

JVC



COMPACT COMPONENT SYSTEM

KOMPAKT-KOMPONENTEN-SYSTEM

SYSTEME DE COMPOSANTS COMPACT

KOMPACTO KOMPONENTEN-SYSTEEM

SISTEMAS DE COMPONENTES COMPACTOS

IMPIANTO A COMPONENTI COMPATTO

CA-MXJ150R

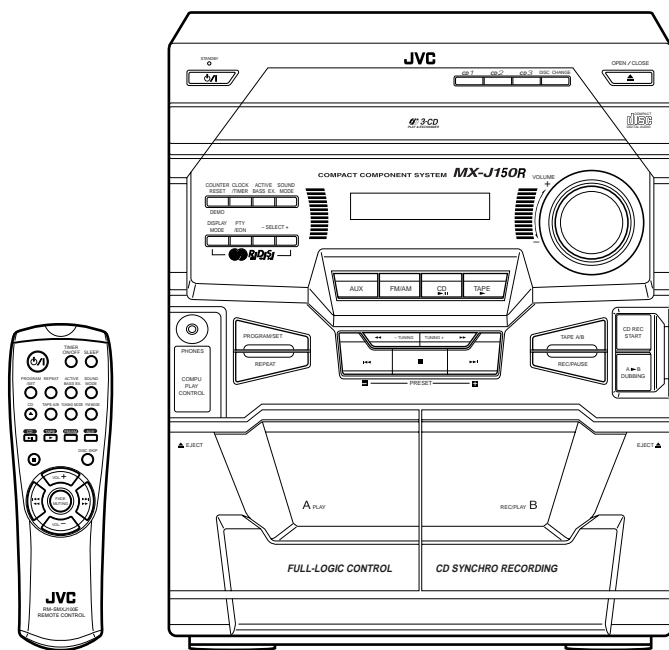

COMPACT
disc
DIGITAL AUDIO

INSTRUCTIONS

BEDIENUNGSANLEITUNG

MANUEL D'INSTRUCTIONS

GEBRUIKSAANWIJZING

MANUAL DE INSTRUCCIONES

ISTRUZIONI

For Customer Use:

Enter below the Model No. and Serial No. which are located either on the rear, bottom or side of the cabinet. Retain this information for future reference.

Model No. _____

Serial No. _____

LVT0473-001A

[E]

IMPORTANT for the U.K.

DO NOT cut off the mains plug from this equipment. If the plug fitted is not suitable for the power points in your home or the cable is too short to reach a power point, then obtain an appropriate safety approved extension lead or consult your dealer.

BE SURE to replace the fuse only with an identical approved type, as originally fitted.

If nonetheless the mains plug is cut off ensure to remove the fuse and dispose of the plug immediately, to avoid a possible shock hazard by inadvertent connection to the mains supply.

If this product is not supplied fitted with a mains plug then follow the instructions given below:

IMPORTANT:

DO NOT make any connection to the terminal which is marked with the letter E or by the safety earth symbol or coloured green or green-and-yellow.

The wires in the mains lead on this product are coloured in accordance with the following code:

Blue : Neutral
Brown : Live

As these colours may not correspond with the coloured markings identifying the terminals in your plug proceed as follows:

The wire which is coloured blue must be connected to the terminal which is marked with the letter N or coloured black.

The wire which is coloured brown must be connected to the terminal which is marked with the letter L or coloured red.

IF IN DOUBT - CONSULT A COMPETENT ELECTRICIAN.

Per l'Italia:

"Si dichiara che il questo prodotto di marca JVC è conforme alle prescrizioni del Decreto Ministeriale n.548 del 28/08/95 pubblicato sulla Gazzetta Ufficiale della Repubblica Italiana n.301 del 28/12/95."

CAUTION

To reduce the risk of electrical shocks, fire, etc.:

1. Do not remove screws, covers or cabinet.
2. Do not expose this appliance to rain or moisture.

ACHTUNG

Zur Verhinderung von elektrischen Schlägen, Brandgefahr, usw.:

1. Keine Schrauben lösen oder Abdeckungen entfernen und das Gehäuse nicht öffnen.
2. Dieses Gerät weder Regen noch Feuchtigkeit aussetzen.

ATTENTION

Afin d'éviter tout risque d'électrocution, d'incendie, etc.:

1. Ne pas enlever les vis ni les panneaux et ne pas ouvrir le coffret de l'appareil.
2. Ne pas exposer l'appareil à la pluie ni à l'humidité.

VOORZICHTIG

Ter verminding van gevaar voor brand, elektrische schokken, enz.:

1. Verwijder geen schroeven, panelen of de behuizing.
2. Stel het toestel niet bloot aan regen of vocht.

PRECAUCIÓN

Para reducir riesgos de choques eléctricos, incendio, etc.:

1. No extraiga los tornillos, los cubiertas ni la caja.
2. No exponga este aparato a la lluvia o a la humedad.

ATTENZIONE

Per ridurre il rischio di shock elettrici, incendi, ecc.:

1. Non togliete viti, coperchi o la scatola.
2. Non esponete l'apparecchio alla pioggia e all'umidità.

Caution — ⏻/! switch!

Disconnect the mains plug to shut the power off completely. The ⏻/! switch in any position does not disconnect the mains line. The power can be remote controlled.

Achtung — ⏻/!-Schalter!

Den Netzstecker aus der Steckdose ziehen, um die Stromversorgung vollkommen zu unterbrechen. Der Schalter ⏻/! unterbricht in keiner Stellung die Stromversorgung vollkommen. Die Stromversorgung kann mit der Fernbedienung ein- und ausgeschaltet werden.

Attention — Commutateur ⏻/!

Déconnecter la fiche de secteur pour couper complètement le courant. Le commutateur ⏻/! ne coupe jamais complètement la ligne de secteur, quelle que soit sa position. Le courant peut être télécommandé.

Voorzichtig — ⏻/! schakelaar!

Om de stroomtoevoer geheel uit te schakelen, trekt u de stekker uit het stopcontact. Anders zal er altijd een geringe hoeveelheid stroom naar het apparaat lopen, ongeacht de stand van de ⏻/! schakelaar. U kunt het apparaat ook met de afstandsbediening aan- en uitschakelen.

Precaución — Interruptor ⏻/!

Desconectar el cable de alimentación para desactivar la alimentación totalmente. Cualquiera que sea la posición de ajuste del interruptor ⏻/!, la alimentación no es cortada completamente. La alimentación puede ser controlada remotamente.

Attenzione — L'interruttore ⏻/!

Disinserire la spina del cavo di alimentazione dalla presa della rete elettrica per staccare completamente l'alimentazione. L'interruttore ⏻/! in nessuna posizione stacca la linea di alimentazione elettrica principale. È possibile il controllo remoto dell'alimentazione.

Caution: Proper Ventilation

To avoid risk of electric shock and fire, and to prevent damage, locate the apparatus as follows:

- 1 Front:
 - No obstructions and open spacing.
- 2 Sides/ Top/ Back:
 - No obstructions should be placed in the areas shown by the dimensions below.
- 3 Bottom:
 - Place on the level surface. Maintain an adequate air path for ventilation by placing on a stand with a height of 10 cm or more.

Achtung: Ausreichende Belüftung

Zur Vermeidung von elektrischen Schlägen, Feuer und sonstigen Schäden sollte das Gerät unter folgenden Bedingungen aufgestellt werden:

- 1 Vorderseite:
 - Hindernisfrei und gut zugänglich.
- 2 Seiten- und Rückwände:
 - Hindernisfrei in allen gegebenen Abständen (s. Abbildung).
- 3 Unterseite:
 - Die Stellfläche muß absolut eben sein. Sorgen Sie für ausreichende Luftzufuhr durch Aufstellung auf einem Stand mit mindestens 10 cm Höhe.

Attention: Aération correcte

Pour prévenir tout risque de décharge électrique ou d'incendie et éviter toute détérioration, installez l'appareil de la manière suivante:

- 1 Avant:
 - Bien dégagé de tout objet.
- 2 Côtés/dessus/dessous:
 - Assurez-vous que rien ne bloque les espaces indiqués sur le schéma ci-dessous.
- 3 Dessous:
 - Posez l'appareil sur une surface plane et horizontale. Veillez à ce que sa ventilation correcte puisse se faire en le plaçant sur un support d'au moins dix centimètres de hauteur.

Voorzichtig: Goede ventilatie vereist

Om brand, elektrische schokken en beschadiging te voorkomen, moet u het toestel als volgt opstellen:

- 1 Voorkant:
 - Geen belemmeringen en voldoende ruimte.
- 2 Zijkanten/boven-/onderkant:
 - Geen belemmeringen plaatsen in de hieronder aangegeven zones.
- 3 Onderkant:
 - Op vlakke ondergrond plaatsen. Voldoende ventilatieruimte voorzien door het toestel op een onderstel met een hoogte van 10 cm of meer te plaatsen.

Precaución: ventilación correcta

Para evitar el riesgo de descargas eléctricas e incendio y prevenir posibles daños, instale el equipo en un lugar que cumpla los siguientes requisitos:

- 1 Parte frontal:
 - Sin obstrucciones, espacio abierto.
- 2 Lados/parte superior/parte posterior:
 - No debe haber ninguna obstrucción en las áreas mostradas por las dimensiones de la siguiente figura.
- 3 Parte inferior:
 - Sitúe el equipo sobre una superficie nivelada. Mantenga un espacio adecuado para permitir el paso del aire y una correcta ventilación, situando el equipo sobre un soporte de 10 o más cm de altura.

Attenzione: Per una corretta ventilazione

Per prevenire il rischio di scosse elettriche e di incendio ed evitare possibili danni, collocare le apparecchiature nel modo seguente:

- 1 Parte anteriore:
 - Nessun ostacolo e spazio libero.
- 2 Lati/Parte superiore/Retro:
 - Lasciare libere le zone indicate dalle dimensioni di seguito.
- 3 Base:
 - Collocare su una superficie piana. Consentire un'adeguata ventilazione dell'impianto appoggiandolo su un tavolino alto almeno 10 cm.

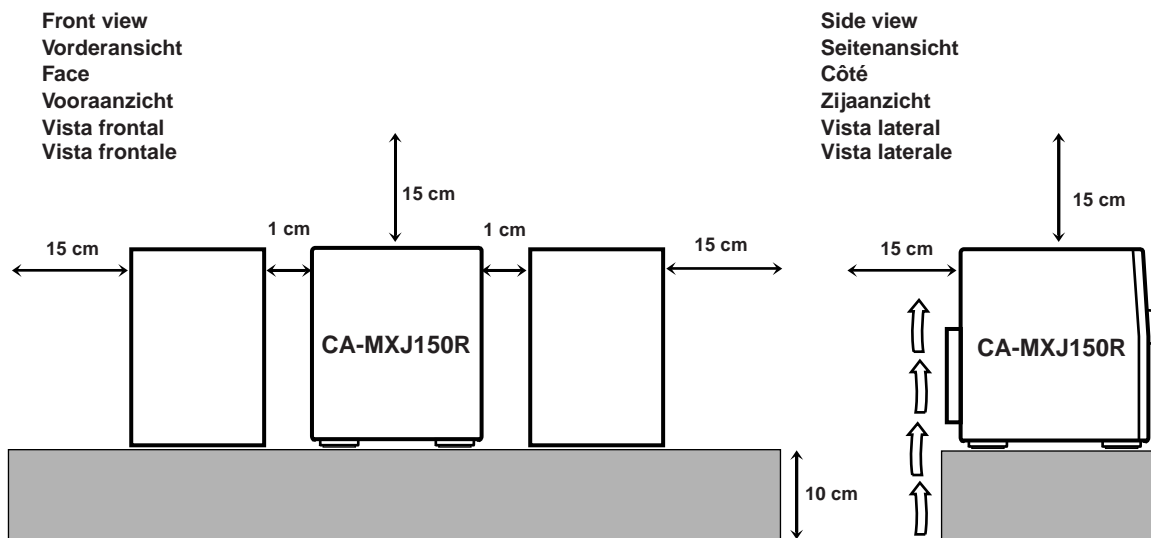

IMPORTANT FOR LASER PRODUCTS / WICHTIGER HINWEIS FÜR LASER-PRODUKTE / IMPORTANT POUR LES PRODUITS LASER / BELANGRIJKE INFORMATIE VOOR LASERPRODUKTEN / IMPORTANTE PARA LOS PRODUCTOS LÁSER / IMPORTANTE PER I PRODOTTI LASER

REPRODUCTION OF LABELS/ANBRINGUNGSORTE FÜR LASER-PRODUKTE/REPRODUCTION DES ETIQUETTES/VERKLARING VAN DE LABELS/REPRODUCCIÓN DE ETIQUETAS/RIPRODUZIONE DELLE ETICHETTE

- | | |
|--|---|
| ① CLASSIFICATION LABEL, PLACED ON REAR ENCLOSURE | ② WARNING LABEL, PLACED INSIDE THE UNIT |
| ① KLASSIFIKATIONSETIKETTE AN DER RÜCKSEITE | ② WARNETIKETTE IM GERÄTEINNEREN |
| ① ETIQUETTE DE CLASSIFICATION, PLACÉE A L'ARRIÈRE DU COFFRET | ② ETIQUETTE D'AVERTISSEMENT PLACÉE À L'INTERIEUR DE L'APPAREIL |
| ① KLASSIFIKATIELABEL, OP DE ACHTERZIJDE VAN HET APPARAAT | ② WAARSCHUWINGSLABEL, IN HET APPARAAT |
| ① ETIQUETA DE CLASIFICACIÓN, PEGADA EN LA PARTE POSTERIOR DE LA CAJA | ② ETIQUETA DE ADVERTENCIA, PEGADA EN EL INTERIOR DE LA UNIDAD |
| ① ETICHETTA DI CLASSIFICAZIONE, SITUATA SUL RIVESTIMENTO POSTERIORE | ② ETICHETTA DI AVVERTENZA, SITUATA ALL'INTERNO DELL'APPARECCHIO |

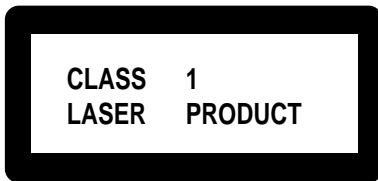

DANGER: Invisible laser radiation when open and interlock failed or defeated. AVOID DIRECT EXPOSURE TO BEAM. (e)	WARNING: Osynlig laserstrålning när denna del är öppnad och spärren är urkopplad. Betrakta ej strålen. (s)	ADVARSEL: Usynlig laserstråling ved åbning, når sikkerhedsafbrydere er ude af funktion. Undgå udsættelse for stråling. (d)	VARO: Avattaessa ja suojalukitus ohitettaessa olet alttiina näkymättömälle lasersäteilylle. Älä katso säteeseen. (f)
---	---	---	---

- | | |
|---|---|
| <ol style="list-style-type: none"> 1. CLASS 1 LASER PRODUCT 2. DANGER: Invisible laser radiation when open and interlock failed or defeated. Avoid direct exposure to beam. 3. CAUTION: Do not open the top cover. There are no user serviceable parts inside the Unit; leave all servicing to qualified service personnel. | <ol style="list-style-type: none"> 1. KLAS 1 LASERPRODUKT 2. GEVAARLIJK: Onzichtbare laserstraling wanneer open en de beveiliging faalt of uitgeschakeld is. Voorkom het direct blootstaan aan de straal. 3. VOORZICHTIG: De bovenkap niet openen. Binnenin het toestel bevinden zich geen door de gebruiker te repareren onderdelen: laat onderhoud over aan bekwaam vakpersoneel. |
| <ol style="list-style-type: none"> 1. LASER-PRODUKT DER KLASSE 1 2. GEFAHR: Unsichtbare Laserstrahlung bei Öffnung und fehlerhafter oder beschädigter Spre. Direkten Kontakt mit dem Strahl vermeiden! 3. ACHTUNG: Das Gehäuse nicht öffnen. Das Gerät enthält keinerlei Teile, die vom Benutzer gewartet werden können. Überlassen Sie Wartungsarbeiten bitte qualifizierten Kundendienst-Fachleuten. | <ol style="list-style-type: none"> 1. PRODUCTO LASER CLASE 1 2. PELIGRO: En el interior hay radiación láser invisible. Evite el contacto directo con el haz. 3. PRECAUCIÓN: No abra la tapa superior. En el interior de la unidad no existen piezas reparables por el usuario; deje todo servicio técnico en manos de personal calificado. |
| <ol style="list-style-type: none"> 1. PRODUIT LASER CLASSE 1 2. ATTENTION: Radiation laser invisible quand l'appareil est ouvert ou que le verrouillage est en panne ou désactivé. Eviter une exposition directe au rayon. 3. ATTENTION: Ne pas ouvrir le couvercle du dessus. Il n'y a aucune pièce utilisable à l'intérieur. Laissez à un personnel qualifié le soin de réparer votre appareil. | <ol style="list-style-type: none"> 1. PRODOTTO LASER CLASSE 1 2. PERICOLO: Radiazione laser invisibile quando l'apparecchio è aperto ed il dispositivo di sicurezza è guasto o disattivato. Evitare l'esposizione diretta ai raggi. 3. ATTENZIONE: Non aprire il coperchio superiore. Non vi sono parti adoperabili dall'utente all'interno di questo apparecchio; lasciare tutti i controlli a personale qualificato. |

Introduction

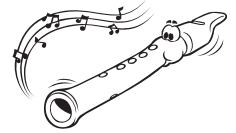

We would like to thank you for purchasing one of our JVC products. Before operating this unit, read this manual carefully and thoroughly to obtain the best possible performance from your unit, and retain this manual for future reference.

About This Manual

This manual is organized as follows:

- The manual mainly explains operations using the buttons and controls on the unit. You can also use the buttons on the remote control if they have the same or similar names (or marks) as those on the unit. If operation using the remote control is different from that using the unit, it is then explained.
- Basic and common information that is the same for many functions is grouped in one place, and is not repeated in each procedure. For instance, we do not repeat the information about turning on/off the unit, setting the volume, changing the sound effects, and others, which are explained in the section “Common Operations” on pages 9 and 10.
- The following marks are used in this manual:



Gives you warnings and cautions to prevent from a damage or risk of fire/electric shock. Also gives you information which is not good for obtaining the best possible performance from the unit.



Gives you information and hints you had better know.

Precautions

Installation

- Install in a place which is level, dry and neither too hot nor too cold — between 5°C (41°F) and 35°C (95°F).
- Install the unit in a location with adequate ventilation to prevent internal heat built-up in the unit.
- Leave sufficient distance between the unit and the TV.
- Keep the speakers away from the TV to avoid interference with TV.



DO NOT install the unit in a location near heat sources, or in a place subject to direct sunlight, excessive dust or vibration.

Power sources

- When unplugging from the wall outlet, always pull the plug, not the AC power cord.



DO NOT handle the AC power cord with wet hands.

Moisture condensation

Moisture may condense on the lens inside the unit in the following cases:

- After starting heating in the room
 - In a damp room
 - If the unit is brought directly from a cold to a warm place
- Should this occur, the unit may malfunction. In this case, leave the unit turned on for a few hours until the moisture evaporates, unplug the AC power cord, and then plug it in again.

Others

- Should any metallic object or liquid fall into the unit, unplug the unit and consult your dealer before operating any further.
- If you are not going to operate the unit for an extended period of time, unplug the AC power cord from the wall outlet.



DO NOT disassemble the unit since there are no user serviceable parts inside.

If anything goes wrong, unplug the AC power cord and consult your dealer.

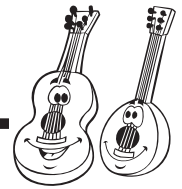

Location of the Buttons and Controls	3
Front Panel	4
Remote Control	5
Getting Started	6
Unpacking	6
Putting the Batteries into the Remote Control	6
Connecting Antennas	6
Connecting Speakers	7
Connecting Other Equipment	8
Common Operations	9
Setting the Clock	9
Turning On the Power and Selecting the Sources	9
Adjusting the Volume	10
Reinforcing the Bass Sound	10
Selecting the Sound Modes	10
Listening to FM and AM (MW/LW) Broadcasts ...	11
Tuning in a Station	11
Presetting Stations	11
Tuning in a Preset Station	11
Receiving FM Stations with RDS	12
Changing the RDS Information	12
Searching for Programs by PTY Codes (PTY Search)	12
Switching to a Traffic Announcement Temporarily ...	13
Playing Back CDs	14
Loading CDs	14
Playing Back CDs	14
Basic CD Operations	15
Programming the Playing Order of the Tracks — Program Play	15
Playing Back Tapes	16
Playing Back a Tape	16
Recording	17
Recording Tapes on Deck B	17
Resetting the Tape Counter	17
Dubbing Tapes	17
CD Direct Recording	17
Using the Timers	18
Using Daily Timer	18
Using Recording Timer	19
Using Sleep Timer	20
Maintenance	21
Troubleshooting	22
Additional Information	23
Specifications	24

Location of the Buttons and Controls

Become familiar with the buttons and controls on your unit.

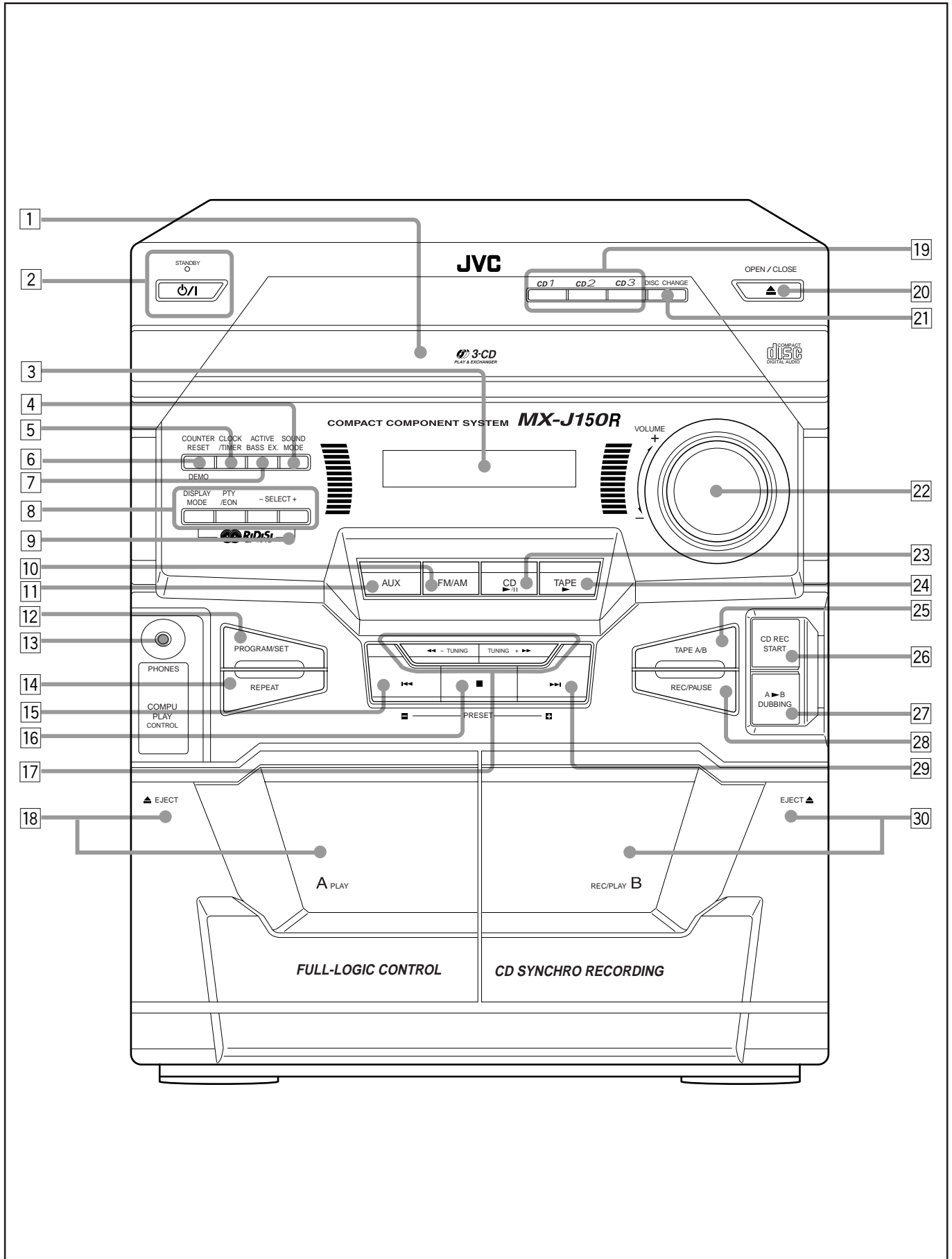

Display Window

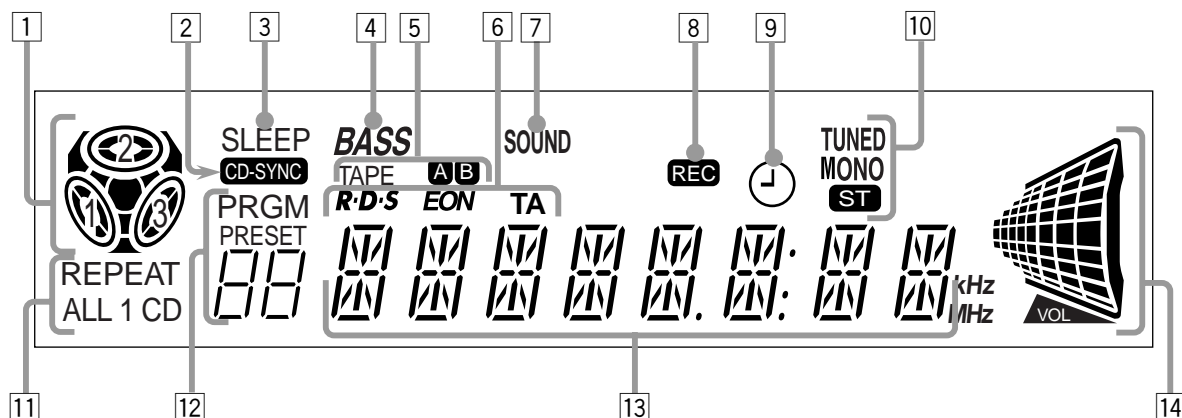

See pages in the parentheses for details.

Front Panel

- 1 Carousel
- 2 (standby/on) button and STANDBY lamp (9)
- 3 Display window
- 4 SOUND MODE button (10)
- 5 CLOCK/TIMER button (9, 18)
- 6 COUNTER RESET button (17)
DEMO button (8)
- 7 ACTIVE BASS EX. (extension) button (10)
- 8 RDS operating buttons (12, 13)
 - DISPLAY MODE, PTY/EON, and SELECT - / + buttons
- 9 Remote sensor
- 10 FM/AM button (11)
Pressing this button also turns on the unit.
- 11 AUX button (9)
Pressing this button also turns on the unit.
- 12 PROGRAM/SET button (9, 15, 18)
- 13 PHONES jack (10)
- 14 REPEAT button (14)
- 15 PRESET - button (11)
◀◀ (reverse search) button (9, 15, 18)
- 16 ■ (stop) button (14, 15, 17)
- 17 TUNING - / + buttons (11)
◀◀ / ▶▶ (fast left/fast right) buttons (15, 16)
- 18 Deck A cassette holder (16)
 - Pressing the ▲ EJECT portion open the holder.
- 19 Disc number buttons (CD 1, CD 2, CD 3) (14)
Pressing one of these buttons also turns on the unit.
- 20 ▲ OPEN/CLOSE button (14)
Pressing this button also turns on the unit.
- 21 DISC CHANGE button (14)
- 22 VOLUME control (10)
- 23 CD ▶/|| (play/pause) button (14)
Pressing this button also turns on the unit.

- 24 TAPE ▶ button (16)
Pressing this button also turns on the unit.
- 25 TAPE A/B button (16)
- 26 CD REC START button (17)
- 27 A ▶ B DUBBING button (17)
- 28 REC/PAUSE button (17)
- 29 PRESET + button (11)
▶▶ (forward search) button (9, 15, 18)
- 30 Deck B cassette holder (17)
 - Pressing the EJECT ▲ portion open the holder.

Display window

- 1 Disc indicators
- 2 CD-SYNC indicator
- 3 SLEEP indicator
- 4 BASS indicator
- 5 Tape operation indicators
 - TAPE A/B (operating deck) indicators
- 6 RDS operating indicators
 - RDS, EON, and TA indicators
- 7 SOUND indicator
- 8 REC indicator
- 9 ⌚ (timer) indicator
- 10 Tuner operation indicators
 - TUNED, MONO and ST (stereo) indicators
- 11 CD play mode indicators
 - REPEAT and (ALL/1/CD) indicators
- 12 PRESET and PRGM (program) number indicators
- 13 Main display
 - Shows the source name, frequency, etc.
- 14 Volume level indicators



Remote Control

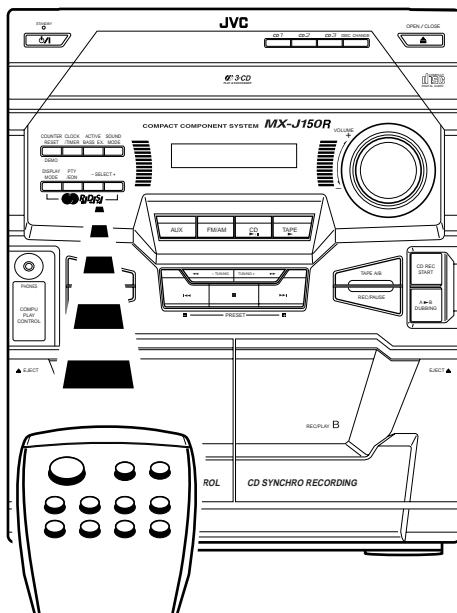
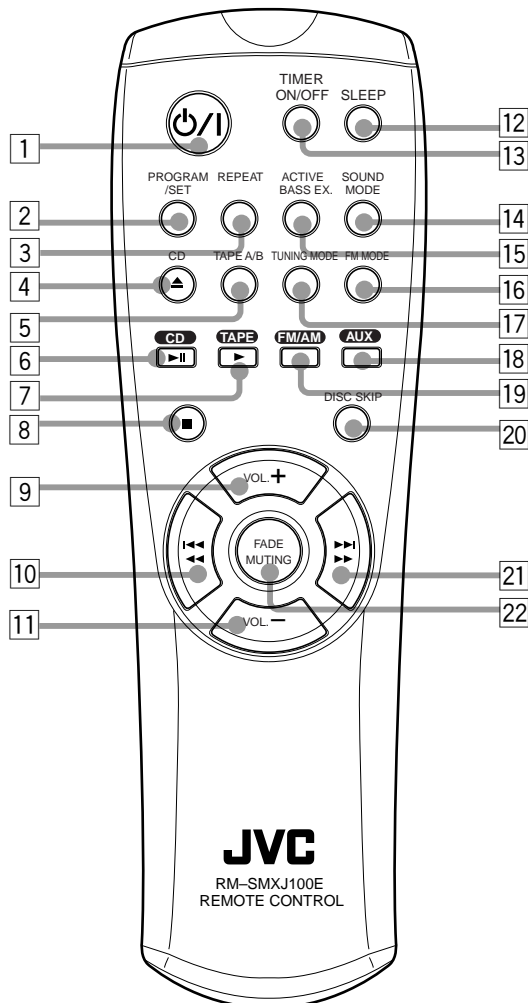

When using the remote control, point it at the remote sensor on the front panel.

Remote Control

- 1 ⏻/⏻ (standby/on) button (9)
- 2 PROGRAM/SET button (9)
- 3 REPEAT button (14)
- 4 CD ▲ button (14)
Pressing this button also turns on the unit.
- 5 TAPE A/B button (16)
- 6 CD ▶|| button (14)
Pressing this button also turns on the unit.
- 7 TAPE ▶ button (16, 17)
Pressing this button also turns on the unit.
- 8 ■ (stop) button (14, 15, 17)
- 9 VOL. + button (10)
- 10 ◀◀ / ◀ (reverse search/fast rewind) button (11, 15, 16)
- 11 VOL. - button (10)
- 12 SLEEP button (20)
- 13 TIMER ON/OFF button (20)
- 14 SOUND MODE button (10)
- 15 ACTIVE BASS EX. (extension) button (10)
- 16 FM MODE button (11)
- 17 TUNING MODE button (11)
- 18 AUX button (9)
Pressing this button also turns on the unit.
- 19 FM/AM button (11)
Pressing this button also turns on the unit.
- 20 DISC SKIP button (14)
- 21 ▶▶ / ▶ (forward search/fast forward) button (11, 15, 16)
- 22 FADE MUTING button (10)

Unpacking

After unpacking, check to be sure that you have all the following items.

The number in the parentheses indicates the quantity of the pieces supplied.

- AM (MW/LW) loop antenna (1)
- FM antenna (1)
- Remote control (1)
- Batteries (2)

If any is missing, consult your dealer immediately.

Putting the Batteries into the Remote Control

Insert the batteries — UM-4/AAA/IEC R03 — into the remote control, by matching the polarity (+ and -) on the batteries with the + and - markings on the battery compartment.

When the remote control can no longer operate the unit, replace both batteries at the same time.

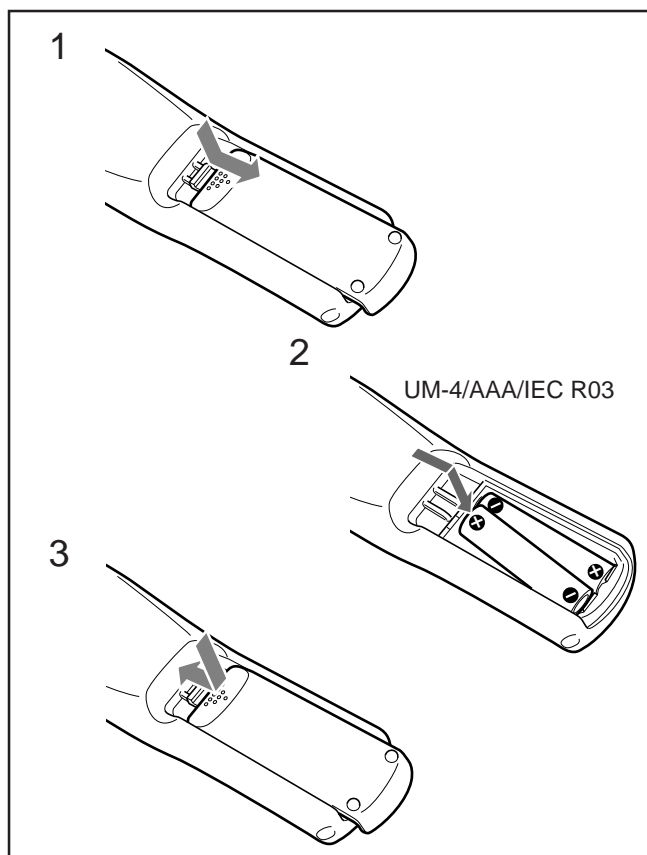

- DO NOT use an old battery together with a new one.
- DO NOT use different types of batteries together.
- DO NOT expose batteries to heat or flame.
- DO NOT leave the batteries in the battery compartment when you are not going to use the remote control for an extended period of time. Otherwise, it will be damaged from battery leakage.

Connecting Antennas

FM antenna

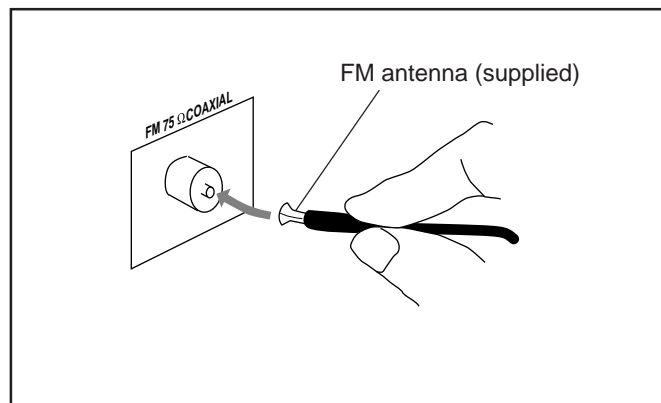

- 1 Attach the FM antenna to the FM 75 Ω COAXIAL terminal.
- 2 Extend the FM antenna.
- 3 Fasten it up in the position which gives you the best reception, then fix it on the wall, etc.



About the supplied FM antenna

The FM antenna supplied with this unit can be used as temporary measure. If reception is poor, you can connect an outdoor FM antenna.

To connect an outdoor FM antenna

Before connecting it, disconnect the supplied FM antenna.

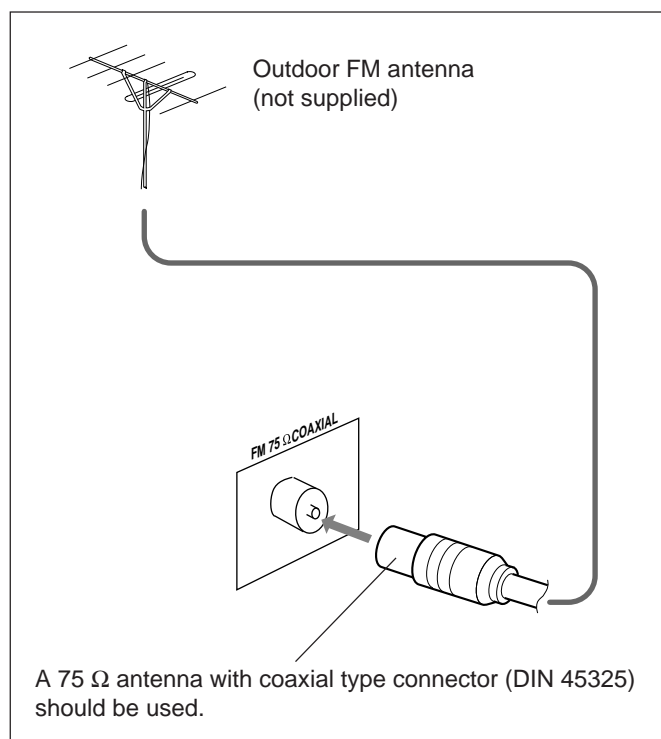

AM (MW/LW) antenna

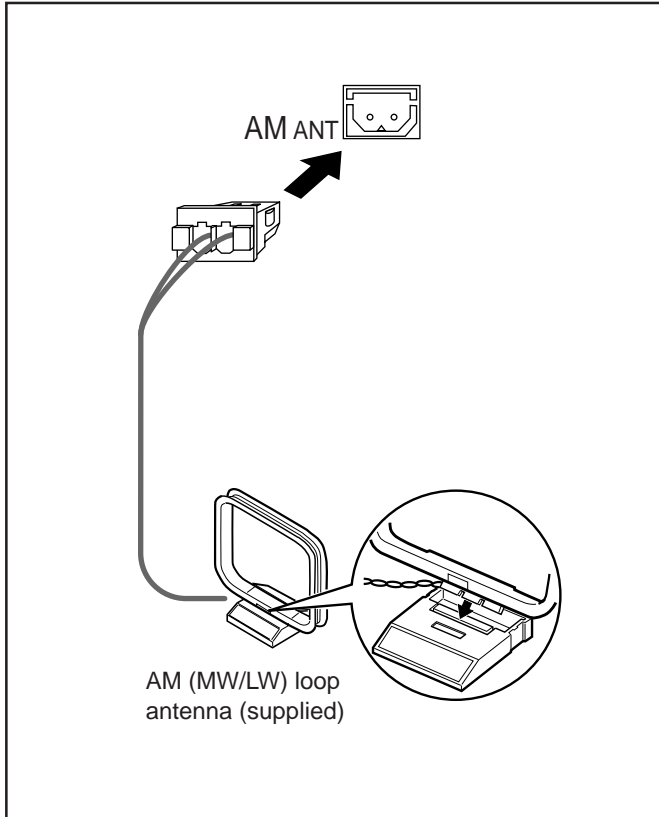

- 1 **Connect the AM (MW/LW) loop antenna to the AM ANT terminal as illustrated.**
- 2 **Turn the AM (MW/LW) loop antenna until you have the best reception.**



For better reception of both FM and AM (MW/LW)

- Make sure the antenna conductors do not touch any other terminals and connecting cords.
- Keep the antennas away from metallic parts of the unit, connecting cords, and the AC power cord.

Connecting Speakers

You can connect a pair of the front speakers.

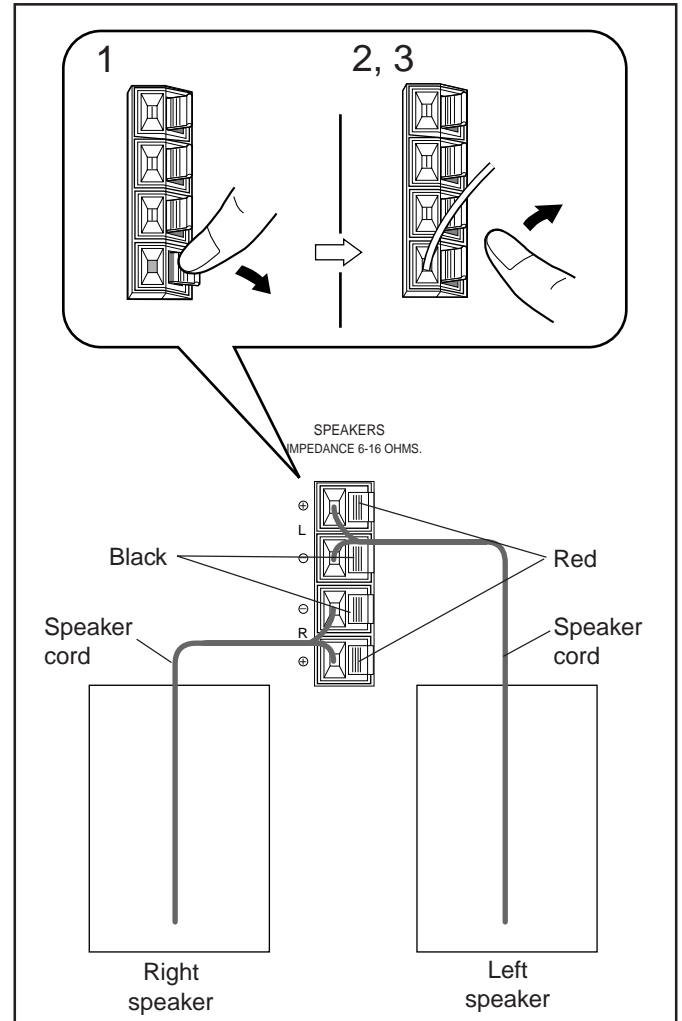

- 1 **Press and hold the clamp of the speaker terminal on the rear of the unit.**
- 2 **Insert the end of the speaker cord into the terminal.**
Match the polarity of the speaker terminals: Red (+) to red (+) and black (-) to black (-).
- 3 **Release the finger from the clamp.**

IMPORTANT: Use only speakers with the same speaker impedance as indicated by the speaker terminals on the rear of the unit.



Connecting Other Equipment

You can connect an audio equipment — used only as a playback device.

When you connect and use this equipment, refer also to its manual.

Be sure that the plugs of the audio cords are color coded: White plugs and jacks are for left audio signals, and red ones for right audio signals.



- DO NOT connect any equipment while the power is on.
- DO NOT plug in any equipment until all connections are complete.

To connect audio equipment

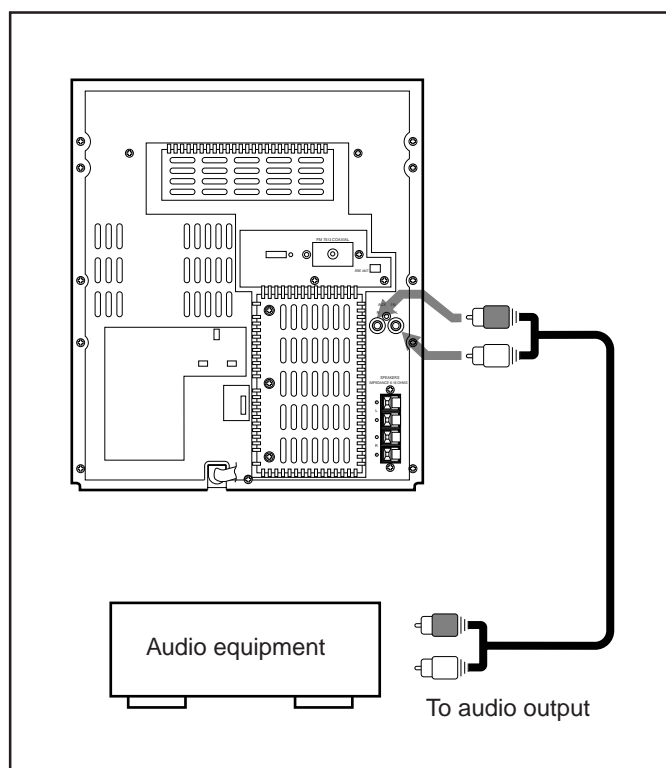

Connect the audio output jacks on the other equipment and the AUX IN jacks on the rear, using an audio cord (not supplied).

NOW, you can plug in the unit and other connected equipment FINALLY!

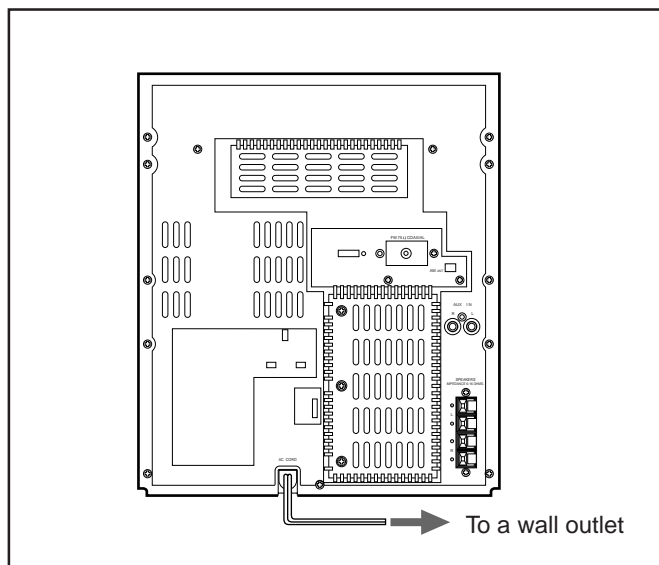

**To start the display demonstration
Press DEMO while the unit is turned off (on standby).**



To stop the display demonstration, press any button.

Common Operations

Setting the Clock

Before operating the unit any further, first set the clock built in this unit.

- There is a time limit in doing the following steps. If the setting is canceled before you finish, start from step 1 again.
- If you want to stop clock setting, press CLOCK/TIMER once or wait until the time limit of 15 seconds comes.

1 Press CLOCK/TIMER twice.

The "CLOCK" appears on the display.



2 Press PROGRAM/SET.

The hour digits start flashing on the display.

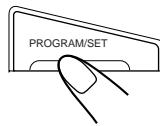

3 Press ◀◀ or ▶▶ to adjust the hour, then press PROGRAM/SET.

After hour digits are set, the minute digits start flashing on the display.

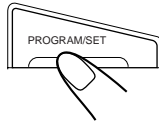
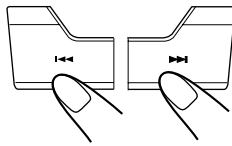
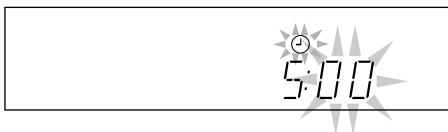

4 Press ◀◀ or ▶▶ to adjust the minute, then press PROGRAM/SET.

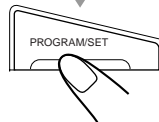
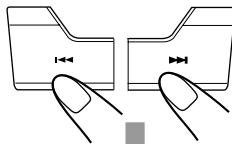

5 Press CLOCK/TIMER twice to finish the clock setting.



To check the clock time

Press CLOCK/TIMER while playing any source. The clock time appears on the display for a while.

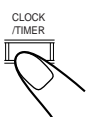

To adjust the clock again

If you have adjusted the clock before, you need to press CLOCK/TIMER until the "CLOCK" is selected.

- Each time you press the button, the clock/timer setting modes change as follows:

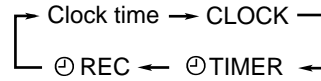

If there is a power failure

The clock loses the setting and is reset to "0:00." You need to set the clock again.

Turning On the Power and Selecting the Sources

When you press the play button for a particular source (AUX, FM/AM, CD ▶/⏸, and TAPE ▶), the unit turns on (and the unit starts playing the source if it is ready — COMPU PLAY CONTROL).

To listen to the FM, MW, or LW broadcasts, press FM/AM. (See page 11.)

To play back CDs, press CD ▶/⏸. (See pages 14 and 15.)

To play back tapes, press TAPE ▶. (See page 16.)

To select the external equipment as the source, press AUX.

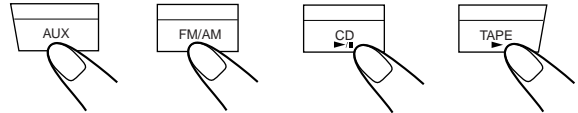

To turn on the unit without playing, press ◻/⏻ (standby/on) so that the STANDBY lamp goes off.

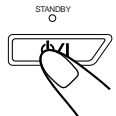

To turn off the unit (on standby), press ◻/⏻ (standby/on) again so that the STANDBY lamp lights up.

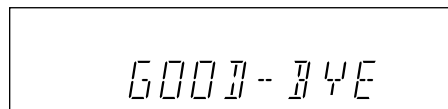
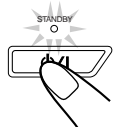

A little power is always consumed even while the unit is on standby.

To switch off the power supply completely, unplug the AC power cord from the AC outlet.



When you unplug the AC power cord or if a power failure occurs

The clock is reset to "0:00" right away, while the tuner preset stations (see page 11) will be erased in a few days.

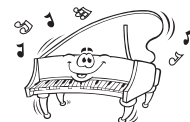

Adjusting the Volume

You can adjust the volume level only while the unit is turned on.

Turn VOLUME clockwise to increase the volume or counterclockwise to decrease it.

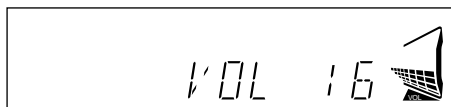
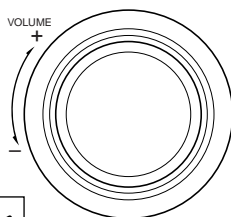

When using the remote control, press VOL. + to increase the volume or press VOL. - to decrease it.



For private listening

Connect a pair of headphones to the PHONES jack. No sound comes out of the speakers. Be sure to turn down the volume before connecting or putting on headphones on the unit.



DO NOT turn off (on standby) the unit with the volume set to an extremely high level; otherwise, a sudden blast of sound can damage your hearing, speakers and/or headphones when you turn on the unit or start playing any source next time. REMEMBER you cannot adjust the volume level while the unit is on standby.

To turn down the volume level temporarily

Press FADE MUTING on the remote control.

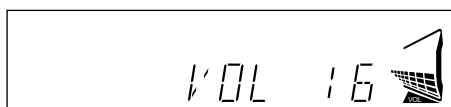

To restore the sound, press the button again.



Reinforcing the Bass Sound

The richness and fullness of the bass sound is maintained regardless of how low you set the volume. You can use this effect only for playback.

To get the effect, press ACTIVE BASS EX. so that the BASS indicator appears on the display.

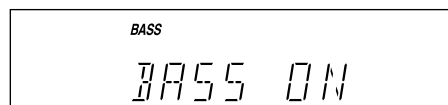

To cancel the effect, press the button again so that the indicator also goes off.

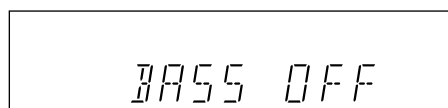

Selecting the Sound Modes

You can select one of the 3 preset sound modes (3 SEA – Sound Effect Amplifier – modes). The sound modes can be applied only to playback sounds, and cannot be used for recording.

To select the sound modes, press SOUND MODE until the sound mode you want appears on the display. The SOUND indicator also lights up on the display.

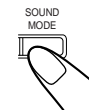

- Each time you press the button, the sound modes change as follows:

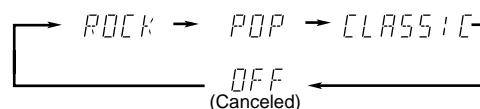

SEA modes:

- ROCK:** Boosts low and high frequency. Good for acoustic music.
- POP:** Good for vocal music.
- CLASSIC:** Good for classical music.
- OFF:** Cancels the sound mode.

Listening to FM and AM (MW/LW) Broadcasts



Tuning in a Station

1 Press FM/AM.

The unit automatically turns on and tunes in the previously tuned station (FM, MW, or LW).

- Each time you press the button, the band changes among FM, MW, and LW.

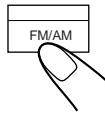

2 Select a station.

On the unit:

Press and hold TUNING – or TUNING + for more than 1 second.

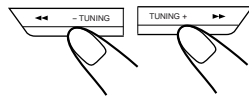

On the remote control:

1) Press TUNING MODE so that “MANUAL” appears on the display.

2) Press and hold ◀◀/◀◀ or ▶▶/▶▶ for more than 1 second.

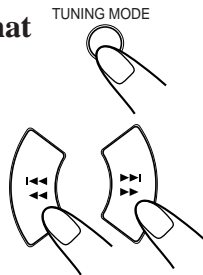

The unit starts searching for stations and stops when a station of sufficient signal strength is tuned in.

If a program is broadcast in stereo, the ST (stereo) indicator lights up.

To stop during searching, press TUNING – or TUNING + (or ◀◀/◀◀ or ▶▶/▶▶ on the remote control).

notes When you press TUNING – or TUNING + (or ◀◀/◀◀ or ▶▶/▶▶ on the remote control) briefly and repeatedly

The frequency changes step by step.

To change the FM reception mode

When an FM stereo broadcast is hard to receive or noisy, press FM MODE on the remote control so that the MONO indicator lights up on the display. Reception improves.



To restore the stereo effect, press FM MODE again so that the MONO indicator goes off.

In this stereo mode, you can hear stereo sounds when a program is broadcast in stereo.

The FM reception mode is restored even when the unit is turned off.

Presetting Stations

You can preset 30 FM, 8 MW, and 7 LW stations.

In some cases, test frequencies have been already memorized for the tuner since the factory examined the tuner preset function before shipment. This is not a malfunction. You can preset the stations you want into memory by following the presetting method.

- There is a time limit in doing the following steps. If the setting is canceled before you finish, start from step 1 again.

1 Tune in the station you want to preset.

- See “Tuning in a Station” to the left.

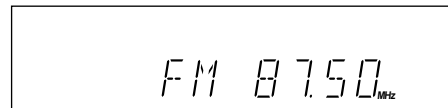

2 Press PROGRAM/SET.



The PRGM flashes on the display.

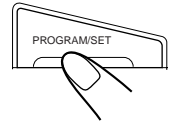

3 Press PRESET – or + to select a preset number.

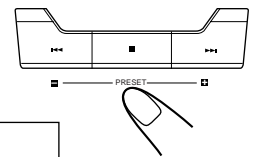
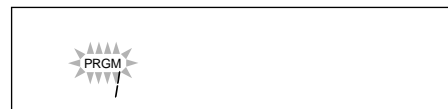

4 Press PROGRAM/SET again.

The tuned station in step 1 is stored in the preset number selected in step 3.

- Storing a new station on a used number erases the previously stored one.

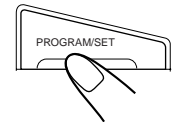

notes When you unplug the AC power cord or if a power failure occurs

The preset stations will be erased in a few days. If this happens, preset the stations again.

Tuning in a Preset Station

1 Press FM/AM.

The unit automatically turns on and tunes in the previously tuned station (FM, MW, or LW).

- Each time you press the button, the band changes among FM, MW, and LW.

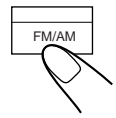

2 Select a preset number.

On the unit:

Press PRESET – or +.

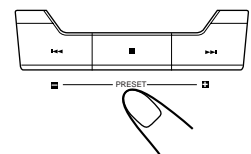

On the remote control:

1) Press TUNING MODE so that “PRESET” appears on the display.

2) Press ◀◀/◀◀ or ▶▶/▶▶.

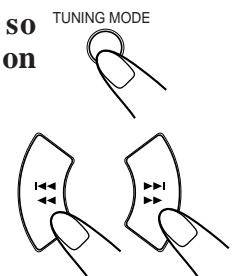

RDS allows FM stations to send an additional signal along with their regular program signals. For example, the stations send their station names, as well as information about what type of program they broadcast, such as sports or music, etc.

When tuned to an FM station which provides the RDS service, the RDS indicator lights up on the display.

With the unit, you can receive the following types of RDS signals.

PS (Program Service):

Shows commonly known station names.

CT (Clock Time):

Shows clock time the station sends.

RT (Radio Text):

Shows text messages the station sends.

EON (Enhanced Other Networks):

Provides the information about the types of the programs sent by other RDS stations.



More about RDS

- Some FM stations and AM (MW/LW) stations do not provide RDS signals.
- RDS services vary among FM RDS stations. For details on RDS services in your area, check with local radio stations.
- RDS may not work correctly if the received station is not transmitting the signals properly or if the signal strength is weak.

Changing the RDS Information

You can see RDS information on the display while listening to an FM station.

Press DISPLAY MODE.

- Each time you press the button, the display changes to show the following information:

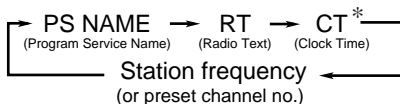
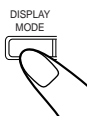

* The clock time shown on the display is not the same as CT (Clock Time) sent by the station.



If no PS NAME, CT, or RT signals are sent by a station

“NO PS,” “NO CT” or “NO RT” appears in the main display.

Searching for Programs by PTY Codes (PTY Search)

One of the advantages of RDS is that you can locate a particular kind of program by specifying the PTY codes.

- For details on the PTY codes, see “Additional Information” on page 23.

To search for a program using the PTY codes

REMEMBER you must preset FM RDS stations to use the EON function. If not yet done, see page 11.

- There is a time limit in doing the following steps. If the setting is canceled before you finish, start from step 1 again.

1 Press PTY/EON.

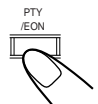

2 Press SELECT - / + until the PTY code you want appears on the display.

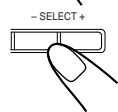

- Each time you press the button, the PTY codes change as follows:

- NEWS ⇄ AFFAIRS ⇄ INFO ⇄ SPORT ⇄
- EDUCATE ⇄ DRAMA ⇄ CULTURE ⇄
- SCIENCE ⇄ VARIED ⇄ POP M ⇄ ROCK M ⇄
- M.O.R. M ⇄ LIGHT M ⇄ CLASSICS ⇄
- OTHER M ⇄ WEATHER ⇄ FINANCE ⇄
- CHILDREN ⇄ SOCIAL A ⇄ RELIGION ⇄
- PHONE IN ⇄ TRAVEL ⇄ LEISURE ⇄ JAZZ ⇄
- COUNTRY ⇄ NATIONAL ⇄ OLDIES ⇄
- FOLK M ⇄ DOCUMENT ⇄ (back to the beginning)

3 Press PTY/EON once again.

The preset FM stations appear on the display with their preset numbers.

The unit searches 30 preset FM stations, stops when it finds the one you have selected and tunes in that station.

- If no program is found, the unit returns to the last received station.

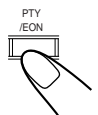

To stop searching any time during the process

Press SELECT -/+ while searching.

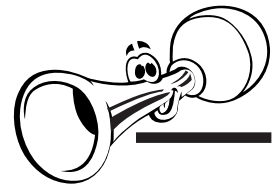

Switching to a Traffic Announcement Temporarily

By receiving EON data sent by FM RDS stations, the EON function allows the unit to switch temporarily to a broadcast of a traffic announcement from a different station.

- The EON function only works when you are listening to a preset FM RDS stations providing EON data.
- The EON indicator lights while receiving a station with EON data.

To activate the EON function

REMEMBER you must preset FM RDS stations to use the EON function. If not yet done, see page 11.

1 Press and hold PTY/EON .

Each time you press and hold PTY/EON, “TA ON” and “TA OFF” alternately appear on the display.

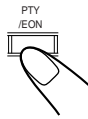

TA ON ↔ TA OFF

TA ON: Switches to a traffic announcement, if any.

TA OFF: This function is canceled.

How the EON function actually works:

CASE 1

If there is no station broadcasting a traffic announcement

The unit continues tuning in the current station.



When a station starts broadcasting a traffic announcement, the unit automatically switches to the station. The TA indicator starts flashing.



When the program is over, the unit goes back to the previously tuned station, but the EON function still remains activated.

CASE 2

If there is a station broadcasting a traffic announcement

The unit tunes in the program. The TA indicator starts flashing.



When the program is over, the unit goes back to the previously tuned station, but the EON function still remains activated.

CASE 3

If the FM station you are listening to is broadcasting a traffic announcement

The unit continues to receive the station but the TA indicator starts flashing.



When the program is over, the TA indicator goes off, but the EON function still remains activated.



More about the EON function

- EON data sent from some stations may not be compatible with this unit. In this case, the EON function may not work correctly.
- While listening to a program tuned in by the EON function, the station does not change even if another network station starts broadcasting a program of the same EON data.
- The EON function is canceled when you change the source to CD, TAPE, or AUX, while it is temporarily canceled when you change the source to AM.

Loading CDs

1 Press OPEN/CLOSE  on the unit or CD  on the remote control.

The unit automatically turns on and the carousel comes out.

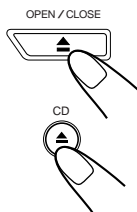

2 Place one or two discs correctly on the front slots of the carousel, with its label side up.

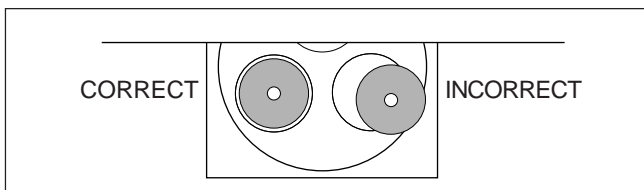



- When using a CD single (8 cm), place it on the inner circle of the disc tray.

3 If you wish to load a third disc, press DISC CHANGE on the unit (or DISC SKIP on the remote control).

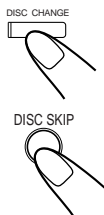
The carousel rotates by 120°.



4 Press OPEN/CLOSE  on the unit or CD  on the remote control again.

The carousel closes, and the corresponding disc number indicator (disc 1 to disc 3) lights up on the display.

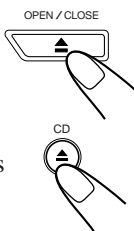

About the disc indicators

Each disc indicator corresponds to the disc tray of the same number.

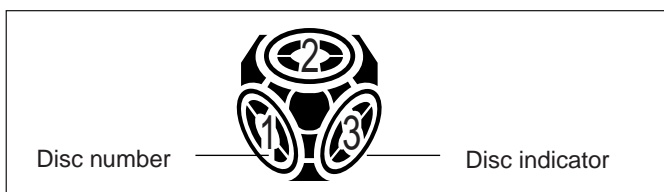

- The disc indicator flashes while the corresponding CD is currently selected.
- The disc indicator goes off when the unit has detected that there is no CD on the corresponding disc tray.

Playing Back CDs

You can play CDs continuously.

1 Load CDs.

2 Press REPEAT on the unit (or REPEAT on the remote control) to select a play mode you want.

Each time you press the button, play modes change as follows:

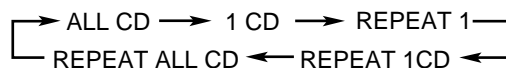
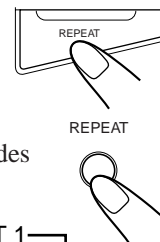

ALL CD: Plays all loaded CD. (When you turned on the unit, "ALL CD" is automatically selected.)

1CD: Plays back one CD.

REPEAT 1: Repeats one track on one CD.

REPEAT 1CD*: Repeats all the tracks on one CD.

REPEAT ALL CD: Repeats all the tracks on all the CDs, or all the tracks in the program.

*REPEAT 1CD is not used for Program play.

3 Select the disc you want to start play from.

On the unit :

Press one of the disc number buttons (CD 1, CD 2, and CD 3).

On the remote control :
Press DISC SKIP repeatedly.

CD play starts from the first track of the selected disc.

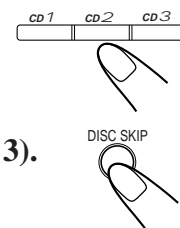

Disc No. flashes



Track number

Elapsed playing time

- Pressing CD  instead of the disc number buttons starts playing back if a CD is on the trays.

To stop during play, press .

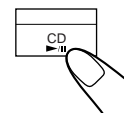
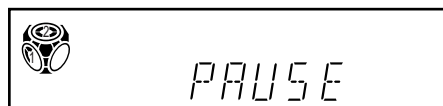

To stop play for a moment

Press CD .



"PAUSE" appears on the display.

To resume play, press CD  again.

To remove the disc, press OPEN/CLOSE  on the unit or CD  on the remote control.



Basic CD Operations

While playing a CD, you can do the following operations.

To exchange CDs during playback of another

Press DISC CHANGE to eject and exchange the CD.

To locate a particular point in a track

During play, press and hold ◀◀ or ▶▶.

- ◀◀ : Fast reverses the disc.
- ▶▶ : Fast forwards the disc.

When using the remote control, press and hold ◀◀ / ▶▶ or ▶▶ / ▶▶.

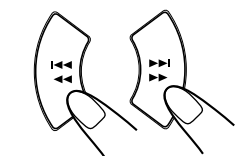
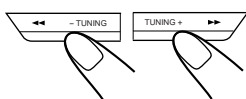

To go to another track

Press ◀◀ or ▶▶ repeatedly before or during playback.

- ◀◀: Goes back to the beginning of the current or previous tracks.
- ▶▶: Skips to the beginning of the next or succeeding tracks.

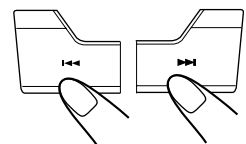

When using the remote control, press ◀◀ / ▶▶ or ▶▶ / ▶▶ before playing.



notes If you press and hold ◀◀ / ▶▶ on the unit you can change the tracks continuously.

Programming the Playing Order of the Tracks — Program Play

You can arrange the order in which the tracks play before you start playing. **You can program up to 24 tracks.**

- To repeat the program, select "REPEAT ALL CD" by pressing REPEAT repeatedly.

1 Load discs.

- If the current playing source is not the CD player, press CD ▶/II, then ■ before going to the next step.

2 Press PROGRAM/SET.

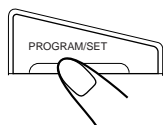

3 Select the disc number.

On the unit:

Press one of the disc number buttons (CD 1, CD 2, and CD 3).

On the remote control:

Press DISC SKIP repeatedly.

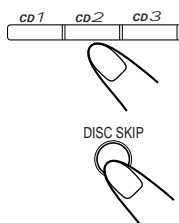

DISC SKIP

Corresponding disc number flashes

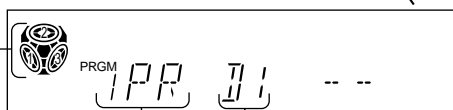

Program step number Disc number

- Press ◀◀ or ▶▶ (or ◀◀ / ▶▶ or ▶▶ / ▶▶ on the remote control) to select the track number, then press PROGRAM/SET.

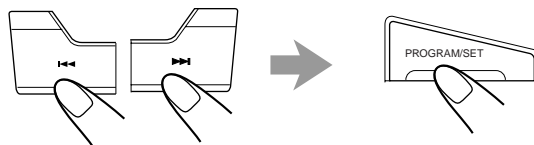

Corresponding disc number flashes

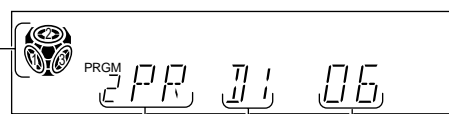

Program step number Disc number Track number

5 Program other tracks you want.

- To program tracks from the same disc, repeat step 4.
- To program tracks from a different disc, repeat steps 3 and 4.

6 Press CD ▶/II.

The tracks are played in the order you have programmed.

To add more tracks into the program

Press PROGRAM/SET.

You can add the tracks into the program before or after play. If you have already programmed all 24 tracks, you cannot add more. If you do, it will overwrite the 1st track and so on.

- You cannot erase or modify the programmed tracks.
- If you want to modify the program, erase all the program and start from the beginning.

To stop during play, press ■.

To erase the entire program before or after play, press ■.

- Ejecting the Carousel will also erase the program.



notes If your entry is ignored

You have tried to program a track from an empty tray, or a track number that does not exist on the CD (for example, selecting track 14 on a CD that only has 12 tracks). Such entries are ignored.

Playing Back Tapes



Playing Back a Tape

1 Press EJECT ▲ for the deck you want to use.

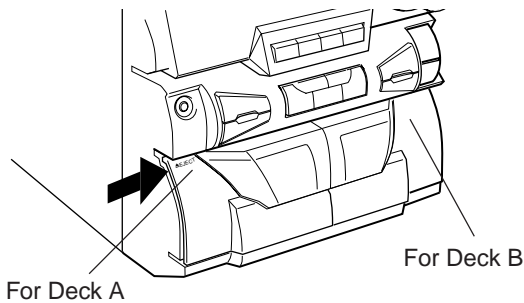

2 Put a cassette in, with the exposed part of the tape down.

- You can play back only the type I tapes.

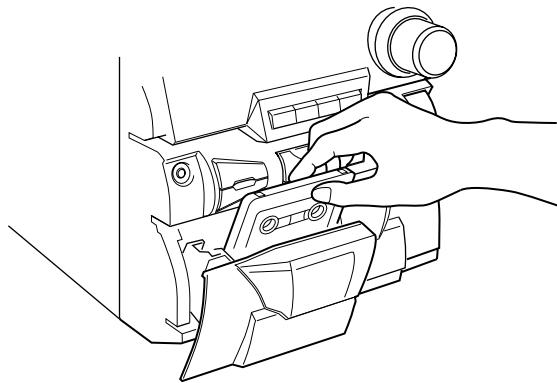

To stop during play, press ■.

To operate the other deck, press TAPE A/B, then TAPE ►.

To fast-forward the tape, press ►► (or ►►| / ►► on the remote control).

To rewind the tape, press ◀◀ (or |◀◀ / ◀◀ on the remote control).

To remove the cassette, press ▲ EJECT for deck A or EJECT ▲ for deck B.

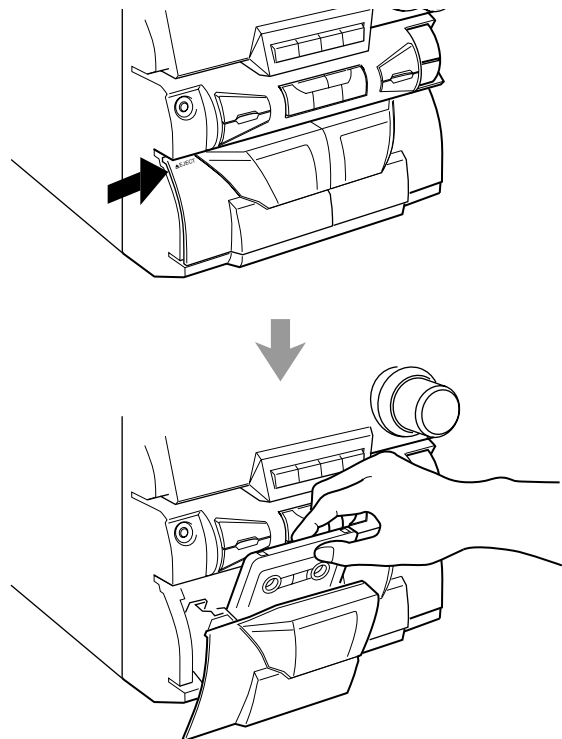

3 Close the cassette holder gently.

If you put cassettes in both decks A and B, the deck which you have put a cassette into last is selected.

To operate the other deck, press TAPE A/B.

4 Press TAPE ►.

The tape play starts.

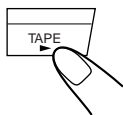

When the tape plays to the end, the deck automatically stops.



The use of the C-120 or thinner tape is not recommended, since characteristic deterioration may occur and this tape easily jams in the pinch-rollers and the capstans.

Recording



IMPORTANT:

- It may be unlawful to record or play back copyrighted material without the consent of the copyrighted owner.
- The recording level is automatically set correctly, so it is not affected by the VOLUME control. Thus, during recording you can adjust the sound you are actually listening to without affecting the recording level.
- While recording, you can hear tunes with sound modes and/or the active bass extension effect through the speakers or headphones. However, the sound is recorded without these effects (see page 10).
- If the sound recorded have excessive noise or static, the unit may be too close to a TV. Please separate the TV from the unit.
- You can use only type I tapes for recording.

Recording Tapes on Deck B

1 Press EJECT ▲ for the deck B.

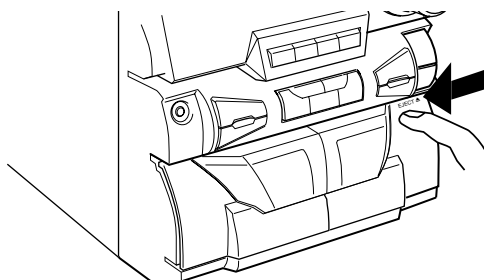

2 Put in a recordable cassette, with the exposed part of the tape down.

3 Close the cassette holder gently.

4 Start playing the source — FM, MW, LW, CD player, or auxiliary equipment connected to AUX jacks.

- When the source is CD, you can also use CD Direct Recording.

5 Press REC/PAUSE. Start recording.

The REC indicator lights up on the display and recording starts.

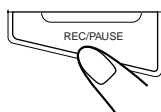

To stop during recording, press ■.

To stop recording temporarily, press REC/PAUSE on the unit. The REC indicator starts flashing on the display.

To resume recording, press REC/PAUSE again.

To remove the cassette, press EJECT ▲ for deck B.

Resetting the Tape Counter

If you wish to take a note on the counter value at the beginning of each track, reset the counter before starting a recording.

Press COUNTER RESET on the unit to reset the counter.

The counter reading becomes "0000."

- The counter reading also becomes "0000" when the unit is turned off (stands by).

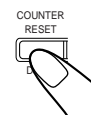

Dubbing Tapes

1 Press TAPE ►, then ■.

2 Put the source cassette in deck A, and a recordable cassette into deck B.

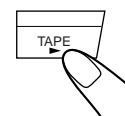

3 Press A ► B DUBBING.

Dubbing starts.

"DUBBING" and REC indicators light up on the display.

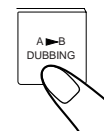

To stop during dubbing, press ■.

To remove the cassette, press ▲ EJECT for deck A and EJECT ▲ for deck B.

CD Direct Recording

Everything on the CD goes onto the tape in the order it is on the CD, or according to the order you have made for Program play.

1 Put a recordable cassette into deck B.

2 Place a disc correctly on the circle of the disc tray, with its label side up.

3 Press one of the disc number buttons (CD 1 to CD 3) to select the disc, then ■.

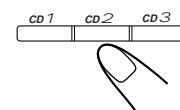

4 Press CD REC START.

"SYNCHRO" appears, and the CD-SYNC, REC and 1CD indicators light up on the display.

Deck B starts recording and the CD player starts playing. When the recording is done, the CD player and deck B stop.



To stop during CD Direct Recording, press ■.

To remove the cassette, press EJECT ▲ for deck B.

There are three timers available — Recording Timer, Daily Timer, and Sleep Timer.

Before using the timers, you need to set the clock built in the unit. (See page 9.)

Using Daily Timer

With Daily Timer, you can wake to your favorite music or radio program.

How Daily Timer actually works

The unit automatically turns on, set the volume level to the preset level, and starts playing the specified source when the on-time comes. Then, when the off-time comes, the unit automatically turns off (stands by).

The timer setting remains in memory until you change it.

- There is a time limit in doing the following steps. If the setting is canceled before you finish, start from step 1 again.
- If you have made a mistake while setting timer, press CLOCK/TIMER twice and start from step 1 again.

On the unit ONLY:

1 Press CLOCK/TIMER until “⊕ TIMER” appears on the display.

The ⊕ indicator also starts flashing on the display.

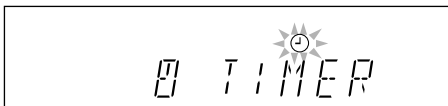
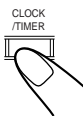

- Each time you press the button, the timer setting modes change as follows:

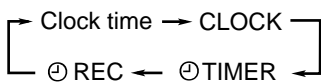

2 Press PROGRAM/SET.

“ON TIME” appears for 2 seconds, then the unit enters on-time setting mode.

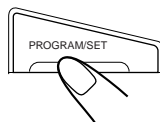

3 Set the on-time you want the unit to turn on.

1) Press ◀◀ or ▶▶ to set the hour, then press PROGRAM/SET.

2) Press ◀◀ or ▶▶ to set the minute, then press PROGRAM/SET.

“OFF TIME” appears for 2 seconds, then the unit enters off-time setting mode.

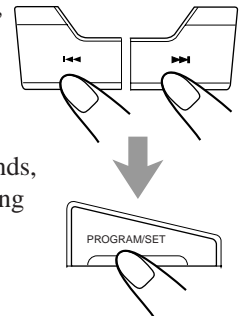

4 Set the off-time you want the unit to turn off (on standby).

1) Press ◀◀ or ▶▶ to set the hour, then press PROGRAM/SET.

2) Press ◀◀ or ▶▶ to set the minute, then press PROGRAM/SET.

The unit enters the volume setting mode.

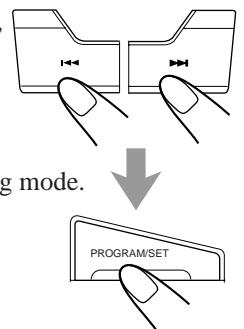

5 Set the volume level when the unit is turned on.

Press ◀◀ or ▶▶ to set the volume, then press PROGRAM/SET.



The unit enters source selecting mode.

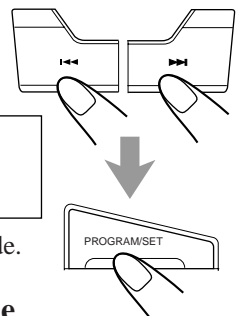

6 Press ◀◀ or ▶▶ to select the source to play, then press PROGRAM/SET.

- Each time you press ◀◀ or ▶▶, the source changes as follows:

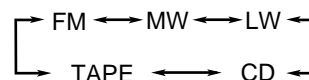

FM: tunes into a specified preset FM station. → go to step 7.

MW: tunes into a specified preset MW station. → go to step 7.

LW: tunes into a specified preset LW station. → go to step 7.

CD: plays a disc from the first track. → go to step 8.

- Make sure there is a CD on the currently selected disc number tray.

TAPE: plays a tape in deck A or B. → go to step 8.

- Make sure that a tape is in the deck whose deck indicator (A or B) is lit on the display.

- Make sure that the tape direction is correct.

7 When selecting "FM," "MW," or "LW."

Press ◀◀ or ▶▶ to select the preset station number, then press PROGRAM/SET.

The unit enters recording timer setting mode.

If you want to continue the Recording Timer setting, go to step 3 of the Recording Timer setting procedure.

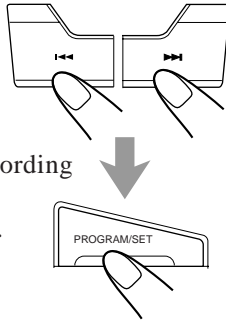

8 Press CLOCK/TIMER.

The ☉ indicator stops flashing and remains lit.

If you have set the Daily Timer with the unit turned on, turn off the unit.



Using Recording Timer

With Recording Timer, you can make a tape of a radio broadcast automatically.

How Recording Timer actually works

The unit automatically turns on, tunes into the specified station, sets the volume level to the preset level and starts recording when the on-time comes. Then, when the off-time comes, the unit automatically turns off (stands by).

The timer setting remains in memory until you change it.

- There is a time limit in doing the following steps. If the setting is canceled before you finish, start from step 1 again.
- If you have made a mistake while setting the timer, press CLOCK/TIMER once and start from step 1 again.

On the unit ONLY:

1 Put a recordable cassette into deck B.

2 Press CLOCK/TIMER until "☉ REC" appears on the display.

The ☉ indicator also starts flashing on the display.

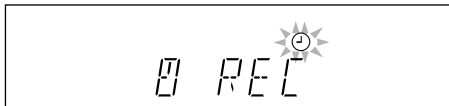
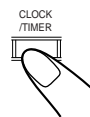

- Each time you press the button, the timer setting modes change as follows:

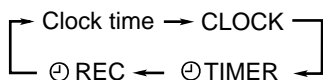

3 Press PROGRAM/SET.

"ON TIME" appears for 2 seconds, then the unit enters on-time setting mode.

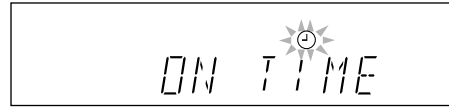
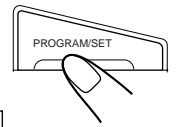

4 Set the on-time you want the unit to turn on.

1) Press ◀◀ or ▶▶ to set the hour, then press PROGRAM/SET.

2) Press ◀◀ or ▶▶ to set the minute, then press PROGRAM/SET.

"OFF TIME" appears for 2 seconds, then the unit enters off-time setting mode.

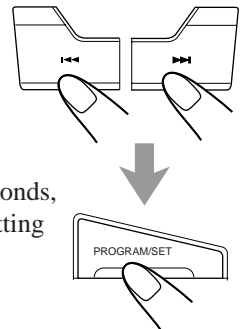

5 Set the off-time you want the unit to turn off (on standby).

1) Press ◀◀ or ▶▶ to set the hour, then press PROGRAM/SET.

2) Press ◀◀ or ▶▶ to set the minute, then press PROGRAM/SET.

The unit enters the volume setting mode.

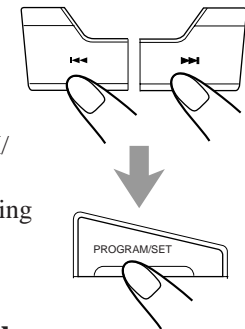

6 Set the volume level when the unit is turned on.

Press ◀◀ or ▶▶ to set the volume, then press PROGRAM/SET.



The unit enters source selecting mode.

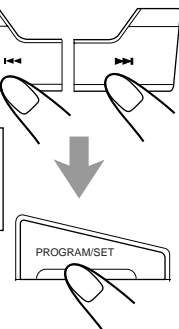



7 Select the preset station.

- 1) Press ◀◀ or ▶▶ to select the band (“FM,” “MW,” or “LW”), then press PROGRAM/SET.
- 2) Press ◀◀ or ▶▶ to select a preset channel number.

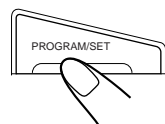
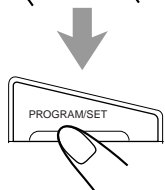
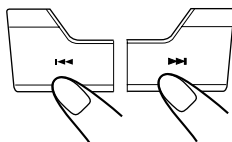

8 Press PROGRAM/SET.

The ⊕ indicator stops flashing and remains lit.

If you have set the Recording Timer with the unit turned on, turn off the unit.

The REC indicator lights up when the unit is turned off (on standby).

To select Recording or Daily Timer after its setting has been done

Press TIMER ON/OFF on the remote control.

Each time you press the button, the timer mode changes as follows:

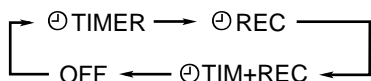

- ⊕ TIMER: Select this when you want to use only the Daily Timer.
- ⊕ REC: Select this when you want to use only the Recording Timer.
- ⊕ TIM+REC: Select this when you want to use both the Daily Timer and the Recording Timer.
- OFF: Select this when you do not want to use the timer.

- **When the timer is set to OFF**, the ⊕ indicator and/or REC indicator goes off from the display. Even if the Recording or Daily Timer is canceled, but the setting condition for the Recording or Daily Timer remains in memory.
- **When any timer setting is activated**, the ⊕ indicator and/or REC indicator lights up again.



If the unit is operating when the timer-on time comes Recording or Daily Timer does not work.

Using Sleep Timer

With Sleep Timer, you can fall asleep to music. You can set Sleep Timer when the unit is operating.

How Sleep Timer actually works

The unit automatically turns off after the specified time length passes by.

On the remote control ONLY:

1 Press SLEEP.

The time length until the shut-off time appears and the SLEEP indicator lights up on the display.

- Each time you press the button, the time length changes as follows:

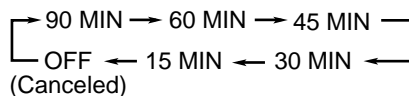

2 Wait for about 5 seconds after specifying the time length.

The SLEEP indicator remains lit.

To check the remaining time until the shut-off time, press SLEEP once so that the remaining time until the shut-off time appears for about 3 seconds.

To change the shut-off time, press SLEEP repeatedly until the desired time length appears on the display.

To cancel the setting, press SLEEP repeatedly so that the SLEEP indicator goes off.

- Sleep Timer is also canceled when you turn off the unit.

Maintenance



To get the best performance of the unit, keep your discs, tapes, and mechanism clean.

Handling discs



- Remove the disc from its case by holding it at the edge while pressing the center hole lightly.
- Do not touch the shiny surface of the disc, or bend the disc.
- Put the disc back in its case after use to prevent warping.

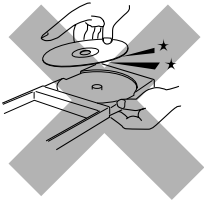

- Be careful not to scratch the surface of the disc when placing it back in its case.
- Avoid exposure to direct sunlight, temperature extremes, and moisture.



To clean the disc

Wipe the disc with a soft cloth in a straight line from center to edge.



DO NOT use any solvent — such as conventional record cleaner, spray, thinner, or benzine — to clean the disc.

Handling cassette tapes

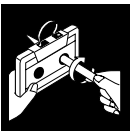

- If the tape is loose in its cassette, take up the slack by inserting a pencil in one of the reels and rotating.
- If the tape is loose, it may get stretched, cut, or caught in the cassette.



- Be careful not to touch the tape surface.



- Avoid the following places to store the tape:
 - In dusty places
 - In direct sunlight or heat
 - In moist areas
 - Near a magnet

To protect your recording

Cassettes have two small tabs on the back to protect unexpected erasure or re-recording. To protect your recording, remove these tabs. To re-record on a protected tape, cover the holes with adhesive tape.

Cassette decks

If the heads, capstans, and pinch rollers of the cassette decks become dirty, the following will occur:

- Impaired sound quality
- Discontinuous sound
- Fading
- Incomplete erasure
- Difficulty in recording

To clean the heads, capstan, and pinch roller

Use a cotton swab moistened with alcohol.

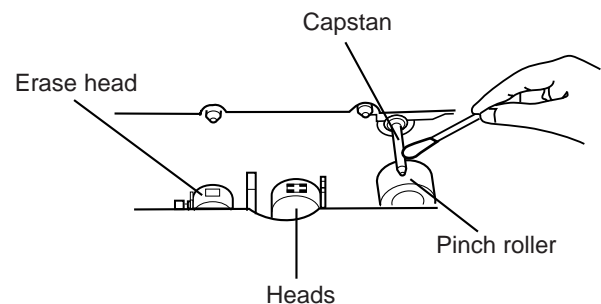

To demagnetize the heads

Turn off the unit, and use a head demagnetizer (available at electronics and record shops).

Troubleshooting



If you are having a problem with your unit, check this list for a possible solution before calling for service.

If you cannot solve the problem from the hints given here, or the unit has been physically damaged, call a qualified person, such as your dealer, for service.

Symptom	Cause	Action
No sound is heard.	Connections are incorrect or loose.	Check all connections and make corrections. (See pages 6 to 8.)
Hard to listen to broadcasts because of noise.	<ul style="list-style-type: none"> Antennas are disconnected. The AM (MW/LW) loop antenna is too close to the unit. The FM antenna is not properly extended and positioned. 	<ul style="list-style-type: none"> Reconnect the antennas correctly and securely. Change the position and direction of the AM (MW/LW) loop antenna. Extend the FM antenna at the best position.
The disc sound is discontinuous.	The disc is scratched or dirty.	Clean or replace the disc. (See page 21.)
The disc tray does not open or close.	The AC power cord is not plugged in.	Plug the AC power cord.
The disc does not play.	The disc is placed upside down.	Place the disc with the label side up.
The cassette holders cannot be opened.	Power supply from the AC power cord has been cut off while the tape was running.	Turn on the unit.
Impossible to record.	Small tabs on the back of the cassette are removed.	Cover the holes with adhesive tape.
Operations are disabled.	The built-in microprocessor may malfunction due to external electrical interference.	Unplug the AC power cord and then plug it back in.
Unable to operate the unit from the remote control.	<ul style="list-style-type: none"> The path between the remote control and the remote sensor on the unit is blocked. The batteries are exhausted. 	<ul style="list-style-type: none"> Remove the obstruction. Replace the batteries.

Additional Information



Description of the PTY codes:

NEWS:	News.
AFFAIRS:	Topical program expanding or enlarging upon the news — debate, or analysis.
INFO:	Program the purpose of which is to impart advice in the widest sense.
SPORT:	Program concerned with any aspect of sports.
EDUCATE:	Educational programs.
DRAMA:	All radio plays and serials.
CULTURE:	Programs concerning any aspect of national or regional culture, including language, theatre, etc.
SCIENCE:	Programs about natural sciences and technology.
VARIED:	Used for mainly speech-based programs like quizzes, panel games and personality interviews.
POP M:	Commercial music of current popular appeal.
ROCK M:	Rock music.
M.O.R. M:	Current contemporary music considered to be “easy-listening.”
LIGHT M:	Instrumental music, and vocal or choral works.
CLASSICS:	Performances of major orchestral works, symphonies, chamber music, etc.
OTHER M:	Music not fitting into any of the other categories.
WEATHER:	Weather reports and forecasts.

FINANCE:	Stock Market reports, commerce, trading etc.
CHILDREN:	Programs targeted at a young audience.
SOCIAL A:	Programs about sociology, history, geography, psychology and society.
RELIGION:	Religious programs.
PHONE IN:	Involving members of the public expressing their views either by phone or at a public forum.
TRAVEL:	Travel information.
LEISURE:	Programs about recreational activities.
JAZZ:	Jazz music.
COUNTRY:	Songs which originate from, or continue the musical tradition of the American Southern States.
NATIONAL:	Current popular music of the nation or region in that country’s language.
OLDIES:	Music from the so-called “golden age” of popular music.
FOLK M:	Music which has its roots in the musical culture of a particular nation.
DOCUMENT:	Program concerning factual matters, presented in an investigative style.

Classification of the PTY codes for some FM stations may be different from the above list.

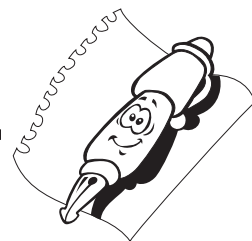

Amplifier

Output Power:

30 W per channel, min. RMS, both channels driven into 6 Ω at
1 kHz with no more than 10 % total harmonic distortion

Audio input sensitivity/Impedance (at 1 kHz)

AUX: 400 mV/50 k Ω

Speakers/Impedance: 6 Ω – 16 Ω

Tuner

FM tuning range: 87.50 MHz – 108.00 MHz

AM tuning range: MW: 522 kHz – 1,629 kHz

LW: 144 kHz – 288 kHz

CD player

CD Capacity: 3 CDs

Dynamic range: 85 dB

Signal-to-noise ratio: 90 dB

Wow and flutter: Immeasurable

Cassette deck

Frequency response:

Normal (type I): 50 Hz — 14,000 Hz

Wow and flutter:

0.15 % (WRMS)

General

Power requirement: AC 230 V \sim , 50 Hz

Power consumption: 68 W (at operation)

13 W (on standby)

Dimensions (approx.): 270 mm x 317 mm x 380 mm (W/H/D)

(10^{11/16} in. x 12^{1/2} in. x 15 in.)

Mass (approx.): 6.9 kg (15.3 lbs)

Supplied accessories

See page 6.



JVC INSTRUCTIONS

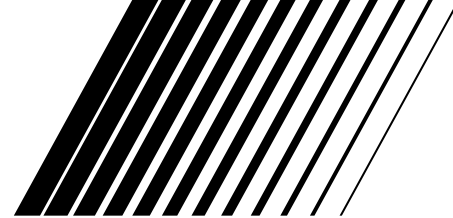

SPEAKER SYSTEM SP-MXJ150R

BEDIENUNGSANLEITUNG: LAUTSPRECHERSYSTEM
MANUEL D'INSTRUCTIONS: SYSTEME DES ENCEINTES
GEBRUIKSAANWIJZING: LUIDSPREKERSYSTEEM
MANUAL DE INSTRUCCIONES: SISTEMA DE ALTAVOCES
ISTRUZIONI: SISTEMA DI ALTOPARLANTI
BRUKSANVISNING: HÖGTALARSYSTEM

Thank you for purchasing JVC speakers.

Before you begin using them, please read the instructions carefully to be sure you get the best possible performance. If you have any questions, consult your JVC dealer.

Vielen Dank für den Kauf dieser JVC-Lautsprecher.

Lesen Sie bitte diese Bedienungsanleitung vor Ingebrauchnahme sorgfältig durch, um stets optimale Ergebnisse zu erzielen. Wenden Sie sich bei etwaigen Fragen bitte an Ihren JVC Händler.

Nous vous remercions pour l'achat de ces enceintes JVC.

Avant de les utiliser, lire ces instructions avec attention pour en obtenir les meilleures performances possibles. En cas de questions, consulter votre revendeur JVC.

Dank u voor de aanschaf van deze luidsprekers.

Lees alvorens over te gaan tot aansluiten, deze gebruiksaanwijzing door zodat u de best mogelijke prestaties zult verkrijgen. Neem contact op met de JVC dealer indien u vragen heeft.

Le estamos muy agradecidos por haber adquirido estos altavoces de JVC. Antes de utilizarlos, sírvase leer las instrucciones detenidamente a fin de obtener el mejor rendimiento posible. Si tienenaluna pregunta, acuda a su agente de JVC.

Grazie per aver acquistato questi altoparlanti della JVC.

Prima di cominciare l'uso degli altoparlanti, leggete attentamente le istruzioni per assicurare le migliori prestazioni. Qualora sorgessero dei dubbi, rivolgetevi al vostro rivenditore JVC.

VEJLEDNING: HØJTTALERSYSTEM
KÄYTTÖOHJE: KAIUTINJÄRJESTELMÄ
INSTRUKCJA UŻYTKOWANIA: ZESTAW GŁOŚNIKOWY
HASZNÁLATI ÚTMUTATÓ: HANGSZÓRÓ RENDSZER
NÁVOD K OBSLUZE: REPRODUKTOROVÁ SOUSTAVA

Tack för ditt val av dessa JVC-högtalare.

Innan du kopplar in högtalarna i din ljudanläggning bör du för att få maximala prestanda från högtalarna läsa igenom bruksanvisningen noggrant. Kontakta din JVC-återförsäljare om du har frågor eller känner dig osäker.

Tak for købet af JVC-højttalerne.

Gennemlæs venligst vejledningen omhyggeligt før de tages i brug, så De kan opnå den bedst mulige ydelse. Forhør hos Deres JVC forhandler hvis De har nogen spørgsmål.

Kiitos siitä että päädyit valinnassasi JVC-kaiuttimiin.

Ennen kuin alat käyttää niitä, lue käyttöohje huolellisesti, jotta ne toimisivat parhaalla mahdollisella tavalla. Jos Sinulla on kysyttävää ota yhteys JVC-edustajaan.

Dziękujemy za wybranie zestawu głośnikowego firmy JVC.

Przed rozpoczęciem użytkowania zestawu głośnikowego prosimy o dokładne zapoznanie się z treścią niniejszej instrukcji użytkowania, aby uzyskać jak najlepszą pracę głośników. W przypadku jakichkolwiek zapytań, prosimy o skonsultowanie się z najbliższym dealerm firmy JVC.

Köszönjük, hogy a JVC hangszóró rendszerét választotta. Annak érdekében, hogy a hangszóró rendszer a legjobb teljesítményt nyújtsa Önnek, használat előtt kérjük figyelmesen olvassa el ezt a használati útmutatót. Ha bármilyen kérdése van, forduljon a legközelebbi JVC márkakereskedőhöz.

Děkujeme Vám, že jste si zakoupili reproduktory JVC.

Dříve než je začnete používat, přečtěte si prosím pečlivě návod k obsluze, abyste dosáhli co nejlepší možné funkce. Jestliže máte další otázky, spojte se s svým prodejcem JVC.

— SAFETY INSTRUCTIONS — “SOME DOS AND DON'TS ON THE SAFE USE OF EQUIPMENT”

This equipment has been designed and manufactured to meet international safety standards but, like any electrical equipment, care must be taken if you are to obtain the best results and safety is to be assured.

Do read the operating instructions before you attempt to use the equipment.

Do ensure that all electrical connections (including the mains plug, extension leads and interconnections between pieces of equipment) are properly made and in accordance with the manufacturer's instructions. Switch off and withdraw the mains plug when making or changing connections.

Do consult your dealer if you are ever in doubt about the installation, operation or safety of your equipment.

Do be careful with glass panels or doors on equipment.

DON'T continue to operate the equipment if you are in any doubt about it working normally, or if it is damaged in any way — switch off, withdraw the mains plug and consult your dealer.

DON'T remove any fixed cover as this may expose dangerous voltages.

DON'T leave equipment switched on when it is unattended unless it is specifically stated that it is designed for unattended operation or has a standby mode.

Switch off using the switch on the equipment and make sure that your family know how to do this.

Special arrangements may need to be made for infirm or handicapped people.

DON'T use equipment such as personal stereos or radios so that you are distracted from the requirements of traffic safety. It is illegal to watch television whilst driving.

DON'T listen to headphones at high volume as such use can permanently damage your hearing.

DON'T obstruct the ventilation of the equipment, for example with curtains or soft furnishing.

Overheating will cause damage and shorten the life of the equipment.

DON'T use makeshift stands and NEVER fix legs with wood screws — to ensure complete safety always fit the manufacturer's approved stand or legs with the fixings provided according to the instructions.

DON'T allow electrical equipment to be exposed to rain or moisture.

ABOVE ALL

- NEVER let anyone, especially children, push anything into holes, slots or any other opening in the case.
- this could result in a fatal electrical shock;
- NEVER guess or take chances with electrical equipment of any kind
- it is better to be safe than sorry!

Amplifier connection
Verstärkeranschluß
Raccordement à l'amplificateur
Aansluiting op de versterker
Anslutning till en förstärkare
Conexión al amplificador
Collegamento dell'amplificatore
Forstærkertilslutning
Vahvistimen liitäntä
Połączenia ze wzmacniaczem
Erősítő csatlakoztatás
Zapojení zesilovače

Right speaker
 Rechter Lautsprecher
 Enceinte droite
 Rechter luidspreker
 Altavoz derecho
 Altoparlante destro
 Höger högtalare
 Højre højttaler
 Oikeanpuoleinen kaiutin
 Prawa kolumna
 Jobb hangszóró
 Pravý reproduktor

Left speaker
 Linker Lautsprecher
 Enceinte gauche
 Linker luidspreker
 Altavoz izquierdo
 Altoparlante sinistro
 Vänster högtalare
 Venstr højttaler
 Vasemmanpuoleinen kaiutin
 Lewa kolumna
 Bal hangszóró
 Levý reproduktor

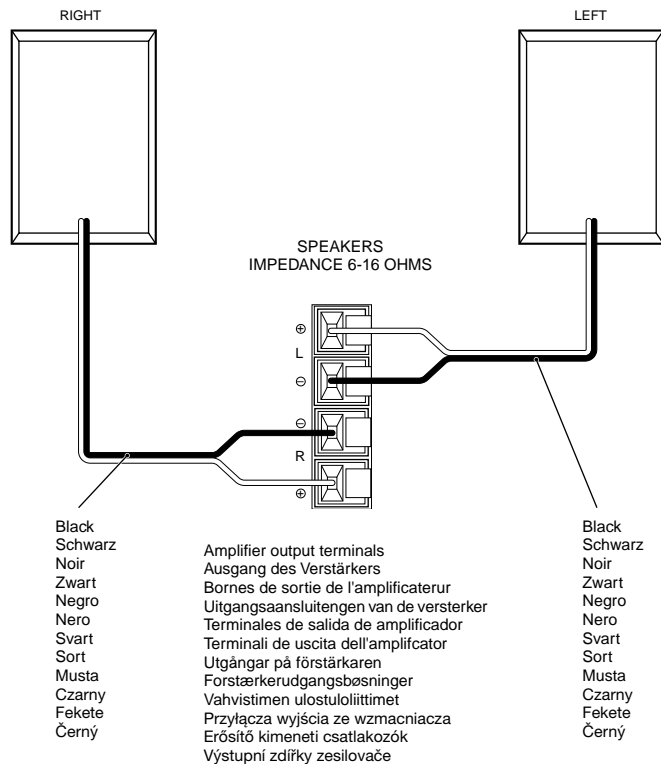

CONNECTION

- Turn off power to the whole system before connecting the speakers to the amplifier.
- The nominal impedance of the SP-MXJ150R is 6 Ω. Select for use an amplifier to which a speaker system with the load impedance of 6 Ω can be connected.
- The maximum power handling capacity of the SP-MXJ150R is 40 W. Excessive input will result in abnormal noise and possible damage. In cases where the signals described below are applied to the speakers, even if the signals are below the maximum allowable input, they may cause an overload and burn the wiring of the speakers. Be sure to lower the amplifier volume beforehand.
 - 1) Noise during FM tuning.
 - 2) High level signals containing high frequency components produced by a tape deck in the fast forward mode.
 - 3) Click noise produced when turning power of other components on and off.
 - 4) Click noise produced when connecting or disconnecting cords with the power on.
 - 5) Click noise produced when the cartridge is replaced with the power on.
 - 6) Click noise produced when operating amplifier switches.
 - 7) Continuous high frequency oscillation or high pitch electronically produced musical instrument sound.
 - 8) Howling when using a microphones.

SPECIFICATIONS

Type	: 2-way bass-reflex type
Speaker units	
Woofer	: 12 cm (4-3/4 in.) cone × 1
Tweeter	: 2 cm (13/16 in.) piezo × 1
Power Handling Capacity	: 40 W
Impedance	: 6 Ω
Frequency Range	: 50 Hz - 18 000 Hz
Sound Pressure Level	: 87 dB/W-m
Dimensions (approx.)	: 219 mm × 317 mm × 219 mm (8-5/8 in. × 12-1/2 in. × 8-5/8 in.)
Mass (approx.)	: 3.1 kg (6.9 lbs) each

Design and specifications subject to change without notice.

ANSCHLUSS

- Schalten Sie vor dem Anschluß der Lautsprecher an den Verstärker die Spannungsversorgung des gesamten Systems aus.
- Die Nennimpedanz der Lautsprecher — Systeme SP-MXJ150R beträgt 6 Ω . Wählen Sie einen Verstärker, an den ein Lautsprechersystem mit einer Lastimpedanz von 6 Ω angeschlossen werden kann.
- Die maximale Belastbarkeit der SP-MXJ150R beträgt 40 W. Eine Überlastung führt zu Verzerrungen und möglicherweise zu Beschädigungen.
Signale der unten beschriebenen Art können, auch wenn sie unter dem maximal zulässigen Eingang liegen, eine Überlastung verursachen und die Lautsprecherwicklungen durchbrennen. Verringern Sie vorher die Lautstärke des Verstärkers.
 - 1) Geräusche beim Einstellen von UKW-Sendern.
 - 2) Hochpegelige Signale mit Hochfrequenz-Anteilen, die von Tonbanddecks beim Schnellvorspulen erzeugt werden.
 - 3) Klickgeräusche, wenn die Spannungsversorgung anderer Komponenten ein- und ausgeschaltet wird.
 - 4) Klickgeräusche, wenn Kabel angeschlossen oder abgetrennt werden, während die Spannungsversorgung eingeschaltet ist.
 - 5) Klickgeräusche, wenn der Tonabnehmer des Plattenspielers ausgewechselt wird, während die Spannungsversorgung eingeschaltet ist.
 - 6) Klickgeräusche, die beim Betätigen von Schaltern des Verstärkers erzeugt werden.
 - 7) Ständige Hochfrequenzschwingungen oder elektronisch erzeugte Töne von Musikinstrumenten mit hohen Tonhöhen.
 - 8) Rückkopplungen von Mikrofonen.

TECHNISCHE DATEN

Typ	: 2-Weg Baßreflexbox
Lautsprechereinheiten	
Tieftöner	: 12 cm – Konus \times 1
Hochtöner	: 2 cm – Piezo \times 1
Belastbarkeit	: 40 W
Impedanz	: 6 Ω
Frequenzbereiche	: 50 Hz - 18 000 Hz
Schalldruckpegel	: 87 dB/W·m
Abmessungen (Ca.)	: 219 mm \times 317 mm \times 219 mm
(W \times H \times T)	
Gewicht (Ca.)	: je 3,1 kg.

Technische Änderungen vorbehalten.

RACCORDEMENT

- Mettre hors circuit tout le système avant de raccorder les enceintes à l'amplificateur.
- L'impédance nominale des enceintes SP-MXJ150R est de 6 Ω . Sélectionner un amplificateur acceptant une impédance de charge de haut-parleur de 6 Ω .
- La puissance maximum admissible des SP-MXJ150R est, respectivement, de 40 W.
En dépassant la puissance admissible, cela provoquera des bruits anormaux et détériorera les enceintes.
Au cas où les signaux décrits ci-dessous sont envoyés aux enceintes, et même si ces signaux sont inférieurs à la puissance d'entrée maximum admissible, ils risquent de provoquer une surcharge ou même un incendie. S'assurer de bien diminuer le volume sonore de l'amplificateur.
 - 1) Parasites durant une syntonisation FM.
 - 2) Signaux de niveau élevé contenant des composants à haute fréquence, comme ceux générés par une platine d'enregistrement en mode avance rapide.
 - 3) Cliquetis se produisant lorsque d'autres appareils sont mis en ou hors circuit.
 - 4) Cliquetis se produisant lorsque des appareils sont branchés ou dé-branchés alors que leur alimentation est en circuit.
 - 5) Cliquetis se produisant lorsque la cellule d'une platine tourne-disque est changée alors que l'alimentation est en circuit.
 - 6) Cliquetis se produisant lorsque les commandes de l'amplificateur sont manipulées.
 - 7) Oscillations continues à haute fréquence ou sons très aigus provenant d'instruments de musique électroniques.
 - 8) Hurlements dus à l'utilisation de micros.

CARACTERISTIQUES

Type	: Enceinte 2 voies type à réflexion des basses
Enceintes	
Graves	: conique de 12 cm \times 1
Aigus	: piezo de 2 cm \times 1
Puissance admissible	: 40 W
Impédance	: 6 Ω
Gamme de fréquence	: 50 Hz - 18 000 Hz
Niveau de pression sonore	: 87 dB/W·m
Dimensions (Environ)	: 219 mm \times 317 mm \times 219 mm
(L \times H \times P)	
Masse (Environ)	: 3,1 kg chaque

Présentation et caractéristiques modifiables sans préavis.

AANSLUITINGEN

- Schakel de spanning van alle aangesloten componenten uit alvorens de luidsprekers met de versterker te verbinden.
- De nominale impedantie van de SP-MXJ150R bedraagt 6 Ω . Kies daarom een versterker waarop u een luidsprekersysteem kunt aansluiten met een impedantie belasting van 6 Ω .
- Het maximum verwerkingsvermogen van de SP-MXJ150R bedraagt 40 W. Te hoge ingang kan in abnormale geluidsreproductie en in beschadigingen resulteren. Overbelasting en verbranding van de bedrading kan worden veroorzaakt, wanneer de hieronder beschreven signalen naar de luidsprekers worden gevoed, zelfs wanneer de signalen onder het maximaal toegestane ingangsvermogen zijn. Verminder eerst het volume van de versterker.
 - 1) Ruis, zoals dit optreedt tijdens afstemming op een FM-zender.
 - 2) Hoogfrequentie signalen van een hoog niveau, zoals die tijdens het vooruitspoelen van een tapedeck worden geproduceerd.
 - 3) Klikkende geluiden, die worden veroorzaakt door het in- en uitschakelen van de netspanning van andere componenten.
 - 4) Klikkende geluiden, zoals die worden geproduceerd bij het tot stand brengen of verbreken van aansluitingen terwijl de netspanning is ingeschakeld.
 - 5) Klikkende geluiden, zoals die optreden bij het vervangen van het element van een draaitafel terwijl de netspanning is ingeschakeld.
 - 6) Klikkende geluiden, zoals die worden geproduceerd door bediening van de schakelaars van de versterker.
 - 7) Voortdurende hoogfrequentie-oscillatie, of hoogtonige, elektronisch geproduceerde geluiden van muziekinstrumenten.
 - 8) Rondzingend geluid bij gebruik van microfoons.

TECHNISCHE GEGEVENS

Type	: 2 tweeweg bass reflex
Luidsprekers	
Woofer	: 12 cm - kegeltipe \times 1
Tweeter	: 2 cm - piëzo \times 1
Toegestane vermogenverwerking	: 40 W
Impedantie	: 6 Ω
Frekwentiekarakteristiek	: 50 Hz - 18 000 Hz
Geluidsdruk-niveau	: 87 dB/W-m
Afmetingen (Ongeveer)	: 219 mm \times 317 mm \times 219 mm
(B \times H \times D)	
Gewicht (Ongeveer)	: Elk 3,1 kg

Veranderingen in technische gegevens en ontwerp onder voorbehoud.

CONEXIÓN

- Desactive la alimentación de todo el sistema antes de conectar los altavoces al amplificador.
- La impedancia nominal del SP-MXJ150R es de 6 Ω . Seleccione un amplificador al que puedan conectarse altavoces con una impedancia de carga de 6 Ω .
- La potencia máxima de salida del SP-MXJ150R es de 40 W. Uná entrada excesiva resultará en ruido anormal y posibles daños. En casos donde las señales descritas más abajo se apliquen a los altavoces, aunque las mismas resulten menores que la entrada máxima permisible, pueden causar una sobrecarga y quemar el cableado de los altavoces. Asegúrese de disminuir el volumen del amplificador con anterioridad.
 - 1) Ruido durante la sintonía en FM.
 - 2) Señales de alto nivel que contengan componentes de alta frecuencia producidos por un magnetófono en el modo de avance rápido.
 - 3) Ruidos de conmutación provocados al encender y apagar otros componentes.
 - 4) Ruido de conmutación al conectar o desconectar cables con los componentes encendidos.
 - 5) Ruido de conmutación cuando se reemplaza la cápsula con los componentes encendidos.
 - 6) Ruido de conmutación provocados por la operación de los selectores del amplificador.
 - 7) Continua oscilación de alta frecuencia o de sonidos de tonos altos provocados por instrumentos electrónicos.
 - 8) Aullidos al utilizar micrófonos.

ESPECIFICACIONES

Tipo	: Reflex bajo con 2 vías
Unidades de altavoces	
De graves	: Tipo cónico de 12 cm \times 1
De agudos	: Piezo de 2 cm \times 1
Potencia máxima	: 40 W
Impédance	: 6 Ω
Gama de frecuencias	: 50 Hz - 18 000 Hz
Nivel de presión sonora	: 87 dB/W-m
Dimensiones (Aprox.)	: 219 mm \times 317 mm \times 219 mm
(An \times Al \times Pr)	
Peso (Aprox.)	: 3,1 kg cada uno

El diseño y las especificaciones están sujetos a cambio sin aviso.

COLLEGAMENTO

- Spegnete la corrente dell'intero sistema prima di collegare gli altoparlanti all'amplificatore.
- L'impedenza nominale del modello SP-MXJ150R è 6 Ω. Selezionate per l'uso un amplificatore a cui collegare un altoparlante con un'impedenza di carico di 6 Ω.
- La capacità di corrente massima del modello SP-MXJ150R è 40 W. Un ingresso eccessivo causerà un suono anormale e possibili danni.

Nel caso in cui i segnali descritti qui sotto vengono applicati agli altoparlanti, possono causare un sovraccarico e bruciare il cablaggio degli altoparlanti, anche se i segnali siano al di sotto dell'ingresso massimo ammesso.

Assicuratevi di diminuire il livello del volume dell'altoparlante prima di procedere.

- 1) Generazione di rumore durante la sintonizzazione FM.
- 2) Segnali di alto livello che contengono dei componenti ad alta frequenza riprodotti da una piastra a cassette nel modo di avanzamento rapido.
- 3) Si sentirà uno scatto quando accendete o spegnete la corrente degli altri componenti.
- 4) Si sentirà uno scatto quando collegate o scollegate i cavi con la corrente accesa.
- 5) Si sentirà uno scatto quando viene sostituita la cartuccia con la corrente accesa.
- 6) Si sentirà uno scatto quando vengono usati gli interruttori dell'amplificatore.
- 7) Oscillazione continua ad alta frequenza o suoni acuti da strumenti musicali elettronici.
- 8) Ululato quando usate i microfoni.

SPECIFICAZIONI

Tipo	: Reflex basso con 2 vie
Le unità altoparlante	
Woofer	: A cono, di 12 cm × 1
Tweeter	: Piezoelettrico, di 2 cm × 1
Capacità di potenza	: 40 W
Impedenza	: 6 Ω
Gamma di frequenza	: Da 50 Hz - 18 000 Hz
Livello della pressione sonora	: 87 dB/W·m
Dimensioni (Circa)	: 219 mm × 317 mm × 219 mm
(L × A × P)	
Massa (Circa)	: 3,1 kg. ciascuno

Il disegno e le specificazioni sono soggetti a cambiamenti senza preavviso.

ANSLUTNING

- Slå av strömmen i alla apparater i ljudanläggningen innan högtalarna ansluts till förstärkaren.
- Nominell impedans för SP-MXJ150R är 6 Ω. Se till att använda en förstärkare till vilken högtalare med en belastnings impedans på 6 Ω kan anslutas.
- Maximal effekthanteringskapacitet hos SP-MXJ150R är 40 W. Brus uppstår i ljudet och högtalarna kan skadas om de matas med för hög effekt. I situationerna som beskrivs nedan kan högtalarna också överbelastas och kabeltråden inne i högtalarna brännas sönder, fastän högtalarnas effekt inte har överskridits. Sänk därför ljudstyrkan på förhand.
 - 1) Brus under inställning av FM-radiostationer.
 - 2) Starka, högfrekventa signaler från ett kassettdäck under snabbspolning framåt.
 - 3) Ljudbangar som uppstår när andra apparater i anläggningen slås till och från.
 - 4) Skrapljud som uppstår när anslutningskablar ansluts eller kopplas från medan strömmen är på.
 - 5) Skrapljud som uppstår när pickupelementet på en skivspelare byts medan strömmen är på.
 - 6) Ljudbangar som uppstår när du använder förstärkarens omkopplare.
 - 7) Kontinuerliga, högfrekvenssvängningar eller högfrekvent ljud från elektroniska musikinstrument.
 - 8) Akustisk återkoppling (tjutande ljud) vid bruk av mikrofoner.

TEKNISKA DATA

Typ	: 2-vägs basreflexhögtalare
Högtalarelement	
Bas	: 12 cm kon × 1
Diskant	: 2 cm kristallformat × 1
Effekthanteringskapacitet	: 40 W
Impedans	: 6 Ω
Frekvensåtergivning	: 50 Hz - 18 000 Hz
Ljudtrycksnivå	: 87 dB/W·m
Yttermått (Ca.) (B × H × D)	: 219 mm × 317 mm × 219 mm
Vikt (Ca.)	: 3,1 kg per st.

Rätt till ändringar av utförande och specifikationer förbehålles utan föregående meddelande.

TILSLUTNING

- Sluk for strømmen til hele systemet før højttalerne forbindes til forstærkeren.
- Den nominelle impedans for SP-MXJ150R er 6 Ω. Anvend en forstærker, hvortil der kan tilsluttes et højttalersystem med en belastningsimpedans på 6 Ω.
- Den maksimale belastningskapacitet for SP-MXJ150R er 40 W. For kraftigt indgangssignal vil resultere i unormal støj og muligvis beskadigelse.

I tilfælde hvor højttalerne udsættes for signaler beskrevet nedenfor, kan der forekomme overbelastning og overbrænding af ledningerne i højttalerne selv om signalstyrken er under den maksimale tilladte værdi. Husk derfor at at sænke højttalerlydstyrken i forvejen.

- 1) Støj under FM-afstemning.
- 2) Signaler med høje niveauer der indeholder højfrekvente komponenter dannet af en båndoptager der er indstillet til hurtig fremspoling.
- 3) Klikstøj dannet når der tændes eller slukkes for strømmen til andre komponenter.
- 4) Klikstøj der dannes når ledninger tilsluttes eller tages ud af forbindelse mens der er tændt for strømmen.
- 5) Klikstøj der dannes når pickuppen udskiftes mens der er tændt for strømmen.
- 6) Klikstøj der dannes når forstærkerens omskiftere betjenes.
- 7) Fortsat høj frekvenssvingning, eller en højlyd dannet af et elektronisk instrument.
- 8) Hyletoner når der anvendes en mikrofon.

SPECIFIKATIONER

Type	: 2-vejs basrefleks-højttaler
Højttalerenheder	
Bashøjttaler	: 12 cm membran × 1
Diskanthøjttaler	: 2 cm piezo × 1
Belastningskapacitet	: 40 W
Impedans	: 6 Ω
Frekvensområde	: 50 Hz - 18 000 Hz
Lydtryksniveau	: 87 dB/W·m
Mål (Ca.) (B × H × D)	: 219 mm × 317 mm × 219 mm
Vægt (Ca.)	: 3,1 kg hver

Design og specifikationer kan blive ændret uden varsel.

LIITÄNTÄ

- Katkaise koko järjestelmän virta ennen kuin suoritat liitännät kaiuttimista vahvistimeen.
- Mallin SP-MXJ150R nimellinen impedanssi on 6 Ω. Valitse käytettäväksi vahvistin, johon voidaan liittää 6 Ω kuormitusimpedanssin omaavat kaiuttimet.
- Mallin SP-MXJ150R enimmäisteho on 40 W. Liiallinen antoteho aiheuttaa epänormaalia kohinaa ja jopa vahinkoa. Tapauksissa, missä kaiuttimet joutuvat alla kuvattujen signaalien kohteeksi, vaikka signaalit olisivat alle sallitun maksimi antotehon, ne saattavat aiheuttaa ylikuormitusta ja polttaa kaiuttimien johdot. Vähennä siis vahvistimen äänenvoimakkuutta jo ennalta.
 - 1) Kohinaa FM-virityksen aikana.
 - 2) Kasettidekistä eteenpäinkelauksen aikana muodostuneet vahvat, korkeataajuuksisia komponentteja sisältävät signaalit.
 - 3) Klik-ääni, joka syntyy silloin kun toisten osien virta kytketään ja katkaistaan.
 - 4) Klik-ääni, joka syntyy silloin kun kytketään tai irrotetaan johtoja virran ollessa päällä.
 - 5) Klik-ääni, joka syntyy silloin kun vaihdetaan hylsy virran ollessa päällä.
 - 6) Klik-ääni, joka syntyy silloin kun käytetään vahvistimen kytkimiä.
 - 7) Jatkuva korkea värähtely tai elektronisesti tuotettu korkea soittimen ääni.
 - 8) Ullinaa mikrofonia käytettäessä.

TEKNISET TIEDOT

Tyyppi	: 2-tie, bassorefleksi
Kaiutinyksiköt	
Basso	: 12 cm kartiomuotoinen × 1
Diskantti	: 2 cm piezo × 1
Enimmäisteho	: 40 W
Impedanssi	: 6 Ω
Taajuusalue	: 50 Hz - 18 000 Hz
Äänenpainetaso	: 87 dB/W·m
Mitat (Noin) (L × K × S)	: 219 mm × 317 mm × 219 mm
Paino (Noin)	: 3,1 kg / kaiutin

Oikeudet muutoksiin pidätetään.

PODŁĄCZENIE

- Przed podłączeniem kolumn do wzmacniacza najpierw wyłączyć sieć całego zestawu.
- Impedancja znamionowa kolumn zestawu głośnikowego SP-MXJ150R wynosi 6 Ω.
Wybrać taki wzmacniacz, który pozwala na podłączenie kolumn o impedancji obciążeniowej wynoszącej 6 Ω.
- Maksymalna moc kolumn zestawu głośnikowego SP-MXJ150R wynosi 40 W. Zbyt wysoki poziom sygnału na wejściu kolumn powoduje zniekształcenie dźwięku, a nawet może spowodować uszkodzenie głośników. W przypadku poddania głośników sygnałom wyszczególnionym poniżej może nastąpić przeciążenie głośników oraz przepalenie przewodów głośników nawet, jeżeli sygnały te są poniżej maksymalnego dopuszczalnego poziomu. Pamiętać zawsze o uprzednim zmniejszeniu poziomu głośności wzmacniacza.
 - 1) Szumy w czasie dostrajania pasma FM.
 - 2) Sygnały o wysokim poziomie charakteryzujące się wysokimi częstotliwościami wytworzonymi przez magnetofon kasetowy w czasie przewijania taśmy do przodu.
 - 3) Trzaski pojawiające się w czasie włączania i wyłączenia sieci innych elementów zestawu.
 - 4) Trzaski pojawiające się w czasie podłączania lub odłączania przewodów, kiedy sieć jest włączona.
 - 5) Trzaski pojawiające się w czasie wymiany wkładki gramofonowej, kiedy sieć jest włączona.
 - 6) Trzaski pojawiające się w czasie przełączania włączonego wzmacniacza.
 - 7) Długotrwałe oscylujące wysokie częstotliwości lub inne dźwięki wysokiej częstotliwości elektronicznie syntezowane przez instrument muzyczny.
 - 8) Gwizdy w czasie używania mikrofonu.

DANE TECHNICZNE

Typ	: Dwudrożny bass-reflexem
Kolumny głośnikowe	
Niskotonowy	: stożkowy, 12 cm śr. × 1
Wysokotonowy	: piezo, 2 cm śr. × 1
Moc max	: 40 W
Impedancja	: 6 Ω
Zakres częstotliwości	: 50 Hz - 18 000 Hz
Poziom ciśnienia akustycznego	: 87 dB/W·m
Wymiary (Ok.)	: 219 mm × 317 mm × 219 mm
(szer. × wys. × głęb.)	
Masa (Ok.)	: 3,1 kg każdy

Wygląd zewnętrzny oraz dane techniczne urządzenia mogą ulec zmianie bez uprzedzenia.

CSATLAKOZTATÁS

- Mielőtt a rendszert csatlakoztatná az erősítőhöz, kapcsoljon ki minden berendezést.
- Az SP-MXJ150R rendszer névleges impedanciája 6 Ω.
Olyan erősítőt válasszon, amelyhez 6 Ω terhelő impedanciával rendelkező hangszóró rendszer csatlakoztatható.
- Az SP-MXJ150R rendszer maximális bemenő teljesítménye 40 W. Nagy energiájú bemeneti jel rendellenes zajt generálhat és a rendszer károsodását okozhatja. Az alább leírt jelek még a maximális megengedett bemeneti szint alatt is a rendszer túlterhelését és a hangszóró tekercsek leégését okozhatják.
 - 1) FM (URH) hangolás alatti zaj.
 - 2) A magnódeck gyors előretekerés során keletkező, magas frekvenciájú komponenseket tartalmazó intenzív jelek.
 - 3) Egyéb berendezés be és kikapcsolásakor keletkező kattanó zaj.
 - 4) Bekapcsolt üzemállapotban a tápkábel össze és szétcsatlakoztatásakor keletkező kattanó zaj.
 - 5) Bekapcsolt üzemállapotban történő patroncsere során keletkező
 - 6) Az erősítő kapcsolóinak használatakor keletkező kattanó zaj.
 - 7) Elektromos hangszer által keltett folyamatos, magas frekvenciájú rezgésű vagy magas tónusú hang.
 - 8) Mikrofon használatakor keletkező füttyülő zaj.

MŰSZAKI ADATOK

Típus	: 2-utas basszreflex típus
Hangsugárzó egység	
Mélyszugárzó	: 12 cm, kónuszos, × 1
Magassugárzó	: 2 cm, piezoelektromos, × 1
Bemenő teljesítmény	: 40 W
Impedancia	: 6 Ω
Frekvenciatartomány	: 50 Hz - 18 000 Hz
Hangnyomásszint	: 87 dB/W·m
Méreték (kb.)	
(szélesség × magasság × mélység)	: 219 mm × 317 mm × 219 mm
Tömeg (kb.)	: 3,1 kg/darab

A formaterv és a műszaki adatok változtatásának joga – minden külön értesítés nélkül – fenntartva.

ZAPOJENÍ

- Vypojte napájení celé soustavy před zapojením reproduktorů k zesilovači.
- Jmenovitá impedance SP-MXJ150R je 6 Ω.
Zvolte si k používání zesilovač, k němuž je možné zapojit reproduktorovou soustavu s impedancí zátěže 6 Ω.
- Maximální kapacita příkonu, který může zpracovat SP-MXJ150R, je 40 W. Nadměrný příkon způsobí abnormální hluk a možné poškození. V případech popsaných níže a to i tehdy, jsou-li signály pod úrovní maximálního možného příkonu, může dojít k přetížení a ke spálení vinutí reproduktorů. Dbejte na snížení výkonu zesilovače předem.
 - 1) Šum během FM ladění.
 - 2) Signály vysoké úrovně obsahující vysokofrekvenční komponenty vytvořené magnetofonem při rychlém převíjení vpřed.
 - 3) Zvuk lupnutí vytvořený během zapínání a vypínání ostatních komponentů.
 - 4) Zvuk lupnutí vytvořený během zapojování nebo rozpojování šňůr na zapnutém přístroji.
 - 5) Zvuk lupnutí vytvořený při výměně zásobníku na zapnutém přístroji.
 - 6) Zvuk lupnutí vytvořený při obsluze přepínačů zesilovače.
 - 7) Spojitý vysokofrekvenční oscilační nebo vysokotónový zvuk elektronicky vytvořený hudebním nástrojem.
 - 8) Houkání při použití mikrofonů.

TECHNICKÁ SPECIFIKACE

Typ	: 2-pásmový basreflexový typ
Reproduktorové soustavy	
Hlubkový	: 12 cm kuželový × 1
Výškový	: 2 cm piezový × 1
Kapacita zpracovatelného příkonu	: 40 W
Impedance	: 6 Ω
Frekvenční rozsah	: 50 Hz - 18 000 Hz
Hladina zvukového tlaku	: 87 dB/W·m
Rozměry (Přibl.) (Š × V × H)	: 219 mm × 317 mm × 219 mm
Hmotnost (Přibl.)	: 3,1 kg každý

Vzhled a specifikace podléhají změnám bez předchozího upozornění.

JVC

VICTOR COMPANY OF JAPAN, LIMITED



EN. GE. FR. NL. SP. IT. SW. FI. DA. PO. HU. CZ.



0500KSMPRISAM

Free Manuals Download Website

<http://myh66.com>

<http://usermanuals.us>

<http://www.somanuals.com>

<http://www.4manuals.cc>

<http://www.manual-lib.com>

<http://www.404manual.com>

<http://www.luxmanual.com>

<http://aubethermostatmanual.com>

Golf course search by state

<http://golfingnear.com>

Email search by domain

<http://emailbydomain.com>

Auto manuals search

<http://auto.somanuals.com>

TV manuals search

<http://tv.somanuals.com>