

JVC

COMPACT COMPONENT MD SYSTEM

CA-MXS6MD

MDLP



COMPACT
disc
DIGITAL AUDIO

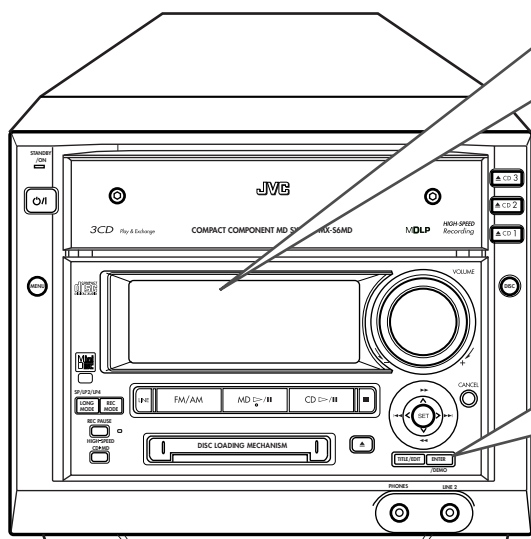
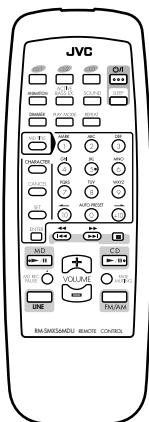

Display Demonstration
Each time you plug the power cord to the AC outlet. Display demonstration starts automatically in the main display.

To stop and cancel the display demonstration, press ENTER/DEMO on the unit so that "DEMO OFF!" appears in the main display.

- For more detailed information about demonstration, see page 9.

INSTRUCTIONS

For Customer Use:

Enter below the Model No. and Serial No. which are located either on the rear, bottom or side of the cabinet. Retain this information for future reference.

Model No. _____

Serial No. _____

LVT0529-004A

[UJ]

Warnings, Cautions and Others

Caution — switch!

Disconnect the mains plug to shut the power off completely (the STANDBY/ON lamp goes off).

The  switch in any position does not disconnect the mains line.

- When the unit is on standby, the STANDBY/ON lamp lights red.
- When the unit is turned on, the STANDBY/ON lamp lights green.

The power can be remote controlled.

CAUTION

To reduce the risk of electrical shocks, fire, etc.:

1. Do not remove screws, covers or cabinet.
2. Do not expose this appliance to rain or moisture.

IMPORTANT FOR LASER PRODUCTS

REPRODUCTION OF LABELS

- ① CLASSIFICATION LABEL, PLACED ON REAR ENCLOSURE ② WARNING LABEL, PLACED INSIDE THE UNIT

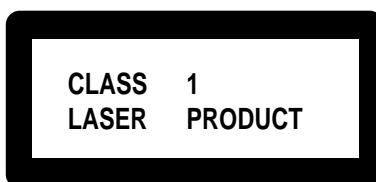

-
1. CLASS 1 LASER PRODUCT
 2. **DANGER:** Invisible laser radiation when open and interlock failed or defeated. Avoid direct exposure to beam.
 3. **CAUTION:** Do not open the top cover. There are no user serviceable parts inside the Unit; leave all servicing to qualified service personnel.

Caution: Proper Ventilation

To avoid risk of electric shock and fire, and to prevent damage, locate the apparatus as follows:

- 1 Front: No obstructions and open spacing.
- 2 Sides/ Top/ Back: No obstructions should be placed in the areas shown by the dimensions below.
- 3 Bottom: Place on the level surface. Maintain an adequate air path for ventilation by placing on a stand with a height of 10 cm or more.

Front View

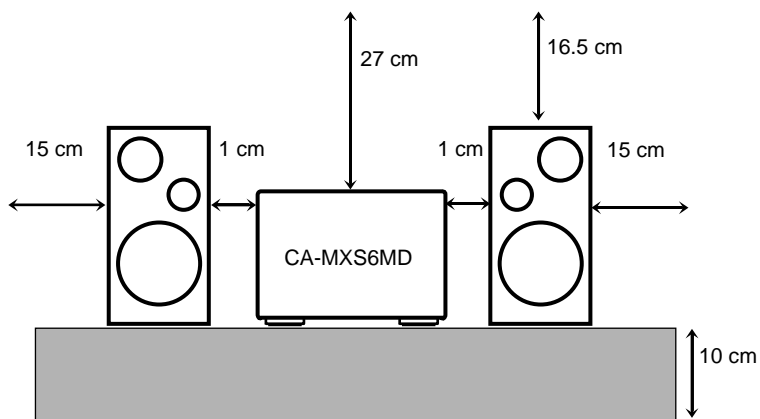

Side View

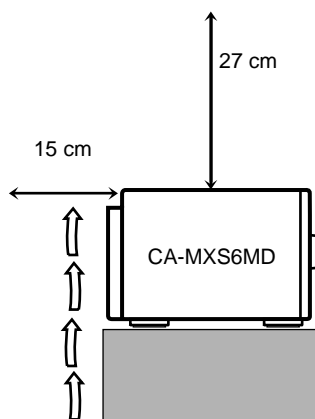



Introduction

We would like to thank you for purchasing one of our JVC products. Before operating this unit, read this manual carefully and thoroughly to obtain the best possible performance from your unit, and retain this manual for future reference.

About This Manual

This manual is organized as follows:

- This manual mainly explains playback operations using the remote control, and the other operation such as recording and editing operations using the buttons and controls on the unit. You can use the buttons and controls both on the remote control and on the unit for the same operations if they have the same or similar names (or marks), unless mentioned otherwise.
- Basic and common information that is the same for many functions is grouped in one place, and is not repeated in each procedure. For instance, we do not repeat the information about turning on/off the unit, setting the volume, changing the sound effects, and others, which are explained in the section “Basic and Common Operations” on pages 10 – 16.
- The following marks are used in this manual:

	Gives you warning and caution to prevent from damage or risk of fire/electric shock. Furthermore, gives you information which is not good for obtaining the best possible performance from the unit.
	Gives you information and hints you had better know.
	Indicates that you have to refer to the menu operation.

Precautions

Installation

- Install in a place which is level, dry and neither too hot nor too cold — between 5°C (41°F) and 35°C (95°F).
- Install the unit in a location with adequate ventilation to prevent internal heat buildup in the unit.
- Leave sufficient distance between the unit and the TV.
- Keep the speakers away from the TV to avoid interference with TV.



DO NOT install the unit in a location near heat sources, or in a place subject to direct sunlight, excessive dust or vibration.

Power sources

- When unplugging the unit from the wall outlet, always pull the plug, not the AC power cord.



DO NOT handle the AC power cord with wet hands.

Moisture condensation

Moisture may condense on the lens inside the unit in the following cases:

- After starting heating in the room
 - In a damp room
 - If the unit is brought directly from a cold to a warm place
- Should this occur, the unit may malfunction. In this case, leave the unit turned on for a few hours until the moisture evaporates, unplug the AC power cord, then plug it in again.

Others

- Should any metallic object or liquid fall into the unit, unplug the AC power cord and consult your dealer before operating any further.
- If you are not going to operate the unit for an extended period of time, unplug the AC power cord from the wall outlet.



DO NOT disassemble the unit since there are no user serviceable parts inside.

If anything goes wrong, unplug the AC power cord and consult your dealer.

Contents

Location of the Buttons and Controls	3
Main Unit	4
Remote Control	5
Getting Started	6
Unpacking	6
Adjusting the Voltage Selector	6
Connecting Antennas	6
Connecting Speakers	7
Connecting Other Equipment	8
Putting the Batteries into the Remote Control	9
Basic and Common Operations	10
Turning On the Power	11
Selecting the Sources and Starting Play	11
Adjusting the Volume	12
Reinforcing the Bass Sound	12
Selecting the Display Brightness	12
Changing the Main Display Screen	13
Selecting the Animation Characters	14
• To store the display setting in memory	15
Selecting the Sound Modes	15
Creating Your Own Sound Mode	16
— MANUAL Mode	16
Listening to FM and AM Broadcasts	17
Setting the AM Tuner Interval Spacing	18
Tuning in a Station	18
Presetting Stations	18
Tuning in a Preset Station	19
Playing Back CDs	20
Loading CDs	21
Playing Back the Entire Discs	21
— Continuous Play	21
Basic CD Operations	22
Programing the Playing Order of the Tracks	22
— Program Play	22
Playing at Random — Random Play	24
Repeating Tracks or CDs — Repeat Play	25
Prohibiting Disc Ejection — Disc Lock	25
Playing Back an MD	26
Playing Back the Entire MD — Normal Play	27
Basic MD Operations	27
Programing the Playing Order of the Tracks	28
— Program Play	28
Playing at Random — Random Play	29
Repeating Tracks — Repeat Play	30
Recording on MDs	31
Before You Start Recording	32
• About the track marks	32
• To avoid erasing important recordings	32
• Stereo Long-Hour Recording (MDLP)	33
• About High-Speed Recording	34
Recording Any Sound Source	34
— Standard Recording	34
Recording CDs — CD Synchronized Recording	35
• All CDs Synchronized Recording	35
• One CD Synchronized Recording	36
• First Track Recording	37
Recording the External Equipment	38
— Sound Synchronized Recording	38
Editing MDs	39
Introducing MD Editing Functions	40
DIVIDE Function	41
JOIN Function	42
MOVE Function	42
ERASE Function	43
ALL ERASE Function	44
Making Your Own Titles and Screens	45
Assigning Titles to an MD	46
Creating Your Own Opening and Ending Screens	50
Using the Timers	51
Setting the Clock	52
Using Recording Timer	52
Using Daily Timer	54
Using Sleep Timer	57
Timer Priority	57
Using the Other Convenient Functions	58
Sound Setting	60
FM Reception Mode Setting	61
CD and MD Playback Mode Setting	61
Display Setting	62
External Source Setting	63
Auto Power Off Setting	64
Maintenance	65
Additional Information	66
MD Disc Types	66
ATRAC (Adaptive TRansform Acoustic Coding)/	66
ATRAC3 (MDLP)	66
UTOC (User Table Of Contents)	66
Sound Skip Guard Memory	66
SCMS (Serial Copy Management System)	67
HCMS (High-speed Copy Management System) ..	67
• MD limitations	67
MD Messages	68
Troubleshooting	69
Specifications	70

Location of the Buttons and Controls

Become familiar with the buttons and controls on your unit.

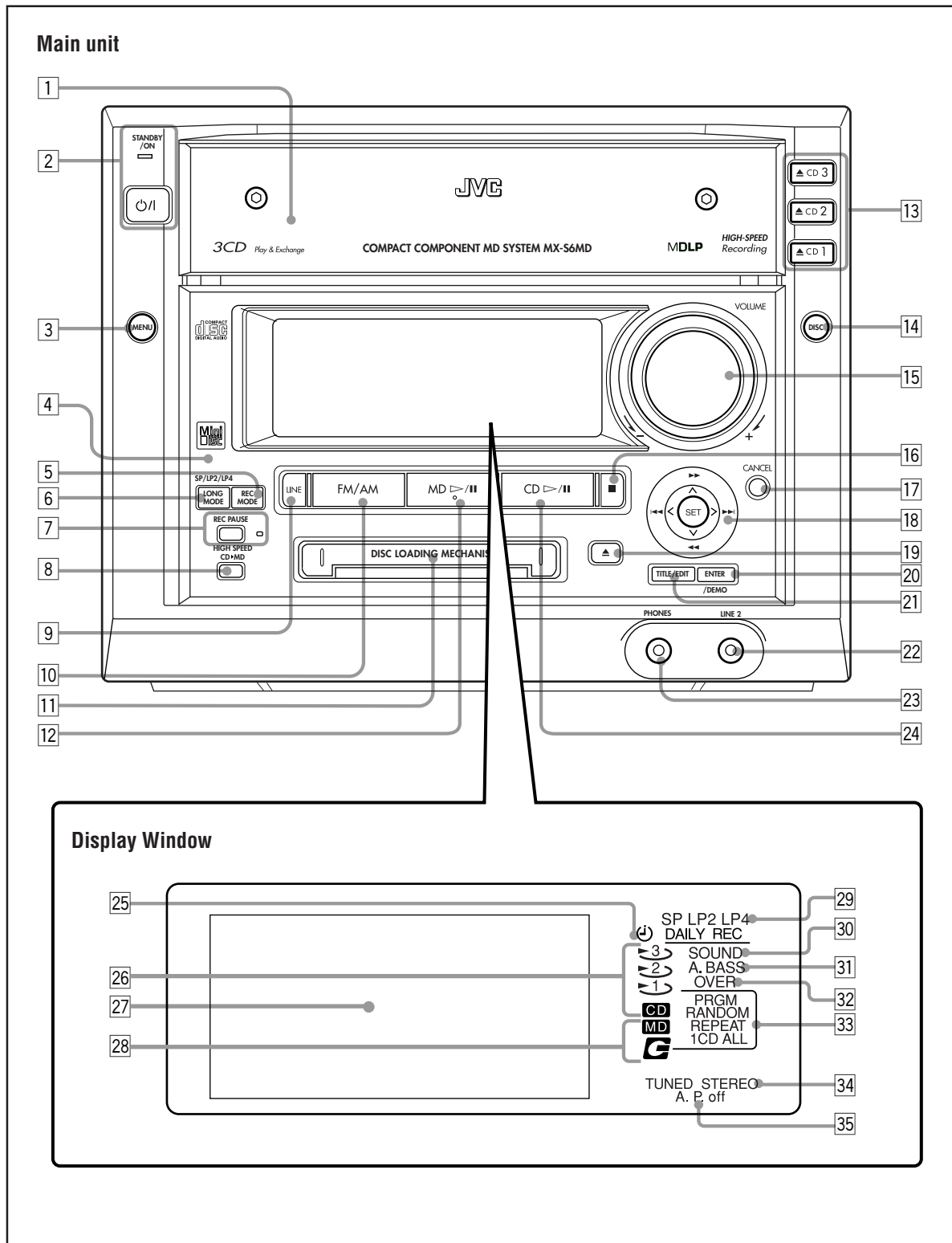

See pages in the parentheses for details.

Main Unit

- 1 Disc trays (21)
- 2 \odot/I (Standby/On) button and STANDBY/ON lamp (11, 18)
- 3 MENU button (16, 52 – 64)
- 4 Remote sensor
- 5 REC MODE button (36 – 38)
- 6 LONG MODE (SP/LP2/LP4) button (33 – 38)
- 7 REC PAUSE button and lamp (34)
- 8 HIGH-SPEED CD \blacktriangleright MD button (35)
- 9 LINE button (11, 38)
 - Pressing this button also turns on the unit.
- 10 FM/AM button (11, 18)
 - Pressing this button also turns on the unit.
- 11 MD loading slot (27)
- 12 MD \triangleright / II (play/pause) button (11, 27)
 - Pressing this button also turns on the unit.
- 13 \blacktriangle CD1, \blacktriangle CD2, \blacktriangle CD3 (open/close) buttons (21)
 - Pressing one of these buttons also turns on the unit.
- 14 DISC button (21)
- 15 VOLUME control (12)
- 16 \blacksquare (stop) button (11, 15, 21, 27, 35)
- 17 CANCEL button (23, 29, 41, 47, 52)
- 18 Joy control
 - \blacktriangleleft ∇ / \blacktriangleright \wedge / \blacktriangleleft \langle / \blacktriangleright \rangle , and SET
 - Pressing SET also turns on the unit.
- 19 MD \blacktriangle (eject) button (27)
 - Pressing this button also turns on the unit.
- 20 ENTER/DEMO button (9, 13, 15, 47, 48, 50)
- 21 TITLE/EDIT button (41 – 44, 46 – 48)
- 22 LINE 2 jack – stereo mini type (8)
- 23 PHONES jack – stereo mini type (12)
- 24 CD \triangleright / II (play/pause) button (11, 21)
 - Pressing this button also turns on the unit.

Display window

- 25 Timer mode indicators (52 – 57)
 - \odot , DAILY (Daily Timer) and REC (Recording Timer)
- 26 CD indicators (21)
 - CD source and CD numbers 1 to 3
- 27 Main display
 - Shows the source name, track number, and other information.
- 28 MD indicators (27)
 - MD source and MD insertion
- 29 Recording length mode indicators (33)
 - SP, LP2, and LP4
- 30 SOUND indicator (15)
- 31 A. BASS (Active Bass Extension) indicator (12)
- 32 OVER indicator (63)
- 33 Play mode indicators (22 – 25, 28 – 30)
 - PRGM (Program), RANDOM, and REPEAT (1/CD/ALL)
- 34 Tuner mode indicators (18)
 - TUNED and STEREO
- 35 A. P. off (Auto Power Off) indicator (64)

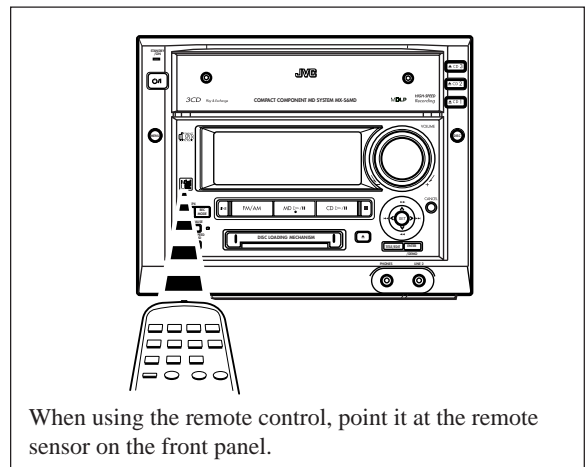

About the indications in the main display

When using some functions with the remote control, the indications in the main display appear differently at first from those when using the same functions with the buttons on the unit.

Ex. When starting CD play using the remote control

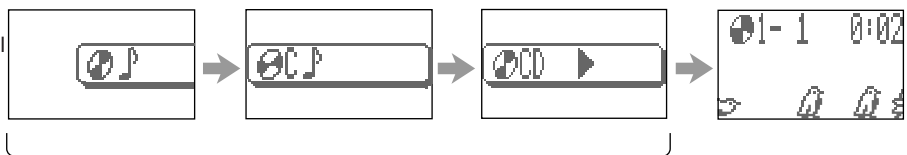

This indication does not appear when using the buttons on the unit except the following:

- When selecting the playback source
- When calling up the menu, MD editing mode, or title entry mode

Remote Control

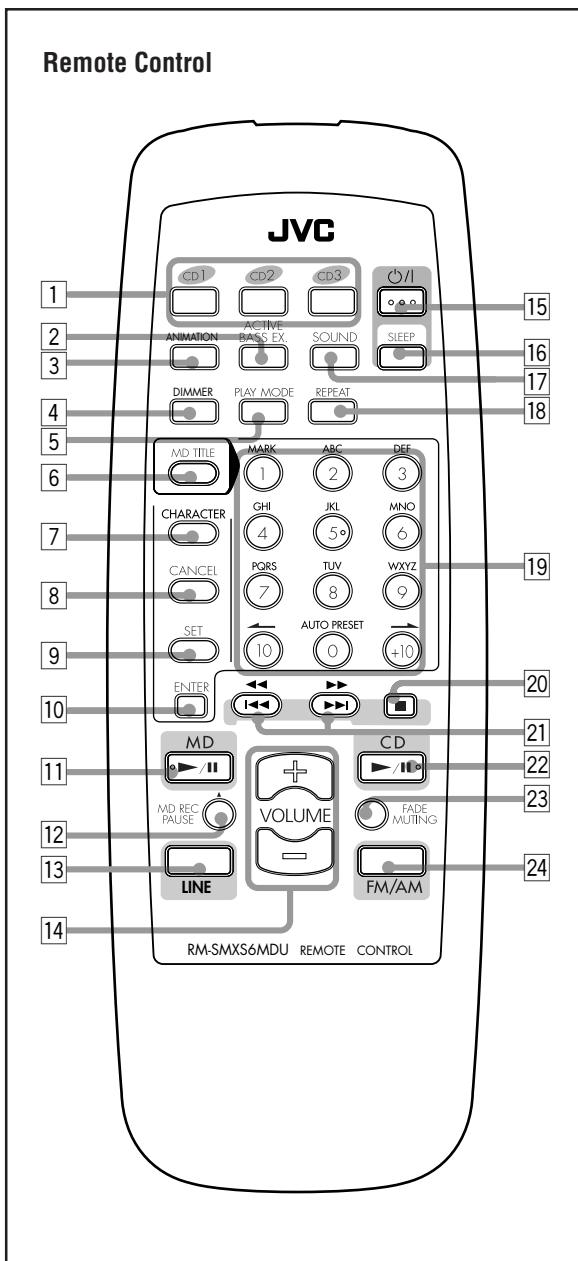

Remote Control

- 1 Disc number buttons (21)
 - CD1, CD2, and CD3
 - Pressing one of these buttons also turns on the unit.*
- 2 ACTIVE BASS EX. (extension) button (12)
- 3 ANIMATION button (14)
- 4 DIMMER button (12)
- 5 PLAY MODE button (22, 24, 28, 29)
- 6 MD TITLE button (48 – 50)
- 7 CHARACTER button (49)
- 8 CANCEL button (23, 29, 49)
- 9 SET button (49)
- 10 ENTER button (49)
- 11 MD ► / || (play/pause) button (11, 27)
 - *Pressing this button also turns on the unit.*
- 12 MD REC PAUSE button (34)
- 13 LINE button (11, 34)
 - *Pressing this button also turns on the unit.*
- 14 VOLUME + / – button (12)
- 15 ⏻ / ⏻ (Standby/On) button (11)
- 16 SLEEP button (57)
- 17 SOUND button (15)
- 18 REPEAT button (25, 30)
- 19 Number buttons
 - 1 – 10, +10 buttons (19, 22, 28)
 - Character entry buttons (A – Z, 0 – 9) (49)
 - ← / → buttons (48, 49)
 - AUTO PRESET button (18)
- 20 ■ (stop) button (11, 21, 27, 35)
- 21 ◀◀ / ▶▶ (reverse search/forward search) button (22, 23, 27 – 29)
 - ◀◀ / ▶▶ (fast-reverse/fast-forward) button (18, 22, 27)
- 22 CD ► / || (play/pause) button (11, 21, 22)
 - *Pressing this button also turns on the unit.*
- 23 FADE MUTING button (12)
- 24 FM/AM button (11, 18)
 - *Pressing this button also turns on the unit.*

Unpacking

After unpacking, check to be sure that you have all the following items.

The number in the parenthesis indicates the quantity of the pieces supplied.

- AM loop antenna (1)
- FM antenna (1)
- Remote control (1)
- Batteries (2)
- AC plug adaptor (1)

If any is missing, consult your dealer immediately.

Adjusting the Voltage Selector

Before plugging in the unit, set the correct voltage for your area with the voltage selector on the rear of the unit.

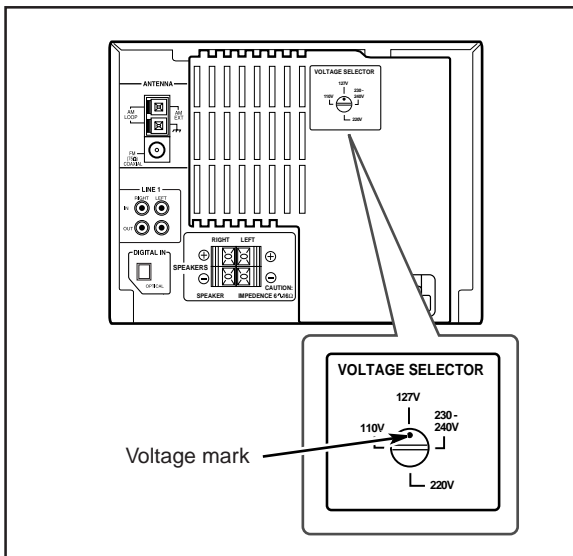

Use a screwdriver to rotate the voltage selector so the voltage number the voltage mark is pointing at is the same as the voltage where you are plugging in the unit.



- DO NOT plug in before setting the voltage selector on the rear of the unit and all connection procedures are complete.

Connecting Antennas

FM antenna

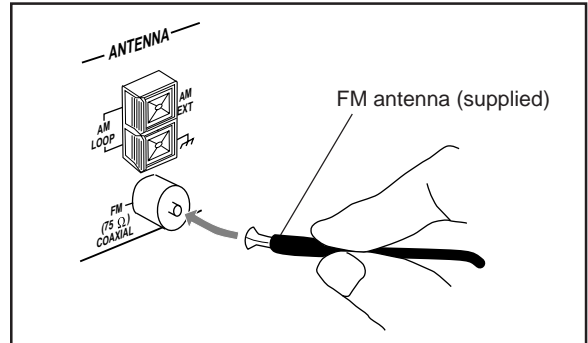

- 1 Attach the FM antenna to the FM (75 Ω) COAXIAL terminal.
- 2 Extend the FM antenna.
- 3 Fasten it up in the position which gives you the best reception.



About the supplied FM antenna

The FM antenna supplied with this unit can be used as temporary measure. If reception is poor, you can connect an outdoor FM antenna.

To connect an outdoor FM antenna

Before connecting it, disconnect the supplied FM antenna.

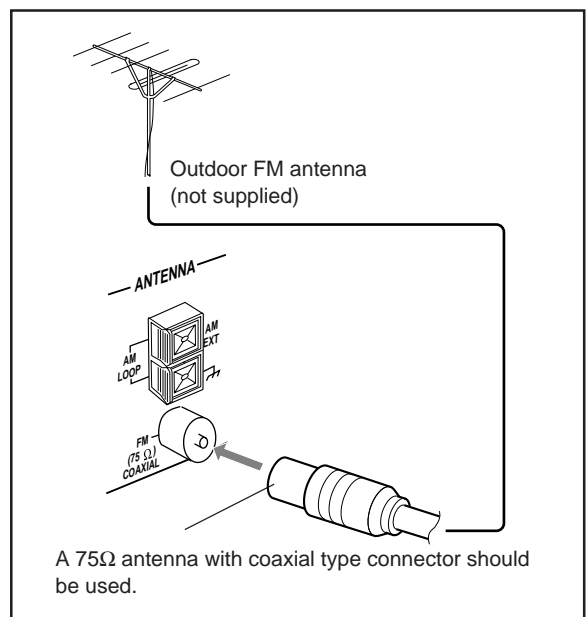

AM antenna

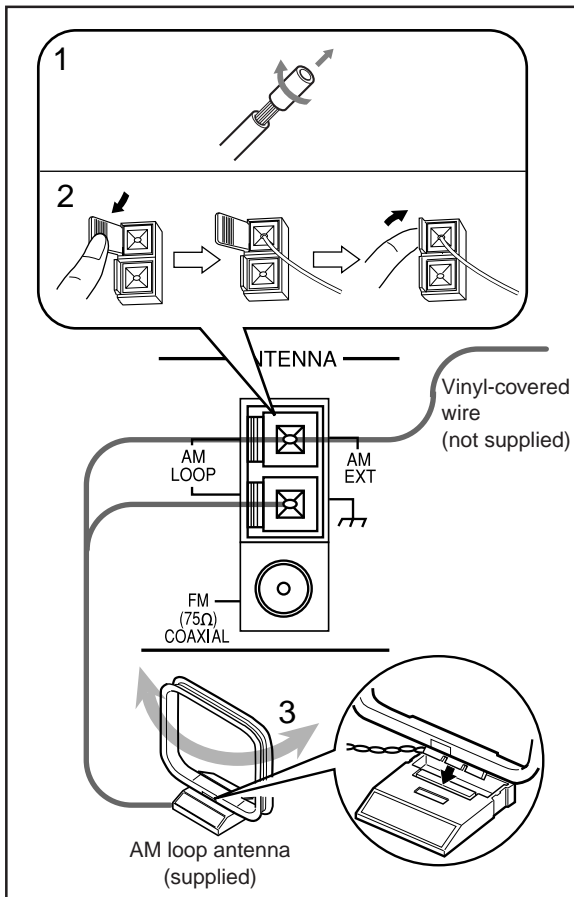

- 1 If cords are covered with insulation, twist the core of the cord at the end of each cord, then remove the insulation.
- 2 Connect the AM loop antenna to the AM LOOP terminals as illustrated.
- 3 Turn the AM loop antenna until you have the best reception.

To connect an outdoor AM antenna

When reception is poor, connect a single vinyl-covered wire to the AM EXT terminal and extend it horizontally. (The AM loop antenna must remain connected.)



For better reception of both FM and AM

- Make sure the antenna conductors do not touch any other terminals and connecting cords.
- Keep the antennas away from metallic parts of the unit, connecting cords, and the AC power cord.

Connecting Speakers

You can connect the speakers using the speaker cords.

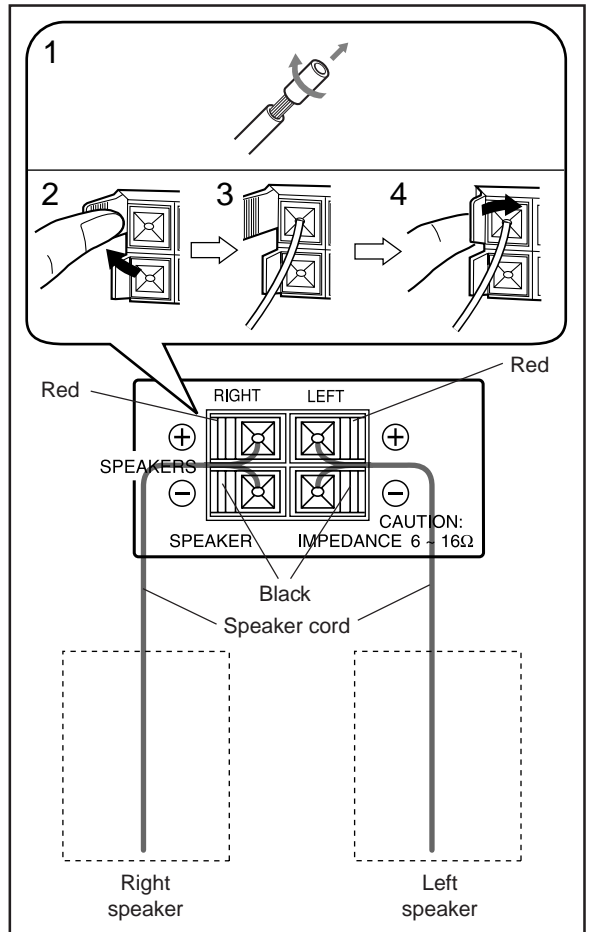

- 1 If cords are covered with insulation, twist the core of the cord at the end of each cord, then remove the insulation.
- 2 Open the speaker terminal.
- 3 Insert the end of the speaker cord to the terminal. Match the polarity of the speaker terminals: Red (+) to red (+) and black (-) to black (-).
- 4 Close the speaker terminal on the rear of the unit.

Use only speakers with the same speaker impedance as indicated by the speaker terminals on the rear of the unit.

Connecting Other Equipment

You can connect the following equipment to this unit:

- Cassette deck — used as a playback and recording device. By using the cassette deck, you can record any source played back on this unit.
- Portable MD player — used as a playback device.
- Audio equipment with an optical digital output terminal — used only as a digital playback device.

When you connect and use these equipment, refer also to the manuals supplied with them.



- DO NOT connect other equipment while the power is on.
- DO NOT plug in any equipment until all connections are complete.

To connect another component such as a cassette deck

Be sure that the plugs of the audio cords and the jacks on the rear of the unit are color-coded: White plugs and jacks are for left audio signals, and red ones for right audio signals.

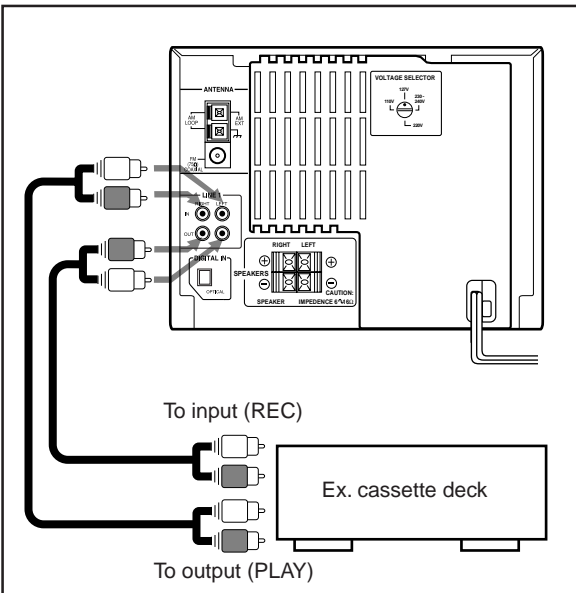

By using audio cords (not supplied), connect:

- Between the audio input jacks on the cassette deck and the LINE 1 OUT jacks — For recording on the cassette deck.
- Between the audio output jacks on the cassette deck and the LINE 1 IN jacks — For playing a tape.

To connect a portable MD player with a mini output jack

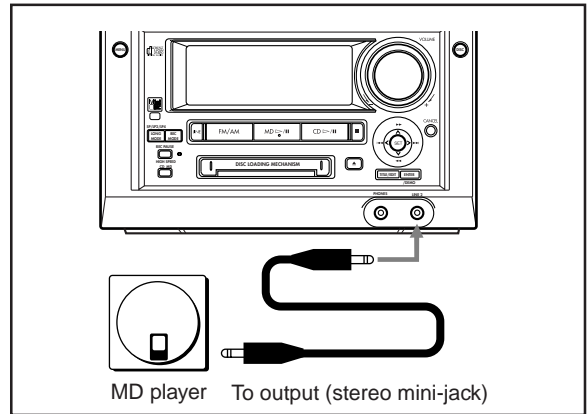

By using a cable with the stereo mini-jack, connect between the stereo mini-jack on the other equipment and the LINE 2 jack on the front panel.

To connect audio equipment with an optical digital output terminal

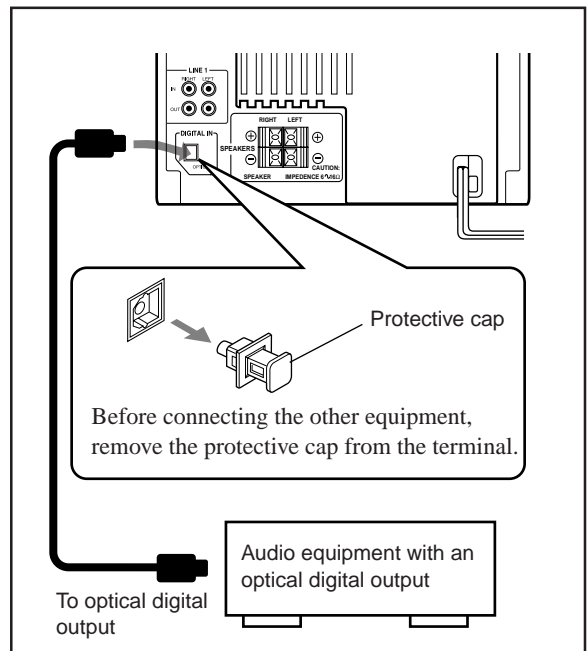

Connect between the optical digital output terminal on the other equipment and the DIGITAL IN terminal.

NOW, you can plug in the unit and other connected equipment FINALLY!

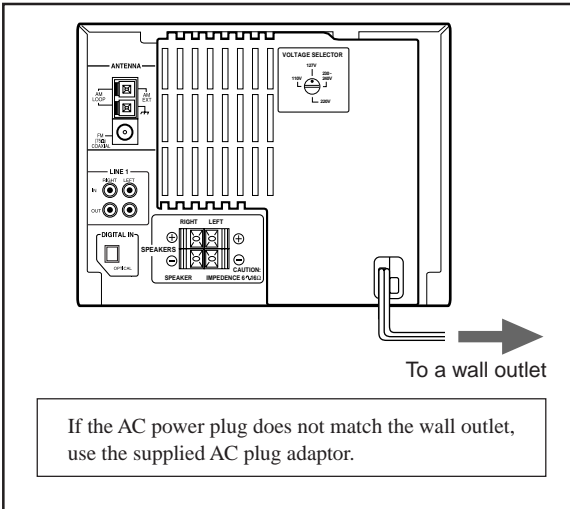

When connecting the AC power cord into a wall outlet, the unit automatically starts display demonstration.

To stop and cancel the display demonstration, press ENTER/DEMO during display demonstration. “DEMO OFF!” appears in the main display, the unit is turned off, then the display dims.

After canceling the display demonstration, it will start only when the AC power cord is reconnected or when a power failure is recovered.

- Pressing some of the buttons on the unit or the remote control will stop the demonstration temporarily.



If you do not cancel the display demonstration, it will start automatically in the following cases

- 2 minutes after the unit is turned off.
- When no operation is done for more than 2 minutes after the unit is turned on.



If you do not want to start the display demonstration when the AC power cord is reconnected or when a power failure is recovered

See “To store the display setting in memory” on page 15.

To start the display demonstration manually

Press ENTER/DEMO.

- Each time you press the button, the display demonstration turns on and off.



During MD editing and title entry mode

The ENTER/DEMO button cannot function for the display demonstration.

Putting the Batteries into the Remote Control

Insert the batteries — R6(UM-3)/AA(15F) — into the remote control, by matching the polarity (+ and –) on the batteries with the + and – markings on the battery compartment.

When the remote control can no longer operate the unit, replace both batteries at the same time.

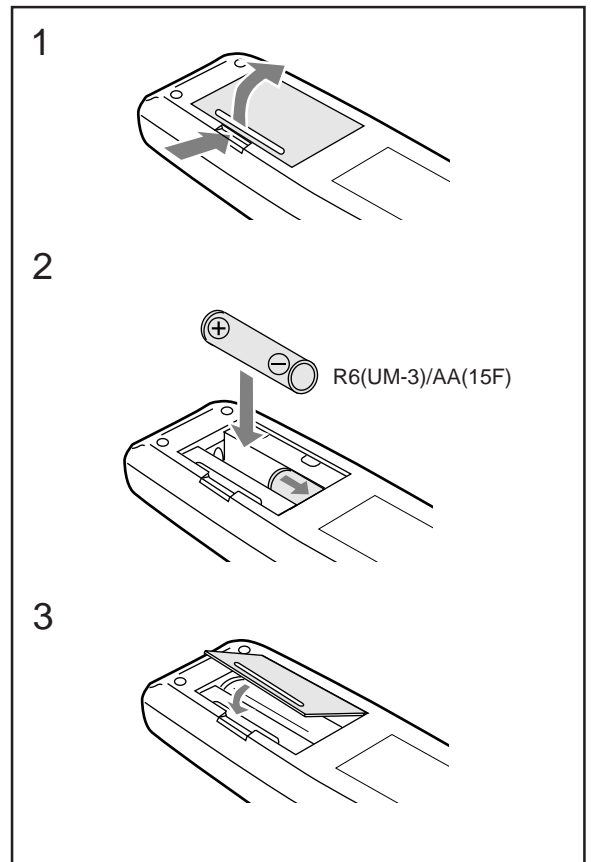

- DO NOT use an old battery together with a new one.
- DO NOT use different types of batteries together.
- DO NOT expose batteries to heat or flame.
- DO NOT leave the batteries in the battery compartment when you are not going to use the remote control for an extended period of time. Otherwise, it will be damaged from battery leakage.

Basic and Common Operations

The buttons and controls enlarged in the illustration below are used and explained in this section (pages 10 to 16).

Remote control

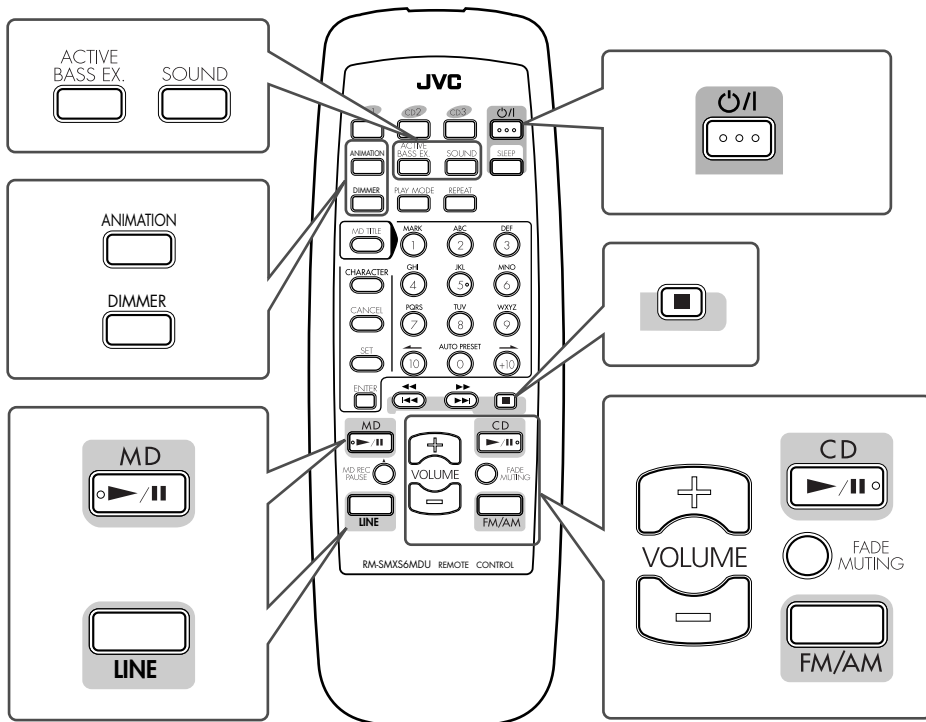

Main unit

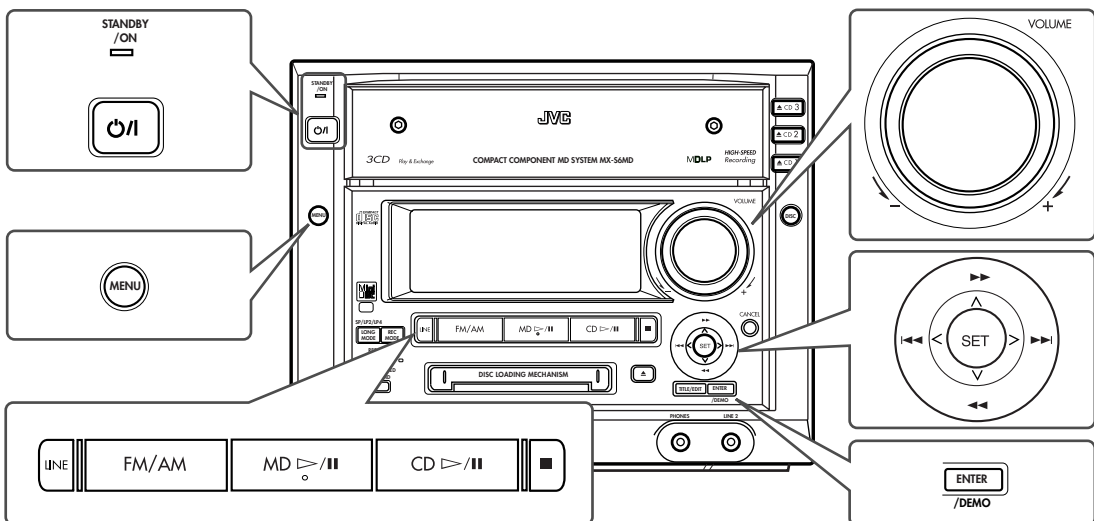

Turning On the Power

When you press the play button (▶ / II) for a particular source or the source selecting buttons such as FM/AM and LINE, the unit automatically turns on (and starts playback if the source is ready).

- Pressing SET on the unit also turns on the unit.

To turn on the unit without playing, press ⏻/I so that the STANDBY/ON lamp on the unit lights green.



This indication changes according to the selected animation character. When "METER 2" is selected, no indication appears. (See page 14.)

To turn off the unit (on standby), press ⏻/I again so that the STANDBY/ON lamp lights red.

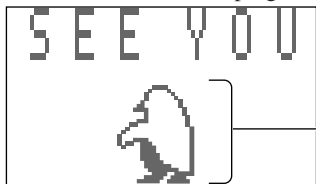

This indication changes according to the selected animation character. When "METER 2" is selected, no indication appears. (See page 14.)

Ex. When "Penguin" is selected as the animation character

- The ⏻ indicator will flash on the display until you set the clock (when the power is off, "0:00" will also flash). After setting the clock, the clock time will appear on the display while the power is off.



To set the clock, use the menu, referring to "Setting the Clock" on page 52.

- A little power is always consumed even while the unit is in standby mode.

To switch off the power supply completely, unplug the AC power cord from the AC outlet.



You can change the opening or ending screen illustrated above

Instead of showing the above opening or ending screen, you can make your original screens. To make and store your original screens, see "Creating Your Own Opening and Ending Screens" on page 50.



When you unplug the AC power cord or if a power failure occurs

The clock will be reset to "0:00," while the tuner preset stations and other settings will be erased in a few days.

Selecting the Sources and Starting Play

To select the tuner as the source, press FM/AM.

The unit automatically turns on and the last received station is tuned in.

- For more detailed operations, see pages 18 to 19.

To select the CD player as the source, press CD ▶ / II.

The unit automatically turns on. (Play starts if a CD is on one of the CD trays.)

To stop play, press ■.

- For more detailed operations, see pages 21 to 25.

To select the MD player as the source, press MD ▶ / II.

The unit automatically turns on. (Play starts if an MD is in the MD loading slot.)

To stop play, press ■.

- For more detailed operations, see pages 27 to 30.

To select the external equipment as the source, press LINE.

The unit automatically turns on.

- Each time you press the button, the source changes as follows:



LINE1*: To use the equipment connected to the LINE 1 jacks on the rear.

LINE2*: To use the equipment connected to the LINE 2 jack on the front panel.

DIGITAL IN*: To use the digital equipment connected to the DIGITAL IN terminal on the rear.

* If you have changed the source name, the changed name will appear. (See page 64.)



When selecting the equipment connected to the LINE 1 jacks or the LINE 2 jack, the sound input level appears for a while. You can adjust the input level by using the menu. (See page 63 for the sound input level.)

- For operating the external equipment, see the manuals supplied with them.



While selecting the digital equipment ("DIGITAL IN") as the source

The sampling frequency of the connected digital equipment is shown in the main display. (If no equipment is connected to the DIGITAL IN terminal, "UNLOCK" appears.)

Adjusting the Volume

You can adjust the volume level only while the unit is turned on.

When using the remote control, press **VOLUME +** to increase the volume or press **VOLUME -** to decrease it.

When using the unit, turn **VOLUME** clockwise to increase the volume or counterclockwise to decrease it.



For private listening

Connect a pair of headphones to the PHONES jack. No sound comes out of the speakers. Be sure to turn down the volume before connecting or putting on the headphones.



If “CANNOT LISTEN!” appears in the main display

During high-speed recording (see page 34), you cannot listen to any source, and therefore, cannot adjust the volume level.



DO NOT turn off (on standby) the unit with the volume set to an extremely high level; otherwise, the sudden blast of sound can damage your hearing, speakers and/or headphones when you turn on the unit or start playing any source.
REMEMBER you cannot adjust the volume level while the unit is in standby mode.

To turn down the volume level temporarily

Press **FADE MUTING** on the remote control.



To restore the sound, press the button again.

Reinforcing the Bass Sound

The richness and fullness of the bass sound is maintained regardless of how low you set the volume — Active Bass Extension.

- You can use this effect only for playback.

To get the effect, press **ACTIVE BASS EX.** (extension) on the remote control so that “ACTIVE BASS EX. ON” appears in the main display (the A. BASS indicator also lights).

To cancel the effect, press the button again so that “ACTIVE BASS EX. OFF” appears in the main display (the A. BASS indicator goes off).



When using the unit, you can activate or deactivate the Active Bass Extension by using the menu. (See page 60).

Selecting the Display Brightness

You can change the display brightness whether the unit is turned on or in standby mode.

You can set and memorize the display brightness setting each for power-on time and for power-off (standby) time.

To change the display brightness, press **DIMMER** on the remote control.

- Each time you press the button, the display brightness changes as follows:

When the unit is turned off (on standby):

Dark ↔ Dimmer

When the unit is turned on:

Bright ↔ Dimmer*

- * When using some functions, the display window brightens for a while. For example, when selecting the source either using the buttons on the unit or on the remote control, or when selecting the CD or MD track using the buttons on the remote control, etc.



During display demonstration

The display always brightens regardless of the dimmer setting.

Changing the Main Display Screen

You can change the screen pattern which appears in the main display while the unit is not playing or no operation is done for a certain period of time.

On the unit ONLY:

You can do the following procedure while the unit is turned on.

- If the unit is turned off, you can only select "DEMO" in step 2.

1

Press ENTER/DEMO.

The SCREEN MODE screen appears.



- If "DEMO OFF!" appears, press ENTER/DEMO again.

2

Push the joy control upward (^) or downward (v) to select the screen pattern you want in the main display.

- DEMO:** Starts the display demonstration → go to step 4.
- PENGUIN:** Penguins try to catch fishes.
- DOLPHIN:** Dolphins and whales swim.
- MONKEY:** A monkey eats bananas.
- SURFING:** A surfer enjoys surfing.
- FIREWORKS:** Sets up multicolored fireworks.
- STAR DUST:** Colorful star dust shines in the sky.
- STOVE:** Fire frame in the stove and rocking chair create a relaxing atmosphere.
- OFF:** To cancel the display demonstration and the animation screen → go to step 4.

3

When selecting any setting other than "DEMO" and "OFF" in the above step:

Push the joy control repeatedly rightward (>) or leftward (<) to select the starting-time (no operation period).

- You can select the starting-time – from among 1, 3, and 5 minutes.

4

Press SET to finish the setting.

How these settings work

- **When selecting "DEMO":**
Display demonstration starts.



If you do not cancel the display demonstration by pressing ENTER/DEMO, display demonstration automatically starts in the following cases:

- 2 minutes after the unit is turned off.
- When no operation is done for more than 2 minutes.

- **When selecting any setting other than "DEMO" and "OFF":**

Selected image appears in the lower portion of the main display.

If you press any button while the selected image is shown in the main display, it goes off from the main display. However, it will be shown again if no operation is done for your specified starting-time (1, 3 and 5 minutes).

- **When selecting "OFF":**

"SCREEN OFF!" appears in the main display.

Neither display demonstration nor selected image appears, but one of the selected animation characters or of the level meters (see page 14) appears in the lower portion of the main display.



While recording or editing an MD

Display demonstration and animation screen will not appear.



When the AC power is unplugged

"DEMO" is automatically restored unless you have stored another image setting in backup memory. See "To store the display setting in memory" on page 15.

Selecting the Animation Characters

You can select the animation characters or level meters shown in the main display while the unit is playing a source or operated.



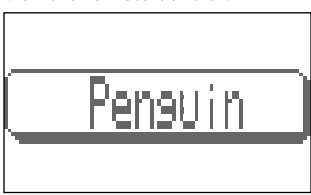







To select the animation character or level meter, press ANIMATION on the remote control.



Ex. When "Penguin" is selected

- Each time you press the button, the animation characters (including the level meters) are shown in the main display change as follows:

AUTO → Penguin → Dolphin → Rabbit → UFO → Snail → Monkey → Tortoise → Elephant → METER 1 → METER 2 → (back to the beginning)

AUTO Changes the characters and colors periodically.	Monkey 
Penguin 	Tortoise 
Dolphin 	Elephant 
Rabbit 	METER 1 
UFO 	METER 2 
Snail 	



Color relationship between the animation characters (including the level meters) and the main display

- The color of the main display is preset for each animation character. When an animation character is selected, the color of the main display and illumination color of the ring around the VOLUME control are changed to the color preset for the animation character selected.
- You can change the color of the animation character to any color other than preset. To change the color of the animation character, first select an animation character, then change the color of the main display (see "Selecting the display color" on page 62). The selected color is also stored in memory as the color for the animation character.
- If you select an animation character after selecting the color of the main display, the color of the main display will also change to the selected animation character's color.
- The animation character and main display colors can be backed up (memorized). For details, refer to "To store the display setting in memory" (see page 15).



When using the unit, you can select the animation characters and the level meters by using the menu. (See "Selecting the display color" on page 62).

* The animations actually shown on the main display may be different from the ones illustrated above, because animations shown on the main display change and move according to the operating condition of this unit.

To store the display setting in memory

You can store the following display settings in memory. So, even though the AC power is unplugged or a power failure occurs, the settings are kept in memory.

- Display demonstration off setting (see page 9)
- Animation character or level meter (see pages 14 and 62)
- Display color (see page 62)

On the unit **ONLY**:

- 1** Unplug the AC power cord.
- 2** Plug the AC power cord again while holding ■ and ENTER/DEMO at the same time.



- 3** Set the above settings as you like.
 - **Turn off the display demonstration.** (See page 9.)
If you turn it off and store its setting in backup memory, display demonstration will not start even after the AC power cord is reconnected or when a power failure is recovered.
 - **Select the animation character or the level meter.** (See page 14 or 62.)
 - **Select the display color.** (See page 62.)

To erase the memory

Repeat steps **1** and **2** of the above procedure.



Memory is cleared.

- When the AC power plug is reconnected or a power failure is recovered, display demonstration automatically starts.

Selecting the Sound Modes

You can select one of the 6 preset sound modes (3 surround modes and 3 SEA – Sound Effect Amplifier – modes) and 1 manual mode. The sound modes can be applied only to playback sounds, and cannot be used for recording.

To select the sound modes, press SOUND on the remote control until the sound mode you want appears on the display. The SOUND indicator also lights on the display.

- Each time you press the button, the sound modes change as follows:

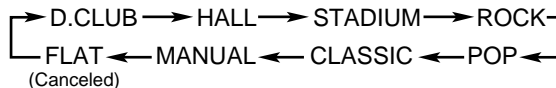

Surround modes *:

D. (Dance) CLUB: Increases resonance and bass.

HALL: Adds depth and brilliance to the sound.

STADIUM: Adds clarity and spreads the sound, like in an outdoor stadium.

SEA modes:

ROCK: Boosts low and high frequency. Good for acoustic music.

POP: Good for vocal music.

CLASSIC: Good for classical music.

Manual mode:

MANUAL: Your individual mode stored in memory. See “Creating Your Own Sound Mode — MANUAL Mode” on page 16.

FLAT: Cancels the sound mode.

* Surround elements are added to the sound modes to create a being-there feeling in your room.

To check the sound mode currently selected, press SOUND once while the SOUND indicator is lit. The currently selected sound mode screen will appear in the main display.

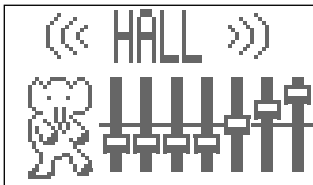

Ex. When "HALL" is currently selected (with "Elephant" selected as the animation character)



When using the unit, you can select the sound modes by using the menu (see page 60).

Creating Your Own Sound Mode — MANUAL Mode



You can create and store your own sound mode.

- You have to use the menu for the following operations. For general information on the menu, see pages 59 and 60.
- There is a time limit in doing the following steps. If the setting is canceled before you finish, start from step 1 again.

On the unit ONLY:

1 Press MENU.



Ex. When the source is CD, and playing

2 Push the joy control downward (∨) to select "SOUND" (highlighted).



Current sound mode

3 Push the joy control rightward (>) or leftward (<) to select "SET UP."

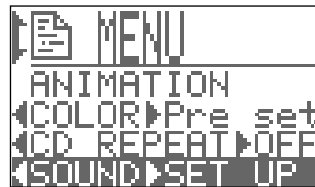

- Each time you push the joy control, the sound modes change as follows:

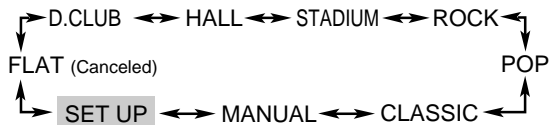

4 Press SET.

The equalizer pattern adjustment screen appears.

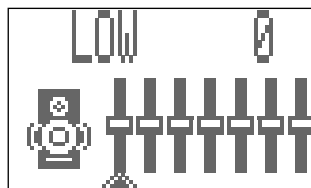

5 Adjust the equalizer pattern.

- Push the joy control rightward (>) or leftward (<) to select the frequency range to adjust (LOW, MID, HIGH).
- Push the joy control upward (^) or downward (∨) to adjust the level (-3 to +3) of the selected frequency range.



- Repeat steps 1) and 2) to adjust the level of the other frequency ranges.

6 Press SET again (or wait until the above indication disappears).

The equalizer pattern you have created is stored in memory (MANUAL).

To use your own sound mode

Select "MANUAL" when using the sound modes. See "Selecting the Sound Modes" on page 15.

Listening to FM and AM Broadcasts

The buttons and controls enlarged in the illustration below are used and explained in this section (pages 17 to 19).

Remote control

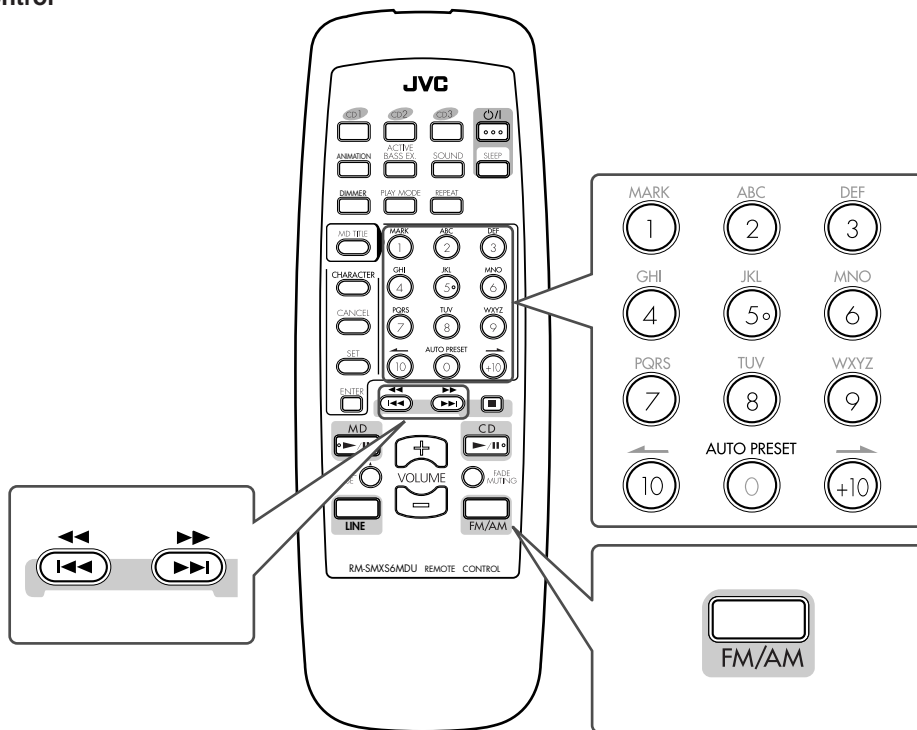

Main unit

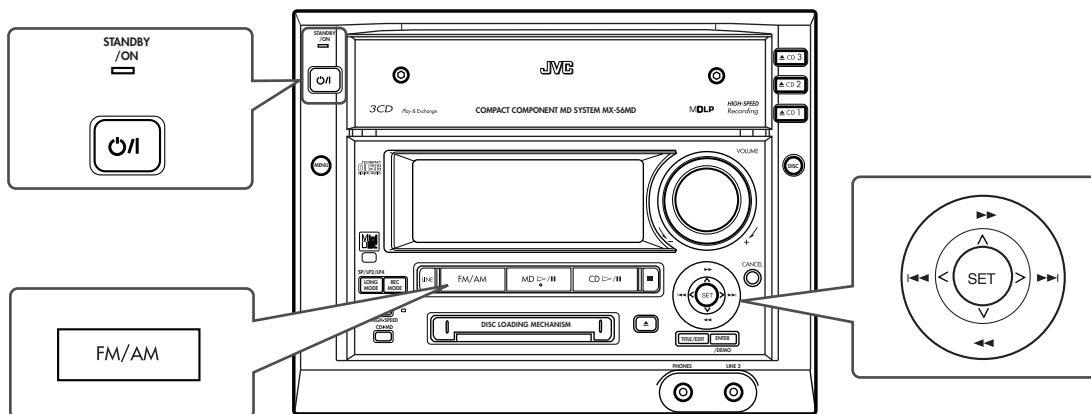

Setting the AM Tuner Interval Spacing

Some countries space AM stations 9 kHz apart, and some countries use 10 kHz spacing.

When shipped, the built-in AM tuner is set to 9 kHz spacing.

On the unit ONLY:

To set the AM tuner to the 10 kHz spacing, be sure that the unit is turned off, but is plugged into a wall outlet. While holding the joy control upward (^), press $\odot/!$.

To set it back to the 9 kHz spacing, be sure that the unit is turned off, but is plugged into a wall outlet.

While holding the joy control downward (v), press $\odot/!$.



When you change the setting

Preset stations will be erased. (You need to preset stations again.)

Tuning in a Station

1 Press FM/AM.

The unit automatically turns on and tunes in the previously tuned station (either FM or AM).

- Each time you press the button, the band alternates between FM and AM.



2 Tune into a station.

On the remote control:

Press and hold $\blacktriangleright\blacktriangleright$ ($\blacktriangleright\blacktriangleright$) or $\blacktriangleleft\blacktriangleleft$ ($\blacktriangleleft\blacktriangleleft$) until the station frequencies start changing in the main display.

- $\blacktriangleright\blacktriangleright$ ($\blacktriangleright\blacktriangleright$): to increase the frequencies.
- $\blacktriangleleft\blacktriangleleft$ ($\blacktriangleleft\blacktriangleleft$): to decrease the frequencies.

On the unit:

Push and hold the joy control upward (^) or downward (v) until the station frequencies start changing in the main display.

- Upward (^): to increase the frequencies.
- Downward (v): to decrease the frequencies.

The unit starts searching stations and stops when a station of sufficient signal strength is tuned in (the TUNED indicator lights).

- If an FM program is broadcast in stereo, the STEREO indicator also lights.

To stop during searching, press $\blacktriangleright\blacktriangleright$ ($\blacktriangleright\blacktriangleright$) or $\blacktriangleleft\blacktriangleleft$ ($\blacktriangleleft\blacktriangleleft$) (or push the joy control again on the unit).



When you repeatedly press $\blacktriangleright\blacktriangleright$ ($\blacktriangleright\blacktriangleright$) or $\blacktriangleleft\blacktriangleleft$ ($\blacktriangleleft\blacktriangleleft$) (or push the joy control upward or downward on the unit)

The frequency changes step by step.



When an FM stereo broadcast is hard to receive or noisy

You can use the menu to improve FM reception. See “FM Reception Mode Setting” on page 61.

Presetting Stations

You can preset 30 FM and 15 AM stations — using either automatic presetting method or manual presetting method.

In some cases, test frequencies have been already memorized for the tuner since the factory examined the tuner preset function before shipment. This is not a malfunction. You can preset the stations you want into memory by following the presetting method.

- There is a time limit in doing the following steps. If the setting is canceled before you finish, start from step 1 again.

To preset stations automatically — Automatic Presetting

On the remote control ONLY:

You need to preset stations separately for the FM and AM bands.

1

Press FM/AM to select the band.

2

Press and hold AUTO PRESET until “A. PRESET” appears in the main display for about 2 seconds.



Local stations with strong signals are searched and stored in memory automatically.

When automatic preset is over, the station stored in preset number 1 is received.



- 3** Repeat steps 1 and 2 to store stations of the other band.



When you cannot store stations you want automatically

Stations with weak signals cannot be detected with this automatic presetting method. To store such a station, use the manual presetting method that follows.

To preset stations manually — Manual Presetting

- 1** Tune in the station you want to preset.
- See “Tuning in a Station” on page 18.

- 2** Press SET.
The preset number starts flashing.



- 3** Select a preset number.

On the remote control:

Press the number buttons.

Ex. For preset number 5, press 5.
For preset number 15, press +10, then 5.
For preset number 20, press +10, then 10.

On the unit:

Push the joy control rightward (>) or leftward (<).

- Rightward (>): to increase the preset numbers.
- Leftward (<): to decrease the preset numbers.

- 4** Press SET again.

The tuned station in step 1 is stored in the preset number selected in step 3.



- Storing a new station on a used number erases the previously stored one.



When you unplug the AC power cord or if a power failure occurs

The preset stations will be erased in a few days. If this happens, preset the stations again.

Tuning in a Preset Station

- 1** Press FM/AM.

The unit automatically turns on and tunes in the previously tuned station (either FM or AM).

- Each time you press the button, the band alternates between FM and AM.

- 2** Select a preset number.

On the remote control:

Press the number buttons.

Ex. For preset number 5, press 5.
For preset number 15, press +10, then 5.
For preset number 20, press +10, then 10.

On the unit:

Push the joy control rightward (>) or leftward (<).

- Rightward (>): to increase the preset numbers.
- Leftward (<): to decrease the preset numbers.

Playing Back CDs

The buttons and controls enlarged in the illustration below are used and explained in this section (pages 20 to 25).

Remote control

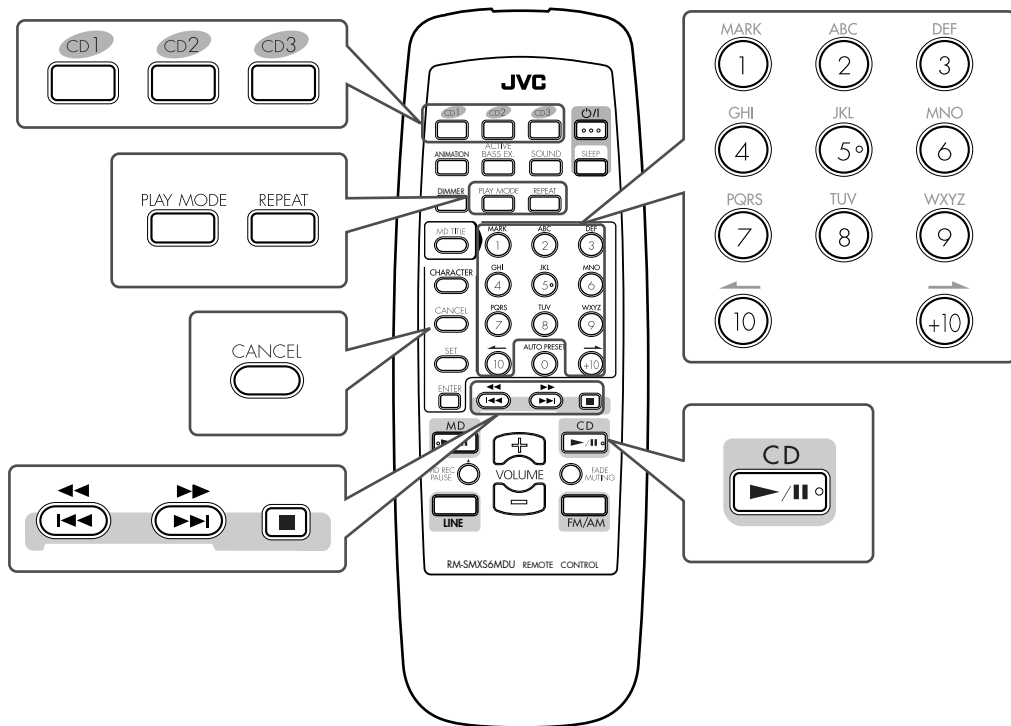

Main unit

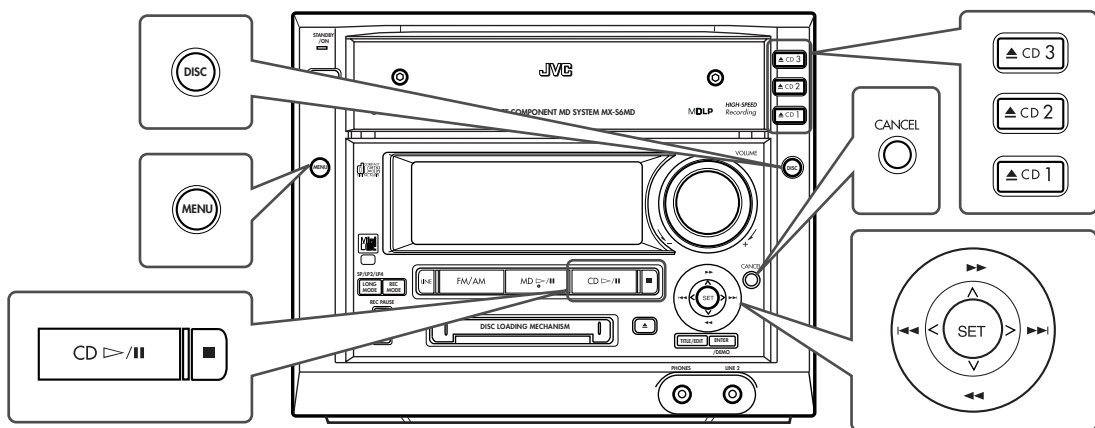

Loading CDs

On the unit ONLY:

1 Press one of the open/close buttons (▲ CD1, ▲ CD2, or ▲ CD3) for the disc tray you want to load a CD onto.

The unit automatically turns on and the selected disc tray comes out.

2 Place a CD correctly on the circle of the disc tray, with its label side up.

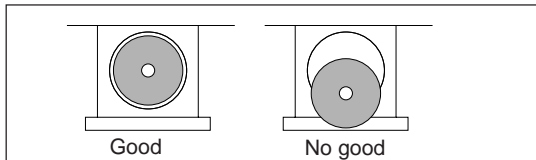
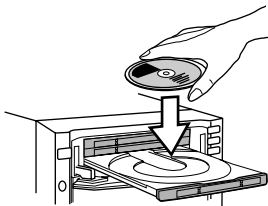

- When using a CD single (8 cm), place it on the inner circle of the disc tray.

3 Press the same open/close button (▲ CD1, ▲ CD2, or ▲ CD3) you have pressed in step 1.

The disc tray closes.

4 Repeat steps 1 to 3 to place other CDs.



When loading more than one CD continuously

Press the open/close button (▲ CD1, ▲ CD2, or ▲ CD3) for the next tray you want to place a CD onto. The first disc tray automatically closes and the next disc tray comes out.



About the CD indicators

Each disc number indicator (1, 2, 3) corresponds to the disc tray of the same number.

Lights when a disc on the corresponding disc tray is currently selected.

3

Goes off when the unit has recognized that there is no CD on the corresponding disc tray.

2

Flashes during play or pause.

1

CD

Lights when the CD player is selected as the source.

Playing Back the Entire Discs — Continuous Play

You can play CDs continuously.

1 Load CDs.

2 Select a disc number you want to start play with.

On the remote control:

Press one of the disc number buttons (CD1, CD2 and CD3).

On the unit:

Press DISC repeatedly to select the disc number you want, then press CD ▷ / II.

CD playback starts from the first track of the selected disc.

This shows the currently selected disc.



Track No. Elapsed playing time

- Pressing CD ▷ / II without selecting a disc number starts playing back the currently selected CD.

To stop during play, press ■.

To remove the disc, press the corresponding open/close buttons (▲ CD1, ▲ CD2, or ▲ CD3).



CD playback sequence

When 3 CDs are loaded on the disc trays, they are played in one of the following sequences.

- When CD 1 is the starting disc : CD 1 ⇒ CD 2 ⇒ CD 3 (then stops)
- When CD 2 is the starting disc : CD 2 ⇒ CD 3 ⇒ CD 1 (then stops)
- When CD 3 is the starting disc : CD 3 ⇒ CD 1 ⇒ CD 2 (then stops)
- * If no CD is on the disc trays, CD player skips such an empty tray.

Basic CD Operations

While playing a CD, you can do the following operations.

To exchange CDs during playback of another

Press the open/close button (\blacktriangle CD1, \blacktriangle CD2, or \blacktriangle CD3) corresponding to a disc number not currently being played to eject that disc tray and exchange the CD.

If CDs are exchanged during playback, playback will stop after playing all newly inserted CDs.

To stop playback for a moment

Press CD \blacktriangleright / \parallel .

To resume play, press CD \blacktriangleright / \parallel again.

To locate a particular point in a track during play

On the remote control:

Press and hold $\blacktriangleright\blacktriangleright$ ($\blacktriangleright\blacktriangleright$) or $\blacktriangleleft\blacktriangleleft$ ($\blacktriangleleft\blacktriangleleft$).

- $\blacktriangleright\blacktriangleright$ ($\blacktriangleright\blacktriangleright$): Fast-forwards the tracks.
- $\blacktriangleleft\blacktriangleleft$ ($\blacktriangleleft\blacktriangleleft$): Fast-reverses the tracks.

On the unit:

Push the joy control upward ($\blacktriangleright\blacktriangleright \wedge$) or downward ($\blacktriangleleft\blacktriangleleft \vee$).

- Upward ($\blacktriangleright\blacktriangleright \wedge$): Fast-forwards the tracks.
- Downward ($\blacktriangleleft\blacktriangleleft \vee$): Fast-reverses the tracks.

To go to another track

On the remote control:

Press $\blacktriangleright\blacktriangleright\blacktriangleright$ ($\blacktriangleright\blacktriangleright\blacktriangleright$) or $\blacktriangleleft\blacktriangleleft\blacktriangleleft$ ($\blacktriangleleft\blacktriangleleft\blacktriangleleft$) repeatedly.

- $\blacktriangleright\blacktriangleright\blacktriangleright$ ($\blacktriangleright\blacktriangleright\blacktriangleright$): Skips to the beginning of the next or succeeding tracks.
- $\blacktriangleleft\blacktriangleleft\blacktriangleleft$ ($\blacktriangleleft\blacktriangleleft\blacktriangleleft$): Goes back to the beginning of the current or previous tracks.

On the unit:

Push repeatedly (or hold) the joy control rightward ($\blacktriangleright\blacktriangleright\blacktriangleright \blacktriangleright$) or leftward ($\blacktriangleleft\blacktriangleleft\blacktriangleleft \blacktriangleleft$).

- Rightward ($\blacktriangleright\blacktriangleright\blacktriangleright \blacktriangleright$): Skips to the beginning of the next or succeeding tracks.
- Leftward ($\blacktriangleleft\blacktriangleleft\blacktriangleleft \blacktriangleleft$): Goes back to the beginning of the current or previous tracks.

To go to another track directly using the number buttons (on the remote control ONLY)

Pressing the number button(s) allows you to start playing the track number you want.

Ex.: For track number 5, press 5.

For track number 15, press +10, then 5.

For track number 20, press +10, then 10.

For track number 32, press +10, +10, +10, then 2.

Programming the Playing Order of the Tracks — Program Play

You can arrange the order in which the tracks play before you start playing. You can program up to 32 tracks.

On the remote control:

1

Load CDs.

- If the current selected source is not the CD player, press CD \blacktriangleright / \parallel , then \blacksquare before going to the next step.

2

Press PLAY MODE so that “CD PROGRAM” appears in the main display.

The PRGM indicator also lights.



- Each time you press the button, play mode changes as follows:

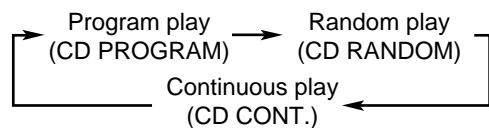

3

Press one of the disc number buttons (CD1, CD2, and CD3) to select the disc number you want to play.

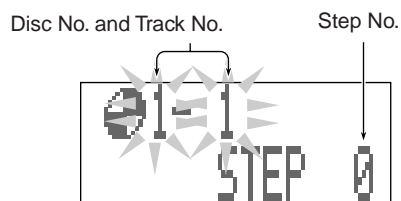

4

Press the number buttons to select the track from the disc selected in the above step.

- For how to use the number buttons, see “To go to another track directly using the number buttons (on the remote control ONLY)” to the left.

5 Program other tracks you want.

- To program tracks from the same disc, repeat step 4.
- To program tracks from a different disc, repeat steps 3 and 4.

6 Press CD ► / II.

- The tracks are played in the order you have programmed.

On the unit:

You have to use the menu for the following operations. For general information on the menu, see pages 59 and 60.

1 Load CDs.

- If the current selected source is not the CD player, press CD ▷ / II, then ■ before going to the next step.

2 Select Program play mode using the menu. (See also page 61.)



- 1) Press MENU.
“MENU” appears in the main display.
- 2) Push the joy control downward (∨) to select “CD (current play mode setting*).”
* The current play mode — CONTINUE, RANDOM, or PROGRAM will appear following “CD” in the main display.
- 3) Push the joy control rightward (>) or leftward (<) to select “PROGRAM.”
- 4) Press SET.
“CD PROGRAM” appears in the main display. The PRGM indicator also lights.



3 Select the tracks.

- 1) Push the joy control upward (∧) or downward (∨) to select the disc number.
- 2) Push the joy control rightward (>) or leftward (<) to select the track number.

3) Press SET.



Ex. Track No. 4 is selected from Disc No. 1.

4) Repeat steps to program other tracks.

- To program tracks from the same disc, repeat steps 2) and 3).
- To program tracks from a different disc, repeat steps 1) to 3).

4 Press CD ▷ / II.

- The tracks are played in the order you have programmed.

To stop during play, press ■.

- Program play also stops when you open a disc tray.

To exit from Program play mode, select another playback mode (Continuous play or Random play mode) before or after play either by pressing PLAY MODE on the remote control or by using the menu on the unit (see page 61).

- Turning off the unit will automatically change the playback mode to Continuous play.

To check the program contents

Before playing, you can check the program contents by pressing I◀◀ (◀◀) or ▶▶I (▶▶) on the remote control.

- I◀◀ (◀◀) : Shows the programmed tracks in the reverse order.
- ▶▶I (▶▶) : Shows them in the programmed order.

To modify the program

Before playing, you can erase the last programmed track by pressing CANCEL. Each time you press the button, the last programmed track is erased from the program.

- When you eject a disc, the tracks selected from that ejected disc are erased from the program.

To add tracks in the program before you start play, simply select track numbers you want to add.

To erase the entire program, before or after play, press and hold CANCEL on the unit until “CD PROGRAM ALL CLEAR” appears in the main display.

- Turning off the unit also erases the entire program.



If you try to program a 33rd step

“CD PROGRAM FULL” will appear in the main display.



If your entry is ignored

You have tried to program a track from an empty tray, or a track number that does not exist on the CD (for example, selecting track 14 on a CD that only has 12 tracks). Such entries are ignored.

Playing at Random — Random Play

The tracks of all loaded CDs will play at random.

On the remote control:

1 Load CDs.

- If the current selected source is not the CD player, press CD ► / II, then ■ before going to the next step.

2 Press PLAY MODE so that “CD RANDOM” appears in the main display.

The RANDOM indicator also lights.



- Each time you press the button, play mode changes as follows:

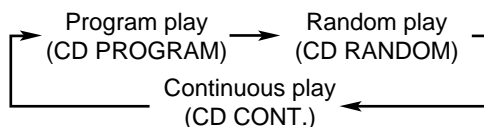

3 Press CD ► / II.

The tracks are played at random.

Random play stops when all the tracks are played once.

On the unit:

You have to use the menu for the following operations. For general information on the menu, see pages 59 and 60.

1 Load CDs.

- If the current selected source is not the CD player, press CD ► / II, then ■ before going to the next step.

2 Select Random play mode using the menu. (See also page 61.)



- 1) Press MENU.
“MENU” appears in the main display.
- 2) Push the joy control downward (∨) to select “CD (current play mode setting*).”
* The current play mode — CONTINUE, RANDOM, or PROGRAM will appear following “CD” in the main display.
- 3) Push the joy control rightward (>) or leftward (<) to select “RANDOM.”
- 4) Press SET.
“CD RANDOM” appears in the main display. The RANDOM indicator also lights.



3 Press CD ► / II.

The tracks are played at random.

Random play stops when all the tracks are played once.

To skip the playing track, press ►► (►►) on the remote control or push the joy control rightward (►► >).

- You cannot go back to the previous tracks by pressing ◀◀ (◀◀) on the remote control or pushing the joy control leftward (◀◀ <).

To stop during play, press ■.

- Random play also stops when you open a disc tray.

To exit from Random play mode, select another playback mode (Continuous play or Program play mode) before or after play either by pressing PLAY MODE on the remote control or by using the menu on the unit (see page 61).

- Pressing one of the disc number buttons (CD1, CD2, and CD3) starts Continuous play from the first track of the selected CD.
- Pressing one of the number buttons will start Continuous play from the selected track of the currently selected CD.
- Turning off the unit will automatically change the playback mode to Continuous play.

Repeating Tracks or CDs — Repeat Play

You can have all the CDs, the program or the individual track currently playing repeat as many times as you like.

To repeat play, press REPEAT on the remote control during or before playing.



Ex. When "REPEAT ALL" is selected

- Each time you press the button, Repeat play mode changes and appears in the main display as follows:

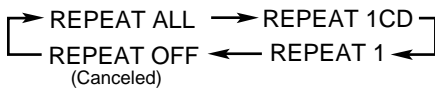

- REPEAT ALL:** Repeats all the tracks on all the CDs (continuously or at random), or all the tracks in the program.
- REPEAT 1CD*:** Repeats all the tracks on one CD.
- REPEAT 1:** Repeats one track on one CD.
- REPEAT OFF:** Cancels the repeat play.

* REPEAT 1CD is not used for Program play and Random play.



When using the unit, you can activate or deactivate Repeat play mode by using the menu (see "Setting the repeat modes" on page 61).

Prohibiting Disc Ejection — Disc Lock

You can prohibit CD and MD ejection from the unit and can lock discs.

- You cannot use this function while the display demonstration is shown in the main display.

On the unit ONLY:

To prohibit disc ejection

- 1 Press and hold ■ when the unit is in standby mode.
- 2 Press ▲ CD1.
"LOCKED" appears for a while, and the loaded discs (both CDs and MD) are locked.



- 3 Release your finger from ■.



If you try to eject the locked discs
"LOCKED" appears to inform you that the Disc Lock is in use.

To cancel the prohibition and unlock the discs, repeat the above procedure.

"UNLOCKED" appears for a while in step 2, and the loaded discs (both CDs and MD) are unlocked.



If you turn on the unit after canceling the prohibition to unlock the discs

The CD tray may come out. This is not a malfunction of the unit.

Playing Back an MD

The buttons and controls enlarged in the illustration below are used and explained in this section (pages 26 to 30).

Remote control

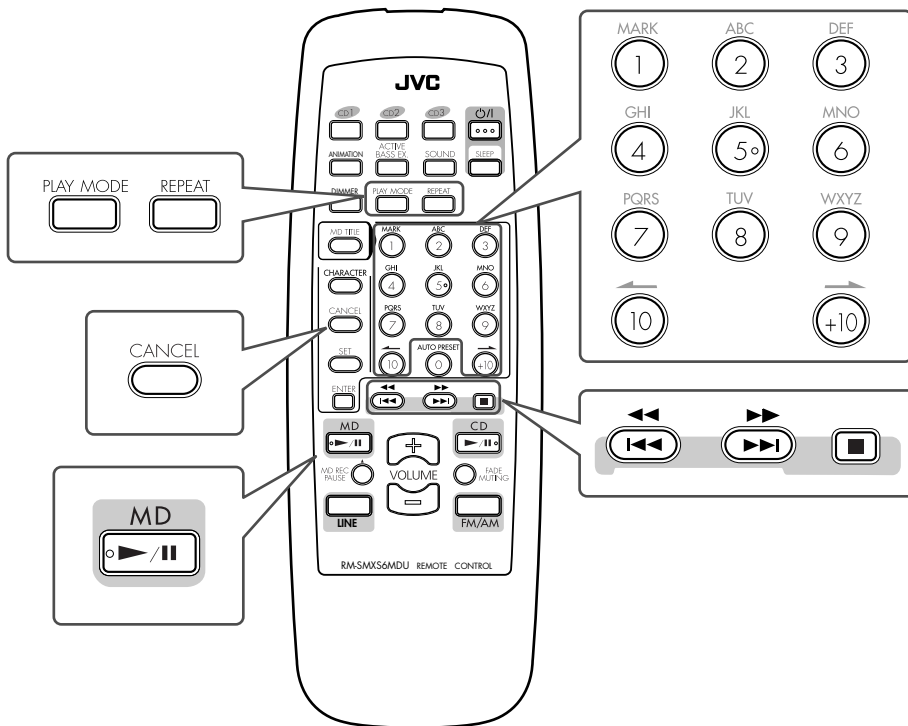

Main unit

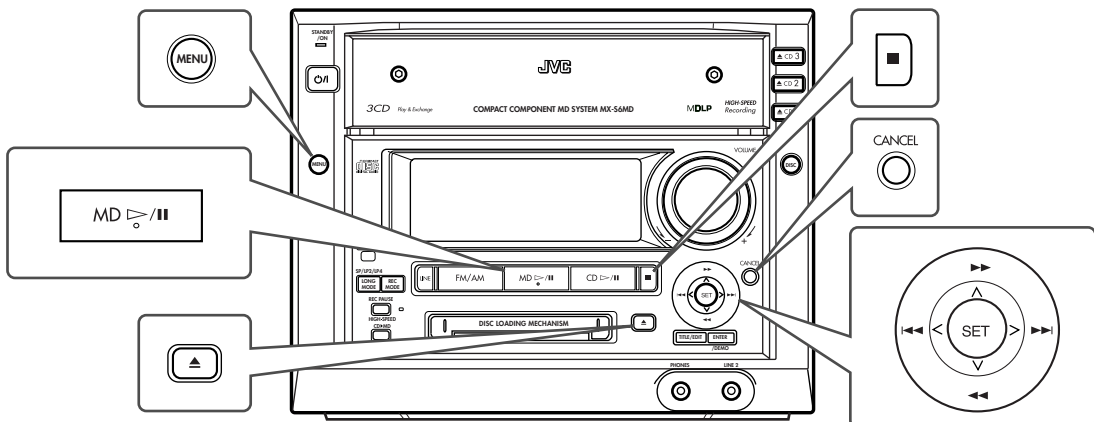

Playing Back the Entire MD — Normal Play

You can play an MD.

Before inserting an MD, turn on the unit; otherwise, you cannot insert it.

1 Insert an MD into the MD loading slot.

The MD is pulled in automatically.

The MD insertion indicator () lights on the display.

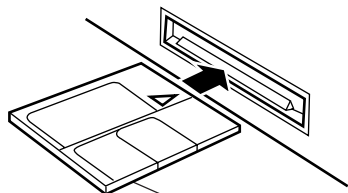

Insert an MD in the same way as indicated on the MD.

The following indications appear when the current source is "MD"

 MD LOADING

 TOC READING

Total Track No. Total Playing time

 17 1:04:21

2 Press MD ► / II.

The MD source () indicator lights on the display and MD playback starts from the first track.

The recording length mode indicator (SP/LP2/LP4)* lights on the display.

Track No. Elapsed playing time

 1 0:01

To stop during play, press ■.

To remove the disc, press ▲ for the MD recorder.



If the MD or track has a title

The title will be shown at the center portion of the main display. (If a title is long and cannot be shown at a time, the unit scrolls the title to show the entire title.)



* About recording length mode

MDs are played back in the same recording length mode as they were recorded. When an MD starts playing, the playback mode of the currently playing track lights on the display.

SP : Indicates the tracks recorded in standard stereo recording mode on this unit or those recorded on an MD recorder incompatible with MDLP*.

LP2 : Indicates the tracks recorded in 2 times long-hour stereo recording mode.

LP4 : Indicates the tracks recorded in 4 times long-hour stereo recording mode.

* MDLP features a new sound compression method (ATRAC3) and a 2 times (or 4 times) long-hour stereo recording and playing function.

The MDLP logo is marked on the MD recorders and players compatible with MDLP. It is also marked on MDs pre-recorded in ATRAC3 (excluding recordable MDs).

Basic MD Operations

While playing an MD, you can do the following operations.

To stop playback for a moment

Press MD ► / II.

To resume play, press MD ► / II again.

To locate a particular point in a track during play

On the remote control:

Press and hold ►► (►►) or ◀◀ (◀◀).

• ►► (►►) : Fast-forwards the tracks.

• ◀◀ (◀◀) : Fast-reverses the tracks.

On the unit:

Push the joy control upward (►► ^) or downward (◀◀ v).

• Upward (►► ^) : Fast-forwards the tracks.

• Downward (◀◀ v) : Fast-reverses the tracks.

To go to another track

On the remote control:

Press **▶▶▶** (▶▶▶) or **◀◀◀** (◀◀◀) repeatedly.

- **▶▶▶** (▶▶▶) : Skips to the beginning of the next or succeeding tracks.
- **◀◀◀** (◀◀◀) : Goes back to the beginning of the current or previous tracks.

On the unit:

Push repeatedly (or hold) the joy control rightward (**▶▶▶ >**) or leftward (**◀◀◀ <**).

- Rightward (**▶▶▶ >**) : Skips to the beginning of the next or succeeding tracks.
- Leftward (**◀◀◀ <**) : Goes back to the beginning of the current or previous tracks.

To go to another track directly using the number buttons (on the remote control ONLY)

Pressing the number button(s) allows you to start playing the track number you want.

- Ex.:
- For track number 5, press 5.
 - For track number 15, press +10, then 5.
 - For track number 20, press +10, then 10.
 - For track number 32, press +10, +10, +10, then 2.

Programming the Playing Order of the Tracks — Program Play

You can arrange the order in which the tracks play before you start playing. You can program up to 32 tracks.

On the remote control:

1 Load an MD.

- If the current playing source is not the MD recorder, press **MD ▶ / II**, then **■** before going to the next step.

2 Press **PLAY MODE** so that “MD PROGRAM” appears in the main display.

The PRGM indicator also lights.



- Each time you press the button, play mode changes as follows:

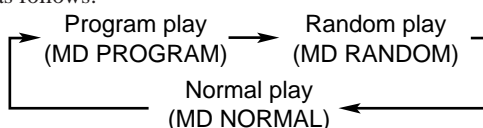

3 Press the number buttons to select the tracks.

- For how to use the number buttons, see “To go to another track directly using the number buttons (on the remote control ONLY)” to the left.

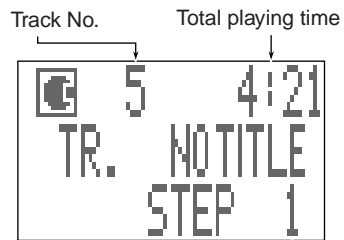

Ex. When selecting track 5 Step No.

- If the selected track has a title, it will be shown at the center portion of the main display. (If the title is long and cannot be shown at a time, the unit scrolls the title to show the entire title.)

4 Press **MD ▶ / II**.

- The tracks are played in the order you have programmed.

On the unit:

You have to use the menu for the following operations. For general information on the menu, see pages 59 and 60.

1 Load an MD.

- If the current playing source is not the MD recorder, press **MD ▶ / II**, then **■** before going to the next step.

2 Select Program play mode using the menu. (See also page 61.)



- 1) Press **MENU**.
“MENU” appears in the main display.
- 2) Push the joy control downward (**∨**) to select “MD (current play mode setting*).”
* The current play mode — NORMAL, RANDOM, or PROGRAM will appear following “MD” in the main display.
- 3) Push the joy control rightward (**>**) or leftward (**<**) to select “PROGRAM.”

- 4) **Press SET.**
 “MD PROGRAM” appears in the main display.
 The PRGM indicator also lights.



3 Select the tracks.

- 1) Push the joy control rightward (>) or leftward (<) to select the track number.
- 2) Press SET.



Ex. When selecting track 5

- 3) Repeat steps 1) and 2) to program other tracks.

4 Press MD ▷ / II.

- The tracks are played in the order you have programmed.

To stop during play, press ■.

To exit from Program play mode, select another playback mode (Normal play or Random play mode) before or after play either by pressing PLAY MODE on the remote control or by using the menu on the unit (see page 61).

- Turning off the unit or ejecting the MD will automatically change the playback mode to Normal play.

To check the program contents

Before playing, you can check the program contents by pressing ◀◀ (◀◀) or ▶▶ (▶▶) on the remote control.

- ◀◀ (◀◀) : Shows the programmed tracks in the reverse order.
- ▶▶ (▶▶) : Shows them in the programmed order.

To modify the program

Before playing, you can erase the last programmed track by pressing CANCEL. Each time you press the button, the last programmed track is erased from the program.

To add tracks in the program before you start play, simply select track numbers you want to add.

To erase the entire program, before or after play, press and hold CANCEL on the unit until “MD PROGRAM ALL CLEAR” appears in the main display.

- When you eject the MD or turn off the unit, the entire program is also erased.



If you try to program a 33rd step
 “MD PROGRAM FULL” will appear in the main display.



If your entry is ignored
 You have tried to program a track that does not exist on the MD (for example, selecting track 14 on an MD that only has 12 tracks). Such entries are ignored.



If the total playing time exceed 2 hours and 30 minutes
 The playing time will not be shown. (“- : - -” will appear.)

Playing at Random — Random Play

The tracks of the loaded MD will play at random.

On the remote control:

1 Load an MD.

- If the current playing source is not the MD recorder, press MD ▶ / II, then ■ before going to the next step.

2 Press PLAY MODE so that “MD RANDOM” appears in the main display.

The RANDOM indicator also lights.



- Each time you press the button, play mode changes as follows:

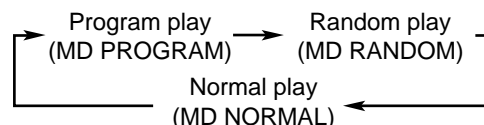

3 Press MD ► / II.

The tracks are played at random.
Random play ends when all the tracks are played once.

On the unit:

You have to use the menu for the following operations. For general information on the menu, see pages 59 and 60.

1 Load an MD.

- If the current playing source is not the MD recorder, press MD ▷ / II, then ■ before going to the next step.

2 Select Random play mode using the menu. (See also page 61.)



- 1) Press MENU.
“MENU” appears in the main display.
- 2) Push the joy control downward (∨) to select “MD (current play mode setting*).”
* The current play mode — NORMAL, RANDOM, or PROGRAM will appear following “MD” in the main display.
- 3) Push the joy control rightward (>) or leftward (<) to select “RANDOM.”
- 4) Press SET.
“MD RANDOM” appears in the main display. The RANDOM indicator also lights.



3 Press MD ▷ / II.

The tracks are played at random.
Random play stops when all the tracks are played once.

To skip the playing track, press ►►I (►►) on the remote control or push the joy control rightward (►►I >).

- You cannot go back to the previous tracks by pressing I◄◄ (◄◄) on the remote control or pushing the joy control leftward (I◄◄ <).

To stop during play, press ■.

To exit from Random play mode, select another playback mode (Normal play or Program play mode) before or after play either by pressing PLAY MODE on the remote control or by using the menu on the unit (see page 61).

- Turning off the unit or ejecting the MD will automatically change the playback mode to Normal play.
- Pressing one of the number buttons will start Normal play from the selected track.

Repeating Tracks — Repeat Play

You can have all the tracks, the program or the individual track currently playing repeat as many times as you like.

To repeat play, press REPEAT on the remote control during or before playing.



Ex. When “REPEAT ALL” is selected

- Each time you press the button, Repeat play mode changes and appears in the main display as follows:



REPEAT ALL: Repeats all the tracks in the MD (in Normal play or Random play mode), or all the tracks in the program.

REPEAT 1: Repeats one track.

REPEAT OFF: Cancels the repeat play.



When using the unit, you can activate or deactivate Repeat play mode by using the menu (see “Setting the repeat modes” on page 61).

To prohibit disc ejection — Disc Lock

You can prohibit CD and MD ejection from the unit, and can lock the discs.

See page 25 for details.

Recording on MDs

The buttons and controls enlarged in the illustration below are used and explained in this section (pages 31 to 38). For recording operations, you mainly use the buttons and controls on the unit.

Main unit

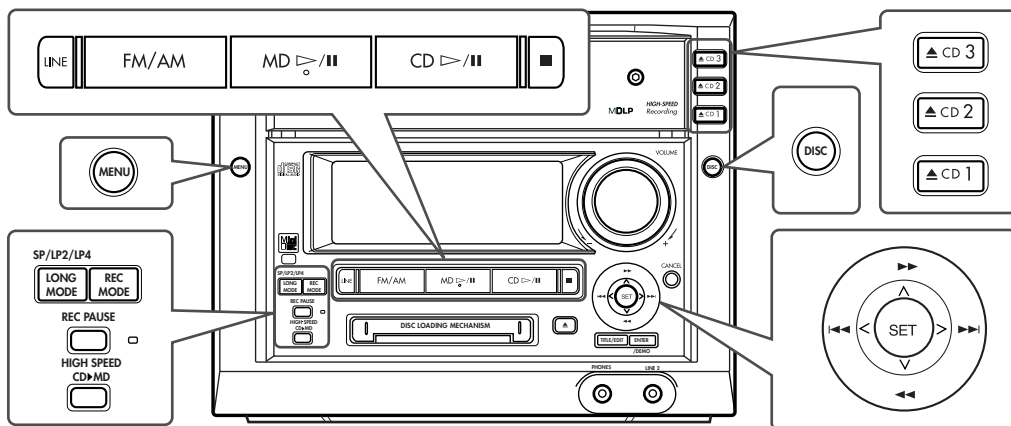

Remote control

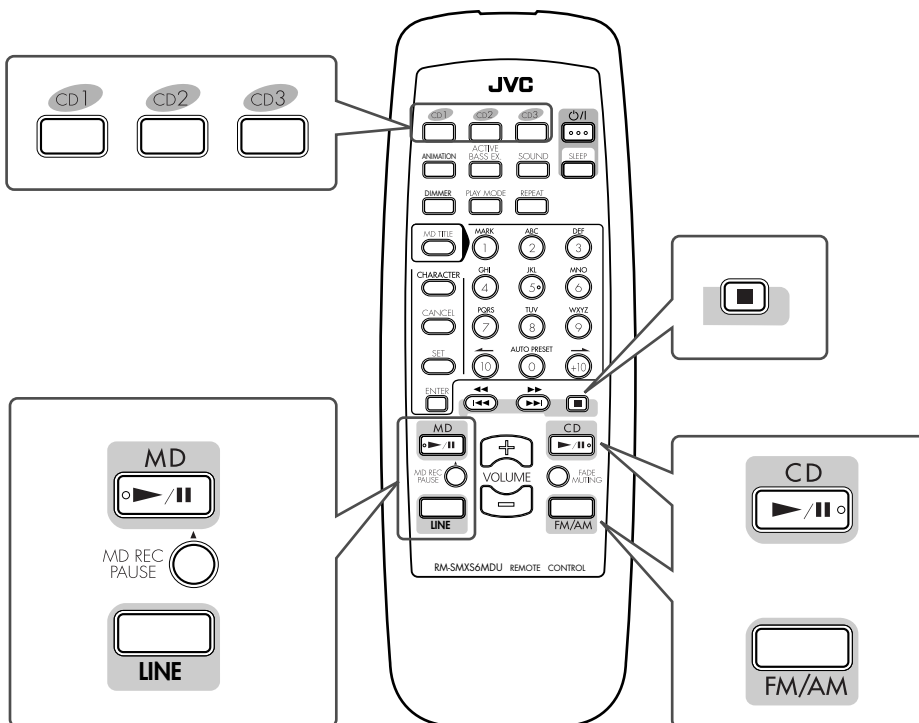

Before You Start Recording

- **It may be unlawful to record or play back copyrighted material without the consent of the copyright owner.**
- The sampling frequency rate converter built in the MD recorder allows you to record a digital source if its sampling frequency is 32 kHz, 44.1 kHz, or 48 kHz. If no source equipment is connected to the DIGITAL IN terminal or if the sampling frequency of the connected equipment is not 32 kHz, 44.1 kHz, or 48 kHz, "DIGITAL IN UNLOCK" appears in the main display (no recording is possible).
- You cannot record the Dolby Digital, DTS Digital Surround, or MPEG Multichannel signals entirely through the DIGITAL IN terminal.
- When you record onto partially recorded MD, its contents are not erased or overwritten. The recording starts from the point following the last recorded track of the MD.
If you want to record on such an MD from the beginning, you have to erase its contents first (see "ALL ERASE Function" on page 44).
- When an MD is fully recorded, recording will stop automatically.
- The recording level is automatically set correctly (except when recording from the equipment connected to the LINE 1 and LINE 2 jacks), so it is not affected by the VOLUME control. Thus, during recording you can adjust the sound you are actually listening to without affecting the recording level.
- While recording, you can hear sound mode effect and/or the Active Bass Extension effect through the speakers or headphones. However, the sound is recorded without these effects (see pages 12 and 15).

About the track marks

When playing an MD, you can move among the tracks. You can do this because there is a mark recorded at the beginning of each track enabling you to locate the track. This mark is called a "track mark" and the portion between two adjacent track marks is called a "track."

- **When recording from an analog source such as FM/AM broadcasts**, no track mark is recorded on the MD. This means that, when playing this MD, the MD recorder will regard the entire recording as one track (track 1). You will not be able to select directly a song or navigate through songs.

However, if there is a blank of 3 seconds or more, the MD recorder will consider it as a blank separating 2 tracks and consequently put a track mark.

To put a track mark manually while recording an analog source, press SET on the unit at the place you want to put a track mark.

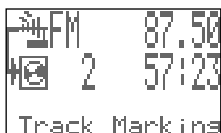

EX. When pressing SET while recording an FM broadcast program

To add a track mark after recording is over, you can use the DIVIDE function (see page 41).

To avoid erasing important recordings

The recordable MD has an erasure prevention tab so that important recordings are not accidentally erased. When you finish recording or editing, slide open the erasure prevention tab on the cartridge side surface. New recording or editing is now no longer possible. (If you try to do, "DISC PROTECTED" appears in the main display.)

To do re-recording or editing, return the tab to the closed position.

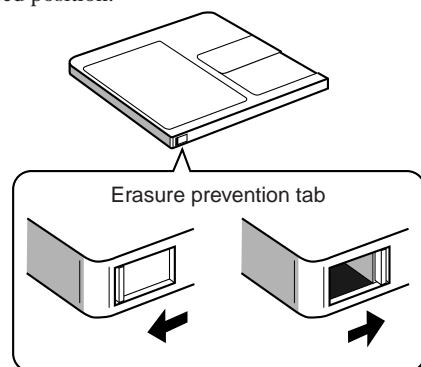

Recording/Editing possible

Disc protected:
Recording/Editing not possible



If "PLAYBACK DISC" appears in the main display when you try to record on an MD

The MD is only for playback use, not for recording.

Stereo Long-Hour Recording (MDLP)

On conventional MD recorders, 2 times long-hour recording on MDs has been possible only in monaural sound, but this unit allows for 2 times or 4 times long-hour recording without losing stereo sound.

This feature can be used for any recording method provided with this unit.

Songs (tracks) can be recorded on a single MD using different recording length modes (LONG MODE — SP: Standard Play, LP2: 2 Times Long Play, LP4: 4 Times Long Play).

To make a recording using this feature, follow the basic procedure below:

- 1 Check the recording remaining time of the MD you want to use for recording. (See the right column, “To check the remaining recording time.”)
- 2 Press LONG MODE to set the desired recording length mode (LONG MODE — SP/LP2/LP4).

- Each time you press the button, the recording length modes change as follows and the corresponding indicator lights in the display:

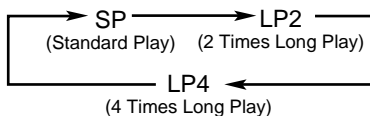

SP: Signifies standard-hour stereo recording. The number of hours usable for recording is the same as shown on the package of the MD.

LP2: Signifies 2 times long-hour stereo recording. The number of hours usable for recording is twice as long as shown on the package of the MD.

LP4: Signifies 4 times long-hour stereo recording. The number of hours usable for recording is 4 times as long as shown on the package of the MD.

- 3 Press REC MODE to select the recording method if necessary.
 - 4 Start recording.
- For more detailed explanation, see the following pages describing the actual recording methods.

REMEMBER to check the remaining recording time of MDs before starting recording

The remaining recording time of MDs will be calculated and shown, based on the recording length mode (SP/LP2/LP4) currently selected.

Before starting recording or using the Recording Timer, check the recording time remaining on the MD for each recording length mode (SP/LP2/LP4) and select the optimum recording length mode.

To check the remaining recording time

- 1 Insert an MD to record on.
- 2 Select any source other than “MD.”
- 3 Press LONG MODE to select the recording length mode (SP/LP2/LP4).
- 4 Press REC PAUSE (or MD REC PAUSE on the remote control).
The unit enters recording pause mode. The track number to be recorded and **the remaining recording time are shown in the main display.**
- 5 Press ■ to cancel the recording pause mode after checking the remaining recording time.
Now you can proceed with your recording operation or Recording Timer operation.

If you want to check the remaining time in other recording length modes, repeat steps 3 to 5.

Precautions for performing long-hour stereo recording

After having made long-hour stereo recordings on this unit, pay attention to the following:

- Songs (tracks) recorded in 2 times or 4 times long-hour recording mode can only be played back on the equipment provided with MDLP, compatible with a long-hour stereo recording function; otherwise, “LP:” is displayed before a title and playback proceeds without sounds.
- When editing songs (tracks) on an MD, you cannot join (JOIN) songs (tracks) recorded in different recording length modes (SP/LP2/LP4).



More about MDLP

- You cannot make a long-hour monaural recording using this unit.
- Sound quality will decrease as the recording length mode changes to LP2 (little) and LP4 (much). To obtain the best sound quality, it is recommended to use the SP mode when recording.

About High-Speed Recording

There are some restrictions to observe for high-speed recording (exceeding normal speed) to protect copyrights. (HCMS: see page 67.)

This unit is so designed that a song (track) recorded from a CD using high-speed recording cannot be re-recorded until 74 minutes elapse after the previous recording started.

If you try to re-record the same song (track) within the 74 minutes, recording is canceled and the display turns red with "HCMS CANNOT COPY" shown as a warning.



The remaining time required until re-recording will then appear in the main display.

If this happens, press ■ after the remaining time appears.
CD playback stops.

REMEMBER if you are trying to record a program including the same song (track) twice using high-speed recording, recording will stop at the beginning of the 2nd recording of the same song (track). ("HCMS CANNOT COPY" will appear in the main display.)



During high-speed recording

You cannot listen to any source, and therefore, cannot adjust the volume level. ("CANNOT LISTEN!" will appear if you try to do.)

Recording Any Sound Source — Standard Recording

The following recording method can be applied to any sound source.

1 Insert a recordable MD in the MD loading slot.

2 Select the source.

- When recording CDs:
On the unit: Press DISC to select a disc, and press CD ▷ / ■, then press ■.
On the remote control: Press CD1, CD2, or CD3 to select a disc you want to record with, then ■.
- When recording an FM/AM broadcast:
Press FM/AM, then tune into a station you want.
- When recording from external equipment:
Press LINE repeatedly until the external equipment you want is selected.

When the source for recording is the equipment connected to either the LINE 1 jacks or the LINE 2 jack, you can select the sound input level. See "Selecting the sound input level" on page 63.

3 Press LONG MODE on the unit if necessary.

The recording length mode changes as follows:

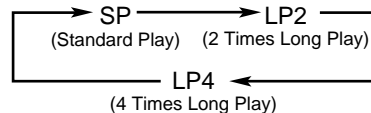

- For the recording length mode, see "Stereo Long-Hour Recording (MDLP)" on page 33.

4 Press REC PAUSE on the unit (or MD REC PAUSE on the remote control).

The REC PAUSE lamp on the unit starts flashing.

5 Press MD ▷ / ■.

The REC PAUSE lamp stops flashing and remains lit, and recording starts.

- When recording an FM/AM broadcast:
The station frequency will be recorded as the track title.

6 When recording a CD:

Press CD ▷ / ||.

When recording from external equipment:

Start playback.

- For details, see the manual supplied with your equipment.

To stop recording for a moment, press REC PAUSE (or MD REC PAUSE) again.

To resume recording, press MD ▷ / || again. (A track mark is recorded when you resume recording.)

To stop recording, press ■. “WRITING” flashes for a while.

- When recording from a CD, both the CD player and the MD recorder stop.



When recording from a CD using Standard Recording

Two track marks may be recorded at the beginning of the recording. If this occurs, join these two track marks using the JOIN function described on page 42.



You can use more useful and easier recording methods

- For recording from CDs, see “Recording CDs — CD Synchronized Recording” below.
- For recording from the external equipment, see “Recording the External Equipment — Sound Synchronized Recording” on page 38.

Recording CDs — CD Synchronized Recording

You have three methods to record from CDs onto an MD. Using the synchronized recording methods, you can start and stop CD play and MD recording at the same time.

- **All CDs Synchronized Recording** — Records all loaded CDs continuously (Continuous play mode) or at random (Random play mode), or the program you have made (Program play mode).
- **One CD Synchronized Recording** — Records the entire CD.
- **First Track Recording** — Records the first track of each CD.

For each recording method, you can select the recording speed — either high speed or normal speed.

All CDs Synchronized Recording

■ Using the HIGH-SPEED CD ► MD button on the unit

This is the easiest way of CD recording.

1

Insert a recordable MD into the MD loading slot.

2

Prepare CDs.

- After placing CDs, press CD ▷ / ||, then ■ before going to the next step.
- You can make a program (see page 22) or select Random play mode (see page 24) if you want. In this case, you cannot select the starting disc → go to step 4.

3

Press DISC to select the disc you want to start recording with.

- Make sure that the correct disc number indicator is selected on the display.

4

Press LONG MODE on the unit if necessary.

The recording length mode changes as follows:

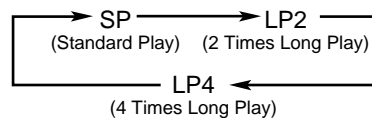

- For the recording length mode, see “Stereo Long-Hour Recording (MDLP)” on page 33.

5

Press HIGH-SPEED CD ► MD.

The REC PAUSE lamp on the unit lights, and recording starts.

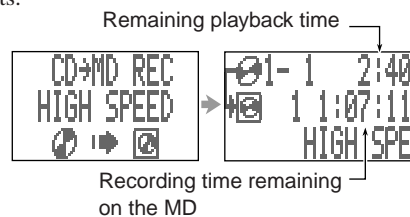

When all loaded CDs are recorded, recording will stop. Both the CD player and the MD recorder stop automatically.

To stop recording, press ■. “WRITING” flashes for a while.

Both the CD player and the MD recorder stop.

To record a single track during play or pause

Press HIGH-SPEED CD ► MD while playing back or pausing a CD track you want to record.

The playback of that CD track is stopped, and the same track starts playing from the beginning again. This time, the MD recorder starts recording the CD track.

- When the track is recorded, both the CD player and the MD recorder stop.

■ Using the REC MODE button on the unit

You can select the recording speed — high speed or normal speed.

1 Insert a recordable MD into the MD loading slot.

2 Prepare CDs.

- After placing CDs, press CD ▷ / II, then ■ before going to the next step.
- You can make a program (see page 22) or select Random play mode (see page 24) if you want. In this case, you cannot select the starting disc → go to step 4.

3 Press DISC to select the disc you want to start recording with.

- Make sure that the correct disc number indicator is selected on the display.

4 Press LONG MODE on the unit if necessary.

The recording length mode changes as follows:

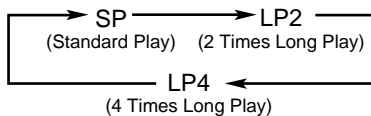

- For the recording length mode, see “Stereo Long-Hour Recording (MDLP)” on page 33.

5 Select the recording mode.

1) Press REC MODE.

- Make sure that “CD→MD” is selected (highlighted).

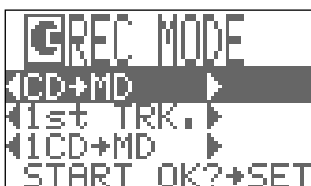

2) Push the joy control rightward (>) or leftward (<) if you want to change the recording speed from normal speed to high speed (HIGH).

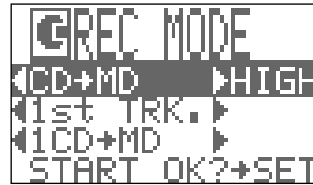

3) Press SET.

The REC PAUSE lamp on the unit lights, and recording starts.

When all loaded CDs are recorded, recording will stop. Both the CD player and the MD recorder stop automatically.

To stop recording, press ■. “WRITING” flashes for a while.

Both the CD player and the MD recorder stop.

To record a single track during play or pause

1 Press REC MODE while playing back or pausing a CD track you want to record.

2 Make sure that “CD→MD” is selected (highlighted).

3 Push the joy control rightward (>) or leftward (<) if you want to change the recording speed from normal speed to high speed (HIGH).

4 Press SET.

The playback of that CD track is stopped, and the same track starts playing from the beginning again. This time, the MD recorder starts recording the CD track.

- When the track is recorded, both the CD player and the MD recorder stop.

**During All CDs Synchronized Recording**

You can exchange the discs not being played back. (See page 22.)

One CD Synchronized Recording**■ Using the REC MODE button on the unit ONLY**

You can record the entire CD onto an MD.

1 Insert a recordable MD into the MD loading slot.

2 Prepare a CD.

- Place a CD on one of the disc tray (CD 1, CD 2, or CD 3), press CD ▷ / II, then ■ before going to the next step.

3 Press DISC to select the disc you want to record.

- Make sure that the correct disc number indicator is selected on the display.

4 Press LONG MODE on the unit if necessary.

The recording length mode changes as follows:

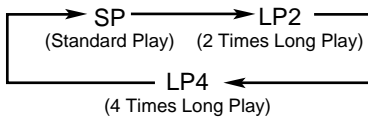

- For the recording length mode, see “Stereo Long-Hour Recording (MDLP)” on page 33.

5 Select the recording mode.

- Press REC MODE.
- Push the joy control downward (∨) to select “1CD→MD.”
- Push the joy control rightward (>) or leftward (<) if you want to change the recording speed from normal speed to high speed (HIGH).
- Press SET.
The REC PAUSE lamp on the unit lights, and recording starts.

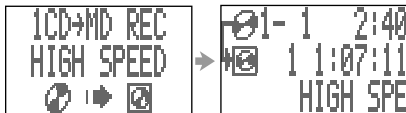

EX. When high speed recording is selected

When the entire CD is recorded, recording will stop. Both the CD player and the MD recorder stop automatically.

To stop recording, press ■. “WRITING” flashes for a while.

Both the CD player and the MD recorder stop.



During One CD Synchronized Recording

Repeat play mode will be canceled automatically.

First Track Recording

First Track Recording allows you to record the first track of each loaded CD. You can, for example, make a directory of all your best CDs.

■Using the REC MODE button on the unit ONLY

1 Insert a recordable MD into the MD loading slot.

2 Prepare CDs.

- After placing CDs, press CD ▷ / II, then ■ before going to the next step.
- Always place a CD on the CD 1 tray. If not, this function does not work.

3 Press LONG MODE on the unit if necessary.

The recording length mode changes as follows:

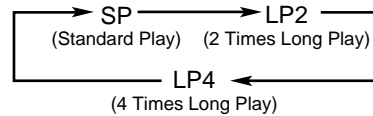

- For the recording length mode, see “Stereo Long-Hour Recording (MDLP)” on page 33.

4 Select the recording mode.

- Press REC MODE.
- Push the joy control downward (∨) to select “1st TRK.”
- Push the joy control rightward (>) or leftward (<) if you want to change the recording speed from normal speed to high speed (HIGH).
- Press SET.

The REC PAUSE lamp on the unit lights, and recording starts.

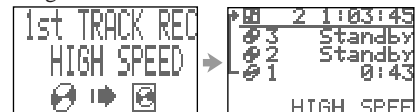

When the first track of the CD on the CD 1 tray is recorded, the first track of the CD on the CD 2 tray will be recorded. Recording continues until the first track of each loaded CD is recorded.

5 Press the open/close button (▲ CD1, ▲ CD2, or ▲ CD3) for the CDs already played to replace the CDs.

- You can change CDs to continue the First Track Recording using more than 3 CDs.

When the first track of the last loaded CD is recorded, First Track Recording stops.

To stop recording, press ■. “WRITING” flashes for a while.

Both the CD player and the MD recorder stop.



During First Track Recording

Repeat play mode will be canceled automatically.

Recording the External Equipment — Sound Synchronized Recording

With this recording method, you can start recording automatically when the source sound comes into this unit through the LINE 1 jacks, LINE 2 jack, or the DIGITAL IN terminal. Sound Synchronized Recording will stop automatically if no sound comes in for more than 30 seconds.

When the sound signal comes in through the DIGITAL IN terminal, digital recording is performed.

1 Insert a recordable MD into the MD loading slot.

2 Press LINE repeatedly to select the external equipment you want to record from.

- When selecting the equipment connected either the LINE 1 jacks or LINE 2 jack, the sound input level appears for a while. (See page 63 for the sound input level.)

3 Press LONG MODE on the unit if necessary.

The recording length mode changes as follows:

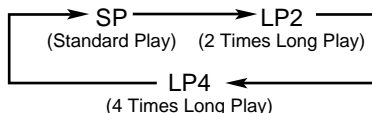

- For the recording length mode, see “Stereo Long-Hour Recording (MDLP)” on page 33.

4 Select Sound Synchronized Recording.

1) Press REC MODE.



2) Press SET.

The REC PAUSE lamp on the unit starts flashing.



Ex. When “LINE 1” is selected as a playback source (with “Penguin” is selected as the animation character)

5 Start playback on the external equipment.

The REC PAUSE lamp stops flashing and remains lit, and recording starts automatically.

To stop recording, press ■. “WRITING” flashes for a while.



When the source for recording is the equipment connected to either the LINE 1 jacks or the LINE 2 jack

You can select the sound input level. See “Selecting the sound input level” on page 63.



When recording is stopped or finished

Sound Synchronized Recording is canceled automatically.



If Sound Synchronized Recording do not work correctly

Use the Standard Recording method (see page 34).

Sound Synchronized Recording starts automatically when this unit detects sound signals coming in. This means that, if sound signal is too weak for this unit to detect, Sound Synchronized Recording will not start (or will stop even while the source is being played).



When recording from a DAT deck using Sound Synchronized Recording

Two track marks may be recorded at the beginning of the recording. If this occurs, join these two track marks using the JOIN function described on page 42.

Editing MDs

The buttons and controls enlarged in the illustration below are used and explained in this section (pages 39 to 44).

Main unit

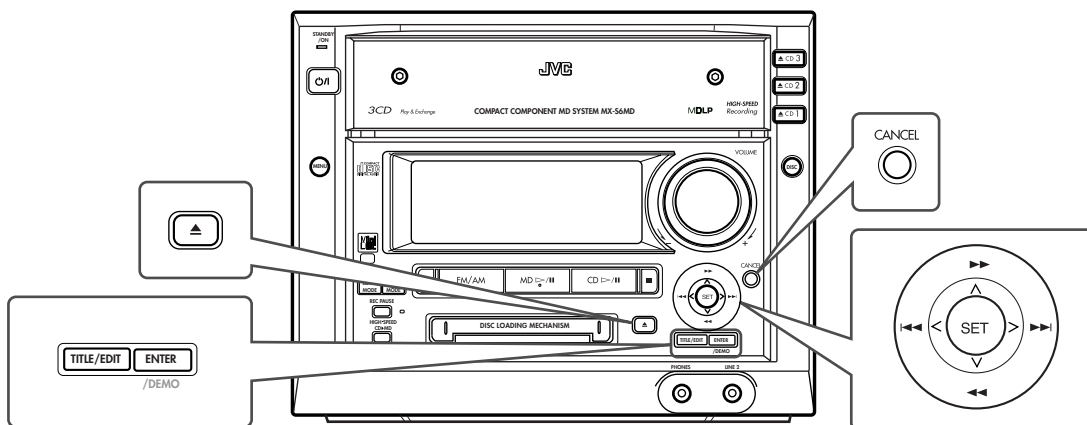

**You cannot use the remote control to edit MDs.
Use only buttons on the unit.**

Introducing MD Editing Functions

A recorded MD can be edited in many ways. The MD editing functions include dividing, joining, moving, erasing tracks, erasing the entire disc, and more than one of them can be combined as required.

Dividing a track (DIVIDE) : Page 41

This function divides a track by adding a track marking(s) in the desired point(s) in the middle or where you want to search later.

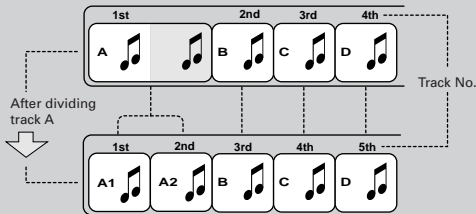

Joining a track (JOIN) : Page 42

This function joins two adjacent tracks into a single track by deleting a track marking.

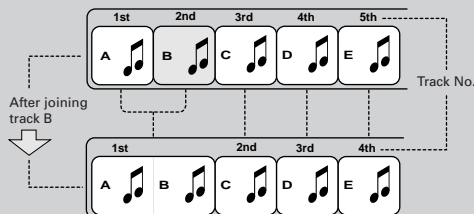

Moving a track (MOVE) : Page 42

This function moves a track by reordering the track numbers.

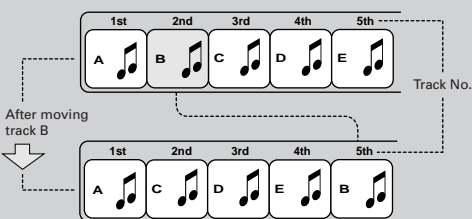

Erasing a track (ERASE) : Page 43

This function erases selected tracks. After the erasure, the subsequent tracks are justified and their track numbers are renumbered automatically. You can erase up to 15 tracks at a time.

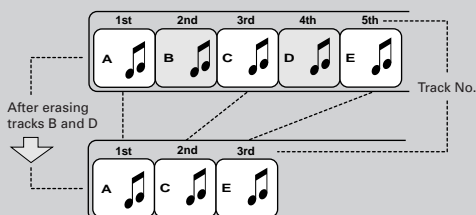

Erasing all tracks (ALL ERASE) : Page 44

This function erases data in a disc entirely.

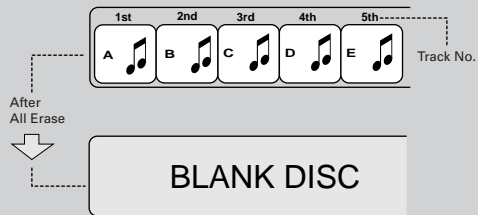

Erasing a portion of a track

By combining "DIVIDE," "ERASE" and "JOIN," for example, it is possible to erase only a part of an existing track.

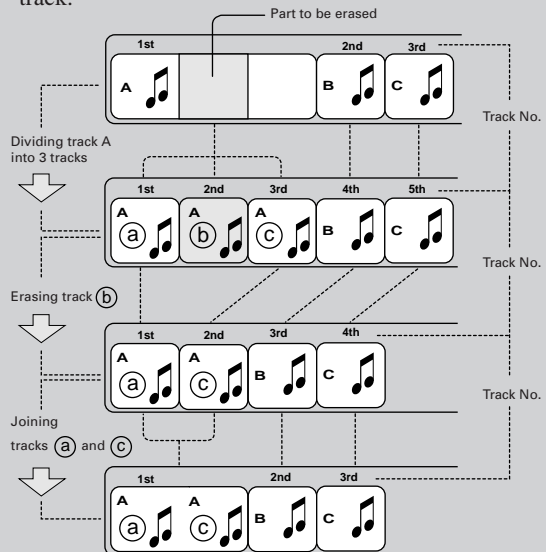

If "PLAYBACK DISC" or "DISC PROTECTED" appears when you try to edit an MD

You cannot edit such MDs. See page 68.



You can also assign titles to MDs and/or tracks
(See page 46.)

A title can be assigned to a track or disc. Once a title is assigned, it is displayed in later playback for confirmation.

Each title can be composed of up to 61 characters, and can be input using alphabetic characters (uppercase and lowercase), symbols and numerals.

DIVIDE Function

This function allows you to divide one track into two separate tracks. It is useful, for example, when you want to add track marks at a certain point within a track or if you want to separate a recording.

- To stop any time during editing process, press TITLE/EDIT.

1 Insert an MD you want to edit into the MD loading slot.

- It takes about 5 seconds for the unit to read the TOC (Table Of Contents) of the inserted MD. While the unit is reading it, you cannot go to the next step.

2 Press TITLE/EDIT.

The source is changed to "MD."

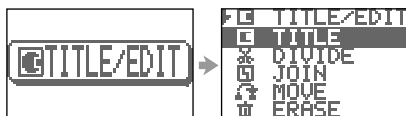

- If "DIVIDE" is not shown, you cannot divide the track.

3 Push the joy control downward (∨) to select "DIVIDE" (highlighted), then press SET.

The first track (or the current track) starts playing.

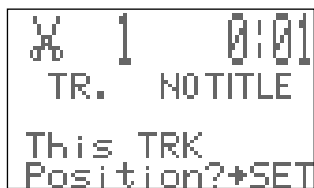

4 Push the joy control rightward (>) or leftward (<) to select the track you want to divide.

The selected track starts playing.

Ex. When you want to divide track 5

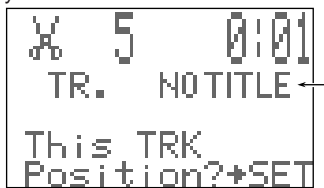

If the track has a title, it is shown here.

- If you do not push the joy control rightward (▶▶▶ >) or leftward (◀◀◀ <), the same track plays repeatedly.
- You can push and hold the joy control upward (▶▶▶ ^) or downward (◀◀◀ ∨) to find the dividing point.

5 Press SET when you find the point where you want to divide the track.

The MD recorder repeats the selected point — a 3-second period following the dividing point.

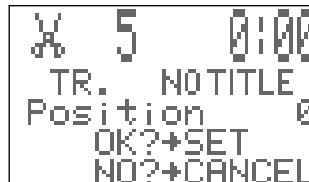

- If the dividing point is satisfactory, go to step 7.
- If the dividing point is not satisfactory, go to the next step.

6 Push and hold the joy control rightward (>) or leftward (<) to precisely adjust the dividing point.

- You can shift the dividing point up to ± 128 . This range (± 128) corresponds to approximately ± 8 seconds* from the original point (Position 0).

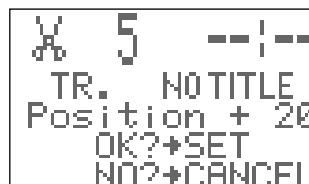

Ex. When adjusting the point by +20

- * When "SP" is selected for the recording length mode. For "LP2," it is approximately ± 16 seconds, and for "LP4" approximately ± 32 seconds.

When you stop holding the joy control, the unit repeats the newly selected dividing point.

- When you find the right position, go to the next step.
- If you want to cancel the dividing point, press CANCEL, then select the correct dividing point.

7 Press SET.



8 Press ENTER/DEMO to finish the editing procedure.

"EDITING" appears for a while, then "WRITING" flashes while the editing you have made is being recorded on the MD.

To join the divided tracks again, see the JOIN function.

JOIN Function

This function allows you to join two adjacent tracks into one track.

- To stop any time during editing process, press TITLE/EDIT.

1 Insert an MD you want to edit into the MD loading slot.

- It takes about 5 seconds for the unit to read the TOC (Table Of Contents) of the inserted MD. While the unit is reading it, you cannot go to the next step.

2 Press TITLE/EDIT.

The source is changed to "MD."

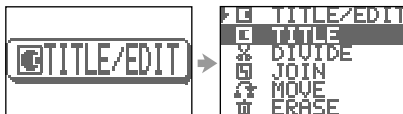

- If "JOIN" is not shown, you cannot join the tracks.

3 Push the joy control downward (∨) to select "JOIN" (highlighted), then press SET.



4 Push the joy control downward (∨) or upward (∧) to select the two adjacent tracks you want to join.



Ex. When you want to join tracks 2 and 3

5 Press SET.



- If you have selected wrong tracks, press CANCEL, then select the correct tracks.

6 Press ENTER/DEMO to finish the editing procedure.

"EDITING" appears for a while, then "WRITING" flashes while the editing you have made is being recorded on the MD.

To divide the joined tracks, see the DIVIDE function.



If "CANNOT JOIN" appears in step 5

You cannot join the following tracks.

- Tracks recorded using different recording length modes (LONG MODE — SP/LP2/LP4). (See page 33.)
- Digital-recording tracks and analog-recording tracks.
- Tracks recorded using monaural long recording method (not possible on this unit) and stereo-recording tracks.

MOVE Function

This function allows you to move a track to the position you prefer. It is useful to change the order of the tracks as you like.

- To stop any time during editing process, press TITLE/EDIT.

1 Insert an MD you want to edit into the MD loading slot.

- It takes about 5 seconds for the unit to read the TOC (Table Of Contents) of the inserted MD. While the unit is reading it, you cannot go to the next step.

2 Press TITLE/EDIT.

The source is changed to "MD."

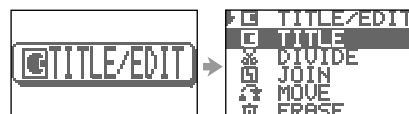

- If "MOVE" is not shown, you cannot move the track.

- 3** Push the joy control downward (∨) to select “MOVE” (highlighted), then press SET.

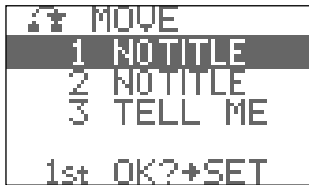

- 4** Push the joy control downward (∨) or upward (∧) to select the track you want to move.

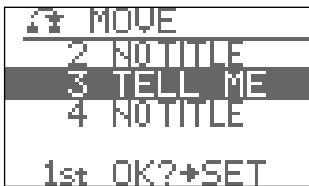

- 5** Press SET.

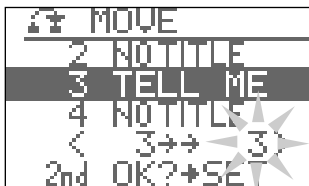

Ex. When you want to move track 3

- If you have selected a wrong track number, press CANCEL, then select the correct track number.

- 6** Push the joy control downward (∨) or upward (∧) to select the position where you want to move the track to.

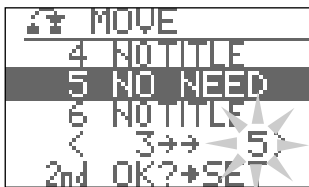

Ex. When you want to move to the track 5 position

- 7** Press SET.



- If you have selected wrong tracks, press CANCEL, then select the correct tracks by repeating from step 4.

- 8** Press ENTER/DEMO to finish the editing procedure.

“EDITING” appears for a while, then “WRITING” flashes while the editing you have made is being recorded on the MD.

ERASE Function

This function allows you to erase unwanted tracks.

- To stop any time during editing process, press TITLE/EDIT.

- 1** Insert an MD you want to edit into the MD loading slot.

- It takes about 5 seconds for the unit to read the TOC (Table Of Contents) of the inserted MD. While the unit is reading it, you cannot go to the next step.

- 2** Press TITLE/EDIT.

The source is changed to “MD.”

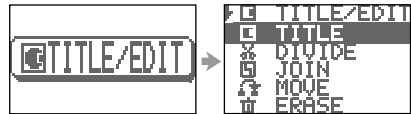

- 3** Push the joy control downward (∨) to select “ERASE” (highlighted), then press SET.

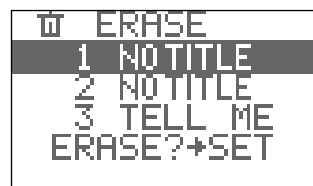

- 4** Push the joy control downward (∨) or upward (∧) to select the track you want to erase.

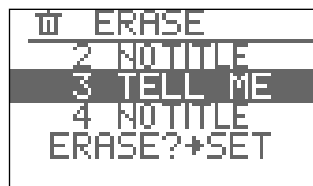

5 Press SET.

“✓” appears between track number and track title.
“✓” means the track in the same line will be erased when you finish the editing procedure.

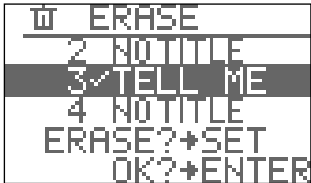

Ex. When you want to erase track 3

- If you have selected a wrong track number, press CANCEL, then select the correct track number.

6 Repeat step 4 and 5 to select all the tracks you want to erase.

- You can select up to 15 tracks.

7 Press ENTER/DEMO to finish selecting tracks.

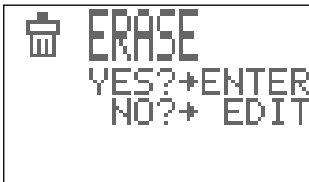

8 Press ENTER/DEMO again to finish the editing procedure.

“EDITING” appears for a while, then “WRITING” flashes while the editing you have made is being recorded on the MD.

ALL ERASE Function

This function allows you to erase all the tracks on an MD.

- To stop any time during editing process, press TITLE/EDIT.

1 Insert an MD you want to edit into the MD loading slot.

- It takes about 5 seconds for the unit to read the TOC (Table Of Contents) of the inserted MD. While the unit is reading it, you cannot go to the next step.

2 Press TITLE/EDIT.

The source is changed to “MD.”

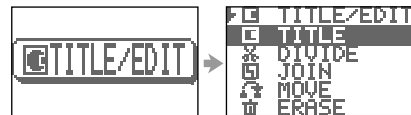

3 Push the joy control downward (✓) to select “ALL ERASE” (highlighted), then press SET.



4 Press ENTER/DEMO to finish the editing procedure.

“EDITING” appears for a while, then “WRITING” flashes while the editing you have made is being recorded on the MD.



Assigning Titles to an MD

You can assign a name to each MD and to each track using alphabetic characters (uppercase and lowercase), symbols and numerals. Once a title is assigned, it is displayed for your confirmation.

- You cannot edit titles composed of more than 61 characters.

About the number of characters inputted for an MD

The total number of characters that can be input for an MD is 1792, and the maximum number that can be input for each track is 61. (However, the actual number you can input may be slightly less than this maximum numbers due to the MD limitations – see page 67.)

- A space can be counted as one character.
- When the stereo long-hour recording (LP2 or LP4: see page 33) method is used for recording, the maximum number you can input for a track title automatically reduced since "LP:" and four spaces are automatically added to the beginning of the track title. Consequently this reduces the total number of characters you can input for an MD.

Example: You can input up to 10 characters for each track if an MD is composed of 120 tracks recorded using the stereo long-hour recording method.

On the unit:

In the following example, the process is explained from the very first — that is, inserting a disc. If you have already started recording or playing, start from step 2.

- To exit from the title entry screen any time during the process, press TITLE/EDIT.

1 Insert an MD you want to edit into the MD loading slot.

- It takes about 5 seconds for the unit to read the TOC (Table Of Contents) of the inserted MD. While the unit is reading it, you cannot go to the next step.

2 Press TITLE/EDIT.

The source is changed to "MD."

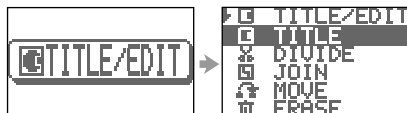

- If you press TITLE/EDIT while recording, **track title entry screen** of the current recording track appears in the main display → go to step 4.

3 Press SET.

The MD recorder enters one of the following title entry screen.

- Disc title entry screen:** appears when you press SET when the MD recorder stops.



- Track title entry screen:** appears when you press SET while playing or pausing.



Ex. While playing track 1

4 Push the joy control rightward (>) or leftward (<) to change the title entry mode.

- Title entry mode changes as follows:

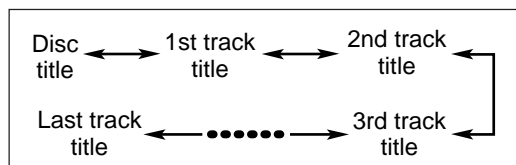

5 Press SET to enter the selected title entry mode.

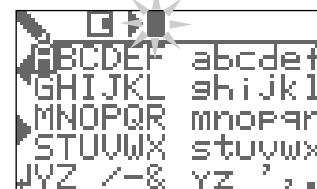

Ex. When entering a disc title

6 Select the character set you want.

- Push the joy control horizontally (</>) and vertically (∨/∧) to select "↓."

- Press SET.

- Each time you press the button, the character sets change as follows:

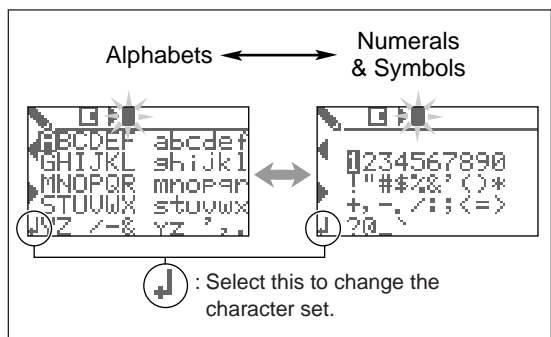

7 Input a character.

- Ex. When entering "H"

1) Push the joy control horizontally (</>) and vertically (∨/∧) until "H" is selected.

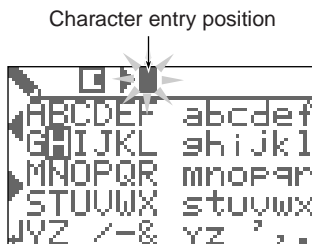

2) Press SET.

The selected character is entered, and the character entry position moves to the next.

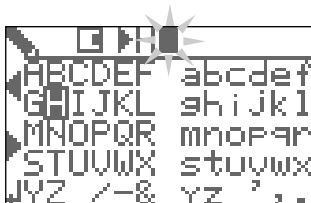

Character entry position

The diagram shows the same 4x6 grid of characters. A vertical bar is drawn over the characters. Arrows point to the bar from the text 'Blanks' below. Below the diagram are two bullet points explaining the function of the bar.

Blanks

- To change the character set, select this, and press SET.
- To move the character entry position while entering a title, select ► for moving it rightward and ◀ for moving it leftward, then press SET.
Each time you press SET, the character entry position moves.

- To enter a blank, select a blank in the main display, then press SET.
- If you have entered an incorrect character, press CANCEL to cancel the last entry.

8 Repeat steps 6 and 7 to enter other characters.

- The main display can only show 7 characters at a time. If you enter the 8th character, the first character disappears, and so on.

9 Press ENTER/DEMO to finish the current title entry.

The unit enters title entry mode again.

- You can assign another title by repeating steps 4 to 9.

10 Press TITLE/EDIT (or ENTER/DEMO again) to exit from the title entry mode.

11 Press ▲ for the MD recorder to eject the MD.

"WRITING" flashes while the editing you have made is being recorded on the MD.



You can assign titles during play or recording

• During play:

Entering a track title

The MD recorder repeats playback of the current track until you press ENTER/DEMO in step 9 above. When you press ENTER/DEMO, the next track will be played.

Entering a disc title

The MD recorder repeats playback of all tracks of the MD until you press ENTER/DEMO in step 9 above. When you press ENTER/DEMO, the MD recorder enters the track title entry mode.

• During recording:

Entering a track title

The MD recorder continues recording even after you press ENTER/DEMO in step 9 above. When you press ENTER/DEMO, a track title is assigned to the track where you have started the title entry. If you do not press ENTER/DEMO before recording ends, the track title assigned will be canceled.

• During CD Synchronized Recording (see page 35):

You can assign the disc title, and 16 track titles one after another as recording goes on. The track titles you have entered are automatically assigned to the tracks recorded on the MD in sequential order. If you enter 17th track title or more, they are ignored.



If "NO OPERATE!" appears

Operation you have tried to use is not acceptable. For example, you have tried to use the remote control while entering a title using the buttons on the unit. Use the buttons on the unit only.

Changing the Title

You can make a correction or change the title.

- 1** Follow steps 1 to 5 of page 46.
- 2** Select the character you want to correct, referring to step 7 on page 47.
 - Make sure that the character you want to change is flashing.
- 3** Press CANCEL to delete the character you have selected in the above step.
- 4** Input the correct character, referring to step 7 on page 47.
- 5** Repeat steps 2 to 4 of the current procedure to correct more characters.
- 6** Press ENTER/DEMO to finish correcting the title.
 - If you want to correct another title, select another title entry mode by pushing the joy control rightward (>) or leftward (<), press SET, then repeat from step 2 above.
 - If you want to finish the correction, go to the next step.
- 7** Press TITLE/EDIT (or ENTER/DEMO again) to exit from the title entry mode.
- 8** Press \blacktriangle for the MD recorder to eject the MD. "WRITING" flashes while the editing you have made is being recorded on the MD.

To erase all the characters

Press CANCEL repeatedly in step 3 above to erase all the characters, then go to step 6.

On the remote control:

In the following example, the process is explained from the very first — that is, inserting a disc. If you have already started recording or playing, start from step 2.

- To exit from the title entry screen any time during the process, press MD TITLE.

1 Insert an MD you want to edit into the MD loading slot.

- It takes about 5 seconds for the unit to read the TOC (Table Of Contents) of the inserted MD. While the unit is reading it, you cannot go to the next step.

2 Press MD TITLE.

The source is changed to "MD," and the MD recorder enters one of the following title entry screen.

- **Disc title entry screen:** appears when you press MD TITLE when the MD recorder stops.



- **Track title entry screen:** appears when you press MD TITLE while playing, pausing, or recording.

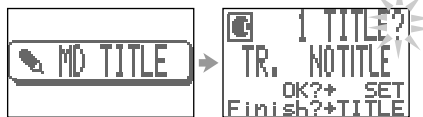

3 Press \leftarrow (10) or \rightarrow (+10) to change the title entry mode.

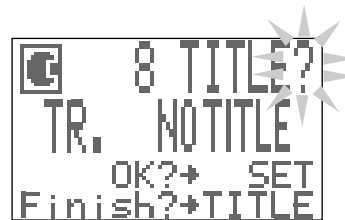

EX. When track 8 is selected

- Title entry mode changes as follows:

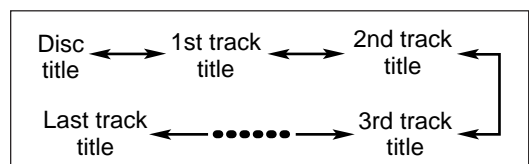

4 Press SET to enter the selected title entry mode.

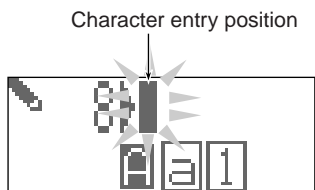

5 Press CHARACTER to select the character set you want.

- Each time you press the button, the character sets change as follows:

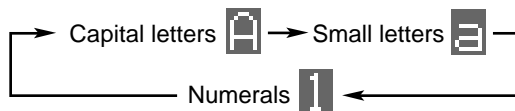

6 Input a character.

- 1) Press the character entry button for a character you want to input.

Examples:

- To input an "A" or "a," press ABC once.
To input a "B" or "b," press ABC twice.
To input a "C" or "c," press ABC three times.
- To input a symbol, press MARK repeatedly until the mark you want appears.
- To input a numeral, press 0 – 9.
- To move the character entry position while entering a title, press ← (10) or → (+10).
- To enter a space while entering a title, press → (+10) twice.
- If you have entered an incorrect character, press CANCEL to cancel the last entry.

- 2) Press the button for the next character you want to input.

- If the next character you want to input is assigned to the same button you have just pressed in step 6-1, press → (+10) first to move the character entry position to the right.

7 Repeat steps 5 and 6 to enter other characters.

- The main display can only show 8 characters at a time. If you enter the 9th character, the first character disappears, and so on.

8 Press ENTER to finish the current title entry.

The unit enters title entry mode again.

- You can assign another title by repeating steps 3 to 8.

9 Press MD TITLE (or ENTER again) to finish the title entry.

10 Press ▲ (on the unit) for the MD recorder to eject the MD.

"WRITING" flashes while the editing you have made is being recorded on the MD.



Available Symbols are as follows:

(Blank)	!	"	#	\$	%	&	'	()
*	+	,	-	.	/	:	;	< =
>	?	@	_	\				



You can assign titles during play or recording

• During play:

Entering a track title

The MD recorder repeats playback of the current track until you press ENTER in step 8 above. When you press ENTER, the next track will be played.

Entering a disc title

The MD recorder repeats playback of all tracks of the MD until you press ENTER in step 8 above. When you press ENTER, the MD recorder enters the track title entry mode.

• During recording:

Entering a track title

The MD recorder continues recording even after you press ENTER in step 8 above. When you press ENTER, a track title is assigned to the track where you have started the title entry. If you do not press ENTER before recording ends, the track title assigned will be canceled.

• During CD Synchronized Recording (see page 35):

You can assign the disc title, and 16 track titles one after another as recording goes on. The track titles you have entered are automatically assigned to the tracks recorded on the MD in sequential order. If you enter 17th track title or more, they are ignored.



If "NO OPERATE!" appears

Operation you have tried to use is not acceptable. For example, you have tried to use the buttons on the unit while entering a title using the remote control. Use the remote control only.

Changing the Title

You can make a correction or change the title.

- 1** Follow steps 1 to 4 of pages 48 and 49.
- 2** Press ← (10) or → (+10) to select the character you want to correct.
 - Make sure that the character you want to change is flashing.
- 3** Press CANCEL to delete the character you have selected in the above step.
- 4** Input the correct character by pressing one of the character entry buttons.
- 5** Repeat steps 2 to 4 of the current procedure to correct more characters.
- 6** Press ENTER to finish correcting the title.
 - If you want to correct another title, select another title entry mode by pressing ← (10) or → (+10), press SET, then repeat from step 2 above.
 - If you want to finish the correction, go to the next step.
- 7** Press MD TITLE (or ENTER again) to exit from the title entry mode.
- 8** Press ▲ (on the unit) for the MD recorder to eject the MD.

“WRITING” flashes while the editing you have made is being recorded on the MD.

To erase all the characters

Press CANCEL repeatedly in step 3 above to erase all the characters, then go to step 6.

Creating Your Own Opening and Ending Screens



When you turn on or off the unit, you can show your own screens instead of the HELLO and SEE YOU screens. To create your own opening and ending screens, follow the procedure below.

- You can register up to 26 characters for each screen.
- You have to use the menu for the following operations.

For general information on the menu, see pages 59 and 60.

On the unit ONLY:

- 1** Press ⏻/| to turn off the unit if it is on.

The STANDBY/ON lamp lights red.
- 2** Call up the Startup Display setting mode.
 - 1) Press MENU.
 - 2) Push the joy control downward (∨) to select “Startup Disp.” (highlighted), then press SET.
 - 3) Push the joy control downward (∨) or upward (∧) to select the screen you want to make, then press SET.

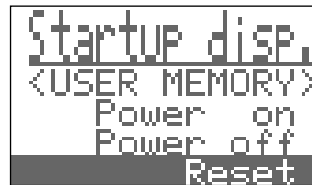

Power on : To make your own opening screen

Power off : To make your own ending screen

Reset : See “To erase your own screen” below.

- 3** Enter the message using the title entry procedure explained in step 7 on pages 47.
- 4** Press ENTER/DEMO to finish creating the screen.
- 5** Repeat steps 2 to 4 to create the other screen if you want.

To erase your own screen

Repeat the above procedure and in step 3, select “Reset.” “Startup disp. Reset!” appears in the main display, and your own screens are erased.

When you turn on and off the unit, the HELLO screen and the SEE YOU screen will appear.

- If you want to erase only one of the screens, erase all registered characters by inserting blanks.



When you unplug the AC power cord or if a power failure occurs

The registered screen messages will be erased.

Using the Timers

The buttons and controls enlarged in the illustration below are used and explained in this section (pages 51 to 57).

Main unit

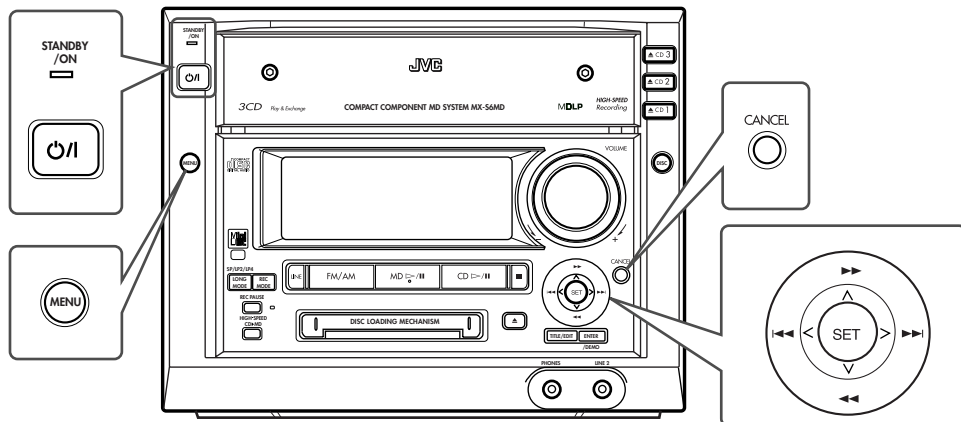

Remote control

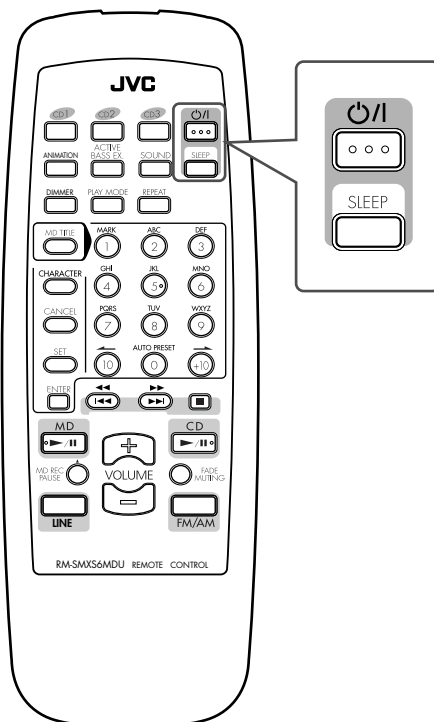

There are three timers available — Recording Timer, Daily Timer, and Sleep Timer.

Before using these timers, you need to set the clock built in the unit.

To set the clock, Recording Timer and Daily Timer, you have to use the menu. (See pages 59 and 60.)

Setting the Clock



You can set the clock whether the unit is turned on or in standby mode.

On the unit ONLY:

1 Press MENU.

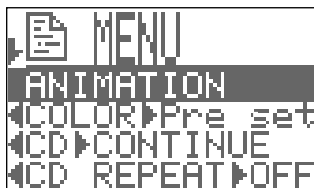

Ex. When the unit is turned on, and the source is CD (but not playing)

2 Push the joy control downward (∨) to select “CLOCK SET” (highlighted), then press SET.



The hour digit in the main display starts flashing.

3 Push and hold the joy control rightward (>) or leftward (<) to adjust the hour, then press SET.

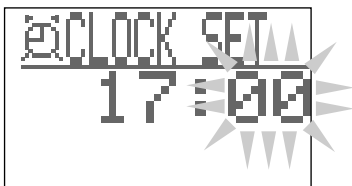

- If you want to correct the hour after pressing SET, press CANCEL. The hour digit starts flashing again.

4 Push and hold the joy control rightward (>) or leftward (<) to adjust the minute, then press SET. “ADJUST OK!” appears in the main display, and the built-in clock starts.



If there is a power failure

The clock loses the setting and is reset to “0:00.” You need to set the clock again.

To adjust the clock again

Once you have adjusted the clock, you cannot go to the clock setting directly on the menu.

To readjust the clock, follow the procedure below:

1 Press MENU.

2 Push the joy control downward (∨) to select “REC ON/OFF” (highlighted).

- If “REC ON/OFF” does not appear and “CLOCK SET” appears, the clock setting has been lost. (In this case, simply press SET in the following step.)

3 Push the joy control rightward (>) or leftward (<) to select “CLOCK SET,” then press SET.

The hour digit starts flashing, and now you can adjust the clock again, following steps **2** to **4** of “Setting the Clock” procedure to the left.

Using Recording Timer



With Recording Timer, you can make an unattended recording.

- You can set Recording Timer whether the unit is turned on or in the standby mode.
- To correct a mis-entry any time during the setting process, press CANCEL.
- To cancel the setting any time during the process, press MENU.

How Recording Timer actually works

The unit automatically turns on, turns off the volume, and starts recording on the MD when the timer-on time comes. Then, when the timer-off time comes, the unit automatically turns off (stands by).

Recording Timer works only once, but the timer settings remain stored in memory until you reset them or unplug the AC power cord.

On the unit ONLY:

1 Press MENU.



Ex. When the unit is turned on, and the source is CD (but not playing)

2 Push the joy control downward (∨) to select "REC ON/OFF" (highlighted).



- If you cannot select "REC ON/OFF," you have not finished setting the built-in clock. (See page 52.)

3 Call up the Recording Timer Setup screen.

1) Push the joy control rightward (>) or leftward (<) to select "REC SET UP."



- The items on the menu change as follows:

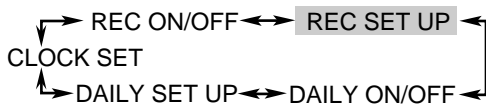

2) Press SET.

The timer (⌚) and REC indicators start flashing on the display.

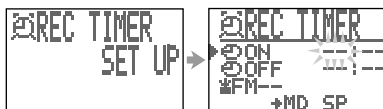

4 Push the joy control rightward (>) or leftward (<) to set the hour of the timer-on time, then press SET.

5 Push the joy control rightward (>) or leftward (<) to set the minute of the timer-on time, then press SET.

6 Push the joy control rightward (>) or leftward (<) to set the hour of the timer-off time, then press SET.

7 Push the joy control rightward (>) or leftward (<) to set the minute of the timer-off time, then press SET.

8 Push the joy control rightward (>) or leftward (<) to select the source.

- The source changes as follows:

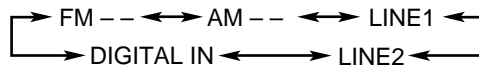

- FM --:** Tunes into an FM station.
→ Select a preset station (see below).
- AM --:** Tunes into an AM station.
→ Select a preset station (see below).
- LINE1*:** Selects the external equipment connected to the LINE 1 jacks.
- LINE2*:** Selects the external equipment connected to the LINE 2 jack.
- DIGITAL IN*:** Selects the external equipment connected to the DIGITAL IN terminal.

* To operate these equipment with the Recording Timer, they also need to have the timer function. If you have changed the source name, the changed name will appear.

9 If you have selected "FM --" or "AM --" as the source in the above step, select a preset number.

Push the joy control downward (∨) or upward (∧) to select a preset station, then press SET.

- If you press SET without selecting a preset station, the last received station will be tuned in when the timer recording starts.

If you have selected one of the external equipment as the source in the above step, simply press SET.

10 Push the joy control rightward (>) or leftward (<) to select the recording length mode.

- The recording length mode changes as follows:

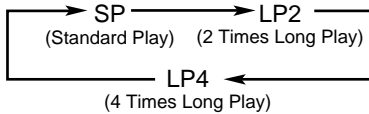

11 Press SET.

The timer (⌚) and REC indicators stop flashing, and remain lit.

12 Press ⏻/⏸ to turn off the unit (on standby) if necessary.

The STANDBY/ON lamp lights red.



Recording Timer will be canceled and the unit will not turn off automatically in the following.

- When you pause the recording.
- When you change the source after stopping the recording.
- When you enter the timer setting or clock setting mode.

To turn on or off Recording Timer after its setting is done

1 Press MENU.

2 Push the joy control downward (∨) to select “REC ON/OFF” (highlighted), then press SET.

The Recording Timer On/Off screen appears.



3 To turn off the Recording Timer, push the joy control downward (∨) to select “OFF” (highlighted), then press SET.

“REC TIMER OFF” appears for a while. The timer (⌚) and REC indicators go off from the display. The Recording Timer is canceled, but the setting for the Recording Timer remains in memory.

To turn on the Recording Timer, press SET (after making sure that “ON” is selected (highlighted) in the main display).

The timer (⌚) and REC indicators light on the display. The settings you have done are shown in the main display for your confirmation.

Using Daily Timer



With Daily Timer, you can wake up to your favorite music or radio program.

- You can set Daily Timer whether the unit is turned on or in standby mode.
- To correct a mis-entry any time during the setting process, press CANCEL.
- To cancel the setting any time during the process, press MENU.

How Daily Timer actually works

The unit automatically turns on, and starts playing the specified source when the timer-on time comes. Then, when the timer-off time comes, the unit automatically turns off (stands by).

Daily Timer works every day, and the timer settings remain stored in memory until you reset them or unplug the AC power cord.

On the unit ONLY:

1 Press MENU.



Ex. When the unit is turned on, and the source is CD (but not playing)

2 Push the joy control downward (∨) to select “REC ON/OFF” (highlighted).



- If you cannot select “REC ON/OFF,” you have not finished setting the built-in clock. (See page 52.)

3 Call up the Daily Timer Setup screen.

- 1) Push the joy control rightward (>) or leftward (<) to select "DAILY SET UP."

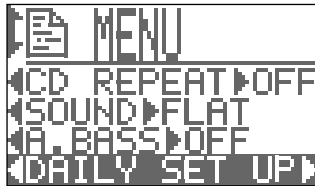

- The items on the menu change as follows:

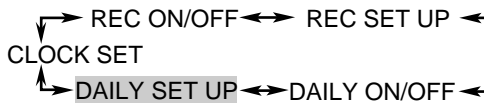

- 2) Press SET.
The timer (⌚) and DAILY indicators start flashing on the display.

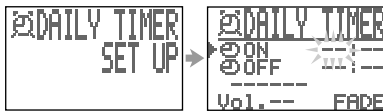

- 4 Push the joy control rightward (>) or leftward (<) to set the hour of the timer-on time, then press SET.

- 5 Push the joy control rightward (>) or leftward (<) to set the minute of the timer-on time, then press SET.

- 6 Push the joy control rightward (>) or leftward (<) to set the hour of the timer-off time, then press SET.

- 7 Push the joy control rightward (>) or leftward (<) to set the minute of the timer-off time, then press SET.

- 8 Push the joy control rightward (>) or leftward (<) to select the source.

- The source changes as follows:



- : Plays the source selected when the unit has been turned off.
- FM --: Tunes into an FM station.
→ go to step 9 to select a preset station.
- AM --: Tunes into an AM station.
→ go to step 9 to select a preset station.
- CD -: Plays a CD.
→ Prepare a CD, then go to step 9 to select the CD and starting track.
- MD ---: Plays an MD.
→ Prepare an MD, then go to step 9 to select the starting track.
- LINE1*: Selects the external equipment connected to the LINE 1 jacks.
- LINE2*: Selects the external equipment connected to the LINE 2 jack.
- DIGITAL IN*: Selects the external equipment connected to the DIGITAL IN terminal.

* To operate these equipment with the Daily Timer, they also need to have the timer function.
If you have changed the source name, the changed name will appear.

9 If you have selected "FM --" or "AM --" as the source in the above step, select a preset station.

Push the joy control downward (∨) or upward (∧) to select a preset station, then press SET.

- If you press SET without selecting a preset station, the last received station will be tuned in when the unit is turned on with the Daily Timer.

If you have selected "CD --" as the source in the above step, select a disc number and a track number.

- 1) Push the joy control downward (∨) or upward (∧) to select the disc number (CD 1 to CD 3), then press SET.
- 2) Push the joy control downward (∨) or upward (∧) to select a track number, then press SET.

- If you press SET without selecting a disc number, the last selected disc will be played back when the unit is turned on with the Daily Timer.
- If you press SET without selecting a track number, playback starts from the first track of the selected disc when the unit is turned on with the Daily Timer.

If you have selected “MD --” as the source in the above step, select a track number.

Push the joy control downward (∨) or upward (∧) to select a track number, then press SET.

- If you press SET without selecting a track number, the first track starts playing when the unit is turned on with the Daily Timer.

If you have selected one of the external equipment as the source in the above step, simply press SET.**10 Push the joy control rightward (>) or leftward (<) to adjust the volume level.**

- You can adjust the volume level within the range of 0 (silent) to 50 (maximum).

- “--” can be selected if you set the timer while the unit is turned on. The volume is set to the current volume level.

11 Push the joy control downward (∨) or upward (∧) to select volume fade-in mode — “FADE” or “NoFADE.”

- FADE :** Volume fades in (gradually becomes louder and is set to the specified level).
- NoFADE :** No fade-in effect. Volume is set to the specified level when the timer-on time comes.

12 Press SET.

The timer (⌚) and DAILY indicators stop flashing and remains lit.

13 Press ⏻/⏷ to turn off the unit (on standby) if you have set the timer with the unit turned on.

The STANDBY/ON lamp lights red.

To turn on or off Daily Timer after its setting is done

- 1 Press MENU.
- 2 Push the joy control downward (∨) to select “REC ON/OFF” (highlighted).
- 3 Push the joy control rightward (>) or leftward (<) to select “DAILY ON/OFF” (highlighted), then press SET.

The Daily Timer On/Off screen appears.



- 4 To turn off the Daily Timer, push the joy control downward (∨) to select “OFF” (highlighted), then press SET.

“DAILY TIMER OFF” appears for a while. The timer (⌚) and DAILY indicators go off from the display. The Daily Timer is canceled, but the setting for the Daily Timer remains in memory.

To turn on the Daily Timer, press SET (after making sure that “ON” is selected (highlighted) in the main display).

The timer (⌚) and DAILY indicators light on the display. The settings you have done are shown in the main display for your confirmation.



If the unit is kept turned on when the timer-on time comes

Daily Timer does not work at all.



Daily Timer will be canceled and the unit will not turn off automatically in the following.

- When you change the source.
- When you try to start recording.
- When you enter the MD editing or title entry mode.
- When you enter the timer setting or clock setting mode.

Using Sleep Timer

With Sleep Timer, you can fall asleep to your favorite music.

You can set Sleep Timer when the unit is turned on.

How Sleep Timer actually works

The unit automatically turns off after the specified time length passes.

On the remote control ONLY:

1 Press SLEEP.



- Each time you press the button, the time length changes as follows:

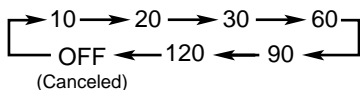

2 Wait for about 4 seconds after specifying the time length.

The display window dims.

To check the remaining time until the shut-off time, press SLEEP once. The remaining time until the shut-off time appears for about 4 seconds.

To change the shut-off time, press SLEEP repeatedly until the time length you want appears.

To cancel the setting, press SLEEP repeatedly until "SLEEP OFF" appears in the main display.



Sleep Timer will be also canceled in the following cases

- When you turn off the unit.
- When you operate other timer settings.
- When you adjust the clock.



You can use the Auto-Power Off function through the menu to turn off the unit automatically. See "Auto Power Off Setting" on page 64.

To sleep with the Sleep Timer and wake up with the Daily Timer

The unit turns off when the shut-off time comes (set by the Sleep Timer), and turns on when the timer-on time (set by the Daily Timer) comes.

- 1 Set the Daily Timer as explained on pages 54 to 56.
- 2 Start playing back any source you want to listen to before sleep.
- 3 Set the Sleep Timer.

Timer Priority

Since each timer can be set separately, you may wonder what happens if the setting for these timers overlaps. Here are the priorities for each timer.

• A timer with the late timer-on time has priority.

If Recording Timer is set to come on while Daily Timer is operating, Daily Timer is canceled.

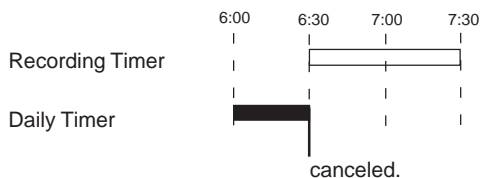

If Recording Timer is set to come on while Sleep Timer is operating, Sleep Timer will not shut off the power even if the shut-off time comes.

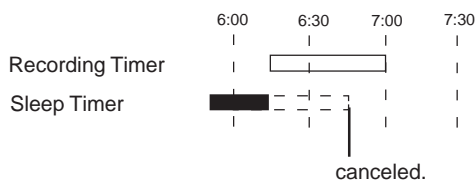

Using the Other Convenient Functions

The buttons and controls enlarged in the illustration below are used and explained in this section (pages 58 to 64).

Main unit

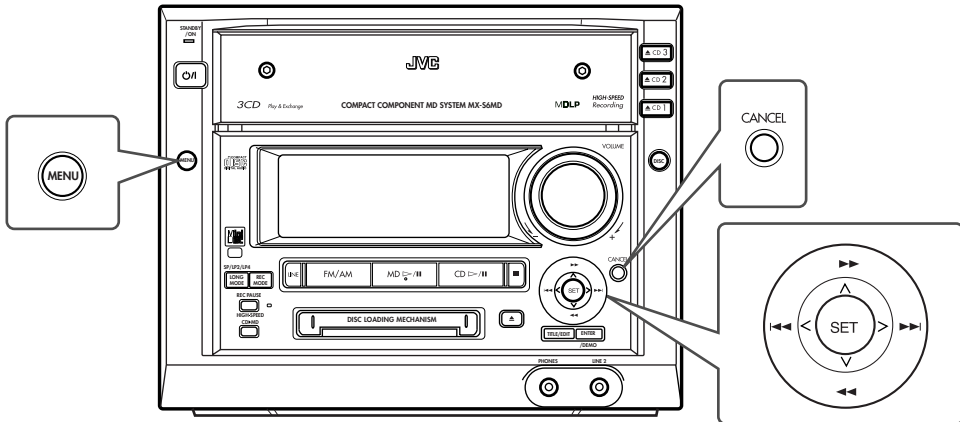

You cannot use the remote control for the menu operations explained in this section. Use only buttons on the unit.

About the menu screen

Arrows indicate the direction (up/down) you can move on the menu screen. (In this example, you can only move down.)

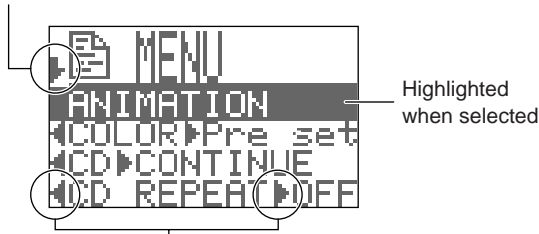

- These triangles indicate that you can select a mode or move to another setting by pushing the joy control rightward (>) or leftward (<).
- Items with no triangles indicate that you can move to their setting screens by pressing SET. (In this example, "ANIMATION")

Ex. This menu appears when the source is CD (with the unit turned on, but not playing)

The following functions are selected and operated through the menu screens.

- Menu you can see on the screen vary according to the operating condition of the unit.

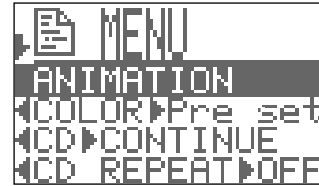

Ex. This menu appears when the source is CD (with the unit turned on, but not playing)

- **Clock Setting** — CLOCK SET (see page 52)
Appears only when the clock has not been set. Once it has been adjusted, it appears in the timer setting mode.
- **Timer Setting** (see pages 52 – 56)
 - Recording Timer Setup**
— REC SET UP (see page 52)
 - Recording Timer On/Off Setting**
— REC ON/OFF (see page 54)
 - Daily Timer Setup**
— DAILY SET UP (see page 54)
 - Daily Timer On/Off Setting**
— DAILY ON/OFF (see page 56)
 - Clock Readjustment Setting**
— CLOCK SET (see page 52)
- **Sound Setting**
 - Sound Mode Setting** — SOUND
Appears only when the unit is turned on.
 - Active Bass Extension On/Off** — A. BASS
Appears only when the unit is turned on.
- **FM Reception Mode Setting** — FM MODE
Appears only when the unit is turned on, and the source is FM.

Buttons you use to operate the menu

MENU



- Press to show the menu in the main display when the menu is not shown.
- Press to cancel the menu operation when the menu is shown.

Joy control

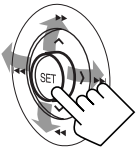

- Push downward (∨) or upward (∧) to select the functions on the menu.
- Push the joy control rightward (>) or leftward (<) to select a proper setting after selecting the function on the menu, or to move to another setting mode.

SET

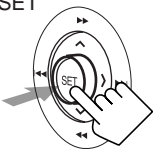

- Press to finish the setting or to move to another setting mode.

CANCEL



- Press to cancel the menu operation.
- Press to go back to the previous step while setting clock or timers.

- **CD and MD Playback Mode Setting**

- **CD playback mode setting** — CD

- Appears only when the unit is turned on, and the source is CD, but not playing.

- **CD repeat mode setting** — CD REPEAT

- Appears only when the unit is turned on, and the source is CD.

- **MD playback mode setting** — MD

- Appears only when the unit is turned on, and the source is MD, but not playing.

- **MD repeat mode setting** — MD REPEAT

- Appears only when the unit is turned on, and the source is MD.

- **Display Setting**

- **Animation Selection** — ANIMATION

- **Display Color Selection** — COLOR

- **Display Pattern Selection** — DISP

- **Contrast Adjustment** — CONTRAST ADJ.

- Appears only when the unit is turned on.

- **Startup Display Setting**

- — Startup Disp. (see page 50)

- Appears only when the unit is turned off.

- **External Source Setting**

- **Input Level Adjustment** — INPUT Level

- Appears only when the unit is turned on, and the external equipment connected to the LINE 1 jacks or to the LINE 2 jack is selected as the source.

- **Source Name Change** — NAME CHANGE

- Appears only when the unit is turned on, and the external equipment is selected as the source.

- **Auto-Power Off Setting** — A. P. off

- Appears only when the unit is turned on.

Sound Setting

Selecting the sound modes

You can select one of the 6 preset sound modes (3 surround modes and 3 SEA – Sound Effect Amplifier – modes) and 1 manual mode.

1 Press MENU.

- The menu screen appears in the main display.

2 Push the joy control downward (∨) to select “SOUND” (highlighted).

3 Push the joy control rightward (>) or leftward (<) to select a sound mode you want.

- The sound modes change as follows:

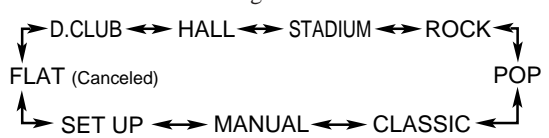

- See pages 15 and 16 for details.

4 Press SET to finish the setting.

Reinforcing the Bass Sound

The richness and fullness of the bass sound is maintained regardless of how low you set the volume — Active Bass Extension.

1 Press MENU.

- The menu screen appears in the main display.

2 Push the joy control downward (∨) to select “A. BASS” (highlighted).

3 Push the joy control rightward (>) or leftward (<) to turn “ON” or “OFF” the Active Bass Extension.

- See page 12 for details.

4 Press SET to finish the setting.

FM Reception Mode Setting

When an FM stereo broadcast is hard to receive or noisy, you can change the FM reception mode to "MONO" so that reception improves.

1 Press MENU.

The menu screen appears in the main display.

- If the current source is not "FM," you cannot go to the next step.

2 Push the joy control downward (∨) to select "FM MODE (current play mode setting*)." * The current play mode — AUTO or MONO will appear following "FM MODE."

* The current play mode — AUTO or MONO will appear following "FM MODE."

3 Push the joy control rightward (>) or leftward (<) to select the FM reception mode you want.

- AUTO :** Normally select this.
In this mode, you can hear stereo sound when a program is broadcast in stereo. In addition, static noise between stations will be erased while tuning.
- MONO :** Select this when an FM stereo broadcast is hard to receive or noisy. Reception improves though stereo effect is lost.

4 Press SET to finish the setting.

CD and MD Playback Mode Setting

Selecting the playback modes

When the source is "CD" or "MD," and playback has not been started, you can change its playback modes through the menu.

1 Press MENU.

The menu screen appears in the main display.

- If the current source is not "CD" or "MD," or if CD or MD play has been started, you cannot go to the next step.

2 Push the joy control downward (∨) to select "CD REPEAT (current repeat mode setting*)" or "MD REPEAT (current play mode setting*)." * The current repeat mode will appear following "CD REPEAT" or "MD REPEAT."

* The current repeat mode will appear following "CD" or "MD."

3 Push the joy control rightward (>) or leftward (<) to select the play mode you want.

- The playback modes change as follows:
When the source is "CD"



- See pages 23 and 24 for details.

When the source is "MD"

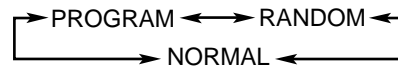

- See pages 28 and 30 for details.

4 Press SET to finish the setting.

Setting the repeat modes

When the source is "CD" or "MD," you can change its repeat modes through the menu.

1 Press MENU.

The menu screen appears in the main display.

- If the current source is not "CD" or "MD," you cannot go to the next step.

2 Push the joy control downward (∨) to select "CD REPEAT (current repeat mode setting*)" or "MD REPEAT (current repeat mode setting*)." * The current repeat mode will appear following "CD REPEAT" or "MD REPEAT."

* The current repeat mode will appear following "CD REPEAT" or "MD REPEAT."

3 Push the joy control rightward (>) or leftward (<) to select the play mode you want.

- The repeat modes change as follows:
When the source is "CD"



- * "1CD" is not used for Program play and Random play.

- See page 25 for details.

When the source is "MD"



- See page 30 for details.

4 Press SET to finish the setting.

Display Setting

Selecting the animation character

- 1** Press **MENU**.
The menu screen appears in the main display.
- 2** Make sure that **“ANIMATION”** is selected (highlighted), then press **SET**.
- 3** Push the joy control downward (∨) — or upward (∧) — to select the animation character or the level meter you want.
 - See page 14 for details.
- 4** Press **SET** to finish the setting.

Selecting the display color

When you change the display color, the illumination color of the ring around the VOLUME control also changes.

- 1** Press **MENU**.
The menu screen appears in the main display.
- 2** Push the joy control downward (∨) to select **“COLOR (current display color setting*)”**.
* The current display color setting will appear following **“COLOR.”**
- 3** Push the joy control rightward (>) or leftward (<) to select the display color you want.
 - The display color changes as follows:

Pre set ∟ Blue ∟ White ∟ Purple ∟ Orange ∟
L. Blue (Light Blue) ∟ Yellow ∟ Green ∟
Pink ∟ Random* ∟ Manual1** ∟
Manual2** ∟ Set up*** ∟
(back to the beginning)

- * When you select **“Random,”** the display color changes according to the playback sound.
- ** When you select **“Manual1”** or **“Manual2,”** the display color changes to your own color stored in memory.
- *** When you select **“Set up,”** you can create and store your own colors into **“Manual1”** and **“Manual2.”** (See **“Creating your own display colors”** on the next column.)

- 4** Press **SET** to finish the setting.



More on the display color

- The colors shown in the display cannot be always reproduced precisely. Due to the circumstances (room temperature, etc.) where the unit is used, colors may vary slightly.
- When you change the color of the main display, the display may seem to move back and forth; this is a characteristic of this unit and is not a malfunction.
- When a strong light strikes the display, the display happens to become dark, but this is not a malfunction.

Creating your own display colors

You can select one color from among 24 colors and store it into each of **“Manual 1”** and **“Manual 2.”**

- 1** Press **MENU**.
The menu screen appears in the main display.
- 2** Push the joy control downward (∨) to select **“COLOR (current display color setting*)”**.
* The current display color setting will appear following **“COLOR.”**
- 3** Push the joy control rightward (>) or leftward (<) to select **“Set up”** as color setting, then press **SET**.

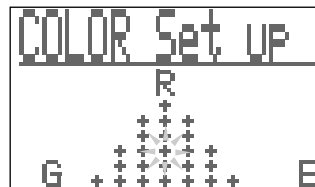

- 4** Push the joy control horizontally (</>) and vertically (∨/∧) to select the color setting.
 - You can select one of 24 colors (+ marks in the main display).

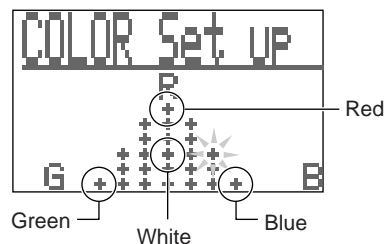

5 Press SET.



6 Push the joy control downward (∨) — or upward (∧) — to select either “Manual 1” or “Manual 2” in which you want to store the setting.

7 Press SET to finish the setting.

Selecting the display pattern

You can change the display pattern either to positive pattern or to negative pattern.

1 Press MENU.

The menu screen appears in the main display.

2 Push the joy control downward (∨) to select “DISP (current display pattern setting*).”

* The current display pattern setting will appear following “DISP.”

3 Push the joy control rightward (>) or leftward (<) to select either “Nega” or “Posi.”

Nega : Letters and animation characters are shown in color. (Initial setting when shipped from the factory)

Posi : Background other than letters and animation characters is shown in color, and letters and level meters look like being shown in black.

4 Press SET to finish the setting.

Adjusting the display contrast

You can change the display contrast only when the unit is turned on.

- There is a time limit in doing the following steps. If the setting is canceled before you finish, start from step 1 again.

1 Press MENU.

The menu screen appears in the main display.

2 Push the joy control downward (∨) to select “CONTRAST ADJ.,” then press SET.

- When shipped from the factory, contrast level is set to +40.



3 Push and hold the joy control upward (∧) or downward (∨) to adjust the contrast.

- You adjust the contrast within the range of +25 to +64.

4 Press SET to finish the adjustment.



notes If you cannot see any indications on the display The display contrast is too light. If this happens, unplug the AC power cord and plug it again. The contrast will be reset to the initial setting when shipped from the factory.

External Source Setting

Selecting the sound input level

This is only used for recording from analog sources (ex. tape, VCR, or portable MD player) connected to the LINE 1 jacks and to the LINE 2 jack.

If the recorded sound from such an analog source is not loud enough, or if it is distorted, select the appropriate sound input level before recording.

- When the input level is too loud during recording, the display turns red, the OVER indicator lights, and “Level OVER!” appears.
- You cannot adjust the input level while recording.

1 Press MENU.

The menu screen appears in the main display.

- If the current source is not the external equipment connected to the LINE 1 jacks or to the LINE 2 jack, you cannot go to the next step.

2 Push the joy control downward (∨) to select “INPUT Level,” then press SET.



Ex. When the source is the external equipment connected to the LINE 1 jacks

3 Push the joy control downward (∨) — or upward (∧) — to select the input level

- When the source is the equipment connected to the LINE 1 jacks:

Level 1 : Select when the recorded sound is not loud enough. This setting increases the input signal level. (Initial setting when shipped from the factory)

Level 2: Select when the recorded sound is distorted. This setting reduces the input signal level.

- When the source is the equipment connected to the LINE 2 jack:

Level 1 : Initial setting when shipped from the factory

Level 2: Select when the recorded sound is distorted with “Level 1” selected.

Level 3: Select when the recorded sound is still distorted with “Level 2” selected.

Level 4: Select when the recorded sound is still distorted with “Level 3” selected.

- If “Level OVER!” still appears even after setting the input level to “Level 4,” reconnect the equipment to the LINE 1 jacks, and set the input level to “Level 2.”

4 Press SET to finish the setting.

Changing the source name

You can change the external source names (LINE1, LINE2, and DIGITAL IN) to the actual component names.

- You cannot change the external source names while recording its sound on an MD.

1 Press MENU.

The menu screen appears in the main display.

- If the current source is not the external equipment connected, you cannot go to the next step.

2 Push the joy control downward (∨) to select “NAME CHANGE,” then press SET.



Ex. When the source is the external equipment connected to the LINE 1 jacks

3 Push the joy control downward (∨) — or upward (∧) — to select the source name.

- When the source is the external equipment connected to the LINE 1 jacks:

You can select from “LINE1” (Initial setting), “TAPE,” “DBS,” “VCR,” “TV,” and “GAME.”

- When the source is the equipment connected to the LINE 2 jack:

You can select from “LINE2” (Initial setting) and “P-MD” (portable MD player).

- When the source is the equipment connected to the DIGITAL IN terminal:

You can select from “DIGITAL IN” (Initial setting) and “DBS-DIGITAL.”

4 Press SET to finish the setting.

Auto Power Off Setting

Auto Power Off function automatically turns off the unit if no sound comes in for more than 3 minutes.

If any operation is done during this 3-minute period, Auto Power Off function is canceled temporarily even though no sound comes in.

1 Press MENU.

The menu screen appears in the main display.

- If the unit is turned off, you cannot go to the next step.

2 Push the joy control downward (∨) to select “A.P.off (current setting*)”

* The current setting will appear following “A.P.off.”

3 Push the joy control rightward (>) or leftward (<) to select either “SET” or “CANCEL.”

SET : Activates the Auto Power Off function.

CANCEL : Cancels the Auto Power Off function.

4 Press SET to finish the setting.

When Auto Power Off function is activated, the A.P.off indicator lights on the display.

The A.P.off indicator starts flashing if no sound comes in.

When the remaining time until the shut-off time becomes 20 seconds, it will be shown in the main display.

Maintenance

To get the best performance of the unit, keep your discs and mechanism clean.

General Notes

In general, you will have the best performance by keeping your CDs, MDs and the mechanism clean.

- Store CDs and MDs in their cases, and keep them in cabinets or on shelves.
- Keep the CD trays, and the MD loading slot cover closed when not in use.

Handling CDs



- Remove the CD from its case by holding it at the edge while pressing the center hole lightly.
- Do not touch the shiny surface of the disc, or bend the CD.
- Put the CD back in its case after use to prevent warping.

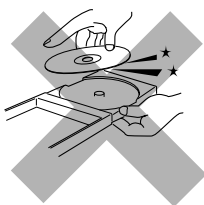

- Be careful not to scratch the surface of the CD when placing it back in its case.
- Avoid exposure to direct sunlight, temperature extremes, and moisture.

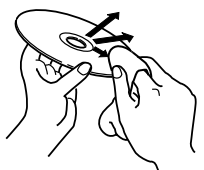

To clean the CD

Wipe the CD with a soft cloth in a straight line from center to edge.



DO NOT use any solvent — such as conventional record cleaner, spray, thinner, or benzine — to clean the CD.

Handling MDs

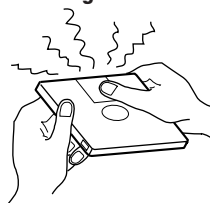

- Do not open the shutter.
 - The shutter is locked so that it will not open. Trying to force it open will break the MD. If the shutter opens accidentally, close it again quickly without touching the MD inside.

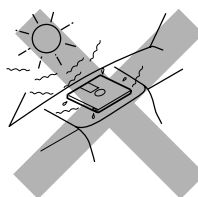

- Do not place MDs in the following places:
 - High temperature areas such as in direct sunlight or inside a car.
 - High humidity areas, e.g. in a bathroom.
 - On a beach or sandy area.

- Clean MDs regularly.
 - If dust or dirt gets on cartridge, wipe it off with a soft dry cloth.

MD Disc Types

There are two types of MDs: Premastered (prerecorded) and Recordable (blank).

Premastered MDs

Premastered MDs, which have been recorded at music studio, can be played back like regular CDs. On an MD of this type, data is recorded as the presence or absence of tiny pits. A laser beam focuses on the pits on the surface of the MD and reflects the detection back to the lens in the MD recorder. The MD recorder then decodes the signals and plays them back as music. This type of MD is called an "optical disc."

Recordable MDs

Recordable MDs, which use magneto-optical technology, can be recorded and played back repeatedly. The laser inside the MD recorder applies heat to the MD, demagnetizing the magnetic layer of the MD for recording and playback. This type of MD is called an "magnetic-optical disc."

ATRAC (Adaptive Transform Acoustic Coding)/ATRAC3 (MDLP)

The MD provides 80 minute recording and playback time, much more than an audio CD, but in a diameter of only 64 mm. This ability to store such a large amount of data is the result of ATRAC, an audio compression technique developed for MD. This technology cuts out faint sounds that would not be heard by the human beings. This technology, based on human sensitivity to sounds, reduces recorded data volume up to about one-fifth of the original data volume.

Furthermore, this unit takes advantage of the latest ATRAC3 techniques, which can reduce the amount of data to record to one-10th or one-20th of the original data volume. This allows for 2 times or 4 times long-hour stereo recording on this unit.

UTOC (User Table Of Contents)

Found only on recordable MDs, this area contains sub-data (track number, recording data, etc.) which can be rewritten by the user.

UTOC enables us to search tracks quickly and edit tracks on the MD.

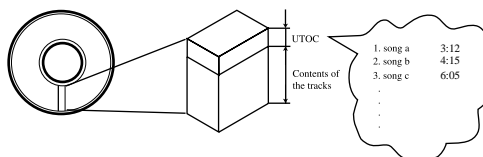

Sound Skip Guard Memory

The biggest weakness of discs is their susceptibility to vibration. The "Sound Skip Guard Memory" has been developed to cope with this weakness.

With this function, a few seconds of signals read by the optical read head from the MD are first stored in memory before being reproduced as audio signals. Thus, even when vibration or shock interrupts signals being read, these stored signals can continue to reproduce sounds for the few seconds. Thus, the user will enjoy uninterrupted music.

Normally....

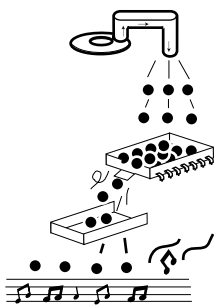

When "vibrated"....

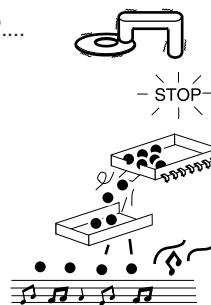

SCMS (Serial Copy Management System)

The MD recorder integrated to this unit uses the Serial Copy Management System which allows only first-generation digital copies to be made of premastered software (like CDs or prerecorded MDs).

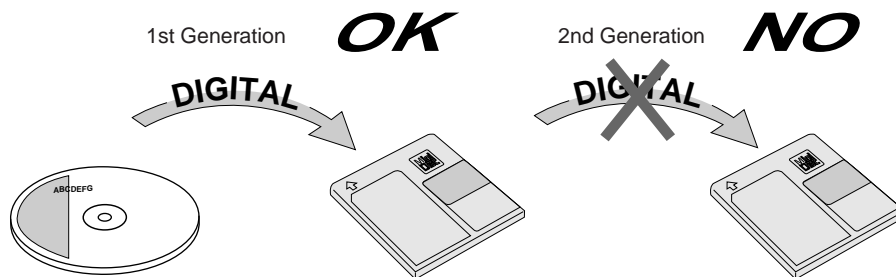

HCMS (High-speed Copy Management System)

Now onto recordable MDs (minidisks), you can record (copy) sound at a recording speed exceeding the normal speed. This fact requires some restrictions for protecting copyrights.

On this unit, you cannot re-record, at either high speed or normal speed, a song (track) that has been recorded once from a CD at high speed, until 74 minutes elapse after the first recording of the song started.

For example, after having recorded the first song (track) of a CD at high speed, you cannot record it again, at either high speed or normal speed, until 74 minutes elapse after the first recording of that song started.

MD limitations

The MD records data in an original format that differs from that of conventional cassette tapes or DATs. Since there are some limitations with this recording format, the following types of symptoms may occur. These symptoms are not malfunctions.

Symptoms	Cause
“DISC FULL” appears, even though there is still enough remaining time on an MD.	There is a maximum number of tracks which can be recorded, regardless of recording time. More than 254 tracks cannot be recorded on an MD.
“DISC FULL” appears, even though the number of tracks and recording time do not reach the limit.	<ul style="list-style-type: none"> Repeating erasure and recording on the same MD creates many blank portions sparsely on the MD. When recording on such an MD, a track is recorded on these blank portions sparsely. If a track is divided and recorded into so many portions, “DISC FULL” appears. If a divided portion of less than 8 seconds is made while a track is recorded on the MD, that track cannot be joined to another track using the JOIN function. Furthermore, if that track is erased, the remaining time of the MD may not increase exactly by the erased amount. If a track has been divided into many portions while being recorded on the MD, sounds will drop out while fast forwarding or reversing such an MD.
The JOIN function sometimes does not work.	
The remaining time on the MD does not increase even when tracks are erased.	
The sound drops out during fast forward or fast reverse.	
The amount of recorded time on the MD added to the amount of remaining time is shorter than the MD’s total possible recording time.	You cannot record on a blank portion of less than 2 seconds in the MD. For this reason, the actual recording time of discs may become shorter.

MD Messages

Message	Signification	Solution
BLANK DISC	The disc is blank.	Change the MD with another if you want to enjoy playback.
CANNOT JOIN	You are trying to join tracks which cannot be joined.	This is not a malfunction. (See “MD limitations” on pages 42 and 67.)
CANNOT LISTEN!	You are trying to listen to the sound during high-speed recording.	This is not a malfunction. You cannot listen to the sound during high-speed recording.
DISC ERROR	There is a problem with the MD.	Change the MD.
DISC FULL	There is no more space on the MD or there are over 254 tracks.	Use another recordable MD or erase some tracks.
EMERGENCY STOP	A malfunction has occurred during recording.	Stop playback, and eject the MD and re-insert it.
HCMS CANNOT COPY	You are trying to re-record a song that has been recorded once at high speed, before 74 minutes have passed after its first recording.	An internal timer works to protect copyrights. Wait for 74 minutes or more, then start recording.
MD LOAD ERROR	MD is not loaded correctly.	Eject the MD and re-insert it.
MD NO DISC	There is no MD.	Put an MD.
NON-AUDIO CANNOT COPY	You are trying to copy a non-audio disc like a CD-ROM, Video CD, or DVD.	Stop recording.
PLAYBACK DISC	You are trying to edit or record on a playback-only MD.	Use a recordable MD.
DISC PROTECTED	MD is write-protected.	Unprotect the MD or use another. (See page 32.)
SCMS CANNOT COPY	Digital copy of the 2nd generation is prohibited.	Use the external equipment connected to either the LINE 1 jacks (as the recording/playback device) or the LINE 2 jack (as the playback device).

Troubleshooting

If you are having a problem with your unit, check this list for a possible solution before calling for service.

If you cannot solve the problem from the hints given here, or the unit has been physically damaged, call a qualified person, such as your dealer, for service.

Symptom	Possible Cause	Action
No sound is heard.	Connections are incorrect, or loose.	Check all connections and make corrections. (See pages 6 – 9.)
Unable to record on an MD.	<ul style="list-style-type: none"> You are using a prerecorded MD. The MD is write-protected. 	<ul style="list-style-type: none"> Change it with a recordable MD. Unprotect the MD. (See page 32.)
Poor radio reception.	<ul style="list-style-type: none"> The antenna is not connected correctly. The AM loop antenna is too close to the unit. The FM antenna is not properly extended and positioned. 	<ul style="list-style-type: none"> Reconnect the antenna securely. Change the position and direction of the AM loop antenna. Extend FM antenna to the best reception position.
Unable to operate the remote control.	<ul style="list-style-type: none"> The path between the remote control and the remote sensor on the unit is blocked. The batteries have lost their charge. You are using the remote control far from the main unit. 	<ul style="list-style-type: none"> Remove the obstruction. Replace the batteries. (See page 9.) Signals cannot reach the remote sensor. Move close to the main unit.
Loaded CDs and MD cannot be ejected.	<ul style="list-style-type: none"> The main AC power cord is not plugged in. The Disc Lock function is in use. 	<ul style="list-style-type: none"> Plug in the AC power plug. Turn off the Disc Lock function. (See page 25.)
The CD does not play.	The CD is upside down.	Put the CD in with the label side up.
The CD skips.	The CD is dirty or scratched.	Clean or replace the CD. (See page 65.)
If “DIGITAL IN UNLOCK” appears in the main display.	There is no digital device connected to the DIGITAL IN terminal.	Connect a digital device using digital optical cord. (See page 8.)
If “NO OPERATE!” appears in the main display.	Operation you have done is not acceptable. For example, you are trying to use both the remote control, and the buttons and controls on the unit while entering disc or track titles.	Follow the correct procedure explained in this manual.
If “CAUTION!” appears in the main display.	Something is wrong with your unit.	Unplug the unit immediately, then consult your dealer.
The display suddenly becomes dark.	This happens because a strong light strikes the display.	Avoid exposing the unit to a strong light.
Operations are disabled.	The built-in microprocessor has malfunctioned due to external electrical interference.	Press CANCEL and DISC on the unit at the same time to reset the microprocessor, or unplug the unit then plug it back in.

Specifications

Amplifier

Output Power (IEC 268-3/DIN):

19 W per channel, min. RMS, both channels driven into 6 Ω at 1 kHz, with no more than 0.9% total harmonic distortion

Audio input sensitivity/Impedance (at 1 kHz)

Analog input:

LINE 1: 190 mV/47 k Ω (at "INPUT Level 1")
500 mV/47 k Ω (at "INPUT Level 2")

LINE 2: 45 mV/47 k Ω (at "INPUT Level 1")
55 mV/47 k Ω (at "INPUT Level 2")
110 mV/47 k Ω (at "INPUT Level 3")
290 mV/47 k Ω (at "INPUT Level 4")

Digital input:

DIGITAL IN: Optical

Signal wave length: 660 nm
Input level: -23 dBm to -15 dBm
(With the built-in sampling rate converter, corresponding to 32 kHz/44.1 kHz/48 kHz)

Audio output level/Impedance (at 1 kHz)

LINE 1: 150 mV/3.9 k Ω

Speakers/Impedance: 6 Ω – 16 Ω

Tuner

FM tuning range: 87.50 MHz — 108.00 MHz

AM tuning range:

531 kHz — 1 602 kHz
(at 9 kHz channel spacing)

530 kHz — 1 710 kHz
(at 10 kHz channel spacing)

CD player

CD Capacity: 3 CDs

Dynamic range: 92 dB

Signal-to-noise ratio: 100 dB

Wow and flutter: Immeasurable

MD recorder

Audio playing system: MiniDisc digital audio system

Recording system: Magneto-optical overwrite system

Reading system: Non-contact, semiconductor laser pickup ($\lambda=780$ nm)

Error correction system: CIRC (Cross Interleave Reed-Solomon Code)

Sampling frequency: 44.1 kHz
(With sampling rate converter for recording — 32 kHz/44.1 kHz/48 kHz)

Audio compression system:

ATRAC (Adaptive TRansform Acoustic Coding)/ATRAC3 (**MDLP**)

General

Power requirement:

AC 110V/AC 127V/AC 220V/
AC 230V – AC 240V \sim
(adjustable with the voltage selector), 50 Hz/60 Hz

Power consumption: 75 W (at operation)
11 W (on standby)

Dimensions (approx.):

215 mm x 170 mm x 349 mm (W/H/D)
(8 $\frac{1}{2}$ in. x 6 $\frac{3}{4}$ in. x 13 $\frac{3}{4}$ in.)

Mass (approx.): 6.2 kg (13.7 lbs)

Supplied accessories

See page 6.

Design and specifications are subject to change without notice.

US and foreign patents licensed from Dolby Laboratories Licensing Corporation.
--

Mains (AC) Line Instruction (not applicable for Europe, U.S.A., Canada, Australia and U.K.)

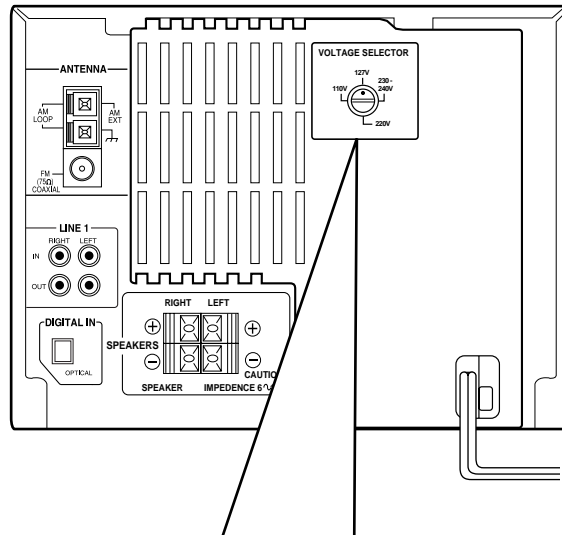

VOLTAGE SELECTOR

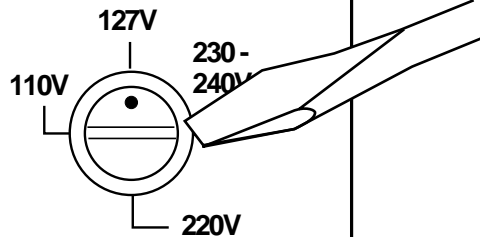

CAUTION for mains (AC) line

BEFORE PLUGGING IN, do check that your mains (AC) line voltage corresponds with the position of the voltage selector switch provided on the outside of this equipment and, if different, reset the voltage selector switch, to prevent from damage or risk of fire/electric shock.

Free Manuals Download Website

<http://myh66.com>

<http://usermanuals.us>

<http://www.somanuals.com>

<http://www.4manuals.cc>

<http://www.manual-lib.com>

<http://www.404manual.com>

<http://www.luxmanual.com>

<http://aubethermostatmanual.com>

Golf course search by state

<http://golfingnear.com>

Email search by domain

<http://emailbydomain.com>

Auto manuals search

<http://auto.somanuals.com>

TV manuals search

<http://tv.somanuals.com>