

JVC

English

MICRO COMPONENT MD SYSTEM MD 微型组合音响

中文

UX-QD7M

Consists of CA-UXQD7M and SP-UXQD6M
由 CA-UXQD7M 和 SP-UXQD6M 组成

UX-QD7W

Consists of CA-UXQD7W and SP-UXQD6W
由 CA-UXQD7W 和 SP-UXQD6W 组成

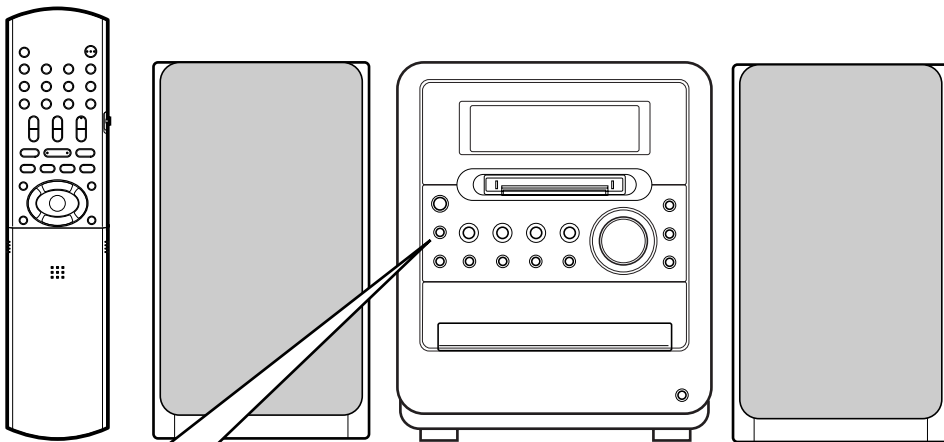

For hiding the demonstration display, refer to page 16.
有关隐藏演示显示的详情, 请参阅第 16 页。



MDLP *Digital Direct Progressive Scan* **AV COMPU LINK** **3D** *3D-PHONIC*

INSTRUCTIONS 使用说明书

LVT1220-002A
[UB]

Warnings, Cautions and Others / 警告，注意及其他须知事项

CAUTION

To reduce the risk of electrical shocks, fire, etc.:

1. Do not remove screws, covers or cabinet.
2. Do not expose this appliance to rain or moisture.

注意

为了减少触电、火灾等危险：

1. 请勿擅自卸下螺丝钉、盖子或机壳。
2. 请勿让本机受雨淋或置于潮湿环境中。

CAUTION — button!

Disconnect the mains plug to shut the power off completely.

The  button in any position does not disconnect the mains line.

The power can be remote controlled.

注意 — 开关！

想要完全关闭电源，须将电源插头从插座上拔下。

无论  键处于何种位置，主电路仍旧没有关闭。

电源开关可用遥控器进行控制。

CAUTION

- Do not block the ventilation openings or holes. (If the ventilation openings or holes are blocked by a newspaper or cloth, etc., the heat may not be able to get out.)
- Do not place any naked flame sources, such as lighted candles, on the apparatus.
- When discarding batteries, environmental problems must be considered and local rules or laws governing the disposal of these batteries must be followed strictly.
- Do not expose this apparatus to rain, moisture, dripping or splashing and that no objects filled with liquids, such as vases, shall be placed on the apparatus.

注意

- 切勿堵塞通风口或通风孔。
(如果通风口或通风孔被报纸或布等物堵塞，热量将无法散出。)
- 切勿在本系统上放置明火，如点燃的蜡烛。
- 想要丢弃电池时，务必考虑环保问题以及严格遵守当地关于处理废旧电池相关的法律规定和条例。
- 切勿让本机受雨淋、受潮湿、落上或溅上水滴，亦勿在本机上面放置盛满液体的容器，如花瓶。

IMPORTANT FOR LASER PRODUCTS / 镭射产品的重要说明

1. CLASS 1 LASER PRODUCT

2. **CAUTION:** Do not open the top cover. There are no user serviceable parts inside the unit; leave all servicing to qualified service personnel.

3. **CAUTION:** Visible and invisible laser radiation when open and interlock failed or defeated. Avoid direct exposure to beam.

4. REPRODUCTION OF LABEL: CAUTION LABEL, PLACED INSIDE THE UNIT.

1. 一级镭射产品。

2. **注意:** 请勿打开顶盖板，本机内部没有用户可自行维修的部件；所有维修工作应由有资格的人员完成。

3. **注意:** 当内部锁定装置失效或者损坏后，打开盖板可能会产生可见或不可见的镭射辐射。应避免受到镭射光束的直接照射。

4. 标签的复制标示：注意标签位于机内。

CAUTION: Visible and invisible laser radiation when open and interlock failed or defeated. AVOID DIRECT EXPOSURE TO BEAM. (e)	ADVARSEL: Synlig og usynlig laserstråling når maskinen er åben eller interlocken fejler. Undgå direkte eksponering til stråling. (d)	WARNING: Synlig och osynlig laserstråling när den öppnas och spärren är urkopplad. Betrakta ej strålen. (s)	VARO: Avattaessa ja suojalukitus ohitettuna tai viallisena olet alttiina näkyvälle ja näkymättömälle lasersäteilylle. Vältä säteen kohdistumista suoraan itseesi. (f)
--	---	--	--

CAUTION — Proper Ventilation

To avoid risk of electric shock and fire and to protect from damage, locate the apparatus as follows:

Top/Front/Back/Sides: No obstructions should be placed in the areas shown by the dimensions below.

Bottom: Place on the level surface. Maintain adequate air path for ventilation by placing on a stand with a height of 10 cm or more.

In addition, maintain the best possible air circulation.

Front view

前视图

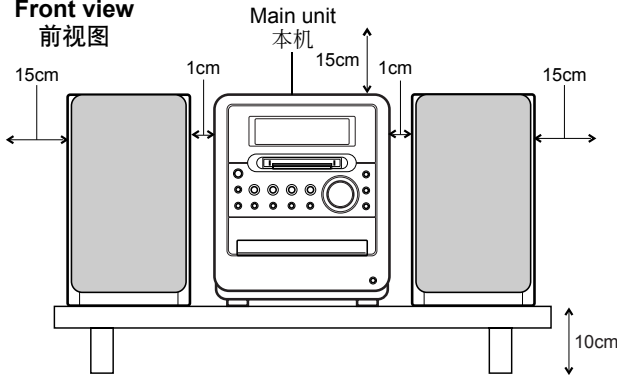

注意 — 正确的通风方法

为了防止触电，火灾及避免损坏，

按如下要求放置机器：

上面 / 前面 / 后面 / 侧面： 在图中所示范围中，不应放置任何障碍物。

底部： 放置在水平面上。放置在一个高 10 cm 或更高的台上以保留足够的通风道。

此外，如图所示，尽可能保持最佳的空气循环。

Side view

侧视图

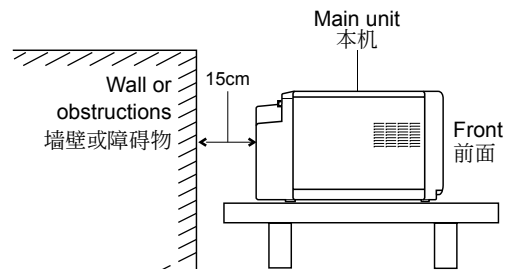

Table of Contents

Used frequently marks refer to operation used frequently. You can quickly learn the general usage of this product by reading those parts only.

Introduction

Notes on Operation	3
Suitable Locations for the Main Unit	3
Condensation	3
Cleaning the Main Unit	3
Listener's Etiquette	3
Playable Disc Types	4
Disc Structure	5
Selecting the Color System	6
Special Cautions	7
Notes on Handling	7
Supplied Accessories	7

Preparation

Part Description	8
Remote Control	9
Inserting Batteries into the Remote Control	9
Operating the TV Using the Remote Control	10
Connections	11
Connecting the Antennas	11
Connecting the Speakers	13
Connecting Other Equipment	14
Connecting with a TV	15
When a Clearer Picture Is Desired	15
Connecting the Power Plug	16

Basic Operations

Basic Operations	17
Setting the Clock	17
Turning On/Off the Main Unit	18
Adjusting the Volume	18
Temporarily Turning Off the Sound (FADE MUTING)	18
Emphasizing Heavy Bass Sound (AHB PRO) ..	18
Adjusting the Sound Quality	18
Changing the Color Patterns for the Display Window and Disc Tray	19

Listening to Radio Broadcasts

Listening to Radio Broadcasts	20
.....	Used frequently
Setting the AM Tuner Spacing	20
Selecting a Radio Station	20
Storing Radio Stations (Preset)	21
Tuning In to a Preset Radio Station	21
Changing the Display in the Display Window ...	21

Listening to Discs

Basic Operations of the DVD Player ...	22
Playback	22
Changing the Display in the Display Window ...	24
Playing Back from a Position 10 Seconds Before (One Touch Replay)	24
Stopping Playback	25
Resuming Playback (RESUME)	25
Pausing Playback	25
Advancing Picture Frame by Frame	25
Fast Reverse/Fast Forward Search	25
Slow Motion Playback	26
Skipping to the Beginning of a Track	26
Skipping to the Beginning of a Track with the Number Buttons	26
Selecting a Track from the Menu Screen	26
Convenient Functions of the DVD Player	27
Selecting the Audio	27
Selecting the Subtitle	28
Selecting a View Angle	28
Magnifying the Picture (ZOOM)	28
Adjusting the Picture Quality (VFP)	29
Creating Realistic Sound (3D PHONIC)	29
Adjusting Playback Level (DVD LEVEL)	30
Enjoying Better Pictures (PROGRESSIVE)	30
Playing Back the Bonus Group	31
Browsable Still Pictures (B.S.P.)	31
Playing Back the Disc in the Desired Order (Program Playback)	32
Random Playback	33
Repeat Playback	34
Status Bar and Menu Bar	35
Using the Status Bar and Menu Bar	35
Playing Back the Designated Part Repeatedly (A-B Repeat Playback)	36
Designate the Time (Time Search)	36
Playing Back MP3/WMA and JPEG Discs	37
Playback	37
Repeat Playback	38
Preferences	39
Basic Operations	39
LANGUAGE	39
PICTURE	39
AUDIO	40
OTHERS	40
Country/Area Codes	41
Language Codes	42

Listening to Cassette Tapes

Listening to Cassette Tapes	
.....	Used frequently 43
Changing the Display in the Display Window	44

Listening to Other Equipment

Listening to Other Equipment	45
Adjusting the Sound Input Level from Other Equipment	45
Changing the Display in the Display Window ...	45

Listening to MDs

Listening to MDs	46
Listening to MDs	Used frequently 46
Changing the Display in the Display Window ...	47
Specifying the Track (Direct Track Selection)...	47
Group Playback of an MD	47
Program Playback	48
Random Playback	48
Repeat Playback	49
Searching Titles	49

Recording Sound

Recording Sound to MDs	Used frequently 51
Recording All Tracks from a Disc to an MD	51
Quitting Recording	52
Recording Only One Track from a Disc	52
Recording the Second or Subsequent Track to the Last Track from a Disc	52
Program Recording from a Disc	52
Things You Should Know about MD Recording	53
Recording Sound from Radio, Cassette Tape or Other Equipment	53
Quitting Recording	54
Recording Sound to Cassette Tapes	Used frequently 55
Quitting Recording	56
Recording Only One Track from a Disc or MD	56
Recording the Second or Subsequent Track to the Last Track from a Disc or MD	56
Program Recording from a Disc or MD	56
Recording with No Blank Time between Tracks	56
Erasing Recorded Sound from a Cassette Tape	56

Editing MDs

Giving (Editing) Titles	58
Things You Should Know about Editing	58
Giving (Editing) Titles	58
Entering Titles	59
Available Characters	59
Editing Tracks	60
Dividing a Track into Two Tracks (DIVIDE)	60
Joining Tracks (JOIN)	61
Moving a Track (MOVE)	61
Erasing a Track (ERASE)	Used frequently 62
Erasing All Tracks (ALL ERASE)	Used frequently 62
Editing Tracks by Group	63
Forming a Group (FORM GR)	63
Adding a Track to a Group (ENTRY GR)	64
Dividing a Group into Two Groups (DIVIDE GR)	64
Joining Groups (JOIN GR)	65
Moving a Group (MOVE GR)	65
Canceling a Group (UNGROUP/UNGR ALL) ...	66
Erasing a Group (ERASE GR)	67

Convenient Functions

Using the Timers	68
Sleep Timer	68
Recording Timer	68
Playback Timer	70
Auto Standby	72
Disc/MD Ejection Lock	72
Using AV COMPU LINK	73
Connection and Setting	73
Operations	73

Reference

Restrictions on MDs	74
Serial Copy Management System (SCMS)	74
Handling Discs/MDs/Cassette Tapes ..	75
MD/Disc Messages	76
Troubleshooting	77
Specifications	78

Notes on Operation

Suitable Locations for the Main Unit

To minimize the need for servicing and maintain the high quality of this product, do not place the main unit in the following locations:

- In a position subject to high humidity or considerable dust
- On an uneven or unstable surface
- Near a heat source
- Near a computer, fluorescent light or other electric appliance
- In a small room with insufficient ventilation
- In a position exposed to direct sunlight
- In a position exposed to excessive cold
- In a position exposed to strong vibration
- Near a TV, other amplifier, or tuner
- Near a magnetic source

CAUTION

- The operating temperature of this product is 5°C to 35°C. Use in temperatures outside this range may cause a malfunction or damage the product.

Condensation

Under the following conditions, you may not be able to operate this product properly due to condensation formed on the lens of the main unit:

- When you have just started an air conditioner to warm your room
- When you have placed the main unit at an area with high humidity
- When you have moved the main unit from a cold place to a warm place

When condensation forms, leave the main unit turned on, wait for approximately 1 or 2 hours, and then operate the main unit.

Cleaning the Main Unit

When the operation panel becomes dirty, dust it with a soft dry cloth. When the operation panel is very dirty, wipe it with a cloth dampened with a small amount of a neutral detergent, and then wipe it with a soft dry cloth.

CAUTION

- Do not wipe the operation panel with thinners, benzenes or other chemical agents. Do not spray insecticides onto the operation panel. These may cause discoloration and damage to the surface.

Listener's Etiquette

When using headphones, keep the volume at a moderate level so as not to over-stimulate your ears.

- When enjoying sound from the speakers, adjust the volume to a suitable level to avoid disturbing your neighbors. Even low-volume sound carries a long way, especially at night. Show consideration to your neighbors by closing windows or using headphones.

-
- Manufactured under license from Dolby Laboratories. "Dolby", "MLP Lossless", and the double-D symbol are trademarks of Dolby Laboratories.
 - "DTS" and "DTS 2.0+DIGITAL OUT" are registered trademarks of Digital Theater Systems, Inc.
 - This product incorporates copyright protection technology that is protected by method claims of certain U.S. patents and other intellectual property rights owned by Macrovision Corporation and other rights owners. Use of this copyright protection technology must be authorized by Macrovision Corporation, and is intended for home and other limited viewing uses only unless otherwise authorized by Macrovision Corporation. Reverse engineering or disassembly is prohibited.

Playable Disc Types

This product has been designed to play back the following discs:

DVD VIDEO, DVD AUDIO, VCD, SVCD, CD

This product can also play back the following discs:







- Finalized DVD-R/RW discs recorded in the DVD VIDEO format.
- CD-R/RW discs recorded in the following formats
- Music CDs (finalized discs)
- VCDs
- SVCDs
- MP3/WMA/JPEG discs recorded in ISO 9660 (for details, refer to "About MP3/WMA/JPEG discs")

However, some discs may not be played back because of their disc characteristics, recording conditions, or damage or stain on them.

Only sounds can be played back from the following discs:

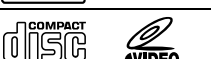
MIX-MODE CD CD-G
CD-EXTRA CD TEXT

Discs you can play:

Disc Type	Mark (Logo)	Video Format	Region Code Number*
DVD VIDEO		PAL/NTSC	3/ALL
DVD AUDIO		—	—
VCD		PAL/NTSC	—
SVCD		PAL/NTSC	—
CD		—	—
CD-R		—	—
CD-RW		—	—

DVD Logo is a trademark of DVD Format/Logo Licensing Corporation.

* Note on Region Code

DVD players and DVD VIDEOS have their own region code numbers. This product can only play back a DVD VIDEO recorded with the region code number and video format mentioned above.

Examples:



If a DVD VIDEO with an improper region code number is loaded, "REGION CODE ERROR!" appears on the TV screen and playback cannot start.

- On some DVD VIDEOS, DVD AUDIOS, VCDs or SVCDs, their actual operation may be different from what is explained in this manual. This is due to the disc programming and disc structure, not a malfunction of this product.

About CD-Rs/CD-RWs

You can play back a CD-R/CD-RW only when the disc is finalized.

- You can play back a CD-R/CD-RW which has been recorded in the audio CD format and a CD-R/CD-RW to which audio data (MP3/WMA) or a still picture data (JPEG) file is recorded.

However, playback is impossible in some cases due to the disc characteristics, recording condition, scratches or dirt on the disc, or dirt or condensation on the lens.

- Before using a CD-R/CD-RW, carefully read the cautions regarding the disc.
- This product does not support playback or CD text display of sound files such as MP3s.
- To play back a CD-RW on this product, erase all tracks if the CD-RW was recorded in a format other than the audio CD format. Using the CD-RW without erasing all tracks may result in damage to the speakers or other parts caused by sudden loud volume.

Discs that cannot be played back

- The following discs cannot be played back: DVD-ROM, DVD-RAM, DVD-RW (recorded in VR format), CD-ROM, CD-I (CD-I Ready), Photo CD, SACD, etc. Playing back these discs will generate noise and damage the speakers.
- Damaged discs and discs in an extraordinary shape (other than a disc of 12 cm or 8 cm in diameter) cannot be played back.
- JVC do not guarantee the operation and sound quality of discs not authorized by CD-DA, which is a CD specification.

Before playback, confirm that the disc complies with this CD specification by checking the marks and reading notes printed on the package.

About MP3/WMA/JPEG discs

Playable MP3/WMA/JPEG discs and files

- Discs recorded in the ISO 9660 format are playable (except discs recorded in the "packet write" format (UDF format)).
- Discs recorded in the multi-session format are also playable.
- Files with an extension of ".mp3", ".wma", ".jpg" or ".jpeg" (extensions with uppercase and lowercase letters mixed are also acceptable) are playable.

Notes on MP3/WMA/JPEG discs and files

- A disc may not be played back, or reading it may take a long time depending on its recording conditions or properties.
- The time needed for reading varies with the number of groups or tracks (files) recorded on the disc.
- If a character other than single byte English characters is used in the file name of an MP3/WMA/JPEG file, the track/file name will not be displayed correctly.
- The order of tracks/groups displayed on the MP3/WMA Control screen, and the order of files/groups displayed on the JPEG Control screen may be different from that of files/folders displayed on PC's monitor screen.
- In the case of MP3/WMA discs, since groups/tracks are played back in alphabetical order, an off-the-shelf MP3/WMA disc may be played back in an order different from that indicated on the label attached to the disc.
- Playing back an MP3/WMA file including a still image may take a long time. The elapsed time is not displayed until playing back starts. If playing back starts, the elapsed time may not be displayed correctly.
- For an MP3/WMA file, a disc with a sampling frequency of 44.1 kHz and transmission rate of 128 kbps is recommended.
- This product is not compatible with MP3i or MP3PRO.
- This product can play back a baseline JPEG file, excluding monochromatic JPEG files.
- This product can play back JPEG data taken with a digital camera conforming to the DCF (Design Rule for Camera File System) standard (when a function is applied such as the automatic rotation function of a digital camera, data goes beyond the DCF standard, so the image may not be displayed).
- If data has been processed, edited and restored with PC image editing software, the data may not be displayed.
- This product cannot play back animations such as MOTION JPEG, or still pictures (TIFF etc.) other than JPEG, and image data with sound.
- The resolution of 640 x 480 pixels is recommended for JPEG files. If a file has been recorded at a resolution of more than 640 x 480 pixels, display may take a long time. An image with a resolution of more than 8 192 x 7 680 pixels cannot be displayed.
- Files recorded on DVD-R/RW discs cannot be played back.

Disc Structure

DVD VIDEO

A DVD VIDEO consists of "titles" and each title may be divided into "chapters".

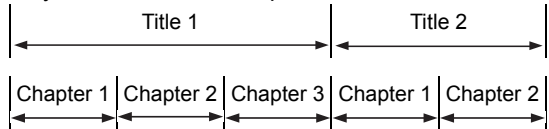

DVD AUDIO

A DVD AUDIO consists of "groups" and each group may be divided into "tracks".

Some discs include a "bonus group" that requires a password for playing (🔑 page 31).

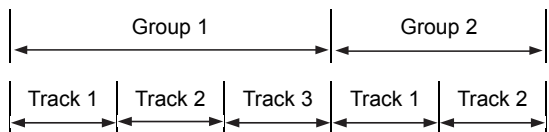

VCD/SVCD/CD

VCD, SVCD and CD consist of "tracks".

In general, each track has its own track number. (On some discs, each track may also be further divided by indexes.)

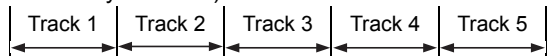

MP3/WMA [JPEG] discs

On an MP3/WMA [JPEG] disc, each still picture (material) is recorded as a track [file]. Tracks [Files] are usually grouped into a folder. Folders can also include other folders, creating hierarchical folder layers.

This unit simplifies the hierarchical construction of a disc and manages folders by "groups".

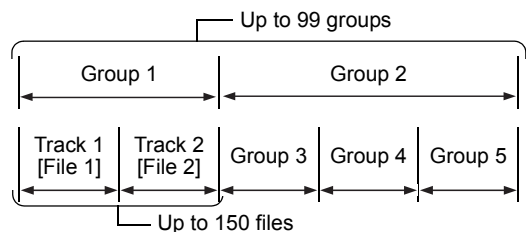

This product can recognize up to 1 000 tracks [files] in a disc. Also, the product can recognize up to 150 tracks [files] per group and up to 99 groups in a disc. Since the unit ignores the tracks [files] whose numbers are exceeding 150 and the groups whose numbers are exceeding 99, they cannot be played back.

- If there is any type of files other than MP3/WMA [JPEG] files in a disc, those tracks [files] are also counted in the total file number.

Selecting the Color System

This product is compatible with PAL and NTSC color systems.

In standby mode, select PAL or NTSC to match your TV.

If the VIDEO OUT SELECT switch is switched over when the power is on, turn off the power, and then turn it on again.

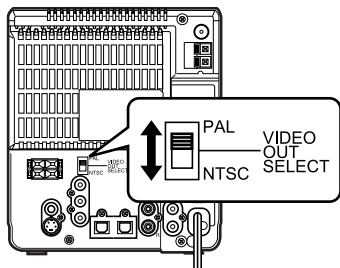

Color system of TV	VIDEO OUT SELECT
Multi-color system	PAL or NTSC*
PAL	PAL
NTSC	NTSC

* Set the color system of the unit and TV to match the playback disc.

- Before playing back a disc, it is also required to select the correct MONITOR TYPE in the PICTURE menu according to the aspect ratio of your TV (👉 page 39).

NOTE

- If you play back an NTSC disc with this setting set to "PAL", you can watch the playback pictures (the disc will be reproduced using "PAL 60" format), but the TV screen may roll over upward and downward rapidly.

NOTE

- If you play back a PAL disc with this setting set to "NTSC", you can watch the playback pictures, but the following symptoms may occur:
 - The items on the disc menu will be blurred, and be shown slightly shifted when highlighted.
 - The aspect ratio of the picture may differ from the original aspect ratio.
 - The picture movement is not smooth.

Special Cautions

Notes on Handling

■ Important cautions

Installation of the system

- Select a place which is level, dry and neither too hot nor too cold; between 5°C and 35°C.
- Leave sufficient distance between the system and the TV.
- Do not use the system in a place subject to vibration.

Power cord

- Do not handle the power cord with wet hands!
- A small amount of power is always consumed while the power cord is connected to the wall outlet.
- When unplugging the power cord from the wall outlet, always pull on the plug, not the power cord.

To prevent malfunctions of the system

- There are no user-serviceable parts inside. If anything goes wrong, unplug the power cord and consult your dealer.
- Do not insert any metallic object into the system.
- Do not use any non-standard shape disc (like a heart, flower or credit card, etc.) available on the market, because it may damage the system.
- Do not use a disc with tape, stickers, or paste on it, because it may damage the system.

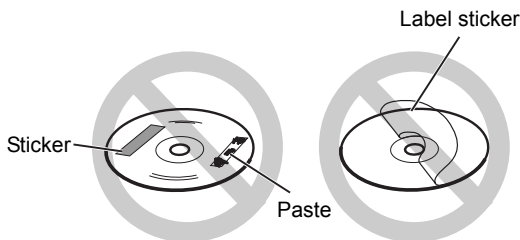

Note about copyright laws

Check the copyright laws in your country before recording from CDs. Recording of copyrighted material may infringe copyright laws.

■ Safety precautions

Avoid moisture, water and dust

Do not place the system in moist or dusty places.

Avoid high temperatures

Do not expose the system to direct sunlight and do not place it near a heating equipment.

When you are away

When away on travel or for other reasons for an extended period of time, disconnect the power cord plug from the wall outlet.

Do not block the vents

Blocking the vents may damage the system.

Care of the cabinet

When cleaning the system, use a soft cloth and follow the relevant instructions on the use of chemically-coated cloths. Do not use benzene, thinner or other organic solvents including disinfectants. These may cause deformation or discoloring.

If water gets inside the system

Turn the system off and disconnect the power cord plug from the wall outlet, then call the store where you made your purchase. Using the system in this condition may cause fire or electrical shock.

■ When condensation or water drops adhere to the lens

In any of the following cases, condensation or water drops may adhere to the lens to prevent the system from working properly:

- Immediately after roomheating starts
- When the system is installed in a steamy or damp space
- When the system is suddenly moved from a cold place to a warm space

In any of these cases, leave the system turned on for 1 or 2 hours before use.

Supplied Accessories

Check to be sure you have all of the supplied accessories.

The number in parentheses is the quantity of the pieces supplied. If anything is missing, contact your dealer immediately.

- Remote control (1)
- Batteries (2)
- FM antenna (1)
- AM loop antenna (1)
- Video cord (1)

- This product incorporates copyright protection technology that is protected by method claims of certain U.S. patents and other intellectual property rights owned by Macrovision Corporation and other rights owners. Use of this copyright protection technology must be authorized by Macrovision Corporation, and is intended for home and other limited viewing uses only unless otherwise authorized by Macrovision Corporation. Reverse engineering or disassembly is prohibited.

Part Description

The numbers refer to the pages in which the parts are explained.

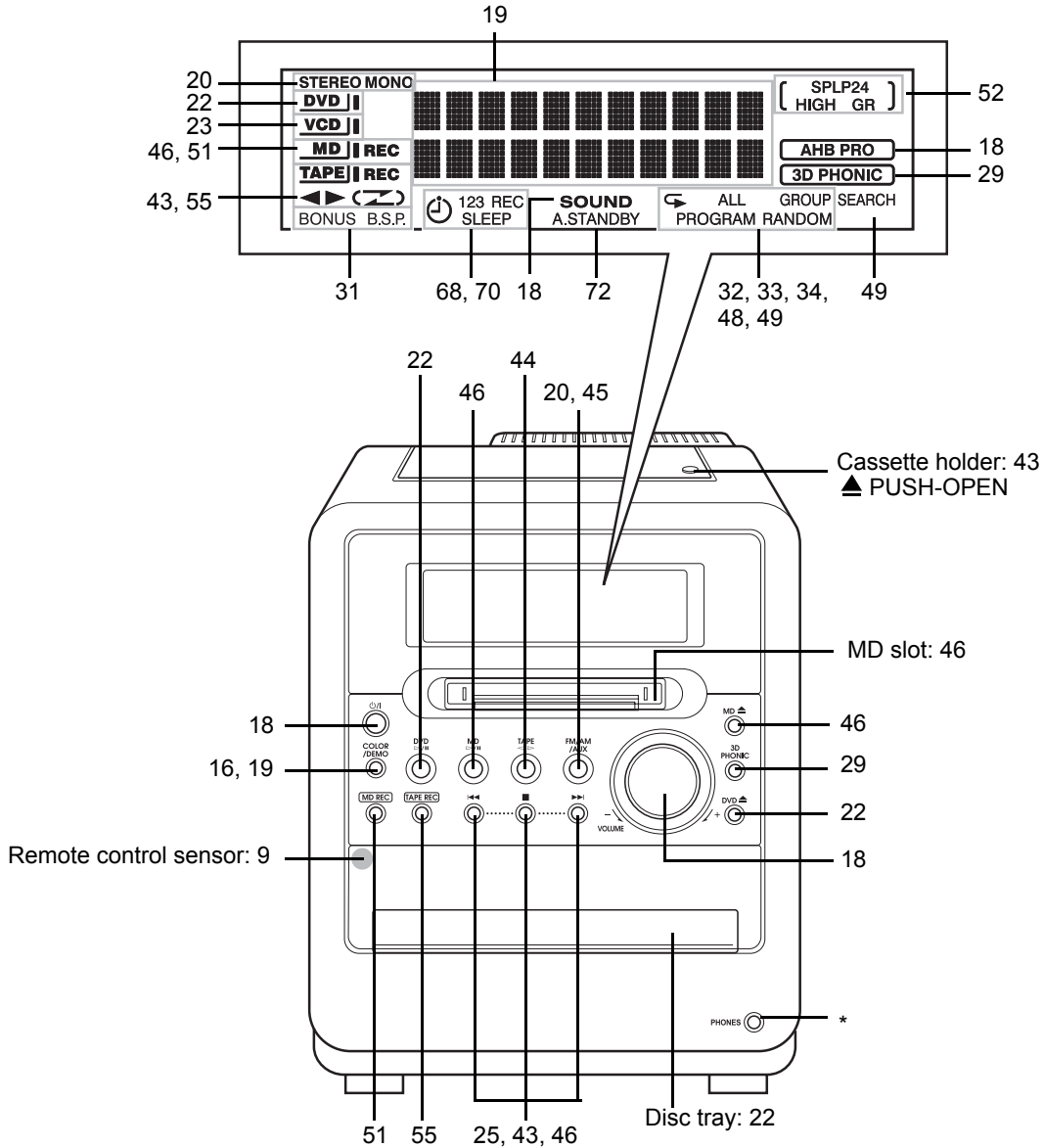

* This terminal is for connecting a pair of headphones equipped with a stereo mini plug (not supplied). While the headphones are connected, the speakers do not produce any sound.

Remote Control

The numbers refer to the pages in which the parts are explained.

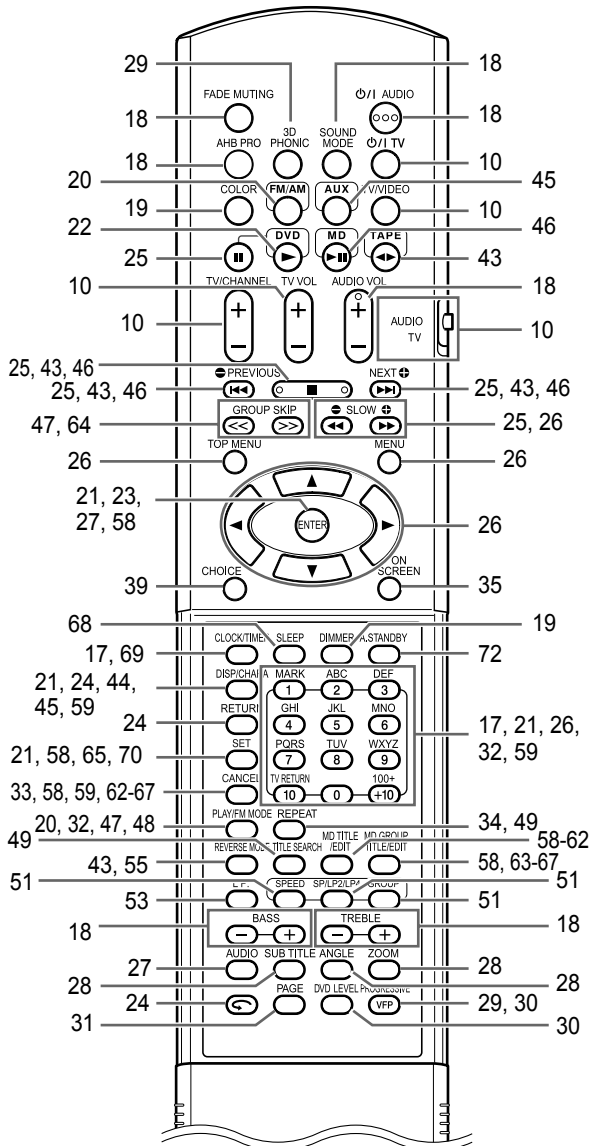

Opening the cover

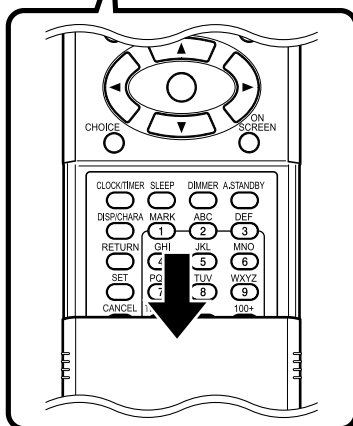

Inserting Batteries into the Remote Control

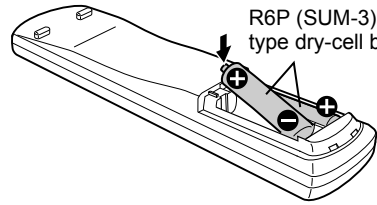
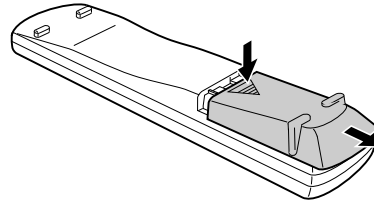

R6P (SUM-3) / AA (15F)
type dry-cell batteries (2)

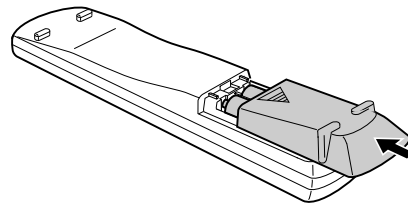

CAUTION

- Do not use a used battery and a new battery together.
- Do not use different types of batteries at the same time.
- Take out the batteries if the remote control is not to be used for a long time. Otherwise it may cause a leakage.

Remote control operation

- When operating the remote control, point it at the front panel of the main unit.
- The effective distance between the remote control and the remote control sensor on the main unit is approximately 5 m maximum.
- When the effective distance decreases, replace the batteries.
- Do not drop the remote control or subject it to excessive shock.

This page is for when operating your TV using the remote control of this product.

Operating the TV Using the Remote Control

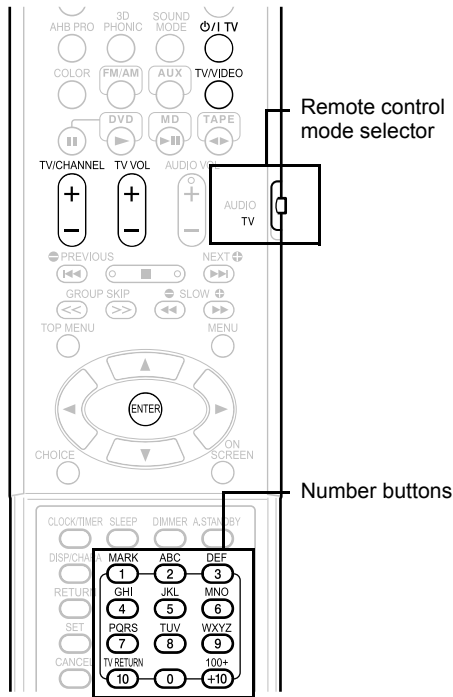

Setting the manufacturer's code

1 Slide the remote control mode selector to the TV side.



2 Hold down ϕ/I TV.

NOTE

- Hold down ϕ/I TV until step 4 is completed.

3 Press ENTER and release.

4 Press number buttons (1-9, 0).

Examples:

- For a Hitachi TV: Press 1, then 0.
- For a Toshiba TV: Press 0, then 8.

If there are two or more manufacturer's codes, try them in turn and select the one that causes the product to work properly.

Manufacturer	Code	Manufacturer	Code
JVC	01	Samsung	12
Hitachi	10	Sanyo	13
Magnavox	02	Sharp	06
Mitsubishi	03	Sony	07
Panasonic	04, 11	Toshiba	08
Philips	14	Zenith	09
RCA	05		

5 Release ϕ/I TV.

NOTE

- The manufacturer's codes may be changed without notice. You may not be able to operate a TV produced by the manufacturer shown above.

For TV operation

Operate the remote control by pointing it towards the TV.

ϕ/I TV	Turn on/off the power.
TV/CHANNEL	Change channels.
TV VOL	Adjust volume.
MARK 1 - WXYZ / 0 / 100+ / +10	Select channels. *1
TV RETURN 10	Change between the previously selected channel and the current channel.
TV/VIDEO	Change between TV and video input.

*1 Make sure to slide the remote control mode selector to the TV side in advance.

NOTE

- When the batteries are replaced, perform the manufacturer's code setting again.

Connecting the Antennas

Connecting the AM antenna

1 Set up the AM antenna (supplied).

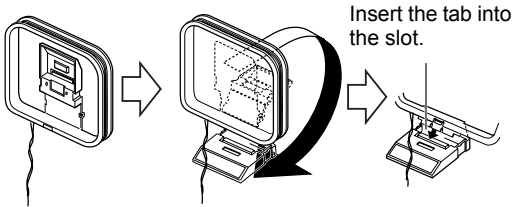

2 Connect the antenna cord.

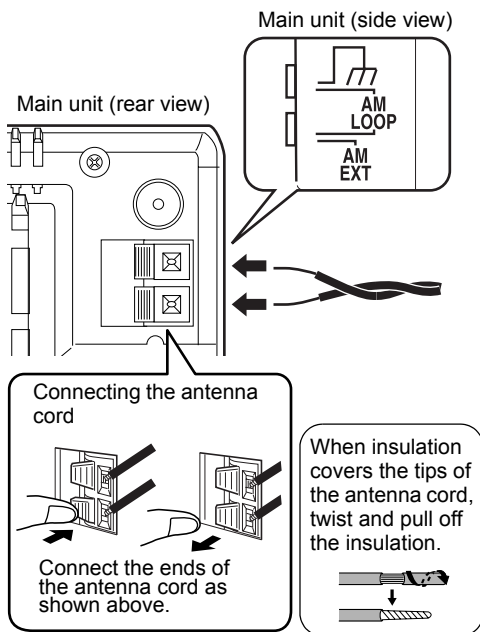

■ When radio reception with the supplied AM loop antenna is poor

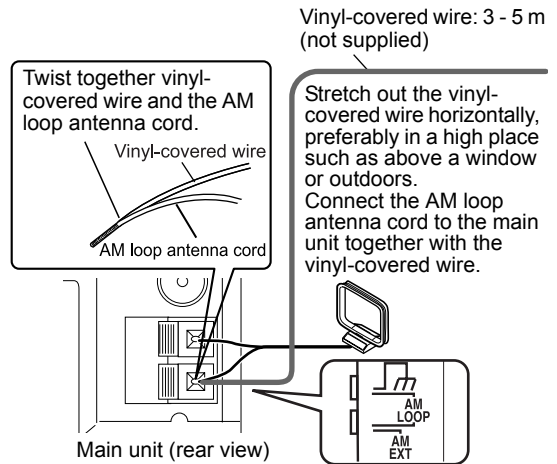

3 Turn the AM loop antenna to find the best position for radio reception.

Place the AM loop antenna as far from the main unit as possible.

- Do not place the AM loop antenna on a metallic table or close to a TV, computer, or other electric appliances. Doing so may affect radio reception.

When positioning the antennas, find the best position for reception while listening to an actual radio program (refer to "Listening to Radio Broadcasts" (📻 page 20)).

Connecting the FM antenna

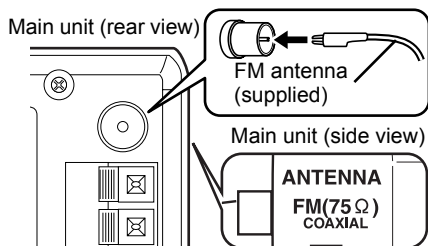

Stretch out the FM antenna to the best position for radio reception, and then fix it with adhesive tape.

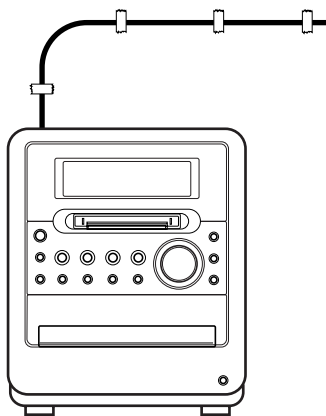

- When radio reception with the supplied FM antenna is poor, or when using a communal antenna

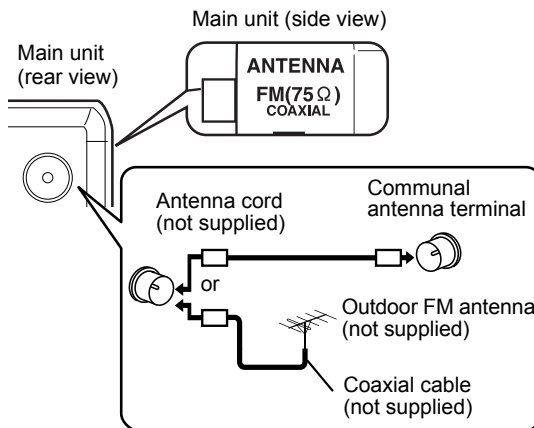

When using an antenna other than those supplied with this product, refer to the operation manuals for the antenna for details of connection.

When positioning the antennas, find the best position for reception while listening to an actual radio program (refer to "Listening to Radio Broadcasts" (👉 page 20)).

Connecting the Speakers

After connecting the speakers, gently pull on the speaker cords to make sure the cords are firmly connected and do not pull out.

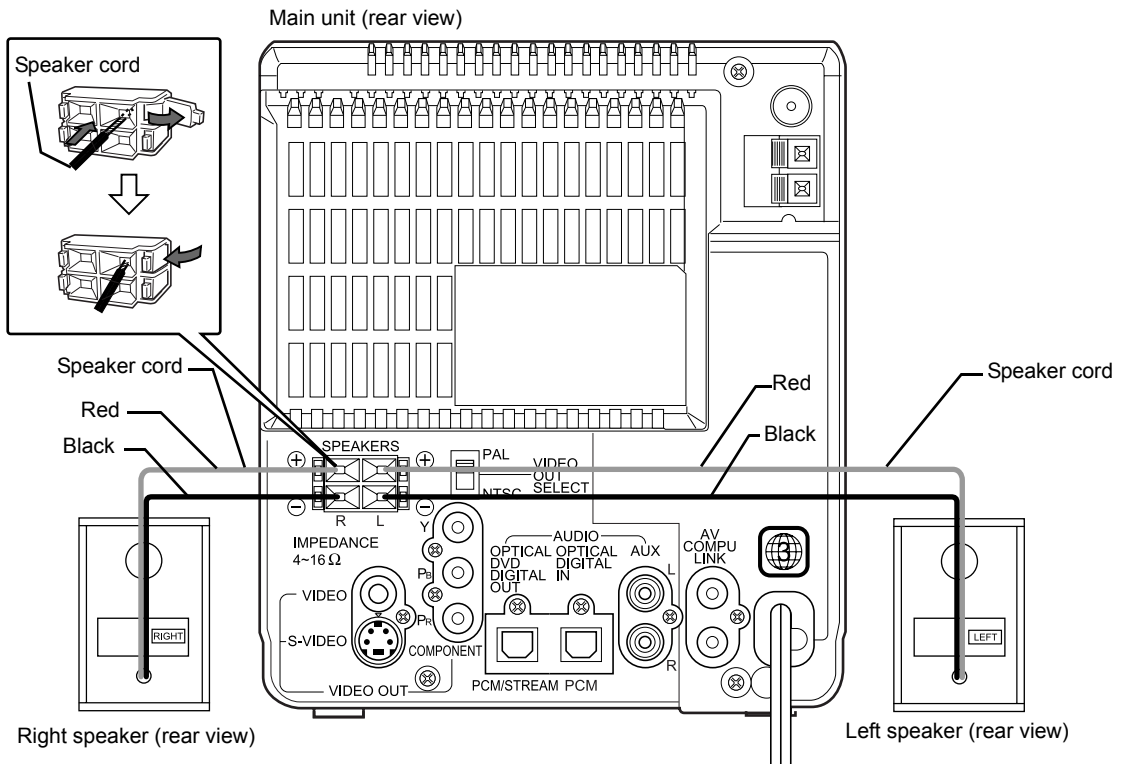

CAUTION

- Do not short-circuit the \oplus and \ominus speaker terminals. Doing so may damage the speakers.
- Do not connect other speakers together with the supplied speakers. The change in impedance may damage the main unit and the speakers.
- The speakers of this product are magnetically shielded, but color irregularities may occur on the TV depending on how the speakers are installed. Keep in mind the following.
 1. Turn off the main power of your TV before installing the speakers. Wait for about 30 minutes before turning on the TV again.
 2. If color irregularity occurs in pictures, keep a distance of more than 10 cm between the TV and the speakers.

You can detach the speaker cover.

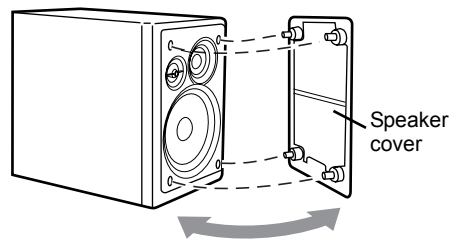

NOTE

- Improper speaker cord connection spoils the stereo effect and sound quality.
- The impedance of speakers connected to this product must be within the range of 4 Ω to 16 Ω .
- Cooling fan is built into the main unit for emitting generated heat. The internal cooling fan automatically rotates and stops. To ensure sufficient cooling, leave a space of more than 1 cm between the main unit and the speakers or other objects.

Connecting Other Equipment

Read this section when connecting other audio equipment to this product.

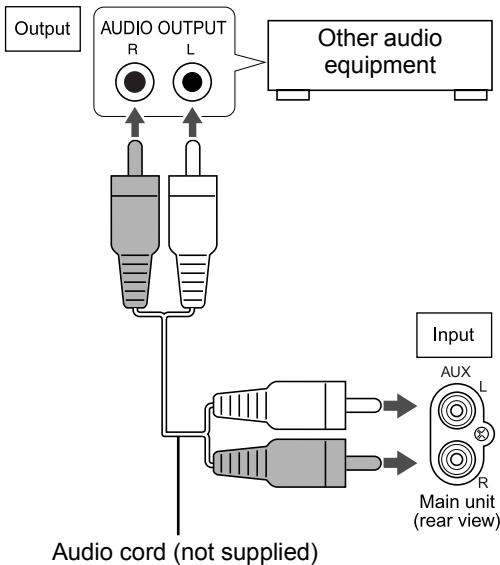

CAUTION

- Before connecting other equipment, turn off both the main unit and the equipment.

Connecting with digital equipment

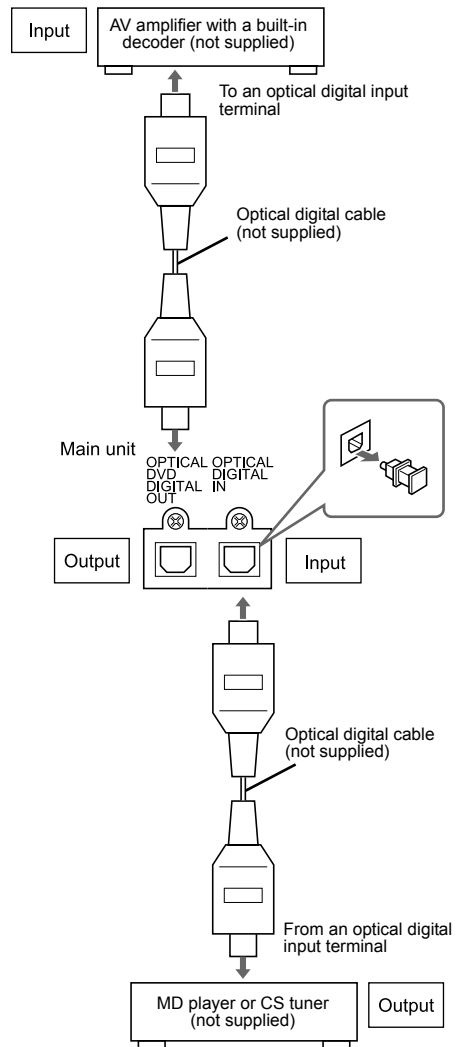

CAUTION

- For details of signals to be output, refer to page 40.
- If connecting the main unit to equipment that has the function of a Dolby Digital decoder, the setting in "D. RANGE COMPRESSION" of "AUDIO" (page 40) will be invalid regarding sound from the digital audio output of the main unit.

Connecting with a TV

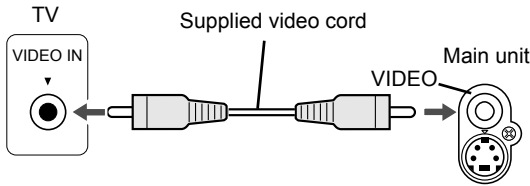

CAUTION

- Connect the main unit directly with a TV (or a monitor) without routing through a VCR. Otherwise it may cause picture distortion while playing back. (Such picture distortion is caused by a copy protection system, and thus it is not a malfunction.)

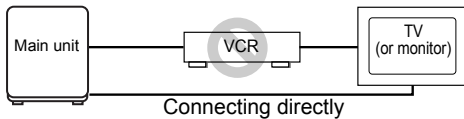

Also, if the main unit is connected to a TV with a built-in VCR, there may be picture distortion during playback.

NOTE

- Please check that the setting for VIDEO OUT SELECT (PAL/NTSC) on the rear panel of the main unit and the color system on your TV set are the same. (▶▶ page 6)
You need to set "MONITOR TYPE" in the "PICTURE" menu correctly according to the aspect ratio of your TV. (▶▶ page 39)

When a Clearer Picture Is Desired

You can enjoy pictures of better quality using the following cord instead of the supplied video cord.

Connecting by using the S-video cord

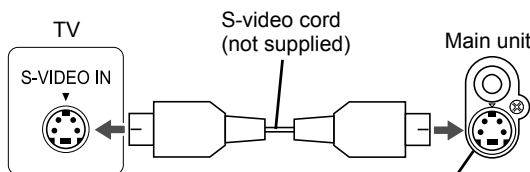

Connect the ends of S-video cord making sure that each end matches its compatible terminal.

Connecting by using the component video cord

You can enjoy better quality pictures than when using the S-video cord.

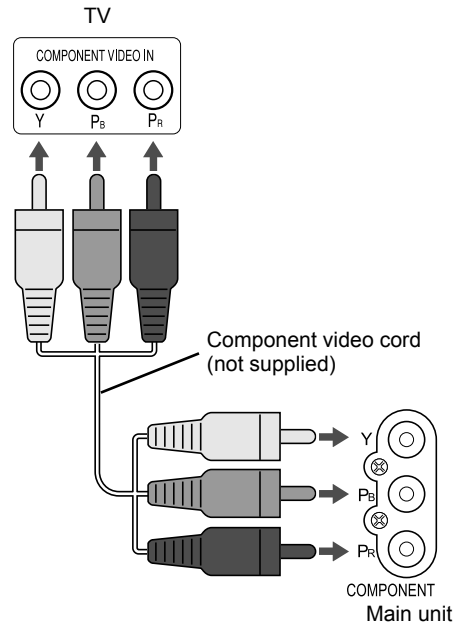

CAUTION

- Use one of either the S-video cord or the component video cord. If both cords are used, pictures may not be played back properly.

NOTE

- In order to enjoy pictures with the progressive mode (▶▶ page 30), the TV is required to have progressive video input.
- If the component video input jacks of your TV are BNC type, use a plug adapter (not supplied) to convert the plugs.

Connecting the Power Plug

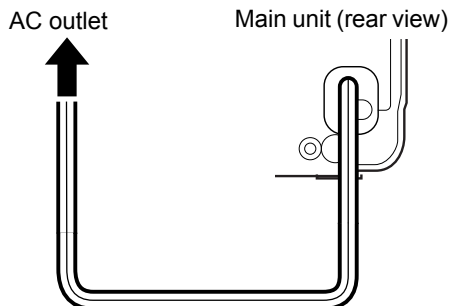

- After making all other necessary connections, connect in the power plug.

NOTE

- The preset setting such as preset channels and sound adjustment may be erased in a few days in the following cases:
 - When you disconnect the power plug.
 - When a power failure occurs.

Demonstration display function

When you connect the power plug into the AC outlet, "DEMO START!" appears in the display window and the demonstration display starts.

When you press  on the main unit, "DEMO OFF" appears in the display window and the demonstration display is canceled.

Turning on the main unit automatically cancels the demonstration display.

Resuming the demonstration display

With the power turned off, press  on the main unit.

Hiding the demonstration display

With the power turned off, hold down  until "DEMO CLEAR" appears.

Disconnecting and then reconnecting the power plug does not start the demonstration display.

To activate the demonstration display again, hold down  until "DEMO START!" appears.

Basic Operations

This manual explains the operations assuming that you will use the remote control. Some buttons on the main unit are the same as those on the remote control. You can use either button in this case.

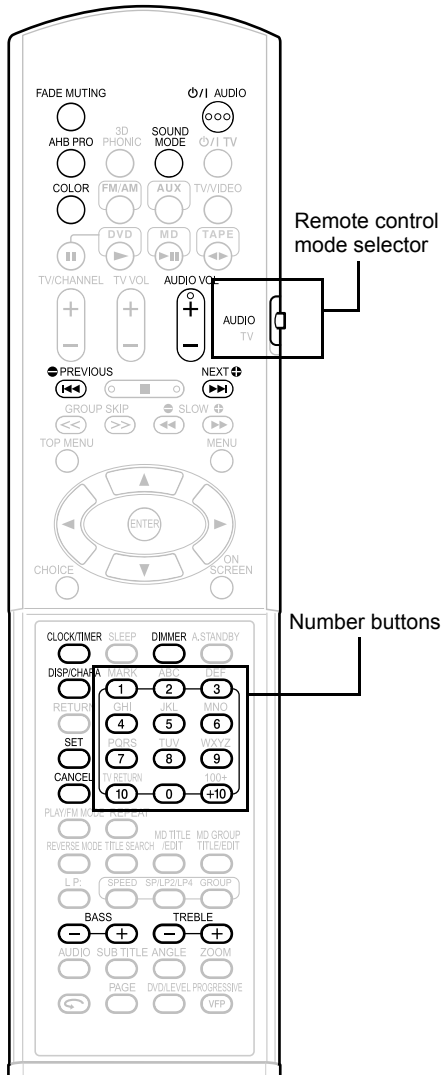

CAUTION

- Set the remote control mode selector to **AUDIO** before using the number buttons. 

Setting the Clock

You can set the clock while the main unit is turned either on or off.

Example: To set the clock to 10:10 a.m.

1 Press .











2 Set the hour.

 
Back Next

- Holding down the button causes the hour to increment.
- You can use the number buttons to specify the hour. Refer to "Using the number buttons" shown below.

Using the number buttons

Set the remote control mode selector to **AUDIO** before using the number buttons. 

Examples: 3: 
13:  → 
20:  → 
23:  →  → 



3 Press .



- To return to step 2, press .

4 Set the minute in the same manner as steps 2 and 3.



Adjusting the clock

Press  four times to display the clock, and then adjust the clock starting from step 2.

Displaying the clock while using the main unit

Press  repeatedly.

NOTE

- The time display on the main unit is a 24-hour clock.
- The clock will gain or lose approximately 1 minute per month.
- Set the clock again after you have disconnected the power plug or a power cut has occurred.



Turning On/Off the Main Unit

Used frequently

Press  (or  on the main unit).

- With the power off, pressing either button also turns on the main unit. The function assigned to the button starts working at the same time.

Remote control:     

Main unit:      

NOTE

- Cooling fan is built into the main unit for emitting generated heat. The internal cooling fan automatically rotates and stops.

Adjusting the Volume

Used frequently

Press .

- You can also adjust the volume by turning the VOLUME control on the main unit.

NOTE

- You can adjust the volume within the range of 0 to 40.



Temporarily Turning Off the Sound (FADE MUTING)

Press .

- "FADE MUTING" appears and the volume reduces to "0".
- To return to the previous volume, press  again.

Emphasizing Heavy Bass Sound (AHB PRO)

Press .

- Each time you press , AHB PRO function toggles between "ON" and "OFF".
- While AHB PRO function is activated,  is displayed in the display window.
- "AHB PRO" stands for "Active Hyper Bass PRO".

Adjusting the Sound Quality

Selecting the sound mode

Press .

- Each time you press , the display toggles as follows.

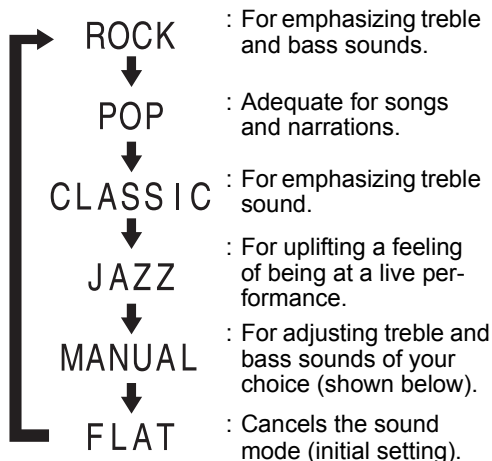

- While the sound mode is set to an item other than "FLAT", **SOUND** is displayed in the display window.

NOTE

- This function does not affect recording sound.

Adjusting bass/treble sound

1 Press  repeatedly to display "MANUAL".

2 For adjusting bass sound;

Press .

For adjusting treble sound;

Press .

- You can adjust the sound quality within the range of -5 to +5.
- The display returns to the sound source display in a few seconds.

NOTE

- While the sound mode is set to an item other than "MANUAL", "NO OPERATE" is displayed in the display window and you cannot adjust bass/treble sound.

Changing the Color Patterns for the Display Window and Disc Tray

Press  (or  on the main unit).

- Each time you press , the display toggles as follows.

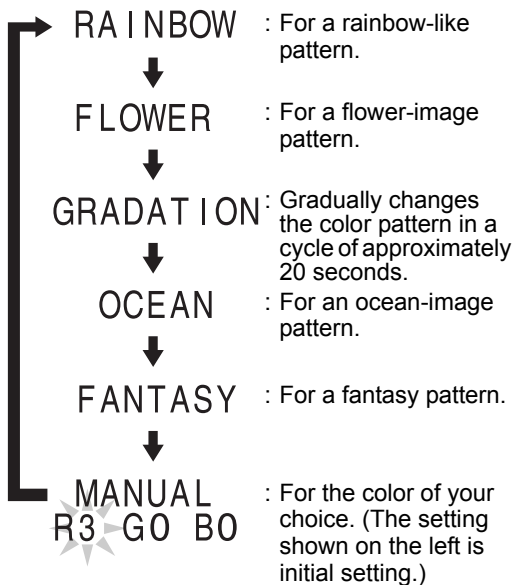

Setting your favorite color for the display window and disc tray

- Press  repeatedly to display "MANUAL".
- Press  or  to select a component color.

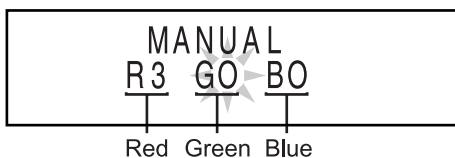

- Numerical value of the selected component color flashes.

- Press  to adjust the intensity of the component color.

- You can also adjust the color intensity by turning the VOLUME control on the main unit.
- You can adjust the color intensity within the range of "0" to "3". You cannot set all three component colors (red, green, and blue) to "0" at the same time.

NOTE

- After you have adjusted each component color, the display returns to the sound source display in approximately 8 seconds.
- You cannot set different colors for the display window and disc tray.
- When you operate a button on the main unit or remote control, the display window and disc tray light in pale blue for approximately 2 seconds.
- When recording finishes, the color of the display window and disc tray switches to the color set in "MANUAL" to inform you that recording has finished. (With an item other than "MANUAL" selected) When you operate the main unit after recording finishes, the color pattern for the display window and disc tray returns to the selected pattern.

Changing the brightness of the display window and disc tray (DIMMER)

Press .

- Each time you press , the display toggles as follows.

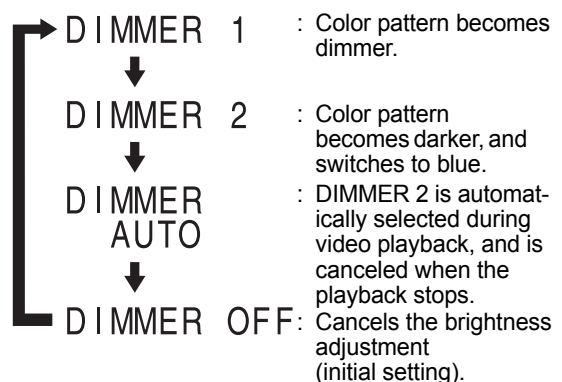

NOTE

- Once you press  to change the color pattern, the brightness returns to the initial setting. (except for DIMMER AUTO)
- When you turn off the main unit, the brightness also returns to the initial setting.
- You cannot turn off the color pattern.

Listening to Radio Broadcasts

Used frequently

This product can receive FM and AM radio broadcasts.

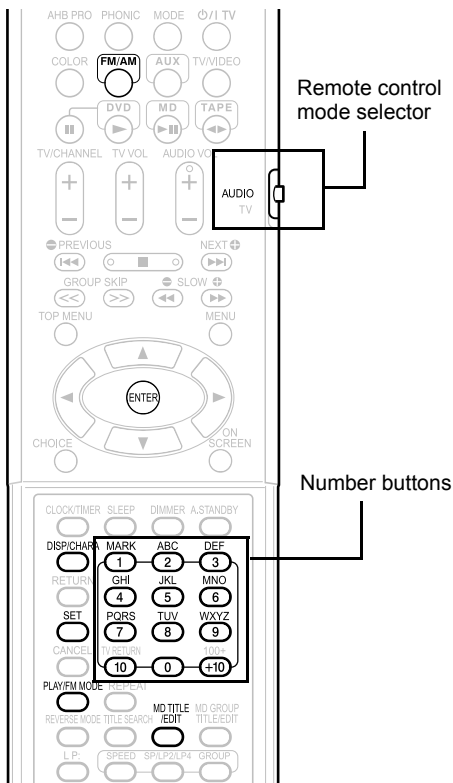

CAUTION

- Set the remote control mode selector to **AUDIO** before using the number buttons.

Setting the AM Tuner Spacing

Some countries space AM stations 9 kHz apart, and other countries use 10 kHz spacing.

On the main unit **ONLY**:

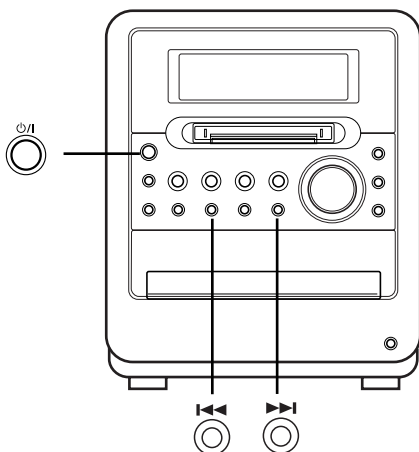

■ When the main unit is turned off

To select 10 kHz spacing, while holding down on the main unit, press on the main unit to turn on the power. "AM 10 kHz" appears in the display window.

To select 9 kHz spacing, while holding down on the main unit, press on the main unit to turn on the power. "AM 9 kHz" appears in the display window.

NOTE

- If the spacing is switched, the memory in which the radio stations were stored will be erased.

Selecting a Radio Station

1 Press repeatedly to select "FM" or "AM".

Example: Display while an FM radio broadcast is received

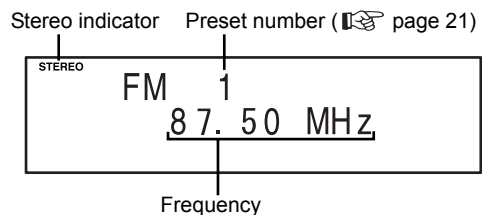

2 Press or repeatedly to select a radio station (frequency).
 • You can also select a radio station using the automatic tuning.

Automatic tuning:

Hold down or until the frequency starts changing, and then release the button.
 When the main unit has received a broadcast, the frequency automatically stops changing.
 To quit the function while searching for a broadcast, press or .

- When the main unit has received an FM stereo broadcast, "STEREO" lights up.

NOTE

- If an FM stereo broadcast is difficult to hear because of noise, you may be able to hear more easily by pressing to switch the sound to monaural reception. In this case, "MONO" lights up. To return the sound to stereo reception, press again or select another FM radio station.
- This product is not compatible with AM stereo broadcasts.

Storing Radio Stations (Preset)

You can store up to 30 FM radio stations and up to 15 AM radio stations.

■ While the broadcast from the radio station you want to preset is being received

1 Set the remote control mode selector to AUDIO.



2 Press **SET**.

- The preset number flashes for approximately 5 seconds.

3 While the preset number is flashing, press the number buttons (**MARK 1** - **TV RETURN 10** or **100+ +10**) to select the preset number you want to use.

- Refer to "Using the number buttons" (page 17).

4 While the selected number is flashing, press **SET**.

- "STORED" appears and the selected radio station is stored.

NOTE

- When you store a radio station to a preset number to which another radio station has previously been stored, the newly set radio station replaces the previously stored radio station.

Tuning In to a Preset Radio Station

■ While an FM or AM broadcast is being received

1 Set the remote control mode selector to AUDIO.



2 Use the number buttons to select the preset number of the radio station to which you want to tune in.

- Refer to "Using the number buttons" (page 17).

Entering radio station names

You can enter the name of a stored radio station using up to 8 characters.

1 Set the remote control mode selector to AUDIO.



2 Press **MD TITLE / EDIT**.

3 Entering a radio station name with

DISP/CHARA or the number buttons (**MARK 1** - **WXYZ 9**).

- To enter radio station names, refer to "Entering Titles" (page 59).

4 Press **ENTER**.

- "STORED" appears in the display window and the entered radio station name is registered.

NOTE

- When you store a radio station after you have entered a radio station name, the entered radio station name with the same preset number is erased.
- You cannot enter radio station names after selecting a radio broadcast with **PREVIOUS** or **NEXT**.
- If you change the AM tuner spacing (page 20), radio station names remain unchanged. Enter radio station names again, if necessary.

Changing the Display in the Display Window

Press **DISP/CHARA**.

- Each time you press **DISP/CHARA**, the display toggles as follows.

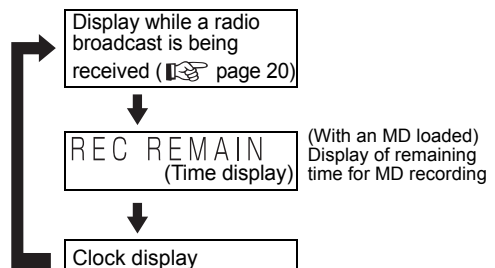

Basic Operations of the DVD Player

How to read this manual

- Operations are described by mainly using the remote control buttons. If there are the same marks on the main unit, the buttons on the main unit can also be used.
- The following marks tell you for which type of the discs the operation can be made.



JPEG

- The illustrations and TV screens may be different between the actual case and the description.
- "VCD" stands for "Video CD".
- "SVCD" stands for "Super Video CD".

Playback

Used frequently



(Refer to page 37 for playing back MP3/WMA and JPEG.)

- 1 Press on the main unit.
 - The disc tray comes out.
- 2 Place a disc on the disc tray.

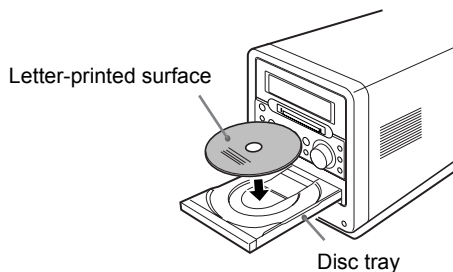

Letter-printed surface

Disc tray

- When you want to listen to an 8 cm disc, place it on the inner hollow of the disc tray.

- 3 Press .

■ Display for DVD VIDEO

Display while a DVD VIDEO is being played back:

DVD indicator
(The DVD indicator lights up while the DVD VIDEO is stopped. The DVD indicator flashes while the DVD VIDEO is being played back or paused.)

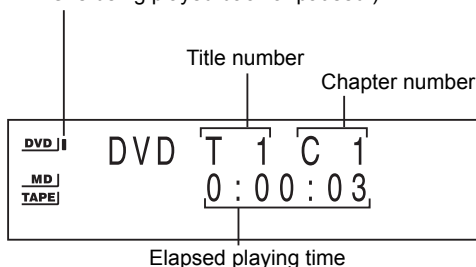

Display while the DVD VIDEO is stopped:

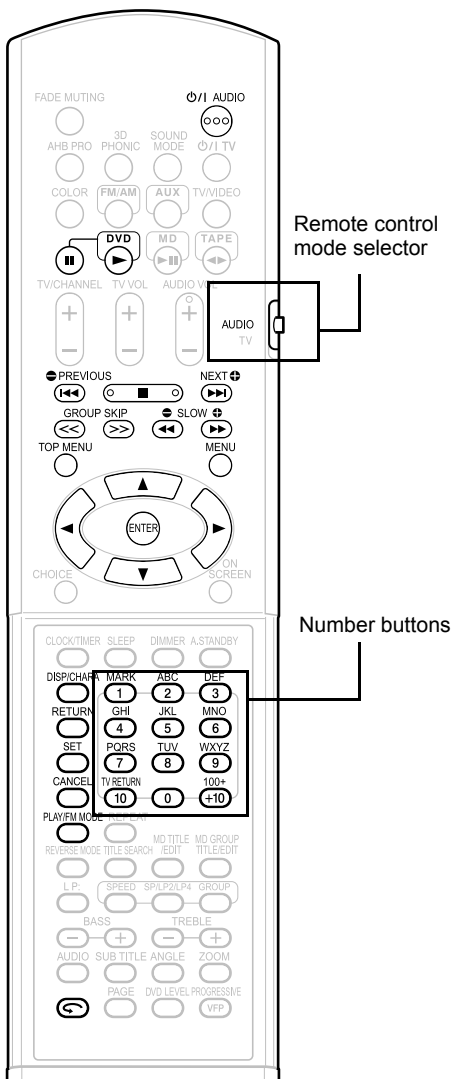
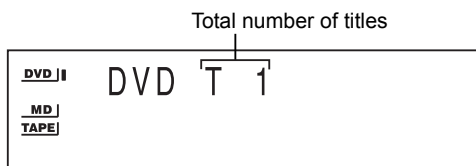

NOTE

- Set the remote control mode selector to before using the number buttons.

(Continued on next page)

■ Display for CD

Display while a CD is being played back:

CD indicator

(The CD indicator lights up while the CD is stopped. The CD indicator flashes while the CD is being played back or paused.)

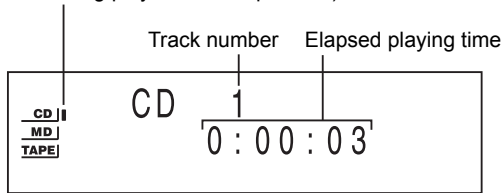

Display while the CD is stopped:

Total number of tracks Total playing time

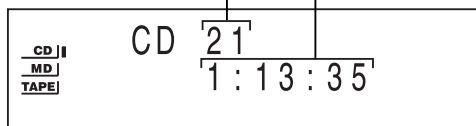

■ Display for DVD AUDIO

Display while a DVD AUDIO is being played back:

DVD indicator

(The DVD indicator lights up while the DVD AUDIO is stopped. The DVD indicator flashes while the DVD AUDIO is being played back or paused.)

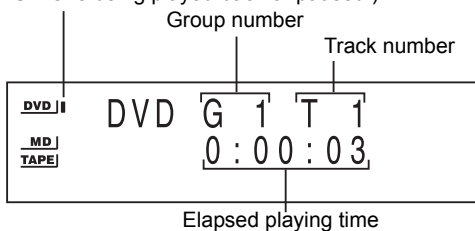

Display while the DVD AUDIO is stopped:

Total number of groups

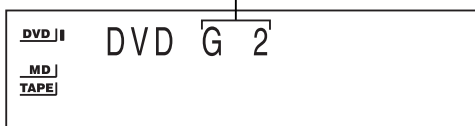

- "G1" and "T1" will appear after the total number of groups is displayed.

■ Display for VCD/SVCD

Display while a VCD/SVCD is being played back:

VCD indicator

(The VCD indicator lights up while the VCD/SVCD is stopped. The VCD indicator flashes while the VCD/SVCD is being played back or paused.)

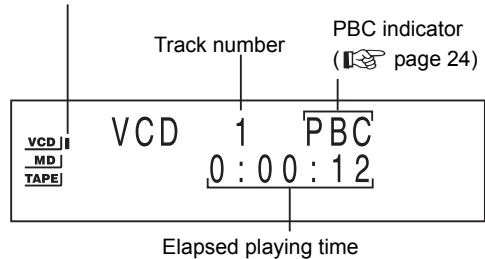

- PBC indicator is displayed while PBC is activated.

Display while the VCD/SVCD is stopped:

Total number of tracks (*1, *2)

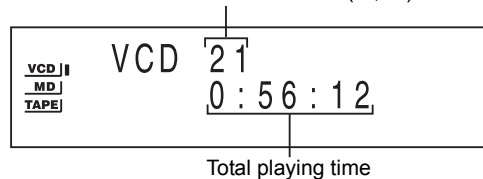

- *1 "1" will appear after the total number of tracks is displayed.
- *2 "PBC" will appear when the disc is PBC-compatible.

NOTE

- The menu may appear in the display window after DVD playback starts. In such a case, select the desired menu item by using the following buttons on the remote control.
- Select a menu item with , or and then press .
- Select a menu item with the number buttons.
- Operation may differ from the explanation given here, depending on the disc type.

Messages displayed on the TV screen

While a DVD is selected as the sound source, the messages shown below are displayed, depending on the status.

NOW READING

The main unit is reading the disc. Wait for a while.

REGION CODE ERROR!

The disc cannot be played back because its region code is not compatible. (☞ page 4)

NO DISC

No disc is loaded.

OPEN

The disc tray is opening.









CLOSE

The disc tray is closing.





CANNOT PLAY

You are trying to play back an unplayable disc.

Guide icons temporarily displayed on the TV screen (on-screen guide)

-  : Play (☞ page 22)
-  : Pause (☞ page 25)
-  : Fast reverse/Fast forward search (☞ page 25)
-  : Slow motion playback (reverse/forward directions)(☞ page 26)
-  : Containing multi-angle views (☞ page 28)
-  : Containing multi-audio (☞ page 27)
-  : Containing multi-subtitle (☞ page 28)
-  : The disc cannot accept the operation you have attempted.

PBC (Playback control)

- PBC is a signal recorded in a VCD (version 2.0) for controlling VCD playback. You can operate software that has interactive or search functions using the menu display recorded in a PBC-compatible VCD. To play back a VCD without PBC, follow the operation below.
 - Select the desired track number with the number buttons while playback is stopped.
 - While playback is stopped, press  or  to select the desired track number, and then press .
 - While a VCD or SVCD is being played back, press  to return to the higher menu group.

Changing the Display in the Display Window

Press  .

- Each time you press , the display toggles as follows.

■ While a disc is being played back (or stopped)

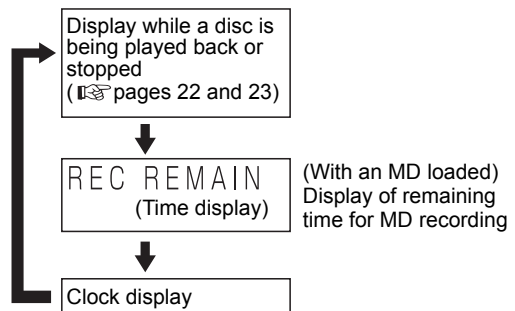

Playing Back from a Position 10 Seconds Before (One Touch Replay)



■ While a disc is being played back

Press .

NOTE

- This operation may not be carried out for some discs.
- You cannot return to the previous title.

Stopping Playback

Used frequently

DVD VIDEO DVD AUDIO VCD SVCD CD MP3 WMA JPEG

■ While a disc is being played back

Press .

Resuming Playback (RESUME)

DVD VIDEO DVD AUDIO VCD SVCD

When playback is stopped in the middle, playback can be started from the stopped scene.

How to suspend playback

■ While a disc is being played back

Perform any of the following operations during playback.

Press  once.*

Press  to turn off the power.

Change the source to FM/AM or AUX.*



* Even if the power is turned off by pressing  after this, the position where playback has been stopped will be stored.



How to start playback from the stored position

Press .

NOTE

- This function does not work in program playback or random playback.
- The position where playback starts again may be a little different from the stopped position.
- When a disc menu is displayed, the resume function may not work.
- The audio, the subtitle and the angle at that time are stored as well as the stopped position.
- The stored position will be cleared if the disc tray is opened. Further, if  is pressed during playback, "RESUME" appears. If  is pressed at this time, "RESUME" will disappear and the stored information will be cleared.
- **Resume function is set to on as the initial preset. You can set the function to off** ( page 40).

Pausing Playback

DVD VIDEO DVD AUDIO VCD SVCD CD MP3 WMA JPEG

■ While a disc is being played back

Press .

To resume normal playback, press .

- Playback cannot be paused by pressing  on the main unit during JPEG disc slide-show.

Advancing Picture Frame by Frame

DVD VIDEO SVCD VCD DVD AUDIO

(only for moving image)

■ While a disc is paused

Press .

- Each time you press , picture will be advanced frame by frame.

- You cannot operate this function with  on the main unit.

Fast Reverse/Fast Forward Search



Used frequently



DVD VIDEO DVD AUDIO VCD SVCD CD

There are two methods.

■ While a disc is being played back

Press  or .

- Each time you press  or , the speed increases as shown below.

×2  ×5  ×10  ×20  ×60

- To restore the normal speed, press .

Hold down  PREVIOUS or NEXT .

- Fast reverse/fast forward search can be carried out only while the button is pressed.

NOTE

- For a DVD VIDEO, SVCD or VCD, no sound comes out during fast reverse/fast forward search.
- For a CD or DVD AUDIO, sound is intermittent during fast reverse/fast forward search.

Slow Motion Playback

DVD VIDEO VCD SVCD DVD AUDIO

(only for moving image)

■ While a disc is paused

Press or .

- Each time you press , the speed increases as shown below.

1/32 ➔ 1/16 ➔ 1/8 ➔ 1/4 ➔ 1/2

- Press to pause playback, and press to resume normal playback.

NOTE

- No sound will be produced.
- The picture motion in the reverse direction may not be smooth.
- For a VCD or SVCD, slow motion playback can be carried out in the forward direction only.

Skipping to the Beginning of a Track

Used frequently

DVD VIDEO DVD AUDIO VCD SVCD CD MP3 WMA JPEG

■ While a disc is being played back*

Press or .

- Each time you press , the current chapter/track/file skips to the beginning of the previous chapter/track/file.
- Each time you press , the current chapter/track/file skips to the beginning of the next chapter/track/file.
- Press or to select a title or group.

NOTE

- * For a VCD or SVCD, this operation can be carried out only during playback without the PBC function.
- Except for a DVD VIDEO, this operation can also be carried out while the disc is stopped.
- This operation may not be carried out for some discs.

Skipping to the Beginning of a Track with the Number Buttons

DVD VIDEO DVD AUDIO VCD SVCD CD MP3 WMA JPEG

■ While a disc is being played back

1 Set the remote control mode selector to AUDIO.



2 Press the number buttons ()- or) to select the track/chapter you want to listen to.

- Refer to "Using the number buttons" (page 17).

NOTE

- You can operate a VCD or SVCD while the disc is stopped or played back with PBC off.
- You can operate a DVD AUDIO, CD, MP3, WMA, or JPEG while the disc is either played back or stopped.
- This operation may not be carried out for some discs.

Selecting a Track from the Menu Screen

DVD VIDEO DVD AUDIO VCD SVCD

■ While a disc is stopped or being played back*

1 Set the remote control mode selector to AUDIO.



2 Press or .

- A menu screen of the disc appears.
- Only can be used for DVD AUDIOS.

3 Press , , , or (only for a DVD VIDEO or a DVD AUDIO) or the number buttons to select a track you want to listen to.

- Refer to "Using the number buttons" (page 17).
- If there are two or more pages of menu screen, press or to change the pages (only for a VCD or SVCD).

4 Press .

NOTE

- * You can operate a VCD or SVCD while PBC is set to off.
- You cannot perform this function with discs to which a menu screen is not recorded.
- Some disc may start playback even if you do not press .

Convenient Functions of the DVD Player

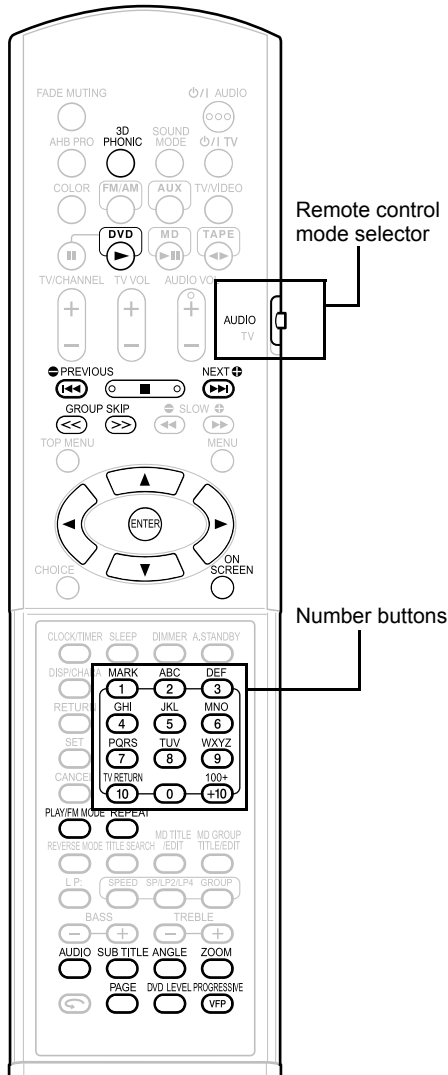

Selecting the Audio Used frequently

DVD VIDEO **DVD AUDIO** **VCD** **SVCD**

■ While a disc containing two or more audio is being played back

1 Press .

Example: TV screen

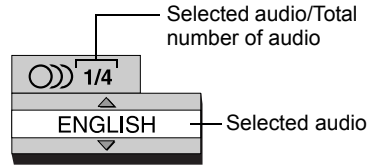

- Each time you press , the audio will be changed. The audio can also be changed by pressing .

2 Wait for a few seconds or press .

NOTE

- You can also operate this function by using the menu bar (page 35).
- For a language code such as "AA", refer to "Language Codes" (page 42).
- When 2 channel sounds are recorded in 1/2 and multi channel sounds with down-mix prohibited are recorded in 2/2 in a DVD AUDIO, you can select 1/2 only.

NOTE

- Set the remote control mode selector to **AUDIO** before using the number buttons.

Selecting the Subtitle



(only for moving image)

- While a disc containing two or more subtitles is being played back

1 Press .

Example: TV screen

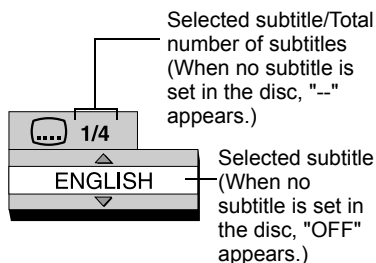

2 Press to select a subtitle.

3 Wait for a few seconds or press



NOTE

- You can also operate this function by using the menu bar (page 35).
- For an SVCD, each time you press in step 1, the subtitle type and ON/OFF will be changed.
- For a language code such as "AA", refer to "Language Codes" (page 42).
- The manner of displaying subtitles may be different depending on the disc.

Canceling the subtitle

Press to select "OFF".

Selecting a View Angle



(only for moving image)

- While a disc containing two or more view angles is being played back

1 Press .

Example: TV screen

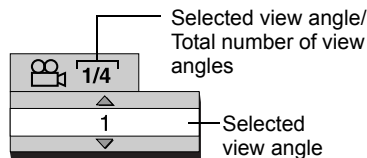

- Each time you press , the angle will be changed. The angle can also be changed by pressing .

2 Wait for a few seconds or press



NOTE

- You can also operate this function by using the menu bar (page 35).

Magnifying the Picture (ZOOM)



(only for moving image)

- While a disc is played back or paused

1 Press .

- Each time you press , the picture magnification will be changed (OFF, ZOOM1 - 6).
- When a JPEG disc is used, the picture magnification changes through "ZOOM 1", "ZOOM 2" to "OFF". You cannot change the picture magnification during slide-show playback.

2 Select the portion you want to see

by pressing .

CAUTION

- When you magnify a picture, image quality may be deteriorated or image may be distorted.

Adjusting the Picture Quality (VFP)

DVD VIDEO DVD AUDIO VCD SVCD JPEG

■ While a disc is played back or paused

1 Press .

Example: TV screen

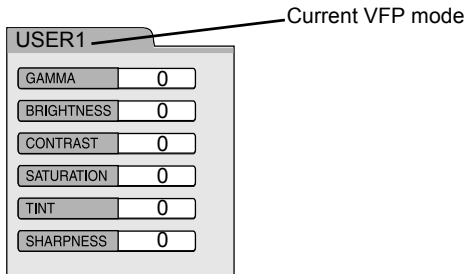

Setting items

- GAMMA** : Controls the brightness of neutral tints while maintaining the brightness of dark and light portions.
(Setting range: **-3 - +3**)
- BRIGHTNESS** : Controls the brightness of the display.
(Setting range: **-8 - +8**)
- CONTRAST** : Controls the contrast of the display.
(Setting range: **-7 - +7**)
- SATURATION** : Controls the saturation of the display.
(Setting range: **-7 - +7**)
- TINT** : Controls the tint of the display.
(Setting range: **-7 - +7**)
- SHARPNESS** : Controls the sharpness of the display.
(Setting range: **-8 - +8**)

2 Press   to select VFP mode.

- NORMAL** : For normal playback.
(You cannot adjust the image quality.) → Go to step 7.
- CINEMA** : Suitable when viewing a movie in a dim room.
(You cannot adjust the image quality.) → Go to step 7.
- USER1/USER2** : You can adjust the image quality.
→ Go to step 3.

3 Press   to select an item you want to adjust.

4 Press .

Example:



5 Press   to change the value.

6 Press .

- To adjust other items, go back to step 3.

7 Press .

NOTE

- If no operation is made for several seconds during the procedure, the settings made so far will be automatically stored.
- "VFP" stands for "video fine processor".

Creating Realistic Sound (3D PHONIC)

DVD VIDEO DVD AUDIO VCD SVCD CD MP3 WMA

The two speakers produce an effect resembling surround-sound.

■ While a disc is being played back

Press .

Example: TV screen

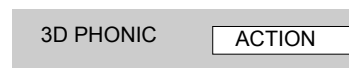

- Each time you press , the display toggles as follows.

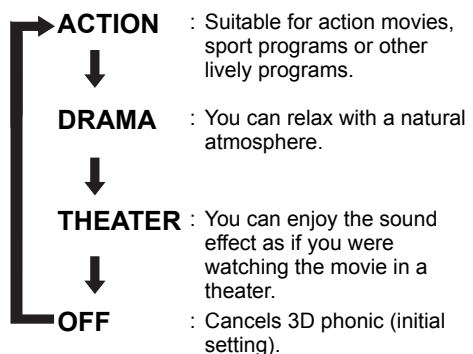

- While 3D phonic is activated,  is displayed in the display window.

NOTE

- 3D phonic is effective for both the speakers and headphones.
- When noise is produced or sound is distorted, set "3D PHONIC" to "OFF".
- You cannot operate some types of DVD AUDIO discs.

Adjusting Playback Level (DVD LEVEL)



The audio of a DVD VIDEO and DVD AUDIO may be recorded at a lower level (volume) than for other types of disc. You can adjust the DVD level.

■ While a disc is being played back

Press .

- Each time you press , the display toggles as follows in the display window.

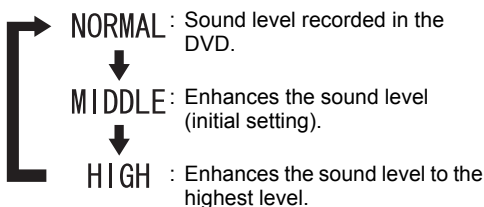

- Select the level while listening to the sound played back.

NOTE

- DVD level is effective only for playback of a DVD.
- Even if the DVD level is changed, the output level from the digital audio output terminal will not be changed.
- This function does not affect recording sound.

Enjoying Better Pictures (PROGRESSIVE)

In the progressive mode, you can enjoy better pictures.

CAUTION

- In order to enjoy pictures in the progressive mode, the following requirements should be met.
- There must be component video input terminals on the TV set connected to the main unit.
- The main unit and the TV set must be connected using a component video cord (page 15).

When the above requirements are not satisfied, leave the main unit in the Interlace mode. If the progressive mode is set, pictures may be distorted.

■ While the disc is played back or paused

Hold down .

- Each time you press , the display toggles as follows.

Interlace mode (initial setting)



Progressive mode



Playing Back the Bonus Group



There are some DVD AUDIO discs with a special group, called "bonus group", recorded.



- This operation can be carried out when "BONUS" is lit in the display window on the main unit.

■ While a disc is being played back

1 Set the remote control mode selector to AUDIO.



2 Press repeatedly during playback to select a bonus group.

- "KEY_ _ _ _" appears on the TV screen and in the display window on the main unit.

3 Press the number buttons to enter a pin code (4 digits).

- The method of getting a pin code is different depending on the disc.

4 Press .

- When a correct pin code is entered, "BONUS" disappears and the playback of the bonus group starts.
- If an incorrect pin code is entered, try entering a correct pin code again.

Browsable Still Pictures (B.S.P.)



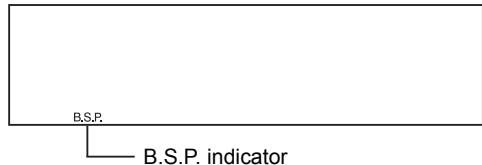

There are some DVD AUDIO discs with still pictures recorded. Among the still pictures, there are pictures called B.S.P. (browsable still pictures). You can change these pictures as if turning over pages.



- This operation can be carried out when "B.S.P." is lit in the display window on the main unit.

■ While a disc is being played back

1 Press .

- Each time you press , the still picture will be switched over.
- You can also change the pictures by pressing  .

Example: TV screen

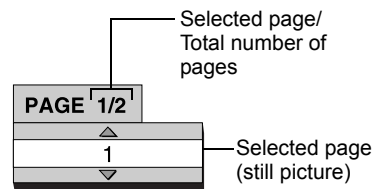

2 Wait for a few seconds or press .

NOTE

- You can operate this function on the menu bar ( page 35).

Playing Back the Disc in the Desired Order (Program Playback)

DVD VIDEO **DVD AUDIO** **VCD** **SVCD** **CD** **MP3 WMA**

You can program a maximum of 99 chapters or tracks. You can program the same chapter or track more than once.

■ While a disc is stopped

1 Set the remote control mode selector to AUDIO.



2 Press **PLAY/FM MODE** to select "PROGRAM".

■ Display for DVD VIDEO

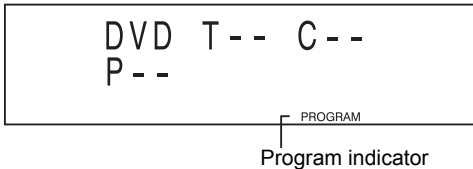

■ Display for DVD AUDIO/MP3/WMA

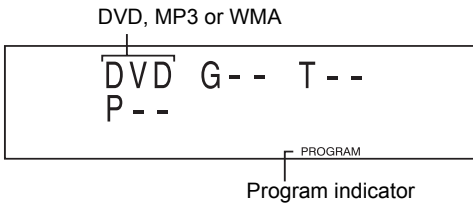

■ Display for CD/VCD/SVCD

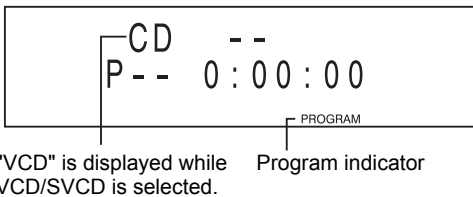

"VCD" is displayed while VCD/SVCD is selected.

Example: For DVD VIDEO

TV screen

No.	Group/Title	Track/Chapter
1		
2		
3		
4		
5		
6		
7		
8		

Program screen

3 Press the number buttons (**1** - **10** or **+10**) to program chapters/tracks.

■ Display for DVD VIDEO

- Select a title number, and then select a chapter number.

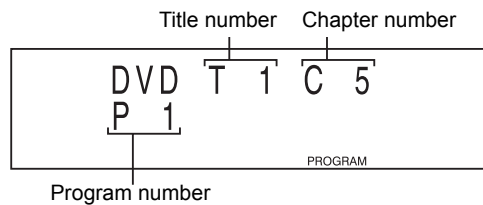

■ Display for DVD AUDIO/MP3/WMA

- Select a group number, and then select a track number.

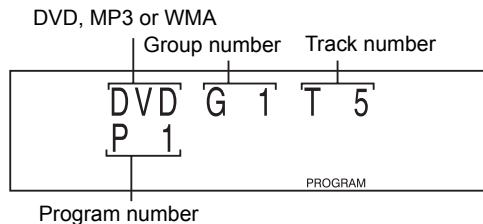

■ Display for CD/VCD/SVCD

- Select a track number.

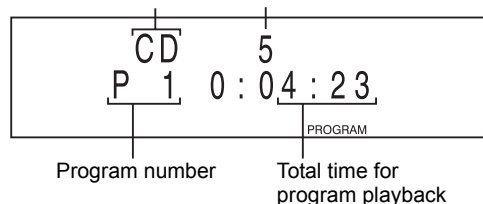

(Continued on next page)

Example: For DVD VIDEO

PROGRAM			TV screen
No.	Group/Title	Track/Chapter	
1	1	5	
2			
3			
4			
5			
6			
7			
8			

- Refer to "Using the number buttons" (page 17).
- Before selecting a bonus group of a DVD AUDIO, cancel the "BONUS" display as explained in "Playing back the Bonus Group" on page 31.
- When you try to enter more than 99 chapters or tracks, "MEMORY FULL" appears.

4 Press 

NOTE

- You can set tracks from either a disc or MD in a program playback setting.

Confirming programmed content

While playback is stopped, press

 **or**  **repeatedly.**

- During this operation, you can add a track as the last in the program, or erase the last track. (step 3)

Canceling program playback

While playback is stopped, press

 **repeatedly to display an item other than "PROGRAM".**

- This operation does not erase the programmed content.

Erasing the whole program

While playback is stopped, hold down



NOTE

- Ejecting the disc or turning off the main unit also erases the programmed content. This operation also cancels program playback.

Random Playback



You can listen to tracks or chapters in random order.

■ While playback is stopped

1 Press  **repeatedly to select "RANDOM".**

Example: For CD



Random indicator

- "RANDOM" appears in the TV screen.

2 Press 

NOTE

- You can set tracks in random playback from either a disc or MD.
- Pressing  repeatedly does not return playback to the previous track.
- Each track is played back once.

Canceling random playback

While playback is stopped, press

 **repeatedly to display an item other than "RANDOM".**

NOTE

- Ejecting the disc or turning off the main unit also cancels random playback.

Repeat Playback



Refer to page 38 for repeat playback of MP3/WMA and JPEG files.

■ While a disc is being played back

Press .

- Each time you press , the repeat type will be changed.

For DVD VIDEO

Repeat types	Display on the TV screen	Display in the display window on the main unit
Repeats the current chapter	CHAP*	REPEAT CHAPTER*
Repeats the current title	TITLE	REPEAT TITLE ALL
Cancels repeat	OFF	REPEAT OFF

For DVD AUDIO

Repeat types	Display on the TV screen	Display in the display window on the main unit
Repeats the current track	TRACK*	REPEAT TRACK*
Repeats the current group	GROUP	REPEAT GROUP GROUP
Cancels repeat	OFF	REPEAT OFF

For CD/VCD/SVCD

Repeat types	Display on the TV screen	Display in the display window on the main unit
Repeats the current track	TRACK*	REPEAT TRACK*
Repeats all tracks	ALL	REPEAT ALL ALL
Cancels repeat	OFF	REPEAT OFF

* "STEP" is displayed during program playback or random playback.

NOTE

- For a VCD and SVCD, the operation can be carried out during playback without the PBC function (page 24).
- You can also operate this function on the menu bar (page 35).
- For details on A-B repeat (repeat playback of a designated part), refer to page 36.

Status Bar and Menu Bar

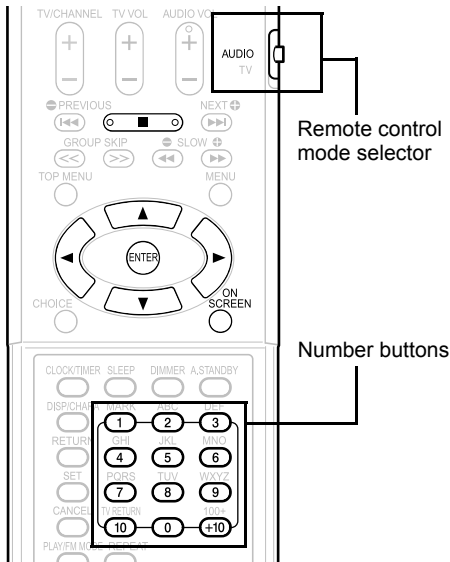

DVD VIDEO DVD AUDIO VCD SVCD CD

You can display the status bar and menu bar on the TV screen, and can control discs with the bars.

CAUTION

- Set the remote control mode selector to **AUDIO** before using the number buttons.

Using the Status Bar and Menu Bar

While a disc is being played back

1 Press **ON SCREEN** twice.

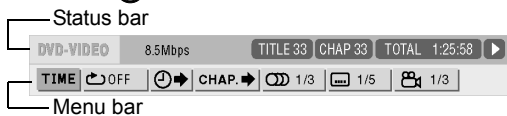

- The above is an example for a DVD VIDEO.

2 Press **LEFT/RIGHT** to select an item you want to operate.

3 Press **ENTER**.

- You can set the selected function. For the setting items, refer to the following "Function list".
- The currently active function shows blue.
- To cancel the menu bar, press **ON SCREEN**.

Function list

Press **UP/DOWN** to select, and press **ENTER** to determine unless otherwise noted.

TIME Time display selection	Changes time information displayed in the display window on the main unit and the status bar. Each time ENTER is pressed, the display will be changed. DVD VIDEO/DVD AUDIO TOTAL : Elapsed playing time of current title/group T.REM : Remaining time of current title/group TIME : Elapsed playing time of current chapter/track REM : Remaining time of current chapter/track CD/VCD/SVCD TIME : Elapsed playing time of current track REM : Remaining time of current track TOTAL : Elapsed playing time of disc T.REM : Remaining time of disc
Repeat mode	page 34
Time search	page 36
/ Chapter search/ Track search	DVD VIDEO/DVD AUDIO Selects a chapter/track. Press the number buttons to enter the chapter/track number and press ENTER . Examples: 5: 5 24: 2 → 4
Audio	DVD VIDEO/DVD AUDIO/VCD/SVCD page 27
Subtitle	DVD VIDEO/DVD AUDIO/SVCD page 28
1/3 View angle	DVD VIDEO/DVD AUDIO page 28
Page switch	DVD AUDIO Switches the still pictures (B.S.P.) recorded on a DVD AUDIO disc. page 31

Information displayed on the status bar

DVD VIDEO/DVD AUDIO (the example below is for a DVD VIDEO)

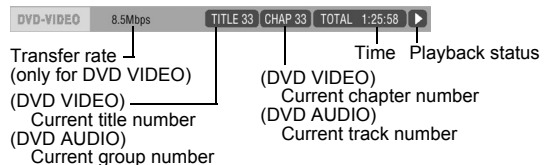

VCD/SVCD/CD (the example below is for a CD)

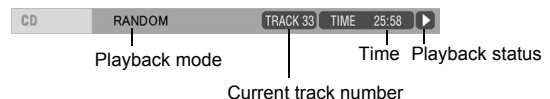











NOTE

- The playback status mark has the same meaning of the mark on the on-screen guide (page 24).



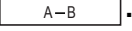

Playing Back the Designated Part Repeatedly (A-B Repeat Playback)

DVD VIDEO DVD AUDIO VCD SVCD CD

■ While a disc is being played back

- 1 Press  twice.
 - The menu bar ( page 35) appears.
- 2 Press  to select .
- 3 Press .
- 4 Press  to select .
- 5 Press  at the starting point of the part to be repeated (designating A point).
 - The icon on the menu bar will be .
- 6 Press  at the end of the part to be repeated (designating B point).
 - The icon on the menu bar will be .
 - "↶ A-B" appears in the display window on the main unit and the part between A and B points is played back repeatedly.

Canceling A-B repeat playback

- To cancel A-B repeat playback:
 - Press .
 - Select  and press  twice. (Select .)

NOTE

- You can operate a VCD and SVCD while the disc is played back with PBC off.
- A-B repeat playback is possible only within the same title or track. A-B repeat playback cannot be carried out during PBC playback, program playback, random playback and repeat playback.





Designate the Time (Time Search)

DVD VIDEO DVD AUDIO VCD SVCD CD



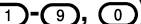

■ While a disc is being played back

- 1 Set the remote control mode selector to AUDIO.



- 2 Press  twice.
 - The menu bar appears ( page 35).
- 3 Press  to select .
- 4 Press .
- 5 Enter the time using the number buttons (.

Example: When you want to play back a disc from the position of (0 hour) 23 minutes 45 seconds, press the buttons in the order:

 →  →  →  → 

- You can skip entering "minutes" and "seconds".
- If you enter wrong numbers, press  to delete the numbers, and then enter the numbers again.

- 6 Press .

- To delete the menu bar, press .

NOTE

- You may not be able to operate this function depending on the disc.
- This function does not work during program playback or random playback.
- For a CD, this operation can always be carried out. For a VCD or SVCD, the operation can be carried out when the disc is stopped or during playback without the PBC function.
- Time search for a DVD VIDEO is from the beginning of the title, for a DVD AUDIO is from the beginning of the track being played back. Time search for a VCD, SVCD and a CD is as follows:
 - When the disc is stopped, time search is from the beginning of the disc.
 - When the disc is being played back, time search is within the track currently being played back.

Playing Back MP3/WMA and JPEG Discs

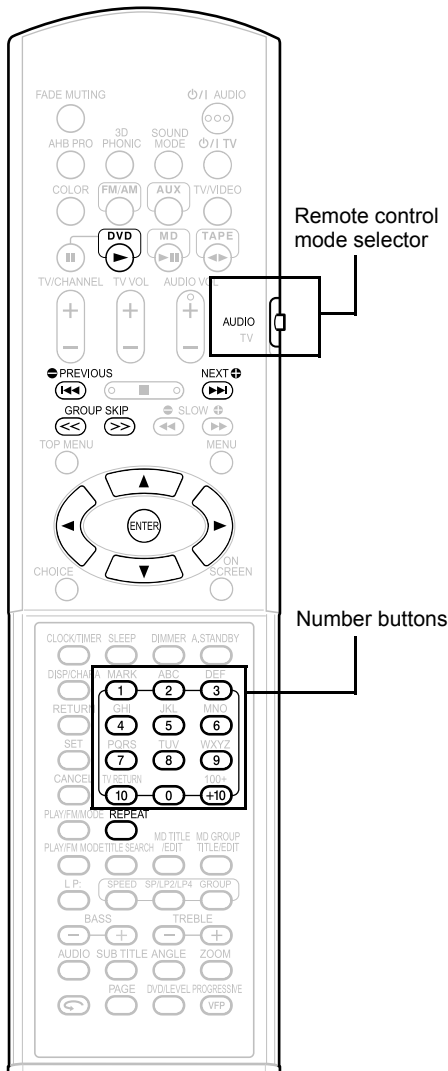

NOTE

- Set the remote control mode selector to **AUDIO** before using the number buttons.

Playback

MP3 **WMA** **JPEG**

Display of an MP3/WMA disc is described here as an example.

For a JPEG disc, read "track" as "file".

NOTE

- When playing back a disc containing both MP3/WMA and JPEG files, set one of them to be played (page 39).

1 Insert a disc.

Example: TV screen

This indicator lights up during repeat playback (page 38).

This indicator lights up during program playback (page 32).

Group list

Elapsed playing time of the selected track (only for MP3/WMA).

FILE	PROGRAM	REPEAT	STEP	Time 00:02:15
Group: 1/10		Track : 1/6 (Total 128)		
spring	1. begonia.mp3			
summer	2. german chamomile.mp3			
fall	3. kiwi fruit.mp3			
winter	4. orchard grass.mp3			
mountain	5. petunia.mp3			
	6. north pale.mp3			
Track Information				
Title				
begonia				
Artist				
nipper kun				
Album				
Voice				

Tag information of the selected track (only for MP3s/WMAs)

Track list (Tracks contained in the selected group)

Example: Display window

Group number	Track number
MP3, G 1	1

"WMA" is displayed when a WMA disc is loaded, and "JPG" is displayed when a JPEG disc is loaded.

2 Press to select a group.

3 Press to move to the track list.

- Pressing returns to the group list.

4 Press to select a track.

5 Press or .

Example: Display during playback

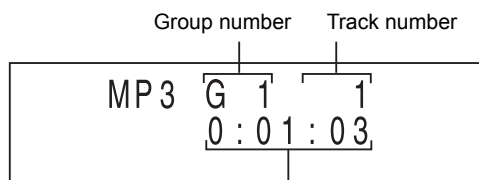

Elapsed playing time
(This indicator is not displayed
while a JPEG is loaded.)

- At first, a track title (file name) is scrolled.
- When an MP3 or WMA is loaded, tag information (title/artist/album) is scrolled followed by a track title.
- Only alphanumerical one-byte characters are displayed properly as a track title or tag information.

NOTE

- You can also use and in step 2.
- You can also use the number buttons in step 4. In this case, steps 3 and 5 are not needed. Refer to "Using the number buttons" (page 17).
- You can also use or in step 4. In this case, step 3 is not needed.

Slide-show playback **JPEG**

- For a JPEG disc, when you press in step 5, files are continuously played back from the selected file (slide-show playback). When you press , only a selected file is played back.
- A file is displayed for approximately 3 seconds in a slide-show playback.
- After all files are played back, the playback is automatically stopped.

Repeat Playback

MP3 **WMA** **JPEG**

■ While a disc is being played back

Press .

- Each time you press , the repeat type is changed.

Repeat types	Display on the TV screen	Display in the display window on the main unit
Repeats the current track (only for MP3/WMA)	REPEAT TRACK*	REPEAT* TRACK
Repeats the current group	REPEAT GROUP	REPEAT GROUP GROUP
Repeats the entire disc	REPEAT ALL	REPEAT ALL ALL
Cancels repeat playback	No display	REPEAT OFF

* "STEP" is displayed during program playback and random playback.

NOTE

- The repeat types can also be changed while the disc is stopped.
- The repeat playback is automatically canceled if there is a file that cannot be played back (page 4).

Preferences

DVD VIDEO DVD AUDIO VCD SVCD CD MP3 WMA JPEG

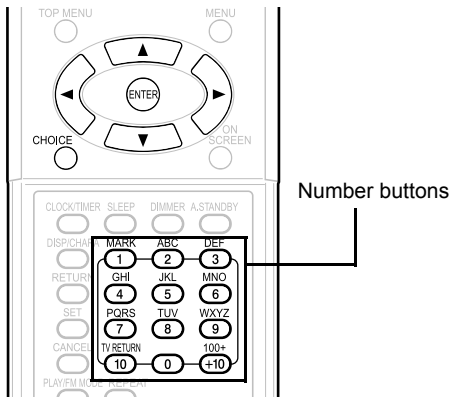

You can change the initial settings of this product according to the environment the product is used in.

CAUTION

- Set the remote control mode selector to **AUDIO** before using the number buttons.

NOTE

- The top and bottom of the preference screen may not be displayed on a wide TV. Adjust the picture size on the TV.

Basic Operations

This section explains basic operation for changing various settings.

- While a disc is stopped or no disc is loaded (while "NO DISC" is displayed)

1 Press

- "SETTING" appears in the display window on the main unit and the following screen appears on the TV.

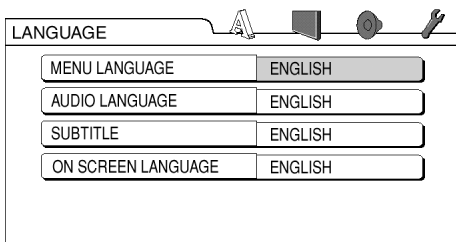

- Proceed with operations by following the description on the TV screen.



LANGUAGE

NOTE

- If the selected language is not recorded on the disc, the optimum language set for the disc appears.
- For a language code such as "AA", refer to the "Language Codes" (page 42).

Items	Contents
MENU LANGUAGE	Select the language for the DVD VIDEO menu.
AUDIO LANGUAGE	Select the audio language for the DVD VIDEO.
SUBTITLE	Select the subtitle language for the DVD VIDEO.
ON SCREEN LANGUAGE	Select the language displayed on the preference screens.



PICTURE

Items	Contents (: initial setting)
MONITOR TYPE	<p>Select a display method suitable for your TV. 16 : 9 / 16 : 9 MULTI (wide TV): Select this item when the aspect ratio of your wide TV is fixed to 16:9 (when playing back a DVD VIDEO recorded at 4:3, this product automatically adjusts the screen width of the output signal).</p>  <p>4 : 3 LB / 4 : 3 MULTI LB (letter box) : Select this item when the aspect ratio of your TV is conventional 4:3. While viewing a wide screen picture, the black bars appear on the top and bottom of the screen.</p>  <p>4 : 3 PS / 4 : 3 MULTI PS (pan scan): Select this item when the aspect ratio of your TV is conventional 4:3. While viewing a wide screen picture, the left and right edges of the picture will not be shown on the screen. (If the disc is not compatible with the pan scan, the picture will be displayed at the letter box ratio.)</p> 
PICTURE SOURCE	<p>Select an item suitable to the video source. VIDEO: Select this item when you want to view a normal video. FILM: Select this item when you want to view a film or video recorded with the progressive scan method. AUTO: The video source type (a video or film) is automatically selected.</p>
SCREEN SAVER	Select the screen saver mode between ON / OFF (screen saver activates when there is no operation made for about 5 minutes since a still picture was last displayed).
FILE TYPE	If a disc includes an AUDIO file (MP3/WMA) and a still picture file (JPEG), select which file is played back. If you change this setting, open and close the disc tray, or momentarily turn off the main unit. (A disc either with audio files or still picture files can be played back regardless of this setting.)

AUDIO

Items	Contents ( : initial setting)
DIGITAL AUDIO OUTPUT	<p>Select an output signal type from the following in accordance with the equipment connected to the digital audio output terminal (AV amplifier, etc.). (See the list below for the preference items and output signal.)</p> <p>PCM ONLY: Equipment corresponding only to linear PCM.</p> <p>DOLBY DIGITAL/PCM: Dolby digital decoder or equipment having the same function.</p> <p>STREAM/PCM : DTS/Dolby digital decoder or equipment having the same function.</p>
DOWN MIX	<p>Switch signal from the digital output terminal of the DVD VIDEO according to the connected equipment. Select this when Digital Audio Output is set to "PCM ONLY".</p> <p>DOLBY SURROUND : A dolby pro logic decoder-built-in equipment.</p> <p>STEREO: An ordinary equipment.</p> <ul style="list-style-type: none"> When 3D phonic is activated, Down Mix does not work.
D (Dynamic) RANGE COMPRESSION	<p>To make adjustments for the difference between a high volume and a low volume when playing back with low volume (only for a DVD recorded with Dolby digital).</p> <p>AUTO : D. range compression automatically works.</p> <p>ON: D. range compression always works.</p>

OTHERS

Items	Contents ( : initial setting)
RESUME	( page 25)
ON SCREEN GUIDE	Select whether you display guide icons on the on-screen guide indicating status of a disc/main unit (For details on the guide icons, refer to page 24)
AV COMPU LINK MODE	<p>When you want to control JVC TV by using this product, select a mode that matches the terminal from the following. (For more details, refer to "Using AV COMPU LINK" on page 73.)</p> <p>DVD1 : Connect to the video-3 input on the TV set.</p> <p>DVD2: Connect to the video-1 input of the TV set.</p> <p>DVD3: Connect to the video-2 input of the TV set.</p>
PARENTAL LOCK	<p>Set the parental lock function to cut off violent scenes or replace the scenes with others. (This is effective only for discs equipped with the parental lock function.)</p> <p>COUNTRY CODE ( page 41) Select your country or area.</p> <p>SET LEVEL: The restriction is stricter as the number becomes smaller. "NONE" is no restriction.</p> <p>PASSWORD (essential): Enter four-digit number as your password using the number buttons (1-9, 0) every time. (Enter "8888" if you forget your password.) The password is required at the time of playback.</p> <ul style="list-style-type: none"> If you enter a wrong password three times, "EXIT" will be automatically selected.

List of relationships of DIGITAL AUDIO OUTPUT preference items and output signal

Playback disc	DIGITAL AUDIO OUTPUT preference		
	STREAM/PCM	DOLBY DIGITAL/PCM	PCM ONLY
48 kHz, 16/20/24 bits Linear PCM DVD VIDEO 96 kHz linear PCM DVD VIDEO	48 kHz, 16 bits stereo linear PCM		
48/96/192 kHz, 16/20/24 bits linear PCM DVD AUDIO	48 kHz, 16 bits stereo linear PCM		
44.1/88.2/176.4 kHz, 16/20/24 bits linear PCM DVD AUDIO	44.1 kHz, 16 bits stereo linear PCM		
DTS DVD VIDEO	DTS bit stream	48 kHz, 16 bits stereo linear PCM	
DOLBY DIGITAL DVD VIDEO/ DVD AUDIO	DOLBY DIGITAL bit stream		48 kHz, 16 bits stereo linear PCM
CD/VCD/SVCD	44.1 kHz, 16 bits stereo linear PCM/48 kHz, 16 bits linear PCM		
DTS CD	DTS bit stream	44.1 kHz, 16 bits linear PCM	
MP3/WMA disc	32/44.1/48 kHz, 16 bits linear PCM		

NOTE

- For a DVD VIDEO without content protection set, there is a 20 bit or 24 bit output at the digital audio output terminal.

Country/Area Codes

AD	Andorra
AE	United Arab Emirates
AF	Afghanistan
AG	Antigua and Barbuda
AI	Anguilla
AL	Albania
AM	Armenia
AN	Netherlands Antilles
AO	Angola
AQ	Antarctica
AR	Argentina
AS	American Samoa
AT	Austria
AU	Australia
AW	Aruba
AZ	Azerbaijan
BA	Bosnia and Herzegovina
BB	Barbados
BD	Bangladesh
BE	Belgium
BF	Burkina Faso
BG	Bulgaria
BH	Bahrain
BI	Burundi
BJ	Benin
BM	Bermuda
BN	Brunei Darussalam
BO	Bolivia
BR	Brazil
BS	Bahamas
BT	Bhutan
BV	Bouvet Island
BW	Botswana
BY	Belarus
BZ	Belize
CA	Canada
CC	Cocos (Keeling) Islands
CF	Central African Republic
CG	Congo
CH	Switzerland
CI	Côte d'Ivoire
CK	Cook Islands
CL	Chile
CM	Cameroon
CN	China
CO	Colombia
CR	Costa Rica
CU	Cuba
CV	Cape Verde
CX	Christmas Island
CY	Cyprus
CZ	Czech Republic
DE	Germany
DJ	Djibouti
DK	Denmark
DM	Dominica
DO	Dominican Republic
DZ	Algeria
EC	Ecuador
EE	Estonia
EG	Egypt
EH	Western Sahara
ER	Eritrea

ES	Spain
ET	Ethiopia
FI	Finland
FJ	Fiji
FK	Falkland Islands (Malvinas)
FM	Micronesia (Federated States of)
FO	Faroe Islands
FR	France
FX	France, Metropolitan
GA	Gabon
GB	United Kingdom
GD	Grenada
GE	Georgia
GF	French Guiana
GH	Ghana
GI	Gibraltar
GL	Greenland
GM	Gambia
GN	Guinea
GP	Guadeloupe
GQ	Equatorial Guinea
GR	Greece
GS	South Georgia and the South Sandwich Islands
GT	Guatemala
GU	Guam
GW	Guinea-Bissau
GY	Guyana
HK	Hong Kong
HM	Heard Island and McDonald Islands
HN	Honduras
HR	Croatia
HT	Haiti
HU	Hungary
ID	Indonesia
IE	Ireland
IL	Israel
IN	India
IO	British Indian Ocean Territory
IQ	Iraq
IR	Iran (Islamic Republic of)
IS	Iceland
IT	Italy
JM	Jamaica
JO	Jordan
JP	Japan
KE	Kenya
KG	Kyrgyzstan
KH	Cambodia
KI	Kiribati
KM	Comoros
KN	Saint Kitts and Nevis
KP	Korea, Democratic People's Republic of
KR	Korea, Republic of
KW	Kuwait
KY	Cayman Islands
KZ	Kazakhstan
LA	Lao People's Democratic Republic
LB	Lebanon

LC	Saint Lucia
LI	Liechtenstein
LK	Sri Lanka
LR	Liberia
LS	Lesotho
LT	Lithuania
LU	Luxembourg
LV	Latvia
LY	Libyan Arab Jamahiriya
MA	Morocco
MC	Monaco
MD	Moldova, Republic of
MG	Madagascar
MH	Marshall Islands
ML	Mali
MM	Myanmar
MN	Mongolia
MO	Macau
MP	Northern Mariana Islands
MQ	Martinique
MR	Mauritania
MS	Montserrat
MT	Malta
MU	Mauritius
MV	Maldives
MW	Malawi
MX	Mexico
MY	Malaysia
MZ	Mozambique
NA	Namibia
NC	New Caledonia
NE	Niger
NF	Norfolk Island
NG	Nigeria
NI	Nicaragua
NL	Netherlands
NO	Norway
NP	Nepal
NR	Nauru
NU	Niue
NZ	New Zealand
OM	Oman
PA	Panama
PE	Peru
PF	French Polynesia
PG	Papua New Guinea
PH	Philippines
PK	Pakistan
PL	Poland
PM	Saint Pierre and Miquelon
PN	Pitcairn
PR	Puerto Rico
PT	Portugal
PW	Palau
PY	Paraguay
QA	Qatar
RE	Réunion
RO	Romania
RU	Russian Federation
RW	Rwanda
SA	Saudi Arabia
SB	Solomon Islands
SC	Seychelles

SD	Sudan
SE	Sweden
SG	Singapore
SH	Saint Helena
SI	Slovenia
SJ	Svalbard and Jan Mayen
SK	Slovakia
SL	Sierra Leone
SM	San Marino
SN	Senegal
SO	Somalia
SR	Suriname
ST	Sao Tome and Principe
SV	El Salvador
SY	Syrian Arab Republic
SZ	Swaziland
TC	Turks and Caicos Islands
TD	Chad
TF	French Southern Territories
TG	Togo
TH	Thailand
TJ	Tajikistan
TK	Tokelau
TM	Turkmenistan
TN	Tunisia
TO	Tonga
TP	East Timor
TR	Turkey
TT	Trinidad and Tobago
TV	Tuvalu
TW	Taiwan
TZ	Tanzania, United Republic of
UA	Ukraine
UG	Uganda
UM	United States Minor Outlying Islands
US	United States
UY	Uruguay
UZ	Uzbekistan
VA	Vatican City State (Holy See)
VC	Saint Vincent and the Grenadines
VE	Venezuela
VG	Virgin Islands (British)
VI	Virgin Islands (U.S.)
VN	Viet Nam
VU	Vanuatu
WF	Wallis and Futuna Islands
WS	Samoa
YE	Yemen
YT	Mayotte
YU	Yugoslavia
ZA	South Africa
ZM	Zambia
ZR	Zaire
ZW	Zimbabwe

Language Codes

Code	Language	Code	Language
AA	Afar	MK	Macedonian
AB	Abkhazian	ML	Malayalam
AF	Afrikaans	MN	Mongolian
AM	Ameharic	MO	Moldavian
AR	Arabic	MR	Marathi
AS	Assamese	MS	Malay (MAY)
AY	Aymara	MT	Maltese
AZ	Azerbaijani	MY	Burmese
BA	Bashkir	NA	Nauru
BE	Byelorussian	NE	Nepali
BG	Bulgarian	NL	Dutch
BH	Bihari	NO	Norwegian
BI	Bislama	OC	Occitan
BN	Bengali, Bangla	OM	(Afan) Oromo
BO	Tibetan	OR	Oriya
BR	Breton	PA	Panjabi
CA	Catalan	PL	Polish
CO	Corsican	PS	Pashto, Pushto
CS	Czech	PT	Portuguese
CY	Welsh	QU	Quechua
DA	Danish	RM	Rhaeto-Romance
DZ	Bhutani	RN	Kirundi
EL	Greek	RO	Rumanian
EO	Esperanto	RU	Russian
ET	Estonian	RW	Kinyarwanda
EU	Basque	SA	Sanskrit
FA	Persian	SD	Sindhi
FI	Finnish	SG	Sangho
FJ	Fiji	SH	Serbo-Croatian
FO	Faroese	SI	Singhalese
FY	Frisian	SK	Slovak
GA	Irish	SL	Slovenian
GD	Scots Gaelic	SM	Samoan
GL	Galician	SN	Shona
GN	Guarani	SO	Somali
GU	Gujarati	SQ	Albanian
HA	Hausa	SR	Serbian
HI	Hindi	SS	Siswati
HR	Croatian	ST	Sesotho
HU	Hungarian	SU	Sundanese
HY	Armenian	SV	Swedish
IA	Interlingua	SW	Swahili
IE	Interlingue	TA	Tamil
IK	Inupiak	TE	Telugu
IN	Indonesian	TG	Tajik
IS	Icelandic	TH	Thai
IW	Hebrew	TI	Tigrinya
JI	Yiddish	TK	Turkmen
JW	Javanese	TL	Tagalog
KA	Georgian	TN	Setswana
KK	Kazakh	TO	Tonga
KL	Greenlandic	TR	Turkish
KM	Cambodian	TS	Tsonga
KN	Kannada	TT	Tatar
KO	Korean (KOR)	TW	Twì
KS	Kashmiri	UK	Ukrainian
KU	Kurdish	UR	Urdu
KY	Kirghiz	UZ	Uzbek
LA	Latin	VI	Vietnamese
LN	Lingala	VO	Volapuk
LO	Laothian	WO	Wolof
LT	Lithuanian	XH	Xhosa
LV	Latvian, Lettish	YO	Yoruba
MG	Malagasy	ZU	Zulu
MI	Maori		

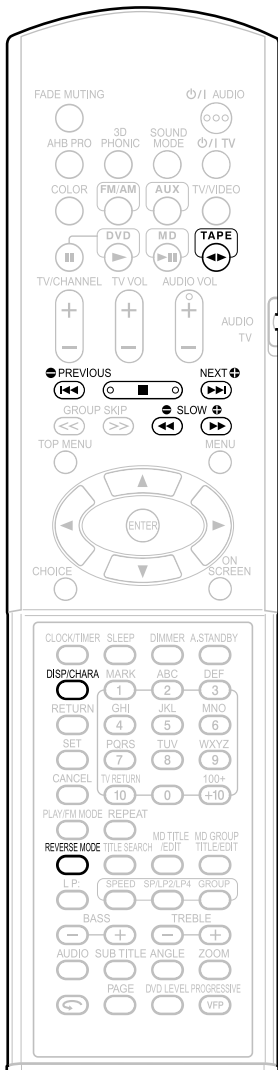

1 Insert a cassette tape.

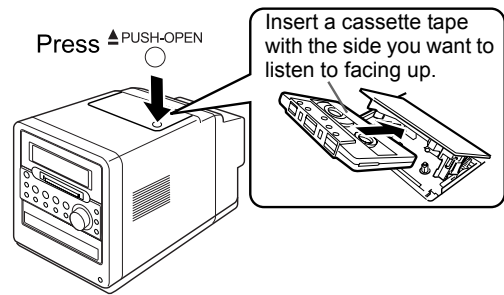

Cassette tape indicator
 (The cassette tape indicator lights up while the cassette tape is stopped. The cassette tape indicator flashes while the cassette tape is being played back.)

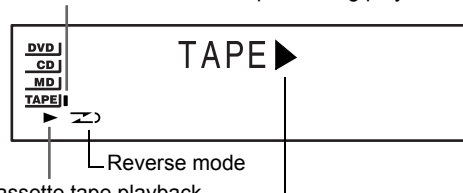

Cassette tape playback direction
 (▶: normal direction / ◀: opposite direction)

CAUTION



- Before using a cassette tape, wind up any slack in the cassette tape. (▶ page 75)
- Do not use long cassette tapes such as C-120 or C-150. Long cassette tapes are thin and stretch easily, and may become tangled in the inner part of the main unit.
- This product is compatible with playback of TYPE I cassette tapes. Playback of TYPE II or TYPE IV cassette tapes is not recommended, because this product does not meet the specifications for these tapes. The main unit does not produce the proper sound from these cassette tape types.

2 Press ^{REVERSE MODE} repeatedly to select the reverse mode.

- ▶◀ : For one return playback of both sides.
- ◀▶ : For repeated playback of both sides (Playback continues until playback is stopped.)
- ▶ : For one-way playback of either side.

Operation	
Stop	Press .
Fast forward/ Rewind	<p>Press or .</p> <ul style="list-style-type: none"> • When a cassette tape is played back in the normal direction (▶), is fast forward and is rewind. • When the cassette tape is played back in the opposite direction (◀), is fast forward and is rewind. • You can perform the same operation by pressing or .

3 Press .

- Playback starts.
- When the main unit is turned off, pressing  automatically turns on the main unit.
- Each time you press , the cassette tape playback direction changes. The initial playback direction after you have inserted a cassette tape is always the normal direction.
- The cassette tape playback direction indicator facing right ► is displayed during normal playback. The indicator facing left ◀ is displayed during reverse playback.

Changing the Display in the Display Window

Press .

- Each time you press , the display toggles as follows.

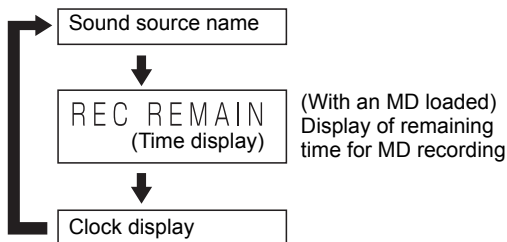

Listening to Other Equipment

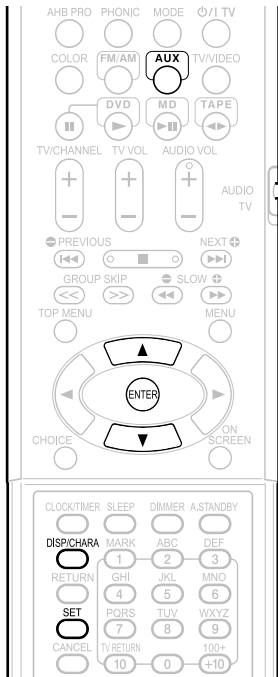

1 Press .

- Each time you press , the display toggles as follows.

AUX : To listen to sound from other equipment connected to the AUX terminals on the main unit.

AUX-DIGITAL : To listen to sound from other equipment connected to the OPTICAL DIGITAL IN terminal on the main unit.

2 Start other equipment playback.

- Refer to the operation manual for the connected equipment.

3 Adjust the volume and make other necessary settings.

- For adjusting the volume and making other necessary settings, refer to "Basic Operations" (page 18).

Adjusting the Sound Input Level from Other Equipment

Adjusting the sound input level of the AUX

1 Press  repeatedly to select "AUX".

2 (With "AUX" being displayed) Hold down  until the input level appears.

- Each time you hold down , the display toggles as follows.



LEVEL 1 For ordinary use. (initial setting)

LEVEL 2 For increasing the level.

Adjusting the sound input level of the AUX-DIGITAL

1 Press  repeatedly to select "AUX-DIGITAL".

2 (With "AUX-DIGITAL" being displayed) Hold down  until the input level appears.

3 Press  or  to adjust the input level.

- You can adjust the input level within the range of -12 dB to 12 dB (in increments of 2 dB). The initial setting is 0 dB.

4 Press .

Changing the Display in the Display Window

Press .

- Each time you press , the display toggles as follows.

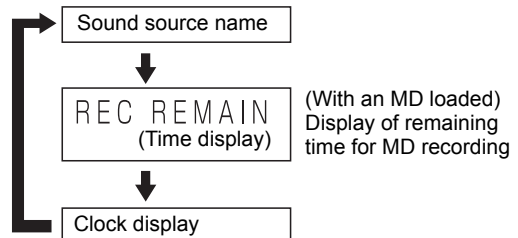

Listening to MDs

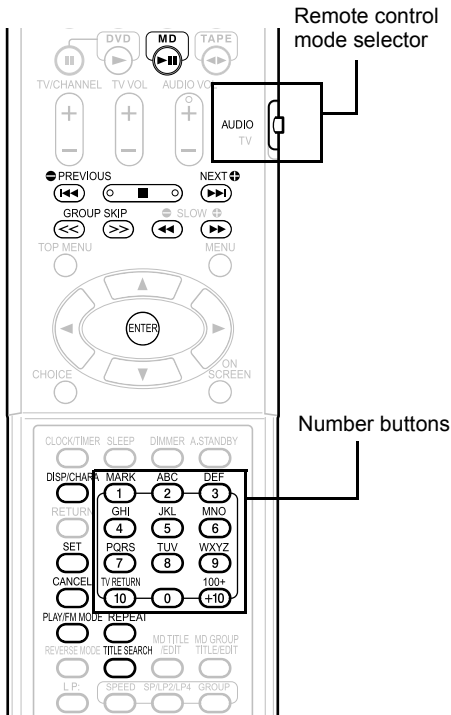

NOTE

- Set the remote control mode selector to **AUDIO** before using the number buttons.

	Operation
Stop	Press .
Pause	Press during playback. Pressing again resumes playback.
Skip	<ul style="list-style-type: none"> : Press the button repeatedly. :
Fast forward/ Rewind (Search)	<ul style="list-style-type: none"> : Hold down the button during playback. : <p>Press the button during playback. (Pressing during search resumes normal playback.)</p>
Eject	Press on the main unit.

Listening to MDs Used frequently

When the main unit is turned on

1 Insert an MD.

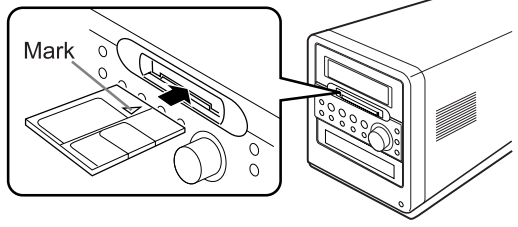

CAUTION

- Do not insert an MD while the main unit is turned off. Forcibly inserting an MD may damage the main unit.

2 Press .

Display while an MD is being played back

MD indicator
 (The MD indicator lights up while the MD is stopped. The MD indicator flashes while the MD is being played back or paused.)

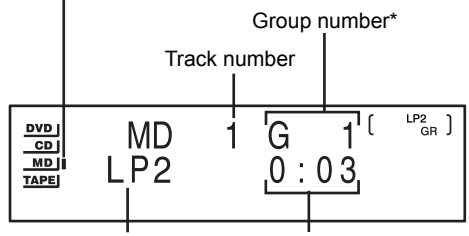

MDLP mode (page 51) Elapsed playing time

- When the track title has been set to the track, the track title appears first.
- * When the track being played back does not belong to a group, "G - -" appears.

CAUTION

- Do not insert another MD while the MD indicator is lighting up or flashing. Forcibly inserting an MD may damage the main unit.

Display while the MD is stopped

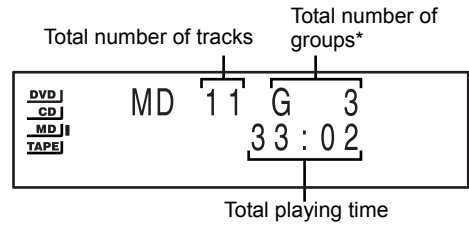

- When the MD title (the disc title) has been set to the MD, the MD title appears first.
- Long titles are scrolled.
- * When no group belongs to the MD, "G - -" appears.

Changing the Display in the Display Window

Press .

- Each time you press , the display toggles as follows.

■ While an MD is being played back

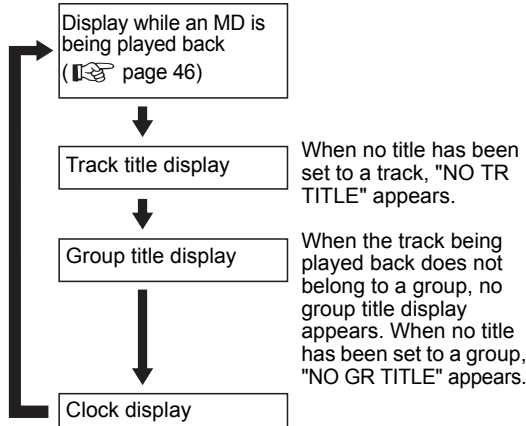

■ While an MD is stopped

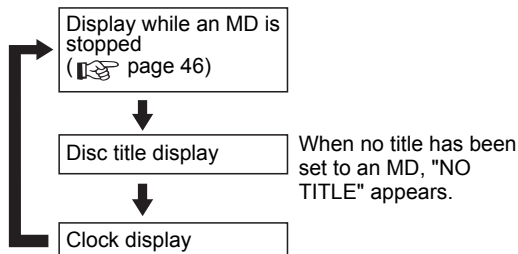

NOTE

- While an MD is selected as the sound source, when you insert an MD to which nothing has been recorded, "BLANK DISC" appears.

Group Playback of an MD

You can play back just the tracks from a group which you want to listen to.

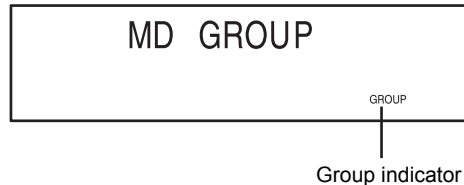

■ While an MD is stopped

1 Press  repeatedly to select "GROUP".



2 Press .

- Group 1 playback starts.
- If there is no group, "GROUP" disappears and normal playback starts.

3 Press  or  to select a group.

- When playback of all tracks in the selected group finishes, playback automatically stops.

Canceling group playback

While playback is stopped, press

 repeatedly to select an item other than "GROUP".



NOTE

- Ejecting the MD or turning off the main unit also cancels group playback.

Specifying the Track (Direct Track Selection)

1 Set the remote control mode selector to AUDIO.



2 Press the number buttons ( -  or ) to select the track you want to listen to.

- Refer to "Using the number buttons" (page 17).

Program Playback

This function allows you to program up to 32 tracks.

■ While the MD is stopped

1 Set the remote control mode selector to AUDIO.



2 Press to select "PROGRAM".

Example: Display while MD program playback is selected

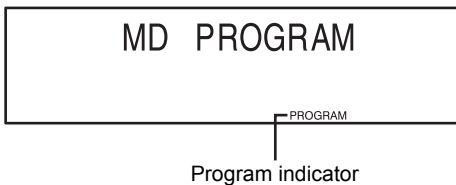

3 Press the number buttons (, , or) to select the track numbers.

• Refer to "Using the number buttons" (page 17).

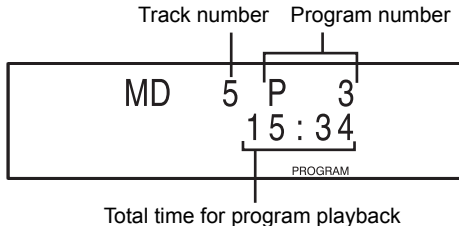

NOTE

- When you want to erase the program, press while playback is stopped. Programmed tracks are erased one by one from the last track. Holding down erases all programmed tracks.
- When you try to program the 33rd track, "MEMORY FULL" appears in the display window to indicate that 33 or more tracks cannot be programmed.
- When total time for program playback reaches 2 hours 31 minutes for an MD, "--:--" appears.

4 Press .

NOTE

- You can set tracks for program playback either from a CD, MD or DVD.

Confirming the programmed track order

While playback is stopped, press

or repeatedly.

- You can add a track as the last track in the program, or erase the last track. (step 3)

Canceling the program playback

While playback is stopped, press

repeatedly to display an item other than "PROGRAM".

- This operation does not erase the program.

Erasing all the programmed tracks

While playback is stopped, hold down

.

NOTE

- Ejecting the MD or turning off the main unit also erases all the programmed tracks. This operation also cancels program playback.

Random Playback

This function allows you to listen to tracks in random order.

■ While a disc is stopped

1 Press repeatedly to select "RANDOM".

Example: Display while MD random playback is selected

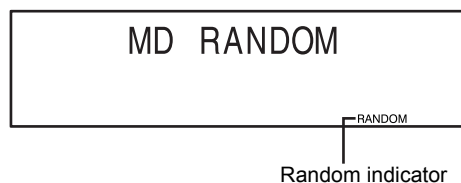

2 Press .

NOTE

- You can set tracks for random playback either from a CD, MD or DVD.
- Pressing repeatedly does not return playback to the previous track.
- Each track is played back once.

Canceling the random playback

While playback is stopped, press
PLAY/FM MODE
 **repeatedly to display an item other than "RANDOM".**

NOTE

- Ejecting the MD or turning off the main unit also cancels random playback.

Repeat Playback

This function allows you to repeatedly listen to the same track.

During MD playback, press REPEAT
 **repeatedly to select the repeat mode.**

- Each time you press REPEAT , the display toggles as follows.

Example: While "REPEAT ALL" is selected



Repeat indicator

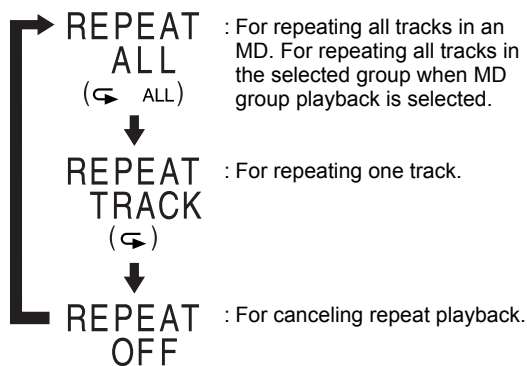

NOTE

- Ejecting the MD or turning off the main unit also cancels repeat playback.

Searching Titles

This function allows you to search titles for tracks or groups in an MD.

■ While a disc is stopped

1 Set the remote control mode selector to AUDIO.



2 Press TITLE SEARCH
 **repeatedly to select the search type.**

TRACK
T. SEARCH

For searching track titles.

"T" stands for "Title".

GROUP
T. SEARCH

For searching group titles. (This function is available only when there are groups.)

3 Press SET
.

Example: Display while track titles are being searched



While group titles are being searched, "GROUP SEARCH" is displayed.

4 Enter the title you want to search.

- Enter the first one to five characters of the title.
Example: Entering "F" searches titles starting with "F" in order of track number.

Entering "Frien" searches titles starting with "Frien" in order of track number.

- For entering titles, refer to "Entering Titles" ( page 59).
- When searching tracks or groups with no titles, enter nothing, and then proceed to step 5.



5 Press ENTER
.

- "SEARCH" appears and the title search starts. When the title is found, playback of the track starts. When playback finishes, the next title search automatically starts.

NOTE

- A space is treated as a character. However, when no character exists after the space, the space is ignored.
- Capital letters and small letters are distinguished.
- When no corresponding titles are found, "SEARCH END" appears.

Searching another track or group title

Press  (or ).

Quitting the title search

Press  .

- The title search is canceled and playback returns to the beginning of the current track.

SEARCH END

Recording Sound to MDs Used frequently

Main unit

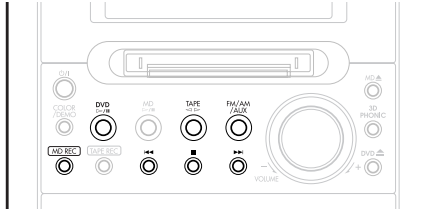

Remote control

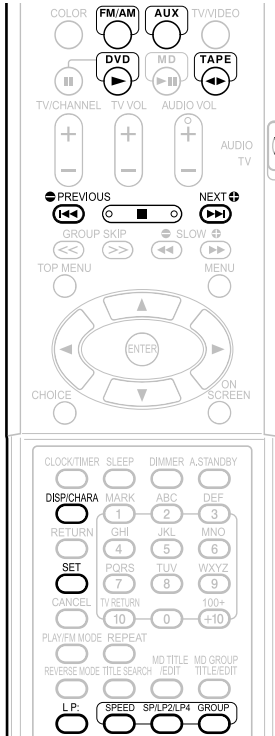

Recording All Tracks from a Disc to an MD

- 1 Press , and then press .**
 - The DVD is selected as the sound source and **playback is stopped**.
- When recording sound from DVD VIDEOS
 - Play back a title or chapter, pause playback, and then press to return to the beginning of the first title/chapter.
 - You may not be able to record a DVD VIDEO depending on the disc.
- 2 Insert an MD.**
 - Close the write protect knob on the MD beforehand (page 75).

- 3 Press to select the MDLP mode.**
 - Each time you press , the display toggles as follows.
 - SP : For standard stereo recording (Maximum recording time is 80 minutes with an MD 80).
 - ↓
 - LP2 : For ×2 extended stereo recording (Maximum recording time is 160 minutes with an MD 80).
 - ↓
 - LP4 : For ×4 extended stereo recording (Maximum recording time is 320 minutes with an MD 80).
 - As you change the MDLP mode (SP→LP2→LP4), the sound quality also changes. When you want to record sound at the best possible quality, select the SP mode.
 - When you use an MD car audio system, portable MD player or other MD player that is not compatible with the MDLP mode, select the SP mode.

- 4 Press to set group recording.**
 - Each time you press , the display toggles as follows.
 - GROUP REC: Activates group recording (initial setting).
 - ON
 - ↕
 - GROUP REC: Cancels group recording.
 - OFF
 - You can form or cancel a group after the recording finishes. (pages 63 and 66)

- 5 Press to select the recording speed.**
 - Each time you press , the display toggles as follows.
 - HIGH SPEED : ×5 high speed recording (only for CDs)
 - ↕
 - NORMAL REC : Normal speed recording
 - Select "NORMAL REC" when you want to play back a disc other than a CD.
 - Recorded sound quality is the same for both "HIGH SPEED" and "NORMAL REC".
 - You cannot listen to the sound during ×5 high speed recording.

6 Press on the main unit.

Example: Display while CD is recorded

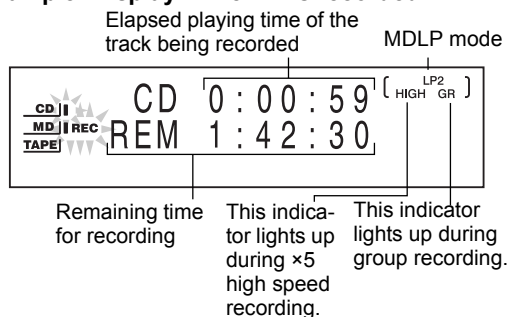

- When recording finishes, the color pattern of the display window and disc tray changes to the color pattern set in "MANUAL" to inform you that recording has finished ( page 19).
- When "HCMS CANNOT COPY" appears, refer to pages 74 and 76.

NOTE

- The recorded sound level is automatically adjusted.
- The CD rotates at high speed during x5 high speed recording. Therefore, depending on the condition of the CD, the sound may be recorded improperly and affected by noise. If the sound is not recorded properly, select normal speed recording.
- The remaining time for recording differs depending on the selected MDLP mode.
- You cannot record sound while the repeat playback function is on. Starting the recording function automatically cancels repeat playback.
- While recording a DVD video, you cannot make settings on the DVD including audio, subtitle, view angles, picture magnification and 3D PHONIC selection.

Quitting Recording

Press .

Recording Only One Track from a Disc

(Excluding DVD VIDEOS)

Before proceeding to step 6, start playback of the track you want to record.

- Pressing  in step 6 returns playback to the beginning of the track, and only that track is recorded.
- This one-track recording is not available for DVD VIDEOS.

Recording the Second or Subsequent Track to the Last Track from a Disc

- When recording CDs/VCDs/SVCDs/DVD VIDEOS (For a DVD VIDEO: while the disc is paused)

Before proceeding to step 6, select the starting track or chapter number by

pressing  or .

- When recording DVD AUDIOS/MP3s/WMA

Before proceeding to step 6, select the group number by pressing 

, and then select the track

number by pressing  or .

Program Recording from a Disc

Before performing step 1 on page 51, program the tracks you want to record ( page 48).

- Select normal speed recording ( step 5 on page 51).
When you select "HIGH SPEED" and proceed to step 6, "CANNOT REC x 1 REC ONLY" appears in the display window and recording does not start.

Changing the display in the display window during recording

Press .

- Each time you press , the display toggles as follows.

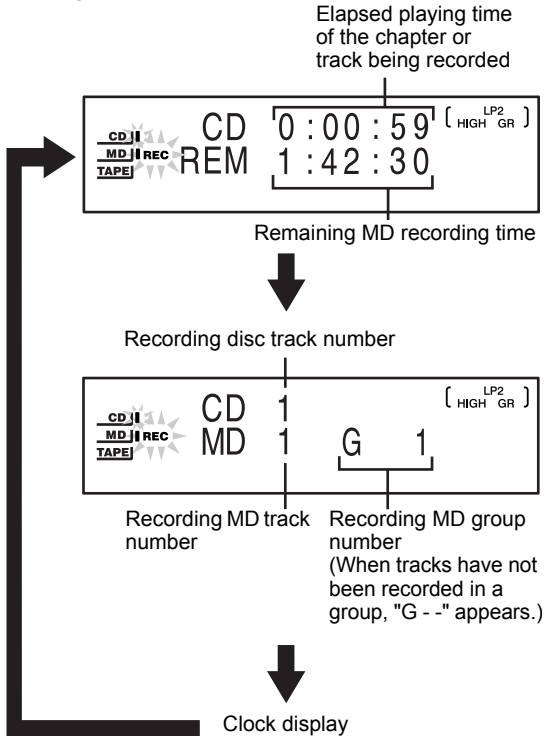



Things You Should Know about MD Recording

- It may be unlawful to record or playback copyright material without the consent of the copyright owner.
- You can record tracks having different MDLP modes onto an MD.
- You cannot use the monaural extended recording function with this product.

CAUTION

- Do not bump or sway the main unit during MD recording. Be especially careful while "WRITING" is displayed. Such movement may interfere with MD playback.
- You cannot play back tracks recorded in LP2 or LP4 with audio equipment that is not compatible with MDLP. When you attempt playback, "LP: " appears in front of the track title, and the main unit does not produce any sound. When you play back tracks recorded in LP2 or LP4 with audio equipment that is compatible with MDLP, "LP: " does not appear.

To activate or cancel the "LP: " indicator, press .
( on the right)

"LP: " indicator setting

Press .

- Each time you press , the display toggles as follows.

(LP:) ON : For adding "LP: " to the track title.



(LP:) OFF : For deleting "LP: " from the track title.

CD-R/CD-RW/DVD AUDIO recording

- When you record sound from a CD-R, CD-RW or DVD AUDIO onto an MD, pressing  may display "SCMS CANNOT COPY" in the display window, and digital recording may not be available.

In such a case, set the recording speed to normal, hold down  for 4 or more seconds.

While "ANALOG REC?" is displayed, press  once again to select analog recording.

- You can record up to 254 tracks to an MD. If you try to record 255 or more tracks, "DISC FULL" appears.
- When you use a partially-recorded MD, this product searches for the blank portion and records the new tracks to that portion. Unlike cassette tape recording, you cannot record over old tracks on an MD.
- Changing in sound volume and quality on this product during recording does not affect the recorded sound.
- Sound from a CD is recorded as digital signals to an MD. Sound from the radio or AUX is converted from analog signals to digital signals during recording.
- When you record a disc, track marks are automatically inserted between tracks. However, track marks may not be inserted when a DVD VIDEO or DVD AUDIO is recorded.

Recording Sound from Radio, Cassette Tape or Other Equipment

NOTE

- The recorded sound level is automatically adjusted.
- Sound-synchronized recording is employed for recording sound from other equipment (AUX). With sound-synchronized recording, this product automatically identifies sound signals from the sound source and starts recording. When sound from the sound source pauses for 30 or more seconds, this product automatically quits recording. The blank time between the last recorded track and the next recorded track is approximately 2 seconds.

1 Select a sound source.

Sound source	Operation
Radio broadcast	Select the radio station whose broadcast you want to record (page 20).
Cassette tape playback	Insert a cassette tape for playback, press and then press . Press to select the reverse mode when necessary.
Sound from other equipment (AUX/AUX-DIGITAL)	Press repeatedly to select AUX or AUX-DIGITAL, and prepare playback on the other equipment (page 45).

2 Insert an MD for recording.

- Confirm the MDLP, "LP: " indicator and group recording settings. (pages 51 and 53)
- Close the write protect knob on the MD (page 75).

3 Hold down on the main unit for approximately 4 seconds to display the track mark options.

4 While the track mark options are displayed, press to select a track mark option.

- Each time you press , the display toggles as follows.

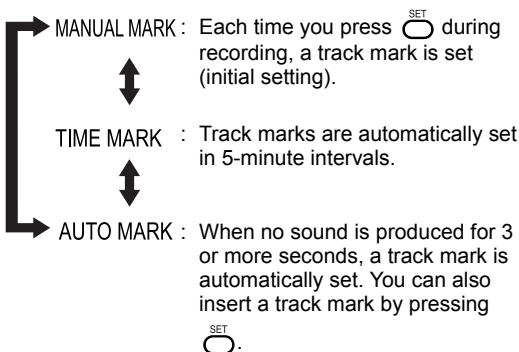

5 Press on the main unit.

Example: Display while FM radio broadcast is recorded

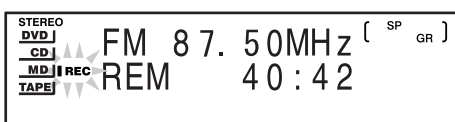

- When recording the sound from other equipment, wait until "AUX → MD" appears, and then start playback of the connected equipment. Recording automatically starts when sound is input to the main unit. You can also start recording by pressing



With this method, even when sound from the connected equipment pauses for 30 or more seconds, the main unit does not automatically quit recording.

Quitting Recording

Press .

Changing the display in the display window during recording

Press .

- Each time you press , the display toggles as follows.

Recording sound source name

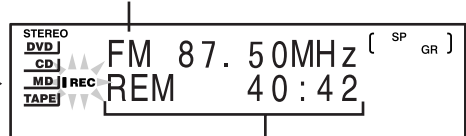

Remaining time for recording

Recording sound source name

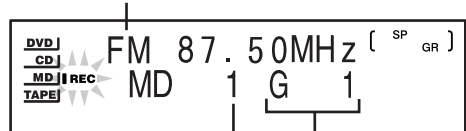

Recording MD track number

Recording MD group number
(When tracks are not recorded in a group, "-" appears.)

Clock display

Recording Sound to Cassette Tapes Used frequently

Main unit

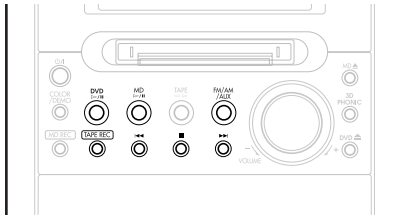

Remote control

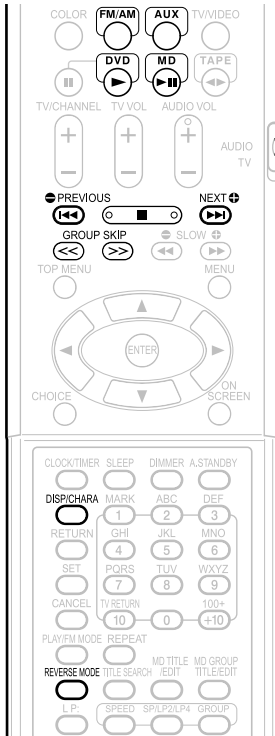

NOTE

- The sound input level during recording is automatically adjusted.
- When you record tracks from a disc or MD, a 4-second blank is inserted between tracks in the recording. You can record tracks with no blank time. (▶▶▶ page 56)

CAUTION

- It may be unlawful to record or playback copyright material without the consent of the copyright owner.
- Do not use long cassette tapes such as C-120 or C-150. Long cassette tapes are thin and stretch easily, and may become tangled in the inner part of the main unit.
- Since this product is not compatible with TYPE II and TYPE IV cassette tapes, do not use these types of cassette tapes. This product does not meet the specifications for these tapes, so sound is not properly recorded to these types of cassette tapes. You cannot obtain proper playback sound.

Preventing recorded sound from being erased

- Write protect tags are attached to a cassette tape for preventing the erasing of recorded sound. They enable you to avoid losing important recordings because once you snap off the write protect tags, you cannot record to the cassette tape or erase recorded material.
- When you want to use the cassette tape for recording again, cover the tag holes with adhesive tape.

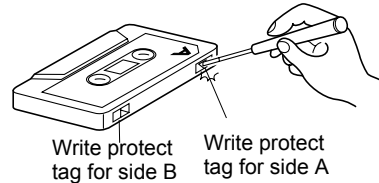

1 Insert a cassette tape for recording.

- Before inserting the cassette tape, wind the tape past the leader part of the cassette tape.

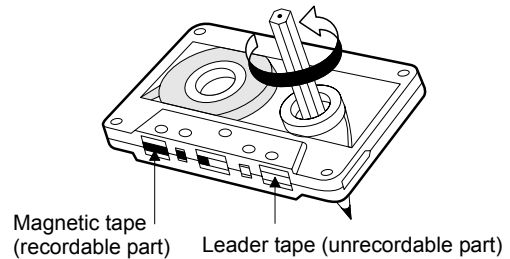

2 Press to select the reverse mode.



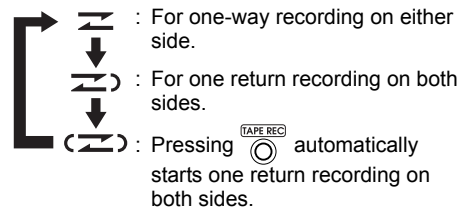



- Each time you press , the display toggles as follows.



- You can change the reverse mode during recording.

3 Select a sound source for recording.

- Before selecting a sound source, **make sure to stop a disc and MD.**

Sound source	Operation
Disc	Press  , and then press  .
MD	Press  , and then press  .
Radio broadcast	Select the radio station whose broadcast you want to record ( page 20).
Sound from other equipment (AUX/AUX-DIGITAL)	Press  repeatedly to select AUX or AUX-DIGITAL, and prepare playback on the other equipment ( page 45).

4 Press on the main unit.

Example: Display while CD sound is recorded

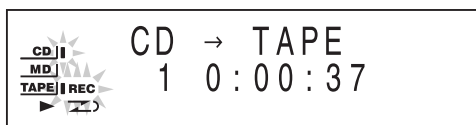

- When you record from a disc or MD, **all tracks are recorded to the cassette tape.**
- When you want to record sound from other equipment, start playback on the connected equipment.
- When recording finishes, the color pattern of the display window and disc tray switches to the color pattern set in "MANUAL" to inform you that recording has finished ( page 19).

Quitting Recording

Press .

Recording Only One Track from a Disc or MD



(Excluding DVD VIDEOS)





Before proceeding to step 4, play back the track you want to record.

- Pressing  in step 4 returns playback to the beginning of the track and only that track is recorded.

Recording the Second or Subsequent Track to the Last Track from a Disc or MD

(For a DVD VIDEO: while the disc is paused)

■ For a CD/VCD/SVCD/DVD VIDEO
Before proceeding to step 4, select the starting track/chapter number by pressing  or .

■ For a DVD AUDIO/MP3/WMA
Before proceeding to step 4, select the group number by pressing  or , and then select the track number by pressing  or .

Program Recording from a Disc or MD

Before proceeding to step 4, program the tracks you want to record ( pages 32 and 48).

Recording with No Blank Time between Tracks

Before proceeding to step 4, play back a disc or MD, pause the playback, and then press  to return to the beginning of the first track.

Erasing Recorded Sound from a Cassette Tape

Select the sound from other equipment (AUX) in step 3, and then press



- Do not play back any tracks on the connected equipment.

Changing the display in the display window during recording

Press .

- Each time you press , the display toggles as follows.

■ While tracks from a disc or MD are being recorded
DVD, CD or MD

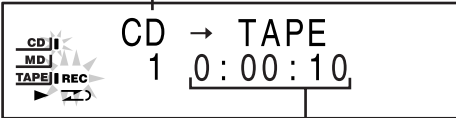

Elapsed playing time

■ While a radio broadcast (FM/AM) is being recorded
FM or AM

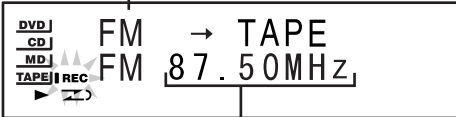

Frequency

■ While sound from other equipment (AUX) is being recorded



Clock display

NOTE

- If the cassette tape reverses direction while a track is being recorded from a disc or MD, this product starts recording that track again from the beginning onto the reverse side of the cassette tape. However, if 12 or less seconds of that track were recorded onto the first side of the cassette tape, recording to the reverse side of the cassette tape starts from the beginning of the previous track.
- Before recording a long track from an MD, such as a recorded concert, using one return recording, use the divide function to divide the track into sections equal to the length of one side of the cassette tape. ( page 32)

Giving (Editing) Titles

Things You Should Know about Editing

- You cannot edit an MD while its write protect knob is open (see page 75). When you attempt to edit a protected MD, "DISC PROTECTED" appears.
- When you finish editing, "EDITING" appears, then "WRITING" flashes and the edited setting is recorded to the MD. While "WRITING" is displayed, be careful not to bump or sway the main unit. Such movement may interfere with MD playback.
- You cannot edit an MD during program playback, random playback, or group playback.

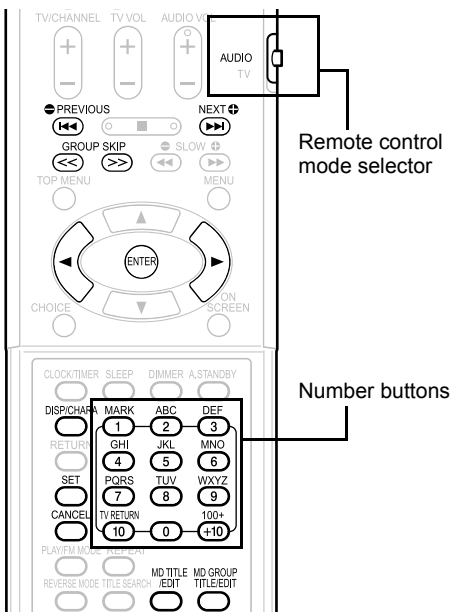

NOTE

- Set the remote control mode selector to **AUDIO** before using the number buttons.

Giving (Editing) Titles

You can give titles to an MD (disc), tracks and groups.

While the track or group to which you want to give a title is being played back

1 Set the remote control mode selector to AUDIO.



2 Display the title editing mode.

For editing an MD (disc) title or track titles

- Press **MD TITLE EDIT** to display the title editing mode.



- To edit a disc title, press **PREVIOUS** repeatedly to display "DISC TITLE?". You can also display "DISC TITLE?" by pressing **MD TITLE EDIT** while the disc is stopped.
- You can also select track number with **PREVIOUS** or **NEXT**.

For editing group titles

- Press **MD GROUP TITLE EDIT** twice to display the group title editing mode.

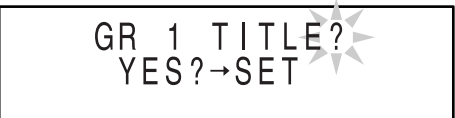

- You can also select a group number with **GROUP SKIP** or **GROUP SKIP**.

3 Press SET.

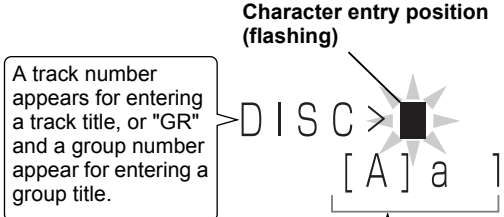

Available character types:
 [] indicates the selected character type.
 [A]: Uppercase characters or symbols
 [a]: Lowercase characters or symbols
 [1]: Numerical characters

4 Enter a title using the number buttons.

- For entering a title, refer to "Entering Titles" (see page 59).

5 Press ENTER.

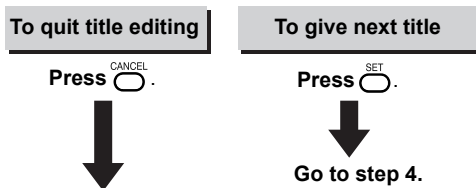

- The entered title is given to an MD, track or group.



(Continued on next page)



6 Press on the main unit to eject the MD.

NOTE

- Number of characters that can be entered to an MD
You can enter up to 1 792 characters to each MD, with up to 61 characters to each track. However, the actual number of characters that you can enter is less than the number indicated here because of restrictions of the MD writing method.
Spaces are counted as characters.
When you use long-play stereo recording (LP2 or LP4), the larger the number of tracks is, the smaller the number of characters that you can enter, because "LP: " and 4 spaces are automatically added to each track.
You can set this product so that "LP: " is not added to tracks. ( page 53)
- Example: When editing 120 tracks recorded using long-play stereo recording to an MD, you can enter 10 characters to each track.
- You cannot edit a title consisting of 62 or more characters. When you want to edit a title containing 62 or more characters, edit the title on the equipment on which the title was entered.
- You can set a title during recording.
 - While recording from a CD (except when recording only one track from a CD), you can enter up to 16 track titles before recording finishes.
 - If you do not press  before recording finishes, the entered titles are not stored.
 - During group recording, you can enter titles for the group.

Entering Titles

Example: To enter "F"

- Press  repeatedly until [] appears on "A".
- Press  repeatedly to display "F".

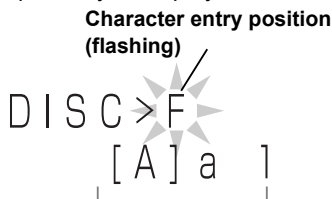



Available character types:

- [] indicates the selected character type.
- [A]: Uppercase characters or symbols
- [a]: Lowercase characters or symbols
- [1]: Numerical characters

- Several characters are assigned to one button. Press the button repeatedly until the desired character is displayed.
- For the available characters, refer to "Available Characters" ( on the right).



To move the character entry position

- Press  or .
- When you want to enter "NO", "TV" or two characters which are assigned to one button, enter the first character, press  to move the character entry position to the right, and then enter the second character.



To erase a character

- Move the character entry position to the character you want to erase, and press .











To enter a space

- Select the space from "Symbol" ( the chart below). You can also enter a space at the end of a title by pressing .

To quit title entry

- Press  or . The entered titles are not stored.

Available Characters

Button	Uppercase character	Lowercase character	Numerical character
 1	Symbol*	Symbol*	1
 2	ABC	abc	2
 3	DEF	def	3
 4	GHI	ghi	4
 5	JKL	jkl	5
 6	MNO	mno	6
 7	PQRS	pqrs	7
 8	TUV	tuv	8
 9	WXYZ	wxyz	9
 0			0

*Available symbols

	!	"	#	\$	%	&	'	()	*	+
,	-	.	/	:	;	<	=	>	?	@	_

Dividing a Track into Two Tracks (DIVIDE)

Example: Dividing a tune into tune A and tune B

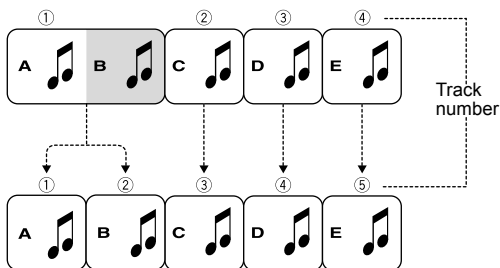

■ While the track you want to divide is being played back

1 Press **MD TITLE / EDIT** repeatedly to select "DIVIDE?".

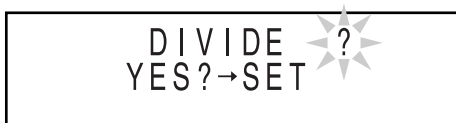

2 Press **SET**.

- You can also select the track number with **PREVIOUS**, **NEXT** or the number buttons. Refer to "Using the number buttons" (page 17).

3 Press **SET** to specify the dividing point.

- This product repeatedly plays back the 4 seconds of sound immediately following the dividing point.

"POSIT." stands for "POSITION".

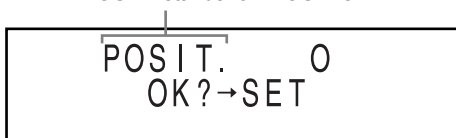

- When the dividing point does not have to be adjusted, proceed to step 5.
- When you want to adjust the dividing point, proceed to step 4.

4 Press **PREVIOUS** or **NEXT**.

- You can adjust the dividing point within the range of -128 to +128 position (approximately -8 to +8 seconds in SP mode).

5 Press **SET**.

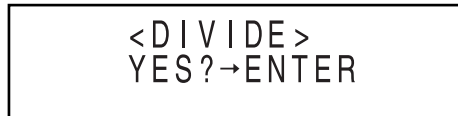

6 Press **ENTER**.

NOTE

- During editing, you can return to the previous step by pressing **CANCEL**. You can quit the editing operation by pressing **MD TITLE / EDIT**.
- You cannot divide a track in an MD containing 254 or more tracks. When you press **SET** in step 3, "DISC FULL" appears.
- When you divide a track that has a title, the title is added to both divided tracks.

Joining Tracks (JOIN)

You can join two adjacent tracks into one track.

Example: Joining tune A and tune B

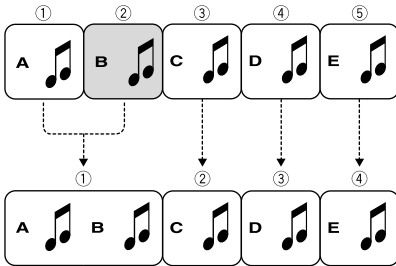

- While the second track (track 2 in the example shown above) to which you want to join the first track is being played back

- 1 Press repeatedly to select "JOIN?".



- 2 Press .

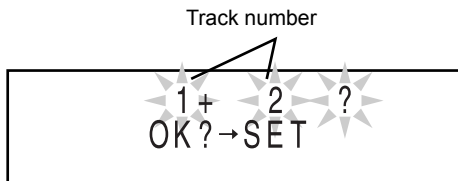

- You can also select a track number with , or the number buttons. Refer to "Using the number buttons" (page 17).

- 3 Press .

- 4 Press .

NOTE

- During editing, you can return to the previous step by pressing . You can quit the editing operation by pressing .
- You cannot join tracks that have different MDLP modes (SP/LP2/LP4), or tracks that have different recording types (digital/analog). If you attempt to join such tracks, "CANNOT JOIN" appears.
- When you join two tracks that have titles, the title of the first track remains as the title of the joined track.

Moving a Track (MOVE)

Example: Moving tune B

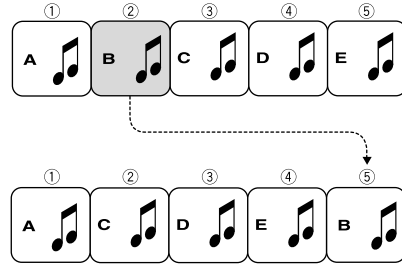

- While the track you want to move (track 2 in the example shown above) is being played back

- 1 Press repeatedly to select "MOVE?".



- 2 Press .

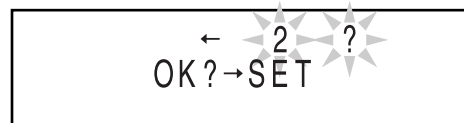

- You can also select a track number with , or the number buttons. Refer to "Using the number buttons" (page 17).

- 3 Press .

- 4 Press or to select the track number to which you want to move the specified track.

(Track 5 is selected in the example shown above)

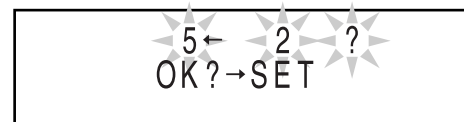



- You can also select a track number with the number buttons. Refer to "Using the number buttons" (page 17).
- When you move a track to a track number which is registered in a group, the track is registered in the group. When you move a track which is registered in a group to a track number which is not registered in a group, the track is removed from the group registration.

- 5 Press .

- 6 Press .

NOTE

- During editing, you can return to the previous step by pressing . You can quit the editing operation by pressing .

Erasing a Track (ERASE)

Used frequently

Example: Erasing tune B

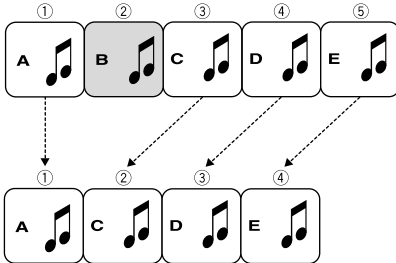

CAUTION

- Once you erase a track, you cannot retrieve it. Before erasing a track, confirm that you no longer need it.

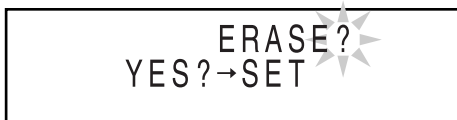

- While the track you want to erase (track 2 in the example shown above) is being played back

- 1 Press  repeatedly to select "ERASE?".



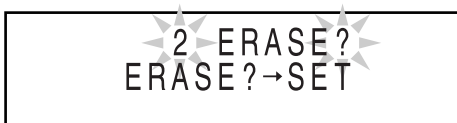



- 2 Press .



- You can also select a track number with , , or the number buttons. Refer to "Using the number buttons" ( page 17).



- 3 Press .

- "✓" is added in front of the selected track number.
- When you select a wrong track, press  to delete "✓".
- You can select up to 15 tracks to be erased with , , or the number buttons, and . Refer to "Using the number buttons" ( page 17).

- 4 Press .

- 5 Confirm that you no longer need the tracks, and then press .

NOTE

- During editing, you can return to the previous step by pressing . You can quit the editing operation by pressing .

Erasing All Tracks (ALL ERASE)

Used frequently

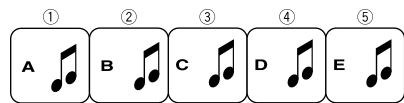

↓ All tracks are erased.



CAUTION

- Once you erase a track, you cannot retrieve it. Before erasing a track, confirm that you no longer need it.

- 1 Press  repeatedly to select "ALL ERASE?".

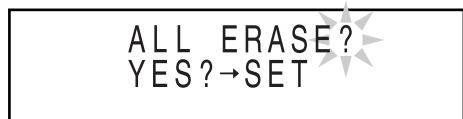

- 2 Press .

- 3 Confirm that you no longer need all tracks, and then press .

NOTE

- You can quit the editing operation by pressing .

Editing Tracks by Group

You can sort tracks into 99 groups maximum.

Forming a Group (FORM GR)

You can group tracks together. A sequence of tracks that is not registered in any group can be grouped.

Example: Forming tune A, tune B and tune C into a group

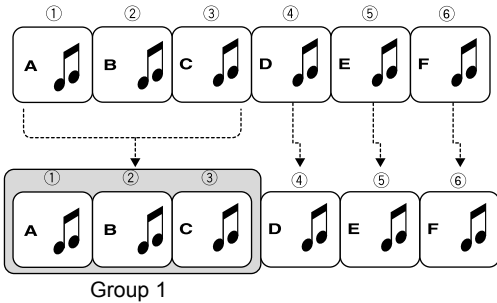

■ While the track which you want to specify as the first in the group (track 1 in the example shown above) is being played back

1 Press repeatedly to select "FORM GR?".

- "GR" stands for "GROUP".

2 Press .

The first track number in the group

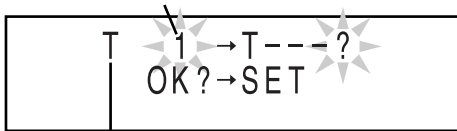

"T" stands for "TRACK".

- You can also select a track number with , or the number buttons. Refer to "Using the number buttons" (page 17).

3 Press .

4 Press or to select the track number which you want to specify as the last in the group. (Track number 3 is selected in the example shown on the left.)

The last track number in the group

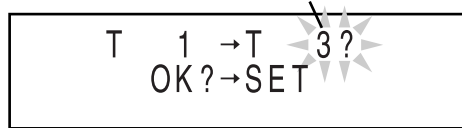

- You can also select a track number with the number buttons. Refer to "Using the number buttons" (page 17).

5 Press .

6 Press .

NOTE

- During editing, you can return to the previous step by pressing . You can quit the editing operation by pressing .
- If you select a track in another group, "GROUP TRACK" appears and you cannot proceed to the next step.
- If you select a sequence including a track that is registered in another group, "CANNOT FORM!" appears and you cannot proceed to the next step.

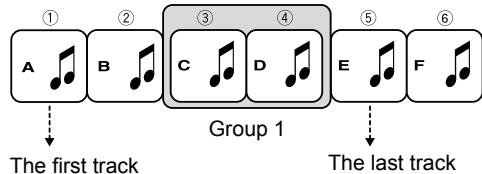

Adding a Track to a Group (ENTRY GR)

You can add a track to the specified group as the last track of the group.

Example: Adding tune F to group 1

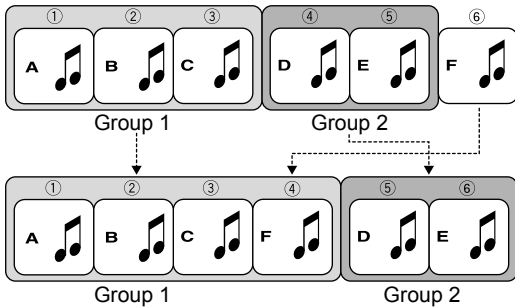

■ While the track which you want to add to a group (track 6 in the example shown above) is being played back

- 1 Press repeatedly to select "ENTRY GR?".
- 2 Press .

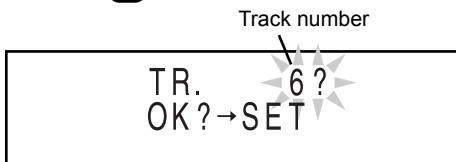

• You can also select a track number with , or the number buttons. Refer to "Using the number buttons" (page 17).

- 3 Press .

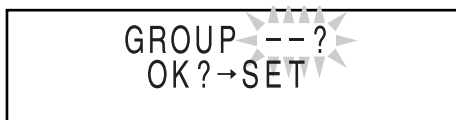

- 4 Press or to select the group to which you want to add the track.

(Group 1 is selected in the example shown above)

- 5 Press .
- 6 Press .

NOTE

- During editing, you can return to the previous step by pressing . You can quit the editing operation by pressing .
- If you select a track already belonging to the group, "CANNOT ENTRY!" appears and you cannot proceed to the next step.

Dividing a Group into Two Groups (DIVIDE GR)

Example: Dividing group 1 into two groups

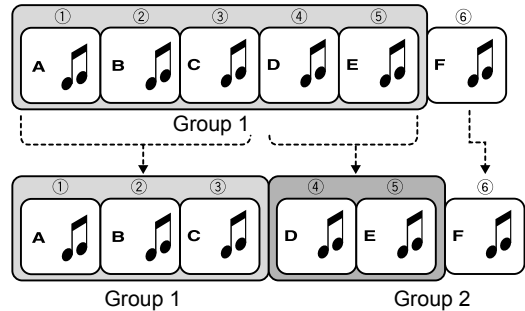

■ While the track which you want to specify as the first in the second group (track 4 in the example shown above) is being played back

- 1 Press repeatedly to select "DIVIDE GR?".
- 2 Press .

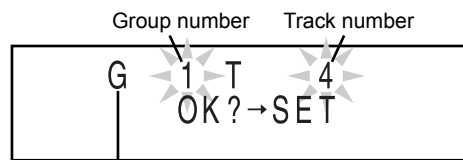

"G" stands for "GROUP".

- You can also select a track number with , or the number buttons. Refer to "Using the number buttons" (page 17).
- You can also select a group number with or .

- 3 Press .
- 4 Press .

NOTE

- During editing, you can return to the previous step by pressing . You can quit the editing operation by pressing .
- If you select the first track in the group or a track not belonging to the group, you cannot proceed to the next step.
- When you divide a group that has a title, the same title is given to both divided sections.

Joining Groups (JOIN GR)

You can join two adjacent groups.

Example: Joining group 1 and group 2

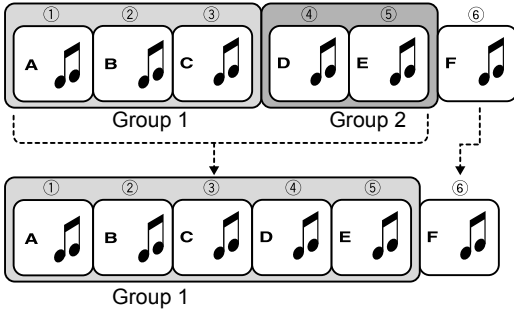

- While the track in the second group to which you want to join the first group (group 2 in the example shown above) is being played back

1 Press repeatedly to select "JOIN GR?".

2 Press .

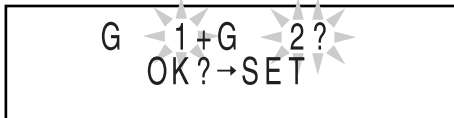

- Two adjacent group numbers appear. When no group is formed in the MD, "--" appears.
- You can also select a group number with or .

3 Press .

4 Press .

NOTE

- During editing, you can return to the previous step by pressing . You can quit the editing operation by pressing .
- You cannot join two groups separated by a track not belonging to either group. "CANNOT JOIN" appears, and display returns to the previous step.

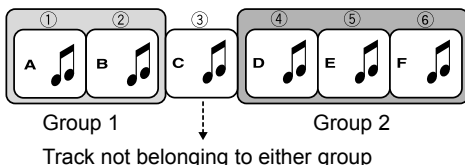

- When you join two groups that have titles, the title of the first group remains as the title of the joined group.

Moving a Group (MOVE GR)

Example: Moving group 2

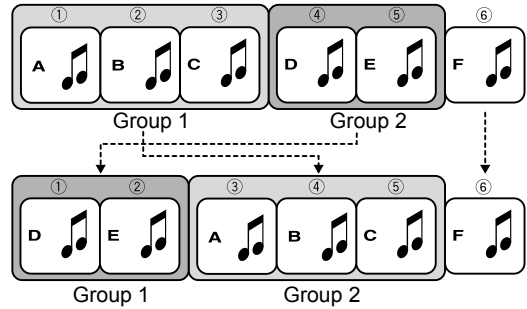

- While a track in the group you want to move (group 2 in the example shown above) is being played back

1 Press repeatedly to select "MOVE GR?".

2 Press .

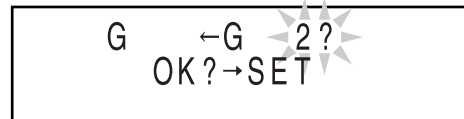

- You can also select a group number with or .

3 Press .

4 Press or to select the group number to which you want to move the specified group. (Group 1 is selected in the example shown above)

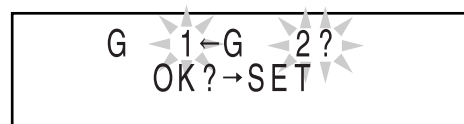

5 Press .

6 Press .

NOTE

- During editing, you can return to the previous step by pressing . You can quit the editing operation by pressing .

Canceling a Group (UNGROUP/UNGR ALL)

Canceling a specified group (UNGROUP)

Example: Canceling group 1

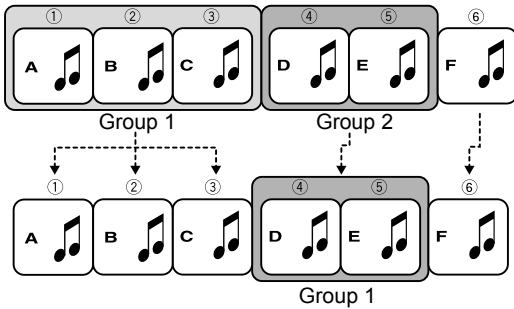

- While a track in the group you want to cancel (group 1 in the example shown above) is being played back

1 Press **MD GROUP TITLE/EDIT** repeatedly to select "UNGROUP?".

2 Press **SET**.

Example: When you want to cancel group 1



- You can also select a group number with

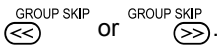

3 Press **SET**.

4 Press **ENTER**.

NOTE

- During editing, you can return to the previous step by pressing **CANCEL**. You can quit the editing operation by pressing **MD GROUP TITLE/EDIT**.

Canceling all groups (UNGR ALL)

Example: Canceling all groups

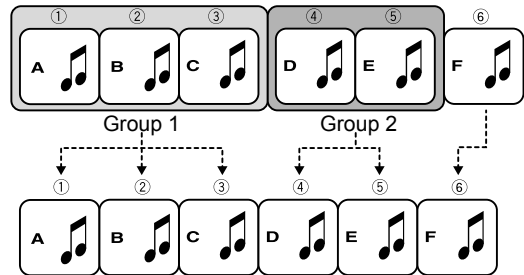

1 Press **MD GROUP TITLE/EDIT** repeatedly to select "UNGR ALL?".

- "UNGR" stands for "UNGROUP".

2 Press **SET**.

3 Press **ENTER**.

NOTE

- You can quit the editing operation by pressing



Erasing a Group (ERASE GR)

You can erase a group including all tracks in the group.

Example: Erasing group 2

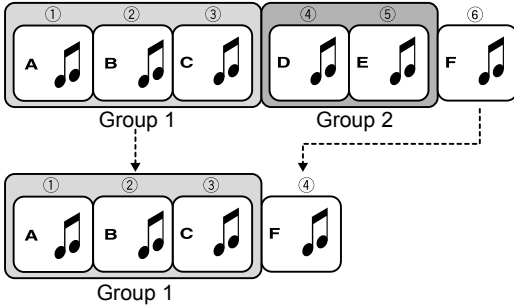

CAUTION

- Once you erase a track, you cannot retrieve it. Before erasing a track, confirm that you no longer need it.

- While a track in the group you want to erase (group 2 in the example shown above) is being played back

1 Press ^{MD GROUP TITLE/EDIT} repeatedly to select "ERASE GR?".

2 Press ^{SET}.

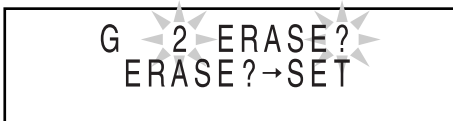

- You can also select a group number with

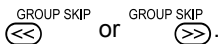

3 Press ^{SET}.

4 Confirm that you no longer need the tracks, and then press ^{ENTER}.

NOTE

- During editing, you can return to the previous step by pressing ^{CANCEL}. You can quit the editing operation by pressing ^{MD GROUP TITLE/EDIT}.

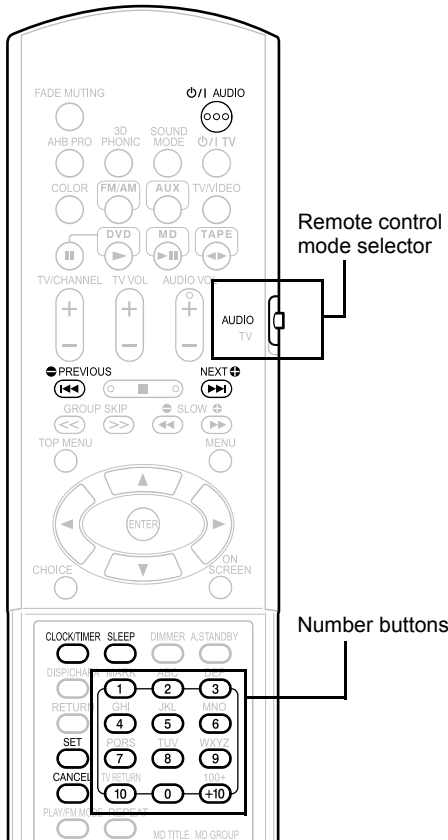

NOTE

- Set the remote control mode selector to AUDIO before using the number buttons. TV

Sleep Timer

When the specified time passes, the main unit automatically turns off.

Press .

- Each time you press , the time display (in minutes) toggles as follows.

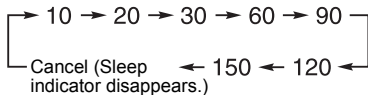

Example: Display while the sleep timer is set to 60 minutes

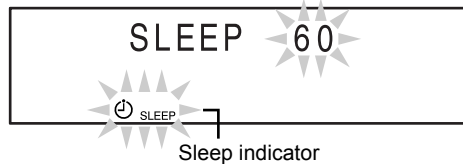

NOTE

- When you set the sleep timer, the display window automatically dims.
- Before the clock has been set (While "0:00" is flashing), when you press , "CLOCK ADJUST!" appears.

Changing the sleep timer setting

- Press repeatedly to select the time again.

Confirming the sleep timer setting (remaining time)

- With the sleep timer activated, press once.

Recording Timer

You can use the recording timer function to record FM/AM broadcasts or sound from other equipment to an MD or cassette tape.

You can enter up to three timer settings in total for the recording timer and the playback timer (👉 page 70).

NOTE

- Timer settings remain unchanged until the timer is replaced by new setting.

1 Prepare to record.

Radio	Preset the radio station whose broadcast you want to record. (👉 page 21)
Other equipment	Follow the operation manual for the equipment.
MD recording	Insert an MD. (👉 page 46)
Cassette tape recording	Insert a cassette tape. (👉 page 43)

(Continued on next page)

2 Press  repeatedly to select "TIMER1", "TIMER2" or "TIMER3".

Example: When "TIMER1" is selected

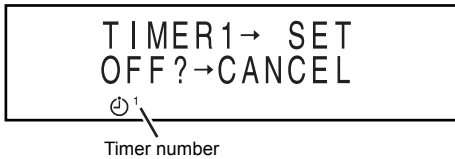



3 Press .

4 Press ,  or  to set the starting time and ending time.

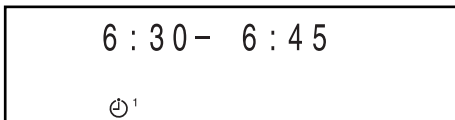
Example: To set the recording time from 6:30 a.m. to 6:45 a.m.



- You can use the number buttons to set the recording time. Refer to "Using the number buttons" (📖 page 17).
- For setting the clock, refer to "Setting the Clock" (📖 page 17).



Entering the "hour" →  → Entering the "minute" → 

5 Press  or  to select "ONCE" or "EVERYDAY".

ONCE : The recording timer works once.

EVERYDAY : The recording timer works every day.

6 Press .

7 Press  or  to select "REC TIMER".

• "REC" stands for "Recording".

8 Press .



9 Press  or  to select the combination of a sound source and recording medium.

Example: To record an FM broadcast to an MD





- When you want to record sound from other equipment, you cannot use the recording timer function to start playback on any equipment other than this product.
- "AUX-D" stands for "AUX-DIGITAL".

■ When you want to record an FM/AM radio broadcast

- Press , and then press ,  or the number buttons to select the preset number of the radio station whose broadcast you want to record. Refer to "Using the number buttons" (📖 page 17).

10 Press .

- When you use an MD as the recording medium, proceed to step 11.
- When you use a cassette tape as the recording medium, the settings appear in the display window. Confirm the settings, and then proceed to step 13.

11 Press  or  to select the MDLP mode (📖 page 51).

12 Press .

- The settings appear in the display window.



13 When the main unit is on, press

 to turn off the main unit.



- While the recording timer is functioning, the volume is set to "0" and no sound is produced from the speakers or headphones.
- The recording timer is available only when the main unit is turned off.

NOTE

- During operation, you can return to the previous step by pressing . You can quit the recording timer settings by pressing . The settings are not stored.
- When you want to change the track mark options, make the change before or after setting the recording timer. (📖 step 3 and 4 on page 54)

Canceling the recording timer

In step 2 on page 69, select the timer number you want to cancel, and then press . Even when you cancel the recording timer, the setting remains stored.

Activating the recording timer again





In step 2 on page 69, select the timer number you want to activate, and then press  repeatedly until all of the setting procedure finishes. Then turn off the main unit.

NOTE

- When you want to activate two or three recording timers, leave a blank time of 2 or more minutes between the ending time of the first recording timer and the starting time of the second recording timer. If the blank time is less than 2 minutes, the second recording timer does not work.
- When the power plug is disconnected or the power is cut, the recording timer settings may be lost. If the settings are lost, set the clock and recording timer again.

Playback Timer

1 Prepare the sound source you want to play back.

Disc	Make sure that a disc is loaded. ( page 22)
MD	Insert an MD. ( page 46)
Cassette tape	Insert a cassette tape. ( page 43)
Radio	Preset the radio station whose broadcast you want to listen to. ( page 21)
Other equipment	Follow the operation manual for the equipment.

2 Press repeatedly to select "TIMER1", "TIMER2" or "TIMER3".

Example: When "TIMER2" is selected

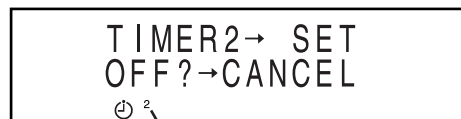



Timer number

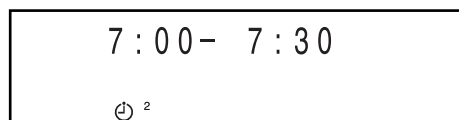

3 Press .

4 Press , or to set the starting time and ending time.

Example: When you want to set the playback time from 7:00 a.m. to 7:30 a.m.



- You can use the number buttons to set the playback time. Refer to "Using the number buttons" ( page 17).
- For setting the clock, refer to "Setting the Clock" ( page 17).

Entering the "hour" →  → Entering the "minute" → 

5 Press or to select "ONCE" or "EVERYDAY".

ONCE : The playback timer works once.
EVERYDAY : The playback timer works every day.

6 Press .

7 Press or to select "PLAY TIMER".

(Continued on next page)

8 Press .





9 Press  or  to select the sound source you want to play back.

Example: When you want to listen to an AM broadcast



- When you want to listen to sound from other equipment, you cannot use the playback timer function to start playback on any equipment other than this product.
- You cannot use the playback timer function together with program playback, repeat playback, random playback, or group playback of a disc or MD.





■ When you want to listen to an FM/AM radio broadcast

- (With "FM" or "AM" selected) Press , and then press ,  or the number buttons to select the preset number of the radio station whose broadcast you want to listen to ( page 21). Refer to "Using the number buttons" ( page 17).







■ When you want to play back a DVD VIDEO or DVD AUDIO

- (With "DVD/CD" selected) Press  twice. Regardless of the displayed numbers of group (G) and track (T), you can play back a DVD VIDEO or DVD AUDIO only from the beginning of the disc.

■ When you want to play back a CD, VCD, SVCD or MD

- (With "DVD/CD" selected) Press  twice, and then press ,  or the number buttons to select the number of a track (T) from which you want to start playback. Refer to "Using the number buttons" ( page 17). The group number (G) is ignored.

■ When you want to specify a track from which you want to start playback on an MP3 or WMA

- (With "DVD/CD" selected) Press , press ,  or the number buttons to select the group number (G) to be played back, press , and then press ,  or the number buttons to select the track number (T) to be played back. Refer to "Using the number buttons" ( page 17).

10 Press .

11 Press  or  to adjust the playback volume.

12 Press .

- The settings appear in the display window.



13 When the main unit is turned on,

press  to turn off the main unit.



- The playback timer is available only when the main unit is turned off.

NOTE

- During operation, you can return to the previous step by pressing . You can quit the playback timer settings by pressing . The settings are not stored.
- When the playback timer starts, the volume gradually increases to the selected level.

Canceling the playback timer function

In step 2 on page 70, select the timer number you want to cancel, and then press . Even when you cancel the playback timer, the setting remains stored.

Activating the playback timer again

In step 2 on page 70, select the timer number you want to activate, and then press  repeatedly until all of the setting procedure finishes. Then turn off the main unit.

NOTE

- When you want to activate two or three playback timers, leave a blank time of 2 or more minutes between the ending time of the first playback timer and the starting time of the second playback timer. If the blank time is less than 2 minutes, the second playback timer does not work.
- When the power plug is disconnected or the power is cut, the playback timer settings may be lost. If the settings are lost, set the clock and playback timer again.
- When you operate the playback timer with a DVD VIDEO, DVD AUDIO or VCD, sound and video may not be played back automatically. A DVD VIDEO, DVD AUDIO or VCD may contain a disc menu that appears first when played back. Sound or video will not come out before you select the desired item to be played back on the disc menu.

Auto Standby

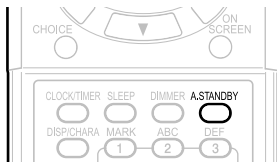

If no sound is produced for 3 minutes when a sound source other than the FM/AM radio is selected, the main unit automatically turns off.

- When a sound source other than the FM/AM radio is selected

Press .

"A. STANDBY" stands for "Auto Standby".

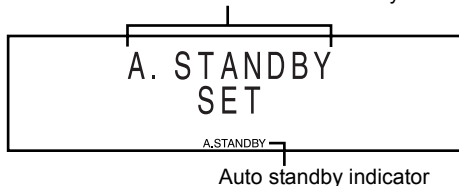

Auto standby performance

While a disc, MD, or cassette tape is being played back or recorded:

When playback or recording finishes, auto standby starts the countdown (the "A. STANDBY" indicator flashes). When no operation is carried out within 3 minutes, the main unit automatically turns off. When you start playback or recording within 3 minutes, auto standby starts the countdown again after playback or recording finishes. When an operation other than playback and recording finishes and no operation is carried out within 3 minutes, the main unit automatically turns off.

While you are listening to sound from other equipment:

When no sound is produced, auto standby starts the countdown (the "A. STANDBY" indicator flashes). When no operation is carried out within 3 minutes, the main unit automatically turns off. "A. STANDBY OFF" indicator starts to flash 20 seconds before the main unit is to turn off.

Canceling auto standby

Press  once again.





NOTE

- Leaving the volume at "0" is not the same as producing no sound, and therefore does not start the auto standby function.

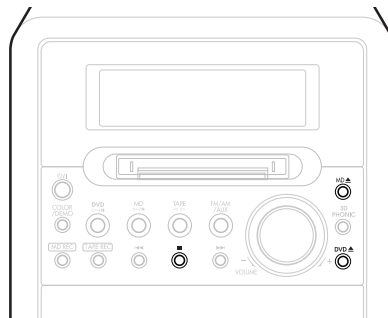

Disc/MD Ejection Lock





You can prohibit ejection of a disc and MD.

- When the main unit is turned off
- While holding down , press  on the main unit.



Even if you press  or , "LOCKED" appears in the display window and the disc or MD does not come out.

In addition, when you press  or , while the main unit is turned off, "LOCKED" appears in the display window and the main unit does not turn on.

Canceling the disc/MD ejection lock

- When the main unit is turned off
- Carry out the operation explained above once again.



Using AV COMPU LINK

The JVC AV COMPU LINK system allows you to enjoy video or audio with the simplest operation. If your JVC TV set supports the JVC AV COMPU LINK system, simply starting the main unit will automatically make all necessary settings on the TV to allow you to enjoy the playback.

Connection and Setting

- Carefully read manuals of equipment to be connected.

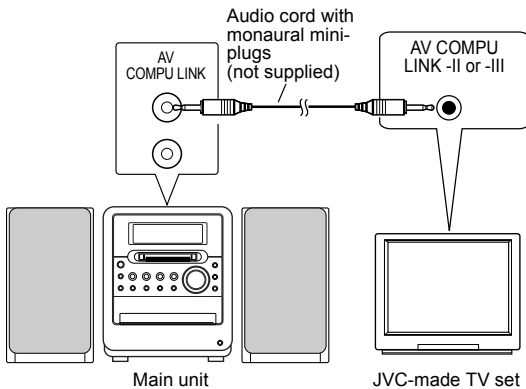

Set the main unit's AV COMPU LINK MODE setting (▶▶ page 40) as follows.

- When connecting to the VIDEO-1 input terminal of the TV: DVD 2
- When connecting to the VIDEO-2 input terminal of the TV: DVD 3
- When connecting to the VIDEO-3 input terminal of the TV: DVD 1

Operations

You can enjoy sound or video simply by starting playback on the main unit. You do not have to select the input setting for the TV, or turn on the TV beforehand.

- 1 Turn on the main power to the TV.**
- 2 Insert a disc into the main unit.**
- 3 Press  on the main unit.**

The following operation is performed automatically.

- The TV set will be turned on.
- TV input will be switched to external input (Video 1, 2 or 3) of the main unit.

When you turn off the main unit, power to the TV is not turned off.

Restrictions on MDs

Because the MD recording method has some restrictions, the following phenomena may occur. The phenomena are not a malfunction of this product.

Phenomenon	Possible cause
"DISC FULL" appears even though recordable time as printed on the MD remains.	Regardless of remaining recordable time, MDs have a limit on the number of recordable tracks. You cannot record 255 or more tracks to an MD. (You can record up to 254 tracks to an MD.)
"DISC FULL" appears even though the track numbers and recordable time have not reached the limit.	Repeated partial erasure and recording creates many blanks on an MD. When you record a track to such an MD, the track is split up and a small portion of the track is recorded into each blank.
You cannot join tracks or groups.	When the number of such split portions increases, "DISC FULL" may appear. When a split portion is 8 or less seconds (in SP mode (the standard stereo recording mode)), you cannot join the track with another track.
The remaining recordable time does not increase even after you have erased some tracks.	In addition, when you erase such portions, remaining recordable time does not increase.
Sound drops out intermittently during fast forward or fast reverse.	With a track split into many portions, fast forward or fast reverse may produce intermittent sound dropouts. You cannot join tracks that have different MDLP modes (SP/LP2/LP4).
Recorded time plus remaining time is shorter than the total recordable time printed on the MD.	MD recording is possible only when there is a blank of consecutive 12 or more seconds (in SP mode) on the MD. Actual recording time is shortened on an MD that contains many blanks.

Serial Copy Management System (SCMS)

The Serial Copy Management System protects copyright and allows only first-generation digital copies from the digitally recordable source.

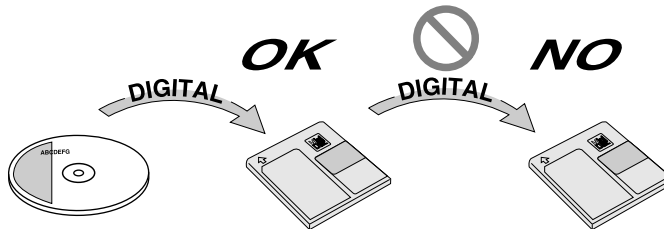

CAUTION

- The SCMS does not permit you to record sound from a digitally recorded MD to other media as digital sound.

High Speed Copy Management System (HCMS)

You can record sound to an MD at a higher speed than normal recording. Therefore, restrictions are required in order to protect copyright.

When you use this product to record a track of a CD with the high speed recording function, this product does not then permit you to use the high speed recording function to record the same track of the CD to an MD within 74 minutes of the start of the first recording.

For instance, when you record the track 1 of a CD to an MD with the high speed recording function, you cannot record the track 1 again to an MD with the high speed recording function for 74 minutes after the first high speed recording started. In addition, you cannot record 101 or more tracks within 74 minutes with the high speed recording function.

Handling Discs/MDs/Cassette Tapes

Handling discs

- Do not put adhesive tape or stickers, or write on a disc.
- Do not bend a disc.
- Be sure not to use heart/flower shaped discs or other irregularly shaped discs. The use of such discs damages the main unit.

Cleaning discs

Signal surface **OK**

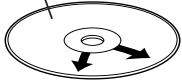

Wipe a disc from the center outward with a soft cloth.

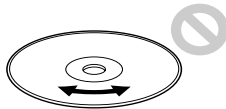

Scratches concentrated on a certain part cause sound dropout.

- Be sure not to use thinners, benzenes, cleaners for analog records, or other chemical agents.

Handling MDs

- Do not open the shutter. Forcibly opening the shutter will break the MD.

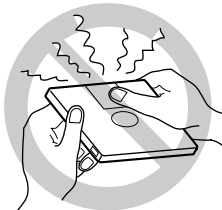

Preventing the loss of important recorded sound

- A write protect knob is attached to an MD for preventing accidental erasure of recorded sound.

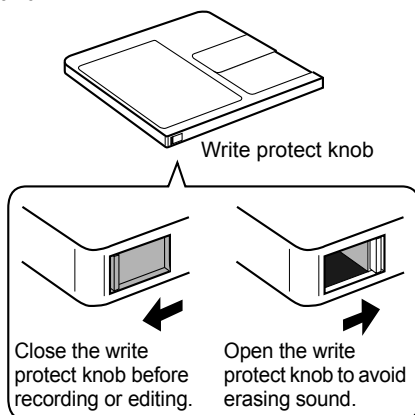

NOTE

- Do not put labels such as those indicating CD/track titles or other notes on any part of an MD other than the specified position. If you insert an MD with a label extending beyond the specified area, a label that is peeling off, or any other improperly attached label, it may damage the main unit.

Handling cassette tapes

- A slack tape may become caught in the inner part of the main unit and damage the main unit. Before using a cassette tape, wind up any slack in the cassette tape as shown on the right. Do not pull out the tape or touch the tape's surface.

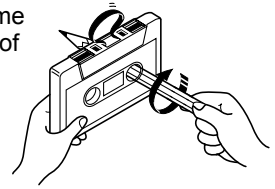

Cleaning the tape deck head

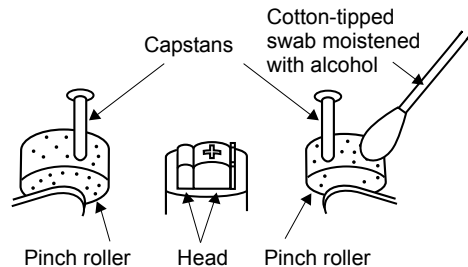

- Clean the head, pinch rollers and capstans approximately every 10 hours of playback time before the volume falls or sound quality deteriorates



Cleaning the main unit cabinet

- Gently dust the cabinet surface with a soft dry cloth. When the cabinet is very dirty, dampen the cloth with a neutral detergent diluted with water, wring out the cloth well, and then wipe the cabinet with the dampened cloth followed by a soft dry cloth.
- Do not wipe the cabinet with thinners or benzenes. Wiping it with these agents may cause discoloration of the cabinet or removal of the paint. Do not spray insecticides or other highly volatile agents onto the cabinet. Do not leave pieces of rubber or plastic on the cabinet for a long period.

MD/Disc Messages

MD message	Meaning	Possible solution
CANNOT ENTRY!	The track has already been in the selected group.	Select an appropriate track. (👉 page 64)
CANNOT FORM!	There is a group between the selected tracks.	Select appropriate tracks. (👉 page 63)
CANNOT GROUP!	There is no space for storing more group information. (Group information is stored in the same area as title information.)	You cannot form a group any more on the MD. (Erase the disc or track titles you do not need.)
CANNOT JOIN	You are trying to join tracks that have different MDLP modes (SP/LP2/LP4), or tracks of only 8 or less seconds (in SP mode).	The MD system restricts such operation.
CANNOT LISTEN	You are trying to adjust the volume during high speed recording.	You cannot listen to sound from a CD during high speed recording.
CANNOT REC	You are trying to operate one-track-recording with a VCD or SVCD during PBC playback.	Set PBC to off (👉 page 24).
CANNOT TITLE	You are trying to enter a total of 1 793 or more characters to an MD.	You cannot enter more titles.
READ ERROR	The main unit cannot read the MD.	Turn off the main unit. If the same message appears again, the MD may be damaged. Replace the MD.
DISC FULL	There is no more space in the MD, or you are trying to record 255 or more tracks.	Replace the MD. (👉 page 74).
DISC PROTECTED	The MD is write-protected.	Close the write protect knob on the MD. (👉 page 75).
EMERGENCY STOP	A malfunction occurred during recording.	Press  to quit recording, press  to eject the MD, and then start recording again.
GROUP FULL	You are trying to form 100 or more groups.	You can form up to 99 groups.
GROUP TRACK	You are trying to form a group with a track already belonging to another group.	Select tracks that do not belong to any groups. (👉 page 63)
LOAD ERROR	The MD is not properly loaded.	Insert the MD properly.
MD NO DISC	No MD is loaded.	—
NON-AUDIO CANNOT COPY	You are trying to record digital sound other than linear PCM from the connected equipment to an MD.	Set digital output to linear PCM on the connected digital equipment. (Refer to the instruction manual for the connected equipment for details.)
PLAYBACK DISC	You are trying to edit or record to an MD which is designed only for playback.	Replace the MD with a recordable MD.
SCMS CANNOT COPY	You are trying to make a digital audio duplication of a CD-R or CD-RW.	Operate analog recording at normal speed. (👉 page 53)
TRACK PROTECTED	You are trying to divide, join, or erase tracks which are recorded in the Net MD format.	Edit the tracks on equipment compatible with Net MD.
	The tracks are write-protected by equipment other than this product.	Edit the tracks with the equipment on which the tracks were recorded.
HCMS CANNOT COPY	You are trying to record a track with the high speed recording function within 74 minutes of starting to record the same track with the high speed recording function.	Wait 74 minutes, or change from high speed recording to normal speed recording.
BLANK DISC	There are no tracks in the MD.	—

Disc message	Meaning	Possible solution
CANNOT PLAY	You are trying to play back an unplayable disc or a disc that has many scratches.	Replace the disc.
NO DISC	No disc is loaded.	—
NO AUDIO	The disc may be an illegally copied disc.	You cannot listen to the disc.
LR ONLY	You are playing back a multi-channel track for which down-mix is prohibited.	This is normal operation.

Troubleshooting

Problem	Possible cause	Possible solution	Reference page
No sound/video is produced.	Improper connection.	Connect all cords properly.	11
	Headphones are connected.	Disconnect the headphone plug.	8
The clock display is flashing.	A power failure occurred or the power plug was disconnected.	Reset the clock.	17
Disc playback does not start.	The disc is upside down.	Place the disc on the disc tray with the letter-printed surface facing up.	22
	Moisture has condensed on the lens.	Leave the main unit turned on, wait for approximately 1 or 2 hours, and then operate the main unit.	3
A certain point cannot be played back properly.	The disc is scratched or dirty.	Clean or replace the disc.	75
	An error occurred on the MD.	Record to the MD again.	51
The volume of cassette tape playback is low.	The head or capstans are dirty.	Clean the head or capstans.	75
You cannot record an MD/cassette tape.	The MD/cassette tape is write-protected.	Cancel the write-protection.	55, 75
A radio broadcast cannot be received.	No antenna is connected.	Connect an antenna.	11
A whirring noise is produced.	The main unit is located close to a TV, computer, or other electric appliance.	Place the main unit away from a TV, computer, or other electric appliance.	3
You cannot set the timer.	You did not set the clock.	Set the clock.	17
The timer does not work.	The main unit is turned on.	After setting the timer, turn off the main unit.	69, 71
You cannot operate the remote control.	The remote control batteries are running low.	Replace the batteries with new batteries.	9
You cannot operate the main unit with the number buttons on the remote control.	The remote control mode selector on the remote control is set to TV.	Set the remote control mode selector to AUDIO.	17
When you turn on the main unit, a noise comes out from the rear of the main unit.	The internal cooling fan produces the noise as it rotates.	The noise is not a malfunction. This is to prevent excessive heat.	13, 18

● **If this product does not function properly even after you have implemented the possible solutions given above**

Many functions of this product are implemented by microcomputers. If malfunction is caused by thunder or static electricity, or the main unit does not function properly even when you press a button, disconnect the power plug from the AC outlet, wait for a while, and then connect this product again. Then reset the clock.

Specifications

■MD/DVD receiver (CA-UXQD7)

Amplifier

Output power	20 W + 20 W at 4 Ω (10% THD)
Input terminals	
<Analog>	AUX×1, 500 mV/47 kΩ:LEVEL1 250 mV/47 kΩ:LEVEL2
<Digital>	Digital optical input × 1 -23 dBm to -15 dBm (Optical square terminal) (Compatible with frequency of 32 kHz, 44.1 kHz and 48 kHz)
Output terminals	
<Analog>	Speaker×1, 20 W/4 Ω Impedance 4 Ω - 16 Ω Headphone (×1), 25 mW/32 Ω Impedance 16 Ω - 1 kΩ
<Digital>	DVD/CD optical input × 1 -23 dBm to -15 dBm (Optical square terminal)
<Other>	AV COMPU LINK × 2 (φ 3.5)

Tuner

Frequency	FM:87.50 MHz - 108.00 MHz AM:531 kHz - 1 710 kHz (9 kHz spacing) 530 kHz - 1 710 kHz (10 kHz spacing)
-----------	---

DVD player

Playable discs	DVD VIDEO, DVD AUDIO, CD, VCD, SVCD, CD-R/CD- RW (CD, VCD, SVCD, MP3/ WMA/JPEG format), DVD-R/ DVD-RW (video format)
----------------	--

MD recorder

Audio playing system	MiniDisc digital audio system
Recording system	Magneto-optical overwrite system
Reading system	Non-contact, semiconductor laser pickup
Recording/Playback time (when using an 80-minute MD)	SP: 80 minutes LP2: 160 minutes LP4: 320 minutes
Sampling frequency	44.1 kHz
Audio compression system	ATRAC (Adaptive TRansform Acoustic Coding)/ATRAC3 (MDLP)

Cassette deck

Frequency response	
Normal (type I)	60 Hz - 14 000 Hz
Wow and flutter	0.15% (WRMS)

General

Power source	AC 220 V~, 50 Hz
Power consumption	70 W (at operation) 1.3 W (on standby)
Dimensions	165 mm (W) × 200 mm (H) × 355 mm (D)
Mass (approx.)	5.1 kg

■Speaker (SP-UXQD6)

System	3-way bass reflex type, Magnetically shielded type
Speakers	Woofers: 10 cm × 1 Midrange: 4 cm × 1 Tweeter: 1.5 cm × 1
Power handling capacity	20 W
Impedance	4 Ω
Frequency range	58 Hz - 40 kHz
Sound pressure level	85 dB/W•m
Dimensions	135 mm (W) × 200.5 mm (H) × 211.5 mm (D)
Mass (approx.)	2.0 kg (1 unit)

■Micro component MD system (UX-QD7)

General

Dimensions	435 mm (W) × 200.5 mm (H) × 355 mm (D)
Mass (approx.)	9.1 kg

- U.S. and foreign patents licensed from Dolby Laboratories.

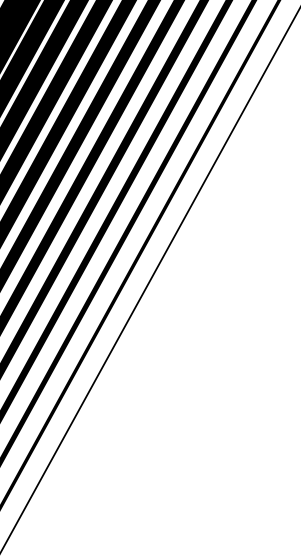

JVC

Free Manuals Download Website

<http://myh66.com>

<http://usermanuals.us>

<http://www.somanuals.com>

<http://www.4manuals.cc>

<http://www.manual-lib.com>

<http://www.404manual.com>

<http://www.luxmanual.com>

<http://aubethermostatmanual.com>

Golf course search by state

<http://golfingnear.com>

Email search by domain

<http://emailbydomain.com>

Auto manuals search

<http://auto.somanuals.com>

TV manuals search

<http://tv.somanuals.com>