

# JVC



## MICRO COMPONENT SYSTEM

# UX-S57 —Consists of CA-UXS57 and SP-UXS57

COMPACT  
**disc**  
DIGITAL AUDIO

**R-D-S**

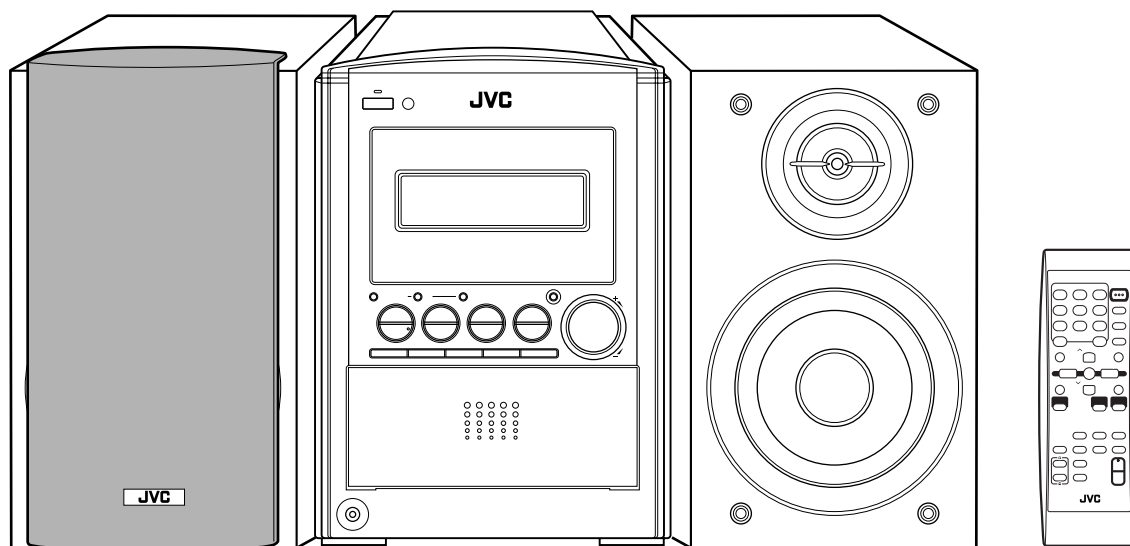

# INSTRUCTIONS

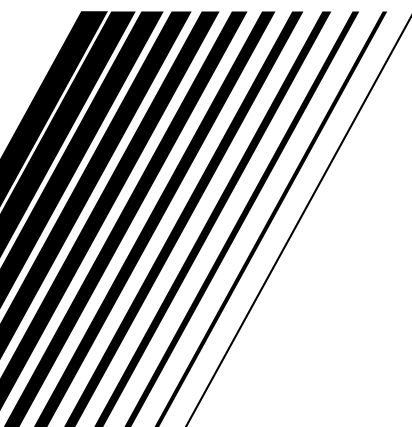

GVT0134-003A  
[B]

## Warnings, Cautions and Others

### IMPORTANT for the U.K.

**DO NOT** cut off the mains plug from this equipment. If the plug fitted is not suitable for the power points in your home or the cable is too short to reach a power point, then obtain an appropriate safety approved extension lead or consult your dealer.

**BE SURE** to replace the fuse only with an identical approved type, as originally fitted.

If nonetheless the mains plug is cut off ensure to remove the fuse and dispose of the plug immediately, to avoid a possible shock hazard by inadvertent connection to the mains supply.

If this product is not supplied fitted with a mains plug then follow the instructions given below:

### IMPORTANT:

**DO NOT** make any connection to the terminal which is marked with the letter E or by the safety earth symbol or coloured green or green-and-yellow.

The wires in the mains lead on this product are coloured in accordance with the following code:

Blue : Neutral  
Brown : Live

As these colours may not correspond with the coloured markings identifying the terminals in your plug proceed as follows:

The wire which is coloured blue must be connected to the terminal which is marked with the letter N or coloured black.

The wire which is coloured brown must be connected to the terminal which is marked with the letter L or coloured red.

**IF IN DOUBT—CONSULT A COMPETENT ELECTRICIAN.**

### Caution— (STANDBY/ON) button!

Disconnect the mains plug to shut the power off completely (all lamps and indications go off). The  (STANDBY/ON) button in any position does not disconnect the mains line.

- When the unit is on standby, the STANDBY/ON lamp lights red.
  - When the unit is turned on, the STANDBY/ON lamp lights green.
- The power can be remote controlled.

### CAUTION

To reduce the risk of electrical shocks, fire, etc.:

1. Do not remove screws, covers or cabinet.
2. Do not expose this appliance to rain or moisture.

### CAUTION

- Do not block the ventilation openings or holes. (If the ventilation openings or holes are blocked by a newspaper or cloth, etc., the heat may not be able to get out.)
- Do not place any naked flame sources, such as lighted candles, on the apparatus.
- When discarding batteries, environmental problems must be considered and local rules or laws governing the disposal of these batteries must be followed strictly.
- Do not expose this apparatus to rain, moisture, dripping or splashing and that no objects filled with liquids, such as vases, shall be placed on the apparatus.

## IMPORTANT FOR LASER PRODUCTS

1. CLASS 1 LASER PRODUCT
2. **CAUTION:** Do not open the top cover. There are no user serviceable parts inside the unit; leave all servicing to qualified service personnel.
3. **CAUTION:** Visible and invisible laser radiation when open and interlock failed or defeated. Avoid direct exposure to beam.
4. **REPRODUCTION OF LABEL: CAUTION LABEL, PLACED INSIDE THE UNIT.**

<b>CAUTION :</b> Visible and invisible laser radiation when open and interlock failed or defeated. <b>AVOID DIRECT EXPOSURE TO BEAM.</b>	<b>ADVARSEL :</b> Synlig og usynlig laserstråling når maskinen er åben eller interlocken fejler. <b>Undgå direkte eksponering til stråling.</b> (e)	<b>WARNING :</b> Synlig och osynlig laserstråling när den öppnas och spärren är urkopplad. <b>Betrakta ej strålen.</b> (d)	<b>VARO :</b> Avattaessa ja suojalukitus ohitettuna tai viallisena olet alttiina näkyvälle ja näkymättömälle lasersäteilylle. <b>Vältä säteen kohdistumista suoraan itseesi.</b> (f)
--	---	--	--

### CAUTION: Proper Ventilation

To avoid risk of electric shock and fire, and to prevent damage, locate the apparatus as follows:

- 1 Front:
  - No obstructions and open spacing.
- 2 Sides/ Top/ Back:
  - No obstructions should be placed in the areas shown by the dimensions below.
- 3 Bottom:
  - Place on a level surface. Maintain an adequate air path for ventilation by placing on a stand with a height of 10 cm or more.

Front View

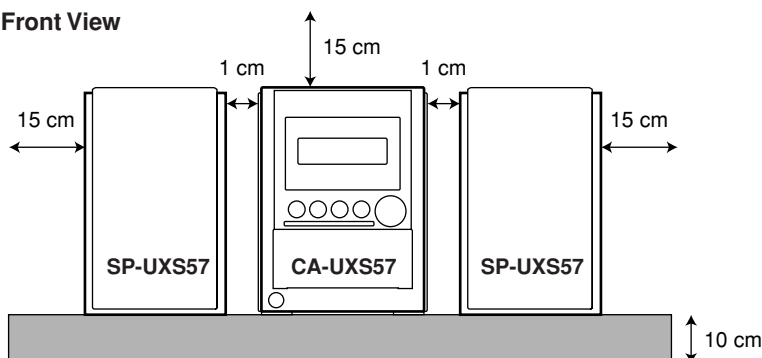

Side View

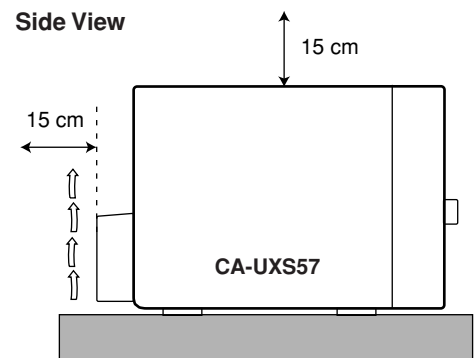

# SAFETY INSTRUCTIONS

## “SOME DOS AND DON'TS ON THE SAFE USE OF EQUIPMENT”

This equipment has been designed and manufactured to meet international safety standards, but like any electrical equipment, care must be taken if you are to obtain the best results and safety is to be assured.

\*\*\*\*\*

Do read the operating instructions before you attempt to use the equipment.

Do ensure that all electrical connections (including the mains plug, extension leads and interconnections between pieces of equipment) are properly made and in accordance with the manufacturer's instructions. Switch off and withdraw the mains plug when making or changing connections.

Do consult your dealer if you are ever in doubt about the installation, operation or safety of your equipment.

Do be careful with glass panels or doors on equipment.

\*\*\*\*\*

DON'T continue to operate the equipment if you are in any doubt about it working normally, or if it is damaged in any way—switch off, withdraw the mains plug and consult your dealer.

DON'T remove any fixed cover as this may expose dangerous voltages.

DON'T leave equipment switched on when it is unattended unless it is specifically stated that it is designed for unattended operation or has a standby mode.

Switch off using the switch on the equipment and make sure that your family know how to do this.

Special arrangements may need to be made for infirm or handicapped people.

DON'T use equipment such as personal stereos or radios so that you are distracted from the requirements of traffic safety. It is illegal to watch television whilst driving.

DON'T listen to headphones at high volume as such use can permanently damage your hearing.

DON'T obstruct the ventilation of the equipment, for example with curtains or soft furnishings.

Overheating will cause damage and shorten the life of the equipment.

DON'T use makeshift stands and NEVER fix legs with wood screws—to ensure complete safety always fit the manufacturer's approved stand or legs with the fixings provided according to the instructions.

DON'T allow electrical equipment to be exposed to rain or moisture.

### ABOVE ALL

- NEVER let anyone, especially children, push anything into holes, slots or any other opening in the case—this could result in a fatal electrical shock.
- NEVER guess or take chances with electrical equipment of any kind—it is better to be safe than sorry!

# Introduction

We would like to thank you for purchasing one of our JVC products. Before operating this unit, read this manual carefully and thoroughly to obtain the best possible performance from your unit, and retain this manual for future reference.

## About This Manual

This manual is organized as follows:

- **This manual mainly explains operations using the buttons on the remote control. You can use the buttons both on the remote control and on the unit for the same operations if they have the same or similar names (or marks), unless mentioned otherwise.**
- Basic and common information that is the same for many functions is grouped in one place, and is not repeated for each procedure. For instance, we do not repeat the information about turning on/off the unit, setting the volume, changing the sound effects, and others, which are explained in the section “Basic and Common Operations” on pages 9 to 12.
- The following symbols are used in this manual:



Gives you warning and caution to prevent damage or risk of fire/electric shock. In addition, we put information here about conditions which will prevent getting the best possible performance from the unit.



Gives you information and hints you need to know.

## Precautions

### Installation

- Install in a place which is level, dry and neither too hot nor too cold—between 5°C and 35°C.
- Install the unit in a location with adequate ventilation to prevent internal heat buildup.
- Leave sufficient distance between the unit and the TV.
- Keep the speakers away from the TV to avoid interference with TV.



DO NOT install the unit in a location near heat sources, or in a place subject to direct sunlight, excessive dust or vibration.

### Power sources

- When unplugging the unit from the wall outlet, always pull on the plug, not the AC power cord.



DO NOT handle the AC power cord with wet hands.

### Moisture condensation

Moisture may condense on the lenses inside the unit in the following cases:

- After starting to heat the room.
- In a damp room.
- If the unit is brought directly from a cold to a warm place. Should this occur, the unit may malfunction. In this case, leave the unit turned on for a few hours until the moisture evaporates, unplug the AC power cord, then plug it in again.

### Others

- Should any metallic object or liquid fall into the unit, unplug the AC power cord and consult your dealer before operating any further.
- If you are not going to operate the unit for an extended period of time, unplug the AC power cord from the wall outlet.



DO NOT disassemble the unit since there are no user serviceable parts inside.

If anything goes wrong, unplug the AC power cord and consult your dealer.

# Contents

---

<b>Location of the Buttons and Controls .....</b>	<b>3</b>
Front Panel .....	3
Remote Control .....	5
<b>Getting Started .....</b>	<b>6</b>
Unpacking .....	6
Connecting Antennas .....	6
Connecting Speakers .....	7
Connecting Other Equipment .....	8
Putting the Batteries into the Remote Control .....	8
<b>Basic and Common Operations .....</b>	<b>9</b>
Setting the Clock .....	9
Turning On the Power .....	10
Adjusting the Volume .....	11
Reinforcing the Bass Sound .....	11
Adjusting the Tone .....	12
Changing the Display Brightness .....	12
<b>Listening to FM and AM (MW) Broadcasts .....</b>	<b>13</b>
Tuning in to a Station .....	13
Presetting Stations .....	13
Tuning in to a Preset Station .....	14
<b>Receiving FM Stations with RDS .....</b>	<b>15</b>
Changing the RDS Information .....	15
Searching for Programs by PTY Codes (PTY Search) .....	15
Switching Temporarily to a Program Type of Your Choice .....	16
<b>Playing Back Discs on the 5-CD Changer .....</b>	<b>17</b>
Loading Discs .....	17
Playing Back All the Entire Discs—Continuous Play .....	18
Basic Disc Operations .....	19
Programing the Track Playing Order—Program Play .....	20
Playing at Random—Random Play .....	21
Repeating Tracks or Discs—Repeat Play .....	21
Prohibiting Disc Ejection .....	21
<b>Using the Timers .....</b>	<b>22</b>
Using the Daily Timer .....	22
Using the Sleep Timer .....	24
<b>Maintenance .....</b>	<b>25</b>
<b>Troubleshooting .....</b>	<b>26</b>
<b>Additional Information .....</b>	<b>27</b>
<b>Specifications .....</b>	<b>28</b>

# Location of the Buttons and Controls

Become familiar with the buttons and controls on your unit.

## Front Panel

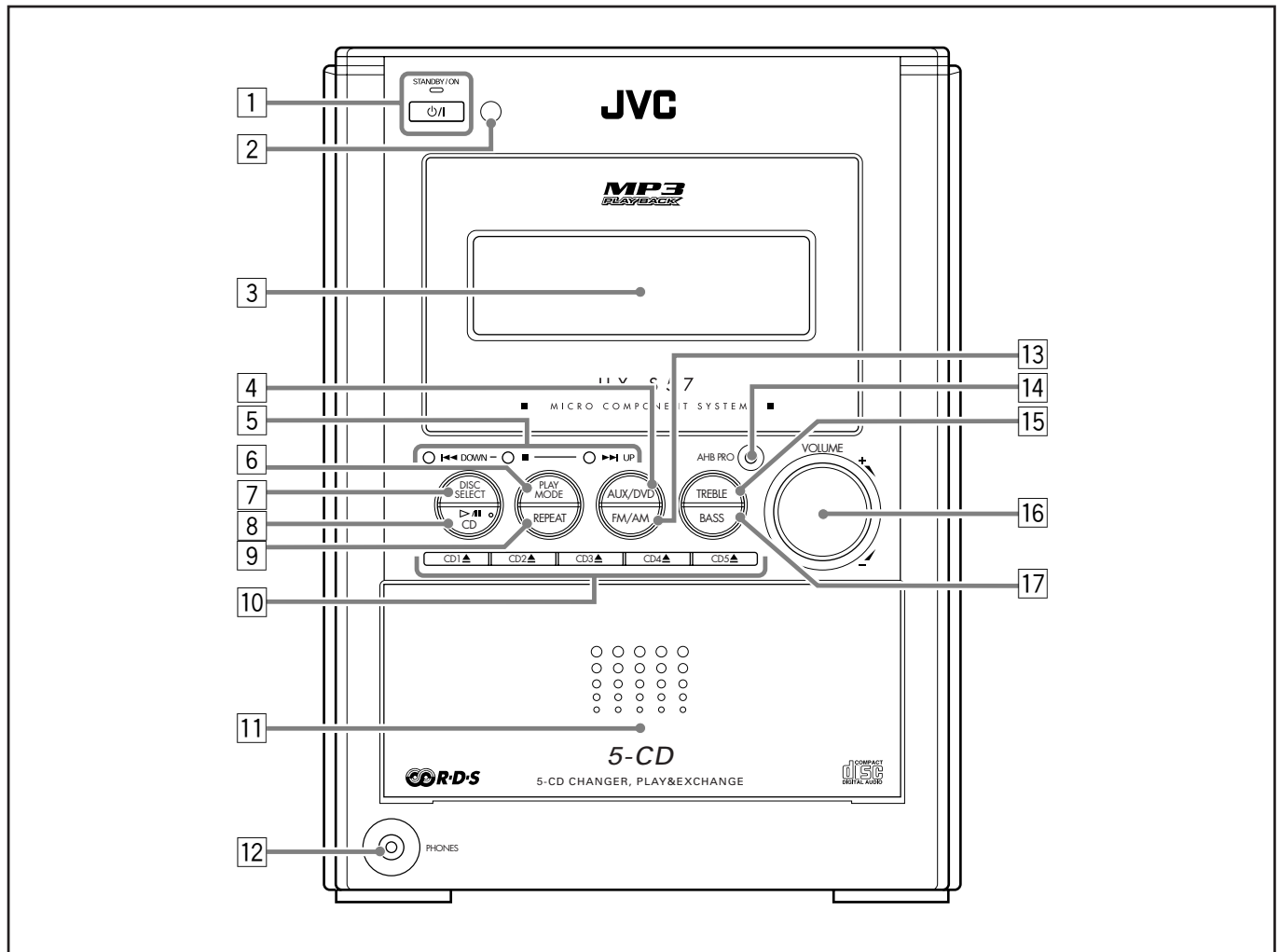

### Front panel

See pages in parentheses for details.

- 1 **⏻/⏻** (standby/on) button and STANDBY/ON lamp (10, 21)
- 2 Remote sensor (5)
- 3 Display window (4)
- 4 AUX/DVD button (10)
  - Pressing this button also turns on the unit.
- 5 Multi operation buttons  
⏮ DOWN, ■, and ⏭ UP
- 6 PLAY MODE button (20, 21)
- 7 DISC SELECT button (18, 19)
- 8 ▷/⏻ CD button (10, 18)
  - Pressing this button also turns on the unit.
- 9 REPEAT button (21)
- 10 Disc eject buttons (10, 17, 18)  
CD1▲, CD2▲, CD3▲, CD4▲, and CD5▲
  - Pressing one of these buttons also turns on the unit and opens the corresponding disc tray.
- 11 Disc trays compartment (17)
- 12 PHONES jack (11)
- 13 FM/AM button (10, 13, 14)
  - Pressing this button also turns on the unit.
- 14 AHB PRO (Active Hyper Bass Pro) button (11)
- 15 TREBLE button (12)
- 16 VOLUME + / - control (11)
- 17 BASS button (12)

## Display window on the front panel

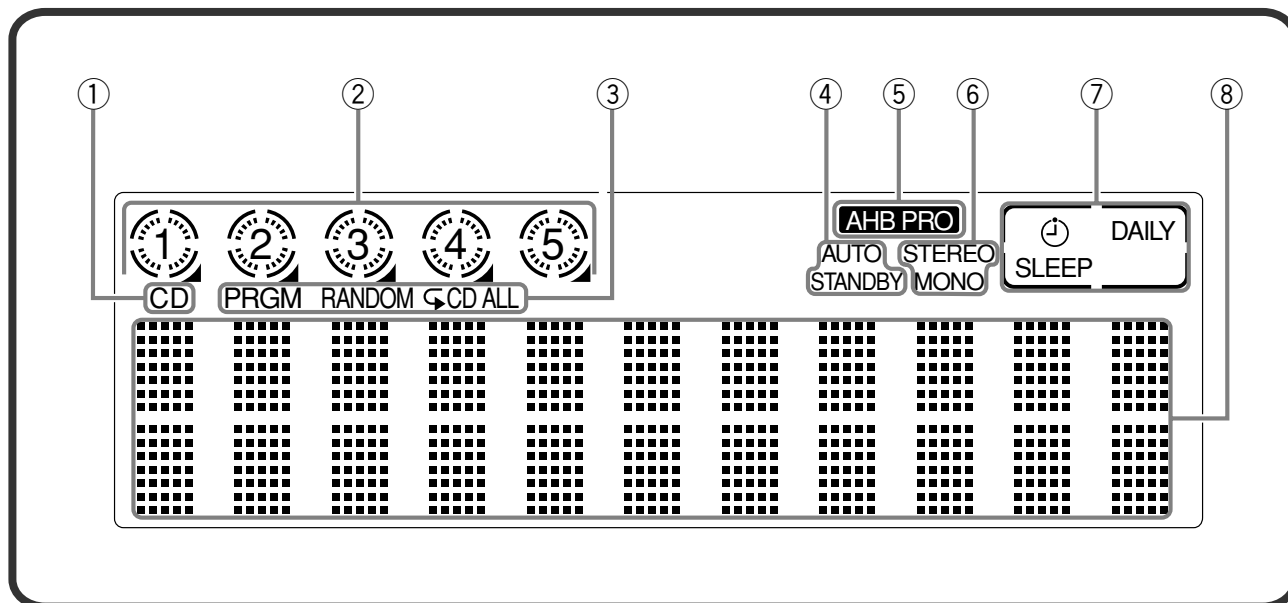

### Display window

See pages in parentheses for details.

- ① CD indicator (17)
- ② Disc indicators (17)
- ③ Disc play mode indicators (20, 21)
  - PRGM (program), RANDOM, and Repeat mode (↶, ↷ CD, ↷ ALL)
- ④ AUTO STANDBY indicator (10)
- ⑤ **AHB PRO** (Active Hyper Bass Pro) indicator (11)
- ⑥ FM mode indicators (13)
  - STEREO and MONO
- ⑦ Timer indicators
  - ⌚ (timer) (9, 22, 23)
  - SLEEP (sleep timer) (24)
  - DAILY (daily timer) (9, 22, 23)
- ⑧ Main display
  - Shows the source name and other information.

# Location of the Buttons and Controls (continued)

## Remote Control

See pages in parentheses for details.

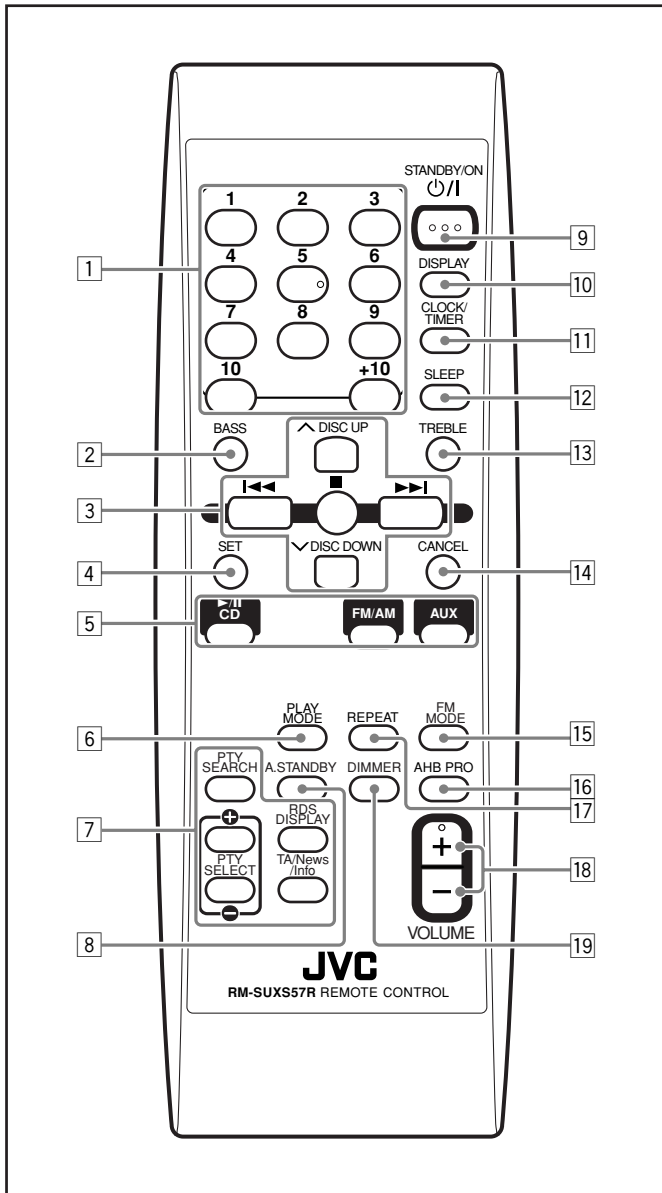

- 1 Number buttons
- 2 BASS button (12)
- 3 Multi operation buttons
  - ▲ DISC UP and ▼ DISC DOWN
  - ◀◀, ■, and ▶▶
- 4 SET button (13, 14)
- 5 Source buttons
  - ▶/|| CD, FM/AM, and AUX

*Pressing one of these buttons also turns on the unit.*
- 6 PLAY MODE button (20, 21)
- 7 RDS operation buttons (15, 16)
  - PTY SEARCH, PTY SELECT ⊕ / ⊖, RDS DISPLAY, and TA/News/Info
- 8 A.STANDBY (auto standby) button (10)
- 9 STANDBY/ON ⏻/⏻ button (10, 23)
- 10 DISPLAY button (9)
- 11 CLOCK/TIMER button (9, 22, 23)
- 12 SLEEP button (24)
- 13 TREBLE button (12)
- 14 CANCEL button (20)
- 15 FM MODE button (13)
- 16 AHB PRO (Active Hyper Bass Pro) button (11)
- 17 REPEAT button (21)
- 18 VOLUME + / - button (11)
- 19 DIMMER button (12)

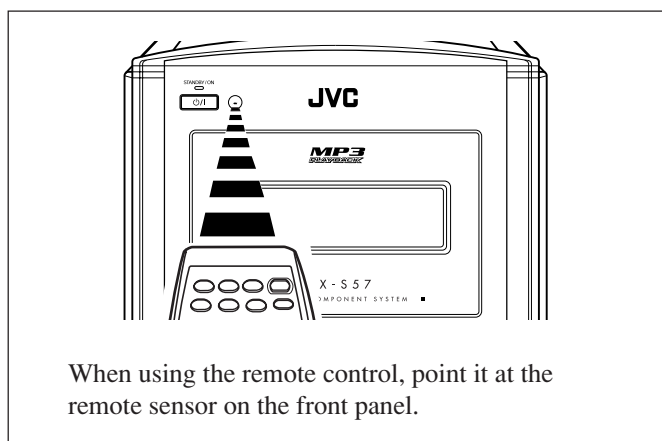

When using the remote control, point it at the remote sensor on the front panel.



## Unpacking

After unpacking, check to be sure that you have all the following items.

The number in parentheses indicates the quantity of each piece supplied.

- FM antenna (1)
- AM (MW) loop antenna (1)
- Remote control (1)
- Batteries (2)

If any item is missing, consult your dealer immediately.

## Connecting Antennas

### FM antenna

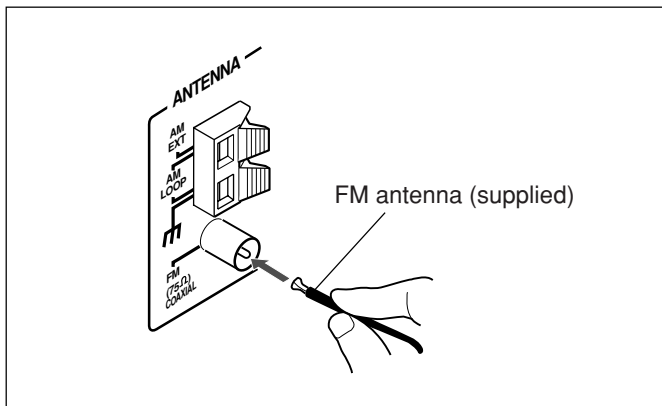

**1 Attach the FM antenna to the FM (75 Ω) COAXIAL terminal.**

**2 Extend the FM antenna.**

**3 Fasten it up in a position which gives you the best reception, then attach it to the wall, etc.**



#### About the supplied FM antenna

The FM antenna supplied with this unit can be used as a temporary measure. If reception is poor, you can connect an outdoor FM antenna.

### To connect an outdoor FM antenna

Before connecting it, disconnect the supplied FM antenna.

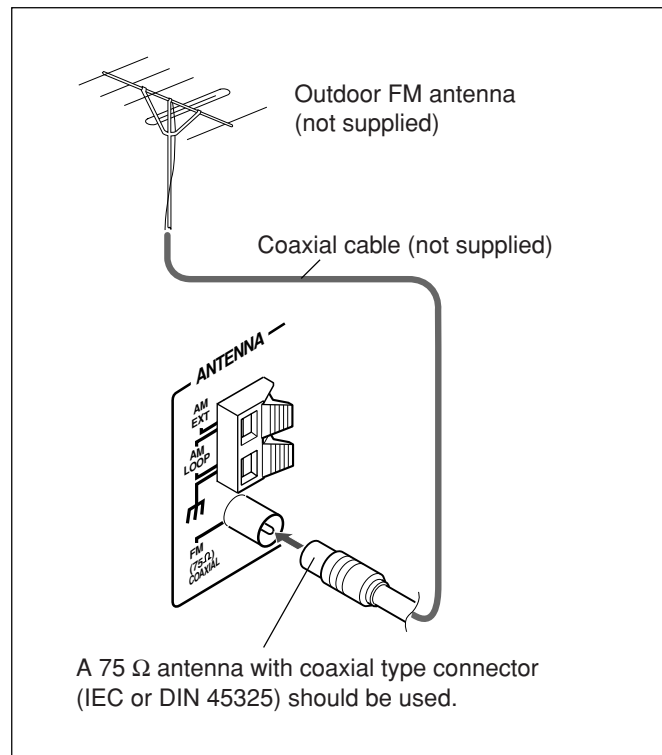

# Getting Started (continued)

Do not connect the AC power cord until all other connections have been made.

## AM (MW) antenna

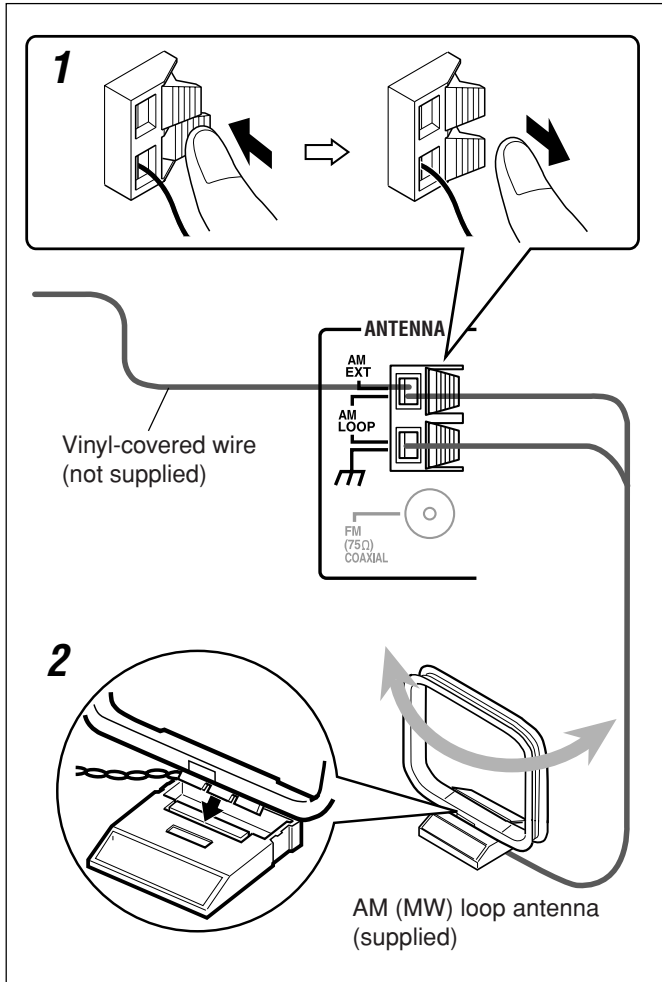

- 1 Connect the AM (MW) loop antenna to the AM LOOP terminals as illustrated.
- 2 Turn the AM (MW) loop antenna until you have the best reception.

### To connect an outdoor AM (MW) antenna

When reception is poor, connect a single vinyl-covered wire to the AM EXT terminal and extend it horizontally. The AM (MW) loop antenna must remain connected.



For better reception of both FM and AM (MW)

- Make sure the antenna conductors do not touch any other terminals or connecting cords.
- Keep the antennas away from metallic parts of the unit, connecting cords, and the AC power cord.

## Connecting Speakers

### To connect speakers

You can connect the speakers using the speaker cords.

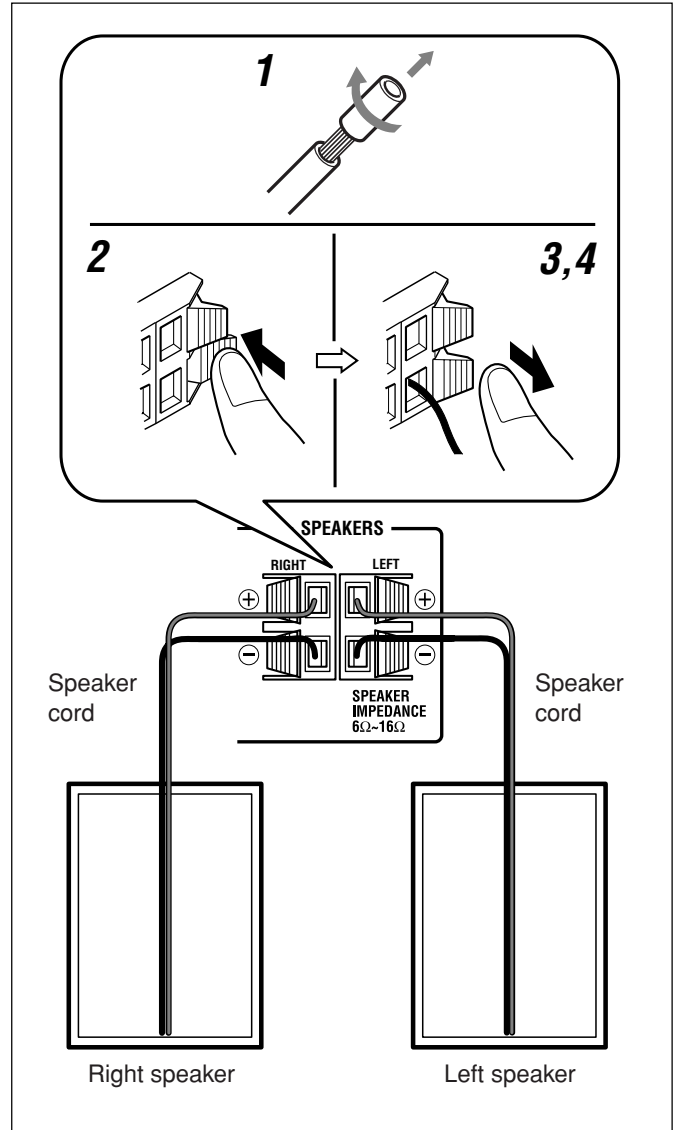

- 1 If the cords are covered with insulation, remove a short section of insulation at the end of each cord by twisting and pulling it off.
- 2 Hold the clamp of the speaker terminal.
- 3 Insert the end of the speaker cord into the terminal.  
Match the polarity of the speaker terminals: red cord to ⊕ and black cord to ⊖.
- 4 Release your finger from the clamp.

### IMPORTANT:

- Use only speakers with the same speaker impedance as indicated by the speaker terminals on the rear of the unit.
- DO NOT connect more than one speaker to one speaker terminal.

**Do not connect the AC power cord until all other connections have been made.**

### To remove the speaker grilles

The speaker grilles are removable as illustrated below:

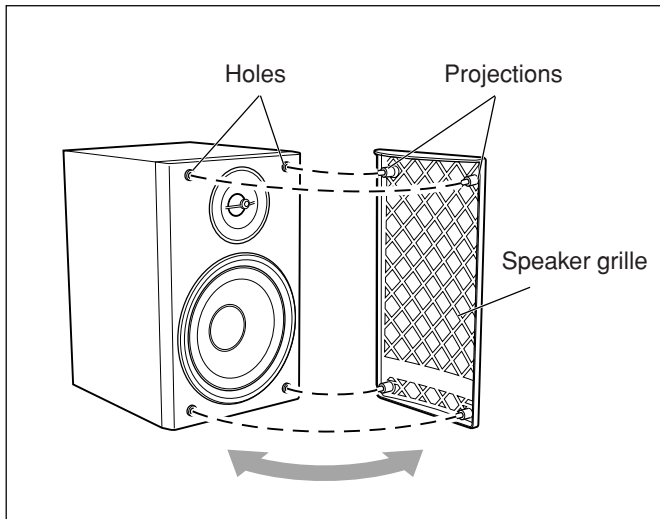

To remove the speaker grille, insert your fingers at the top of the speaker grille, then pull towards you. Also pull the bottom towards you.

To attach the speaker grille, follow the illustration above.

### Connecting Other Equipment

You can connect audio equipment—used only as a playback device.



- DO NOT connect any equipment while the power is on.
- DO NOT plug in any equipment until all connections are complete.

### To connect audio equipment

Be sure that the plugs of the audio cords are colored: White plugs and jacks are for left audio signals, and red ones for right audio signals.

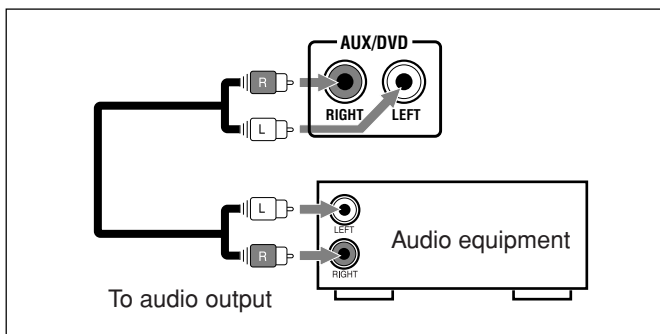

To play the other equipment through this unit, connect between the audio output jacks on the other equipment and AUX/DVD jacks by using audio cords (not supplied).

**NOW you are ready to plug in the unit and any other connected equipment.**

#### IMPORTANT:

Be sure to check that all connections have been made before plugging in the power cord.

### Putting the Batteries into the Remote Control

Insert the batteries—R6(SUM-3)/AA(15F)—into the remote control by matching the polarity (+ and -) on the batteries with the + and - marking on the battery compartment. When the remote control can no longer operate the unit, replace both batteries at the same time.

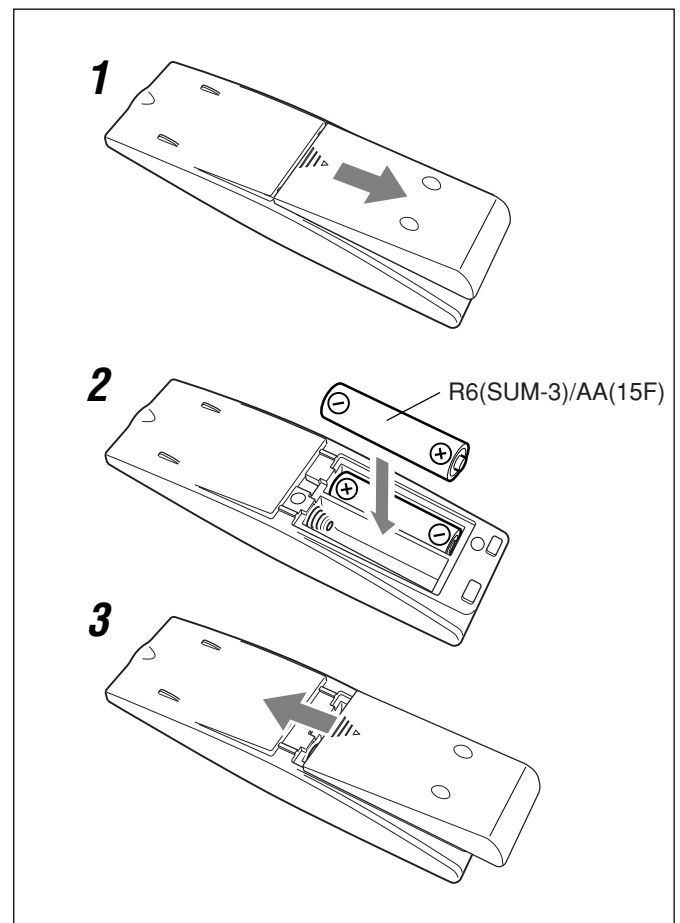

- DO NOT use an old battery together with a new one.
- DO NOT use different types of batteries together.
- DO NOT expose batteries to heat or flame.
- DO NOT leave the batteries in the battery compartment when you are not going to use the remote control for an extended period of time. Otherwise, the remote control will be damaged from battery leakage.

# Basic and Common Operations

## Setting the Clock

Before operating the unit any further, first set the unit's clock. When you plug in the power cord, "0:00" starts flashing on the display.

You can set the clock when the unit is either turned on or in standby mode.

### On the remote control ONLY:

#### 1 Press CLOCK/TIMER.

The hour digits start flashing on the display.

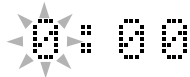

#### 2 Press ^ DISC UP or v DISC DOWN to adjust the hour, then press CLOCK/TIMER.

The minute digits start flashing.

- When you press and hold ^ DISC UP or v DISC DOWN, the hour digit changes continuously.

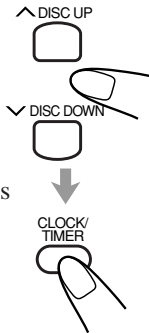
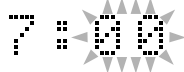

#### 3 Press ^ DISC UP or v DISC DOWN to adjust the minute, then press CLOCK/TIMER.

The built-in clock starts.

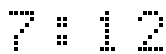

- **When you unplug the power cord or if a power failure occurs**  
The clock is reset to "0:00" right away. If this happens, set the clock again.
- **The clock may gain or lose 1 to 2 minutes per month**  
If this happens, reset the clock.

To show the clock when the unit is turned on

### On the remote control ONLY:

Press DISPLAY.

The clock indication appears on the display.

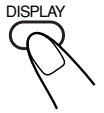

To return to the normal display, press DISPLAY again.



#### When playing an MP3 disc

Pressing DISPLAY shows the elapsed playing time instead of the clock time.

### To change the clock

- 1 **Make sure the ☺ (timer) indicator and the timer mode indicator (DAILY) are not lit on the display.**
  - If they are lit, press and hold CLOCK/TIMER until they go off.
- 2 **Press CLOCK/TIMER repeatedly until the unit enters the clock setting mode (the hour digits start flashing on the display).**  
First time you press CLOCK/TIMER, the unit enters the timer setting mode. (See page 22.)
- 3 **Repeat steps 2 and 3 of the procedure "Setting the Clock."**
- 4 **Press and hold CLOCK/TIMER again so that the ☺ (timer) indicator and the timer mode indicator (DAILY) go off.**

### To turn off the clock indication (power save mode)

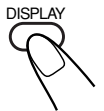

#### On the remote control ONLY:

Press DISPLAY while the unit is in standby mode. "DISPLAY OFF" appears on the display and the clock indication goes off.





To turn on the clock indication, press DISPLAY again while the unit is in standby mode. "DISPLAY ON" appears on the display.



## Turning On the Power

**To turn on the unit,** press STANDBY/ON  (or  on the unit).

The STANDBY/ON lamp on the unit lights green.

- When you press the source button— CD, FM/AM and AUX (or AUX/DVD on the unit), the unit automatically turns on and starts playback if the source is ready.
- Pressing one of the disc eject buttons (CD1  – CD5 ) also turns on the unit. (See page 17.)



**To turn off the unit (standby),** press STANDBY/ON  (or  on the unit) again.

The STANDBY/ON lamp on the unit lights red.

- “0:00” flashes on the display until you set the built-in clock. After setting the clock, the clock time will appear on the display while the unit is on in standby mode.
- A little power is always consumed even while the unit is in standby mode.

**To switch off the power supply completely,** unplug the AC power cord from the AC outlet.



**When you unplug the AC power cord or if a power failure occurs**

The clock is reset to “0:00” right away, while the tuner preset stations will be erased in a few days.

## To turn off the unit automatically (Auto Standby)

Using the Auto Standby function, the unit automatically turns itself off if no sound comes in for more than 3 minutes when “CD” is selected as the source.

If an operation is done within this 3-minute period, the Auto Standby function is canceled temporarily even though no sound comes in.

- You can also turn off the unit automatically by using the Sleep Timer. (See page 24.)

## On the remote control ONLY:

**To activate the Auto Standby function,** press A.STANDBY.

The AUTO STANDBY indicator lights up on the display.

- When no sound comes in, the AUTO STANDBY indicator starts flashing on the display. About 5 seconds before the unit turns itself off, “AUTO STANDBY” starts flashing on the display.



AUTO STANDBY indicator

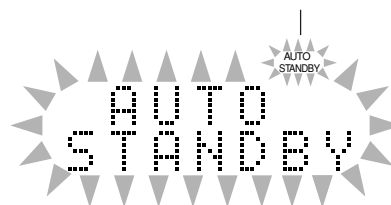

**To deactivate the Auto Standby function,** press A.STANDBY.

The AUTO STANDBY indicator goes off.

# Basic and Common Operations (continued)

## Adjusting the Volume

You can adjust the volume level only while the unit is turned on. The volume level can be adjusted between “VOLUME MIN” and “VOLUME 1” – “VOLUME 40 (VOLUME MAX).”

### On the remote control:

To increase the volume, press VOLUME +.

To decrease the volume, press VOLUME –.

- When you press and hold either button, you can change the volume level continuously.



### On the unit:

To increase the volume, turn the VOLUME + / – control clockwise.

To decrease the volume, turn the VOLUME + / – control counterclockwise.

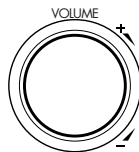

VOLUME 10



### For private listening

Connect a pair of headphones to the PHONES jack. No sound comes out of the speakers. Be sure to turn down the volume before connecting or putting on the headphones.



DO NOT turn off (standby) the unit with the volume set to an extremely high level; Otherwise, the sudden blast of sound can damage your hearing, speakers and/or headphones when you turn on the unit or start playing any source. REMEMBER you cannot adjust the volume level while the unit is in standby mode.

## Reinforcing the Bass Sound

The richness and fullness of the bass sound is clearly maintained regardless of how low you set the volume —Active Hyper Bass Pro.

- This function also affects the sound from headphones.

To get the effect, press AHB PRO repeatedly so that “AHB BASS1” or “AHB BASS2” appears on the display.

The **AHB PRO** indicator also lights up on the display.

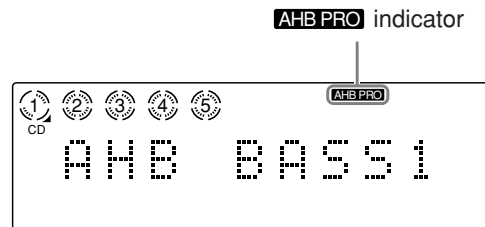

- Each time you press the button, the Active Hyper Bass Pro mode changes as follows:

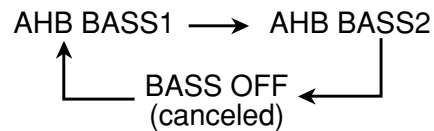

- “AHB BASS2” is more effective than “AHB BASS1.”

To cancel the effect, press AHB PRO repeatedly until “BASS OFF” appears on the display.

The **AHB PRO** indicator goes off.

## Adjusting the Tone

You can adjust the bass level (low frequency range) and the treble level (high frequency range) within a range of “-5” to “+5.”

When shipped, each level is set to “+2.”

- This function also affects the sound from headphones.
- There is a time limit in doing the following steps. If the setting is canceled before you finish, start again from step 1.

### On the remote control:

- 1 Press **BASS** to adjust the bass level or press **TREBLE** to adjust the treble level.



Ex.: When you select “BASS.”



- 2 Press **^ DISC UP** to increase the level or press **∨ DISC DOWN** to decrease the level.

BASS +2

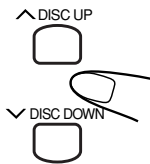

### On the unit:

- 1 Press **BASS** to adjust the bass level or press **TREBLE** to adjust the treble level.

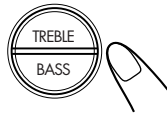

- 2 Press **▶▶| UP** to increase the level or press **|◀◀ DOWN** to decrease the level.

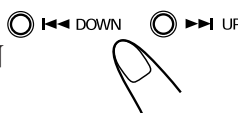

## Changing the Display Brightness

You can change the display brightness only while the unit is turned on.

### On the remote control ONLY:

Press **DIMMER** while the unit is turned on.

- Each time you press the button, the display brightness changes as follows:



**DIMMER 1:** The display illumination dims.



**DIMMER 2:** The display illumination dims and the blue illumination on the display disappears.



**DIMMER OFF:** The display and blue illumination resumes.



(back to the beginning)



Turning off the unit (standby) sets the display brightness back to “DIMMER OFF.”

# Listening to FM and AM (MW) Broadcasts

## Tuning in to a Station

### 1 Press FM/AM to select either “FM” or “AM.”

The unit automatically turns on and tunes in to the previously received station—either FM or AM (MW).

- Each time you press the button, the band alternates between FM and AM (MW).

FM  
87.50MHz



### 2 Press and hold >>> or <<< (or >>> UP or <<< DOWN on the unit) for more than 1 second.

- >>> (>>> UP):  
Increases the frequencies.
- <<< (<<< DOWN):  
Decreases the frequencies.

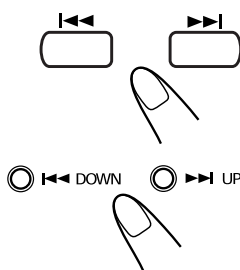

The unit starts searching for stations and stops when a station of sufficient signal strength is tuned in.

- If an FM program is broadcast in stereo, the STEREO indicator lights up on the display (only when the reception is good).

To stop during searching, press >>> or <<< (or >>> UP or <<< DOWN on the unit).



When you repeatedly press >>> or <<< (or >>> UP or <<< DOWN on the unit)

The frequency changes step by step.

## To change the FM reception mode

### On the remote control ONLY:

When an FM stereo broadcast is hard to receive or noisy, press FM MODE so that the MONO indicator lights up on the display. Reception will improve.



To restore the stereo effect, press FM MODE again so that the MONO indicator goes off. In stereo mode, you can hear stereo sound when a stereo program is broadcast.

## Presetting Stations

You can preset 30 FM and 15 AM (MW) stations manually.

In some cases, test frequencies have been already stored for the tuner since the factory examined the tuner preset function before shipment. This is not a malfunction. You can preset the stations you want into memory by following the presetting method.

- There is a time limit in doing the following steps. If the setting is canceled before you finish, start again from step 2.

### On the remote control ONLY:

#### 1 Tune in to the station you want to preset.

- See “Tuning in to a Station.”

#### 2 Press SET.

“SET” starts flashing on the display.



FM SET  
87.50MHz

#### 3 Press ^ DISC UP or v DISC DOWN to select a preset number.

FM 14  
87.50MHz

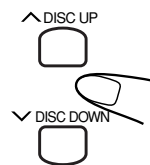

You can also select the preset number using the number buttons.

Ex.: For preset number 5, press 5.

For preset number 15, press +10, then 5.

For preset number 20, press +10, then 10.

For preset number 30, press +10, +10, then 10.

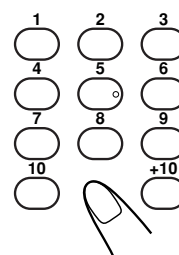



#### 4 Press SET again.

“STORED” appears on the display for a while.

STORED

The tuned station in step 1 is stored in the preset number selected in step 3.

- Storing a new station on an already assigned number erases the previously stored one.



#### To tune in to a preset station directly using the number buttons

##### On the remote control ONLY:

Pressing the number button(s) allows you to select the preset number you want.

Ex.: For preset number 5, press 5.

For preset number 15, press +10, then 5.

For preset number 20, press +10, then 10.

For preset number 30, press +10, +10, then 10.

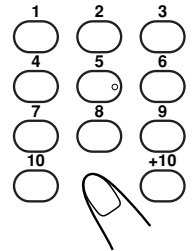

##### **When you unplug the AC power cord or if a power failure occurs**

The FM and AM (MW) preset stations will be erased in a day. If this happens, preset the stations again.

## Tuning in to a Preset Station

##### On the remote control ONLY:

#### 1 Press FM/AM to select either “FM” or “AM.”

The unit automatically turns on and tunes in to the previously received station—either FM or AM (MW).

- Each time you press the button, the band alternates between FM and AM (MW).



#### 2 Press ^ DISC UP or v DISC DOWN to select a preset number.

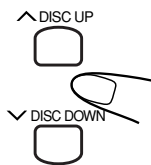

# Receiving FM Stations with RDS

RDS (Radio Data System) allows FM stations to send an additional signal along with their regular program signals. For example, the stations send their station names, as well as information about what type of program they broadcast, such as sports or music, etc. When tuned in to an FM station which provides the RDS service, the RDS indicator lights up on the display. With the unit, you can receive the following types of RDS signals.

## PS (Program Service):

Shows commonly known station names.

## PTY (Program Type):

Shows types of broadcast programs.

## RT (Radio Text):

Shows text messages the station sends.

## Enhanced Other Networks:

Provides information about the types of the programs sent by other RDS stations.



### More about RDS

- Some FM and AM (MW) stations do not provide RDS signals.
- RDS services vary among FM RDS stations. For details on RDS services in your area, check with local radio stations.
- RDS may not work correctly if the received station is not transmitting the signals properly or if the signal strength is weak.

## Changing the RDS Information

You can see RDS information on the display while listening to an FM station.

### On the remote control ONLY:

#### Press RDS DISPLAY.

- Each time you press the button, the display changes to show the following information:

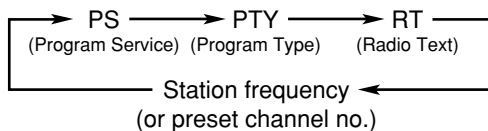

- If no PS, PTY, or RT signals are sent by a station "NO PS," "NO PTY," or "NO RT" appears on the display.

#### On the characters displayed

When the display shows PS, PTY or RT signals:

- The display shows upper case letters only.
- The display cannot show accented letters; for example, "A" may represent accented "A's" like "Á, Â, Ã, Ä and Å."

## Searching for Programs by PTY Codes (PTY Search)

One of the advantages of RDS is that you can locate a particular kind of program by specifying the PTY codes.

- For details on the PTY codes, see "Additional Information" on page 27.

### To search for a program using the PTY codes

REMEMBER you must preset FM RDS stations to use the PTY codes. If not yet done, see page 13.

- There is a time limit in doing the following steps. If the setting is canceled before you finish, start over from step 1.

### On the remote control ONLY:

#### 1 Press PTY SEARCH.

"PTY SELECT" appears on the display.



#### 2 Press PTY SELECT + or PTY SELECT - until the PTY code you want appears on the display.

- Each time you press the buttons, the PTY codes change as follows:

NONE ↔ NEWS ↔ AFFAIRS ↔ INFO  
 ↔ SPORT ↔ EDUCATE ↔ DRAMA  
 ↔ CULTURE ↔ SCIENCE ↔ VARIED  
 ↔ POP M ↔ ROCK M ↔ EASY M  
 ↔ LIGHT M ↔ CLASSICS ↔ OTHER M  
 ↔ WEATHER ↔ FINANCE ↔ CHILDREN  
 ↔ SOCIAL ↔ RELIGION ↔ PHONE IN  
 ↔ TRAVEL ↔ LEISURE ↔ JAZZ  
 ↔ COUNTRY ↔ NATION M ↔ OLDIES  
 ↔ FOLK M ↔ DOCUMENT ↔ TEST  
 ↔ ALARM ↔ (back to the beginning)

#### 3 Press PTY SEARCH once again.

While searching, "SEARCH" flashes and the selected PTY code appears on the display.

The unit searches 30 preset FM stations, stops when it finds the one you have selected ("FOUND" and the selected PTY code appear), and tunes in that station.

- If no program is found, "NOT FOUND" appears on the display and the unit returns to the last received station.

To stop searching any time during the process, press PTY SEARCH while searching.

## Switching Temporarily to a Program Type of Your Choice

The Enhanced Other Networks function allows the unit to switch temporarily to a broadcast program of your choice (TA, News, and Info) from a different station.

- The function only works when you are listening to a preset FM RDS stations providing the data.

### To activate the Enhanced Other Networks function

REMEMBER you must preset FM RDS stations to use the function. If not yet done, see page 13.

- There is a time limit in doing the following steps. If the setting is canceled before you finish, start over from step 1.

### On the remote control ONLY:

#### 1 Press TA/News/Info until the data type you want flashes on the display.

- Each time you press the button, the data type indication changes as follows:

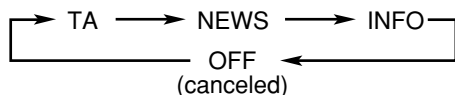

- TA:** Traffic announcement
- NEWS:** News
- INFO:** Program the purpose of which is to impart advice in the widest sense.
- OFF:** The function is canceled.

#### 2 Wait for about 3 seconds after specifying the data type.

The data type on the display stops flashing and remains lit. Now, the function is activated. See “How the Enhanced Other Networks function actually works.”

## How the Enhanced Other Networks function actually works:

### CASE 1

#### If there is no station broadcasting the program you have selected

The unit continues tuning in to the current station.



When a station starts broadcasting the program you have selected, the unit automatically switches to the station. The received PTY code on the display starts flashing.



When the program is over, the unit goes back to the previously tuned station, but the function still remains activated.

### CASE 2

#### If there is a station broadcasting the program you have selected

The unit tunes in to the program. The received PTY code on the display starts flashing.



When the program is over, the unit goes back to the previously tuned station, but the function still remains activated.

### CASE 3

#### If the FM station you are listening to is broadcasting the program you have selected

The unit continues to receive the station but the received PTY code on the display starts flashing.



When the program is over, the received PTY code stops flashing and remains lit on the display, but the function still remains activated.



### More about the Enhanced Other Networks function

- The data sent from some stations may not be compatible with this unit and also some stations may not include Enhanced Other Networks data. In this case, the function may not work correctly.
- While listening to a program tuned into by the function, the station does not change even if another network station starts broadcasting a program of the same data.

# Playing Back Discs on the 5-CD Changer

This unit has been designed to play back the following discs—CD, CD-R, and CD-RW.

You can play back the discs containing the tracks in music CD format or MP3 files in ISO 9660 format.

- In this instruction, we call a disc recorded MP3 files “MP3 disc,” and “file” is also referred to as “track.”

## When playing CD-Rs or CD-RWs

- Before playing CD-Rs or CD-RWs, read their instructions or cautions carefully.
- User-edited CD-Rs (CD-Recordable) and CD-RWs (CD-ReWritable) can be played only if they are already “finalized.”
- This unit supports “multi-session” discs (up to 5 sessions).
- This unit cannot play “packet write” discs.
- Some CD-Rs or CD-RWs may not be played back on this unit because of their disc characteristics, damage or stain on them, or if the player’s lens is dirty.
- CD-RWs may require a longer readout time. This is because the reflectance of CD-RWs is lower than for regular discs.

## Notes for MP3 files

- The player can only recognize files with “MP3” or “mp3” as the extensions, which can be in any combination of upper and lower case.
- It is recommended that you record your material at a 44.1 kHz sampling rate, using the 128 kbps data transfer rate.
- Some MP3 files or discs may not be played back because of their characteristics or recording conditions.
- MP3 discs requires a longer readout time than normal discs because of the complexity of the group/file configuration.
- MP3i and MP3 Pro are not available.

## General notes

In general, you will have the best performance by keeping your discs and the mechanism clean.

- Store discs in their cases, and keep them in cabinets or on shelves.
- Keep the unit’s disc trays closed when not in use.
- Continued use of irregular shape discs (heart-shape, octagonal, etc.) can damage the unit.

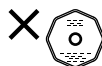

## About the disc indicators

Disc number indicator



While playback is stopped.

Current disc indicator



During playback.

1

When no disc is on the tray.

- When the current source is “CD,” the CD indicator also lights up on the display.

## Loading Discs

### On the unit ONLY:

- 1 Press one of the disc eject buttons (CD1▲ – CD5▲) for the disc tray you want to load a disc onto.

The unit automatically turns on and the selected disc tray comes out.



- 2 Place a disc correctly on the circle of the disc tray, with its label side up.

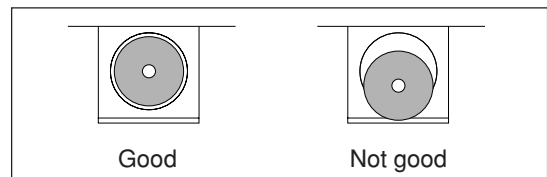
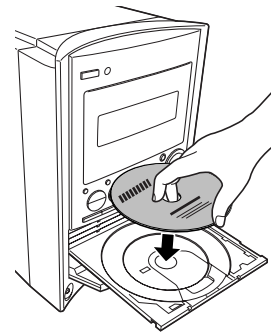

- When using a CD single (8 cm), place it on the inner circle of the disc tray.

- 3 Press the same disc eject button (CD1▲ – CD5▲) you have pressed in step 1.

The disc tray closes.



### When loading more than one disc at a time

Press the disc eject button (CD1▲ – CD5▲) for the next tray you want to place a disc onto. The first disc tray automatically closes and the next disc tray comes out.

## Playing Back All the Entire Discs —Continuous Play

You can play discs continuously.

### 1 Load discs into the 5-CD Changer.

### 2 Select a disc to play.

#### On the remote control:

1) Press  CD, then .

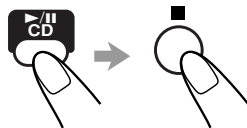

2) Press  DISC UP or  DISC DOWN to select the disc you want.

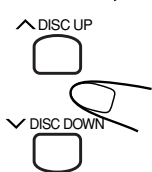

#### On the unit:

Press DISC SELECT repeatedly to select the disc you want.



### 3 Press CD.

Playback starts from the first track of the selected disc.

Ex. When an audio CD is played back.

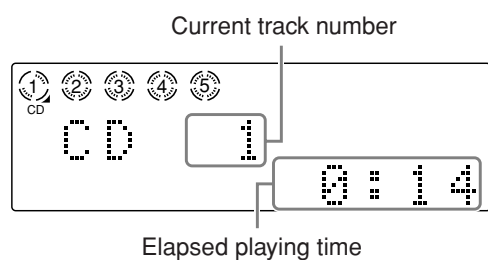

Ex. When an MP3 disc is played back.

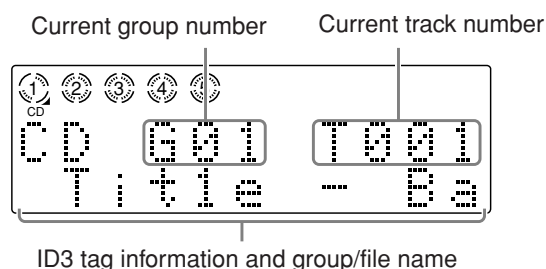

- Without selecting the disc number, pressing  CD starts playing back from the currently selected disc.



To stop play for a moment, press  CD. While pausing, the elapsed playing time flashes on the display.



To resume play, press  CD again.

To stop during play, press .



To remove discs, press the corresponding disc eject buttons (CD1  – CD5 ) on the unit.

To start Continuous Play while a source other than “CD” is selected

#### On the unit ONLY:

Press DISC SELECT repeatedly to select a disc, then press  CD.

- Each time you press DISC SELECT before  CD, the disc tray number changes.



Disc tray number



#### Disc playback sequence in the 5-CD Changer

When 5 discs are loaded on the disc trays\*, they are played in the following sequence:

Ex.: When playback is started from the CD 2 tray:

CD 2 ⇒ CD 3 ⇒ CD 4 ⇒ CD 5 ⇒ CD 1 (then stops)

- \* If no disc is on the disc tray, 5-CD Changer skips that tray.



#### While playing back an MP3 disc

ID3 Tag information (the name of the title, artist, and album) and group/file name will be shown on the display. When the name is too long to be displayed at once, it is scrolled.

# Playing Back Discs on the 5-CD Changer (continued)

## Basic Disc Operations

To exchange a disc during playback of another disc

### On the unit ONLY:

Press the disc eject buttons (CD1▲ – CD5▲) to eject a disc not currently playing.



If discs are exchanged during playback, playback will stop after playing all newly inserted discs.

To start playing a disc during playback of another disc

### On the remote control:

Press ▲ DISC UP or ▼ DISC DOWN. Each time you press the button, the next or previous disc is selected and playback starts.

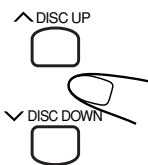

### On the unit:

Press DISC SELECT repeatedly. Each time you press the button, the next disc is selected and playback starts.



To locate a particular point in a track during play

### On the remote control:

Press and hold ►►► or ◀◀◀.



### On the unit:

Press and hold ►►► UP or ◀◀◀ DOWN.



- ►►► (►►► UP): Fast-forwards the tracks.
- ◀◀◀ (◀◀◀ DOWN): Fast-reverses the tracks.

To go to another track

### On the remote control:

Press ►►► or ◀◀◀ repeatedly.



### On the unit:

Press ►►► UP or ◀◀◀ DOWN repeatedly.



- ►►► (►►► UP): Skips to the beginning of the next or succeeding tracks.
  - You can skip to tracks on the next disc.
- ◀◀◀ (◀◀◀ DOWN): Goes back to the beginning of the current or previous tracks.
  - You cannot skip back to tracks on the previous disc.

To go to another track directly using the number buttons

### On the remote control ONLY:

Pressing the number button(s) allows you to start playing the track number on the current disc.

Ex.: For track number 5, press 5.

For track number 15, press +10, then 5.

For track number 20, press +10, then 10.

For track number 30, press +10, +10, then 10.

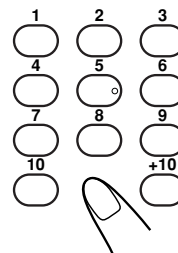

To select a group or track before playback (MP3 discs ONLY)

When the current disc is an MP3 disc, you can start playback from the favorite group/track.

1. When "G01" is flashing, press ►►► or ◀◀◀ (or, ►►► UP or ◀◀◀ DOWN on the unit) repeatedly to select a group.

- To flash "G01," press ■ when "T001" is flashing, or press ■ twice when the disc is played back.

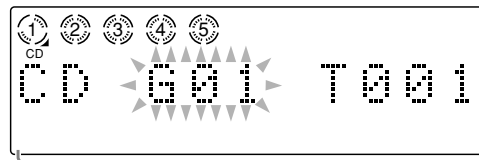

Group name

2. Press ►/|| CD to flash "T001," then press ►►► or ◀◀◀ (or, ►►► UP or ◀◀◀ DOWN on the unit) repeatedly to select a track.

- When you select a group again, press ■.

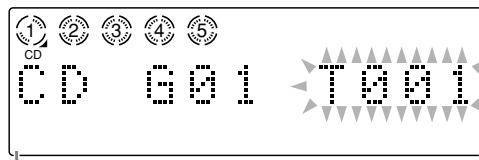

File name

3. Press ►/|| CD to start playback.



### During playback of an MP3 track

You can show the following items alternately by pressing DISPLAY:

- the file name of the current track and the ID3 tag information
- the elapsed playing time



## Programming the Track Playing Order —Program Play

You can arrange the order in which the tracks play before you start playing. You can program up to 100 tracks.

### 1 Load discs into the 5-CD Changer.

- If the current playing source is not “CD,” press **▶/|| CD**, then **■** before going to the next step.

### 2 Press **PLAY MODE** repeatedly until “CD PROGRAM” appears on the display.

The PRGM indicator also lights on the display.

PRGM indicator

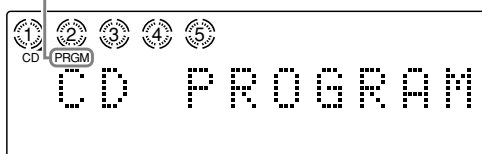

- Each time you press the button, play mode changes as follows:



### 3 Press **▲ DISC UP** or **▼ DISC DOWN** to select the disc number you want to play.

Program step number

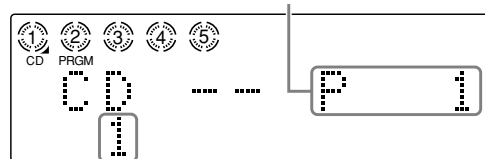

Disc number

### 4 Press the number buttons to select a track from the disc selected in the previous step.

- For how to use the number buttons, see “To go to another track directly using the number buttons” on the previous page.

Track number

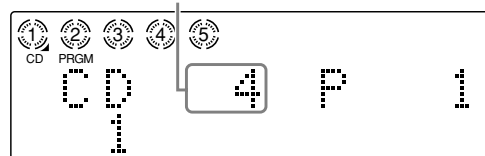

### 5 Program other tracks you want.

- To program tracks from the same disc, repeat step 4.
- To program tracks from a different disc, repeat steps 3 and 4.

### 6 Press **▶/|| CD**.

- The tracks are played in the order you have programmed.



To stop during play, press **■**.

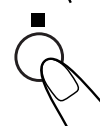

To exit from the Program Play mode, before or after play, press **PLAY MODE** once or twice so that the unit enters another disc playback mode (Random Play or Continuous Play).



The PRGM indicator goes off.

- Turning off the unit or changing the source also cancels Program Play and changes the disc playback mode to Continuous Play.

### To check the program contents

Before playing, you can check the program contents by pressing **▶▶|** or **||◀◀**.

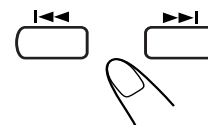

- **▶▶|**: Shows the programmed tracks in the programmed order.
- **||◀◀**: Shows them in the reverse order.
  - Pressing **||◀◀** first time after you have programmed shows the first track in the program.

### To modify the program

Before playing, you can erase the last programmed track by pressing **CANCEL**.

Each time you press the button, the last programmed track is erased from the program.



To add tracks to the program before playing, simply select disc numbers and track numbers you want to add on steps 3 and 4.



In the Program Play mode, you cannot open the disc trays.

### If you try to program a 101st track

“MEMORY FULL” will appear on the display.

### When “NO PROGRAM” appears on the display

- You are trying to program a track from an empty tray, or a track number that does not exist on the disc.
- You are selecting the disc that the unit has not read yet.

# Playing Back Discs on the 5-CD Changer (continued)

## Playing at Random—Random Play

The tracks of all loaded discs will play at random.

### 1 Load discs into the 5-CD Changer.

- If the current playing source is not “CD,” press ►/|| CD, then ■ before going to the next step.

### 2 Press PLAY MODE repeatedly until “CD RANDOM” appears on the display.

The RANDOM indicator also lights on the display.

RANDOM indicator



- Each time you press the button, play mode changes as follows:



### 3 Press ►/|| CD.

The tracks are played at random. Random Play stops when all the tracks are played once.

To stop during play, press ■.

- Opening a disc tray also stops and cancels Random Play.

To skip the current track, press ►►.

- The ◀◀ button does not work during Random Play.

To exit from the Random Play mode, before or after play, press PLAY MODE once or twice so that the unit enters another disc playback mode (Continuous Play or Program Play).

The RANDOM indicator goes off.

- Turning off the unit or changing the source also cancels Random Play and changes the disc playback mode to Continuous Play.

## Repeating Tracks or Discs—Repeat Play

You can repeat each track, each disc, or all discs in the 5-CD Changer as many times as you like. You can also repeat your program.

Press REPEAT repeatedly during or before playing.



CD  
REPEAT 1

- Each time you press the button, the Repeat Play mode changes and appears on the display as follows:

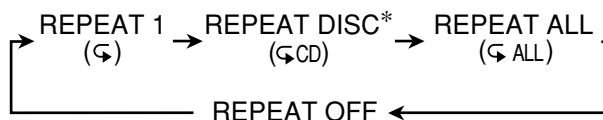

- **REPEAT 1:** Repeats one track.
- **REPEAT DISC\*:** Repeats all tracks on one disc.
- **REPEAT ALL:** Repeats all tracks on all discs (continuously or at random), or all tracks in the program.
- **REPEAT OFF:** Cancels Repeat Play.

\* “REPEAT DISC” is not used for Program Play or Random Play.

## Prohibiting Disc Ejection

You can prohibit disc ejection from the unit and can lock discs—Disc Lock.

You can lock or unlock discs when the unit is either turned on or in standby mode.

### On the unit ONLY:

To prohibit disc ejection, while holding ■, press ◻/I.

“LOCKED” appears on the display for a while, and the loaded discs are locked.



LOCKED

If you try to eject a locked disc, “LOCKED” appears to inform you that the Disc Lock is in use.

To cancel the prohibition and unlock the disc, repeat the above procedure. “UNLOCKED” appears on the display for a while, and the loaded discs are unlocked.



# Using the Timers

Continued 

Two timers are available—Daily Timer and Sleep Timer.

- Before using these timers, make sure the built-in clock is set correctly (see page 9).

## Using the Daily Timer

You can set the timer when the unit is either turned on or in standby mode.

### How the timer actually works

When the on-time comes, the unit automatically turns on (the ⌚ (timer) indicator flashes just before the on-time and continues flashing while the timer is operating). Then, when the off-time comes, the unit automatically turns off (standby). The timer setting remains in memory until you change it.

- When the DAILY indicator is lit on the display, the timer acts as the Daily Timer. Once the timer has been set, it will be activated at the same time everyday until the timer is turned off.

### Before you start...

When using “TUNER” as the source to play, make sure to select the desired station before turning off the power.

- There is a time limit in doing the following steps. If the setting is canceled before you finish, start again from step 1.

## On the remote control ONLY:

### 1 Press CLOCK/TIMER.

The ⌚ (timer) indicator lights up and the timer mode indicator (DAILY) flashes on the display. The unit enters the on-time setting mode.

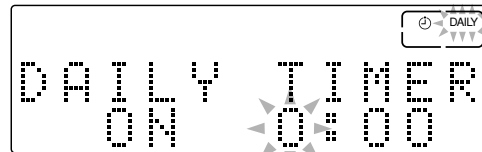

Ex.: When the Daily Timer has been selected the last time.

### 2 Set the on-time you want the unit to turn on.

- 1) Press ▲ DISC UP or ▼ DISC DOWN to set the hour, then press CLOCK/TIMER.
- 2) Press ▲ DISC UP or ▼ DISC DOWN to set the minute, then press CLOCK/TIMER.

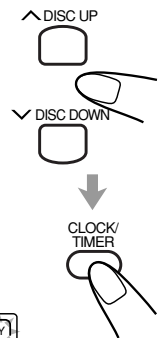

The unit enters the off-time setting mode.

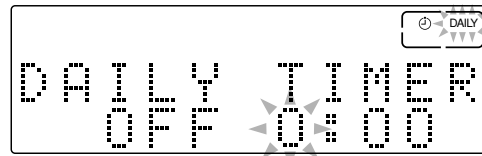

### 3 Set the off-time you want the unit to turn off.

- 1) Press ▲ DISC UP or ▼ DISC DOWN to set the hour, then press CLOCK/TIMER.
- 2) Press ▲ DISC UP or ▼ DISC DOWN to set the minute, then press CLOCK/TIMER.

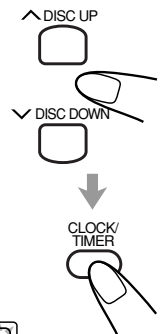

The unit enters the source setting mode.

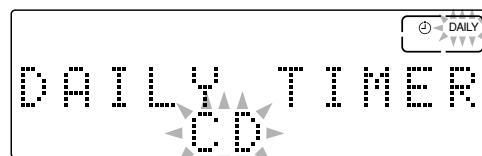

# Using the Timers (continued)

**4** Press **▲ DISC UP** or **▼ DISC DOWN** to select the timer mode and the source to play, then press **CLOCK/TIMER**.

- Each time you press **▲ DISC UP** or **▼ DISC DOWN**, the timer mode and the source to play change as follows:



- **“DAILY TIMER CD”**: plays the selected disc or your program (Daily Timer).
  - Load a disc or make the program.
  - go to step **5**.
- **“DAILY TIMER TUNER”**: tunes in to the last station you have been listening to (Daily Timer).
  - go to step **6**.

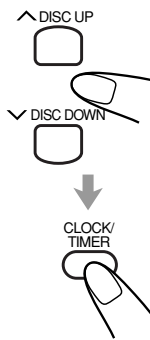

**6** Press **▲ DISC UP** or **▼ DISC DOWN** to set the volume level, then press **CLOCK/TIMER**.

- You can select the volume level between “VOLUME --” and “VOLUME 0” to “VOLUME 40.”
- If you select “VOLUME --,” the volume level is set to the current volume.

The selected timer mode indicator (DAILY) stops flashing.

The unit enters the clock setting mode.

**7** Adjust the clock if needed.

- See “Setting the Clock” on page 9.

**8** Press **STANDBY/ON** to turn off the unit if the unit is on.



**5** When selecting **“DAILY TIMER CD”** in step **4**, select the disc number to play or Program Play.

1) Press **▲ DISC UP** or **▼ DISC DOWN** to select the disc number or Program Play.

- Each time you press the button, the indication on the display changes as follows:



- **“CD DISC 1”** – **“CD DISC 5”**: plays the selected disc.
- **“CD PROGRAM”**: plays the program you have made.

2) Press **CLOCK/TIMER**.



The unit enters the volume level setting mode.

When the timer turns on the unit, the (timer) indicator and the selected timer mode indicator (DAILY) start flashing.

**To deactivate the timer temporarily**, press and hold **CLOCK/TIMER** until the (timer) indicator and the selected timer mode indicator (DAILY) go off.



**To activate and change the timer**, repeat steps **1** to **7** on pages 22 and 23.

- If you want to change the Daily Timer setting, deactivate the timer first.
- To activate the timer again without changing the setting, press **CLOCK/TIMER** repeatedly until the (timer) indicator and the selected timer mode indicator (DAILY) light up on the display.



**If the unit is already turned on when the timer-on time comes**

The timer does not work.



**When you unplug the AC power cord or if a power failure occurs**

The timer will be canceled. You need to set the clock first, then set the timer again.



**When you have selected “CD PROGRAM” in step 5**

Do not press **DISPLAY** while the unit is in standby mode to turn off the clock indication (“DISPLAY OFF”); otherwise, the program contents is cleared and playback starts in the Continuous Play mode when the timer-on time comes.

## Using the Sleep Timer

With the Sleep Timer, you can fall asleep listening to your favorite music or radio program.

- You can set the Sleep Timer only when the unit is turned on.

### How the Sleep Timer actually works

The unit automatically turns off after the specified length of time passes.

### On the remote control ONLY:

#### 1 Press SLEEP.

The SLEEP indicator lights up on the display. "SLEEP 10" appears on the display for a while.

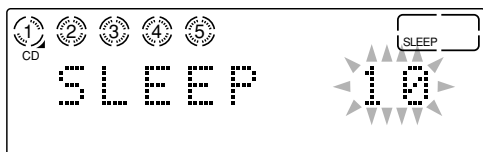

- Each time you press the button, the length of time changes as follows:

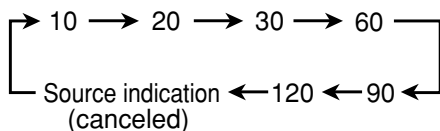

#### 2 Wait for about 5 seconds after specifying the length of time.

To check the remaining time until shut-off time, press SLEEP once. The remaining time until shut-off time appears for about 5 seconds.

To change the shut-off time, press SLEEP repeatedly until the length of time you want appears.

To cancel the setting, press SLEEP repeatedly until the current source indication appears on the display. The SLEEP indicator goes off.

- Turning off the unit also cancels the Sleep Timer.



If you set the Sleep Timer after the Daily Timer starts playing the selected source

The Daily timer is canceled. The unit turns off when the Sleep Timer shut-off time comes.



You can also turn off the unit automatically by using the Auto Standby function. (See page 10.)

# Maintenance

To get the best performance of the unit, keep your discs clean.

## General Notes

In general, you will have the best performance by keeping your discs clean.

- Store discs in their cases, and keep them in cabinets or on shelves.

## Cleaning the unit

### • Stains on the unit

Should be wiped off with a soft cloth. If the unit is heavily stained, wipe it with a cloth soaked in water-diluted neutral detergent and wrung well, then wipe clean with a dry cloth.

- **Since the unit may deteriorate in quality, become damaged or have its paint peel off, be careful about the following:**
  - DO NOT wipe it with a rough cloth.
  - DO NOT wipe it too vigorously.
  - DO NOT wipe it with thinner or benzine.
  - DO NOT apply any volatile substance such as an insecticide to it.
  - DO NOT allow any rubber or plastic to remain in contact with it for a long time.

## Handling discs

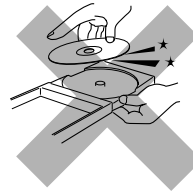

- Remove the disc from its case by holding it at the edge while pressing the center hole lightly.
- Do not touch the shiny surface of the disc, or bend the disc.
- Put the disc back in its case after use to prevent warping.

- Be careful not to scratch the surface of the disc when placing it back in its case.
- Avoid exposure to direct sunlight, temperature extremes, and moisture.

### To clean the disc

Wipe the disc with a soft cloth in a straight line from center to edge.



DO NOT use any solvent—such as conventional record cleaner, spray, thinner, or benzine—to clean the disc.

# Troubleshooting

If you are having a problem with your unit, check this list for a possible solution before calling for service.

If you cannot solve the problem from the hints given here, or the unit has been physically damaged, call a qualified person, such as your dealer, for service.

Symptom	Possible Cause	Action
Power does not come on.	The power cord is not connected to an AC outlet.	Insert the plug into the socket.
No sound is heard.	<ul style="list-style-type: none"><li>• Connections are incorrect or loose.</li><li>• A pair of headphones is connected.</li></ul>	<ul style="list-style-type: none"><li>• Check all connections and make corrections. (See pages 6 to 8.)</li><li>• Unplug the headphones from the PHONES jack.</li></ul>
Hard to listen to broadcasts because of noise.	<ul style="list-style-type: none"><li>• Antennas are disconnected.</li><li>• The AM (MW) loop antenna is too close to the unit.</li><li>• The FM antenna is not properly extended and positioned.</li></ul>	<ul style="list-style-type: none"><li>• Reconnect the antenna correctly and securely.</li><li>• Change the position and direction of the AM (MW) loop antenna.</li><li>• Extend FM antenna and orient to the best reception position.</li></ul>
Loaded discs cannot be ejected.	<ul style="list-style-type: none"><li>• The AC power cord is not plugged in.</li><li>• The Disc Lock function is in use.</li></ul>	<ul style="list-style-type: none"><li>• Plug in the AC power cord.</li><li>• Cancel the Disc Lock function. (See page 21.)</li></ul>
The disc does not play.	The disc is upside down.	Put the disc in with the label side up.
Operations are disabled.	The built-in microprocessor has malfunctioned due to external electrical interference.	Unplug the AC power cord then plug it back in.
Unable to operate the unit by the remote control.	<ul style="list-style-type: none"><li>• The path between the remote control and the remote sensor on the unit is blocked.</li><li>• The batteries are exhausted.</li><li>• You are using the remote control too far from the unit.</li></ul>	<ul style="list-style-type: none"><li>• Remove the obstruction.</li><li>• Replace the batteries. (See page 8.)</li><li>• Signals cannot reach the remote sensor. Move closer to the unit.</li></ul>

# Additional Information

## Description of the PTY codes:

<b>NEWS:</b>	News.
<b>AFFAIRS:</b>	Topical program expanding or enlarging upon the news—debate, or analysis.
<b>INFO:</b>	Program the purpose of which is to impart advice in the widest sense.
<b>SPORT:</b>	Program concerned with any aspect of sports.
<b>EDUCATE:</b>	Educational programs.
<b>DRAMA:</b>	All radio plays and serials.
<b>CULTURE:</b>	Programs concerning any aspect of national or regional culture, including language, theater, etc.
<b>SCIENCE:</b>	Programs about natural sciences and technology.
<b>VARIED:</b>	Used for mainly speech-based programs such as quizzes, panel games and personality interviews.
<b>POP M:</b>	Commercial music of current popular appeal.
<b>ROCK M:</b>	Rock music.
<b>EASY M:</b>	Current contemporary music considered to be “easy-listening.”
<b>LIGHT M:</b>	Instrumental music, and vocal or choral works.
<b>CLASSICS:</b>	Performances of major orchestral works, symphonies, chamber music, etc.
<b>OTHER M:</b>	Music not fitting into any of the other categories.
<b>WEATHER:</b>	Weather reports and forecasts.
<b>FINANCE:</b>	Stock Market reports, commerce, trading etc.
<b>CHILDREN:</b>	Programs targeted at a young audience.
<b>SOCIAL:</b>	Programs about sociology, history, geography, psychology and society.
<b>RELIGION:</b>	Religious programs.
<b>PHONE IN:</b>	Involving members of the public expressing their views either by phone or at a public forum.
<b>TRAVEL:</b>	Travel information.

<b>LEISURE:</b>	Programs about recreational activities.
<b>JAZZ:</b>	Jazz music.
<b>COUNTRY:</b>	Songs which originate from, or continue the musical tradition of the American Southern States.
<b>NATION M:</b>	Current popular music of the nation or region in that country’s language.
<b>OLDIES:</b>	Music from the so-called “golden age” of popular music.
<b>FOLK M:</b>	Music which has its roots in the musical culture of a particular nation.
<b>DOCUMENT:</b>	Program concerning factual matters, presented in an investigative style.
<b>TEST:</b>	Broadcasts for testing emergency broadcast equipment or receiver.
<b>ALARM:</b>	Emergency announcement.

**Classification of the PTY codes for some FM stations may be different from the list on this page.**



### Alarm function

If an “ALARM” (Emergency) signal is received from a station while listening to the radio, the unit automatically switches to the station broadcasting the “ALARM” signal, except when you are listening to non-RDS stations—all AM (MW) and some FM stations.



### Test function

The “TEST” signal is used for testing the “ALARM” signal. Therefore, it makes the unit work in the same way as the “ALARM” signal does.

If a “TEST” signal is received from a station while listening to the radio, the unit automatically switches to the station broadcasting the “TEST” signal, except when you are listening to non-RDS stations—all AM (MW) and some FM stations.

# Specifications

---

## Amplifier Section—CA-UXS57

Output Power (IEC 268-3):

120 W (60 W + 60 W) at 6  $\Omega$  (10% THD)

Analog input sensitivity/Impedance (at 1 kHz)

AUX/DVD: 400 mV/48 k $\Omega$

Speakers/Impedance: 6  $\Omega$  – 16  $\Omega$

## Tuner

FM tuning range: 87.50 MHz—108.00 MHz

AM (MW) tuning range: 522 kHz—1 629 kHz

## CD player

CD Capacity: 5 CDs

Dynamic range: 87 dB

Signal-to-noise ratio: 90 dB

Wow and flutter: Immeasurable

## General

Power requirement: AC 230 V  $\sim$ , 50 Hz

Power consumption: 110 W (at operation)

17 W (on standby)

1.4 W (in power save mode)

Dimensions (W/H/D) (approx.):

175 mm x 240 mm x 378 mm

Mass (approx.):

7.4 kg

## Supplied accessories

See page 6.

## Speaker Section—SP-UXS57

Type: 2-way bass-reflex type

Speakers: Woofer 12 cm cone x1

Tweeter 4 cm cone x1

Power handling capacity: 60 W

Impedance: 6  $\Omega$

Frequency range: 53 Hz to 30 kHz

Sound pressure level: 84 dB/W•m

Dimensions (W/H/D) (approx.):

145 mm x 239.5 mm x 202 mm

Mass (approx.):

2.2 kg each

*Design and specifications are subject to change without notice.*





## Free Manuals Download Website

<http://myh66.com>

<http://usermanuals.us>

<http://www.somanuals.com>

<http://www.4manuals.cc>

<http://www.manual-lib.com>

<http://www.404manual.com>

<http://www.luxmanual.com>

<http://aubethermostatmanual.com>

Golf course search by state

<http://golfingnear.com>

Email search by domain

<http://emailbydomain.com>

Auto manuals search

<http://auto.somanuals.com>

TV manuals search

<http://tv.somanuals.com>