

JVC

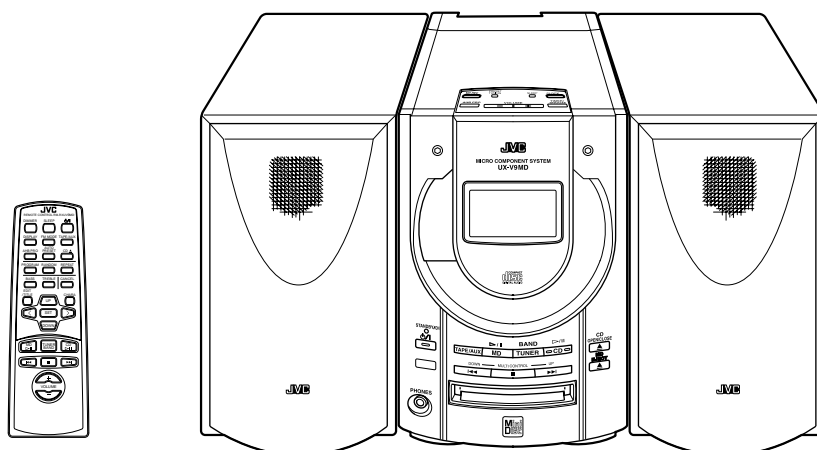

MICRO COMPONENT SYSTEM

UX-V9MD



COMPACT
disc
DIGITAL AUDIO

INSTRUCTIONS

For Customer Use:

Enter below the Model No. and Serial No. which are located either on the rear, bottom or side of the cabinet. Retain this information for future reference.

Model No. _____

Serial No. _____

LVT0247-005A

[A]

Warnings, Cautions and Others

Caution — ⚡ switch!

Disconnect the mains plug to shut the power off completely. The ⚡ switch in any position does not disconnect the mains line. The power can be remote controlled.

CAUTION

To reduce the risk of electrical shocks, fire, etc.:

- 1 Do not remove screws, covers or cabinet.
- 2 Do not expose this appliance to rain or moisture.

Caution: Proper Ventilation

To avoid risk of electric shock and fire, and to prevent damage, locate the apparatus as follows:

- 1 Front: No obstructions and open spacing.
- 2 Sides/ Top/ Back: No obstructions should be placed in the areas shown by the dimensions below.
- 3 Bottom: Place on the level surface. Maintain an adequate air path for ventilation by placing on a stand with a height of 10 cm or more.

1 CLASS 1 LASER PRODUCT

2 **DANGER:** Invisible laser radiation when open and interlock failed or defeated. Avoid direct exposure to beam.

3 **CAUTION:** Do not open the top cover. There are no user serviceable parts inside the Unit; leave all servicing to qualified service personnel.

IMPORTANT FOR LASER PRODUCTS

REPRODUCTION OF LABELS

1 CLASSIFICATION LABEL, PLACED ON EXTERIOR SURFACE



2 WARNING LABEL, PLACED INSIDE THE UNIT

DANGER: Invisible laser radiation when open and interlock failed or defeated. AVOID DIRECT EXPOSURE TO BEAM. (e)

WARNING: Osynlig laserstrålning när denna del är öppnad och spärren är urkopplad. Betrakta ej strålen. (s)

ADVARSEL: Usynlig laserstrålning ved åbning, når sikkerhedsafbrydere er ude af funktion. Undgå udsættelse for stråling. (d)

VARO: Avattaessa ja suo-jalukitus ohitettaessa olet alttiina näkymättömälle lasersäteilylle. Älä katso säteeseen. (f)

Front view

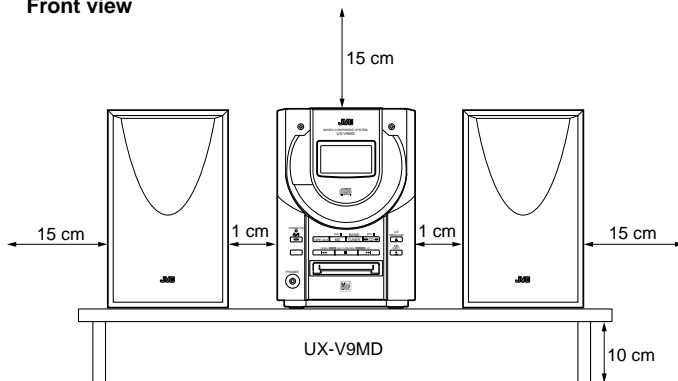

Side view

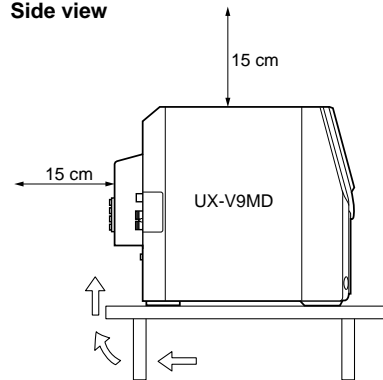

Thank you for purchasing the JVC Micro Component System.
 We hope it will be a valued addition to your home, giving you years of enjoyment.
 Be sure to read this instruction manual carefully before operating your new stereo system.
 In it you will find all the information you need to set up and use the system.
 If you have a query that is not answered by the manual, please contact your dealer.

Features

Here are some of the things that make your System both powerful and simple to use.

- The controls and operations have been redesigned to make them very easy to use, freeing you to just enjoy the music.
 - With JVC's **COMPU PLAY** you can turn on the System and automatically start the Radio, CD Player, or MD Player with a single touch.
- The System incorporates Active Hyper Bass PRO circuitry to faithfully reproduce low frequency sounds.
- A 45-station preset capability (30 FM and 15 AM (MW/LW)) in addition to auto-seek and manual tuning.
- Versatile CD options include repeat, random and program play.
- Versatile MD Player provides playback function, recording function, editing function of the tracks in the MD, title function to give title to the MD and tracks.
- Sampling rate converter which supports 3 digital sources Incorporated.
 - 32 kHz, 44.1 kHz and 48 kHz.
- Timer functions; Daily Timer and Sleep Timer.
- You can connect various external units, such as a CD player, tape deck, etc. as a music source.



How This Manual Is Organized

- Basic information that is the same for many different functions - e.g. setting the volume - is given in the section 'Common Operations', and not repeated under each function.
- The names of buttons/controls and display messages are written in all capital letters: e.g. TUNER BAND, "NO DISC".
- System functions are written with an initial capital letter only: e.g. Normal Play.

Use the table of contents to look up specific information you require.

We have enjoyed making this manual for you, and hope it serves you in enjoying the many features built into your System.

IMPORTANT CAUTIONS

1. Installation of the System

- Select a place which is level, dry and neither too hot nor too cold. (Between 5°C and 35°C or 41°F and 95°F.)
- Leave sufficient distance between the System and a TV.
- Do not use the System in a place subject to vibrations.

2. Power cord

- Do not handle the power cord with wet hands!
- Some power is always consumed as long as the power cord is connected to the wall outlet.
- When unplugging the System from the wall outlet, always pull the plug, not the power cord.

3. Malfunctions, etc.

- There are no user serviceable parts inside. In case of system failure, unplug the power cord and consult your dealer.
- Do not insert any metallic object into the System.

Table of Contents

Features	1	Information on MDs (Minidiscs).....	24
How This Manual Is Organized	1	MD (Minidisc) Messages.....	25
IMPORTANT CAUTIONS	1	Minidisc Limitations.....	25
Getting Started	2	Rules of Digital Dubbing.....	26
Common Operations	6	Care And Maintenance	26
Using the Tuner	8	Troubleshooting	27
Using the CD Player	10	Specifications	28
Using the MD Player (Listening to an MD).....	12		
Recording onto an MD.....	14		
Using the MD Player (Editing)	16		
Using External Equipment	21		
Using the Timers	22		

Getting Started

Accessories

Make sure that you have all of the following items, which are supplied with the System.

- Power Cord (1)
- AM Loop Antenna (1)
- Remote Control (1)
- Batteries (2)
- FM Wire Antenna (1)

If any of these items are missing, contact your dealer immediately.

How To Put Batteries In the Remote Control

Match the polarity (+ and -) on the batteries with the + and - markings in the battery compartment.

R6P(SUM-3)/AA(15F)

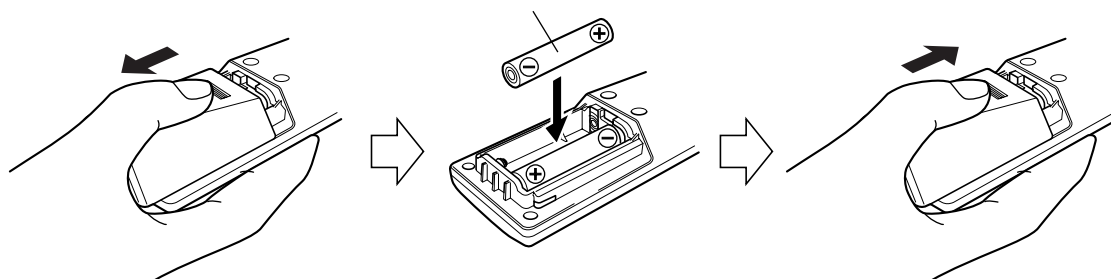

CAUTION: Handle batteries properly.

To avoid battery leakage or explosion:

- Remove batteries when the Remote Control will not be used for a long time.
- When you need to replace the batteries, replace both batteries at the same time with new ones.
- Do not use an old battery with a new one.
- Do not use different types of batteries together.

Using the Remote Control

The Remote Control makes it easy to use many of the functions of the System from a distance of up to 7m (23 feet) away. You need to point the Remote Control at the remote sensor on the System's front panel.

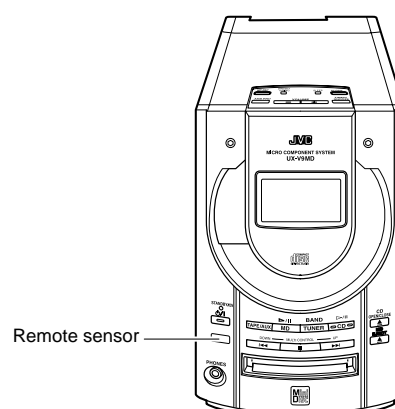

CAUTION: Make all connections before plugging the System into an AC power outlet.

Connecting the FM Antenna

Rear Panel of the Unit

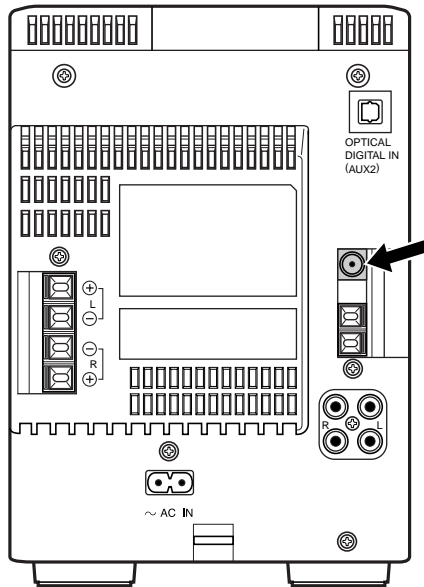

Using the Supplied Wire Antenna

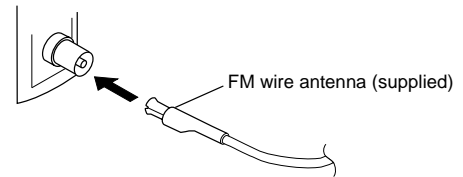

Using the Coaxial Type Connector (Not Supplied)

A 75-ohm antenna with coaxial type connector (IEC or DIN45 325) should be connected to the FM 75-ohm COAXIAL terminal.

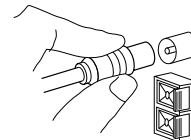

If reception is poor, connect the outdoor antenna.

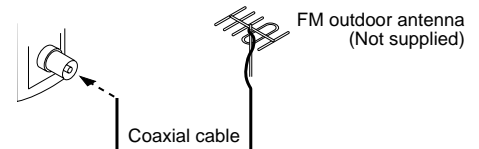

Note: Before attaching a 75 ohm coaxial lead (the kind with a round wire going to an outdoor antenna), disconnect the supplied FM Wire Antenna.

Connecting the AM (MW/LW) Antenna

Rear Panel of the Unit

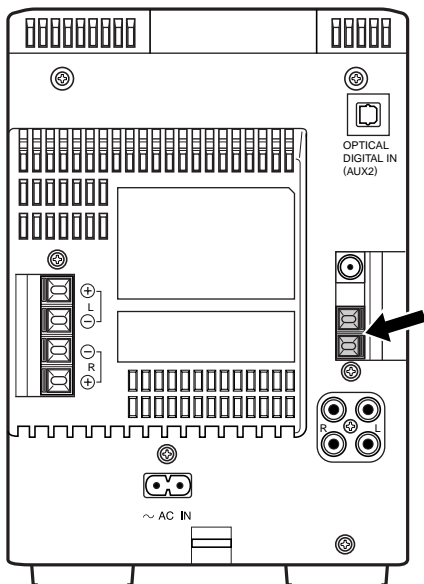

AM loop antenna (Supplied)

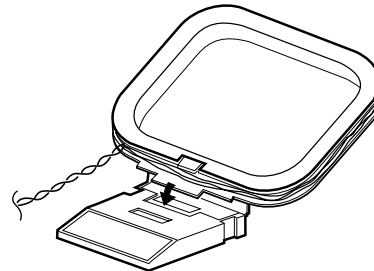

Attach the AM loop to its base by snapping the tabs on the loop into the slot in the base.

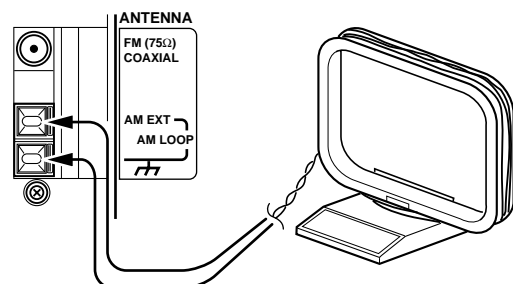

Turn the loop until you have the best reception.

CAUTION: To avoid noise, keep antennas away from the System, the connecting cord and the AC power cord.

CAUTION: Make all connections before plugging the System into an AC power outlet.

Connecting the Speakers

For each speaker, connect one end of the speaker wire to the speaker terminals on the back of the System.

1. Open each of the terminals and insert the speaker wires firmly, then close the terminals.
2. Connect the red (+) and black (-) wires of the right side speaker to the red (+) and black (-) terminals marked R on the System.
Connect the red (+) and black (-) wires of the left side speaker to the red (+) and black (-) terminals marked L on the System.

Note: Since both speakers are the same, you can put either one to the right or left side.

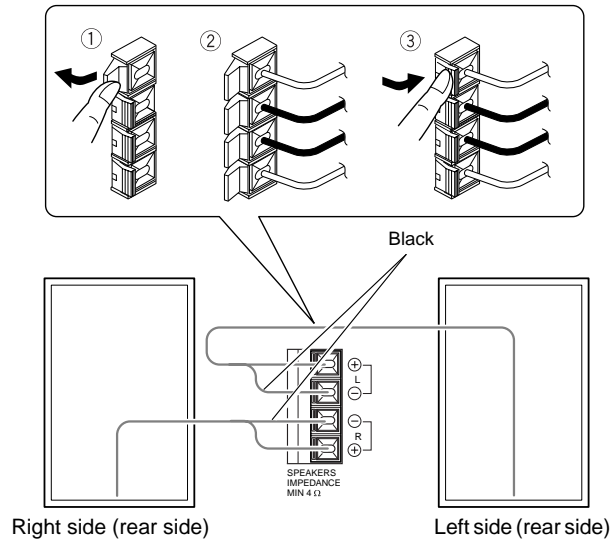

CAUTION: A TV may display irregular colors if located near the speakers. If this happens, set the speakers away from the TV.

Removing the speaker grilles

The speaker grilles can be removed.

When removing,

1. Insert your fingers at the top and pull towards you.
2. Also pull the bottom towards you.

Attaching the speaker grille

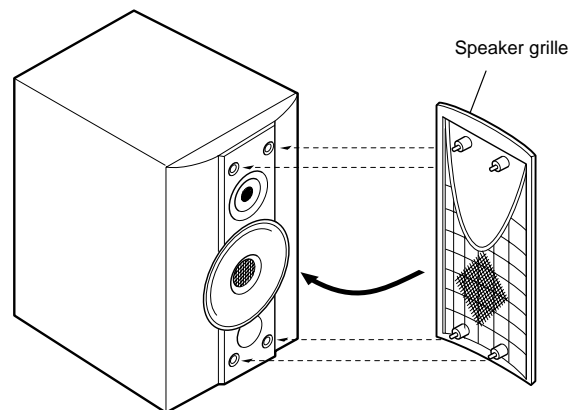

Connecting External Equipment

Connect a signal cord (not supplied) between the System's LINE IN (AUX1)/LINE OUT terminals and the output/input terminals of the external MD recorder, tape deck, etc.

You can then listen to the external source through the System, or record the System's CD player, MD player, or tuner to the external unit.

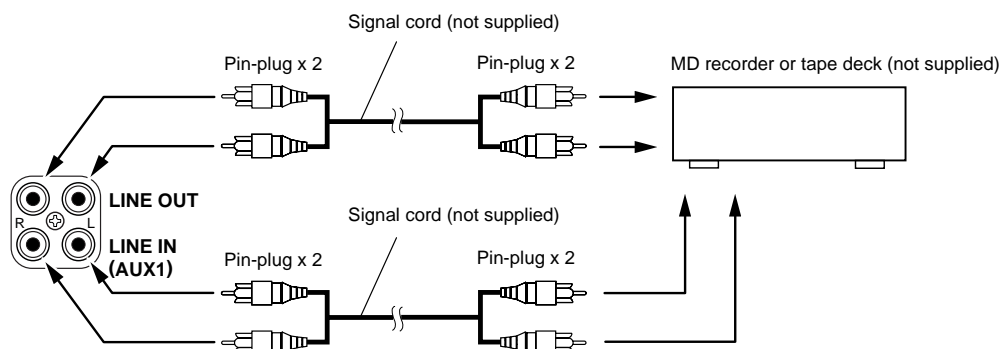

Connecting a CD Player, etc (Digital Input (AUX2))

Unplug the cap and connect an (not supplied) optical digital cord between the System's OPTICAL DIGITAL IN (AUX2) terminal and the output terminal of the CD player, etc.

You can listen to the digital input signal from the CD player, etc.

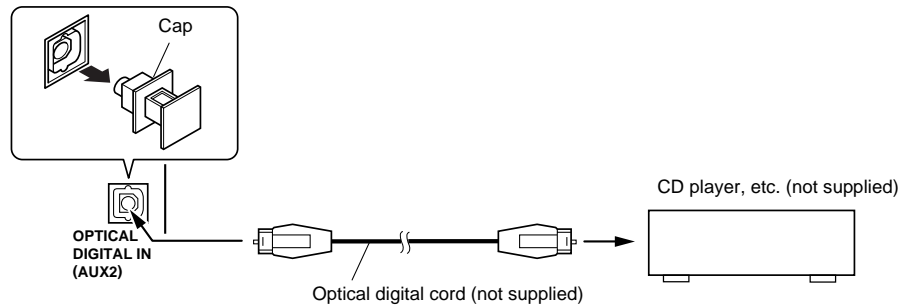

Connecting the AC Power Cord

Firmly insert the supplied AC power cord into the AC inlet on the back of the Unit.

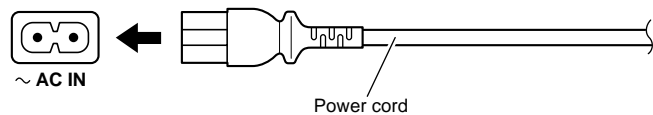

CAUTIONS:

- **ONLY USE THE JVC POWER CORD PROVIDED WITH THIS SYSTEM TO AVOID MALFUNCTION OR DAMAGE TO THE SYSTEM.**
- **BE SURE TO UNPLUG THE POWER CORD FROM THE OUTLET WHEN GOING OUT OR WHEN THE SYSTEM IS NOT IN USE FOR AN EXTENDED PERIOD OF TIME.**

Now you can plug the AC power cord into the wall outlet, and your System is at your command!

COMPU PLAY

JVC's COMPU PLAY feature lets you control the most frequently used System functions with a single touch.

With One Touch Operation you can play a CD, an MD, or turn on the radio with a single press of the play button for that function. One Touch Operation turns the power on for you, then starts the function you have specified. If the System is not ready (no CD in place, for example), the System still powers on so you can insert a CD.

How One Touch Operation works in each case is explained in the section dealing with that function.

The COMPU PLAY buttons are:

On the Unit

- CD ▷/|| button
- TUNER BAND button
- MD ▷/|| button
- TAPE/AUX button

On the Remote Control

- CD ▷/|| button
- TUNER BAND button
- MD ▷/|| button
- TAPE/AUX button

AUTOMATIC POWER ON

The System automatically turns on with the following operation.

- When you press the CD ▲ button, the System automatically turns on and the CD cover opens to allow CD insertion. However, this operation does not change the function to CD.
When you press the ⏻ button to turn off the System, the CD cover will automatically close if it is open.
- When you insert an MD, the System automatically turns on. However, this operation does not change the function to MD.

Common Operations

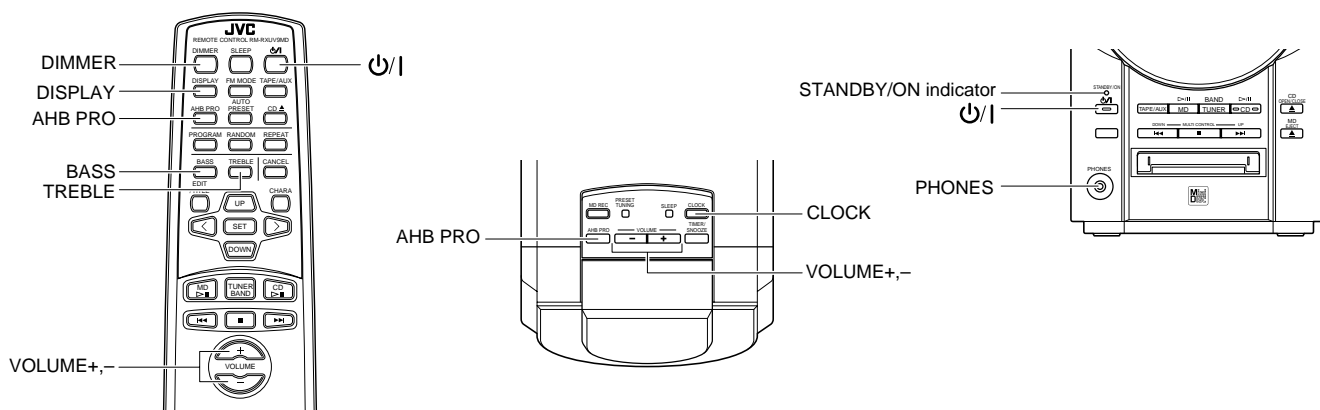

Turning the Power On and Off

Turning the System On

Press the P/I button.

The display comes on and "HELLO" is displayed once. The STANDBY/ON indicator lights in green.

The System comes on ready to continue in the mode it was in when the power was last turned off.

- For example, if the last thing you were doing was listening to a CD, you are now ready to listen to a CD again. If you wish, you can change to another source.
- If you were listening to the Tuner last, the Tuner comes on playing the station it was last set to.

Turning the System Off

Press the P/I button again.

"GOOD BYE" is displayed and the display goes out, except for the clock display. The STANDBY/ON indicator lights in red.

- Some power is always consumed even though power is turned off (called Standby Mode).
- To switch off the System completely, unplug the AC power cord from the wall outlet. When you unplug the AC power cord, the clock will be reset to 0:00 after about 20 minutes.

Adjusting the Brightness (DIMMER)

You can adjust the brightness of the backlighting for the display.

When the System is Turned On

To make the brightness of the backlighting darker, press the DIMMER button on the Remote Control.

To make the brightness brighter, press the DIMMER button on the Remote Control again.

When the System is Turned Off (STANDBY MODE)

To turn on the backlighting, press the DIMMER button on the Remote Control. The brightness is the same as for darker one mentioned above.

To turn off the backlighting, press the DIMMER button on the Remote Control again.

Adjusting the Volume

Press the VOLUME + button to increase the volume or press the VOLUME - button to decrease it.



You can adjust the volume level between 0 and 50.

CAUTION: DO NOT turn on the System and/or start playing any source without first setting the VOLUME control to minimum, as a sudden blast of sound could damage your hearing, speakers and/or headphones.

For private listening

Connect a pair of headphones to the PHONES jack. No sound comes out of the speakers.

Be sure to turn down the volume before connecting or putting on headphones.

Reinforcing the Bass Sound (AHB PRO)

You can reinforce the bass sound to maintain rich, full bass at low volume (you can use this effect only for playback):

To get the effect, press the AHB (Active Hyper Bass) PRO button.

The "BASS" indicator lights up on the display.

To cancel the effect, press the button again.

The "BASS" indicator goes out.

Tone Control (BASS/TREBLE)

You can control the tone by changing the bass and treble.

The analog clock acts to display the bass and treble settings.

By pressing either the BASS or TREBLE button on the **Remote Control**, you can visually see the current tone control settings.

Examples:

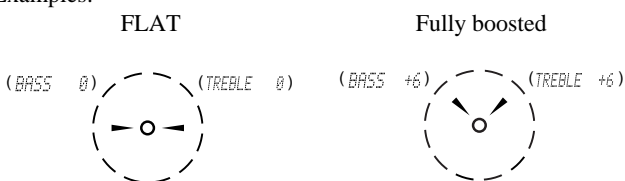

BASS Control

You can adjust the bass level (low frequency range level) between -6 and +6. (0: Flat)

1. Press the BASS button on the Remote Control.

2. Press the UP or DOWN button on the Remote Control to adjust the bass level.

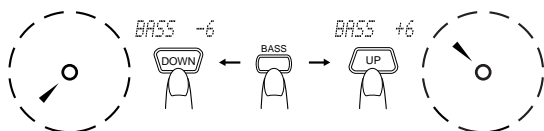

TREBLE Control

You can adjust the treble level (high frequency range level) between -6 and +6. (0: Flat)

1. Press the TREBLE button on the Remote Control.

2. Press the UP or DOWN button on the Remote Control to adjust the treble level.

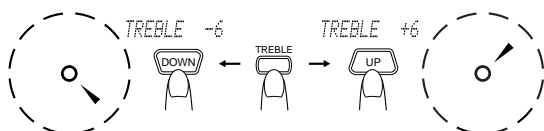

Showing the Time (DISPLAY)

In Standby mode, the digital clock and analog clock appear on the display at the same time. Only the analog clock is displayed when a music source is selected. You can see the analog clock at all times.

When the System is turned on, you can display the digital clock at any time.

Using the CLOCK button on the Unit:

Each time you press the button, the display changes between the normal display and the digital clock.

Using the DISPLAY button on the Remote Control:

By pressing the button repeatedly, the clock will be displayed.

Example:

Normal display → Remaining time (recordable capacity) of MD →

Clock → (back to the beginning)

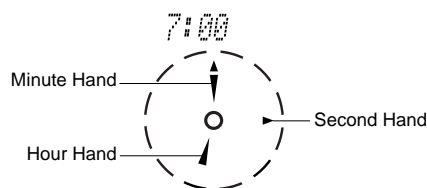

Note: To let the clock work, you need to set the clock beforehand. (See "Setting the Clock" on page 22.)

Using the Tuner

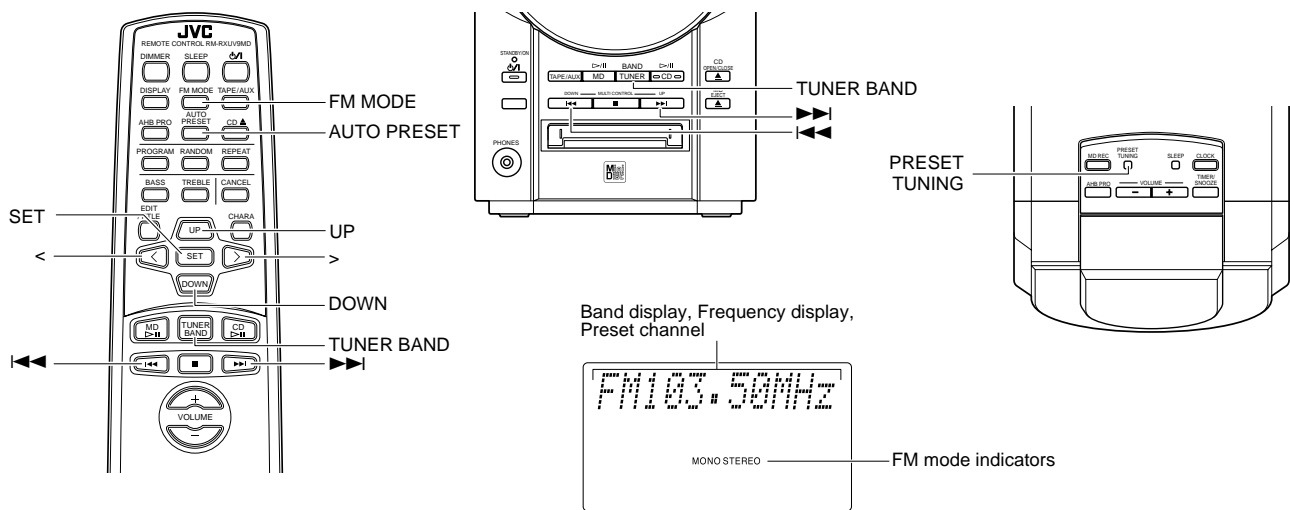

When the System is in use, the display shows other items as well. For simplicity, we show here only the items described in this section.

You can listen to FM and AM (MW/LW) stations. Stations can be tuned in manually, automatically, or from preset memory storage.

■ Before listening to the radio:

- Make sure that both the FM and AM (MW/LW) antennas are correctly connected. (See page 3).

One Touch Radio

Just press the TUNER BAND button to turn on the System and start playing the station you were last tuned to.

- You can switch from any other sound source to the radio by pressing the TUNER BAND button.

Tuning In a Station

1. Press the TUNER BAND button.

The Band and Frequency you were last tuned to appear on the display. (If the last station was selected using the preset number, the preset number appears first.) Each time you press the button, the band alternates between FM and AM (MW/LW).

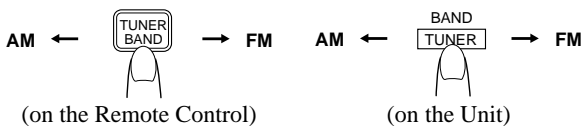

2. Select a station using one of the following methods.

■ Manual Tuning

Press the ◀◀ or ▶▶ button on the Unit or the Remote Control repeatedly to move from frequency to frequency until you find the station you want.

OR

■ Auto Tuning

If you press and hold the ◀◀ or ▶▶ button on the Unit or the Remote Control for one second or more, the frequency changes down, or up, automatically until a station is found.

OR

■ Preset Tuning using the Remote Control (Possible only after presetting stations)

Select the desired preset number using the UP, DOWN, > and < button on the Remote Control. After 1 second the display will show the preset number's band and frequency.

Example: Press the UP button until the preset number 12 "P12" appears.

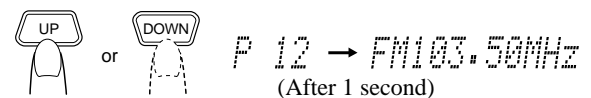

■ Preset Tuning using the Unit (Possible only after pre-setting stations)

Press the PRESET TUNING button to select the desired preset number. Its band and frequency are displayed.

Presetting Stations

You can preset up to 30 FM stations and up to 15 AM (MW/LW) stations using the Remote Control.

Note: Preset numbers may have been set to factory test frequencies prior to shipment. This is not a malfunction. You can preset the stations you want into memory by following one of the presetting methods below.

Manual Presetting

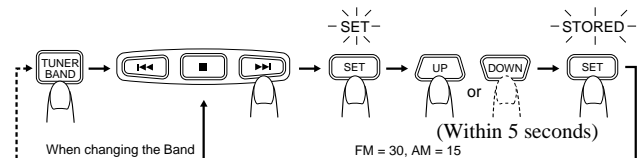

1. Select a band by pressing the TUNER BAND button.

2. Press the ◀◀ or ▶▶ button to tune in a station.

3. Press the SET button.

"SET" will blink for 5 seconds. Within 5 seconds, proceed to the next step. When the display returns to the one set in STEP 2 after 5 seconds, press the SET button again.

4. Press the UP, DOWN, >, or < button within 5 seconds to select the preset number.

- UP or > button: Increases the preset number by 1.
DOWN or < button: Decreases the preset number by 1.
- When the > or < button is kept pressing, the preset number changes rapidly.

5. Press the SET button within 5 seconds.

“STORED” appears and after 2 seconds, the display returns to the broadcast frequency display.

6. Repeat above steps 1 to 5 for each station you want to store in memory with a preset number.

To change the preset stations, repeat the same steps as above.

Auto Presetting

(Using the Remote Control)

In each band, you can automatically preset FM-30, AM (MW/LW)-15 stations. Preset numbers will be allocated as stations are found, starting from the lowest frequency and moving up the frequency.

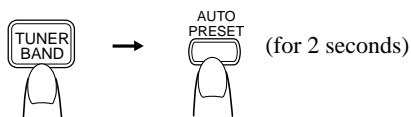

1. Select a band by pressing the TUNER BAND button.

2. Press the AUTO PRESET button on the Remote Control for more than two seconds.

3. Repeat steps 1-2 for the other band.

- If you want to change the preset stations, carry out the Manual Presetting for the desired preset numbers.

CAUTION: Even if the system is unplugged or if the power failure occurs, the preset stations will be stored for about 24 hours. However, in case the preset stations are erased, you will need to preset the stations again.

To Change the FM Reception Mode

When you are tuned into an FM stereo broadcast, the “STEREO” indicator lights up and you can hear stereo effects.

If an FM stereo broadcast is hard to receive or noisy, you can select Monaural mode. Reception improves, but you lose stereo effect.

Press the FM MODE button on the Remote Control so that the “MONO” indicator lights up on the display.

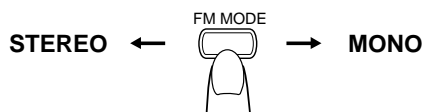

To restore the stereo effect, press the FM MODE button on the Remote Control so that the “MONO” indicator goes off.

Using the CD Player

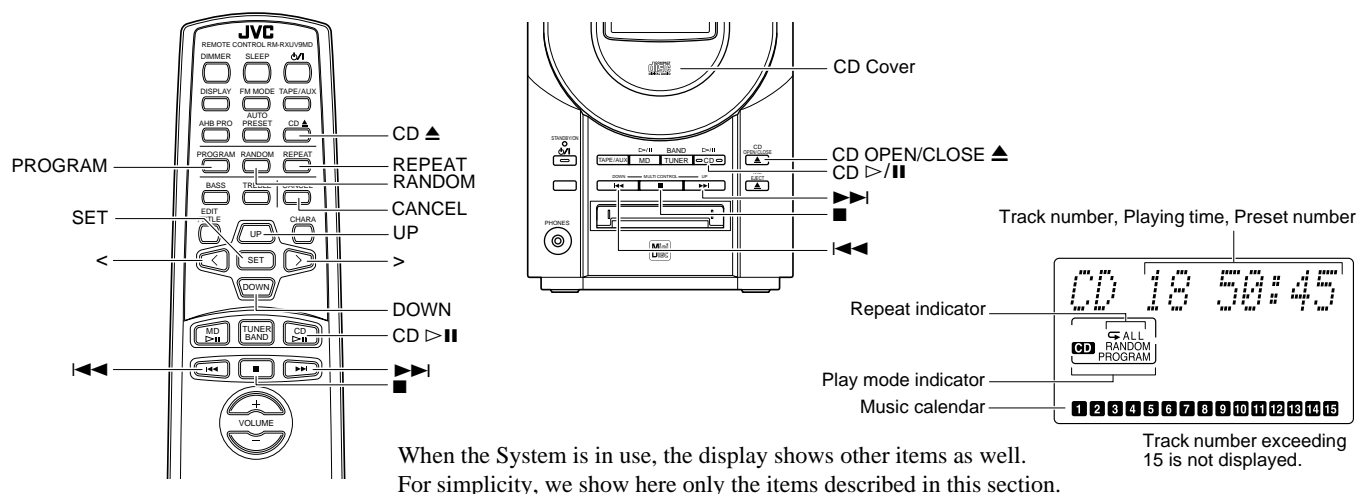

You can use Normal, Random, Program or Repeat Play. Repeat Play can repeat all the tracks or just one of the tracks on the CD. Here are the basic things you need to know to play a CD and locate the different tracks on it.

The Quickest Way To Start a CD Is With the One Touch Operation

- Press the CD ▷/|| button on the Unit or the Remote Control.
 - The power is automatically turned on. If a CD is already inserted, it will start playing from the first track.
 - If no CD is inserted, "CD NO DISC" appears on the display and the CD Player remains in Stop mode.

To Insert a CD

1. Press the CD OPEN/CLOSE ▲ button on the Unit (or the CD ▲ button on the Remote Control.)

The CD cover opens.

2. Place a CD, with its label side out as shown below. Press down on the CD's center until you hear a click.

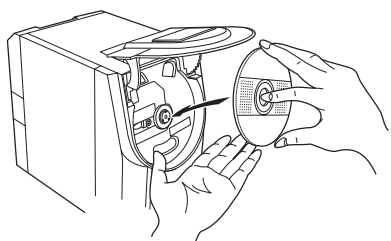

3. Press the CD OPEN/CLOSE ▲ button (or CD ▲ button) again to close the CD cover.

- To close the CD cover and play the CD, you can just press the CD ▷/|| button.
- You can place an 8 cm (3") CD without an adaptor.
- If the CD cannot be read correctly (because it is scratched, for example), "CD 0 0:00" appears on the display.
- You can insert a CD while listening to the other source.

CAUTIONS:

- **DO NOT try to open or close the CD cover by hand as it will be damaged.**

- **When you place or take out a CD, do not let it fall. Also, be careful not to scratch your fingers with the CD cover.**

To Unload a CD

Take out the CD as shown below.

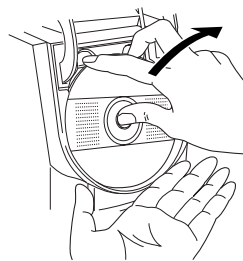

- To unload an 8 cm (3") CD, use the concavity to make removal easier.

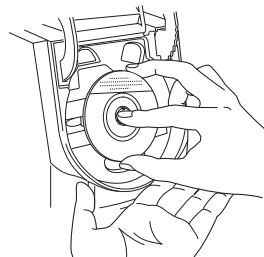

Basics of Using the CD Player-Normal Play

To Play a CD

1. Insert a CD.
2. Press the CD ▷/|| button.

The first track of the CD begins playing.



- The track number that has already played disappears from the music calendar.
- The CD Player automatically stops when the last track of the CD has finished playing.

To stop playing the CD, press the ■ button. The following information for the CD is displayed.



To stop playing and remove the CD, press the CD OPEN/CLOSE ▲ button on the Unit or CD ▲ button on the Remote Control to open the CD cover.

To pause, press the CD ▷|| button. The playback time blinks on the display.

To cancel pause, press the same button again. Play continues from the point where it was paused.

To Select a Track or Passage within a Track

During playback, press the ◀ or ▶ (< or >) button to select the track you want.

The selected track starts playing.

- Press the ▶ or > button once to skip to the beginning of the next track.
- Press the ◀ or < button to skip to the beginning of the track being played. Press twice quickly to skip to the beginning of the previous track.
- When the > or < button on the Remote Control is kept pressing, the track continuously skips.

Search Play

Holding down the ◀ or ▶ button, during playback, will fast forward/backward the CD so you can quickly find a particular passage in the track you are listening to.

Programming the Playing Order of the Tracks

You can program the playing order of the tracks using the Remote Control.

- You can program up to 20 tracks in any desired order including the same tracks.
- You can only make a program when the CD Player is stopped.

1. Insert a CD.
2. Press the CD ▷|| button.
3. Press the ■ button to stop the CD.
4. Press the PROGRAM button.

The System enters the programming mode and the “CD PROGRAM” indicator lights up.



5. Press the UP, DOWN, >, or < button to select the track to program.

UP or > button: Increases the track number by 1.

DOWN or < button: Decreases the track number by 1.

- When the > or < button is kept pressing, the track number changes rapidly.

6. Press the SET button.

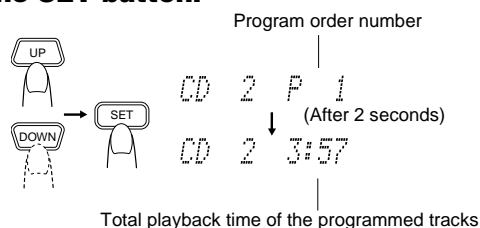

7. Repeat steps 5 and 6 to select the other tracks for the program.

You can see the total playback time of programmed tracks on the display. Also, you can see the programmed tracks on the music calendar.

8. Press the CD ▷|| button.

The System plays the tracks in the order you have programmed them.

- You can skip to a particular program track by pressing the ◀ or ▶ button during Program Play.
- To stop playing, press the ■ button once.

To confirm the programmed tracks while the CD player is stopped, each time press the ◀ or ▶ button; the tracks making up the program will successively be displayed in the programmed order.

To delete all the tracks in the program, in stop mode, press the ■ button. Pressing the CD ▲ button to open the CD cover will also clear the programmed tracks.

To exit the program mode, while the CD Player is stopped, press the PROGRAM button to turn off the “CD PROGRAM” indicator.

- Even if the power is turned off, the programmed contents remain in effect, through the Program mode is cleared.

Notes:

- If the total playback time of the programmed tracks exceeds 99 minutes 59 seconds, the total playback time will go out on the display.
- If you try to program the 21st track, “MEMORY FULL” appears on the display for about 2 seconds.

To Modify the Program

Modify the contents of the program while the CD Player is stopped. Each time you press the CANCEL button, the last track in the program is deleted. To add new tracks to the end of the program, repeat above steps 5 to 7.

Random Play

The tracks will play in no special order when you use this mode.

1. Press the RANDOM button on the Remote Control.

The “CD RANDOM” indicator lights up on the display.

2. Press the CD ▷|| button.

The tracks are played in random order.

To skip a track during playback, press the ▶ button to jump to the next track in the random sequence. Press the ◀ button to jump back to the start of a track being played.

To exit Random Play mode, while the CD Player is stopped, press the RANDOM button to light off the “CD RANDOM” indicator and carry out Normal Play, or press the CD ▲ button to open the CD cover. You can also exit Random Play mode by turning off the power.

Repeating Tracks

You can set the program or individual track to repeat as many times as you like.

Press the REPEAT button on the Remote Control.

The Repeat indicator changes with each press of the button, as shown below.

☐ → ☐ ALL → blank display → (back to the beginning)

☐ : Repeats one track.

☐ ALL : In Normal Play mode, repeats all the tracks.

In Program Play mode, repeats all the tracks in the program.

In Random Play mode, repeats all the tracks in random order.

To exit Repeat mode, press the REPEAT button until the Repeat indicator on the display goes out.

- In Random Play, ☐ cannot be selected.
- Repeat mode remains in effect even when you change the play mode.

Using the MD Player (Listening to an MD)

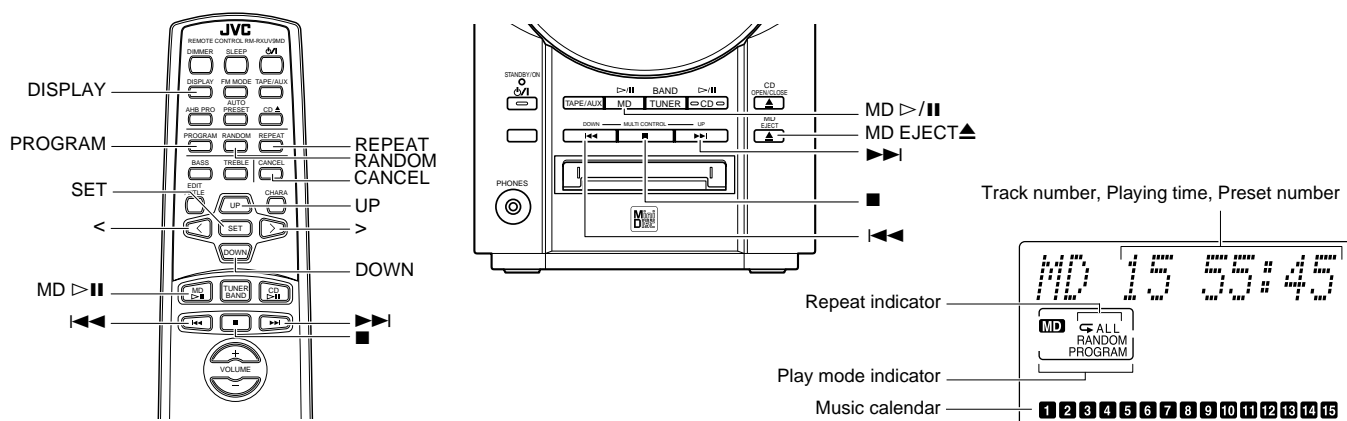

When the System is in use, the display shows other items as well. For simplicity, we show here only the items described in this section.

You can use Normal, Random, Program or Repeat Play in the same way as for CD Player. Repeat Play can repeat all the tracks or just one of the tracks on the MD.

Here are the basic things you need to know to play an MD and locate the different tracks on it.

The Quickest Way To Start an MD Is With the One Touch Operation

■ Press the MD >/|| button.

- The power is automatically turned on. If an MD is already inserted, it will start playing from the first track.
- If no MD is inserted, "MD NO DISC" appears on the display and the MD Player remains in Stop mode.

- The tracks in the MD appear on the music calendar.
 - The track number that has been played disappears from the music calendar.
 - The MD Player automatically stops when the last track of the MD has finished playing.
 - If the MD has the disc title, the disc title is displayed before playing the first track.
 - If the track has the title, the track title will be displayed before playing the track.
- You can give the disc title and the track title as required. (See page 19.)

To stop playing the MD, press the ■ button. The following information for the MD is displayed.

MD 15 55:45

Total track number Total playback time

To stop playing and remove the MD, press the MD EJECT button to eject the MD.

To pause, press the MD >/|| button. The playback time blinks on the display.

To cancel pause, press the same button again. Play continues from the point where it was paused.

To Insert an MD

■ Insert an MD into the MD slot.

Insert it with its label side up and the > or ⇌ mark of the MD directs as shown in the figure.

The MD is automatically drawn inside the MD Player.

Note: If an MD is already inserted, do not force to insert another MD as trouble may arise.

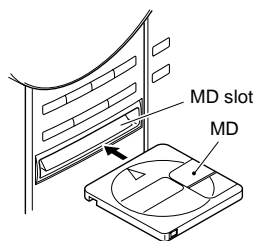

■ You can insert an MD while listening to the other source.

Basics of Using the MD Player - Normal Play

To Play an MD

1. Insert an MD.

2. Press the MD >/|| button.

The first track of the MD begins playing.

MD 1 0:05

Track number Playback time

In Stop mode:

Normal display → Disc title (NO TITLE if not given) → Remaining time (recordable capacity) of MD (e.g. REM. 18:00)* → Clock → (back to the beginning)

In Play mode (MD selected):

Normal display → Track title (NO TITLE if not given) → Remaining time (recordable capacity) of MD (e.g. REM. 18:00)* → Clock → (back to the beginning)

In Play mode (other than MD selected):

Normal display → Remaining time (recordable capacity) of MD (e.g. REM. 18:00)* → Clock → (back to the beginning)

* : For playback-only MD, "0:00" is displayed.

To Select a Track or Passage within a Track

During playback, press the **◀◀** or **▶▶** (< or >) button to select the track you want.

The selected track starts playing.

- Press the **▶▶** button once to skip to the beginning of the next track.
- Press the **◀◀** button to skip to the beginning of the track being played. Press twice quickly to skip to the beginning of the previous track.
- When the > or < button on the Remote Control is kept pressing, the track continuously skips.

Search Play

Holding down the **◀◀** or **▶▶** button, during playback, will fast forward/backward the MD so you can quickly find a particular passage in the track you are listening to.

Programming the Playing Order of the Tracks

You can program the playing order of the tracks **using the Remote Control**.

- You can program up to 32 tracks in any desired order including the same tracks.
- You can only make a program when the MD Player is stopped.

- 1. Insert an MD.**
- 2. Press the MD ▷|| button.**
- 3. Press the ■ button to stop the MD.**
- 4. Press the PROGRAM button.**

The System enters the programming mode and the “MD PROGRAM” indicator lights up.



- 5. Press the UP, DOWN, >, or < button to select the track to program.**

UP button: Increases the track number by 1.
DOWN button: Decreases the track number by 1.

- When the > or < button on the Remote Control is kept pressing, the track continuously skips.

- 6. Press the SET button.**

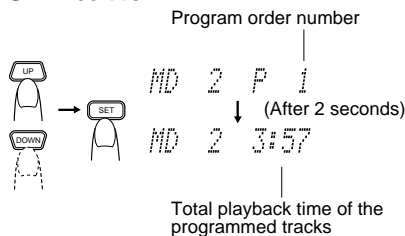

- 7. Repeat steps 5 and 6 to select the other tracks for the program.**

You can see the total playback time of programmed tracks on the display. Also, you can see the programmed tracks on the music calendar.

- 8. Press the MD ▷|| button.**

The System plays the tracks in the order you have programmed them.

- You can skip to a particular program track by pressing the **◀◀** or **▶▶** button during Program Play.
- To stop playing, press the **■** button.

To confirm the programmed tracks while the MD Player is stopped, each time press the **◀◀** or **▶▶** button; the tracks making up the program will successively be displayed in the programmed order.

To delete all the tracks in the program, in stop mode, press the **■** button. Pressing the MD **▲** button to eject the MD will also clear the programmed tracks.

To exit the program mode, while the MD Player is stopped, press the PROGRAM button to turn off the “MD PROGRAM” indicator.

- Even if the power is turned off, the programmed contents remain in effect, through the Program mode is cleared.

Notes:

- You cannot program the track number that is not contained in the MD.
- If the total playback time of the programmed tracks exceeds 150 minutes, the total playback time will go out on the display.
- If you try to program the 33rd track, “MEMORY FULL” appears on the display for about 2 seconds.

To Modify the Program

Modify the contents of the program while the MD Player is stopped. Each time you press the CANCEL button, the last track in the program is deleted. To add new tracks to the end of the program, repeat above steps 5 to 7.

Random Play

The tracks will play in no special order when you use this mode.

- 1. Press the RANDOM button on the Remote Control.**

The “MD RANDOM” indicator lights up on the display.

- 2. Press the MD ▷|| button.**

The tracks are played in random order.

To skip a track during playback, press the **▶▶** button to jump to the next track in the random sequence. Press the **◀◀** button to jump back to the start of a track being played.

To exit Random Play mode, while the MD Player is stopped, press the RANDOM button to light off the “MD RANDOM” indicator and carry out Normal Play or press the MD **▲** button to eject the MD. You can also exit Random Play mode by turning off the power.

Repeating Tracks

You can set the program or individual track to repeat as many times as you like.

Press the REPEAT button on the Remote Control.

The Repeat indicator changes with each press of the button, as shown below.

- ☐ → ☐ **ALL** → blank display → (back to the beginning)
- ☐ : Repeats one track.
- ☐ **ALL** : In Normal Play mode, repeats all the tracks.
In Program Play mode, repeats all the tracks in the program.
In Random Play mode, repeats all the tracks in random order.

To exit Repeat mode, press the REPEAT button until the Repeat indicator on the display goes out.

- In Random Play, ☐ cannot be selected.
- Repeat mode remains in effect even when you change the play mode.

Recording onto an MD

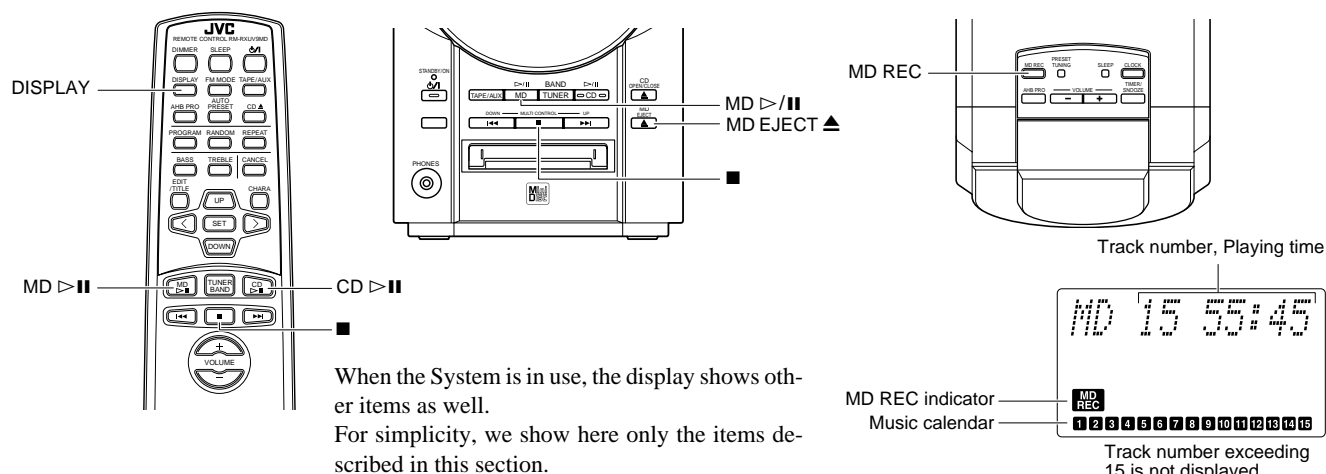

When the System is in use, the display shows other items as well.

For simplicity, we show here only the items described in this section.

Recording onto an MD from any of the sound sources is simple. Just insert an MD to the Unit, have the source ready, make one or two settings, and you are ready to record. For each source, the procedure is a little bit different so we explain each separately. But first, here are a few things to make your recordings better.

Things To Know Before You Start

Recording

- It may be unlawful to record or play back copyrighted material without the consent of the copyright owner.
- Carefully read the "Rules of Digital Dubbing" on page 26.
- The MD Recorder supports the following sampling frequencies for digital sources.
For the OPTICAL DIGITAL IN (AUX2): 32 kHz, 44.1 kHz and 48 kHz.
For the CD Player of the Unit: 44.1 kHz.
- The recording level, which is the volume at which the new MD is being made, is automatically set correctly, so it is not affected by the VOLUME level of the System. Nor it is affected by adjusting the sound effects. Thus, during recording you can adjust the sound you are actually listening to without affecting the recording level.
- Note that it takes 10 seconds until the MD REC button becomes effective after the MD has been inserted.
- The accidental erasure prevention knob is provided on the back of an MD cartridge to prevent accidental erasure or recording. It must be set to the close position beforehand.

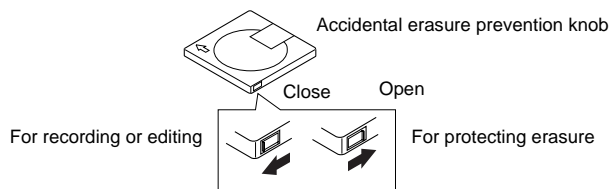

- When you stick an adhesive label onto the MD cartridge, adhere it securely. If it peels off, ejection trouble, etc. will occur.
- To start recording immediately after inserting an MD, it is required to allow several seconds.
- Only stereo recording is possible. (Monaural recording that enables long recording is impossible.)

Preparation Before Recording

- Be sure that the MD is not the Play-only type one.
- Be sure that the accidental erasure prevention knob of the MD cartridge is set to the close position. Otherwise, "DISC PROTECTED" will appear when you try to record a signal to the MD.
- Be sure that the MD has enough space for recording. If not, carry out ALL ERASE or ERASE function to erase all the tracks or desired tracks in the MD. (See page 19.) You can check the recordable remaining time of the MD in Stop mode or during recording by pressing the DISPLAY button. (See "Checking the Remaining Time of the MD" mentioned on page 15.)

Standard Recording

You can record any sound source to an MD as follows.

1. **Insert an MD with its label side up.**
2. **Prepare one of the sources.**
CD: Use the "CD Synchro Recording" on page 15.
Tuner: Tune in to a station.
AUX1 (LINE IN (AUX1)): Press the TAPE/AUX button on the Unit or the Remote Control until "AUX 1 ANALOG IN" appears on the display.
AUX2 (OPTICAL DIGITAL IN (AUX2)): Press the TAPE/AUX button on the Unit or the Remote Control until "AUX 2 DIGITAL IN" appears on the display.
3. **Play the record source selected in step 2.**
4. **Press the MD REC button on the Unit.**

The MD REC indicator lights up and the selected source is recorded on the MD.

- The track number is incremented by one and it blinks on the music calendar.

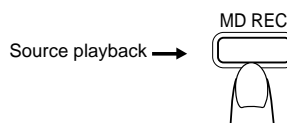

- When AUX1 or AUX2 is selected as a source, **sound synchro recording** takes place. The MD Recorder will automatically start recording when a signal is input and stop when no signal continues for more than 30 seconds.
 - Sound synchro recording may not correctly work if the input noise is large, since it starts after detecting the presence of signal.

- You can also start recording by pressing the MD REC button and then the MD ▷/|| button.

■ When you record a signal from a DAT through the AUX2 terminal, two track numbers (track marks) are added for one track. This is not fault. Join both tracks using the Join function. (See page 18.)

5. Press the ■ button to stop recording.

“UTOCwriting” appears on the display, indicating that the recording is successfully completed. Then, the MD stops.

- If the MD becomes full before pressing the ■ button, the recording will be terminated after indicating “UTOCwriting”.

Checking the Remaining Time of the MD

You can see the recordable remaining time of the MD in Stop or Recording mode.

Press the DISPLAY button on the Remote Control repeatedly.

The remaining time appears on the display as follows.

In Recording mode:

Normal display → Remaining time (recordable capacity) of MD (e.g. FM (current source) > 72:00) → Clock → (back to the beginning)

In Stop mode:

Normal display → Remaining time (recordable capacity) of MD (e.g. REM. 72:00) → Clock → (back to the beginning)

Track marking

- Whenever playback advances from one track to another during digital recording, the track number at the MD side is automatically incremented by 1.
- Whenever no sound at the playback side continues for 3 or more seconds during analog recording, the track number at the MD side is automatically incremented by 1.
- The track number at the MD side is automatically incremented by 1 by pressing the SET button on the Remote Control at the desirable location during analog recording. (Tuner or the equipment connected to the AUX-1)

CD Synchro Recording

Everything on the CD goes onto the MD in the order it is on the CD, or according to the order you have set in the program. (See page 11 for programming the CD tracks.)

1. Insert an MD with its label side up.

2. Insert a CD. (See page 10.)

3. Press the CD ▷/|| button and then press the ■ button to stop the CD.

4. Press the MD REC button on the Unit.

Digital recording from the CD to the MD starts. Then, the tracks on the music calendar change from the CD's ones to MD's one.

- The track number is incremented by one and it blinks on the music calendar.



- The track number for the MD increases synchronous with the track on the CD.

- After the CD Player has played the entire CD or all the programmed tracks, “UTOCwriting” appears on the display, indicating that the recording is successfully completed. Then, the MD and the CD stop.
- When the MD becomes full before the CD Player finishes playback, the MD stops after indicating “UTOCwriting”.

Note: While “UTOCwriting” is displayed, do not disconnect the power cord or subject the Unit to the vibration to avoid incorrect recording.

One Track Recording

1. Insert an MD with its label side up.

2. Play the track on the CD you wish to record.

3. Press the MD REC button on the Unit.

The CD Player returns to the beginning of that track and the track is recorded on the MD. After recording, the CD Player and MD Recorder automatically stops.

Display the Information

During CD synchro recording, you can see various information using the DISPLAY button on the Remote Control.

Press the DISPLAY button on the Remote Control repeatedly.

The display changes as follows.

Remaining of the current track's playback time and remaining time (recordable capacity) of MD → Track numbers of CD and MD → Track number of CD and playing time → Clock → (back to the beginning)

Using the MD Player (Editing)

In addition to its recording and play functions, the MD Player comes with editing functions. You can divide, join, move, or erase the recorded tracks in the MD as required. Also, you can give a disc title to the MD and track titles to the tracks in the MD.

Dividing tracks (DIVIDE function)

This involves adding a track mark at some point during the track which is to be made into the start of an additional track so that the original track is divided into two tracks.

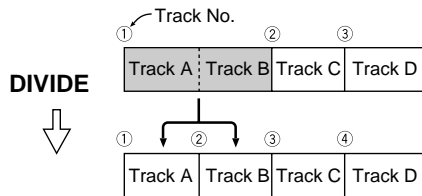

Erasing tracks (ERASE function)

This enables unnecessary tracks. Narration, etc. to be erased speedily. The erased parts do not remain as silences but are closed up by the subsequent tracks.

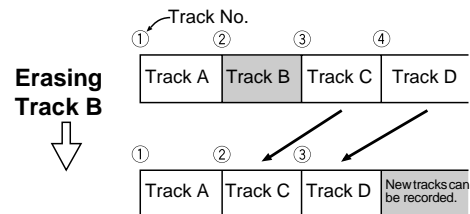

Joining tracks (JOIN function)

This involves erasing a track mark and turning two adjoining tracks into one track.

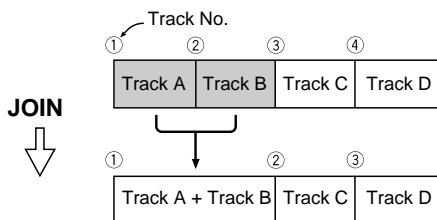

Erasing all the tracks (ALL ERASE function)

All the tracks can be erased at once without recording fresh material over them.

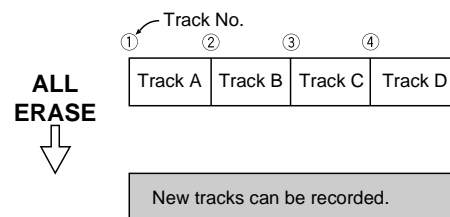

Moving tracks (MOVE function)

Tracks can be moved around so that they are in the desired sequence.

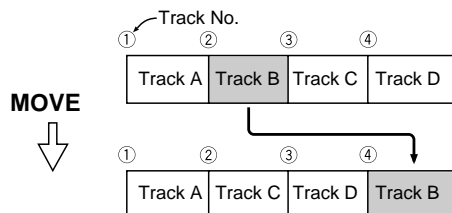

Giving titles to discs and tracks (TITLE function)

A title consisting of up to 64 characters can be given to a disc and a track. The title given appears in the display window.

Note: Track marks

These marks are provided to locate the start of each track. Whatever lies between one track mark and the next is considered to a track and the numbers of the tracks (called "track numbers") are displayed in the sequence in which they are to be played.

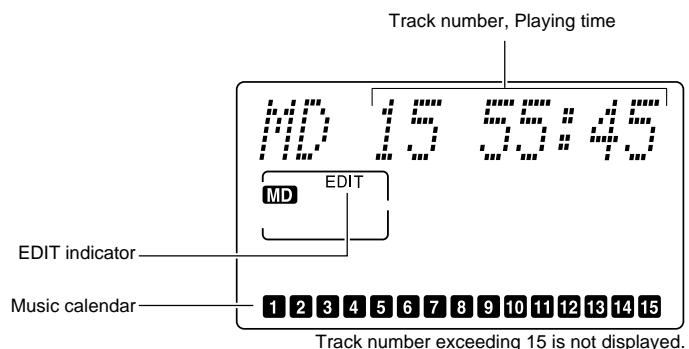
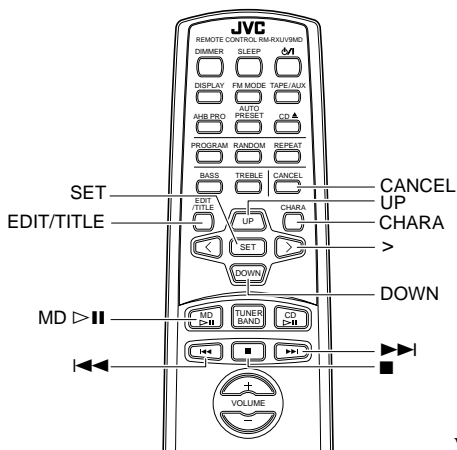

When the System is in use, the display shows other items as well. For simplicity, we show here only the items described in this section.

Dividing Tracks (DIVIDE Function)

■ Use the Remote Control to carry out this function.

1. Insert an MD to be edited with its label side up.

2. Press the MD \triangleright II button and then ■ button to set the function to MD.

The track numbers and total playback time are displayed.

3. Press the EDIT/TITLE button until "DIVIDE ?" is displayed.

The "EDIT" indicator appears on the display.



DIVIDE→JOIN→MOVE→ERASE→ALL ERASE
→DISC TITLE→TITLE→(Back to the beginning)

4. Press the SET button.

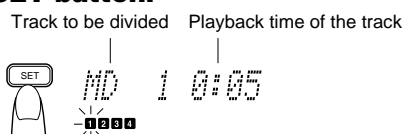

- The first track will be repeatedly played.

5. Select the track number to be divided.

The selected track is automatically played.

To select the track number, press the UP, DOWN, >, or < button.

UP button: Increases the track number by 1.

DOWN button: Decreases the track number by 1.

> button: Rapidly increases the track number.

< button: Rapidly decreases the track number.

Example: For track 3, press the UP button three times. For track 12, use the > button to rapidly increase the track number (or simply press the UP button 12 times.)

6. Press the SET button at the point where the track is to be divided.



- The selected track is divided into two tracks and the track number in the music calendar will increase by 1.
- The recording lasting for 4 seconds starting where the track was divided is repeatedly played for your reference.
- Movement is possible within the POSITION-128 to 128 range (about 8 seconds before or after the position). To move the point, press the UP, DOWN, > or < button. The recording lasting for 4 seconds starting from the position to which the dividing point has been moved is repeatedly played.

7. Press the SET button.

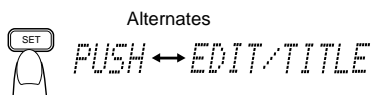

8. Press the EDIT/TITLE button.

The "EDIT" indicator disappears on the display.

9. Press the MD \blacktriangle button to complete editing.

The MD is ejected after "UTOCwriting" is displayed.

- You can also complete editing operation by pressing the \mathcal{O}/I button to turn off the power.

To cancel the operation, press the CANCEL button in step 4 through 7 until the display returns to the original display before editing the track.

Note: While "UTOCwriting" is displayed, do not disconnect the power cord or subject the Unit to the vibration to avoid incorrect recording.

Joining Tracks (JOIN Function)

■ Use the Remote Control to carry out this function.

1. Insert an MD to be edited with its label side up.

2. Press the MD ▷|| button.

- You can also perform this function in Stop mode.

3. Press the EDIT/TITLE button until "JOIN ?" is displayed.

The "EDIT" indicator appears on the display.



DIVIDE→JOIN→MOVE→ERASE→ALL ERASE
→DISC TITLE*→TITLE→(Back to the beginning)
*: Displayed in Stop mode only.

4. Press the SET button.

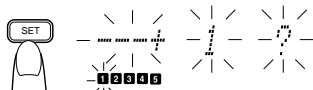

5. Select the track number to be joined.

To select the track number, press the UP, DOWN, >, or < button.
(For details, see step 5 in "Dividing Tracks (DIVIDE Function)".)

Example: Track number 4

Track to be joined Selected track

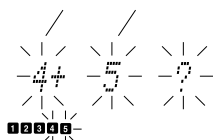

- The selected track is repeatedly played.

6. Press the SET button.

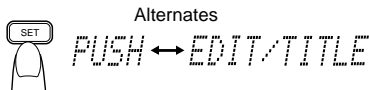

7. Press the EDIT/TITLE button.

The selected track and the previous track are joined and the track numbers in the music calendar will decrease by 1.

- Then the "EDIT" indicator disappears on the display.

8. Press the MD▲ button to complete editing.

The MD is ejected after "UTOCwriting" is displayed.

- You can also complete editing operation by pressing the button to turn off the power.

To cancel the operation, press the CANCEL button in step 4, 5, or 6 until the display returns to the original display before editing the track.

Note: While "UTOCwriting" is displayed, do not disconnect the power cord or subject the Unit to the vibration to avoid incorrect recording.

Moving Tracks (MOVE Function)

■ Use the Remote Control to carry out this function.

1. Insert an MD to be edited with its label side up.

2. Press the MD ▷|| button.

- You can also perform this function in Stop mode.

3. Press the EDIT/TITLE button until "MOVE ?" is displayed.

The "EDIT" indicator appears on the display.



DIVIDE→JOIN→MOVE→ERASE→ALL ERASE
→DISC TITLE*→TITLE→(Back to the beginning)
*: Displayed in Stop mode only.

4. Press the SET button.

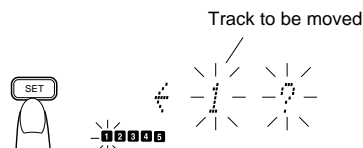

5. Select the track number to be moved.

To select the track number, press the UP, DOWN, >, or < button.
(For details, see step 5 in "Dividing Tracks (DIVIDE Function)".)

Example: Track number 3

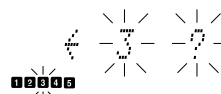

- The selected track is repeatedly played.

6. Press the SET button.

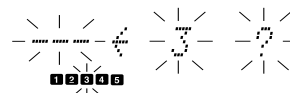

7. Select the destination to which the track is to be moved.

To select the track number, press the UP, DOWN, >, or < button.
In this example, the 3rd track will move to the 5th track. (Since, the 3rd track is lost, the upper tracks than the 3rd one will be shifted toward the younger tracks.)

Destination track Track to be moved

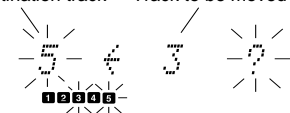

- The selected track is repeatedly played.

8. Press the SET button.

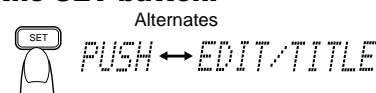

9. Press the EDIT/TITLE button.

The "EDIT" indicator disappears on the display.

10. Press the MD▲ button to complete editing.

The MD is ejected after "UTOCwriting" is displayed.

- You can also complete editing operation by pressing the button to turn off the power.

To cancel the operation, press the CANCEL button in step 4 through 8 until the display returns to the original display before editing the track.

Note: While "UTOCwriting" is displayed, do not disconnect the power cord or subject the Unit to the vibration to avoid incorrect recording.

Erasing Tracks (ERASE Function)

■ Use the Remote Control to carry out this function.

1. Insert an MD to be edited with its label side up.

2. Press the MD ▷|| button.

- You can also perform this function in Stop mode.

3. Press the EDIT/TITLE button until "ERASE ?" is displayed.

The "EDIT" indicator appears on the display.

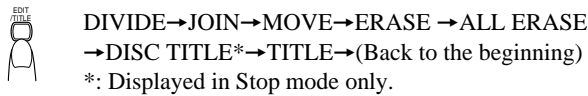

4. Press the SET button.

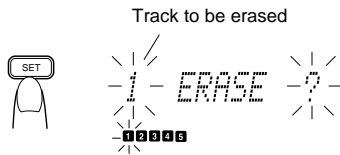

5. Select the track number to be erased.

To select the track number, press the UP, DOWN, >, or < button. (For details, see step 5 in "Dividing Tracks (DIVIDE Function)").

- The selected track is repeatedly played.

6. Press the SET button.

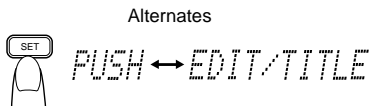

7. Press the EDIT/TITLE button.

The selected track is erased and the track numbers in the music calendar decreases by 1.

Then the "EDIT" indicator disappears on the display.

8. Press the MD ▲ button to complete editing.

The MD is ejected after "UTOCwriting" is displayed.

- You can also complete editing operation by pressing the ⏻ button to turn off the power.

To cancel the operation, press the CANCEL button in step 4, 5, or 6 until the display returns to the original display before editing the track.

Note: While "UTOCwriting" is displayed, do not disconnect the power cord or subject the Unit to the vibration to avoid incorrect recording.

Erasing all the Tracks (ALL ERASE Function)

- Use the Remote Control to carry out this function.

1. Insert an MD to be edited with its label side up.

2. Press the MD ▷|| button and then ■ button to set the function to MD.

The track numbers and total playback time are displayed.

3. Press the EDIT/TITLE button until "ALL ERASE ?" is displayed.

The "EDIT" indicator appears on the display.

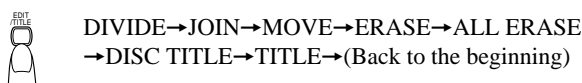

4. Press the SET button.

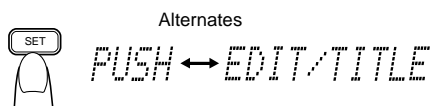

5. Press the EDIT/TITLE button.

All the tracks in the MD are erased and "BLANK DISC" is kept displayed.

The "EDIT" indicator disappears on the display.

To cancel the all erasing, press the CANCEL button in step 4. To remove the MD, press the MD▲ button.

Note: While "UTOCwriting" is displayed, do not disconnect the power cord or subject the Unit to the vibration to avoid incorrect recording.

Giving Titles to MD (DISC TITLE/TITLE Function)

You can give a disc title to the MD and a track title to the tracks in the MD. Any title name can be given up to 64 characters using the provided character sets.

The disc title you have given will be displayed in the following cases.

- When you insert the MD while the function is set to MD.
- When you press the MD ▷|| button and then ■ button to set the function to MD.

Once you have given the title to the tracks, the track title will be displayed before playing the track.

- Since the procedure to give title is the same as for the disc title and track title except for step 4, both functions are explained together here.

- Use the Remote Control to carry out these functions.

1. Insert an MD to be edited with its label side up.

2. Press the MD ▷|| button and then ■ button to set the function to MD.

The total track numbers and total playback time are displayed.

3. Press the EDIT/TITLE button until "DISC TITLE ?/TITLE ? (for track title)" is displayed.

The "EDIT" indicator appears on the display.

DIVIDE→JOIN→MOVE→ERASE→ALL ERASE→DISC TITLE→TITLE→(Back to the beginning)

4. Press the SET button.

- For DISC TITLE:

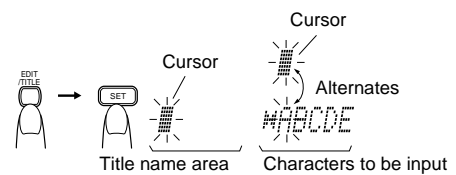

- For TITLE (Track Title):

Track to be given the title

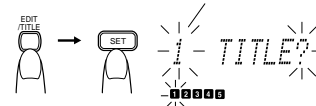



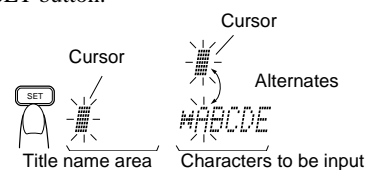

- Select the track number to be given the title using the UP, DOWN, >, or < button. (For details, see step 5 in "Dividing Tracks (DIVIDE Function)").
- Press the SET button.



5. Input a preferred title (up to 64 characters).

Use the following buttons to input a title.

[Title editing buttons and their functions] (see below)

Button	Function
CHARA	Changes the type of characters to be input as follows. Upper-case letters and symbols ↓ Lower-case letters and symbols ↓ Numbers
>	Moves the cursor for the character to be input to the right.
<	Moves the cursor for the character to be input to the left.
	Selects the characters in the upper row in the character set. e.g. FGHIJ → ABCDE
	Selects the characters in the lower row in the character set. e.g. ABCDE → FGHIJ
	Moves the cursor for the title name to the right.
	Moves the cursor for the title name to the left.
	Clears the character of the title name.

Example: When input the title "N(space)1"

- Display the letter N to be input.
 - Press the > button until the letter N is displayed.

OR

 - Press the DOWN button until "KLMNO" is displayed.
- Select "N" (put the cursor to the letter N using the > or < button).

- Press the SET button.



The letter N is now displayed in the title area.



- Select "(space)" and press the SET button.
- Press the CHARA button until the numbers are displayed.
- Select "1" and press the SET button.

The title name "N(space)1" will be displayed.

Editing the Title Name:

- If the wrong character has been input, clear it using the CANCEL button.
- To clear a particular character which has been input, use the  or  button to align the cursor with the character, and press the CANCEL button. Then, select the correct character and press the SET button.

6. Press the EDIT/TITLE button.

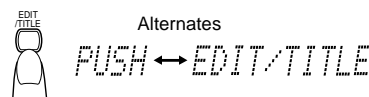

7. Press the EDIT/TITLE button again.

The "EDIT" indicator disappears on the display.

8. Press the MD▲ button to complete editing.

The MD is ejected after "UTOCwriting" is displayed.

- You can also complete editing operation by pressing the  button to turn off the power.

To cancel the operation, press the CANCEL button in step 6.

Note: While "UTOCwriting" is displayed, do not disconnect the power cord or subject the Unit to the vibration to avoid incorrect recording.

[Character Layout Table]

You can write album or song names to a disc, using the following characters:

Uppercase letters

A	B	C	D	E
F	G	H	I	J
K	L	M	N	O
P	Q	R	S	T
U	V	W	X	Y
Z				
(space)	!	"	#	\$
%	&	'	()
*	+	,	-	.
/	:	;	<	=
>	?	@	_	`

Lowercase letters

a	b	c	d	e
f	g	h	i	j
k	l	m	n	o
p	q	r	s	t
u	v	w	x	y
z				
(space)	!	"	#	\$
%	&	'	()
*	+	,	-	.
/	:	;	<	=
>	?	@	_	`

Numbers

0	1	2	3	4
5	6	7	8	9

Using External Equipment

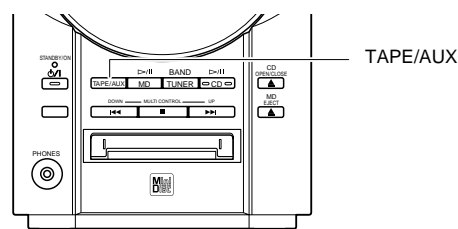
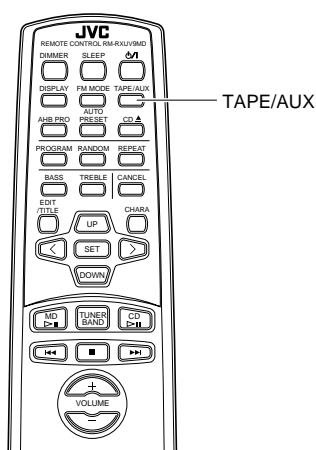

Listening to External Equipment

You can listen to external equipment.

■ First make sure that the external equipment is properly connected to the System. (See pages 4-5.)

1. Set the **VOLUME** control to the minimum position.

2. Press the **TAPE/AUX** button.

Each time you press the button, the display changes between AUX1 and AUX2.

AUX1 → ANALOG IN (Stays lit.)
AUX2 → DIGITAL IN (Stays lit.)

When the "AUX 1 (ANALOG IN)" is selected:

You can use the external equipment connected to the LINE IN (AUX1) terminals of the System, such as cassette deck, turntable, etc.

- To listen to the external equipment, start playing the external equipment.

When the "AUX 2 (DIGITAL IN)" is selected:

You can use the external equipment connected to the OPTICAL DIGITAL IN (AUX2) terminal of the System, such as CD player, etc.

- To listen to the external equipment, start playing the external equipment.

3. Start playing the external equipment.

4. Adjust the **VOLUME** control to the desired listening level.

5. Apply sound effects, if you wish.

- Press the AHB PRO button to reinforce the bass sound.
- Press the BASS/TREBLE button on the Remote Control to control the tone. (See "Tone Control" on page 7.)

To exit TAPE/AUX mode, you will automatically switch out of TAPE/AUX mode when you select another source.

Note: For operation of the external equipment, refer to its Instructions.

To record an external music source to an MD, see "Recording onto an MD" on page 14.

Recording the System's source to External Equipment

You can record the System's source to external equipment which is connected to the LINE OUT terminals of the System, such as cassette deck, etc.

■ First make sure that the external equipment is properly connected to the System. (See page 4.)

1. Play the System's CD Player, MD Player, or tune into a station.

■ The recording level is not affected by the VOLUME level set by the System. Also it is not affected by the sound effects.

Note: For operation of the external equipment, refer to its Instructions.

Using the Timers

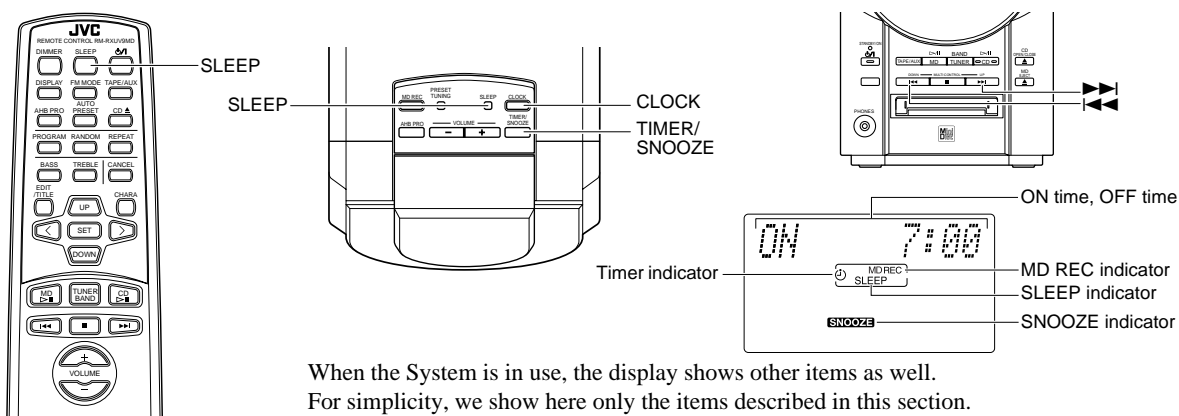

When the System is in use, the display shows other items as well. For simplicity, we show here only the items described in this section.

The timers let you control listening and recording functions automatically.

Setting the Clock

- When you plug the AC power cord into the wall outlet, the time indication blinks on the display.
- You can set the clock whether the System is on or off.
- In addition to the digital clock, the analog clock also shows the time.

Notes:

- The clock must be correctly set for the timers to work.
- The procedure must be completed within two minutes. Otherwise, the setting is cleared and must be repeated from the beginning.

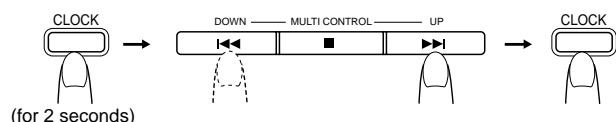

1. Press the **CLOCK** button on the Unit for more than two seconds.

The time indication rapidly blinks on the display.

2. Press the **▶▶** or **◀◀** button on the Unit to set the time.

Pressing the **▶▶** button moves the time forwards and pressing the **◀◀** button moves it backwards. Hold down the button to move the time rapidly.

3. Press the **CLOCK** button.

The selected time is set and the seconds start counting from 0.

CAUTION: If there is a power failure, the clock loses its setting after about 20 minutes. "0:00" blinks on the display and the clock must be reset.

Note: The clock may gain or lose one to two minutes per month.

Setting the Daily Timer

Once you have set the Daily Timer, the timer will be activated at the same time every day. It can be cancelled and re-activate whenever you wish.

The Timer indicator on the display shows when the Daily Timer you have set is in effect.

Note: Perform each setting within 30 seconds. Otherwise, setting is cleared and the procedure must be repeated from the beginning.

1. Press the **⏻** button to turn on the System.

2. Setting the ON time (Example: 12:15).

- Press the **TIMER/SNOOZE** button on the Unit. The Timer indicator lights up and the current ON time blinks on the display.
- When the clock is not set, the "CLOCK" indicator and the "ADJUST" indicator appear alternately on the display. Set the clock at first.



- Press the **▶▶** or **◀◀** button on the Unit to set the time you want the Unit to come on. Pressing the **▶▶** button moves the time forwards and pressing the **◀◀** button moves it backwards. Hold down the button to move the time rapidly.

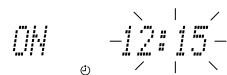

3. Setting the OFF time (Example: 13:15).

- Press the **TIMER/SNOOZE** button on the Unit. The current OFF time blinks on the display.

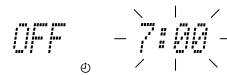

- Press the **▶▶** or **◀◀** button on the Unit to set the time you want the Unit to be turned off. Pressing the **▶▶** button moves the time forwards and pressing the **◀◀** button moves it backwards. Hold down the button to move the time rapidly.

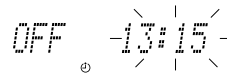

4. Selecting the music source.

- Press the **TIMER/SNOOZE** button on the Unit. The "TUNER" blinks on the display.
- Press the **▶▶** or **◀◀** button to select the music source you want to listen to. The display changes as shown below.
TUNER ↔ TUNER REC ↔ CD ↔ MD ↔ (back to the beginning)
- When you select the "TUNER REC", the "MD REC" indicator appears on the display.

5. Setting the volume level.

1. Press the TIMER/SNOOZE button on the Unit.
The volume level set by the previous timer setting blinks on the display.
2. Press the ►► or ◀◀ button to select the volume level.
-- : The current volume level will be used.
0 to 50: When the timer is turned on, the Volume will be automatically set to the selected level.



6. Press the TIMER/SNOOZE button on the Unit.

The timer setting is completed and the display returns to the display before you set the timer. The timer indicator remains lit.

7. Before turning off the System, prepare the music source selected in step 4.

- TUNER : Tune in to the desired station.
TUNER REC : Tune in to the desired station and insert an MD for recording the station.
CD : Insert a CD.
MD : Insert an MD.

- Program Play on CD or MD is not possible for timer function.

8. Press the ⏻ button to turn off the System.

To cancel the timer, press the TIMER/SNOOZE button. The Timer indicator goes out on the display.

To re-activate the cancelled timer, press the TIMER/SNOOZE button to light the Timer indicator. Then, press the TIMER/SNOOZE button until the display returns to the original display. The Timer indicator should remain lit.

To confirm the timer settings, cancel the timer once by pressing the TIMER/SNOOZE button. Then, press the TIMER/SNOOZE button repeatedly, to see the current timer settings (ON time, OFF time, source, and volume).

To change the timer setting, repeat the setting procedure from the beginning.

- When the timer turns on, the Timer indicator starts blinking.

CAUTION: If the System is unplugged, or a power failure occurs, the timer setting will be lost. You will need to reset the clock first, then the timer.

5-Minute Snoozing

When the timer turns on the music source you can, if you wish, activate the 5-minute snoozing function to temporarily stop playback.

Press the TIMER/SNOOZE button on the Unit.

The “SNOOZE” indicator lights up on the display and the power is turned off for five minutes for snoozing.

- If you press the TIMER/SNOOZE button 5 minutes or less before the timer reaches its OFF time, the power is turned accordingly, but it cannot be turned on again.

Setting the SLEEP Timer

Use the Sleep Timer to turn the System off after a certain number of minutes when it is playing. By setting the Sleep Timer, you can fall asleep to music and know that your System will turn off by itself rather than play all night.

- You can only set the Sleep Timer when the System is on and a source is playing.

1. Play a CD, an MD, or tune in to the desired station.

2. Press the SLEEP button.

The “SLEEP” indicator lights up.

- When the clock is not set, the “CLOCK” indicator and the “ADJUST” indicator appear alternately on the display. Set the clock first.

3. Set the length of time you want the source to play before shutting off.

- Each time you press the SLEEP button, it changes the number of minutes shown on the display in this sequence:
10 → 20 → 30 → 60 → 90 → 120 → Cancelled → (back to the beginning)

After setting the number of minutes for the Sleep Timer, the display will stop blinking and return to the display as before setting the Sleep Timer. (The display is dimmed.)

The System is now set to turn off after the number of minutes you set.

To Confirm the Sleep Time

When the SLEEP button is pressed, the remaining sleep time is displayed. Wait until the display returns to the original display.

To Cancel the SLEEP Timer Setting

Press the SLEEP button until the “SLEEP” indicator goes out on the display.

Turning off the System also cancels the SLEEP Timer.

- If you are setting the Daily Timer, the System will be turned on at the set time to wake you up.

Information on MDs (Minidiscs)

This is a new digital audio disc format: it has a diameter of 64 mm and enables up to 80 minutes of playback and recording.

The cartridge

The diameter of the disc itself is 64 mm, smaller than a CD single. The disc sits inside a 68 × 72 mm cartridge, which also being pocket size, makes minidisks extremely handy for carrying and storage. Since the disc is protected by the cartridge, dust and dirt cannot easily get into it. And thanks to a shutter which is closed at all times except during use, there is no need to worry about scratches or finger marks, making the handling of minidisks very simple.

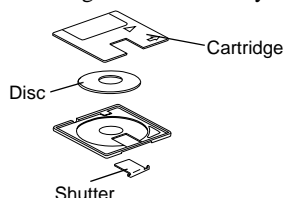

Two types of minidisc

There are two types of minidisc, "recordable MDs" and "playback-only MDs." The playback method for each is the same: a laser irradiates the disc and the signal is read from the beam which comes back. However, the recording method for each type is different.

Playback-only MD

This is the type used for commercially-available pre-recorded MDs, on which recording cannot be done. Like a CD, data is recorded based on the presence or absence of small indentations called pits. A disc recorded with this format is called an "optical disc."

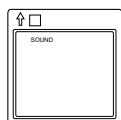

Recordable MDs

These are the so-called "blank" MDs you can use to make your own recordings. Data is recorded by magnetism, which is easily processed, so that recording can be done again and again. By using a laser to heat the disc, the magnetism is erased and the magnetic head records the new data. Discs with this type of recording method are called magneto-optical (MO) discs.

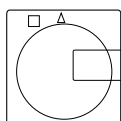

ATRAC (Adaptive Transform Acoustic Coding)

Within recordings, there are sounds which cannot be readily heard. For example, as the volume decreases, high-pitched sounds and low-pitched sounds become difficult to hear. Also, if a quiet sound comes at the same time as or just after a loud sound, it will not be heard. With minidisks, data is compressed using a technology called ATRAC (Adaptive Transform Acoustic Coding) which selectively chooses sounds based on human sense of hearing characteristics. With this technology, the recorded data is about one-fifth the volume of the original data, allowing it to fit on a compact minidisc.

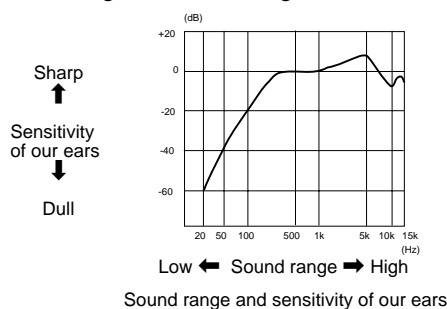

Sound skip guard memory

With the minidisc, the data of the track being played can be temporarily stored up using a function called "sound skip guard memory". Even when data cannot be collected properly from the disc due to shaking or vibrations, information is stored in the "sound skip guard memory", so that there is no break in the sound which is actually delivered.

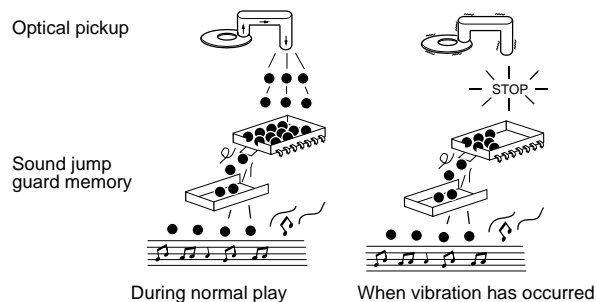

UTOC (User Table Of Contents)

In a minidisc, apart from the recorded tracks, there is the "UTOC". In this area, information such as the position where each track is recorded, the track divisions, and track order are listed. When music search is done, the UTOC is consulted, and the tracks are quickly found and played back. When editing is done, only the UTOC is changed, so there is no need to re-record the tracks.

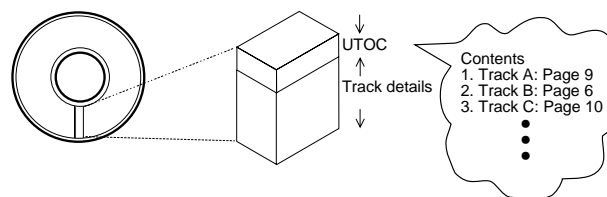

MD (Minidisc) Messages

Message	Meaning	Action
BLANK DISC	A disc has been inserted with nothing recorded on it.	Except when making a new recording, replace the disc with one which has been recorded on.
CANNOT JOIN	You have tried to join tracks which cannot be joined.	This is a limitation of the minidisc system. See "Minidisc limitations" below.
DISC ERROR	There is a problem (damage) with the disc.	Replace the disc.
DISC FULL	There is not enough space left on the disc. There are over 254 tracks.	Replace the disc with another recordable MD.
DISC PROTECTED	The disc is in accidental erasure protection mode.	Slide the accidental erasure protection tab. (So that the hole is covered.)
EMERGENCY STOP	A malfunction occurred during recording.	Stop the disc by pressing the ■ button and redo the operation.
MD NO DISC	There is no disc in the unit.	Insert a disc into the unit.
NON AUDIO CANNOT COPY	You have tried to digitally dub a CD-ROM.	Stop recording.
PLAYBACK MD	You have tried to record or edit on a playback-only disc.	Replace the disc with a recordable MD.
TRACK PROTECTED	The track is protected.	This unit cannot undo track protection. Undo the protection using the appliance that created it.
SCMS CANNOT COPY	You have tried to make a copy of a copy by digital dubbing.	Dub using analog input (LINE IN).
DIGITAL IN UNLOCK	The digital cable is disconnected.	Connect the digital cable securely.
LOAD ERROR	MD is not correctly loaded.	Disconnect the AC power cord and reconnect it after a little while. Then, press the MD ▲ button.

Minidisc Limitations

The minidisc records information in an original format that differs from that of conventional cassette tapes or DATs. Since there are some limitations with this recording format, the following types of conditions may arise. These conditions are not malfunctions.

Condition	Cause
"DISC FULL" is displayed, even though the possible recording time is not used up.	With the minidisc, there is a maximum number of tracks which can be recorded, regardless of time. More than 254 tracks cannot be recorded on a disc.
"DISC FULL" is displayed, even though the number of tracks and recording time are not at the limit.	When parts of the disc are erased and re-recorded, blank spots are created on the disc. When recording to such a disc, one track of data is divided and recorded in the blank areas. During recording, when these divided parts become numerous, the "DISC FULL" message may be displayed. When a part of 8 seconds or less is created by division, that track cannot be joined by the JOIN function, and even if it is erased, the remaining usable time on the disc does not increase. Tracks divided into small pieces may skip when fast forward or fast rewind is done.
The JOIN function sometimes does not work.	
The remaining usable time on the disc does not increase even when tracks are erased.	
The sound skip during fast forward or fast rewind.	
The amount of recorded time on the disc added to the amount of remaining time falls short of the disc's total possible recording time.	Minidiscs must have at least 2 seconds of continuous space in order to record. For this reason, the actual recording time of discs with a lot of short blank areas becomes shorter.

Rules of Digital Dubbing

The following rules regarding copyright exist for dubbing to MDs from CDs or DATs through digital terminals.

SCMS (Serial Copy Management System)

Minidisks can record clear sound with low loss of quality from CDs or DATs through each component's digital input/output terminal. However, minidisks are set up so that a disc recorded in this way cannot be recorded onto another minidisk through digital input/output terminals. In other words, you can not make a copy of a copy. This rule is called SCMS (Serial Copy Management System).

The recorder is designed in compliance with this rule. If you try to make a copy of a copy the error message "SCMS CANNOT COPY" is displayed, and dubbing can not be done.

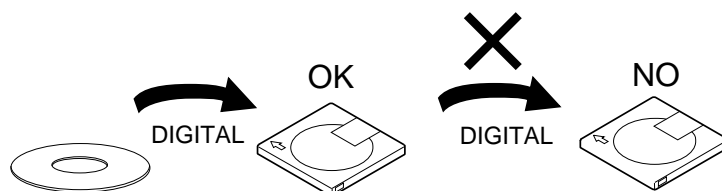

It may be unlawful to record or play back copyrighted material without the consent of the copyright owner.

Care And Maintenance

Handle your CDs and MDs carefully, and they will last a long time.

Compact Discs



- Only CDs bearing this mark can be used with this System. However, continued use of irregularly shaped CDs (heart-shape, octagonal, etc.) can damage the System.



- Remove the CD from its case by holding it at the edges while pressing the case's center hole lightly.
- Do not touch the shiny surface of the CD, or bend the CD.



- Put the CD back in its case after use to prevent warping.
- Be careful not to scratch the surface of the CD when placing it back in the case.
- Avoid exposure to direct sunlight, temperature extremes, and moisture.



- A dirty CD may not play correctly. If a CD does become dirty, wipe it with a soft cloth in a straight line from center to edge.

CAUTION: Do not use any solvent (for example, conventional record cleaner, spray thinner, benzene, etc.) to clean a CD.

MDs (Minidiscs)

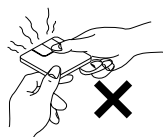

Do not open the shutter. Since the shutter is locked to prevent it from opening, forcing it to open will break the disc.

Moisture Condensation



Moisture may condense on the lens inside the System in the following cases:

- After turning on heating in the room.
- In a damp room.
- If the System is brought directly from a cold to a warm place.

Should this occur, the System may malfunction. In this case, leave the System turned on for a few hours until the moisture evaporates, unplug the AC power cord, and then plug it in again.

General Notes

In general, you will have the best performance by keeping your CDs, MDs, and the mechanism clean.

- Store CDs and MDs in their cases, and keep them in cabinets or on shelves.
- Keep the system's CD cover closed when not in use.

Cleaning the lens

If the lens in the CD pickup is dirty, dropout, etc., could degrade sound.

Open the CD cover and clean the lens as shown.

- Use a blower (available from a camera store) to blow dust off the lens.

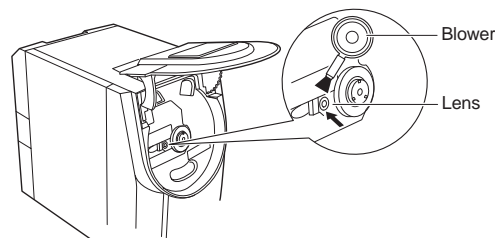

- If there are fingerprints, etc. on the lens, gently wipe clean with a cotton swab.

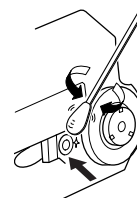

Troubleshooting

- If you are having a problem with your System, check this list for a possible solution before calling for service.
- If you cannot solve the problem from the hints given here, or the System has been physically damaged, call a qualified person, such as your dealer, for service.

Symptom	Possible Cause	Action
No sound is heard.	<ul style="list-style-type: none"> • Connections are incorrect, or loose. • Headphones are connected. 	<ul style="list-style-type: none"> • Check all connections and make corrections. (See pages 3- 5.) • Disconnect the headphones.
Poor radio reception	<ul style="list-style-type: none"> • The antenna is disconnected. • The AM Loop Antenna is too close to the System. • The FM Wire Antenna is not properly extended and positioned. 	<ul style="list-style-type: none"> • Reconnect the antenna securely. • Change the position and direction of the AM Loop Antenna. • Extend FM Wire Antenna to the best reception position.
The CD skips.	The CD is dirty or scratched.	Clean or replace the CD.
The CD does not play.	The CD is upside down.	Put the CD in with the label side up.
The MD cannot be inserted.	An MD has already been inserted.	Press the MD▲ button to eject the inserted MD and insert a new MD.
Recording cannot be made on MD.	The accidental erasure prevention knob of the MD is set to the open position.	Set it to the close position.
Timer fails to start.	Present time is not correct.	Set the time correctly.
Unable to operate the Remote Control.	<ul style="list-style-type: none"> • The path between the Remote Control and the sensor on the Unit is blocked. • The batteries have lost their charge. 	<ul style="list-style-type: none"> • Remove the obstruction. • Replace the batteries.
Operations are disabled.	The built-in microprocessor has malfunctioned due to external electrical interference.	Unplug the System then plug it back in.

Specifications

Amplifier

Output Power	36 W (18 W + 18 W) at 4 ohms (Max.) 28 W (14 W + 14 W) at 4 ohms (10% THD)
Input Sensitivity/Impedance (1 kHz)	
LINE IN (AUX1)	500 mV/65 kohms
Optical In (AUX2)	-24 dBm - -15 dBm
Output Sensitivity/Impedance (1 kHz)	
LINE OUT	500 mV/4.3 kohms
Speaker terminals	4 - 16 ohms
Phones	16 ohms - 1 kohms 0 - 15 mW/ch output into 32 ohms

CD Player

Signal-To-Noise Ratio	90 dB
Wow And Flutter	Unmeasurable

MD Recorder

Audio playing system	Minidisc digital audio system
Recording system	Magneto-optical overwrite system
Sampling frequency	44.1 kHz (With sampling rate converter for recording - 32 kHz/44.1 kHz/48 kHz)
Audio compression system	ATRAC (Adaptive Transform Acoustic Coding)

Tuner

FM Tuner	
Tuning Range	87.5 - 108.0 MHz
AM Tuner	
Tuning Range	(MW) 522 - 1,629 kHz (LW) 144 - 288 kHz

Speaker Specifications

(each unit)	Speakers	Woofer 9 cm, Tweeter 4 cm
	Impedance	4 ohms
	Dimensions	140 × 230 × 218 mm (W/H/D)
	Mass	Approx. 2.0 kg

General

Dimensions	438 × 231 × 310.5 mm (W/H/D)
Mass	Approx. 8.1 kg

Accessories

Power Cord (1)
AM Loop Antenna (1)
Remote Control (1)
Batteries R6P (SUM-3)/AA (15F) (2)
FM Wire Antenna (1)

Power Specifications

Power Requirements	AC 240 V ~ , 50 Hz
Power Consumption	31 watts (power on mode) 2.0 watts (in Standby mode)

*Design and specifications are subject to change without notice.
US and foreign patents licensed from Dolby Laboratories Licensing Corporation.*



JVC
VICTOR COMPANY OF JAPAN, LIMITED

Free Manuals Download Website

<http://myh66.com>

<http://usermanuals.us>

<http://www.somanuals.com>

<http://www.4manuals.cc>

<http://www.manual-lib.com>

<http://www.404manual.com>

<http://www.luxmanual.com>

<http://aubethermostatmanual.com>

Golf course search by state

<http://golfingnear.com>

Email search by domain

<http://emailbydomain.com>

Auto manuals search

<http://auto.somanuals.com>

TV manuals search

<http://tv.somanuals.com>