

JVC



COMPACT DISC PLAYER

XL-Z132BK/XL-Z232BK

XL-Z132BK

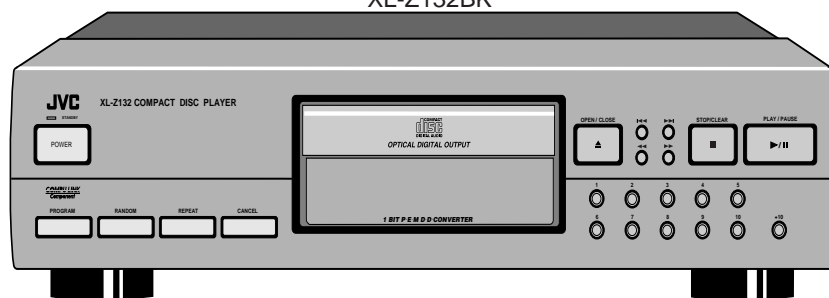

XL-Z232BK

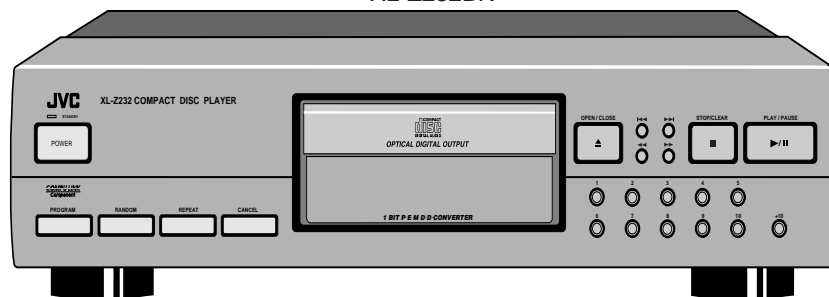
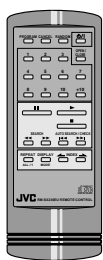

COMPACT
disc
DIGITAL AUDIO

COMPU LINK
Component

INSTRUCTIONS

For Customer Use:

Enter below the Model No. and Serial No. which are located either on the rear, bottom or side of the cabinet. Retain this information for future reference.

Model No. _____

Serial No. _____

LVT0205-001A

[J]

Warnings, Cautions and Others/ Mises en garde, précautions et indications diverses

	CAUTION RISK OF ELECTRIC SHOCK DO NOT OPEN	
CAUTION: TO REDUCE THE RISK OF ELECTRIC SHOCK. DO NOT REMOVE COVER (OR BACK) NO USER SERVICEABLE PARTS INSIDE. REFER SERVICING TO QUALIFIED SERVICE PERSONNEL.		



The lightning flash with arrowhead symbol, within an equilateral triangle is intended to alert the user to the presence of uninsulated "dangerous voltage" within the product's enclosure that may be of sufficient magnitude to constitute a risk of electric shock to persons.



The exclamation point within an equilateral triangle is intended to alert the user to the presence of important operating and maintenance (servicing) instructions in the literature accompanying the appliance.

For U.S.A.

This equipment has been tested and found to comply with the limits for a Class B digital device, pursuant to part 15 of the FCC Rules. These limits are designed to provide reasonable protection against harmful interference in a residential installation.

This equipment generates, uses and can radiate radio frequency energy and, if not installed and used in accordance with the instructions, may cause harmful interference to radio communications. However, there is no guarantee that interference will not occur in a particular installation. If this equipment does cause harmful interference to radio or television reception, which can be determined by turning the equipment off and on, the user is encouraged to try to correct the interference by one or more of the following measures:

- Reorient or relocate the receiving antenna.
- Increase the separation between the equipment and receiver.
- Connect the equipment into an outlet on a circuit different from that to which the receiver is connected.
- Consult the dealer or an experienced radio/TV technician for help.

WARNING: TO REDUCE THE RISK OF FIRE OR ELECTRIC SHOCK, DO NOT EXPOSE THIS APPLIANCE TO RAIN OR MOISTURE.

Caution — POWER switch!

Disconnect the mains plug to shut the power off completely. The POWER switch in any position does not disconnect the mains line. The power can be remote controlled for XL-Z232BK.

Attention — Commutateur POWER!

Déconnecter la fiche de secteur pour couper complètement le courant. Le commutateur POWER ne coupe jamais complètement la ligne de secteur, quelle que soit sa position. Le courant peut être télécommandé modèle XL-Z232BK .

CAUTION

To reduce the risk of electrical shocks, fire, etc.:

1. Do not remove screws, covers or cabinet.
2. Do not expose this appliance to rain or moisture.

ATTENTION

Afin d'éviter tout risque d'électrocution, d'incendie, etc.:

1. Ne pas enlever les vis ni les panneaux et ne pas ouvrir le coffret de l'appareil.
2. Ne pas exposer l'appareil à la pluie ni à l'humidité.

For Canada/pour le Canada

CAUTION: TO PREVENT ELECTRIC SHOCK, MATCH WIDE BLADE OF PLUG TO WIDE SLOT, FULLY INSERT.

ATTENTION: POUR EVITER LES CHOCS ELECTRIQUES, INTRODUIRE LA LAME LA PLUS LARGE DE LA FICHE DANS LA BORNE CORRESPONDANTE DE LA PRISE ET POUSSER JUSQU'AU FOND.

For Canada/pour le Canada

THIS DIGITAL APPARATUS DOES NOT EXCEED THE CLASS B LIMITS FOR RADIO NOISE EMISSIONS FROM DIGITAL APPARATUS AS SET OUT IN THE INTERFERENCE-CAUSING EQUIPMENT STANDARD ENTITLED "DIGITAL APPARATUS," ICES-003 OF THE DEPARTMENT OF COMMUNICATIONS.

CET APPAREIL NUMERIQUE RESPECTE LES LIMITES DE BRUITS RADIOELECTRIQUES APPLICABLES AUX APPAREILS NUMIRIQUES DE CLASSE B PRESCRITES DANS LA NORME SUR LE MATERIEL BROUILLEUR: "APPAREILS NUMERIQUES", NMB-003 EDICTEE PAR LE MINISTRE DES COMMUNICATIONS.

IMPORTANT FOR LASER PRODUCTS

1. CLASS 1 LASER PRODUCT
2. **DANGER:** Invisible laser radiation when open and interlock failed or defeated. Avoid direct exposure to beam.
3. **CAUTION:** Do not open the top cover. There are no user serviceable parts inside the unit; leave all servicing to qualified service personnel.

IMPORTANT POUR LES PRODUITS LASER

1. PRODUIT LASER CLASSE 1
2. **ATTENTION:** Radiation laser invisible quand l'appareil est ouvert ou que le verrouillage est en panne ou désactivé. Eviter une exposition directe au rayon.
3. **ATTENTION:** Ne pas ouvrir le couvercle du dessus. Il n'y a aucune pièce utilisable à l'intérieur. Laisser à un personnel qualifié le soin de réparer votre appareil.

HOW TO LOCATE YOUR JVC SERVICE CENTER

TOLL FREE : 1-800-537-5722

<http://www.jvcservice.com>

Dear customer:

In order to receive the most satisfaction from your purchase, read the instruction booklet before operating the unit. In the event that repair is necessary, or for the address nearest your location, please refer to the factory service center list below or within the Continental United States, Call 1-800-537-5722 for your authorized servicer. Remember to retain your Bill of Sale for Warranty Service.

—JVC

JVC SERVICE & ENGINEERING COMPANY OF AMERICA DIVISION OF JVC AMERICAS CORP.

FACTORY SERVICE CENTER LOCATIONS

107 Little Falls Road
Fairfield, NJ 07004-2105
(973) 808-9279

1500 Lakes Parkway
Lawrenceville, GA 30243-5857
(770) 339-2522

705 Enterprise Street
Aurora, IL 60504-8149
(630) 851-7855

5665 Corporate Avenue
Cypress, CA 90630-0024
(714) 229-8011

2969 Mapunapuna Place
Honolulu, HI 96819-2040
(808) 833-5828

10700 Hammerly, Suite 110
Houston, TX 77043
(713) 935-9331

13 Cummings Park
Woburn, MA 01801
(781) 376-9100

8192 State Road 84
Davie, FL 33324
(954) 472-1960

890 Dubuque Avenue
South San Francisco, CA 94080-1804
(650) 871-2666

Sophisticated electronic products may require occasional service. Just as quality is a keyword in the engineering and production of the wide array of JVC products, service is the key to maintaining the high level of performance for which JVC is world famous. The JVC service and engineering organization stands behind our products.

NATIONAL HEADQUARTERS
JVC SERVICE & ENGINEERING COMPANY OF AMERICA
DIVISION OF JVC AMERICAS CORP.
1700 Valley Road
Wayne, NJ 07470

If you ship the product •••

Pack your JVC unit in the original carton or one of equivalent size and strength. Enclose, with the unit, a letter stating the problem or symptom that exists and also a copy of the receipt or bill of sale you received when you purchased your JVC unit. Print your home return address on the outside and the inside of the carton. Send to the appropriate JVC Factory Service Center as listed above.

Don't service it yourself.

CAUTION

To prevent electrical shock, do not open the cabinet. No user serviceable parts inside.
Refer servicing to qualified service personnel.

ACCESSORIES

To purchase accessories for your JVC product, you may contact your local JVC Dealer.
Or from the 48 Continental United States call toll free : 800-882-2345



LIMITED WARRANTY AUDIO-1

JVC COMPANY OF AMERICA warrants this product and all parts thereof, except as set forth below ONLY TO THE ORIGINAL PURCHASER AT RETAIL to be FREE FROM DEFECTIVE MATERIAL AND WORKMANSHIP from the date of original retail purchase for the period as shown below. ("The Warranty Period.")

PARTS	LABOR
1YR	1YR

THIS LIMITED WARRANTY IS VALID ONLY IN THE FIFTY(50) UNITED STATES, THE DISTRICT OF COLUMBIA AND IN COMMONWEALTH OF PUERTO RICO.

WHAT WE WILL DO:

If this product is found to be defective, JVC will repair or replace defective parts at no charge to the original owner. Such repair and replacement services shall be rendered by JVC during normal business hours at JVC authorized service centers. Parts used for replacement are warranted only for the remainder of the Warranty Period. All products and parts thereof may be brought to a JVC authorized service center on a carry-in basis except for Television sets having a screen size 25 inches and above which are covered on an in-home basis.

WHAT YOU MUST DO FOR WARRANTY SERVICE:

Return your product to a JVC authorized service center with a copy of your bill of sale. For your nearest JVC authorized service center, please call toll free: (800)537-5722. If service is not available locally, box the product carefully, preferably in the original carton, and ship, insured, with a copy of your bill of sale plus and letter of explanation of the problem to the nearest JVC Factory Service Center, the name and location of which will be given to you by the toll-free number. If you have any questions concerning your JVC Product, please contact our Customer Relations Department.

WHAT IS NOT COVERED:

This limited warranty provided by JVC does not cover:

1. Products which have been subject to abuse, accident, alteration, modification, tampering, negligence, misuse, faulty installation, lack of reasonable care, or if repaired or serviced by anyone other than a service facility authorized by JVC to render such service, or if affixed to any attachment not provided with the products, or if the model or serial number has been altered, tampered with, defaced or removed;
2. Initial installation and installation and removal for repair;
3. Operational adjustments covered in the Owner's Manual, normal maintenance, video and audio head cleaning;
4. Damage that occurs in shipment, due to act of God, and cosmetic damage;
5. Signal reception problems and failures due to line power surge;
6. Video Pick-up Tubes/CCD Image Sensor, Cartridge, Stylus(Needle) are covered for 90 days from the date of purchase;
7. Accessories;
8. Batteries (except the Rechargeable Batteries are covered for 90 days from the date of purchase);

There are no express warranties except as listed above.

THE DURATION OF ANY IMPLIED WARRANTIES, INCLUDING THE IMPLIED WARRANTY OF MERCHANTABILITY, IS LIMITED TO THE DURATION OF THE EXPRESS WARRANTY HEREIN.

JVC SHALL NOT BE LIABLE FOR THE LOSS OF USE THE PRODUCT, INCONVENIENCE, LOSS OR ANY OTHER DAMAGES, WHETHER DIRECT, INCIDENTAL OR CONSEQUENTIAL (INCLUDING, WITHOUT LIMITATION, DAMAGE TO TAPES, RECORDS OR DISCS) RESULTING FROM THE USE OF THIS PRODUCT, OR ARISING OUT OF ANY BREACH OF THIS WARRANTY. ALL EXPRESS AND IMPLIED WARRANTIES, INCLUDING THE WARRANTIES OF MERCHANTABILITY AND FITNESS FOR PARTICULAR PURPOSE, ARE LIMITED TO THE WARRANTY PERIOD SET FORTH ABOVE.

Some states do not allow the exclusion of incidental or consequential damages or limitations on how long an implied warranty last, so these limitations or exclusions may not apply to you. This warranty gives you specific legal rights and you may also have other rights which vary from state to state.

JVC COMPANY OF AMERICA
DIVISION OF JVC AMERICAS CORP.

1700 Valley Road
Wayne, NJ 07470

REFURBISHED PRODUCTS CARRY A SEPARATE WARRANTY, THIS WARRANTY DOES NOT APPLY. FOR DETAILS OF REFURBISHED PRODUCT WARRANTY, PLEASE REFER TO THE REFURBISHED PRODUCT WARRANTY INFORMATION PACKAGED WITH EACH REFURBISHED PRODUCT.

For customer use:

Enter below the Model No. and Serial No. which is located either on the rear, bottom or side of the cabinet. Retain this information for future reference.

Model No.: _____

Serial No.: _____

Purchase date: _____

Name of dealer: _____

We would like to thank you for purchasing one of our JVC products.

Before connecting this unit to the wall outlet, please read the instructions carefully to ensure that you obtain the best possible performance.

If you have any questions, please consult your JVC dealer.

Table of contents

INTRODUCTION	1
Precautions	1
About this manual	1
Names of buttons	2
BEFORE USING FOR THE FIRST TIME	4
Installing the unit	4
Connecting to the analog output jacks	4
Connecting to the digital output jack	4
Supplying the power	5
To connect the AC power cord of the main unit	5
Installing the batteries (XL-232BK only)	6
To install the batteries in the remote control unit	6
COMPU LINK connection	6
BASIC OPERATIONS	7
Basic functions for disc playback	7
Turning on the power of this unit	7
Loading a disc in the disc tray	7
Remote control operation (XL-232BK Only)	7
Playing a disc	8
Stopping playback	8
Locating a point to start playback	8
Skipping to a desired track	8
Skipping to a desired index (XL-232BK Only) (for a disc with INDEX)	8
Searching for a desired section	9
Specifying a desired track	9
Displaying the time	9
Switching the time display on XL-Z232BK	9
Displaying the time on XL-Z132BK	9
VARIOUS PLAYBACK PATTERNS	10
Playing tracks in a desired order	10
Playing tracks in a random order	10
Playing repeatedly	11
Repeating whole disc	11
Repeating one track	11
GENERAL INFORMATIONS	12
COMPU LINK remote control system	12
Care and handling	13
Troubleshooting	14
Specifications	14

INTRODUCTION

Precautions

Load compact disc only

Never insert anything other than a compact disc into any part of the player.

If a problem persists

If something goes wrong, turn off the power immediately. If the same problem reoccurs when the power is turned on once more, turn off the power again and consult your JVC dealer.

Handling the power cord

When unplugging from the wall socket, always pull the plug body, never the power cable.

Volume settings

A CD player has almost zero background noise. Because of this, the technique of listening to the background level and then setting the volume before the music starts, as used with analog turntables or tape decks, cannot be used. If you raise the volume level too high, speaker damage may result.

Condensation

The CD player uses optical components. If it is moved from a cold location to a warm one, or is used in a room subject to excessive humidity or where a fire has just been lit, condensation could form on the optical components.

This may prevent the laser beam from being properly transmitted and thus causes noise or even a malfunction.

If condensation has formed and the CD player does not function correctly, we recommend that you leave it turned on for an hour or two. If at the end of this time the CD player still does not function properly, please consult your JVC dealer.

Transporting the unit

When carrying this unit, it is best to avoid either tilting it or turning it upside-down. Where you cannot avoid doing so, please remove the disc first.

Using compact discs

Compact discs are made of plastic and can be easily damaged. If the disc is dirty, scratched, warped or otherwise damaged, the digital information may not be picked up correctly.

Applicable discs

This unit can only be used with compact discs bearing the mark below. Never use discs of other types.



About this manual

This manual covers the operating instructions for the compact disc player XL-Z132BK and XL-Z232BK.

There are several functions which require separate instructions for each model. Please check the model number stated on the carton box, and follow the descriptions applicable to your unit.

This manual is organized as follows:

The first part, "INTRODUCTION", gives you the precautions when using this unit, and shows you the names of buttons on the main unit and the remote control unit.

The second part, "BEFORE USING FOR THE FIRST TIME", tells you what kind of operations you should do before playing a disc. This part describes where to place the unit for best results, how to install batteries in the remote control unit and how to connect this unit to the amplifier/receiver and other components.

The third part, "BASIC OPERATIONS", describes how to load a disc, and convenient basic functions for playing disc.

The fourth part, "VARIOUS PLAYBACK PATTERNS", describes various functions for playing disc, and convenient functions for recording.

The fifth part, "GENERAL INFORMATION", describes the COMPU LINK remote control system which facilitates various operations between JVC components, and explains how to take care of discs.

This part also includes "Troubleshooting" which tells you how to check the unit when a malfunction occurs, and the technical informations regarding this unit.

Names of buttons

Main unit

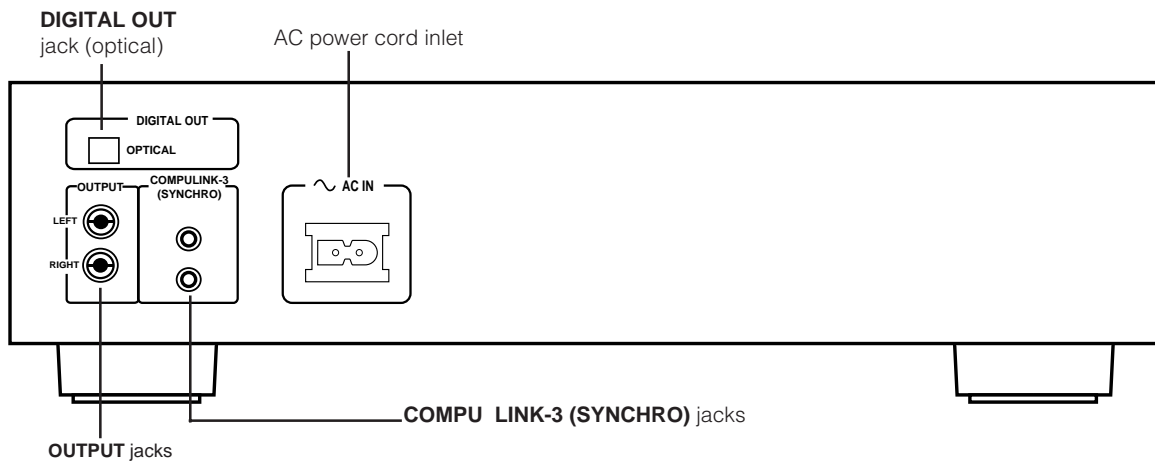
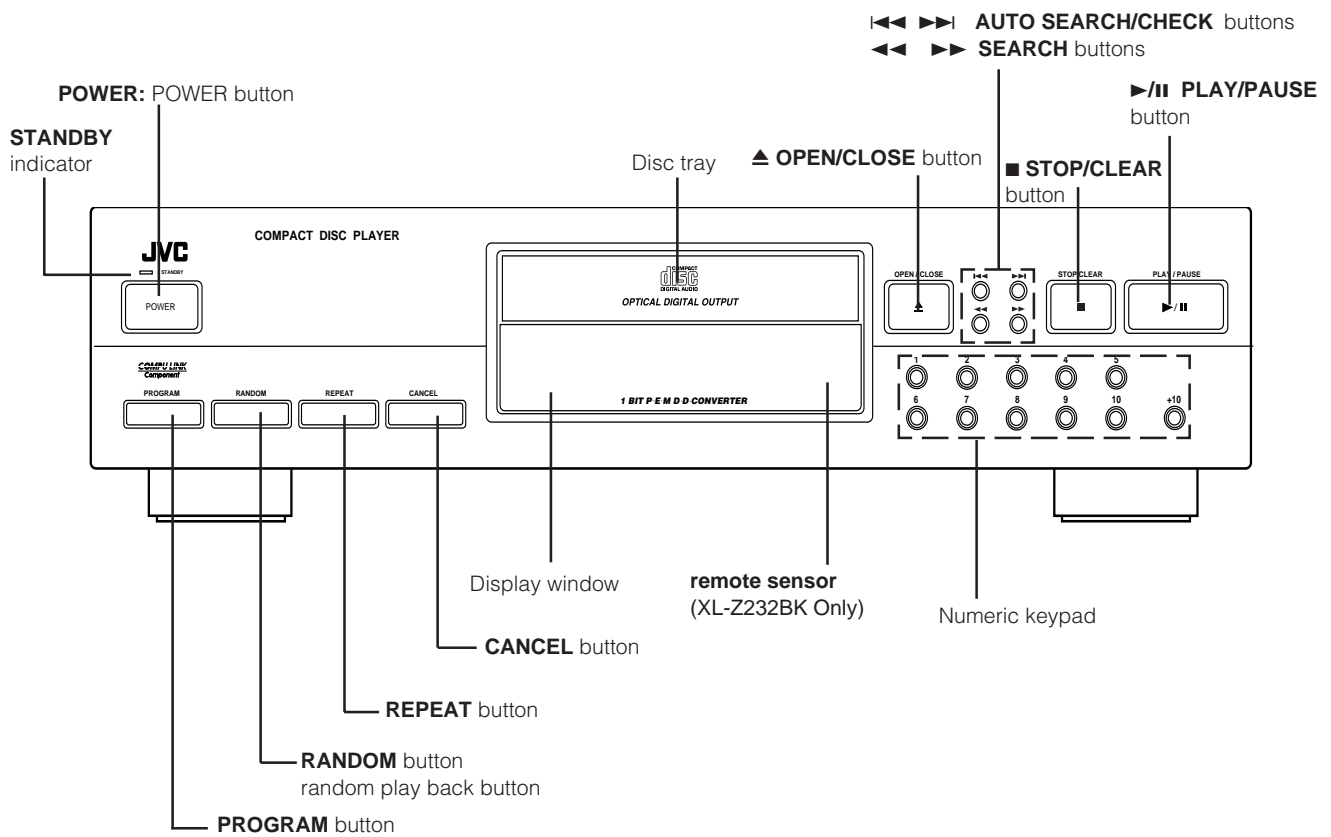

Remote control unit (XL-Z232BK only)

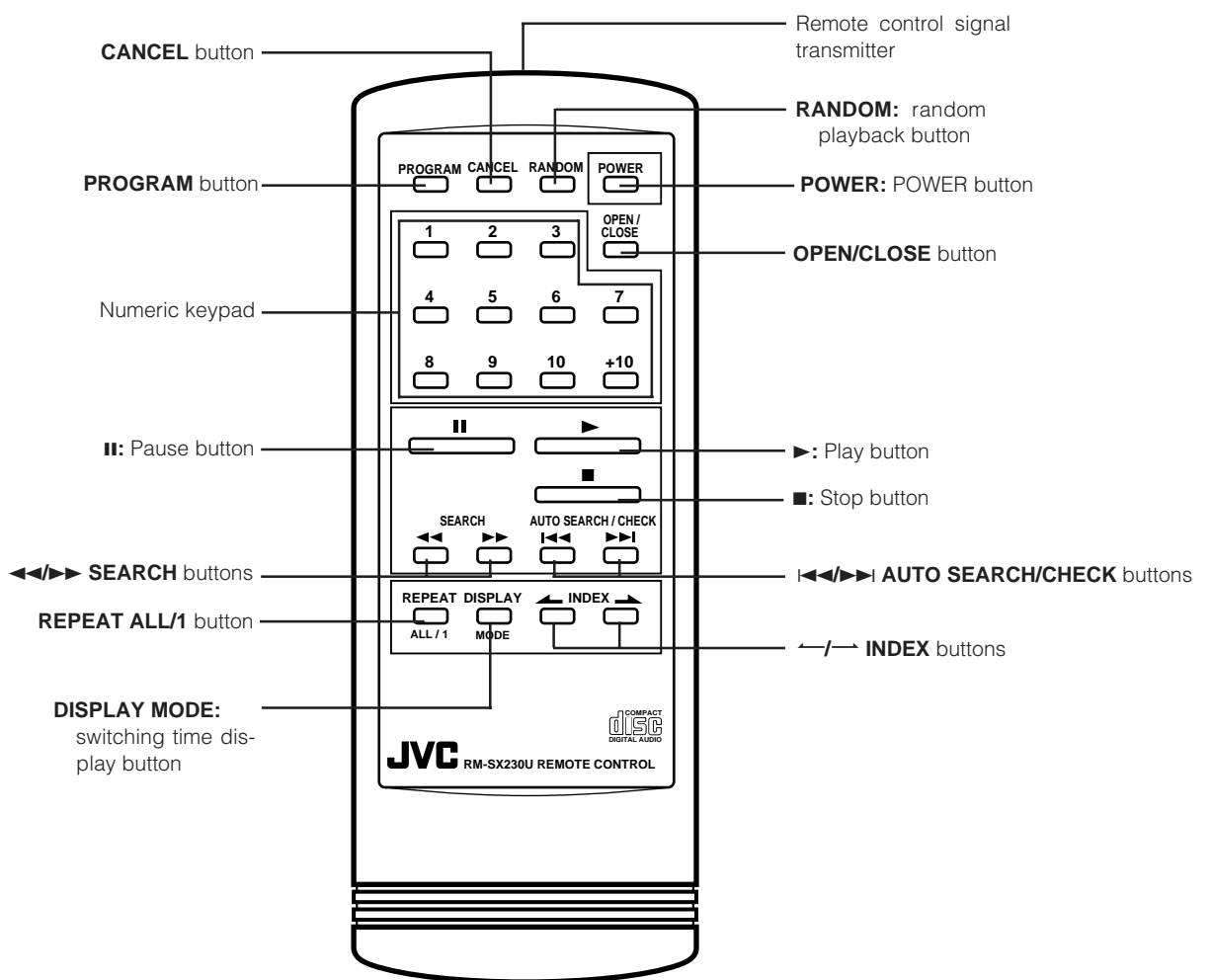

BEFORE USING FOR THE FIRST TIME

Installing the unit

Best location

Select a location which is level, dry and neither too cold nor too hot (temperature range 5°C (41°F) to 35°C (95°F)). Also, avoid dusty locations or any location subject to vibration.

If interference occurs

If this equipment is placed near a tuner or a radio receiver tuned to AM frequencies, interference may occur. If this happens, we recommend either that you move this unit as far away as possible from the tuner or receiver or briefly turn off the power to this unit.

Connecting to the Analog Output Jacks

Connecting to an amplifier or receiver allows you to listen to the sound from the speakers.

Connect the OUTPUT jacks of this unit to the line input jacks of an amplifier or receiver with the supplied audio cord.

Notes

- Never connect the OUTPUT jacks to the PHONO jacks of the amplifier or receiver. This may cause damage to the components.
- Make sure that the same channels are connected between this unit and the amplifier or receiver: LEFT to LEFT and RIGHT to RIGHT.
- Do not connect the power plug unless all connections are completed.
- Connect the plugs firmly. Loose connections may cause noise or malfunction.

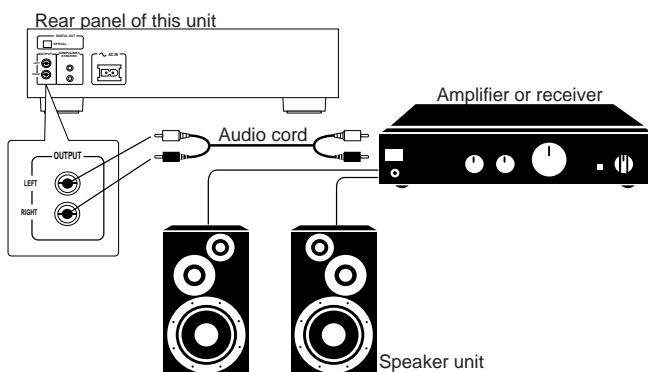

Connecting to the Digital Output Jack

It is possible to transmit a digital sound signal from this unit directly to a MD recorder, etc.

Notes

- Never connect the digital out put cable except to the digital input jack.
- An optical digital cord (optional) is required to make this connection. Refer to the instruction manual of the MD recorder, etc. for details.
- There is a protective cap on the DIGITAL OUT jack (optical). When making the connection, pull off this cap and store it carefully in a safe place. Should you undo the connection, replace the cap on the jack.

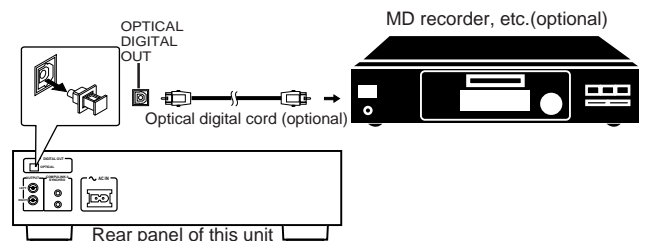

Supplying the power

To connect the AC power cord of the main unit

The AC power cord is supplied separately and must be connected to the unit.

Plug the AC power cord into the AC power cord inlet of this unit and connect to the wall outlet after all connections are complete.

Note

When using the COMPULINK Remote Control System, do not connect the power cord to the SWITCHED AC OUTLET of an amplifier or receiver.

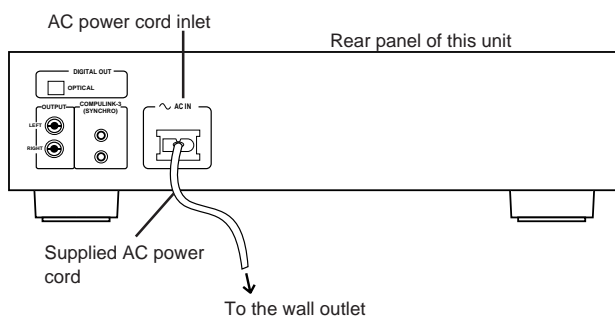

Installing the batteries

(XL-Z232BK Only)

To install the batteries in the remote control unit

Before operating the remote control unit, install two batteries.

1. Remove the rear cover of the remote control unit by pressing down and simultaneously pulling it backwards.

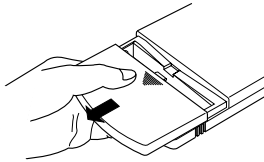

2. Install batteries. Be sure that the batteries are installed with correct polarity, (+) and (-).

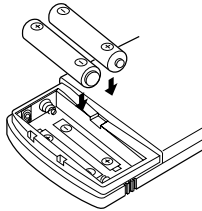

3. Attach the rear cover by sliding it back into position.

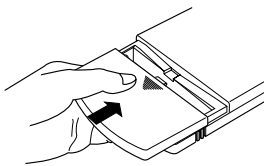

Notes

Incorrect use of batteries can cause corrosion or damage. Note the following points to lengthen battery life.

- Install batteries observing the correct polarity, (+) and (-).
- Do not use new and old batteries simultaneously.
- Batteries with similar shapes may have different voltage ratings. Be sure to use the correct batteries.
- Remove batteries from the remote control unit if it will not be used for a long period of time.
- Do not expose batteries to heat or flame.

Battery replacement

Service life of batteries depends on the condition of use; standard life is about one year. When the batteries become weak, the operating distance of the remote control unit becomes short. If this happens, replace the batteries R03(UM-4)/AAA(24F) with new ones.

Note

- The lower the temperature, the shorter the battery life.

COMPU LINK connection

JVC's COMPU LINK Remote Control System provides unified control over system components connected with COMPU LINK. Connecting JVC audio components with the COMPU LINK jacks automatically controls relative operations between components and facilitates various operations. With the COMPU LINK connection to an amplifier or receiver, you can operate XL-Z132BK/XL-Z232BK with the amplifier or receiver's remote control unit. Synchronized recording is also available with this feature.

Connecting the COMPU LINK cord

The COMPU LINK-3 SYNCHRO jacks are used to output and input the control signal for the COMPU LINK remote control system.

COMPU LINK-compatible products are provided with the jacks marked COMPU LINK-1, COMPU LINK-2 or COMPU LINK-3, referring to the COMPU LINK version. XL-Z132BK/XL-Z232BK is equipped with COMPU LINK-3. You can connect XL-Z132BK/XL-Z232BK also to a component with a lower COMPU LINK versions. But, in that case, only the lower versions' features will be available.

Plug the supplied COMPU LINK cord into the COMPU LINK-3 SYNCHRO jack on the rear panel of XL-Z132BK/XL-Z232BK. Plug the other end into the COMPU LINK jack of the other component. If there are two COMPU LINK jacks, plug it into either of them.

Connect to the COMPU LINK-3 (SYNCHRO) jack of another component equipped with the Compu Link remote control system.

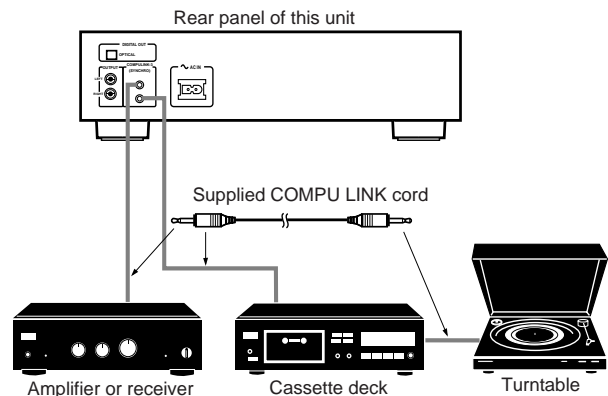

BASIC OPERATIONS

Basic functions for disc playback

Turning on the power of this unit

Press the **POWER** button to turn on this unit. The **STANDBY** indicator is turned off and the display is turned on.

Remote control unit
(XL-Z232BK ONLY)



Main unit

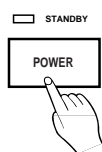

Press again to turn the power off and activate the standby mode. The **STANDBY** indicator is lit.

The power is automatically turned on also by;

- Pressing the **▲ OPEN/CLOSE** button.
- Pressing the **▶** button on the remote control unit or the **▶/|| PLAY/PAUSE** button on the main unit.

Notes

- A small amount of power (4 watts) is consumed even in the standby mode.
- To turn the power off completely, disconnect the power cord from the wall outlet.

Loading a disc in the disc tray

Use the **▲ OPEN/CLOSE** button to open and close the disc tray.

Remote control unit
(XL-Z232BK ONLY)



Main unit



1. Open the disc tray by pressing the **▲ OPEN/CLOSE** button.
2. Place a disc on the disc tray according to the groove with its label side up.
3. Close the disc tray by pressing the **▲ OPEN/CLOSE** button.

Note

- When loading a disc in the disc tray, be sure to put the disc according to the groove. Otherwise, the disc will be damaged when the disc tray is closed, and the disc cannot be removed from the unit.

Good

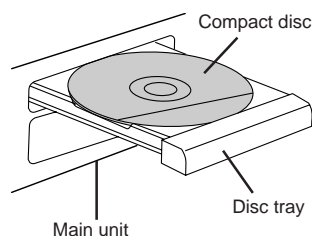

No Good

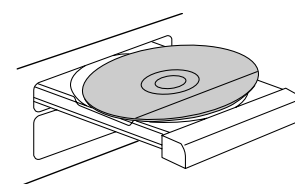

Remote control operation (XL-Z232BK Only)

Point the remote control unit towards the remote sensor and operate it steadily and carefully. The remote control unit can be used within a range of about 7 meters (23 feet) from the remote sensor, and at angles of up to about 30 degrees.

Playing a disc

Press the ► button on the remote control unit or the ►/|| PLAY/PAUSE button on the main unit.

Remote control unit
(XL-Z232BK ONLY)

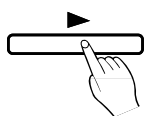

Main unit

PLAY/PAUSE

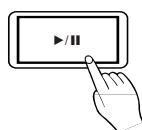

The ► indicator lights on the display and playback starts. When no disc is loaded in the unit, the disc tray opens.

To stop playback temporarily, press the || button on the remote control unit or the ►/|| PLAY/PAUSE button on the main unit.

The || indicator lights on the display and playback stops temporarily. To resume playback, press the ► button on the remote control unit or the ►/|| PLAY/PAUSE button on the main unit.

Stopping playback

Press the ■ button.

Remote control unit
(XL-Z232BK ONLY)

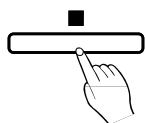

Main unit

STOP/CLEAR

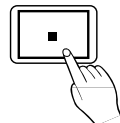

Locating a point to start playback

Skipping to a desired track

Use the ◀◀/▶▶ buttons.

Remote control unit
(XL-Z232BK ONLY)

AUTO SEARCH/CHECK



Main unit

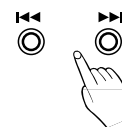

To skip back to the beginning of the track being played, tap the ◀◀ button. When the beginning of the track is reached, tapping this button again skips to the previous track.

To skip to the next track, tap the ▶▶ button.

When using the ◀◀ ▶▶ buttons on the main unit, tap them until the desired track appears.

Skipping to a desired index (XL-Z232BK Only) (for a disc with INDEX)

Use the ←/→ INDEX buttons.

Remote control unit



To skip back to the beginning of the index being played, tap the ← INDEX button. When the beginning of the index is reached, tapping this button again skips to the previous index.

To skip to the next index, tap the → INDEX button.

Displaying the time

Searching for a desired section

Keep the ◀◀/▶▶ SEARCH buttons on the remote control unit or the ◀◀/▶▶ SEARCH buttons on the main unit pressed during playback.

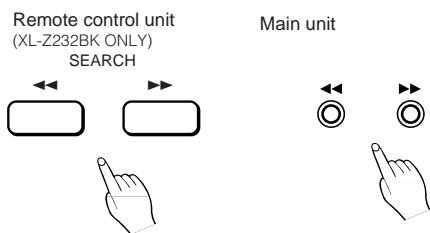

Playback advances or reverses rapidly. While the ◀◀ button is kept pressed, playback rapidly reverses toward the beginning of the track. While the ▶▶ button is kept pressed, playback rapidly advances toward the end of the track. When the desired section is reached, release the button. The player resumes normal playback from that point.

Note
Two speeds are available for fast forward and fast backward. Pressing and holding the button provides the faster speed.

Specifying a desired track

To specify the desired track number, use the numeric keypad (1-10, +10).

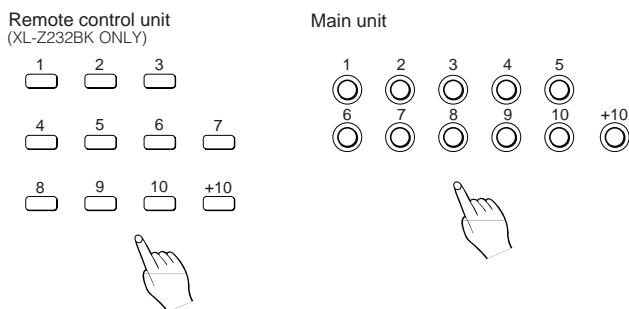

The unit searches for the selected track and playback starts automatically. When selecting track number 10 or less, press the corresponding numeric button. When selecting track number 11 or above, use the [+10] button. Example: To select track number 12, press [+10] and then [2]. To select track number 25, press [+10] twice and then [5]. To select track number 30, press [+10] twice and then [10].

Note
The track number which does not exist on the selected disc, cannot be selected.

Switching the time display on XL-Z232BK

Each time the DISPLAY MODE button is pressed, the time display changes as the following.

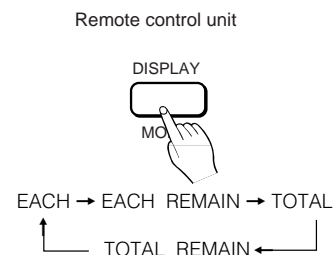

The corresponding indicator lights in each time mode.
EACH: Shows the elapsed time of the track being played.
EACH REMAIN: Shows the remaining playback time of the track being played.
TOTAL: Shows the total playing time of the disc being played.
TOTAL REMAIN: Shows the remaining playback time of the disc being played.

Displaying the time on XL-Z132BK

When the disc is stopped, the XL-Z132BK has the following time displays.

EACH: Shows the elapsed time of the track being played.
EACH REMAIN: Shows the remaining playback time of the track being played.
TOTAL: Shows the total playing time of the disc being played.

VARIOUS PLAYBACK PATTERNS

Playing tracks in a desired order

You can play only the favorite tracks in any desired order.

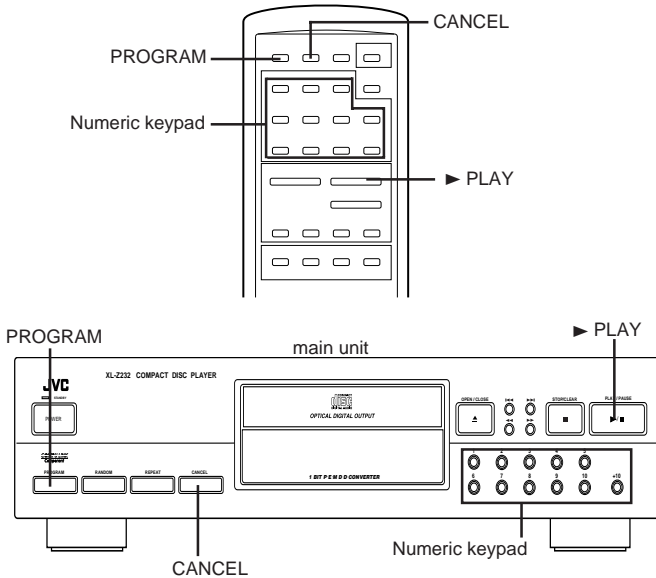

1. In stop mode, press the PROGRAM button so that "PRGM" lights on the display.

2. Select the track number with the numeric keypad.

Refer to "Specifying a desired track" on page 9 for entering the track number.

The selected track number is programmed and the following display appears.

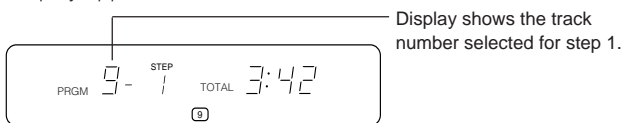

• If you want to cancel the displayed program step, press the CANCEL button and then enter the new track number.

3. Repeat step 2 for other tracks to be programmed.

You can program up to 32 tracks.

4. Start playback by pressing the ► button.

The programmed tracks are played in the programmed order.

- You can skip to a desired program step with the ◀◀ or ▶▶ button.
- You can add tracks in the program during the playback.

To check the program contents

Press the ◀◀ or ▶▶ button during stop mode. Each time the ◀◀ or ▶▶ button is pressed, the program contents are displayed in the programmed order or the reverse order.

To clear the entire program

In stop mode, press the ■ STOP/CLEAR button on the main unit. The program contents will be cleared, however, the program mode is not canceled.

To exit program mode

Press the PROGRAM button again, and the program mode is cancelled.

Playing tracks in a random order

You can select and play tracks in a random order.

Selections are made so that each track in the disc is played only once.

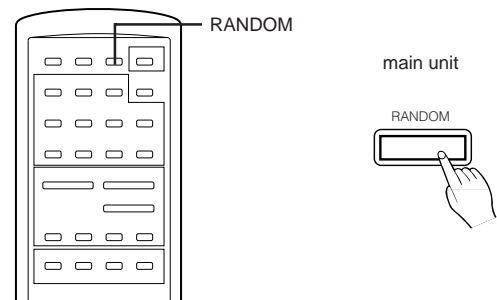

1. Press the RANDOM button so that the "RANDOM" indicator lights on the display.

- To skip to the track to be played next, press the ▶▶ button.

To exit random playback

Press the stop button, and the random mode is cancelled.

Playing repeatedly

*You can repeatedly play the whole disc or one track.
It is also possible to utilize this function in combination with
random/program playback function.*

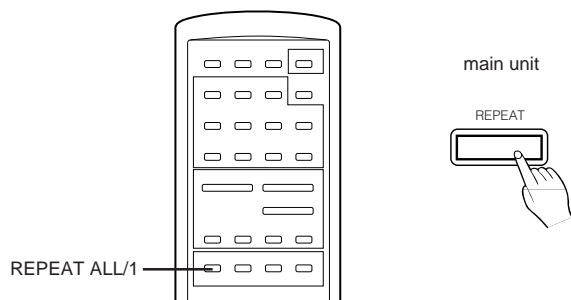

Repeating whole disc

Press the REPEAT (ALL/1) button so that the REPEAT indicator lights on the display.

All tracks are played repeatedly.

Repeating one track

Press the REPEAT (ALL/1) button so that the REPEAT 1 indicator lights on the display.

The displayed track is played repeatedly.

To cancel repeat mode

Press the REPEAT (ALL/1) button so that the REPEAT and REPEAT 1 indicators go out.

GENERAL INFORMATIONS

COMPU LINK remote control system

The COMPU LINK Remote Control System controls relative operations between components automatically and facilitates various operations.

This is a system originated and developed by JVC for facilitating various system operations.
The following is a brief explanation of this system:

Automatic source selection

When the supplied COMPU LINK cord is utilized to connect this unit to others equipped with COMPU LINK jacks, switching-in of each system component can be performed with a single touch on the source selector button located on a JVC amplifier or receiver. When selection is carried out in this manner, the corresponding unit will automatically start operation. Upon pressing of the play button, the source selector of the amplifier or receiver changes automatically. When a new unit is switched in, the previously selected component stops operation within five seconds.

Synchronized recording

Synchronized recording refers to the process in which a JVC cassette deck starts recording, synchronized with this unit. Synchronized recording is carried out as follows:

1. Set the cassette deck to the recording pause mode in accordance with its instructions.
2. To record only certain tracks, program the tracks in any order, as desired.
3. Press the ►/|| PLAY/ PAUSE button on the front panel of this unit. The cassette deck automatically starts recording, synchronized with this unit.

Notes

- Synchronized recording stops automatically when this unit stops playback.
- To cancel synchronized recording, press the ■ STOP button of this unit or the cassette deck.
- To properly operate the synchronized recording, the buttons/controls other than POWER, ■ STOP and OPEN do not function.
- If the recording pause mode is set on the cassette deck by pressing the || PAUSE button after pressing the ● REC and ► PLAY buttons simultaneously, synchronized recording is not possible. For details, refer to the instructions for the cassette deck.

Automatic power on/off function

This function is to control the power on/off of the receiver/amplifier or this unit respectively as the following.

- When this unit enters playback mode, the power of the receiver or amplifier is turned on.
- When the source selector of the receiver/amplifier is set to CD function mode, the power of this unit is turned on.

Notes

- Abnormal operation may result if the power supply of the component(s) is interrupted. If this happens, you must start over again.
- Ensure that the COMPU LINK jacks of the each component are connected with the supplied COMPU LINK cord. Also, be sure to fully read the instructions for each component.
- When the power of the amplifier or receiver is switched off, this unit is also turned off automatically.

Care and handling

How to handle CDs

When handling compact discs, do not touch the surface of the disc (reflective silver side - the side without the label).

Since compact discs are made of plastic, they are easily damaged. If the disc gets dirty, dusty, scratched or warped, the sound will not be picked up correctly and, in addition, such discs may cause the CD player to malfunction.

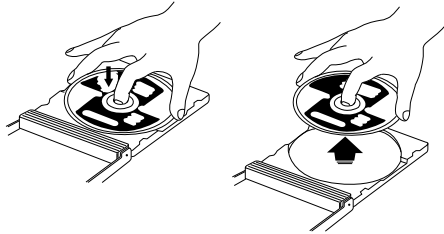

Even on label side

Do not damage the label side, stick paper to or use any adhesive on this surface.

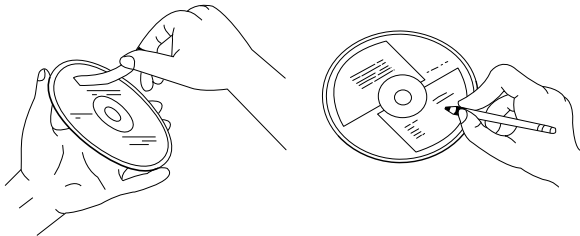

Storage

Make sure that discs are kept in their cases. If discs are piled one on top of another without their protective cases, they can be damaged.

Do not put discs in any location where they can be exposed to direct sunlight - or in any place where humidity or temperature is high. Avoid leaving discs in your car!

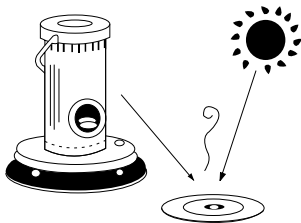

Maintenance of discs

When there are fingerprints or other dirt adhering to a disc, wipe the disc with a soft, dry cloth with a movement going from the inside outwards.

If difficult to clean, wipe the disc with a cloth moistened with water. Never use record cleaners, petrol, alcohol or any anti-static agents.

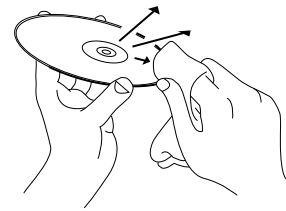

Troubleshooting

What appears to be a malfunction may not always be serious. Please go through the following list before requesting service.

Symptom	Possible cause	Remedy
The unit is not operative.	Power plug is disconnected from the AC outlet.	Connect the plug to an AC outlet.
	The AC power cord plug is disconnected from the AC power cord inlet of this unit.	Connect the plug to an AC power cord inlet.
	Disc is not loaded.	Load a disc in the disc tray.
The remote control unit does not function. (XL-Z232BK only)	Batteries are exhausted.	Replace both batteries.
	There is an obstacle between remote control unit and the remote sensor of the main unit.	Remove the obstacle.
	Direct sunlight shines on the remote sensor of the main unit.	Shade the unit from the direct sunlight.
Playback is not possible.	Disc is inserted upside down.	Load a disc with its label-side up in the disc tray.
	Disc is not loaded in the correct position.	Load the disc according to the groove of the disc tray.
	Moisture is condensed inside the unit.	Leave the unit turned on until the moisture evaporates.
The reproduced sound includes noise.	Disc is dirty.	Wipe off the disc surface with a soft cloth.
	Disc is warped.	Replace the disc with a new one.
The sound is intermittent.	Disc is scratched.	Replace the disc with a new one.

Specifications

General

System:	Compact disc player
Signal detection system:	Non-contact optical system
Sampling frequency:	44.1 kHz
Power requirements:	AC120V~, 60Hz
Power consumption:	10 watts (POWER ON) 4 watts (STANDBY)
Dimensions (W x H x D):	435 x 101 x 281 mm 17-3/16 x 4 x 11-1/8 inches
Mass:	3.3 kg (10.8 lbs)

Audio performance

Frequency response:	2 Hz to 20,000 Hz (±1 dB)
Dynamic range:	More than 98 dB (at 1 kHz)
Signal to noise ratio:	More than 106 dB
Total harmonic distortion:	Less than 0.0025% (at 1 kHz)
Channel separation:	More than 94 dB (at 1 kHz)
Wow and flutter:	Less than measurable limit
Output level	2.0Vrms (at 10 kohms)

Accessories

Remote control unit (RM-SX230U)(XL-Z232BK only)	1
Battery R03(UM-4)/AAA(24F) (XL-Z232BK only)	2
Audio cord	1
COMPU LINK cord	1
AC POWER cord	1

Design and specifications subject to change without notice.

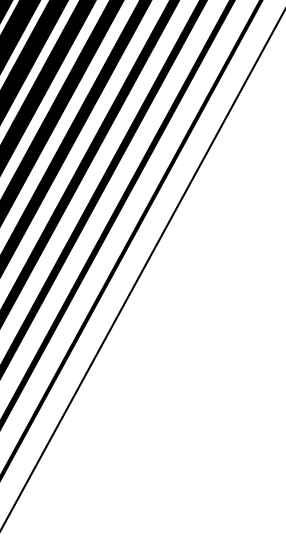

Free Manuals Download Website

<http://myh66.com>

<http://usermanuals.us>

<http://www.somanuals.com>

<http://www.4manuals.cc>

<http://www.manual-lib.com>

<http://www.404manual.com>

<http://www.luxmanual.com>

<http://aubethermostatmanual.com>

Golf course search by state

<http://golfingnear.com>

Email search by domain

<http://emailbydomain.com>

Auto manuals search

<http://auto.somanuals.com>

TV manuals search

<http://tv.somanuals.com>