

JVC



COMPACT COMPONENT SYSTEM

KOMPACTES KOMPONENTENSYSYEM
SYSTEME DE COMPOSANTS COMPACT
KOMPACTO KOMPONENTEN-SYSTEEM
SISTEMA DE COMPONENTES COMPACT
IMPIANTO A COMPONENTI COMPATTO

CA-TD77R

Consists of RX-TD77R and XT-TD77R.
Besteht aus RX-TD77R und XT-TD77R.
Comprenant le RX-TD77R et le XT-TD77R.
Bestaat uit RX-TD77R en XT-TD77R.
Consta del RX-TD77R y el XT-TD77R.
Dotato di RX-TD77R e XT-TD77R.

RX-TD77R

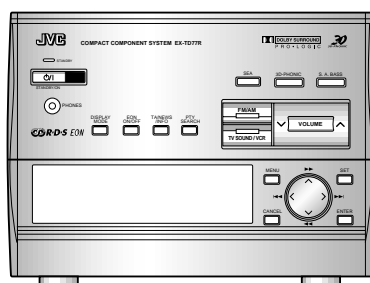

COMPACT
disc
DIGITAL AUDIO

R-D-S EON



XT-TD77R

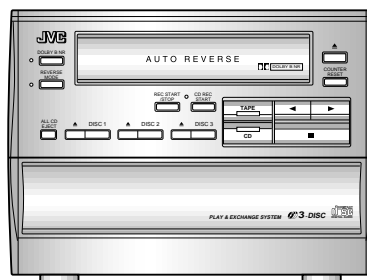

INSTRUCTIONS
BEDIENUNGSANLEITUNG
MANUEL D'INSTRUCTIONS
GEBRUIKSAANWIJZING
MANUAL DE INSTRUCCIONES
ISTRUZIONI

For Customer Use:

Enter below the Model No. and Serial No. which are located either on the rear, bottom or side of the cabinet. Retain this information for future reference.

Model No. _____

Serial No. _____

E30580-2602A
[EF, G]

Warnings, Cautions and Others / Warnung, Achtung und sonstige Hinweise / Mises en garde, précautions et indications diverses / Waarschuwingen, voorzorgen en andere mededelingen / Avisos, precauciones y otras notas / Avvertenze e precauzioni da osservare

IMPORTANT for the U.K.

DO NOT cut off the mains plug from this equipment. If the plug fitted is not suitable for the power points in your home or the cable is too short to reach a power point, then obtain an appropriate safety approved extension lead or consult your dealer.

BE SURE to replace the fuse only with an identical approved type, as originally fitted.

If nonetheless the mains plug is cut off ensure to remove the fuse and dispose of the plug immediately, to avoid a possible shock hazard by inadvertent connection to the mains supply.

If this product is not supplied fitted with a mains plug then follow the instructions given below:

IMPORTANT:

DO NOT make any connection to the terminal which is marked with the letter E or by the safety earth symbol or coloured green or green-and-yellow.

The wires in the mains lead on this product are coloured in accordance with the following code:

Blue : Neutral
Brown : Live

As these colours may not correspond with the coloured markings identifying the terminals in your plug proceed as follows:

The wire which is coloured blue must be connected to the terminal which is marked with the letter N or coloured black.

The wire which is coloured brown must be connected to the terminal which is marked with the letter L or coloured red.

IF IN DOUBT - CONSULT A COMPETENT ELECTRICIAN.

Caution — POWER switch!

Disconnect the mains plug to shut the power off completely. The POWER switch in any position does not disconnect the mains line. The power can be remote controlled.

Achtung — POWER-Schalter!

Den Netzstecker aus der Steckdose ziehen, um die Stromversorgung vollkommen zu unterbrechen. Der Schalter POWER unterbricht in keiner Stellung die Stromversorgung vollkommen. Die Stromversorgung kann mit der Fernbedienung ein- und ausgeschaltet werden.

Attention — Commutateur POWER!

Déconnecter la fiche de secteur pour couper complètement le courant. Le commutateur POWER ne coupe jamais complètement la ligne de secteur, quelle que soit sa position. Le courant peut être télécommandé.

Opgelet — POWER schakelaar!

Om de stroomtoevoer geheel uit te schakelen, trekt u de stekker uit het stopcontact. Anders zal er altijd een geringe hoeveelheid stroom naar het apparaat lopen, ongeacht de stand van de POWER schakelaar. U kunt het apparaat ook met de afstandsbediening aan- en uitschakelen.

¡Atención — Interruptor POWER!

Desconectar el cable de alimentación para desactivar la alimentación totalmente. Cualquier que sea la posición de ajuste del interruptor POWER, la alimentación no es cortada completamente. La alimentación puede ser controlada remotamente.

Attenzione — L'interruttore POWER!

Disinserire la spina del cavo di alimentazione dalla presa della rete elettrica per staccare completamente l'alimentazione. L'interruttore POWER in nessuna posizione stacca la linea di alimentazione elettrica principale. È possibile il controllo remoto dell'alimentazione.

Per l'Italia:

"Si dichiara che il questo prodotto di marca JVC è conforme alle prescrizioni del Decreto Ministeriale n.548 del 28/08/95 pubblicato sulla Gazzetta Ufficiale della Repubblica Italiana n.301 del 28/12/95."

CAUTION

To reduce the risk of electrical shocks, fire, etc.:

1. Do not remove screws, covers or cabinet.
2. Do not expose this appliance to rain or moisture.

ACHTUNG

Zur Verhinderung von elektrischen Schlägen, Brandgefahr, usw.:

1. Keine Schrauben lösen oder Abdeckungen entfernen und das Gehäuse nicht öffnen.
2. Dieses Gerät weder Regen noch Feuchtigkeit aussetzen.

ATTENTION

Afin d'éviter tout risque d'électrocution, d'incendie, etc.:

1. Ne pas enlever les vis ni les panneaux et ne pas ouvrir le coffret de l'appareil.
2. Ne pas exposer l'appareil à la pluie ni à l'humidité.

VOORZICHTIG

Ter vermindering van gevaar voor brand, elektrische schokken, enz.:

1. Verwijder geen schroeven, panelen of de behuizing.
2. Stel het toestel niet bloot aan regen of vocht.

PRECAUCIÓN

Para reducir riesgos de choques eléctricos, incendio, etc.:

1. No extraiga los tornillos, los cubiertas ni la caja.
2. No exponga este aparato a la lluvia o a la humedad.

ATTENZIONE

Per ridurre il rischio di shock elettrici, incendi, ecc.:

1. Non togliete viti, coperchi o la scatola.
2. Non esponete l'apparecchio alla pioggia e all'umidità.

Caution: Proper Ventilation

To avoid risk of electric shock and fire, and to prevent damage, locate the apparatus as follows:

- 1 Front:
No obstructions and open spacing.
- 2 Sides/ Top/ Back:
No obstructions should be placed in the areas shown by the dimensions below.
- 3 Bottom:
Place on the level surface. Maintain an adequate air path for ventilation by placing on a stand with a height of 10 cm or more.

Vorsicht: Ausreichende Belüftung

Zur Vermeidung von elektrischen Schlägen, Feuer und sonstigen Schäden sollte das Gerät unter folgenden Bedingungen aufgestellt werden:

- 1 Vorderseite:
Hindernisfrei und gut zugänglich.
- 2 Seiten- und Rückwände:
Hindernisfrei in allen gegebenen Abständen (s. Abbildung).
- 3 Unterseite:
Die Stellfläche muß absolut eben sein. Sorgen Sie für ausreichende Luftzufuhr durch Aufstellung auf einem Stand mit mindestens 10 cm Höhe.

Attention: Aération correcte

Pour prévenir tout risque de décharge électrique ou d'incendie et éviter toute détérioration, installez l'appareil de la manière suivante:

- 1 Avant:
Bien dégagé de tout objet.
- 2 Côtés/dessus/dessous:
Assurez-vous que rien ne bloque les espaces indiqués sur le schéma ci-dessous.
- 3 Dessous:
Posez l'appareil sur une surface plane et horizontale. Veillez à ce que sa ventilation correcte puisse se faire en le plaçant sur un support d'au moins dix centimètres de hauteur.

Voorzichtig: Goede ventilatie vereist

Om brand, elektrische schokken en beschadiging te voorkomen, moet u het toestel als volgt opstellen:

- 1 Voorkant:
Geen belemmeringen en voldoende ruimte.
- 2 Zijkanten/boven-/onderkant:
Geen belemmeringen plaatsen in de hieronder aangegeven zones.
- 3 Onderkant:
Op vlakke ondergrond plaatsen. Voldoende ventilatieruimte voorzien door het toestel op een onderstel met een hoogte van 10 cm of meer te plaatsen.

Precaucion: ventilación correcta

Para evitar el riesgo de descargas eléctricas e incendio y prevenir posibles daños, instale el equipo en un lugar que cumpla los siguientes requisitos:

- 1 Parte frontal:
Sin obstrucciones, espacio abierto.
- 2 Lados/parte superior/parte posterior:
No debe haber ninguna obstrucción en las áreas mostradas por las dimensiones de la siguiente figura.
- 3 Parte inferior:
Sitúe el equipo sobre una superficie nivelada. Mantenga un espacio adecuado para permitir el paso del aire y una correcta ventilación, situando el equipo sobre un soporte de 10 o más cm de altura.

Attenzione: Per una corretta ventilazione

Per prevenire il rischio di scosse elettriche e di incendio ed evitare possibili danni, collocare le apparecchiature nel modo seguente:

- 1 Parte anteriore:
Nessun ostacolo e spazio libero.
- 2 Lati/Parte superiore/Retro:
Lasciare libere le zone indicate dalle dimensioni di seguito.
- 3 Base:
Collocare su una superficie piana. Consentire un'adeguata ventilazione dell'impianto appoggiandolo su un tavolino alto almeno 10 cm.

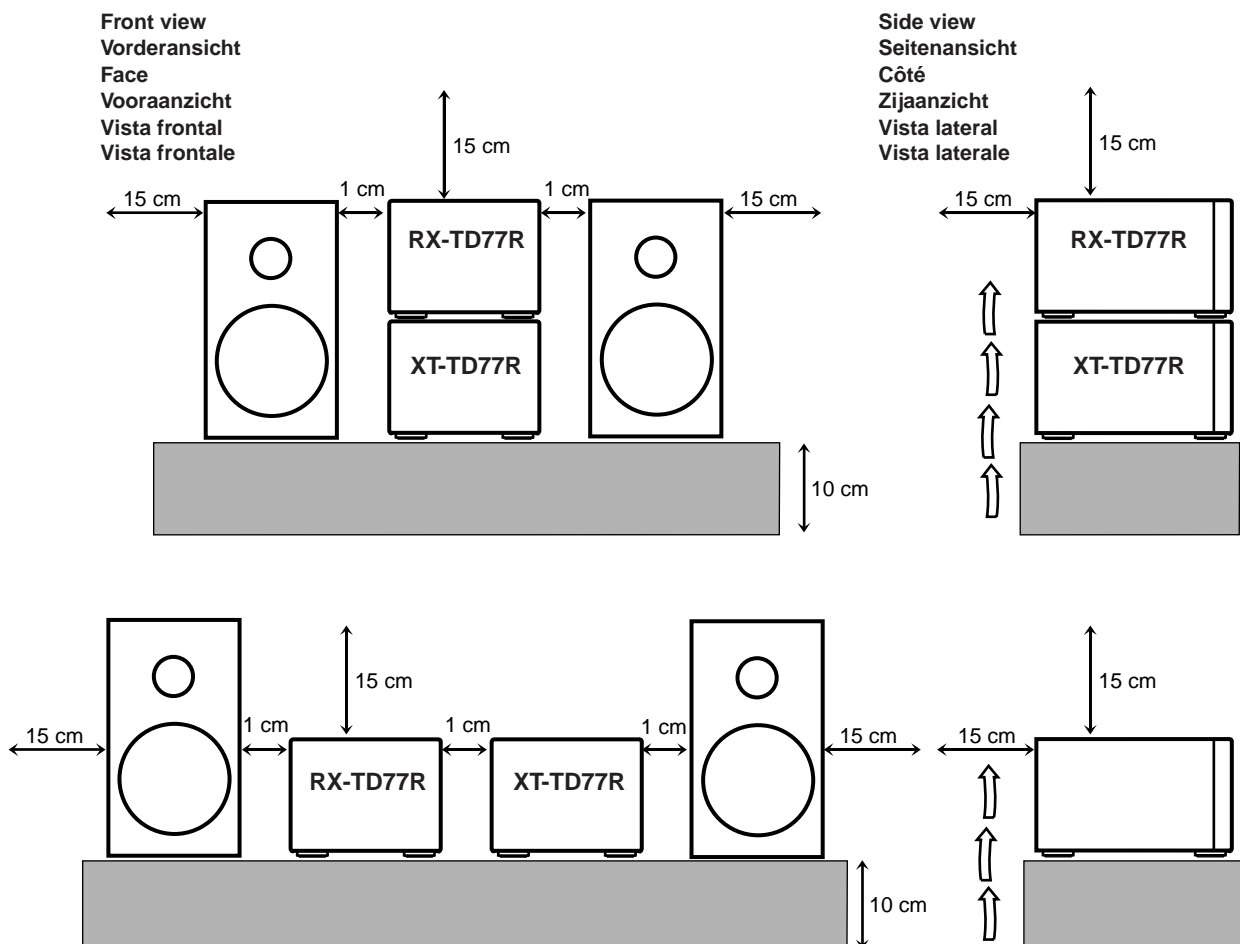

REPRODUCTION OF LABELS/ANBRINGUNGSORTE FÜR LASER-PRODUKTE/REPRODUCTION DES ETIQUETTES/ VERKLARING VAN DE LABELS/REPRODUCCIÓN DE ETIQUETAS/RIPRODUZIONE DELLE ETICHETTE

- ① CLASSIFICATION LABEL, PLACED ON REAR ENCLOSURE
- ① KLASSIFIKATIONSETIKETTE AN DER RÜCKSEITE
- ① ETIQUETTE DE CLASSIFICATION, PLACÉE A L'ARRIÈRE DU COFFRET
- ① KLASSIFIKATIELABEL, OP DE ACHTERZIJDE VAN HET APPARAAT
- ① ETIQUETA DE CLASIFICACIÓN, PEGADA EN LA PARTE POSTERIOR DE LA CAJA
- ① ETICHETTA DI CLASSIFICAZIONE, SITUATA SUL RIVESTIMENTO POSTERIORE
- ② WARNING LABEL, PLACED INSIDE THE UNIT
- ② WARNETIKETTE IM GERÄTEINNEREN
- ② ETIQUETTE D'AVERTISSEMENT PLACÉE À L'INTERIEUR DE L'APPAREIL
- ② WAARSCHUWINGSLABEL, IN HET APPARAAT
- ② ETIQUETA DE ADVERTENCIA, PEGADA EN EL INTERIOR DE LA UNIDAD
- ② ETICHETTA DI AVVERTENZA, SITUATA ALL'INTERNO DELL'APPARECCHIO

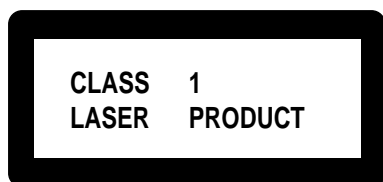

DANGER: Invisible laser radiation when open and interlock failed or defeated. AVOID DIRECT EXPOSURE TO BEAM. (e)	WARNING: Osynlig laserstråling når denna del är öppnad och spärren är urkopplad. Betrakta ej strålen. (s)
ADVARSEL: Usynlig laserstråling ved åbning, når sikkerhedsafbrydere er ude af funktion. Undgå udsættelse for stråling (d)	VARO: Avattaessa ja suojalukitus ohitettaessa olet alltiina näkymättömälle lasersäteilylle. Älä katso säteeseen. (f)

- 1. CLASS 1 LASER PRODUCT
- 2. **DANGER:** Invisible laser radiation when open and interlock failed or defeated. Avoid direct exposure to beam.
- 3. **CAUTION:** Do not open the top cover. There are no user serviceable parts inside the Unit; leave all servicing to qualified service personnel.

- 1. LASER-PRODUKT DER KLASSE 1
- 2. **GEFAHR:** Unsichtbare Laserstrahlung bei Öffnung und fehlerhafter oder beschädigter Spre. Direkten Kontakt mit dem Strahl vermeiden!
- 3. **ACHTUNG:** Das Gehäuse nicht öffnen. Das Gerät enthält keinerlei Teile, die vom Benutzer gewartet werden können. Überlassen Sie Wartungsarbeiten bitte qualifizierten Kundendienst-Fachleuten.

- 1. PRODUIT LASER CLASSE 1
- 2. **ATTENTION:** Radiation laser invisible quand l'appareil est ouvert ou que le verrouillage est en panne ou désactivé. Eviter une exposition directe au rayon.
- 3. **ATTENTION:** Ne pas ouvrir le couvercle du dessus. Il n'y a aucune pièce utilisable à l'intérieur. Laisser à un personnel qualifié le soin de réparer votre appareil.

- 1. KLAS 1 LASERPRODUKT
- 2. **GEVAARLIJK:** Onzichtbare laserstraling wanneer open en de beveiliging faalt of uitgeschakeld is. Voorkom het direct blootstaan aan de straal.
- 3. **VOORZICHTIG:** De bovenkap niet openen. Binnenin het toestel bevinden zich geen door de gebruiker te repareren onderdelen: laat onderhoud over aan bekwaam vakpersoneel.

- 1. PRODUCTO LASER CLASE 1
- 2. **PELIGRO:** En el interior hay radiación láser invisible. Evite el contacto directo con el haz.
- 3. **PRECAUCION:** No abra la tapa superior. En el interior de la unidad no existen piezas reparables por el usuario; deje todo servicio técnico en manos de personal calificado.

- 1. PRODOTTO LASER CLASSE 1
- 2. **PERICOLO:** Radiazione laser invisibile quando l'apparecchio è aperto ed il dispositivo di sicurezza è guasto o disattivato. Evitare l'esposizione diretta ai raggi.
- 3. **ATTENZIONE:** Non aprire il coperchio superiore. Non vi sono parti adoperabili dall'utente all'interno di questo apparecchio; lasciare tutti i controlli a personale qualificato.

Thank you for purchasing the JVC Compact Component System.
We hope it will be a valued addition to your home, giving you years of enjoyment.
Be sure to read this instruction manual carefully before operating your new stereo system.
Here you will find all the information you need to set up and use the system.
For questions that are not answered in the manual, please contact your dealer.

Features

Here are some of the things that make your System powerful and easy to use.

- The controls and operations have been redesigned to make them very easy to use so you can spend your time listening to music.
 - With the One Touch Operation feature of JVC's COMPU PLAY you can turn on the System and start the radio, the Cassette Deck, or the CD Player with a single touch.
- The three types of surround modes including JVC's 3D PHONIC which allows you a nearly surround effect with only two front speakers.
- To get such great sound from such a compact package the System has:
 - Programmed sound mode includes live surround effects D. CLUB, HALL, and STADIUM. It also includes S.E.A (Sound Effect Amplifier) effects ROCK, POP, and CLASSIC. You can also register up to three customized settings.
- The System is compatible with RDS (Radio Data System) broadcasting.
 - The EON data enables you to standby for desired information.
 - The PTY Search function searches for programmes in the category you wish.
 In addition, Radio Text can be displayed using data sent by station.
- CD changer function can operate 3 discs.
 - Discs can be changed during play using the TRIPLE TRAY.
 - Continuous, random or program play of 3 discs.
- The three timers, DAILY Timer, ONCE REC (Recording) Timer, and SLEEP Timer are extremely easy to set.
- The Displays are large and clear. They are organized so you can tell at a glance what's happening because functions light up as you use them, and blink to tell you they are ready. They provide some important messages like "NO DISC", and other informations.



How This Manual Is Organized

In this manual we have incorporated some special features:

- Basic information that is the same for many different functions is grouped in one place, and not repeated in each procedure. For instance, in the section on playing a CD, we do not repeat the information about setting the volume and the sound conditions, which are discussed in the Common Operations section.
- Name of buttons and controls are written in all capital letters like this: VOLUME.
- When we are talking about the Function, rather than the BUTTON or DISPLAY, only the first letter is capitalized.

The manual has a table of contents to help you quickly look up what you want to know.

We've enjoyed making this manual for you, and hope you will use it to enjoy the sound and many features built into your System.

IMPORTANT CAUTIONS

Installation of the Unit

- Select a place which is level, dry and neither too hot nor too cold. (Between 5°C and 35°C or 41°F and 95°F.)
- Leave sufficient distance between the Unit and a TV.
- Do not use the Unit in a place subject to vibrations.

Power cord

- Do not handle the power cord with wet hands!
- Some power (12 watts) is always consumed as long as the power cord is connected to the wall outlet.
- When unplugging the Unit from the wall outlet, always pull the plug, not the power cord.

Malfunctions, etc.

- There are no user serviceable parts inside. If anything goes wrong, unplug the power cord and consult your dealer.
- Do not insert any metallic object into the Unit.

Table of Contents

Features	1	Using the CD Player	26
How This Manual Is Organized	1	The Quickest Way To Start a CD Is With the	
IMPORTANT CAUTIONS	1	One Touch Operation	27
Getting Started	3	Basics of Using the CD Player — Continuous Play	27
Accessories	3	To Insert Discs	27
How To Put Batteries In the Remote Control	3	To Play a Disc	29
Using the Remote Control	3	To Change Discs While Playing	29
Connecting the System Control Cord	4	To Select a Track	29
Connecting the External Wire	4	To Select a Passage Within a Track	30
Connecting the FM Antenna	5	Locating a Track With the Remote Control Directly	30
Connecting the AM (MW/LW) Antenna	5	Programming the Playing Order of the Tracks	30
Connecting the Speakers	6	To Check the Program	32
For Dolby Pro Logic Reproduction	6	To Modify the Program	32
Connecting a VCR	7	Random Play	32
Connecting a TV	7	Repeating a Track or the Discs	33
Connecting the MD Player	7	Tray Lock Function	34
COMPU PLAY	8	Locking the Electronic Lock	34
Setting the Clock	8	Unlocking the Electronic Lock	34
Adjusting the Brightness of the Display	9	Using the Cassette Deck (Listening to a Tape) ..	35
Common Operations	10	One Touch Play	35
Turning the Power On and Off	10	Regular Play	36
Turning the System On	10	Tape Direction Indicator and the Display	36
Turning the System Off	10	Fast Forward and Rewind	37
Adjusting the Volume	11	Music Scan	37
FADE MUTING Function	11	Other Useful Features of the Cassette Deck	37
Balance adjustment	11	Reverse Mode	37
Reinforcing the Bass Sound	11	DOLBY B NR	37
S.E.A. Mode	12	To Control the Cassette Deck While Another Source is	
Selecting a S.E.A. Effect Mode	12	being Played	37
Customizing a S.E.A. Effect Mode	12	Using the Cassette Deck (Recording)	38
Using the Surround Processor	14	Things To Know Before You Start Recording	38
On JVC's 3D-PHONIC Mode	14	Standard Recording	39
On DAP Mode	14	To Record Any Sound Source To Tape	39
On Dolby Pro Logic Mode	14	Checking the Tape Counter While Recording	39
Playing the Source Using the 3D-PHONIC Modes	15	How to create a blank section on the tape	39
Playing the Source Using the DAP Modes	16	CD Direct Recording	40
Playing the Source Using Dolby Pro Logic Mode	17	Auto Edit Recording	40
Preparing the Dolby Pro Logic Reproduction	17	Using the Timer	42
Getting Ready to Use Dolby Pro Logic	17	Setting the DAILY Timer	42
Using the Dolby Pro Logic	19	Turning the DAILY Timer On and Off	44
Using the Tuner	20	Setting the ONCE REC (Recording) Timer	45
One Touch Radio	20	Turning the ONCE REC Timer On and Off	46
Tuning In a Station	20	Setting the SLEEP Timer	47
Switching between Frequency Bands	20	Timer Priority	47
Selecting a radio station	21	Using the VCR	48
To Change the FM Reception Mode	21	Operating a JVC VCR or TV	48
Presetting Stations	21	Listening to a JVC VCR	49
Receiving FM Stations with RDS	22	Recording to a JVC VCR	49
What Information RDS can Provide	22	Operating a JVC TV	49
Changing the Display	23	Operating a VCR other than JVC's VCR	49
Searching for Programmes by PTY codes	23	Listening to a VCR	49
EON Function	24	Recording of a VCR	49
ALARM function	25	Care And Maintenance	50
		Troubleshooting	51
		Specifications	52

Getting Started

Accessories

Check that you have all of the following items, which are supplied with the System.

- AM (MW/LW) Loop Antenna (1)
- Remote Control (1)
- Batteries (2)
- FM Wire Antenna (1)
- External Wire (1)

If any of these items is missing, contact your dealer immediately.

How To Put Batteries In the Remote Control

Match the polarity (+ and -) on the batteries with the + and - markings in the battery compartment.

R6P(SUM-3)/AA(15F)

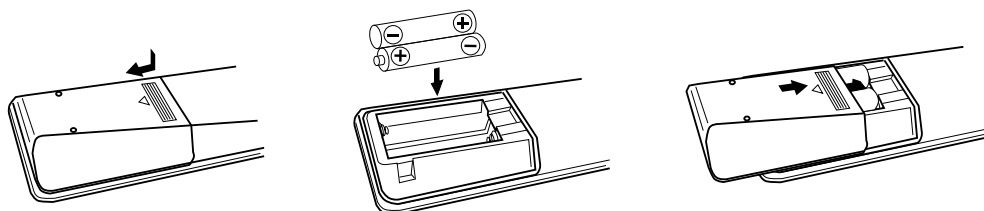

CAUTION: Handle batteries properly.

To avoid battery leakage or explosion:

- Remove batteries when the Remote Control will not be used for a long time.
- When you need to replace the batteries, replace both batteries at the same time with new ones.
- Don't use an old battery with a new one.
- Don't use different types of batteries together.

Using the Remote Control

The Remote Control makes it easy to use many of the functions of the System from a distance of up to 7m (23 feet) away.

You need to point the Remote Control at the remote sensor on the System's front panel.

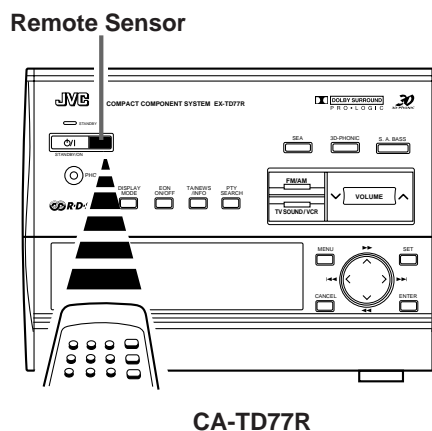

CA-TD77R

CAUTION: Make all connections before plugging the Unit into an AC power outlet.

Connecting the FM Antenna

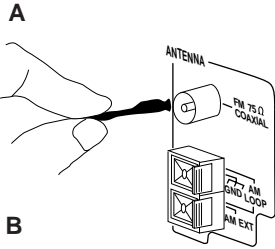

A. Using the Supplied Wire Antenna

The FM Wire Antenna provided can be connected to a FM 75-ohm COAXIAL as temporary measure.

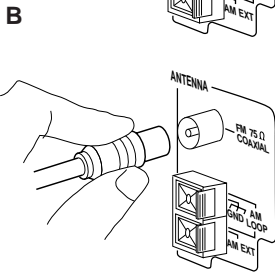

B. Using the Coaxial Type Connector (Not Supplied)

A 75-ohm antenna with coaxial type connector (IEC or DIN 45325) should be connected to the FM 75-ohm COAXIAL terminal.

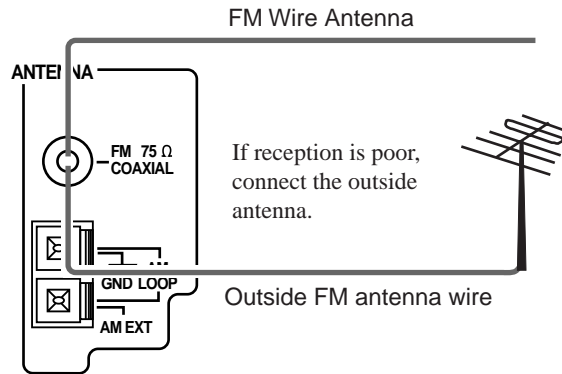

Before attaching a 75 ohm coaxial lead (the kind with a round wire going to an outside antenna), disconnect the supplied FM Wire Antenna.

CAUTION: To avoid noise, keep antennas away from metallic parts of the System, connecting cord and the AC power cord.

Connecting the AM (MW/LW) Antenna

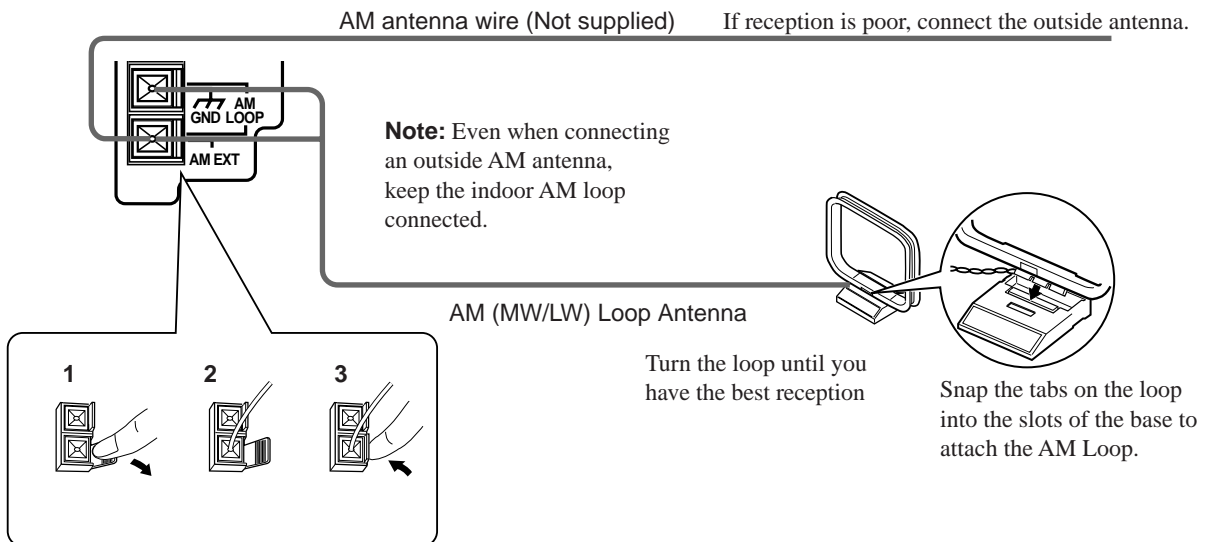

CAUTION: Make all connections before plugging the Unit into an AC power outlet.

Connecting the Speakers

■ Please refer to instructions for speakers as well when you connect speakers.

For each speaker connect one end of the speaker wire to the speaker terminals on the back of the System and one end to the speaker.

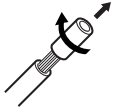

- 1. Open each terminal.**
- 2. Insert the end of the speaker wire as shown (be sure to remove the insulation at the end of each wire first.).**
- 3. Close the terminals to clamp the speaker wires firmly in place.**

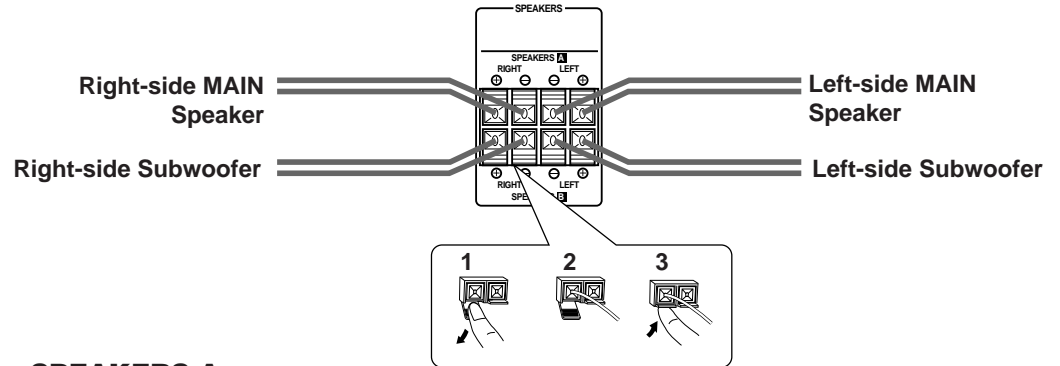

SPEAKERS A

Connect the MAIN Speakers to the SPEAKERS A terminal on the rear panel as follows.

Connect the gray (+) and the blue (-) terminals of the right-side MAIN Speaker to the gray (+) and blue (-) terminals marked RIGHT on the rear panel.

Connect the gray (+) and the blue (-) terminals of the left-side MAIN Speaker to the gray (+) and blue (-) terminals marked LEFT on the rear panel.

SPEAKERS B

Connect the Subwoofers to the SPEAKERS B terminal on the rear panel as follows.

Connect the red (+) and black (-) terminals of the right-side Subwoofer to the red (+) and black (-) terminals marked RIGHT on the rear panel.

Connect the red (+) and black (-) terminals of the left-side Subwoofer to the red (+) and black (-) terminals marked LEFT on the rear panel.

IMPORTANT: Use speakers with the correct impedance only. The correct impedance is indicated on the back panel.

CAUTION: If a TV is installed near speakers, the TV may display irregular colours. In this case, set the speakers away from the TV.

For Dolby Pro Logic Reproduction

For Dolby Pro Logic reproduction, you need a center speaker, two rear speakers, and two amplifiers (for connecting the center and rear speakers).

Connection:

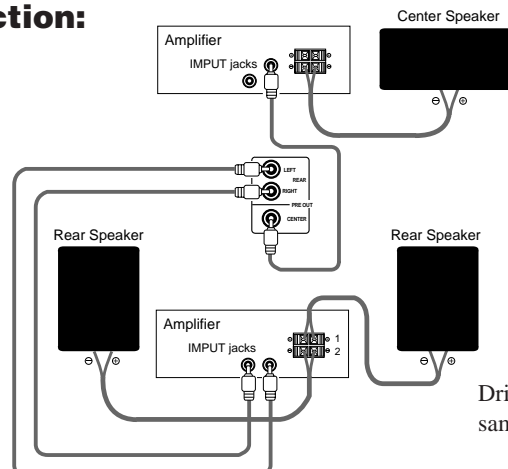

Drive speaker outputs 1 and 2 at the same time.

Connecting a VCR

Connect the VCR to the VCR terminal.

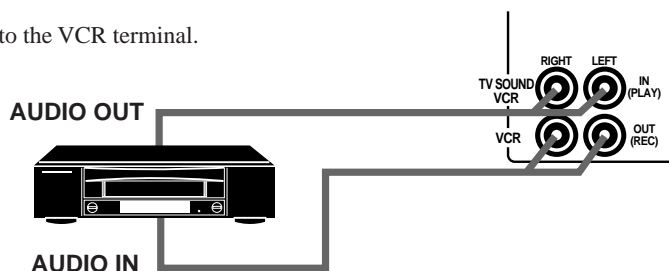

Connecting a TV

Connect a TV to the TV SOUND input terminals.

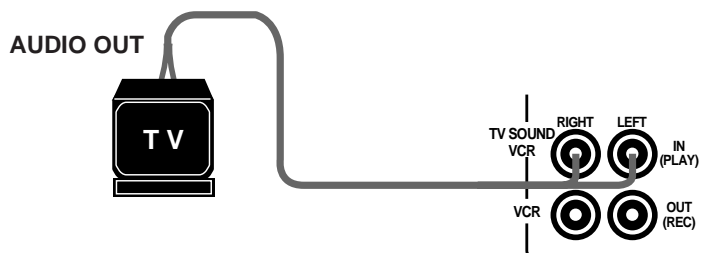

Connecting the MD Player

You can use a digital fiber-optic cable to connect the MD Player for recording CDs. Remove the cap from the DIGITAL OUT OPTICAL terminal and connect the digital fiber-optical cable. (Not supplied.)

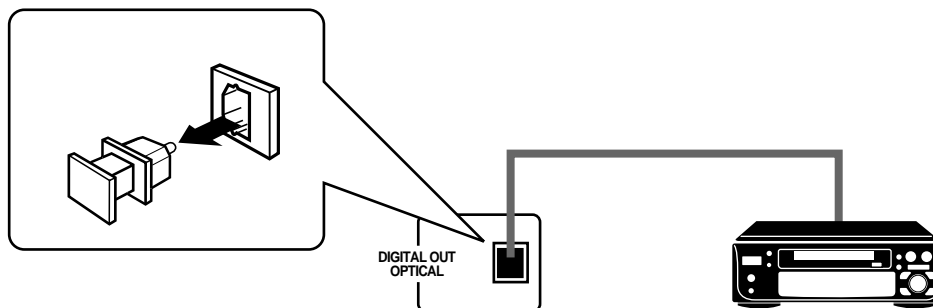

Now you can plug the AC power cord into the wall outlet, and your System is at your command!

COMPU PLAY

COMPU PLAY is JVC's feature that lets you control the most frequently used functions of the System with a single touch.

One Touch Operation starts playing a CD, turns on the radio, plays a tape, etc. with a single press of the play button for that function. What One Touch Operation does for you is to turn the power on, then start the function you have specified. If the Unit is not ready, such as no CD or tape in place, the Unit still powers on so you can insert a CD or tape.

How One Touch Operation works in each case is explained in the section dealing with that function. The COMPU PLAY buttons are:

On the Unit

- FM/AM button
- VCR button
- TAPE button
- CD button
- CD Player DISC 1 to DISC 3 buttons
- CD Player Open/Close (▲) buttons
- CD Player ALL CD EJECT button
- Cassette Deck Open/Close (▲) button

On the Remote Control

- DISC 1 to DISC 3 buttons
- VCR button
- TAPE button
- TUNER button
- CD button

Setting the Clock

The clock should be set before you start using this Unit.

If the clock has not been set, "0:00" appears in the display and the CLOCK indicator blinks.

You can set the clock regardless of whether the Unit is on or off.

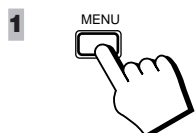

1. Press the MENU button.

"DAILY" blinks on the display and the TIMER selection indicator lights up.

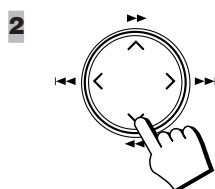
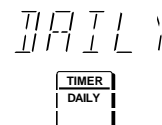

2. Press the ▾ ◀ cursor key twice to select "CLOCK".

"CLOCK ADJ" blinks on the display.

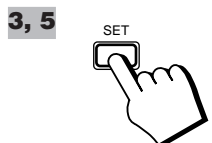

3. Press the SET button.

The hour digits on the display blink.

4. Set the hour by pressing the ◀◀◀ or ▶▶▶ cursor key.

Pressing the ▶▶▶ cursor key increases the hour, and pressing the ◀◀◀ cursor key decreases it.

Pressing down either of these cursor keys adjusts the setting continuously until the key is released.

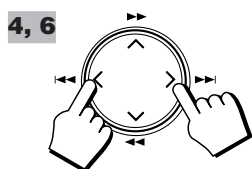
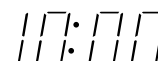

5. Press the SET button.

The minute digits on the display blink.

6. Set the minute by pressing the ◀◀◀ or ▶▶▶ cursor key.

Pressing the ▶▶▶ cursor key increases the minute, and pressing the ◀◀◀ cursor key decreases it.

Holding down either of these cursor keys allows you to continuously adjust the minute setting in 10 minute increments until the key is released.

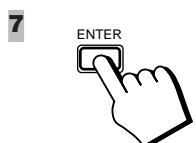
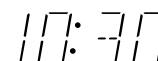

7. Press the ENTER button.

"CLOCK OK" appears on the display and the blinking "CLOCK" indicator disappears. The clock time starts from zero seconds from the set time.

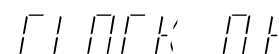

**To correct a mistake:**

- Repeat the procedure from step 1 after pressing the ENTER key.
- To correct a setting during the procedure, press the CANCEL key to go back to the previous setting item.

Note: If you try to select DAILY or REC without first setting the clock, "CLOCK" and "ADJUST" are displayed alternately on the display, and you will be unable to set the timers.

CAUTION: If there is a power failure, the clock loses its setting. The display shows "0:00", and the clock must be reset.

Adjusting the Brightness of the Display

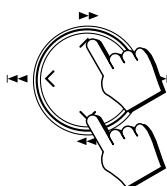

In Standby mode you can adjust the brightness of the clock display.

Press the ►► ^ cursor key to make the display brighter.

Press the ▼◄◄ cursor key to make the display darker.

Adjusting the Volume

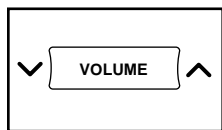

Using the Unit

To increase the volume, press the right side of the VOLUME button \blacktriangle . To decrease the volume, press the left side of the VOLUME button \blacktriangledown .

Using the Remote Control

To increase the volume, press the up side of the VOLUME button \blacktriangle . To decrease the volume, press the down side of the VOLUME button \blacktriangledown .

- Press the button in steps to adjust the volume level one step at a time, press the button continuously to adjust the level continuously.
- You can adjust the volume level between 0 and 50.
- When the System is turned on from Standby mode, the volume is set to 0 and automatically increases to the previous volume level. To stop this automatic volume adjustment, press the VOLUME button.

For private listening

Connect a pair of headphones to the PHONES jack. No sound comes out of the speakers. Be sure to turn down the volume before connecting or putting on headphones.



FADE MUTING Function

Set the Volume Level to 0 by pressing the FADE MUTING button on the Remote Control. Press this button again to restore the Volume Level to its previous level.

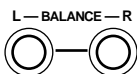

Balance adjustment

You can use the Remote Control to adjust the left and right balance of the speakers.

Press the L - BALANCE - R buttons.

The display changes to show the balance adjustment.

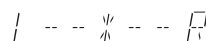

Pressing the L button moves the pointer to the left, pressing the R button moves the pointer to the right. Holding a button down, moves the pointer continuously.

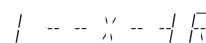
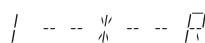
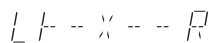

Display when set for no sound from the right speaker.

Display at the centre position.

Display when set for no sound from the left speaker.

- The balance is normally set to the center position.

Note: If no adjustments are made for 4 seconds in balance adjustment mode, the display reverts to the previous display.

Reinforcing the Bass Sound

S.A. (Signal Adaptive) BASS adjusts low tones at low volume to enhance their effect. When the volume level is low, this enhances low tones that are normally difficult to hear and adjusts low tones to a fixed level to reduce low tone distortion.

Press the S.A. BASS button.

The S.A. BASS button lights up.

The display changes with each press of the S.A. (Signal Adaptive) BASS button as shown below.

→ SA-BASS 1 → SA-BASS 2 → OFF → (back to the beginning)

- SA-BASS 2 enhances low tones more than SA-BASS 1.

To get the effect, press the S.A. BASS button and select SA-BASS 1 or SA-BASS 2. “SA-BASS 1” or “SA-BASS 2” appears in the display and the button indicator lights up.

- When listening to recording with low volume low tones, the difference between SA-BASS 1 and SA-BASS 2 is clear. When listening to recording with louder low tones, however, the difference between SA-BASS 1 and SA-BASS 2 may not be so clear.

To cancel an effect, press the S.A. BASS button until “OFF” appears on the display. The S.A. BASS button indicator goes out.

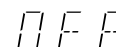

S.E.A. Mode

The System has some preset sound effects that give you control of the way your music sounds, so you can tailor it for your room and for the quality of the source. We can give you some idea of how each one affects the music, but the only way to really tell is to try them yourself.

You can also create up to three of your own customized S.E.A. (Sound Effect Amplifier) settings and store them in the unit's memory.

■ S.E.A. Mode effects cannot be recorded.

S.E.A. effect modes

ROCK Boosts low and high frequencies.

POP Good for vocal music.

CLASSIC Set for wide and dynamic sound stereo systems.

Selecting a S.E.A. Effect Mode

Press the SEA button (or the SEA MODE button on the Remote Control).

The "SEA" indicator on the display lights up.

The display changes with each press of the button as shown below.

→**ROCK** →**POP** →**CLASSIC** → **MANUAL 1** → **MANUAL 2** → **MANUAL 3** → **OFF** → (back to the beginning)

■ The name of the effect appears on the display, then returns to the previous display after a few seconds. If you want to see the name of the selected mode, press the SEA MODE button once. The name of the currently selected mode appears on the display for a few seconds.

To cancel S.E.A. effect mode, select "OFF". The "SEA" indicator goes out.

Customizing a S.E.A. Effect Mode

You can create up to three of your own customized S.E.A. settings and store them in the unit's memory.

■ You can adjust the level of the LOW, MID, or HIGH tones.

■ You can change an existing sound mode to suit your own preferences by adding your own S.E.A. effects to the existing effect. To create an S.E.A. effect from a flat level, perform the following steps after selecting "OFF" for S.E.A. effect mode.

1. Press the MENU button.

The "TIMER" section of the menu display blinks.

2. Press the cursor key to the right or left (◀ or ▶) and select "SEA CONTROL".

The display changes with each press of the cursor keys as shown below.

When a CD source is selected:

← Press the left (◀) cursor key

←**TIMER** ↔ **CD P.MODE** ↔ **REPEAT** ↔ **AUTO EDIT** ↔ **SEA CONTROL** ↔

Press the right (▶) cursor key →

When any other source is selected:

TIMER ↔ **SEA CONTROL**

3. Press the SET button.

"LOW 0 dB" blinks on the display.

- If S.E.A. is already on, the low tones for the selected S.E.A. MODE are displayed.

■ The level for the low tones of the S.E.A. effect appears on the display while the "SEA CONTROL" indicator is lit.

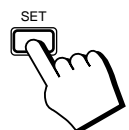
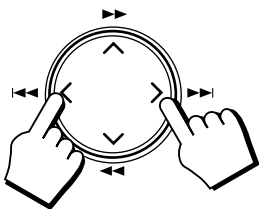
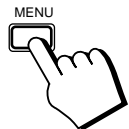
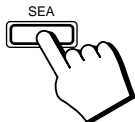

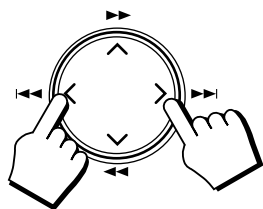

4. Adjust the level of the low (LOW), middle (MID), or high (HIGH) tones.

Using the Unit

1. Select the "LOW", "MID", or "HIGH" tone ranges by adjusting the cursor keys left and right (◀◀◀◀ or ▶▶▶▶).

The display changes with each press of the cursor keys as shown below.

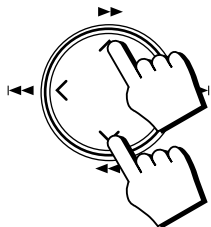

- ← Press the left (◀◀◀◀) cursor key
- ↔ LOW ↔ MID ↔ HIGH ↔
- Press the right (▶▶▶▶) cursor key →

2. Adjust the level of the selected tone range by adjusting the cursor keys up and down (▶▶▶▶ ^ or v ◀◀◀◀).

Pressing the ▶▶▶▶ ^ cursor key increases the level in 2dB units, and pressing the v ◀◀◀◀ cursor key decreases it in 2dB units.

- You can adjust the level between -6 dB and +6 dB in seven steps.

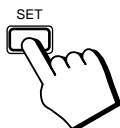

Using the Remote Control

1. Press the SEA CONTROL button.
2. Select the "LOW", "MID", or "HIGH" tone ranges by pressing the ◀◀◀◀◀◀ or ▶▶▶▶▶▶ button.

The display changes with each press of the buttons as shown below.

- ← Press the ◀◀◀◀◀◀ button
- ↔ LOW ↔ MID ↔ HIGH ↔
- Press the ▶▶▶▶▶▶ button →

3. Adjust the level of the selected tone range by pressing the ^▶▶▶▶ or ■ v button.

You can adjust the level between -6 dB and +6 dB in seven steps.

5. Press the SET button.

"MANUAL 1" blinks on the display.

MANUAL 1

SEA

SEA CONTROL

6. Select the number for the MANUAL setting.

Using the Unit

Press the cursor key to the right or left (◀◀◀◀ or ▶▶▶▶) and select the number.

Using the Remote Control

Select the number by pressing the ◀◀◀◀◀◀ or ▶▶▶▶▶▶ button.

The display changes with each press of the buttons or cursor keys as shown below.

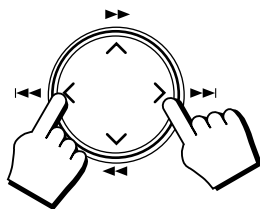

On the unit:

- ← Press the left (◀◀◀◀) button
- ↔ MANUAL 1 ↔ MANUAL 2 ↔ MANUAL 3 ↔
- Press the right (▶▶▶▶) button →

On the Remote Control:

- ← Press the ◀◀◀◀◀◀ button
- ↔ MANUAL 1 ↔ MANUAL 2 ↔ MANUAL 3 ↔
- Press the ▶▶▶▶▶▶ button →



7. Press the ENTER button.

"MEMORY" and the selected memory number are displayed on the screen, and the adjusted settings are stored in memory. After a few seconds, the display reverts to the item that was displayed before you pressed the MENU button.

- The memory setting will appear in the S.E.A. effect mode using the manual number.

MEMORY 1

SEA

SEA CONTROL

- If you store new settings to a MANUAL number that has already been used, the new settings replace the existing setting.

Using the Surround Processor

The Built-in surround processor provides three types of the surround modes — JVC's 3D-PHONIC mode, DAP (Digital Acoustic Processor) mode, and Dolby Pro Logic mode.

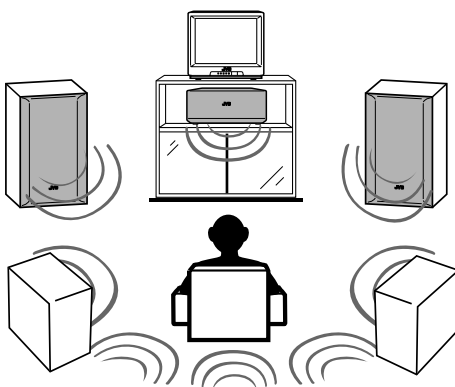
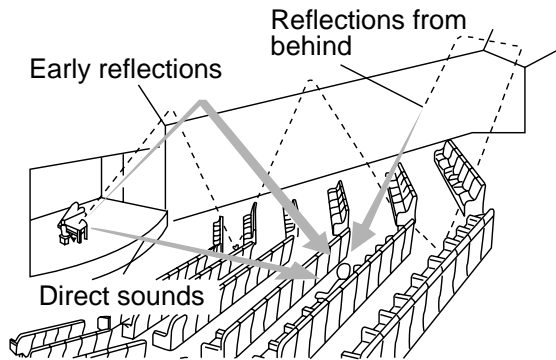
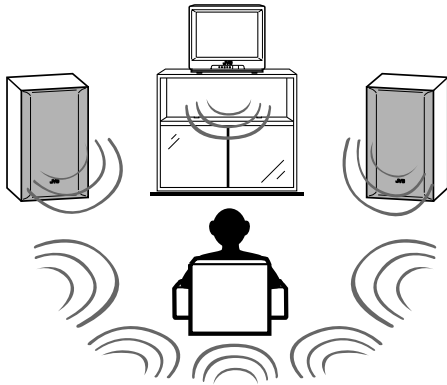

On JVC's 3D-PHONIC Mode

JVC's 3D-PHONIC mode gives you such a nearly surround effect as it is reproduced through the Dolby Surround decoder, which is widely used to reproduce sounds with a feeling of movement like those experienced in movie theaters. JVC's 3D-PHONIC mode is the result of research on sound localization technology carried out at JVC for many years and makes it possible to reproduce the surround sound with only two front speakers.

On DAP Mode

The sound heard in a concert hall or club consists of direct sound and indirect sound — early reflections and reflections from behind. Direct sounds reach the listener directly without any reflection. On the other hand, indirect sounds are delayed by the distances of the ceiling and walls. These direct sounds and indirect sounds are the most important elements of the acoustic surround effects. The DAP mode can create these important elements, and gives you a real "being there" feeling by using only the front speakers.

On Dolby Pro Logic Mode

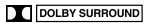
Dolby Pro Logic is a function devised for home use to allow families to enjoy movies and music software bearing * mark which includes the same encoded surround information as found in Dolby Stereo films. Since Dolby Pro Logic reproduces dialogue from a center speaker independently, emphasizes the movement of sound, and gives you a real "being there" feeling.

* Manufactured under license from Dolby Laboratories Licensing Corporation. "Dolby", the double-D symbol and "Pro Logic" are trademarks of Dolby Laboratories Licensing Corporation.

Notes:

- The surround processor has no effect on monaural sources.
- The surround processor cannot be used for recording.

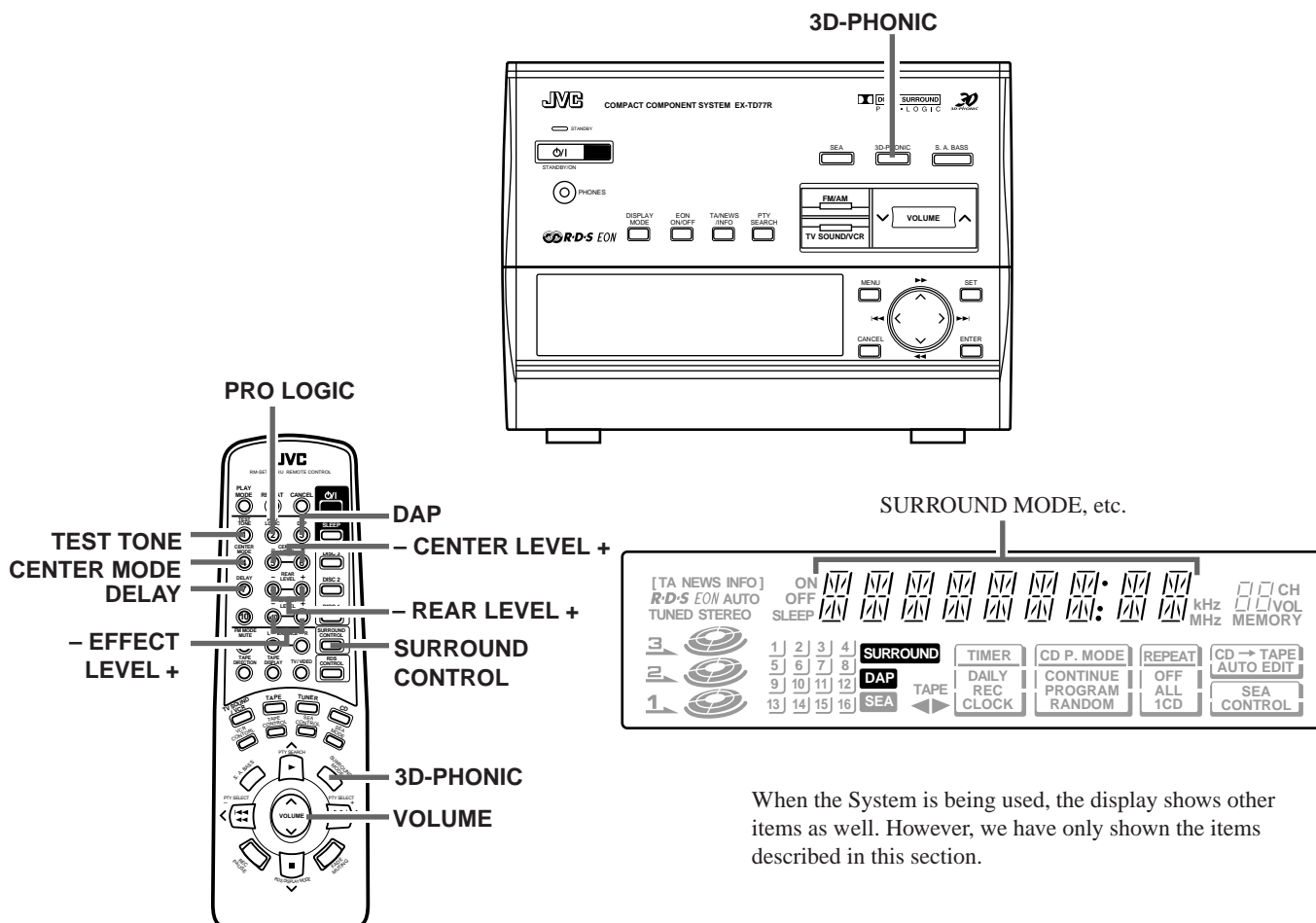

When the System is being used, the display shows other items as well. However, we have only shown the items described in this section.

Playing the Source Using the 3D-PHONIC Modes

When using JVC's 3D-PHONIC modes, you need only two front speakers to reproduce the soundtracks of video software bearing the mark DOLBY SURROUND.

The 3D-PHONIC mode give you a very realistic surround effect when the sound is reproduced through the Dolby Surround decoder.

Perform the following steps using the buttons on the Remote Control.

1. Press the 3D-PHONIC button repeatedly to select the 3D-PHONIC mode you want.

The current 3D-PHONIC mode appears on the display and the 3D-PHONIC button light comes on. Each time you press the button, the 3D-PHONIC mode changes as follows:

→ ACTION → DRAMA → THEATER → OFF → (back to the beginning)

ACTION: Best for action and war movies — where the action is fast and explosive.
DRAMA: Best for dramas and romantic movies — where the action is slow and soft.
THEATER: Reproduces the sound field of a large theater.

2. Press the SURROUND CONTROL button.

3. Press the EFFECT LEVEL + or - button to adjust the effect level.

The current level is shown on the display. Each time you press the button, the level changes as follows:

← Press the EFFECT - button
 EFFECT1 ↔ EFFECT2 ↔ EFFECT3 ↔ EFFECT4 ↔ EFFECT5
 Press the EFFECT + button →

■ As the number increases, the selected 3D-PHONIC mode becomes stronger.

4. Select and play a sound source which was processed with Dolby Surround and is labeled with mark.

- The effect level can be stored for each mode.
- You can select the 3D-PHONIC mode by pressing the 3D-PHONIC button on the Unit.

Note: The 3D-PHONIC mode is not used with other surround modes. When the 3D-PHONIC mode is turned on, the other surround mode, if used, will be turned off.

To cancel the 3D-PHONIC mode, select “OFF” in step 1 or by pressing the 3D-PHONIC button on the Unit.

Playing the Source Using the DAP Modes

When you listen to music, you can create a more realistic sound field by using the DAP modes. Among the DAP mode, there is one suitable for listening to news.

Perform the following steps using the buttons on the Remote Control.



1. Press the SURROUND CONTROL button.

2. Press the DAP button repeatedly to select the DAP mode you want.

The current DAP mode appears on the display and the DAP indicator lights up. Each time you press the button, the DAP mode changes as follows:



→ JAZZ CLUB → SYMPHONY → NEWS → OFF → (back to the beginning)

- JAZZ CLUB:** Reproduces the sound field of a live music club.
SYMPHONY: Reproduces the sound field of a large concert hall. Best for orchestral music.
NEWS: Best for watching or listening to news.

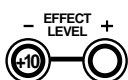

3. Press the EFFECT LEVEL + or - button to adjust the effect level.

The current level is shown on the display. Each time you press the button, the level change as follows:

← Press the EFFECT - button
 EFFECT1 ↔ EFFECT2 ↔ EFFECT3 ↔ EFFECT4 ↔ EFFECT5
 Press the EFFECT + button →

- As the number increases, the selected DAP mode becomes stronger.
- The effect level can be stored for each mode.

Note: The DAP mode is not used with other surround modes. When the DAP mode is turned on, the other surround mode, if used, will be turned off.

To cancel the DAP mode, select “OFF” in step 2.

Playing the Source Using Dolby Pro Logic Mode

Preparing the Dolby Pro Logic Reproduction

For connecting the diagram, See page 6 “For Dolby Pro Logic Reproduction”.
To use the Dolby Pro Logic mode, you need to prepare the various settings as follows:

Center Speaker Mode

Center Speaker mode contains the following four settings.

- PHANTOM:** Select this setting if you have not connected a center speaker. The left and right front speakers project the sound to give the effect of a center speaker.
- NORMAL:** Select this setting if you are using a small center speaker. Since the center speaker cannot boost the low tones effectively, this setting uses the front speakers to boost the low tones from the center speaker.
- WIDE:** Select this setting if you are using a center speaker that is similar in power to the front speakers.
- OFF:** Select this setting to turn off the output for the center speaker.

Delay Time Mode

Delay Time mode contains the following three settings.

- DELAY-1:** Select this setting if the rear speakers are further away from your listening position than the front speakers. (Delay time: 15 msec.)
- DELAY-2:** Select this setting if the rear speakers and front speakers are about the same distance way from your listening position. (Delay time: 20 msec.)
- DELAY-3:** Select this setting if the rear speakers are nearer to your listening position than the front speakers. (Delay time: 25 msec.)

Adjusting the level of the Center Speaker

Adjust the level of the center speaker between +10 and -10. Set the level so that it is about the same as the level from the front speakers.

Adjusting the level of the Rear Speakers

Adjust the level of the rear speakers between +10 and -10. Set the level so that it is about the same as the level from the front speakers.

- You cannot adjust the levels of the left and right rear speakers independently.

Getting Ready to Use Dolby Pro Logic

Speaker arrangements for Dolby Pro Logic

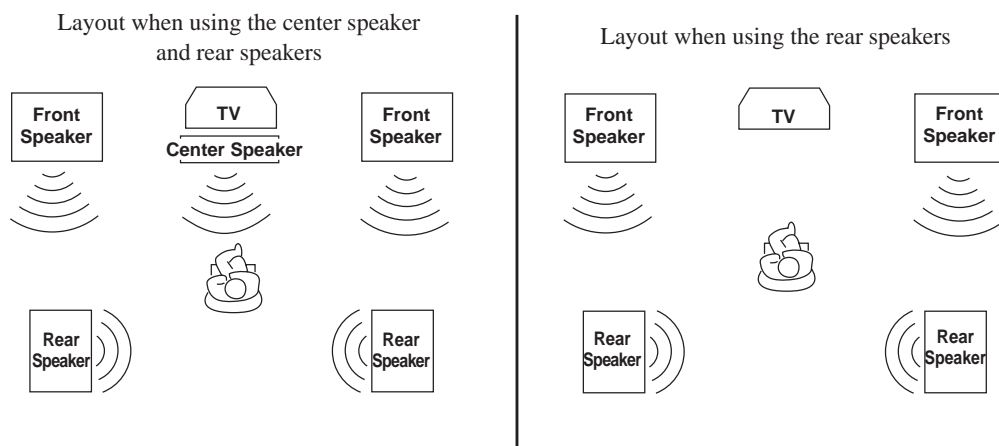

Perform the steps below using the buttons on the Remote Control.



1. Press the **SURROUND CONTROL** button.



2. Press the **PRO LOGIC** button.

“PRO LOGIC” appears on the display and the SURROUND indicator lights up.

PRO LOGIC

SURROUND



3. Select the desired **Center Speaker mode**.

Press the CENTER MODE button. The display changes with each press of the button, as shown below.

→ **NORMAL** → **WIDE** → **OFF** → **PHANTOM** → (back to the beginning)



4. Select the **Delay time**.

Press the DELAY button. The display changes with each press of the button, as shown below.

→ **DELAY 1** → **DELAY 2** → **DELAY 3** → (back to the beginning)

5. Set the volume to the level you normally use.

6. Press the **TEST TONE** button.

A test tone is emitted in the order shown below.

→ **LEFT** → **CENTER** → **RIGHT** → **REAR** → (back to the beginning)

- When “PHANTOM” is selected for Center Speaker mode, the test tone for the center speaker is projected by the front speakers.
- When “OFF” is selected for Center Speaker mode, no test tone is output from the center speaker.



7. Adjust the level for the **center speaker**.

Press the CENTER LEVEL + or – button. Set the level so that it is about the same as the level from the front speakers.

CNTR 000

- You cannot adjust the level for the center speaker if “PHANTOM” or “OFF” is selected for Center Speaker mode.

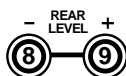

8. Adjust the level for the **rear speakers**.

Press the REAR LEVEL + or – button. Set the level so that it is about the same as the level from the front speakers.

REAR 000



9. To cancel **Test Tone mode**.

Press the TEST TONE button again.

This completes the preparations required for using Dolby Pro Logic.

Note: The Dolby Pro Logic mode is not used with other surround modes. When the Dolby Pro Logic mode is turned on, the other surround mode, if used, will be turned off.



Using the Dolby Pro Logic

- 1. Press the SURROUND CONTROL button.**
- 2. Press the PRO LOGIC button to light the SURROUND indicator on the display.**

"PRO LOGIC" appears on the display.

- 3. Start playback from the desired source.**

Enjoy the great sound of the Dolby surround processor.

- Use recording that have the  logo.

To cancel the Pro Logic mode, press the PRO LOGIC button after pressing the SURROUND CONTROL button. The SURROUND indicator goes out.

Using the Tuner

FM/AM button

Press this to select the Tuner as the source. The button indicator lights up and the cursor keys operate in Tuner control mode.

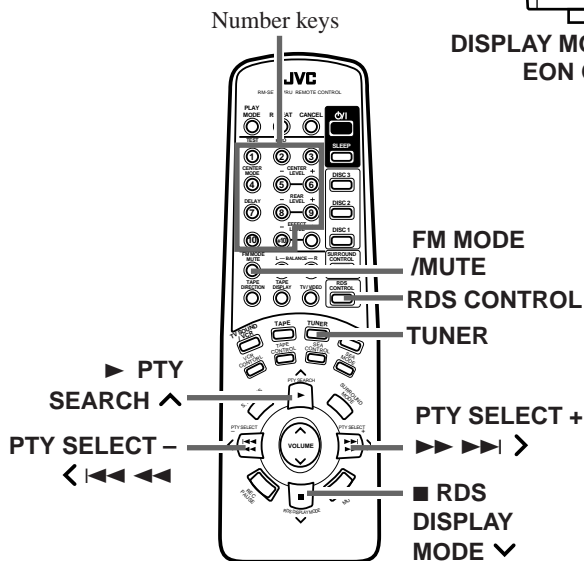
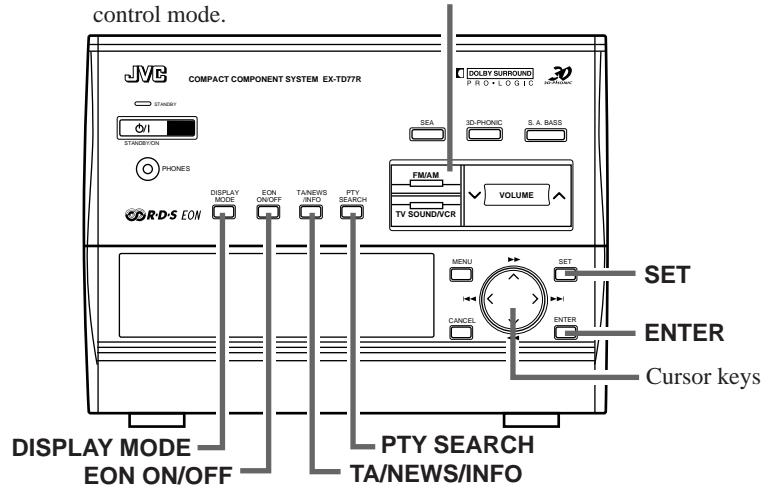

Display

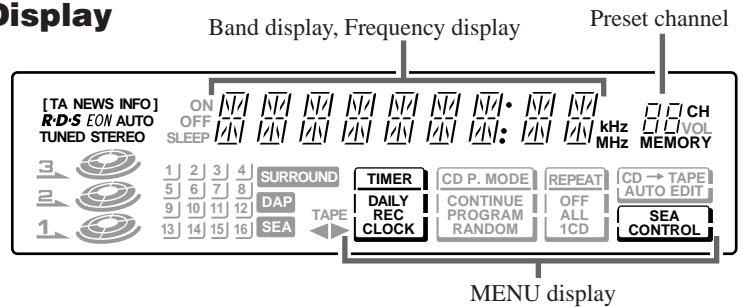

When the System is being used, the display shows other items as well. However, we have only shown the items described in this section. This illustration shows only the Menu display items for the Tuner.

TUNER button

Press this button to select the Tuner as the source and switch the Remote Control Tuner Control mode.

You can listen to both FM and AM (MW/LW) stations. Stations can be tuned in manually, automatically, or from preset memory storage.

■ Before listening to the radio:

- Check that both the FM and AM (MW/LW) antennas are firmly connected. (See page 5).

One Touch Radio

Just press the FM/AM button (or the TUNER button on the Remote Control) to turn on the Unit and start playing the most recent station tuned in.

- You can switch from any other sound source to the radio by pressing the FM/AM button (or the TUNER button on the Remote Control).



Tuning In a Station

Press the FM/AM button (or the TUNER button on the Remote Control) to turn on the radio. The Frequency of the previously selected channel appears on the display.

Switching between Frequency Bands

Press the FM/AM button (or the TUNER button on the Remote Control).

Each time you press the button, the band alternates between FM and AM (MW/LW) .

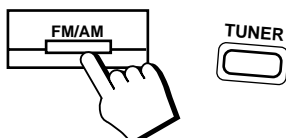

Selecting a radio station

Manual Tuning

Press the up and down cursor keys (▶▶ ▲ or ▼ ◀◀) to select the frequency. The frequency changes in one step increments. "TUNED" appears on the display when a signal is found.

Press the up cursor key (▶▶ ▲) to increase the frequency and the down cursor (▼ ◀◀) to decrease it.

Auto Tuning

Keep the up or down cursor key (▶▶ ▲ or ▼ ◀◀) pressed down to change the frequency continuously until a signal is found. "TUNED" will appear on the display when a signal is found. This is called Auto Tuning.

Preset Tuning (possible only after presetting stations)

Using the Unit

Select the a preset channel number by pressing the left and right (◀◀ ◀ or ▶ ▶▶) cursor keys.

Press the right cursor key (▶ ▶▶) to increase the preset channel number and the left cursor key (◀◀ ◀) to decrease it.

Using the Remote Control

Press the ▶ ▲ or ◼ ▼ after pressing the TUNER button to select a preset channel. Press the ▶ ▲ button to increase the preset channel number and the ◼ ▼ button to decrease it.

You can use the Remote Control to select a preset channel directly.

1. Press the TUNER button so that you can receive the most recent station tuned in.
2. Select the station by entering the preset channel in the number keys of the Remote Control.
 - Example: for channel 5, press 5. For channel 15, press +10 then 5. For channel 20, press +10, then 10. For channel 32, press +10 three times, then 2.

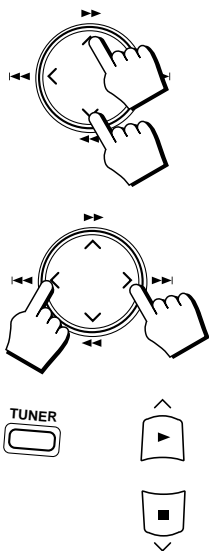

To Change the FM Reception Mode

When an FM stereo broadcast is hard to receive or noisy, press the FM MODE/MUTE button on the Remote Control so that the "AUTO" indicator goes off in the display. Reception improves, but there are no stereo effects. In this monaural mode, noise comes out while tuning in stations (since muting is also cancelled).

To restore the stereo effect, press the FM MODE/MUTE button on the Remote Control so that the "AUTO" indicator lights up. In this stereo mode, no noise comes out while tuning in stations, and you can hear stereo sounds when a program is broadcast in stereo.



Presetting Stations

You can store up to 40 of your favorite radio stations (FM and AM (MW/LW)) in memory, giving you quick, easy access to the stations.

Note: In some cases, test frequencies have been already memorized for the tuner since the factory examined the tuner preset function before shipment. This is not a malfunction. You can preset the stations you want into memory by following the presetting method.

1. Select a frequency band by pressing the FM/AM button.

2. Press the up or down cursor key (▶▶ ▲ or ▼ ◀◀) to tune to a station.

3. Press the ENTER button .

On the display, "MEMORY" will blink for 5 seconds.

- During these 5 seconds while "MEMORY" is blinking, you can assign a channel number to the station and enter it into the memory.

MEMORY

4. Press the right or left cursor key (◀◀ ◀ or ▶ ▶▶) to select a preset channel number.

5. Press the ENTER button again.

"MEMORY" appears on the display and that station is stored in the selected preset number.

- If a station has been previously stored using the same channel number, this will be erased and the newly selected station will be stored.
- If "MEMORY" in the display goes off, start again from step 3.

6. Repeat steps 1 to 5 for each station you want to store in memory with a preset number.

CAUTION: If the Unit is unplugged or if a power failure occurs, the preset stations will be erased after a few days. If this happens, preset the station again.

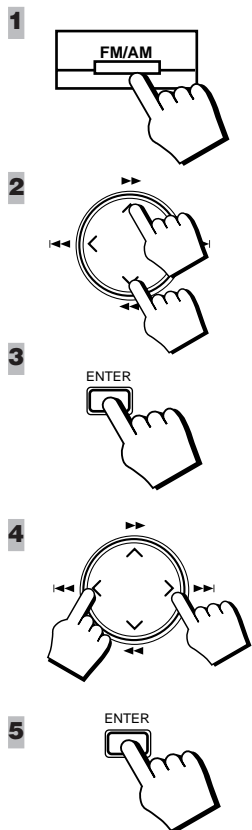

Receiving FM Stations with RDS

RDS (Radio Data System) is a broadcasting service which a growing number of FM stations are now providing. It allows the FM stations to send additional signals along with their regular programme signals. For example, the stations send their station names and information about what type of programme they broadcast, such as sports or music, etc.

When tuned to an FM station which provides the RDS service, the RDS indicator lights up, the station frequency (and then the station name if sent) is displayed.

One convenient RDS service is "Enhanced Other Networks (EON)". This allows the Unit to automatically switch to a programme type of your choice when one starts in your broadcast area.

■ Not all FM stations provide RDS service, nor do all RDS stations provide the same services. If in doubt, check with local radio stations for details on RDS services in your area.

Note: RDS may not work correctly if the station to which you are tuned is not transmitting properly or if the signal strength is weak.

What Information RDS can Provide

The System can use the following RDS service.

PS (Program Service name)

Identifies each station by a name.

TA (Traffic Announcement Identification)

Identifies that a traffic announcement is being broadcast in your area.

RT (Radio Text)

Allows the RDS station to send text messages that appear on the display of the unit.

PTY (Programme Type)

Identifies the type of RDS programme. This allows you to locate a specific type of programme being broadcast.

The programme types are as follows:

TRAFFIC:	Traffic announcement
NEWS:	News
INFO:	Programmes on medical service, weather forecast, etc.
POP M:	Pop music
ROCK M:	Rock music
M.O.R. M:	Middle-of-the-road music (usually called "easy listening")
LIGHT M:	Light music
CLASSICS:	Classics
OTHER M:	Other music
AFFAIRS:	Topical programme expanding on current news or affairs
SPORT:	Sports events
EDUCATE:	Educational programmes
DRAMA:	Radio plays
CULTURE:	Programmes on national or regional culture
SCIENCE:	Programmes on natural sciences and technology
VARIED:	Other programmes like comedies or ceremonies
NONE:	Undefined
ALARM:	Emergency broadcasts

EON (Enhanced Other Networks Information)

Provides information available on RDS stations other than the one which is being received.

Changing the Display

You can see RDS information on the display.

To view RDS information on the display, press the DISPLAY MODE button. (When using the Remote Control, press the RDS DISPLAY MODE button after pressing the RDS CONTROL button.)

Each time you press the button, the display changes to show the following information:

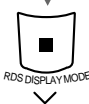
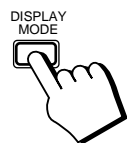

PS (Programme Service):

Station names will be displayed.

PTY (Programme Type):

Types of broadcast programmes will be displayed.

RT (Radio Text):

Text message sent by stations will be displayed.

Station Frequency:

Station frequencies.

- While RDS information is being received from a station, “WAIT PS”, “WAIT PTY”, or “WAIT RT” may appear on the display.

Searching for Programmes by PTY codes

One of the advantages of the RDS service is that you can locate a particular kind of programme by specifying the PTY codes.

- The PTY Search function is applicable to preset stations only.

To search for a programme using the PTY codes, follow this procedure: Using the Unit



1. Press the PTY SEARCH button.

“PTY” and “SELECT” appear alternately on the display.

Note: If no adjustments are made for 5 seconds in PTY Search mode, the display reverts to the previous display. Perform the next step while “PTY” and “SELECT” are being displayed.

2. Press the cursor key to the left or right (◀ or ▶) to select a PTY.

The display changes with each press of the cursor keys as shown below:

← Press the left (◀) cursor key

↔ TRAFFIC ↔ NEWS ↔ INFO ↔ POP M ↔ ROCK M ↔ M.O.R. M ↔
 LIGHT M ↔ CLASSICS ↔ OTHER M ↔ AFFAIRS ↔ SPORT ↔ EDUCATE
 ↔ DRAMA ↔ CULTURE ↔ SCIENCE ↔ VARIED ↔

Press the right (▶) cursor key →

3. Press the PTY SEARCH button again.

While the search function is running, the selected programme type and “SEARCH” alternate on the display. The preset number also change.

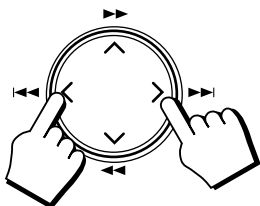

Using the Remote Control

1. Press the RDS CONTROL button.

2. Press the ▶ PTY SEARCH ^ button.

“PTY” and “SEARCH” appear alternately on the display.

Note: If no adjustments are made for 5 seconds in PTY Search mode, the display reverts to the previous display. Perform the next step while “PTY” and “SEARCH” are being displayed.



3. Press the **PTY SELECT - <|<<<< or >>>>| > PTY SELECT +** button to choose a **PTY**.

- The programme type display changes with each press of the PTY SELECT button as shown below.

← Press the **PTY SELECT - <|<<<<** button
 ↔ **TRAFFIC** ↔ **NEWS** ↔ **INFO** ↔ **POP M** ↔ **ROCK M** ↔ **M.O.R. M** ↔
 ↔ **LIGHT M** ↔ **CLASSICS** ↔ **OTHER M** ↔ **AFFAIRS** ↔ **SPORT** ↔ **EDUCATE**
 ↔ **DRAMA** ↔ **CULTURE** ↔ **SCIENCE** ↔ **VARIED** ↔
 Press the **>>>>| > PTY SELECT +** button →

4. Press the **▶ PTY SEARCH ^** button again.

While the search function is running, the selected programme type and “SEARCH” alternate on the display. The preset number also change.

Once the station which is broadcasting the selected PTY (Programme Type) is located, searching will stop. Then the station name (if PS code is being sent) will be indicated and the broadcast will commence. The Display will stay blinking for 10 seconds from the end of the searching function. If you press the PTY SEARCH button again during this period, search for the same PTY (Programme Type) will restart. The PTY Search function is completed when the indicated preset Number changes from blinking to continuously lit.

- If a station broadcasting a selected PTY(Program Type) cannot be found, “NOT” and “FOUND” are displayed alternately on the display after the Unit has searched through the preset numbers. The Unit will then return to the station to which it was tuned prior to the start of the PTY Search.

To cancel a PTY Search operation, press the PTY SEARCH button. “PTY” and “SELECT” are displayed alternately on the display for a few seconds, then the display return to the screen that was selected before PTY SEARCH was displayed.

Note: PTY Search can be used even while AM (MW/LW) broadcasts are being received.

EON Function

With the EON (Enhanced Other Networks) code, the Unit can perform a standby reception which will enable you to obtain desired information which is available from other stations.

- “EON” will be displayed while receiving stations with an EON code.
- EON Standby reception is applicable for preset stations only.
- You can set EON Standby reception regardless of types of receiving bands.

Setting EON Standby reception

1. Press the **EON ON/OFF** button.

[TA NEWS INFO], or the last EON information type selected, is displayed.

2. Select information you want by pressing the **TA/NEWS/INFO** button.

TA: Identifies that a traffic announcement is being broadcast in your area.

NEWS: News

INFO: Programmes on medical service, weather forecast, etc.

- With each pressing of the TA/NEWS/INFO button, indications will change as follows:

[TA] → [NEWS] → [INFO] →
 [TA NEWS] → [NEWS INFO] → [TA INFO] →
 [TA NEWS INFO] → (back to the beginning)

As soon as your selection is entered the Unit will go into EON Standby reception mode.

If you want to cancel the EON function, turn off the [TA NEWS INFO] indicator by pressing the EON ON/OFF button.

When this Unit carries out EON Standby reception, the indication will change as follows:

- Waiting for EON Standby reception

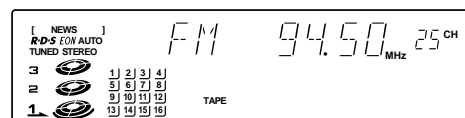

- Preset stations are being searched for and while preparing to change the station, sound will be muted.

Blinking



- The station will be changed and the programme type being received will appear on the display.

Blinking



- When using the DISPLAY MODE button to change the display, use the appropriate setting for the type of display.

Notes:

- EON broadcasts of some stations may not be compatible with this Unit. In the case of an incompatible EON broadcast, "EON" will not appear on the display.
- While the Unit is receiving information for an EON code you have selected for EON Standby, you cannot use the following operations: cursor key, TA/NEWS/INFO button or PTY SEARCH button. In addition, if a station transmits information for a programme type you have selected without sending the EON code, the EON Standby operation is still performed. Therefore, you will not be able to use the operations listed above during this period.
- If the reception is unsatisfactory for a station among the preset stations, "WAITING" appears on the display and the station is searched for again. If after searching through the channels five times, the broadcasting station cannot be found, "NOT" and "FOUND" are displayed alternately on the display. The Unit will then return to the station to which it was previously tuned.

When broadcasting of the desired information has been completed, "EON END" will be indicated and the Unit will automatically go back to the station which had previously been tuned to.

- While receiving information on EON Standby reception, the station will not change to other stations even if the same information is available from them.
- If you cancel the EON function when in EON Standby reception mode by either pressing the EON ON/OFF button, the Unit will automatically return to the station which had been previously tuned-in.

If the information you are waiting for is available from the current station, the indicator will blink.

ALARM function

If an ALARM (Emergency) signal is received while receiving an EON code from a station, "ALARM" blinks on the display and the Unit automatically switches to the station broadcasting the ALARM signal. When an ALARM broadcast of PTY is being received from the currently tuned-in station, "ALARM" will blink on the display for your attention.

Using the CD Player

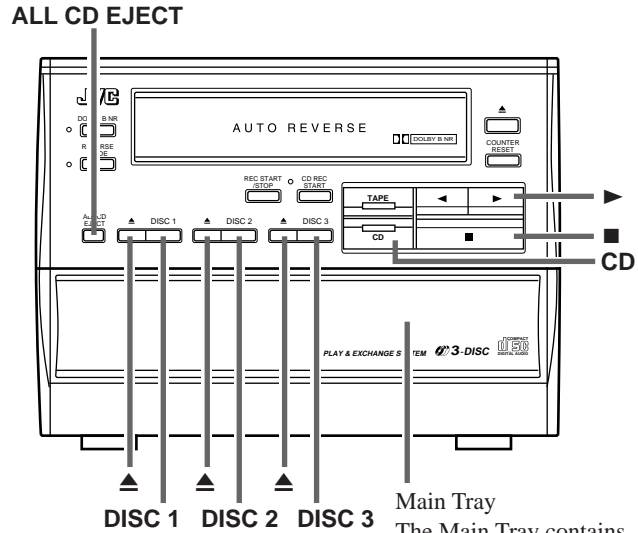
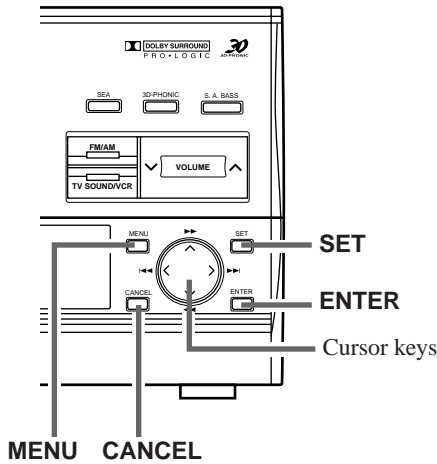

CD
Press this to select the CD as the playback source. The button indicator lights up and the ► button, ■ button and the cursor keys operate in CD control mode.

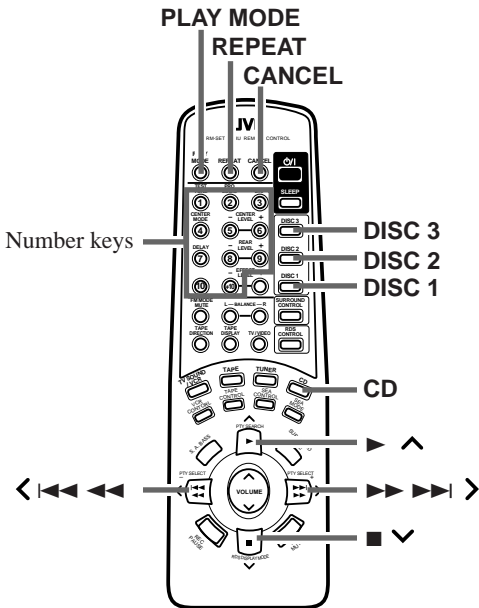

Display

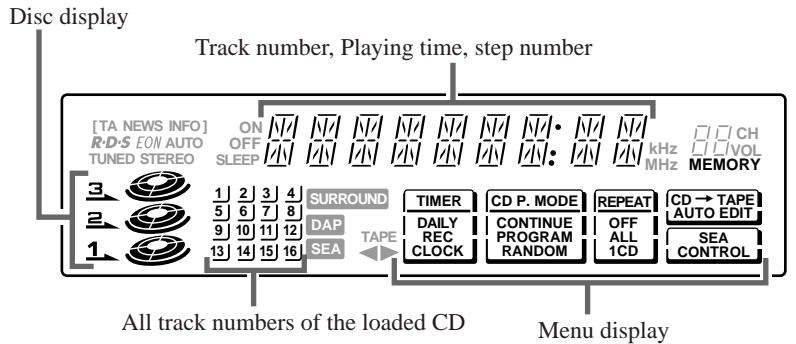

When the System is being used, the display shows other items as well. However, we have only shown the items described in this section. This illustration shows only the Menu display items for the CD.

CD button

Press this button to select the CD as the playback source and switch the Remote Control CD control mode.

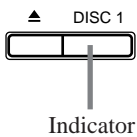

DISC button indicator

The buttons DISC 1, DISC 2, and DISC 3 act as indicators for the corresponding trays. This indicator is off when the CD Player is checking that there is no disc in the disc tray for the selected disc number. Pressing the ▲ button turns the indicator on.

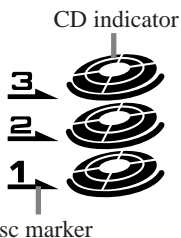

Disc display

A disc marker lights on the disc display for the disc number you have selected. The CD indicator blinks while a CD is being played. The CD indicator, for the disc tray corresponding to the "NO DISC" display, goes out. The CD indicator for the disc tray which is opened with the Main Tray lights up. The CD indicator for disc that have been played are dimmed slightly compared to discs that have still to be played, or are being played.

The System's CD Player has an Automatic Changer with 3 disc trays. You can use Continuous, Random, Program or Repeat Play for the discs in DISC 1, DISC 2 and DISC 3. Repeat Play can repeat all the tracks on all the CD's, the tracks on one of the CD's or one track on one CD. There is also the Tray Lock function, which safely keeps discs in the trays.

Here are the basic things you need to know to play a CD and locate the different selections on it. Each selection is called a track, so when we are talking about locating a track, we are also talking about how you find a certain song or performance.



The Quickest Way To Start a CD Is With the One Touch Operation

The power comes on, and operations are done automatically.

- Press the CD button .
 - If there is a CD in the disc tray of the selected (The Disc marker lights up) disc number, playback begins from the first track of that disc.
 - If there is not a CD in the disc tray of the selected disc number, search starts for a disc tray with a CD. If a CD is found, playback begins from the first track of that disc.
 - If there is no CD in any of the disc trays, the message "NO DISC" appears in the display after a few seconds and the disc tray for DISC 1 opens.
- Press a DISC (1 to 3) button .
 - If there is a CD in the disc tray for the disc number you have selected, playback begins from the first track of that disc. If there is no CD in the disc tray, the message "NO DISC" appears in the display after a few seconds and the disc tray opens.
- Press the ALL CD EJECT button.
 - The Main Tray for all the disc trays opens.
- Press the ▲ button.
 - The Main Tray for the disc number corresponding to the number of the ▲ button pressed, opens.

Basics of Using the CD Player — Continuous Play

You can play the discs continuously in the DISC 1 to DISC 3 trays.

To Insert Discs

To insert three discs at the same time:

1. Press the ALL CD EJECT button.

The Main Tray for all the disc trays opens.

The disc trays are numbered from the top down; DISC 3, DISC 2, and DISC 1.

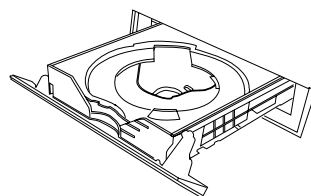

2. Insert a CD into the disc tray for DISC 3, with the label face-up.

ATTENTION: To avoid malfunctions when you play a CD, please set the CD in the right place at the center of the tray.

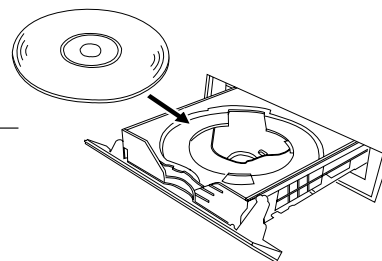
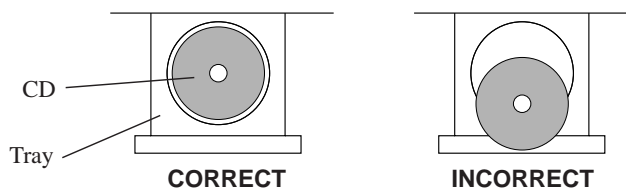

- To put an 8 cm CD into a tray, insert it so that it is aligned with the groove in the tray's center.

3. Push the disc tray for DISC 3 to the back.

Push the disc tray gently to the back using the finger hold on the front right of the tray. The disc tray for DISC 2 will appear below the disc tray for DISC 3.

- Take care not to touch any CDs in the lower trays when pushing the disc tray into the Unit.
- If excessive force is applied to the Main Tray, the Main Tray will be closed. So, when you push the disc tray, gently push it to the back.
- While pushing the disc tray, take care not to touch any buttons on the Unit.

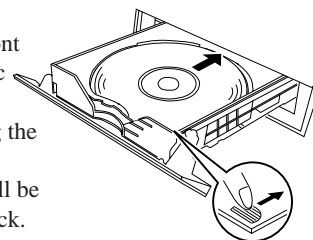
**4. Insert a CD into the disc tray for DISC 2 in the same way as for DISC 3.**

After inserting the CD, push the disc tray to the back. The disc tray for DISC 1 will appear.

5. Insert CD into the disc tray for DISC 1.**6. Press the ALL CD EJECT button.**

The Main Tray returns to its original position.

- “ALL EJECT” appears on the display when the Main Tray is opened, and “ALL CLOSE” appears when it closes.
- If you press the CD or ► button on the unit (CD button on the Remote Control) instead of the ALL CD EJECT button, the Main Tray is automatically closed and continuous play starts for the lit disc marker. Also, if you press the DISC 1 - 3 buttons, the Main Tray will automatically close and playback will start from that disc.
- If the Main Tray is open when the System switches to standby mode, the Main Tray is closed automatically.



CAUTION: Do not push the disc tray for DISC 1 to the back. If the Main Tray is pushed in with a CD in, the tray will not load properly or may be ejected again after it has been pushed in. This can result in you not being able to use the CD Player. If the CD Player does not respond, disconnect the power cord then reconnect it again. The CD Player will operate normally again.

CAUTION: While closing the Main Tray, take care not to nip any foreign matter (headphone cable, etc.) between the Main Tray cover and the CD Player. If a foreign matter is nipped, the CD Player may be inoperative. In this case, remove it, and push the Main Tray cover to close the Main Tray. Then, the CD Player will operate normally again.

To insert CDs individually:**1. Press the ▲ button on the left of the DISC (1 - 3) button you want to insert the disc into.**

The disc tray for the selected disc number is set to the top and the Main Tray opens.

2. Place a CD onto the tray.**3. Press the same ▲ button again.**

The Main Tray closes.

- If you press a different ▲ button, the Main Tray closes then the disc tray for the ▲ button pressed is opened.
- If you press the ALL CD EJECT button, the Main Tray closes. Then the Main Tray opens again, containing all disc trays.

- “D1 OPEN” appears on the display when the Main Tray is opened (when DISC 1 is selected), and “D1 CLOSE” appears when it closes.

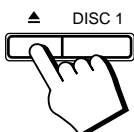
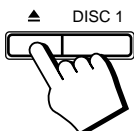

To Play a Disc

This function plays the disc in the Unit continuously, and lights the "CONTINUE" indicator.

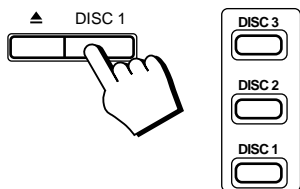

1. Prepare the discs.

2. Press the DISC (1-3) button on the Unit or the Remote Control you want to play.

The first track of the selected disc will begin playing.

When the selected disc finishes playing, the next disc will begin playing automatically.

When the last disc has finished playing, the Unit will stop automatically.

To use Continuous Play from the first track of the disc selected by the disc marker, you do not need to press a DISC (1-3) button, just press the CD or ► button (or CD or ► ▲* button on the Remote Control).

* The ► ▲ button on the Remote Control can be used to control the CD Player when the Remote Control is in CD mode.

Playing order of discs

- When playback starts from DISC 1, the playing order is DISC 1 → DISC 2 → DISC 3. When DISC 3 has finished, the CD Player selects DISC 1 (the disc marker is on) and stops.
- When playback starts from DISC 2, the playing order is DISC 2 → DISC 3 → DISC 1. When DISC 1 has finished, the CD Player selects DISC 2 (the disc marker is on) and stops.
- When playback starts from DISC 3, the playing order is DISC 3 → DISC 1 → DISC 2. When DISC 2 has finished, the CD Player selects DISC 3 (the disc marker is on) and stops.
 - If any of the disc trays are empty, the CD Player skips that disc tray and continues through the remaining disc trays in the order shown above.

Note: If there is no CD in the disc tray for the DISC (1-3) button you pressed, the message "NO DISC" appears on the display and the tray for that disc is automatically moved to the top and the Main Tray opens. If there is no disc in the disc tray for the selected disc number when the ► or CD button (or the CD or ► ▲ button on the Remote Control) is pressed, playback begins from the next disc.

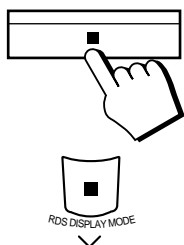

To stop playing the disc, press the ■ button (press the ■ ▼ button after pressing the CD button when using the Remote Control).

To stop play and remove the disc, press the ▲ button for the disc being played or press the ALL CD EJECT button.

To pause, press the ► button. The Disc display will blink. (The Pause function cannot be used with the ► ▲ button on the Remote Control.)

To cancel pause, press the ► button again or press the CD button (or the CD or ► ▲ button on the Remote Control). Play continues from the point where it was paused.

To Change Discs While Playing

You can replace a CD in a tray not being used, while another CD is playing.

1. Press the ▲ button of the tray not being used.

The disc tray you selected is set to the top and the Main Tray opens.

2. Replace the disc in the tray.

3. Press the same ▲ button again.

The Main Tray closes.

To Select a Track

Using the Unit

Press the cursor key to the right or left (|◀◀◀ or ▶▶▶|).

- Set the tracks by pressing the |◀◀◀ or ▶▶▶| cursor key to move between tracks.
 - Pressing the ▶▶▶| cursor key moves to the next track.
 - Pressing the |◀◀◀ cursor key moves to the previous track. (Moves to the beginning of the track during playing a track.)
- Pressing down either of these cursor keys scans the tracks continuously until the key is released.

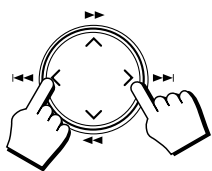

Using the Remote Control

Press the <|◀◀◀ or ▶▶▶|> button after pressing the CD button.

- Each time you briefly press and release the <|◀◀◀ or ▶▶▶|> button, the track changes by one.
 - Press and release the ▶▶▶|> button to go ahead one track at a time.
 - Press and release the <|◀◀◀ button to go back one track at a time. (Moves to the beginning of the track during playing a track.)
- Holding down the <|◀◀◀ or ▶▶▶|> button allows you to change tracks continuously.

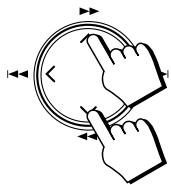

To Select a Passage Within a Track

Press the up or down cursor key continuously while a CD is playing.

Pressing the up (▶▶ ^) cursor key advances the CD rapidly, pressing the down (∨ ◀◀) cursor key plays the CD backwards rapidly. Release the cursor key at the point at which you wish to resume normal playback.

Note: You cannot perform these fast forwards or fast backwards operation with the Remote Control.

Locating a Track With the Remote Control Directly

Using the number keys on the Remote Control allows you to go directly to the beginning of any track.

1. Press the DISC (1-3) button for the disc tray containing the track you want to listen to.

- Example: for the third disc, press the DISC 3 button.

2. Enter the number of the track you want to listen to with the number keys.

The selected track starts playing.

- Example: for track 5, press 5. For track 15, press +10 then 5. For track 20, press +10, then 10. For track 32, press +10 three times, then 2.

Programming the Playing Order of the Tracks

You can change the order in which the discs and tracks play, and select only the discs and tracks you want from among those loaded in the CD Player.

- You can program up to 32 steps in any desired order from among the discs in the player.
- You can only make or change a program when the CD Player is stopped.

Using the Unit

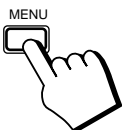

1. Press the MENU button.

The TIMER section of the menu display blinks.

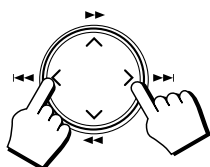
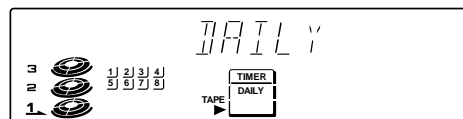

2. Press the cursor key to the right or left (◀◀◀ or ▶▶▶) and select "CD P.MODE".

The menu display changes with each press of the cursor keys as shown below.

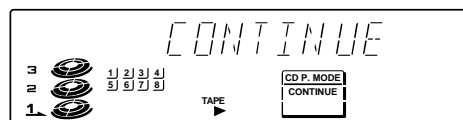

← Press the left (◀◀◀) cursor key

↔ TIMER ↔ CD P.MODE ↔ REPEAT ↔ AUTO EDIT ↔ SEA CONTROL ↔

Press the right (▶▶▶) cursor key →

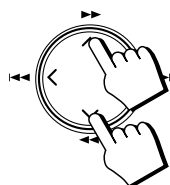

3. Press the cursor key to the up or down (▶▶ ^ or ∨ ◀◀) and select "PROGRAM".

The menu display changes with each press of the cursor keys as shown below.

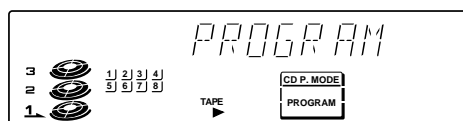

← Press the up (▶▶ ^) cursor key

↔ CONTINUE ↔ PROGRAM ↔ RANDOM ↔

Press the down (∨ ◀◀) cursor key →

"PROGRAM" appears on the display.

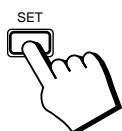

4. Press the SET button.

The blinking "PROGRAM" display changes to a steady display.

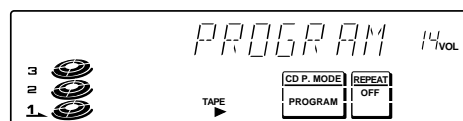

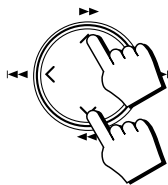

5. Press the cursor key to the up or down (▶▶ ^ or v ◀◀) to select the disc.

The display changes to the Program Entry display and the disc number and track number sections blink for a few seconds.

The menu display changes with each press of the cursor keys as shown below.

← Press the up (▶▶ ^) cursor key
1 ↔ 2 ↔ 3

Press the down (v ◀◀) cursor key →

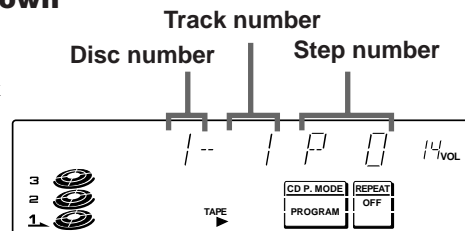

- If you press the DISC (1-3) buttons instead of pressing the up or down (▶▶ ^ or v ◀◀) cursor key, you can select the disc.
- While the display is blinking, perform the operations in steps 6 to 7. When the blinking display changes to the "PROGRAM" display, repeat the operations in steps 5 to 7.

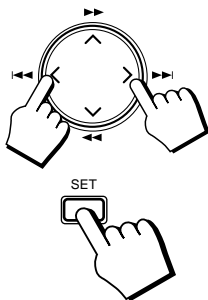

6. Press the cursor key to the right or left (◀◀ < or > ▶▶) to select the track.

The track number appears on the display.

7. Press the SET button.

The blinking disc number and track number changes to a steady light, and the step number is displayed.

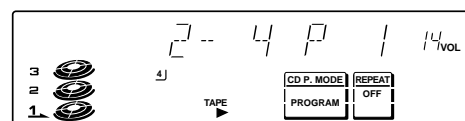
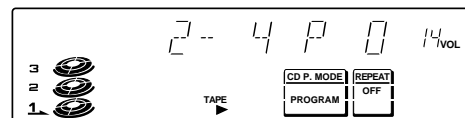

8. Repeat steps 5 to 7 to select the other tracks for the program.

- To select another track from the same disc, repeat the procedure from step 6.

9. Press the ▶ or CD button.

The Unit plays the tracks in the order you have programmed them.

Using the Remote Control



1. Press the PLAY MODE button to select PROGRAM.

"PROGRAM" lights up on the display.

The display changes with each press of the PLAY MODE button as below.

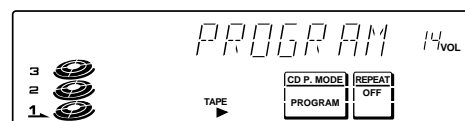

→ CONTINUE → PROGRAM → RANDOM → (back to the beginning)

2. Select a disc with the DISC (1-3) buttons.

The display changes to the Program Entry display and the disc number and track number sections blink for a few seconds.

- While the display is blinking, perform the operations in step 3. When the blinking display changes to the "PROGRAM" display, repeat the operations in steps 2 to 3.

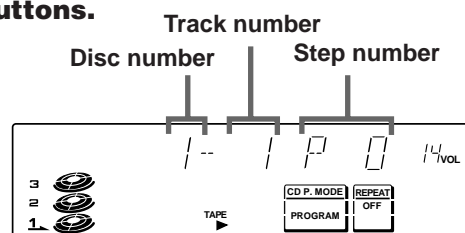

3. Press the number keys (1 to 10 and +10) to select the track to program.

- Example: For track 5, press 5. For track 15, press +10 then 5. For track 20, press +10 then 10. For track 32, press +10 three times, then 2.

The blinking disc number and track number changes to a steady light, and the step number is displayed.

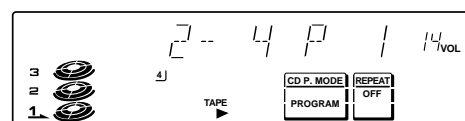

4. Repeat steps 2 to 3 to select the other tracks for the program.

5. Press the ▶ or CD button.

The Unit plays the tracks in the order you have programmed them.

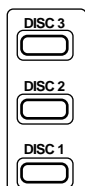

- If you try to program a 33rd track, the System lets you know that the program is full by displaying the message "FULL" on the display.
- If you try to program a disc tray that is empty, or a track number that does not exist on a disc (for example, selecting track 14 on a disc that only has 12 tracks), the selected disc or track are skipped when the program is played.
- You can skip to a particular step in a program during program play. Using the unit, press the right or left (◀◀◀◀◀ or ▶▶▶▶▶) cursor key, to this from the Remote Control, press the ◀◀◀◀◀ or ▶▶▶▶▶ button.
- You can also repeat a step in a program. See page 33 "Repeating a Track or the Discs".

To stop playing, press the ■ button.

To delete all the tracks in a program, press the CANCEL button on the Unit repeatedly until all the tracks in the program have been deleted, or press the ALL CD EJECT button.

To exit Program mode, press the PLAY MODE button on the Remote Control and select CONTINUE, or press the MENU button on the Unit and use the cursor keys to select CONTINUE in CD P.MODE.

To Check the Program

While the CD Player is stopped, use the ◀◀◀◀◀ or ▶▶▶▶▶ button on the Remote Control to check the contents of the program.

Each time you press the ▶▶▶▶▶ button on the Remote Control, the program contents are shown on the display in the programmed order. Pressing the ◀◀◀◀◀ button on the Remote Control displays the previous step in the program.

To Modify the Program

Modify the contents of a program while the CD Player is stopped.

Press the CANCEL button on the Unit, the last track in the program is deleted.

Each time you press the button, the last track listed in the program is deleted from the program.

To add a track to the program, follow the procedure above (on either the Unit or the Remote Control). The new tracks are added to the end of the program.

Random Play

The tracks will play in no special order when you use this mode.

- You can use this mode when the CD Player is stopped.

Using the Unit

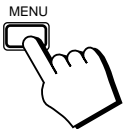

1. Press the MENU button.

The TIMER section of the menu display blinks.

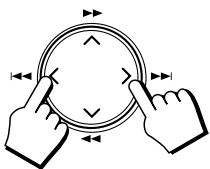
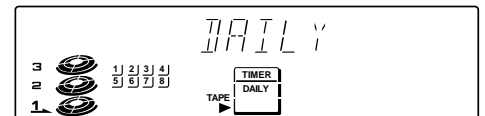

2. Press the cursor key to the right or left (◀◀◀◀◀ or ▶▶▶▶▶) and select "CD P.MODE".

The menu display changes with each press of the cursor keys as shown below.

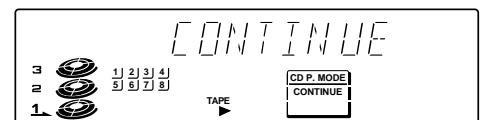

← Press the left (◀◀◀◀◀) cursor key

↔ TIMER ↔ CD P.MODE ↔ REPEAT ↔ AUTO EDIT ↔ SEA CONTROL ↔

Press the right (▶▶▶▶▶) cursor key →

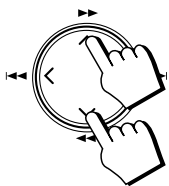

3. Press the cursor key to the up or down (▶▶▶▶▶ ^ or v ◀◀◀◀◀) and select "RANDOM".

The menu display changes with each press of the cursor keys as shown below.

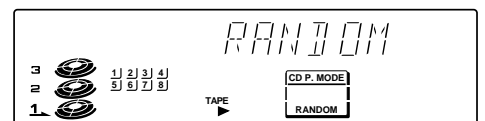

← Press the up (▶▶▶▶▶ ^) cursor key

↔ CONTINUE ↔ PROGRAM ↔ RANDOM ↔

Press the down (v ◀◀◀◀◀) cursor key →

"RANDOM" appears on the display.

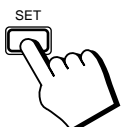

4. Press the SET button.

The blinking "RANDOM" display changes to a steady display.

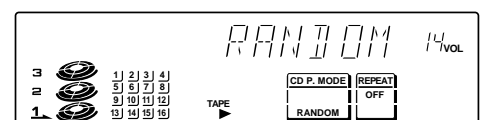

5. Press the ► or CD button.

The tracks are played in random order.

When all of the tracks have been played, the CD Player stops.

Using the Remote Control**1. Press the PLAY MODE button to select RANDOM.**

“RANDOM” lights up on the display.

The display changes with each press of the PLAY MODE button as shown.

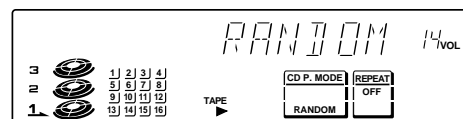

→ CONTINUE → PROGRAM → RANDOM → (back to the beginning)

2. Press the ► ^ or CD button.

The tracks are played in random order.

When all of the tracks have been played, the CD Player stops.

Note: Press the DISC (1-3) buttons, or the number keys, to cancel Random play and begin playback in Continuous Play mode.

- To instruct the CD Player to continue with a different random selection after the current setting has finished before starting random play, or while a random selection is playing, see page 33 “Repeating a Track or the Discs”.

To skip to the next track in the random program, press the > ►► cursor key or ►►►► > button on the Remote Control.

To cancel random play, press the ■ button, then press the PLAY MODE button on the Remote Control to select another mode, or press the MENU button on the Unit and use the cursor keys to select a different mode.

Repeating a Track or the Discs

You can have all the discs, the program or the individual track currently playing repeat as many times as you like.

Using the Unit**1. Press the MENU button.**

The TIMER section of the menu display blinks.

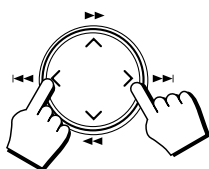
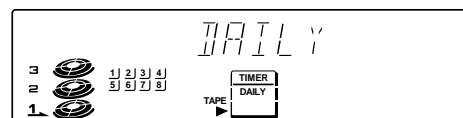
**2. Press the cursor key to the right or left (◀◀◀◀ or ▶▶▶▶) and select “REPEAT”.**

The menu display changes with each press of the cursor keys as shown below.



← Press the left (◀◀◀◀) cursor key

↔ TIMER ↔ CD P.MODE ↔ REPEAT ↔ AUTO EDIT ↔ SEA CONTROL ↔
Press the right (▶▶▶▶) cursor key →

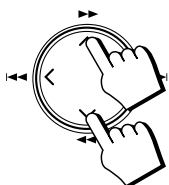
**3. Press the cursor key to the up or down (▶▶▶ ^ or v ◀◀◀) and select Repeat mode.**

The menu display changes with each press of the cursor keys as shown below.

← Press the up (▶▶▶ ^) cursor key
↔ ALL ↔ 1 CD ↔ 1 ↔ OFF ↔
Press the down (v ◀◀◀) cursor key →



ALL: Repeats all the tracks on the CD's in the CD Player, or all the tracks in the program.

1 CD: Repeats all the tracks on one CD.

1: Repeats one track on a CD.

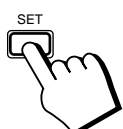
**4. Press the SET button.**



Using the Remote Control

Press the REPEAT button.

The display changes with each press of the button, as shown below.

→ ALL → 1 CD → 1 → OFF → (back to the beginning)

- “REPEAT ALL” and “REPEAT 1” remain on the display even when you change the CD play mode.
- The three Repeat Modes above can be selected during Continuous Play, however, during Program Play and Random Play, you can only select REPEAT ALL or REPEAT 1.

To exit Repeat Mode, select “OFF” in step 3.

Tray Lock Function

In order to safely keep the discs in the CD Player, the three trays can be electronically locked in a single operation. When the electronic lock is on, the trays cannot be opened even if the ▲ or ALL CD EJECT button is pressed.

This function can only be accessed by using the buttons on the Unit itself.

Locking the Electronic Lock

1. Put the System's power into STANDBY mode.

2. While pressing the ■ button, press the DISC 1's ▲ button.

“LOCKED” appears on the display to let you know that the trays have been locked.

L O C K E D

When the CD Player trays are locked, pressing the ▲ or ALL CD EJECT buttons displays the message “LOCKED” on the display and the trays do not open. And the ▲ or ALL CD EJECT button can not be used to automatically turn on the power.

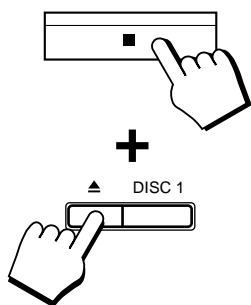

Unlocking the Electronic Lock

1. Put the System's power into STANDBY mode.

2. While pressing the ■ button, press the DISC 1's ▲ button.

When the unlock operation is done, “UNLOCKED” appears in the display to show that the lock has been taken off.

U N L O C K E D

The trays can now be opened by pressing the ▲ or ALL CD EJECT button.

The ▲ and ALL CD EJECT buttons can also be used to automatically turn on the power.

Using the Cassette Deck (Listening to a Tape)

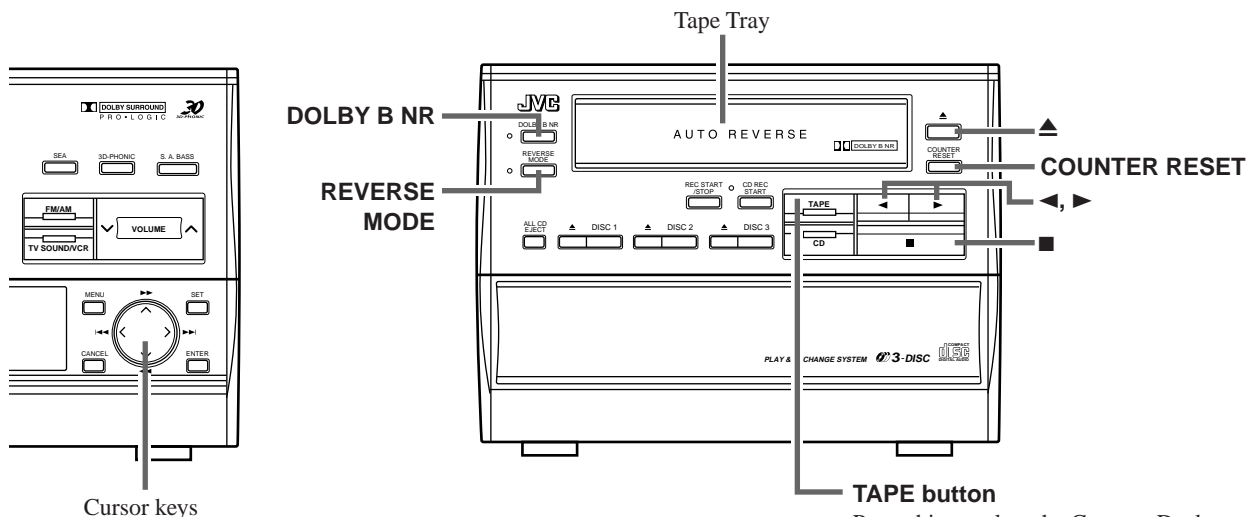

Cursor keys

TAPE button

Press this to select the Cassette Deck as the playback source. The button indicator lights up and the ◀ and ▶, buttons and the cursor keys operate in Cassette Deck control mode.

Display

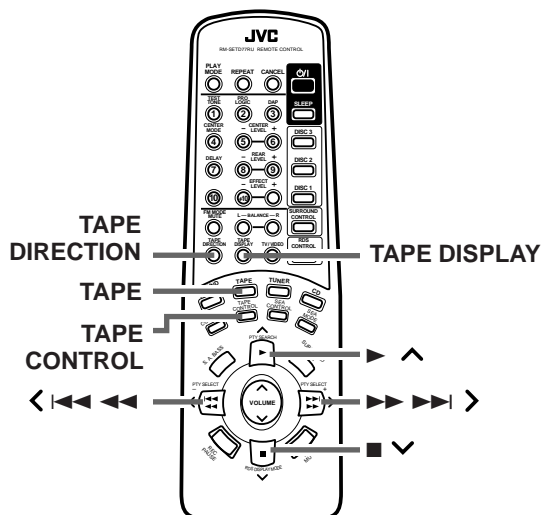

TAPE and counter display

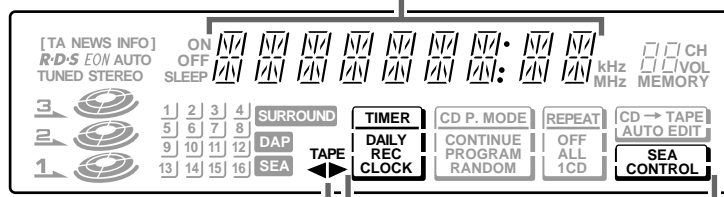

Tape Direction indicator

Menu display

TAPE button and TAPE CONTROL button

Press the TAPE or TAPE CONTROL button to switch the Remote Control to Cassette Deck control mode.

You can then use the ◀◀◀◀, ▶▶▶▶, ▶, ▼ and ▶ ▲ buttons to control the Cassette deck.

■ ▼ and ▶ ▲ buttons to control the Cassette deck.

When the System is being used, the display shows other items as well. However, we have only shown the items described in this section. This illustration shows only the Menu display items for the Cassette Deck.

The Cassette Deck allows you to play and record audio tapes.

- Most tapes are now recorded with the Dolby NR system, so first check which type of the Dolby NR system has been used on the tape. Only Dolby B NR is incorporated into the System.
- With Automatic Tape Detection, you can listen to type I or II tapes without changing any settings.

The use of tapes longer than 120 minutes is not recommended, since characteristic deterioration may occur and these tapes easily jam in the pinch-rollers and the capstans.

One Touch Play

Press the TAPE button (on the Unit or on the Remote Control). Press the ▶ ▲ button on the Remote Control.(When the Remote Control is in Cassette deck control mode)

The power comes on and "TAPE" lights up on the display. If there is a tape in the Tape Tray, the tape is automatically played. If there is no tape in the Tape Tray, "OPEN" appears on the display and the Tape Tray opens.



Regular Play

If the power is already on, you can use this basic procedure:

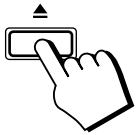

1. Press the ▲ button.

“OPEN” appears on the display and the Tape Tray opens.

2. Insert a tape into the Tape Tray with the tape head at the back.

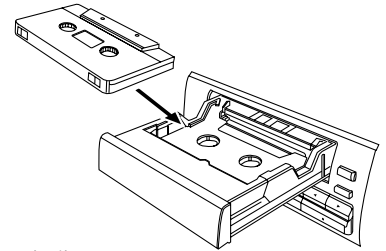

3. Press the ▲ button again.

“CLOSE” appears on the display and the Tape Tray closes.

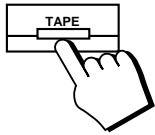

4. Press the TAPE button.

The tape is played in the direction shown by the Tape Direction indicator.

- If the Tape Tray is open, it automatically closes and the tape is played when you press the TAPE button.
- If the Cassette Deck is already selected as the playback source, press the ◀ or ▶ button to play the tape in that direction.
- If the Remote Control is in Cassette Deck control mode, press the ▶ ▲ button on the Remote Control to play the tape in the direction shown by the Tape Direction indicator.

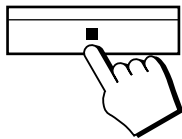

To stop playing, press the ■ button on the Unit or press the ■ ▼ button on the Remote Control after switching to Cassette deck control mode.

To remove the tape, press the ▲ button. The tape automatically stops and the Tape Tray opens.

To change the direction of playback for the tape, press the ◀ or ▶ button. If you are using the Remote Control, press the TAPE DIRECTION button.



Tape Direction Indicator and the Display

Tape Direction indicator

The Tape Direction indicator shows you which direction the tape is being played in. The direction of playback and the Tape Direction indicator display are shown below.

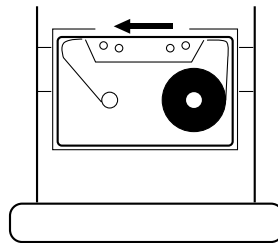

When the indicator is ▶

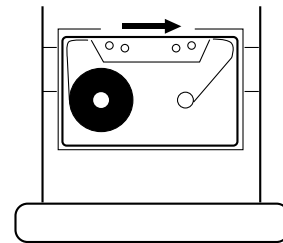

When the indicator is ◀

- During playback, the Tape Direction indicator blinks slowly. During fast left or fast right, the indicator blinks quickly. During Music Scan mode, the direction indicator alternates between blinking slowly and quickly repeatedly.

Display

TAPE 0000

The display includes a tape counter which shows you which direction a tape is being played. The tape counter increases when the tape is playing in the ▶ direction, and decreases when the tape is played in the ◀ direction.

- When the Tape Direction indicator shows ▶, the counter increases when you fast forward a tape and decreases when you rewind a tape.
When the Tape Direction indicator shows ◀, the counter decreases when you fast forward a tape and increases when you rewind a tape.
- When the Tape Direction indicator shows ▶, the following happens when you do a Music Scan.
 - When you scan to the next selection, the counter increases.
 - When you scan to the previous selection, the counter decreases.
- When the Tape Direction indicator shows ◀, the following happens when you do a Music Scan.
 - When you scan to the next selection, the counter decreases.
 - When you scan to the previous selection, the counter increases.



To reset the tape counter, press the COUNTER RESET button. The counter returns to “0000”.

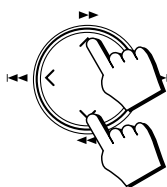

Fast Forward and Rewind

Press the ►► ^ or v ◀◀ cursor key.

- When the Tape Direction indicator shows ►, the tape fast forwards when you press the ►► ^ key and rewinds when you press the v ◀◀ key.
- When the Tape Direction indicator shows ◀, the tape rewinds when you press the ►► ^ key and fast forwards when you press the v ◀◀ key.
 - When using the Remote Control, press the ◀◀◀◀ or ►►►► button while the tape is stopped after pressing the TAPE or TAPE CONTROL button.

Music Scan

To find the beginning of a music selection, use the Music Scan function. Music Scan searches for blank portions that usually separate selections, then plays the next selection.

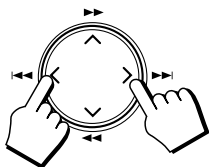

Press the ◀◀◀◀ ◀ or ►►►►►► cursor key.

- When the Tape Direction indicator shows ►.
 - Press the ►►►► button to scan to the next selection. Press the ◀◀◀◀ button to scan to the previous selection.
- When the Tape Direction indicator shows ◀.
 - Press the ◀◀◀◀ button to scan to the next selection. Press the ►►►► button to scan to the previous selection.
 - When using the Remote Control press the ◀◀◀◀ or ►►►► button while playing or Music Scanning after pressing the TAPE or TAPE CONTROL button.

When you press the left or right cursor keys (◀◀◀◀ ◀ or ►►►►►►) while the tape is stopped, the unit scans the first part of the selection in the corresponding direction and automatically plays the track.

Music Scan works by detecting a 4-second long blank at the beginning of each selection, so it won't work well if your tape has:

- No blank at the beginning of a selection.
- Noise (often caused by much use or poor quality dubbing) which fills the blank with noise.
- Long, very soft passages or pauses in a selection. The scan will detect these as 4-second long blanks. If this happens, just scan again until you reach the selection you want.

Other Useful Features of the Cassette Deck

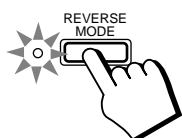

Reverse Mode

Use Reverse Mode to make the tape automatically reverse at the end of a side and start playing the other side. Press the REVERSE MODE button to switch Reverse Mode on (the indicator lights up) or off (the indicator goes off).

When the Reverse Mode is set to off (the indicator goes off), the tape stops playing after being played on one side.

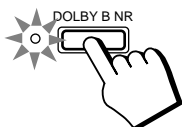

DOLBY B NR

Press the DOLBY B NR button to switch Dolby B Noise Reduction on (the indicator lights up) or off (the indicator goes off). If a tape is recorded with the Dolby B NR system, playing it back with the Dolby NR on will reduce tape noise and improve the clarity of the sound.

Dolby noise reduction manufactured under license from Dolby Laboratories Licensing Corporation. "DOLBY" and the double-D symbol are trademarks of Dolby Laboratories Licensing Corporation.

To Control the Cassette Deck While Another Source is being Played

You can use the Remote Control to rewind or fast forward a tape while another source is being played.

1. Press the TAPE CONTROL button.

The Remote Control switches to Cassette Deck control mode.

2. Press the ◀◀◀◀ ◀ or ►►►►►► > button to rewind or fast forward the tape.

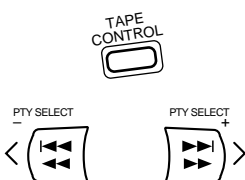

Note: You cannot use any other Cassette Deck controls, apart from fast forward and rewind, while another source is being played.

Using the Cassette Deck (Recording)

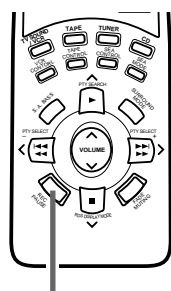
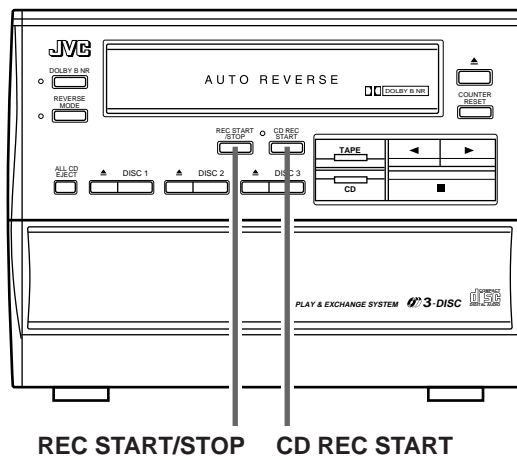
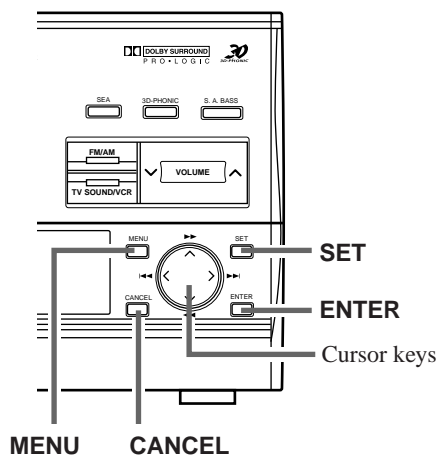

Display

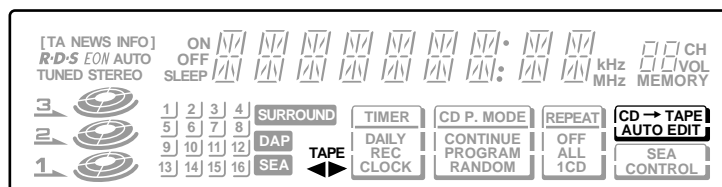

When the System is being used, the display shows other items as well. However, we have only shown the items described in this section.

Recording onto a cassette from any of the sound sources is simple. Just place a tape in the Tape Tray, have the source ready, make one or two settings, and you're ready to record. For each source the procedure is a little different and now we'll explain just what to do for each one. If you forget, just come back to the section which has the specific procedures you need. But first, here are a few things to make your recordings better.

Things To Know Before You Start Recording

- It may be unlawful to record or play back copyrighted material without the consent of the copyright owner.
- Press the DOLBY B NR button — the indicator lights up — to reduce tape hiss.
- When you want to record onto both sides of a tape, you can set Reverse mode on to do so. However, recording automatically stops after recording in the ◀ direction in Reverse mode. Therefore, make sure that the tape direction is ▶ when recording with Reverse mode on.
- The recording level, which is the volume at which the new tape is being made, is automatically set correctly, so it is not affected by the VOLUME control on the System. Thus, during recording you can adjust the sound you are actually listening to without affecting the recording level.
- Two small tabs on the back of the cassette tape, one for side A and one for side B, can be removed to prevent accidental erasure or re-recording. To record on a cassette with the tabs removed, you must cover the holes with adhesive tape first. However, when a type II tape is used, only cover part of the hole as shown, since the other part of the hole is used to detect the tape type.
- When recording, you can hear Sound Mode effects through the speakers or headphones. However, the sound is recorded without Sound Mode effects.
- Type I and Type II tapes can be used for recording.

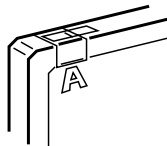

Note: At the start and end of cassette tapes, there is leader tape which cannot be recorded onto. Depending on the recording source, the first part of the recording may be missing because of the leader. When recording CDs or radio broadcasts, to get the beginning of the recording on the tape, first wind on the leader before beginning recording.

CAUTION: If recordings you have made have excessive noise or static, the Unit may be too close to a TV which was on during the recording. Either turn off the TV or increase the distance between the TV and the System.

Standard Recording

This is the basic method for recording any source. The System also has special ways for recording CD to tape which save you time and effort, as well as give you some special effects. However, when you need to add a selection to a tape you have made, or are combining selections from several sources on one tape, use the method described below; just substitute the source you want into this procedure, such as a CD or the Tuner. You can also record from VCR with this procedure.

To Record Any Sound Source To Tape

1. Insert a blank or erasable tape into the Tape Tray. (See page 36.)

2. When recording on both sides of a tape, set Reverse Mode to on (the indicator lights up).

- If you are recording while Reverse Mode is on, insert the tape so that it will be recorded in the forwards ► direction. (See page 36.)

3. Check the recording direction for the tape.

Check that the Tape Direction indicator is the same as that for the tape in the Tape Tray. If the directions are different, press the ■ button after pressing the ◀ or ▶ button to set the tape direction. (When using the Remote Control, press the TAPE DIRECTION button to synchronize the tape direction.)

- If you are recording while Reverse Mode is on, check that the Tape Direction indicator is in the forwards ► direction then press the ■ button. (When using the Remote Control, press the TAPE DIRECTION button so that the Tape Direction indicator is in the ► direction.)

4. Prepare the source, by, for example, tuning in a radio station, loading CDs, or turning on connected equipment.

5. Press the REC START/STOP button.

The recording indicator blinks and the System begins to record.



Notes for using Reverse Mode for recording

If you are recording while Reverse Mode is on, the System automatically stops when it reaches the end of the reverse ◀ direction. To record on both sides of a tape, make sure that the recording direction for the tape inserted into Tape Tray is forwards ►, and that the Tape Direction indicator is also forwards ►, before you start recording.

To Pause at Any Time During the Recording

Press the REC PAUSE button after pressing the TAPE CONTROL button on the Remote Control. The Recording indicator changes from a blinking display to a steady display. To continue the recording, press the REC START/STOP button on the Unit or the ► ^ button after pressing the TAPE CONTROL button on the Remote Control.



To Stop at Any Time During the Recording Process

Press the REC START/STOP button on the Unit or the ■ v button after pressing the TAPE CONTROL button on the Remote Control.

Checking the Tape Counter While Recording

You can check the tape counter while you are recording.

Press the TAPE DISPLAY button on the Remote Control while recording.

The display changes from the source display to the counter display for about five seconds.



How to create a blank section on the tape

1. Select the CD as a source and stop the CD.

2. Press the REC START/STOP button, to create a blank section on the tape.

3. After you have created a blank space, press the REC START/STOP button again to stop recording.

If you are recording an AM (MW/LW) broadcast and you hear interference, move BEAT CUT switch on the back panel from position 1 (the normal mode) to position 2.

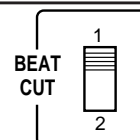

CD Direct Recording

Everything on the CD goes onto the tape in the order it is on the CD, or according to the order you have set in a program.

1. Prepare CDs. (See page 27.)

- Check that the CD Player is not playing a CD.
 - Set the source to CD.

2. Insert a cassette into the Tape Tray to record on.

When you want to record on both sides of a tape, press the REVERSE MODE button to turn Reverse Mode on. Check that the recording direction for the tape and the Tape Direction indicator are correct. (See page 39 "Notes for using Reverse Mode for recording".)

3. Press the CD REC START button.

"CD) TAPE" appears on the display and the CD Player starts playing the first track to be recorded.

At the end of the tape, the System automatically goes back to the beginning of the last selection and re-records it, this time gently fading out at the end. If you selected the Reverse Mode, the reverse side starts with the last selection on the first side and will be faded out at the end again. (About 10 second blank is created at the beginning of the reverse side.) When the recording is finished, the message "CD REC FINISHED" scrolls by on the display. The CD Player and Cassette Deck stop.

To Stop at Any Time During the Recording Process

Press the REC START/STOP or ■ button.

The recording stops when you press the REC START/STOP button. If you press the ■ button, the unit creates a four second blank section of tape before stopping.

Note: When making SLEEP timer settings while doing CD Direct recording, set the time so that there is enough leeway to finish the recording before the power goes off. If the time is set to about the length of the CD, the power may go off before recording finishes.

For CD Direct Recording using more than one disc, use a blank tape. If you use a prerecorded tape, prerecorded material may not be erased between newly-recorded tracks.



Auto Edit Recording

Using Auto Edit, you can record the CD tracks to fit the tape, so a selection isn't cut off. Auto Edit is one of the best ways to copy all of a CD onto a tape.

Auto Edit programs the CD tracks in numerical order. To prevent the end of the last track on the first side from being cut off, the last track on the first side is selected to fit on the remaining tape length.

1. Prepare the CD or CDs. (See page 27.)

- Set the source to CD and check that the CD Player is not playing a CD.

2. Press the MENU button.

The "TIMER" section of the menu display blinks.

3. Press the cursor key to the right or left (◀ or ▶) and select "AUTO EDIT".

The display changes with each press of the cursor keys as shown below.



← Press the left (◀) cursor key
 ↔ TIMER ↔ CD P.MODE ↔ REPEAT ↔ AUTO EDIT ↔ SEA CONTROL ↔
 Press the right (▶) cursor key →

- You cannot select AUTO EDIT if a source other than the CD Player is selected.

4. Press the SET button.

"DISC -" blinks on the display.

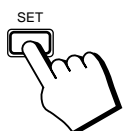
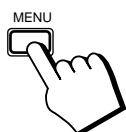

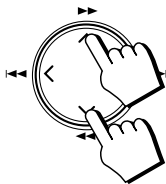

5. Press the cursor key up or down (▶▶ ^ or v ◀◀) and select the disc.

The display changes with each press of the cursor keys as shown below.

← Press the down (v ◀◀) cursor key
3 ↔ 2 ↔ 1

Press the up (▶▶ ^) cursor key →



- If you press the DISC (1-3) buttons instead of pressing the up or down (▶▶ ^ or v ◀◀) cursor keys, you can select the disc.

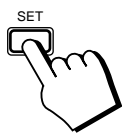

6. Press the SET button.

After "TAPE C - -" appears on the display, the display shows you the length of tape required to record the CD you selected.



- You can select a different length of tape, depending on the actual size of the tape you are using, from eleven possibilities programmed into the System: 40, 46, 50, 54, 60, 64, 70, 74, 80, 84, 90. Use the ◀◀◀ or ▶▶▶ key to select the length that matches the length of tape you will be using, or the length nearest to the length you will be using.



- If you pick a tape length shorter than the total playing time of the CD, the last tracks on both sides of the tape will be faded out as the tape ends.

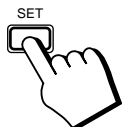

7. Press the SET button.

"SIDE-B" blinks on the display and the tracks that will be recorded on side B of the tape are displayed.



- To display the tracks that will be recorded on side A of the tape, press the SET button again.

The Unit switches between side A and side B with each press of the SET button.



8. Press the ENTER button.

9. Insert a cassette in Tape Tray to record on.

When you want to record on both sides of a tape, press the REVERSE MODE button to turn Reverse mode on.



10. Press the CD REC START button.

The Unit plays the CD and starts recording. If the tape has not been rewound, the Unit rewinds the tape before starting to record the CD.

When the tape is ready, to prevent the start of a track being cut, the System creates a blank period of about 10 seconds before it starts to record the CD. While a blank period is being created, "TAPE SIDE-A STANDBY" scrolls through the display. (The System also creates about 10 second blank period at the start of side B of the tape. While a blank period is being created, "TAPE SIDE-B STANDBY" scrolls through the display.)

When the recording is finished, the message "CD REC FINISHED" scrolls by on the display. The CD Player and Cassette Deck stop.

To stop at any time while recording, press the REC START/STOP button or the ■ button. The recording stops when you press the REC START/STOP button. If you press the ■ button, the unit creates a four second blank section of tape before stopping.

To cancel Auto Edit, press the ▲ button on the CD Player or the ALL CD EJECT button. You can also cancel Auto Edit by selecting play mode from the Unit or the Remote Control after stopping the recording.

Notes:

- If you change any of the CD's while using Auto Edit, Auto Edit will be cancelled. Therefore, do not change the CD's while using Auto Edit.
- When making SLEEP timer settings while doing Auto Edit recording, set the time so that there is enough leeway to finish the recording before the power goes off. If the time is set to about the length of the CD, the power may go off before recording finishes.

Using the Timer

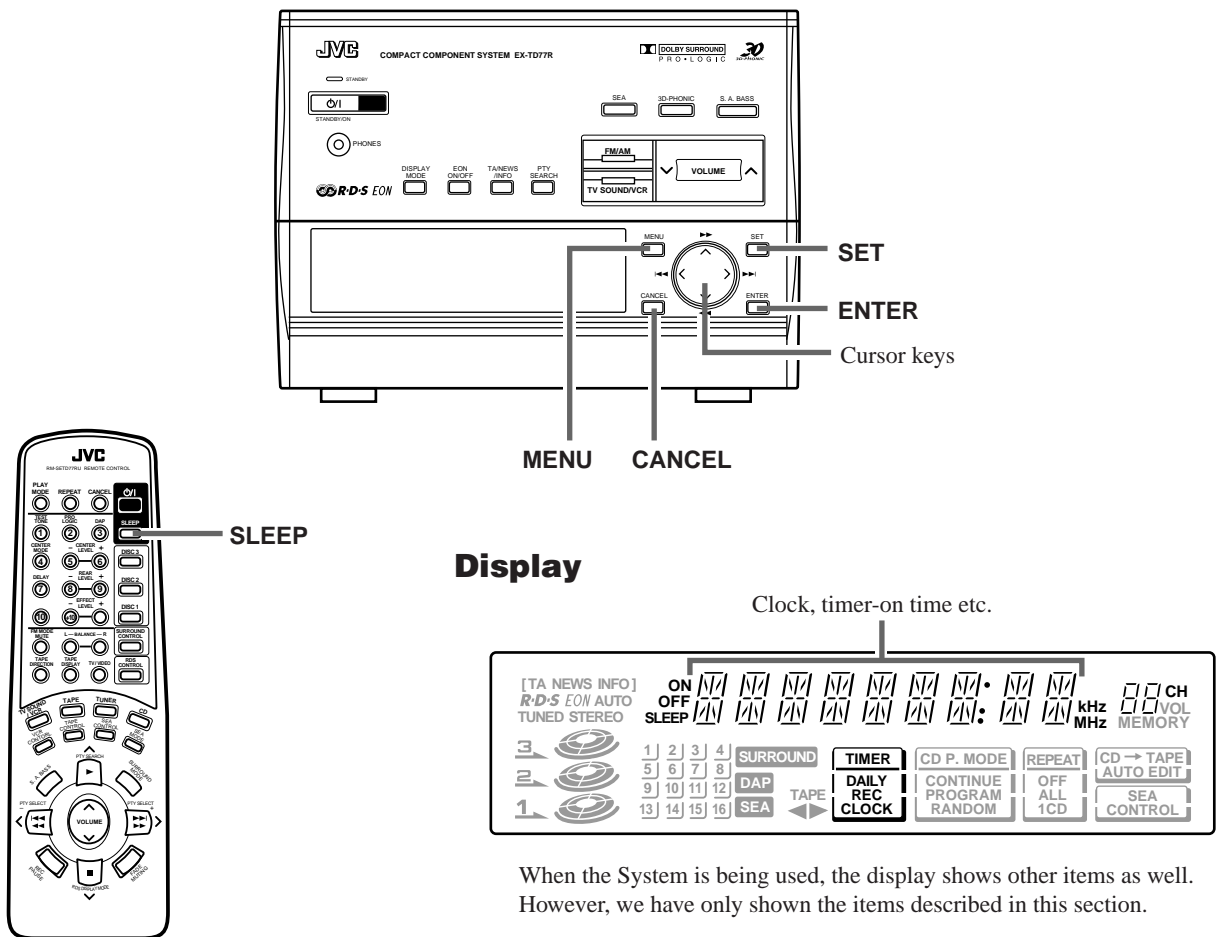

The timers lets you control recording and listening functions automatically.

Three types of timers are available:

- **DAILY Timer** — Use this timer to set wake up everyday to music from any source, instead of an alarm clock.
- **ONCE REC (Recording) Timer** — Unattended recording of radio broadcasts. You can set the starting time and length of the recording.
- **SLEEP Timer** — Fall asleep and have your System turn off automatically after a certain length of time.

Note: If you try to select a Timer mode without setting the clock, “CLOCK” and “ADJUST” are displayed alternately on the display, and you will be unable to set the timer function. (See page 8 “Setting the Clock”.)

Setting the DAILY Timer

With this timer you can wake up to music from a CD, tape, your favorite radio program.

- You can set the DAILY Timer whether the Unit is on or off.

1

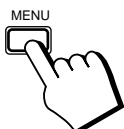

1. Press the MENU button.

“DAILY” appears on the display and the DAILY indicator in the “TIMER” section of the menu display blinks.

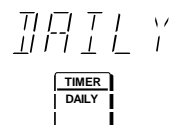

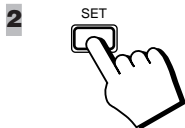

2. Press the SET button.

The display changes to the On Time display.

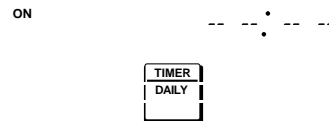

3, 4

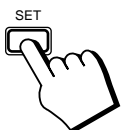
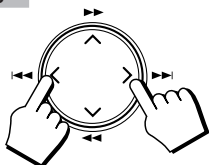

3. Set the On Time.

1. Set the hour by pressing the < or > cursor key.

Pressing the > cursor key increases the hour, and pressing the < cursor key decreases it. Pressing down either of these cursor keys adjusts the setting continuously until the key is released.

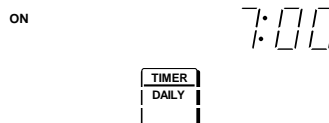

2. Press the SET button.

The minute digits on the display blink.

3. Set the minute by pressing the < or > cursor key.

Pressing the > cursor key increases the minute, and pressing the < cursor key decreases it. Holding down either of these cursor keys allows you to continuously adjust the minute setting in 10 minute increments until the key is released.

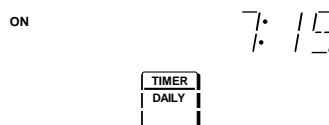

4. Press the SET button.

The On Time is set and the display changes to the Off Time setting.

4. Set the Off Time.

Use the cursor keys and the SET button to set the Off Time in the same way as for set the On time. After the Off Time minute setting has been set, the display changes to source selection display.

5

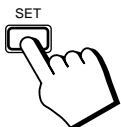
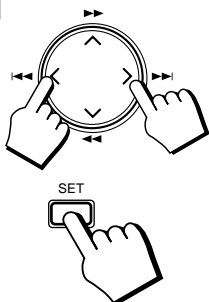

5. Select the source you want to listen to.

To use the Tuner as the source.

1. Press the left or right cursor key (< or >) until "TUNER" blinks on the display.



2. Press the SET button.

3. Press the left or right cursor key (< or >) to select the preset channel you want to listen to.

You can only select a station to receive from amongst the preset channels.

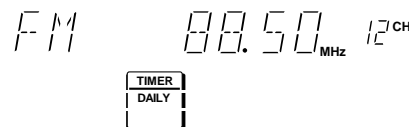

4. Press the SET button.

Proceed to step **6**.

To use a CD as the source

1. Press the left or right cursor key (< or >) until "CD" blinks on the display.

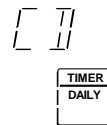

2. Press the SET button.

"DISC -" blinks on the display.

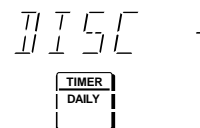

3. Press the left or right cursor key (< or >) to select the disc you want to play.

- If you select "DISC -", the last CD that was played is selected.

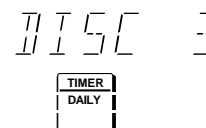

4. Press the SET button.

"TRACK -" blinks on the display.



5. Press the left or right cursor key (< or >) to select the track you want to play.

You can only select up to 20 tracks.

- If you select "TRACK -", play back starts for the first track of the CD.



6. Press the SET button.

Proceed to step **6** .

To use a Cassette Deck as the source

- 1. Press the left or right cursor key (◀◀◀ or ▶▶▶) until "TAPE" blinks on the display.**

T A P E

- 2. Press the SET button.**

Proceed to step **6** .

To Use the current source as the playback source:

- 1. Press the left or right cursor key (◀◀◀ or ▶▶▶) until "- - -" blinks on the display.**

- - - - -

- 2. Press the SET button.**

Proceed to step **6** .

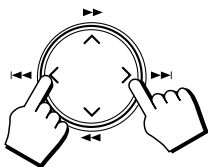
6**6. Setting the volume level.**

Press the left or right cursor key (◀◀◀ or ▶▶▶) to adjust the volume level.

V O L U M E A

VOLUME - A: Sets the volume level to 5.

VOLUME - B: Sets the volume level to 12.

VOLUME - C: Sets the volume level to 20.

VOLUME - - : Sets the volume to the last volume setting used.

7**7. Press the ENTER button.**

The "DAILY" indicator changes from a blinking display to a steady display. The ON TIME, OFF TIME, PLAYBACK SOURCE (including the disc number and track number if a CD source is selected) are displayed then the display reverts to the previous display, before the Timer was set. Turn the power off if you made the timer settings with the power turned on.

- If you make a mistake while setting the Timer, press the CANCEL button to return to the previous setting. You can use the CANCEL button to return to the On Time setting.
- A few seconds before the start time for the timer, the System automatically turns on the power and displays "DAILY" and "TIMER" alternately on the display. When the set time is reached, playback starts using the selected source. A few seconds before the end time for the timer, "TIMER" blinks on the display and when the end time is reached the power is automatically turned off again.
- If you change the source while the DAILY timer is running, the timer operation is cancelled.

Before Turning Off the Unit

- If the source is a CD, make sure that there is a CD in the selected disc number.
- If the source is a tape:
 - Make sure that there is a tape in the Tape Tray.
 - Check that the tape direction is correct. This is important especially when Reverse Mode is off.
 - Set Reverse Mode on if you want to play both sides of the tape.
- Select the Sound Mode if you want to listen using a Sound Mode effect.

To change the DAILY Timer setting

To change the settings for the DAILY Timer, repeat the setting procedure from the beginning.

Turning the DAILY Timer On and Off

Once the DAILY Timer has been set, it will be activated at the same time every day until the setting is turned off.

To Turn the DAILY Timer Off**1**

- 1. Press the MENU button.**

"DAILY" appears on the display and the DAILY indicator in the "TIMER" section of the menu display blinks.

2

- 2. Press the CANCEL button.**

"DAILY OFF" appears on the display and the DAILY indicator in the TIMER section of the menus goes out.

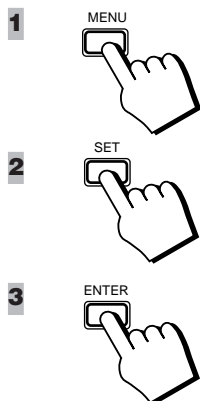

To Turn the DAILY Timer On Again

1. Press the MENU button.

“DAILY” appears on the display and the DAILY indicator in the “TIMER” section of the menu display blinks.

2. Press the SET button.

3. Press the ENTER button.

The DAILY indicator in the TIMER section of the menu changes from a blinking display to a steady display. The Timer ON TIME, OFF TIME, PLAYBACK SOURCE (including the disc number and track number if a CD source is selected), and VOLUME LEVEL are displayed on the display.

CAUTION: If the System is unplugged, or a power failure occurs, the timer setting will be erased in a few days. If the settings are erased in this way, reset the timer settings.

Setting the ONCE REC (Recording) Timer

With the Recording Timer you can make a tape of a radio broadcast automatically whether or not you are home. For the timer to work correctly, you need to make sure of the following in addition to setting the time for the Tuner and Cassette Deck to come on:

- You can set the ONCE REC Timer whether the Unit is on or off.
- The tape you want to record onto must be in Tape Tray.

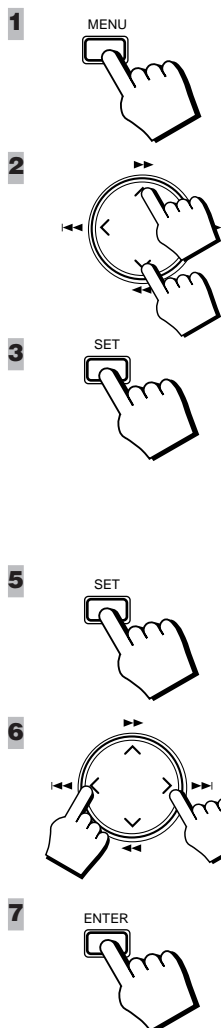

1. Press the MENU button.

“DAILY” appears on the display and the DAILY indicator in the “TIMER” section of the menu display blinks.

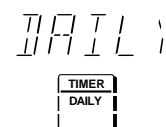

2. Press the up or down cursor key (▶▶ ^ or v ◀◀) until “REC” blinks on the display.

“ONCE REC” appears on the display and the REC indicator in the “TIMER” section of the menu display blinks.

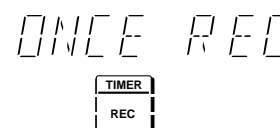

3. Press the SET button.

The display changes to the On Time display.

4. Set the On Time and Off Time

Use the ◀◀◀ or ▶▶▶ key, and the SET key to set the start and end times in the same way as for the DAILY Timer.

When you press the SET button after setting the Off Time, “TUNER” starts to blink on the display.



5. Press the SET button.

The display changes to the preset channel selection screen.

6. Press the left or right cursor key (◀◀◀ or ▶▶▶) to select the preset channel you want to listen to.

You can only select a station to receive from amongst the preset channels.

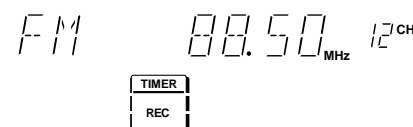

7. Press the ENTER button.

The “REC” indicator changes from a blinking display to a steady display. The ON TIME, OFF TIME, and preset channel number are displayed then the display reverts to the previous display, before the Timer was set.

Turn the power off if you made the timer settings with the power turned on.

- If you make a mistake while setting the Timer, press the CANCEL button to return to the previous setting. You can use the CANCEL button to return to the On Time setting.
- A few seconds before the start time for the timer, the System automatically turns on the power and displays “ONCE REC” and “TIMER” alternately on the display. When the set time is reached, playback starts using the selected source. A few seconds before the end time for the timer, “TIMER” blinks on the display and when the end time is reached the power is automatically turned off again.
- If you change the source while the ONCE REC timer is running the timer operation is cancelled.

Before the Timer Starts

- Check that tape direction is correct. This is important especially when Reverse Mode is off.
- Set Reverse Mode on if you want to record on both sides of the tape.
- The VOLUME control is automatically set to 0 when ONCE REC Timer is recording.

It is very easy, and can be very disappointing, to forget to put in a tape, or to accidentally leave a tape in Tape Tray you don't want recorded over. Although this happens to almost everyone at one time or another, we hope it won't happen to you!

To Change the Recording Timer Setting

To change the settings for the ONCE REC Timer, repeat the setting procedure from the beginning.

Turning the ONCE REC Timer On and Off

Once the ONCE REC Timer has been used to record a source, the setting is maintained but the Timer is set to OFF.

To Turn the REC Timer Off Before the Timer Starts.

1. Press the MENU button.

"DAILY" appears on the display and the DAILY indicator in the "TIMER" section of the menu display blinks.

2. Press the up or down cursor key (▶▶ ^ or v ◀◀) until "REC" blinks on the display.

"ONCE REC" appears on the display and the REC indicator in the "TIMER" section of the menu display blinks.

3. Press the CANCEL button.

"REC OFF" appears on the display and the REC indicator in the TIMER section of the menus goes out.

To Record at the Same Time Again.

1. Press the MENU button.

"DAILY" appears on the display and the DAILY indicator in the "TIMER" section of the menu display blinks.

2. Press the up or down cursor key (▶▶ ^ or v ◀◀) until "REC" blinks on the display.

"ONCE REC" appears on the display and the REC indicator in the "TIMER" section of the menu display blinks.

3. Press the SET button.

4. Press the ENTER button.

The DAILY indicator in the TIMER section of the menu changes from a blinking display to a steady display. The ON TIME, OFF TIME, and preset channel number are displayed then the display reverts to the previous display, before the Timer was set.

CAUTION: If the System is unplugged, or a power failure occurs, the timer setting will be erased in a few days. If the settings are erased in this way, reset the timer settings.

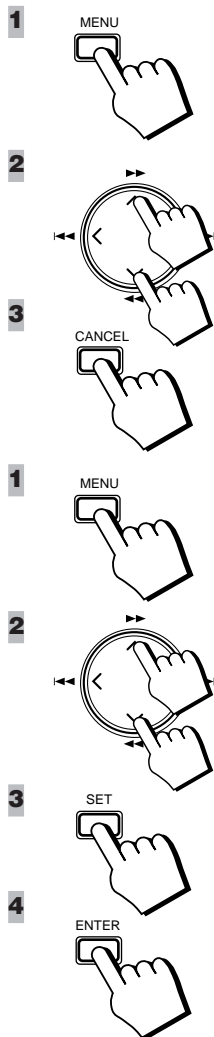

Setting the SLEEP Timer

Use the Sleep Timer to turn the Unit off after a certain number of minutes when it is playing. By setting this timer, you can fall asleep to music and know your Unit will turn off by itself rather than play all night.

■ You can only set the Sleep Timer when the Unit is on and a source is playing.

To set the SLEEP Timer, follow this procedure:



1. With the System on and a source playing, press the SLEEP button on the Remote Control.

The message "SLEEP" appears on the display.

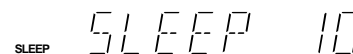

2. Set the length of time you want the source to play before shutting off.

- Each time you press this button while the "SLEEP" indicator is blinking, it changes the number of minutes shown on the display in this sequence:

→ 10 → 20 → 30 → 60 → 90 → 120 → Cancelled → (back to the beginning)

When the number of minutes you want shows on the display, just wait 5 seconds until the "SLEEP" indicator stops blinking, and is lighted steadily.

The Unit is now set to turn off after the number of minutes you set.

To Change the SLEEP Timer Setting

Press the SLEEP button until the number of minutes you want appears on the display.

To Cancel the SLEEP Timer Setting

Press the SLEEP button until the "SLEEP" indicator goes off on the display.

Turning off the Unit also cancels the SLEEP Timer.

Timer Priority

Since each timer can be set independently, you may wonder what happens if the settings overlap. Here are the priorities for each timer:

- The ONCE REC Timer always has priority. This means that:
 - If another timer is set to come on during a time when the ONCE REC Timer is operating, the other timer just won't come on at all, so you will always get the entire program on tape.
 - If the ONCE REC Timer is set to come on while another timer is operating, the other timer will shut off 10 seconds before the ONCE REC Timer is set to turn on, and the ONCE REC Timer will then take over.
- The SLEEP Timer has the least priority. This means that if the SLEEP Timer is set while the DAILY Timer is operating, the DAILY Timer settings are cancelled. However, if the DAILY Timer is set to come while the SLEEP Timer is operating, the SLEEP Timer setting will be cancelled and the Unit will use the settings from the DAILY Timer.

Example 1

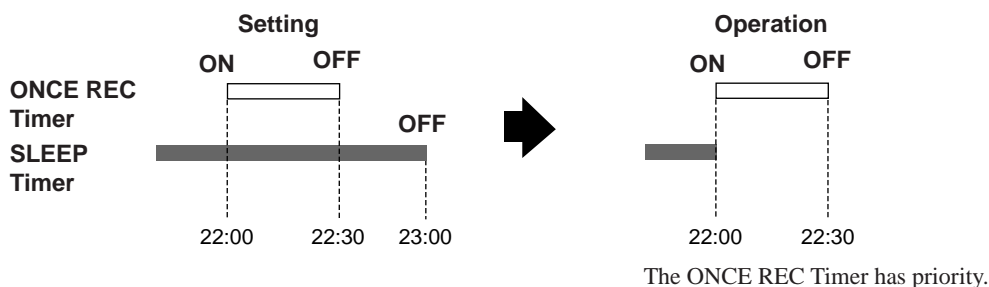

Example 2

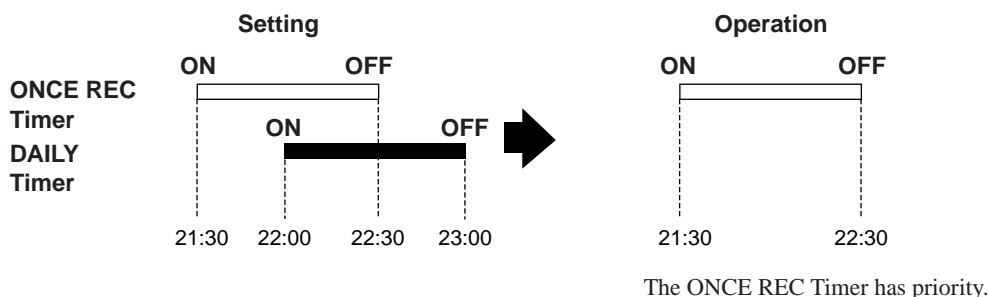

Using the VCR

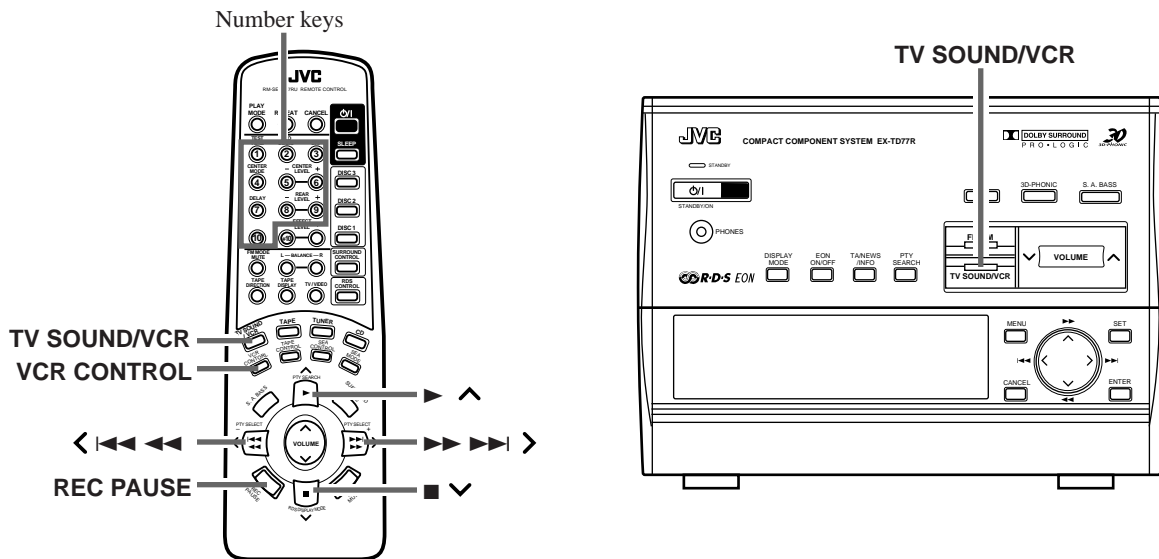

TV SOUND/VCR button and VCR CONTROL button

Press the TV SOUND/VCR or VCR CONTROL button to switch the Remote Control to VCR control mode. You can then use the <|<<<<, >>>>|>, ■, ▽, ▶, ▲, REC PAUSE, and Number keys to control the VCR.

You can use either VCR or TV as a source for System. (See page 7 for connecting diagrams.)

Operating a JVC VCR or TV

By playing the sound from VCR or TV through the System, you can gain control over how the music or program sounds. Once the connected equipment is playing through the System, you can apply the SEA or surround processor effect.

■ First make sure that the optional equipment is properly connected to the System. (See page 7.)

The Remote Control supplied with System can control JVC VCRs.

When operating a VCR, aim the Remote Control at the remote sensor on the VCR. Set the remote code of the VCR to A.

You can use the buttons on the Remote Control to operate the following functions.

- TV SOUND/VCR** Sets the System's source to TV/VCR and switches the Remote Control to VCR Control mode.
- VCR CONTROL** Sets the Remote Control to VCR Control mode but does not set the source to VCR.
- ▶ ▲ Plays back a video tape.
- ▽ Stops playback.
- <|<<<< Rewinds a video tape.
- >>>>|> Fast-forwards a video tape.
- Number keys Selects the VCR channel.
To select a 2 digit number, press tenth digit first, then unit digit. The 10 button corresponds to 0.
 - Example : For channel 10, press 1, then 10 (0). For channel 25, press 2, then 5.
- REC PAUSE** Sets the VCR to record standby mode.

Listening to a JVC VCR

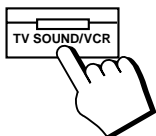

1. Set the VOLUME control to 0.

2. Press the TV SOUND/VCR button.

The TV SOUND/VCR button light comes on.

When you press the TV SOUND/VCR button on the Remote Control, sets the System's source to VCR and switches the Remote Control to VCR Control mode.

When System is in Standby mode, the Unit is automatically turned on and "TV/VCR" appears on the display.



3. Press the ► ^ button on the Remote Control.

4. Adjust the VOLUME control to the desired listening level.

5. Select the SEA or surround processor mode, if you wish.

To stop playing, press the ■ ▼ button.

To Cancel the Setting

Change the source by starting any one of the System's built-in sound sources, such as the Tuner or CD Player.

Recording of a JVC VCR

1. Prepare the VCR for recording.

Turn the power on and insert a tape to be recorded.

2. Press the VCR CONTROL button to set the Remote Control to VCR mode.

3. Select a desired channel by using the number keys.

4. Press the REC PAUSE button.

The VCR is set to standby mode.

5. Press the ► ^ button.

The VCR starts recording.

To stop the recording, press the ■ ▼ button.

To pause the recording, press the REC PAUSE button. To resume the recording, press the ► ^ button again.

Operating a JVC TV

The Remote Control supplied with System can control JVC TVs.

When operating a TV, aim the Remote Control at the remote sensor on the TV.

You can use the buttons on the Remote Control to operate the following functions.

TV SOUND/VCR Sets the System's source to TV.

TV/VIDEO Sets the input mode. (either TV or VIDEO)

Note: When you connect a TV to the System, you cannot connect a VCR since the same input terminals are used for TV.

Operating a VCR other than JVC's VCR

Listening to a VCR

Press the TV SOUND/VCR button to select a VCR as the source. Then, play the TV SOUND/VCR connected to the system according to its instruction manual.

You can adjust VOLUME control to the desired listening level and apply the sound effects on the sound from the VCR.

Recording to a VCR

To record to a VCR, start playback of the recording source of the System and start recording on your VCR. (Refer to the VCR's instruction manual for details on the recording procedure for your VCR.)

■ You cannot record using the SEA or surround processor effect.

Care And Maintenance

Compact Discs



Handle your compact discs, cassette tapes, and Cassette Deck carefully, and they will last a long time.

- Remove the CD from the case by holding it at the edges while pressing the center hole lightly.
- Do not touch the shiny surface of the CD, or bend the CD.
- Put the CD back in its case after use to prevent warping.
- Be careful not to scratch the surface of the CD when placing it back in the case.
- Avoid exposure to direct sunlight, temperature extremes, and moisture.
- A dirty CD may not play correctly. If a CD does become dirty, wipe it with a soft cloth in a straight line, from center to edge.

CAUTION: Do not use any solvent (for example, conventional record cleaner, spray thinner, benzine, etc.) to clean a CD.

Moisture Condensation



Moisture may condense on the lens inside the Unit in the following cases:

- After starting the heating in the room.
- In a damp room.
- If the unit is brought directly from a cold to a warm place.

Should this occur, the Unit may malfunction. In this case, leave the unit turned on for a few hours until the moisture evaporates, unplug the AC power cord, and then plug it in again.

General Notes

In general, you will have the best performance by keeping your tapes, CDs, and the mechanism clean.

- Store tapes and CDs in their cases, and keep them in cabinets or on shelves.
- Keep the Cassette Deck's tape holder and the CD trays closed when not in use.

Cassette Tapes





- If the tape is loose in its cassette, take up the slack by inserting a pencil in one of the reels and rotating.
- If the tape is loose, it may get stretched, cut, or caught in the cassette.
- Do not touch the tape surface.
- Do not store the tape:
 - In dusty places
 - In direct sunlight or heat
 - In moist areas
 - On a TV or speaker
 - Near a magnet

Cassette Deck

- If the heads, capstans, and pinch-rollers of the Cassette Deck become dirty, the following will occur:
 - Loss of sound quality
 - Discontinuous sound
 - Fading
 - Incomplete erasure
 - Difficulty recording
- Clean the heads, capstans and pinch-rollers using a wet-type head cleaning tape, available from an audio store. For more details, refer to the Instructions of the Head Cleaning Tape.
- If the heads become magnetized, the Unit will produce noise or lose high frequencies.
- To demagnetize the heads, turn off the Unit, and use a head demagnetizer (available at electronics and record shops).

Troubleshooting

- If you are having a problem with your System, check this list for a possible solution before calling for service.
- If you cannot solve the problem from the hints given here, or the Unit has been physically damaged, call a qualified person, such as your dealer, for service.

Symptom	Possible Cause	Action
No sound is heard.	Connections are incorrect, or loose.	Check all connections and make corrections. (See pages 4 - 7.)
Unable to record.	Cassette record protect tabs are removed.	Cover holes on back edge of cassette with tape.
Poor radio reception	<ul style="list-style-type: none"> • The antenna is disconnected. • The AM Loop Antenna is too close to the Unit. • The FM Wire Antenna is not properly extended and positioned. 	<ul style="list-style-type: none"> • Re-connect the antenna securely. • Change the position and direction of the AM Loop Antenna. • Extend FM Wire Antenna to the best reception position.
The CD skips.	The CD is dirty or scratched.	Clean or replace the CD.
Unable to operate the Remote Control.	<ul style="list-style-type: none"> • The path between the Remote Control and the sensor on the Unit is blocked. • The batteries have lost their charge. 	<ul style="list-style-type: none"> • Remove the obstruction. • Replace the batteries.
The CD tray cannot be opened.	The main AC power cord is not plugged in.	Plug in the AC power plug.
The CD does not play.	The CD is upside down.	Put the CD in with the label side up.
Operations are disabled.	<ul style="list-style-type: none"> • The built-in microprocessor has malfunctioned due to external electrical interference. • A foreign matter (headphone cable, etc.) is caught by the Main Tray cover. 	<ul style="list-style-type: none"> • Unplug the Unit then plug it back in. • Remove the foreign matter and then push the Main Tray cover by hand to close it.
The cassette door cannot be opened.	During tape playing, the power cord was unplugged.	Plug in the power cord, press the  button, and then press the  button.
“WARNING” appears in the display.	Problem arised in the Cassette Deck.	Contact your dealer.

Specifications

Amplifier/Tuner Section

Amplifier

Output Power	
SPEAKERS A (IEC 268-3/DIN) (Main)	20 watts per channel, min. RMS, both channels driven, into 6 ohms at 1 kHz with no more than 0.9% total harmonic distortion.
SPEAKERS B (Subwoofer)	30 watts per channel, min. RMS, both channels driven, into 3 ohms at 80 Hz, with no more than 10% total harmonic distortion.
Input Sensitivity/Impedance (1 kHz)	
TV SOUND/VCR	400 mV/47 kohms
Output Impedance (1 kHz)	
TV SOUND/VCR	6.8 kohms
Preset S.E.A.	3 patterns
Manual S.E.A. Control	±6 dB at 150 Hz (2 dB step) ±6 dB at 1 kHz (2 dB step) ±6 dB at 10 kHz (2 dB step)
Speaker terminals	
SPEAKERS A	6 - 16 ohms
SPEAKERS B	3 - 16 ohms

Tuner

FM Tuner	
Tuning Range	87.5 - 108.0 MHz
AM Tuner	
Tuning Range	
MW	522 - 1,629 kHz
LW	144 - 288 kHz
Dimensions	196 × 145 × 352 mm (W/H/D) (7-3/4 × 5-3/4 × 13-7/8 inches)
Mass	5.1 kg (11.3 lbs)

CD Player/Cassette Deck Section

CD Automatic Changer

CD Capacity	3 discs
Dynamic Range	96 dB
Signal-To-Noise Ratio	96 dB
Wow And Flutter	Unmeasurable

Cassette Deck

Frequency Response	
Type II (CrO ₂) :	30 - 16,000 Hz
Type I (NORMAL) :	30 - 15,000 Hz
Wow And Flutter	0.09% (WRMS)
Dimensions	196 × 145 × 348 mm (W/H/D) (7-3/4 × 5-3/4 × 13-3/4 inches)
Mass	4.2 kg (9.3 lbs)

Accessories

AM (MW/LW) Loop Antenna	(1)
Remote Control	(1)
Batteries R6P (SUM-3)/AA (15F)	(2)
FM Wire Antenna	(1)
External Wire	(1)

Power Specifications

Power Requirements	AC 230 V \sim , 50 Hz
Power Consumption	89 watts 12 watts (in standby mode)

Design and specifications are subject to change without notice.



Free Manuals Download Website

<http://myh66.com>

<http://usermanuals.us>

<http://www.somanuals.com>

<http://www.4manuals.cc>

<http://www.manual-lib.com>

<http://www.404manual.com>

<http://www.luxmanual.com>

<http://aubethermostatmanual.com>

Golf course search by state

<http://golfingnear.com>

Email search by domain

<http://emailbydomain.com>

Auto manuals search

<http://auto.somanuals.com>

TV manuals search

<http://tv.somanuals.com>