

JVC



MD-CD COMBINATION DECK PLATINE COMBINÉE MD-CD

XU-301BK

COMPU LINK
Component

TEXT
COMPU LINK

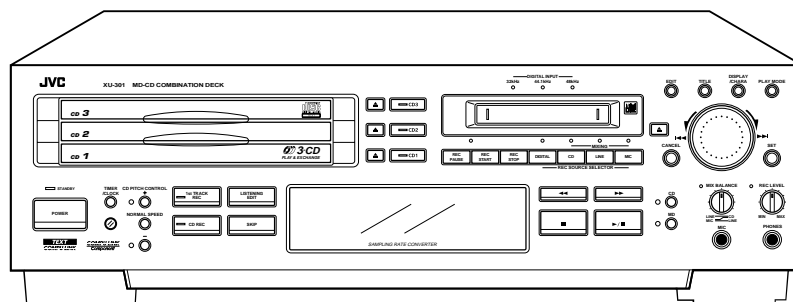
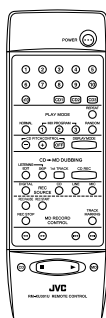

INSTRUCTIONS MANUEL D'INSTRUCTIONS

For Customer Use:

Enter below the Model No. and Serial No. which are located either on the rear, bottom or side of the cabinet. Retain this information for future reference.

Model No. _____

Serial No. _____

LVT0009-001B

[J]

Warnings, Cautions and Others/Mises en garde, précautions et indications diverses



The lightning flash with arrowhead symbol, within an equilateral triangle, is intended to alert the user to the presence of uninsulated "dangerous voltage" within the product's enclosure that may be of sufficient magnitude to constitute a risk of electric shock to persons.



The exclamation point within an equilateral triangle is intended to alert the user to the presence of important operating and maintenance (servicing) instructions in the literature accompanying the appliance.

WARNING:
TO REDUCE THE RISK OF FIRE OR ELECTRIC SHOCK, DO NOT EXPOSE THIS APPLIANCE TO RAIN OR MOISTURE.

CAUTION

To reduce the risk of electrical shocks, fire, etc.:

1. Do not remove screws, covers or cabinet.
2. Do not expose this appliance to rain or moisture.

AC power cord

The AC power cord of this unit has certain one-way direction connections to prevent electric shock. Refer to the illustration for correct connection.

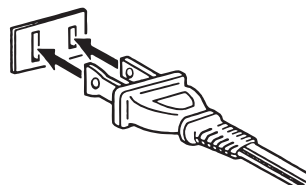

(For CANADA)

CAUTION
TO PREVENT ELECTRIC SHOCK, MATCH WIDE BLADE OF PLUG TO WIDE SLOT, FULLY INSERT.

(Pour le CANADA)

ATTENTION
POUR EVITER LES CHOCS ELECTRIQUES, INTRODUIRE LA LAME LA PLUS LARGE DE LA FICHE DANS LA BORNE CORRESPONDANTE DE LA PRISE ET POUSSER JUSQU'AU FOND.

Thank you for purchasing this JVC product. Please read these instructions through carefully before starting operation to ensure that you will derive the optimum performance and a long service life from your unit.

Table of Contents

BEFORE OPERATION

Precautions	2
Features	3
Connections	4
Names of the Parts	6
Using the Remote Control	8
Power ON/OFF Operations	11

PLAY OPERATIONS

Listening to CDs	12
• Giving a Title to a CD	17
Listening to MDs	20
MIX PROGRAM Play	24

RECORDING/EDITING OPERATIONS

Recording onto MDs	26
• Manual Recording	28
• CD Recording (single-action recording)	29
• CD Recording (1st TRACK recording)	30
• CD Recording (LISTENING EDIT recording)	31
• Mixing Recording	32
MD Editing Functions	34
• Dividing tracks (DIVIDE function)	35
• Joining tracks (JOIN function)	36
• Moving tracks (MOVE function)	37
• Erasing a track (ERASE function)	39
• Erasing all the tracks (ALL ERASE function)	40
• Giving titles to discs and tracks (TITLE function)	41
Character Layout Table	44

CLOCK/TIMER FACILITIES

Setting the Clock	45
Timer Operations	46
• Timer Play (Wake-up play)	46
• Timer Recording	49

IMPORTANT INFORMATION

COMPU LINK Function	50
TEXT COMPU LINK Control System	51
Information on the MDs (Minidisks)	52
MD (Minidisk) Error Messages	53
Restrictions Imposed by MDs (Minidisks)	54
Restriction on Copying Digital Material	54
Troubleshooting	55
Main Specifications	56

Precautions

1. Safeguarding against electric shocks, fire hazards and damage

- 1) A very low current will still flow even when the POWER button is set at STANDBY. To save power and ensure safety when the unit is not going to be used for an extended period of time, disconnect the power cords from the household AC outlet.
- 2) Do not handle the power cord with wet hands.
- 3) To unplug the power cord from the wall outlet, always take hold of the molded plug part and pull the plug free rather than pulling the cord.
- 4) If the power cord is damaged or found to have a disconnected wire or a contact failure, consult your dealer.
- 5) Do not bend the cord at a sharp angle, and do not pull or twist it.
- 6) Do not modify the power cord in any way.
- 7) Do not remove the screws in order to disassemble the unit, and do not touch any of the parts inside the unit.
- 8) Do not insert metallic objects into the unit.
- 9) Unplug the power cord if there is a chance that lightning may strike.
- 10) If water should find its way inside the unit, unplug the power cord from the outlet, and consult your dealer.
- 11) Do not install the unit in a poorly ventilated location.

2. Installation

- 1) Avoid placing the unit on or adjacent to an amplifier: this is to prevent the humming caused by the unit's proximity to some types of amplifiers. Move the unit where it will not be affected by the amplifier.
- 2) Avoid installing the unit where the ambient temperature will exceed 35 °C (95 °F) (namely, in direct sunlight, near a heating appliance, etc.) or drop below 5 °C (41 °F), where it is very humid or dusty, or where the unit will be subject to vibration.
- 3) The unit may not function properly if it is moved suddenly from a cold place (0 °C (32 °F)) to a warm place since condensation may form inside the unit. In such a case, leave the unit standing for about 30 minutes, after which time it should function properly.

3. Cleaning the cabinet

Never use benzine or paint thinners to clean the cabinet as they may mar the unit's surface finish.

- **3CD + MD combination deck**
 - CD-TEXT facility supported
 - Simultaneous copying of CD-TEXT characters (track titles, etc.) onto MDs
 - Input of CD disc titles and names of artists enabled
- **Full complement of input/output facilities including optical digital, LINE and MIC**
- **Sampling rate converter which supports 3 digital sources incorporated**
 - 32 kHz, 44.1 kHz and 48 kHz
- **Mixing and recording of CD+LINE, CD+MIC or LINE+MIC recording signals possible**
 - Choice of 3 analog recording signal sources (CD, LINE and MIC)
- **3CD + MD mixing programs**
- **CD synchro recording in 3 modes: single action, 1st track and listening edit**
- **CD pitch control**
 - This enables the CD play speed to be adjusted up to 12% faster or slower than the normal play speed.
- **Timer functions**
 - Timer play and timer recording (DAILY or ONCE)
- **Remote control whose buttons can be used to input titles provided with unit**
 - Direct input of letters of alphabet possible

Connections

Do not turn on the power until all the connections have been completed.

Analog Connections

- Use the accessory pin cords to connect the unit's LINE connectors with the MD connectors on the receiver, etc.

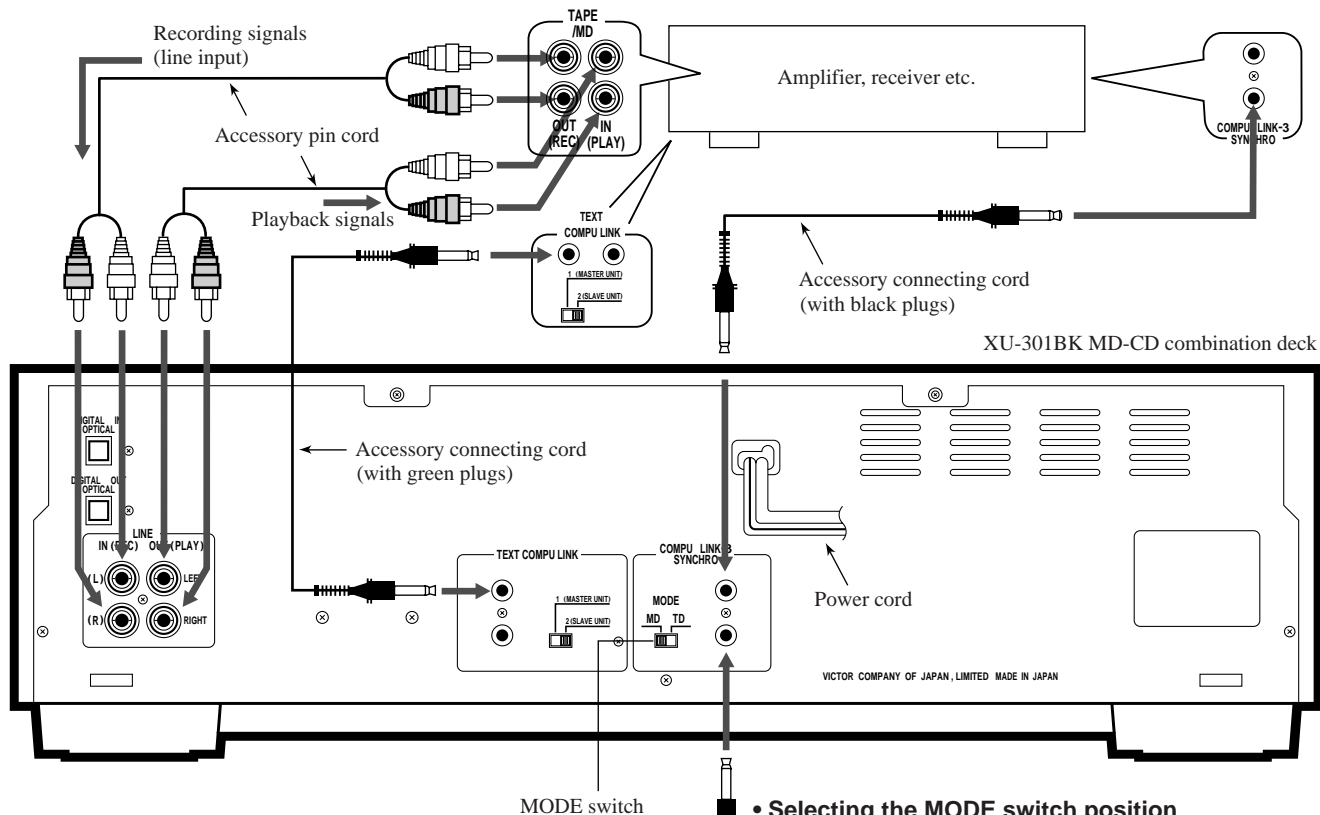

Setting of 1 (MASTER UNIT) and 2 (SLAVE UNIT) selector

Support for JVC's TEXT COMPU LINK	When connection is made to a CD player only	1 (MASTER UNIT)
	When connection is made to a receiver only	2 (SLAVE UNIT)
	When connection is made to a receiver and CD player	2 (SLAVE UNIT)

For further details on the TEXT COMPU LINK function, see page 51.

Selecting the MODE switch position

- When connected with MD input/output terminals of the amplifier or receiver
- When connected with TAPE input/output terminals of the amplifier or receiver



For further details on the COMPU LINK function, see page 50.

NOTE
 Before selecting the COMPU LINK-3 mode (MD or TD) or TEXT COMPU LINK (master or slave) function, disconnect the power cord from the power outlet to turn off the power. The function will be not be set if it is selected while the power is on. Alternatively, when the COMPU LINK-3 mode (MD or TD) or TEXT COMPU LINK (master or slave) function is selected while the power is on, disconnect the power cord and then re-connect it.

Optional connecting cord
 This is connected for synchro recording.

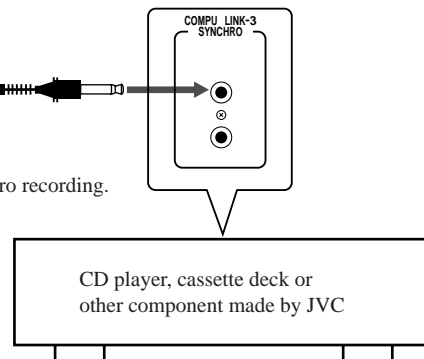

- Misconnections can be avoided by using the white plugs on the accessory pin cords for the LEFT channel and the red plugs for the RIGHT channel.
- Insert the plugs all the way in. Incomplete connections cause noise.

Digital Connections

Before proceeding, check whether the optical digital cable can be connected.

- Connect the stereo amplifier and source component to the DIGITAL (OPTICAL) connectors on the unit using the optical digital cable.
- One connecting cable is used to transmit the stereo signals (L/R) as the digital signals.

• How to use the OPTICAL connectors for the connections

1 Remove the protective cap.

- When the connector is not going to be used, fit this protective cap back in position.

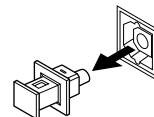

2 Check that the end of the optical digital cable is not dirty, and insert it securely.

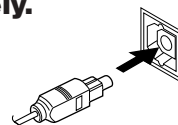

XU-301BK MD-CD combination deck

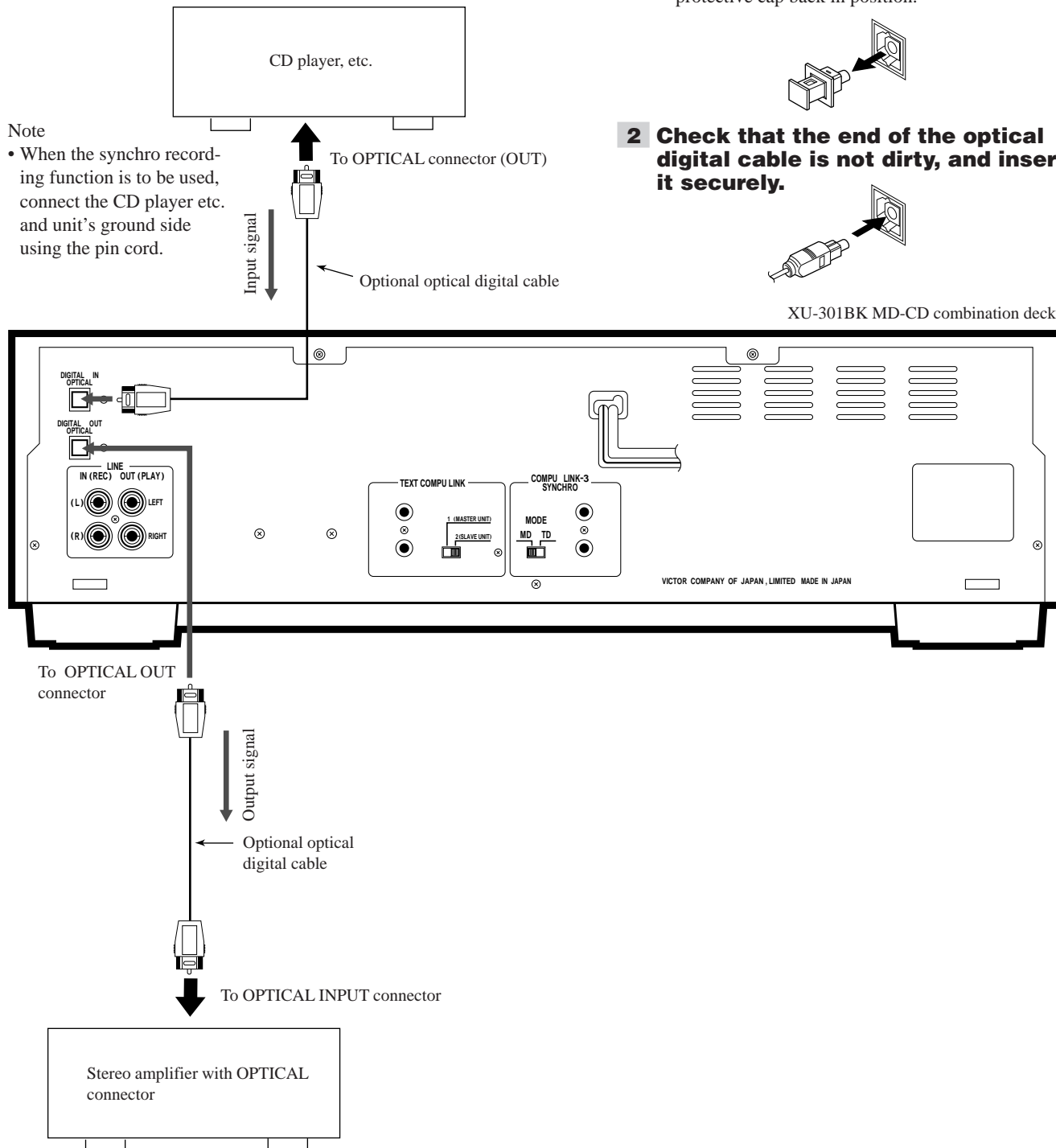

- Before purchasing an optical digital cable (optional), make sure that the cable in question can be connected to the amplifier, etc.
- Do not bend the optical digital cable.
- Red light emitted from the OPTICAL OUT connector

When the power is turned on, the inside of the connector lights up red. This light is for sending the digital signals. Although this light will not harm your eyes, keep the protective cap in place if the connector is not going to be used.

Names of the Parts

CD Parts/Common Parts

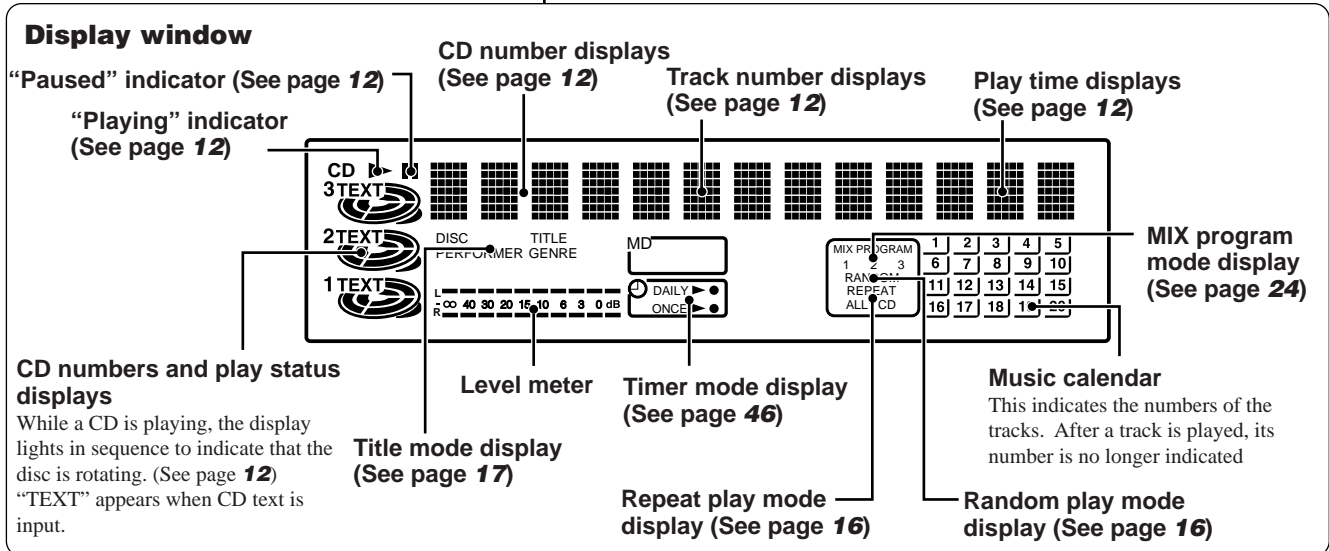
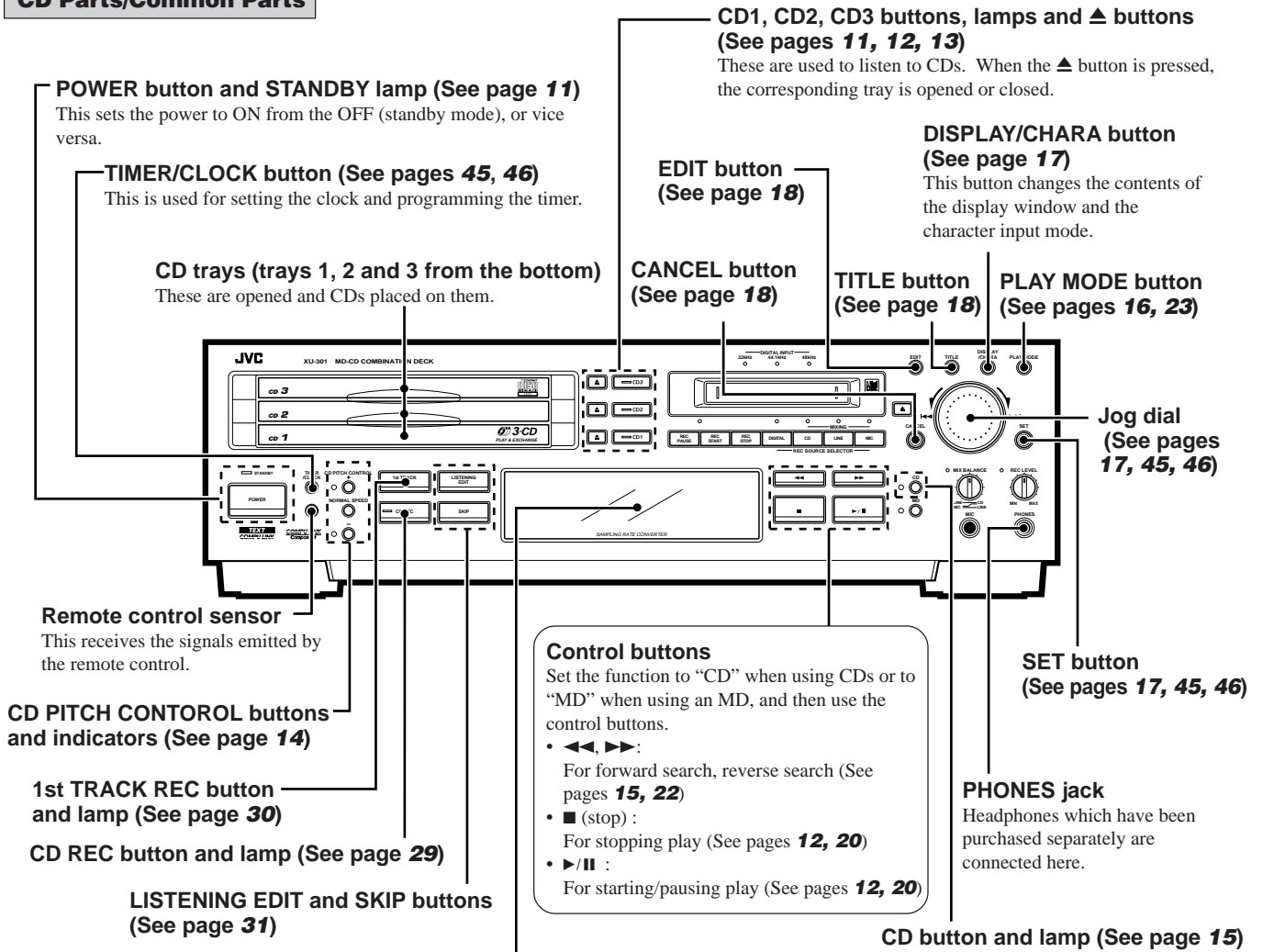

- CD play mode display
 - This display is cleared when no CD has been detected on the tray and "NO DISC" is displayed.

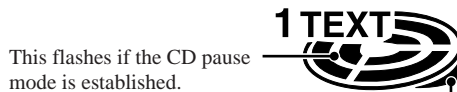

If this lights, it means that the CD on this tray can be played.

MD recording control buttons and lamp (See page 28)

- **REC PAUSE:** This is used to pause recording.
- **REC START:** This is used to start recording.
- **REC STOP:** This is used to stop recording.

DISPLAY/CHARA button (See pages 17, 21, 29, 42)

This button changes the contents of the display window and the character input mode.

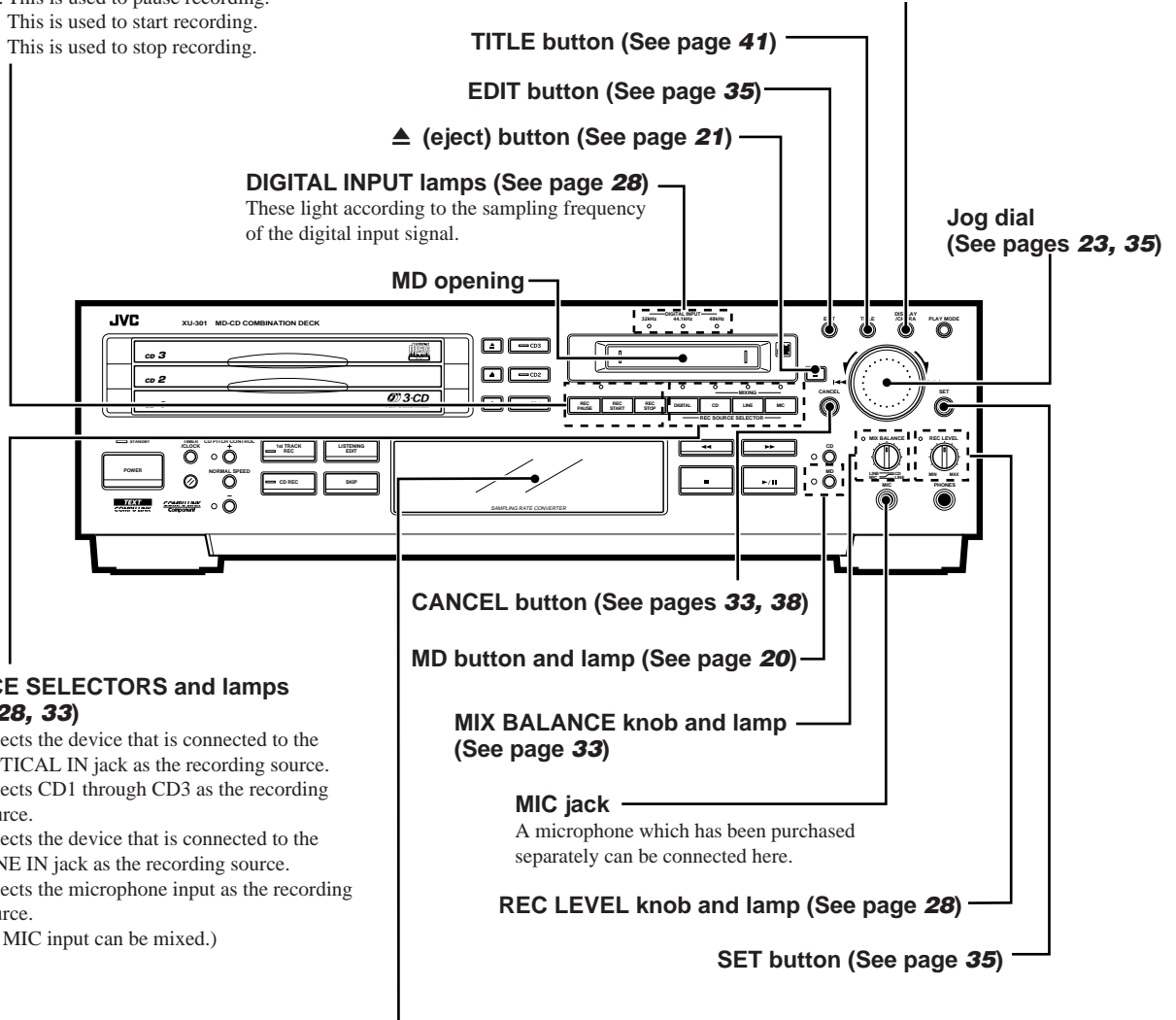

REC SOURCE SELECTORS and lamps (See pages 28, 33)

- **DIGITAL:** Selects the device that is connected to the OPTICAL IN jack as the recording source.
 - **CD:** Selects CD1 through CD3 as the recording source.
 - **LINE:** Selects the device that is connected to the LINE IN jack as the recording source.
 - **MIC:** Selects the microphone input as the recording source.
- (CD, LINE, and MIC input can be mixed.)

Display window

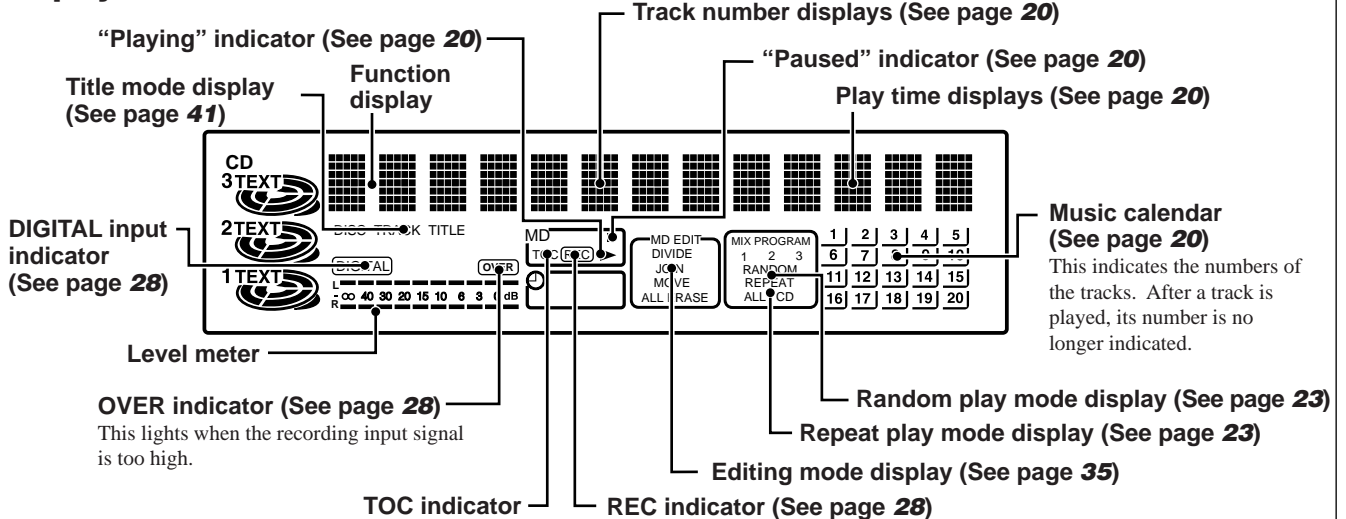

* **TOC:** Table of Contents

This corresponds to the table of contents of a book, etc.

The TOC contains the data on the positions where the tracks are recorded, the breaks between the tracks, the track order (track numbers), etc.

Using the Remote Control

Installing the dry batteries

1 Slide open the cover.

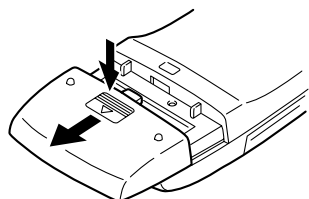

2 Install the dry batteries (Size "AAA", R03 or UM4 x 2).

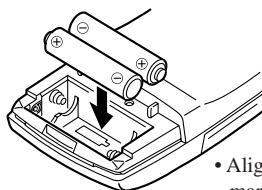

• Align the polarities with the markings inside the battery compartment of the remote control, and install.

3 Slide the cover back into position.

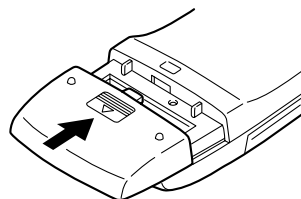

Remote control operations

The remote control has two sets of control panels: the regular control panel on the unit's exterior, and the editing control panel which is revealed when the exterior panel is opened out. The regular controls are used mainly for playing CDs and MDs and for recording MDs, and the editing controls are used mainly when editing and inputting titles.

Regular control panel

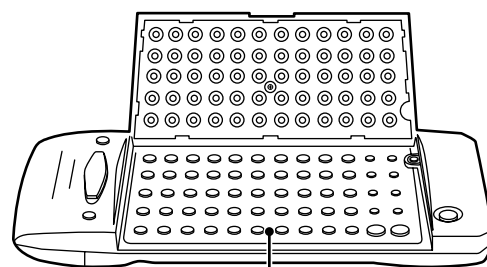
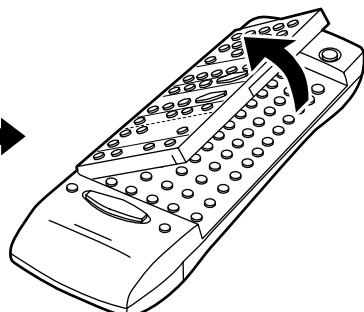
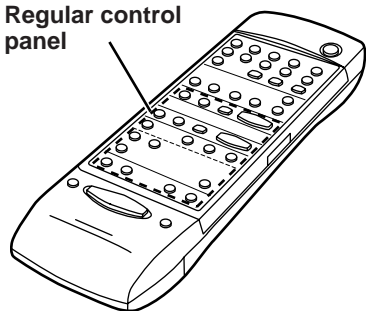

Editing control panel

When the regular controls are used

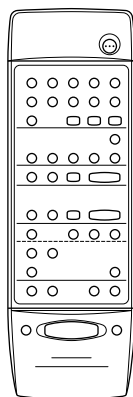
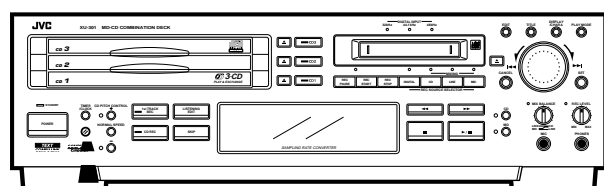

When the editing controls are used

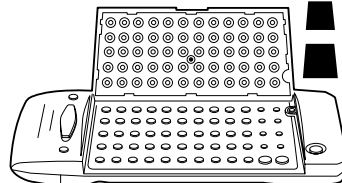
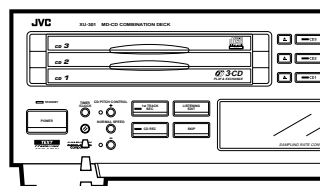

• To input titles, the remote control can be operated sideways. Refer to page **10** for the names of the buttons.

How to use the remote control correctly

- Point the remote control correctly at the remote control sensor on the main unit, and press the buttons.
- The remote control can be operated at a distance of up to 7 meters or so from the remote control sensor. This distance will be less if the remote control is operated from a position which is not directly in front or on the same level as the main unit.

- When the distance over which the remote control can be operated starts to drop, it means that the batteries are nearing the end of their service life. Replace both batteries (size "AAA", R03 or UM4 alkaline batteries) with fresh units.
- The dry batteries provided with the unit are for operational check purposes. Replace them with fresh units at the earliest opportunity.

- When installing the dry batteries, ensure that the ⊕ and ⊖ polarities are aligned correctly with the markings.
- Do not drop the remote control or subject it to strong impact.
- In order to ensure that the remote control does not fail to operate, avoid operation under the following conditions:
 - When the remote control sensor is exposed to direct sunlight or other intense sources of light
 - When objects in front of the remote control sensor block the transmission of signals from the remote control

Names of the buttons (regular control panel)

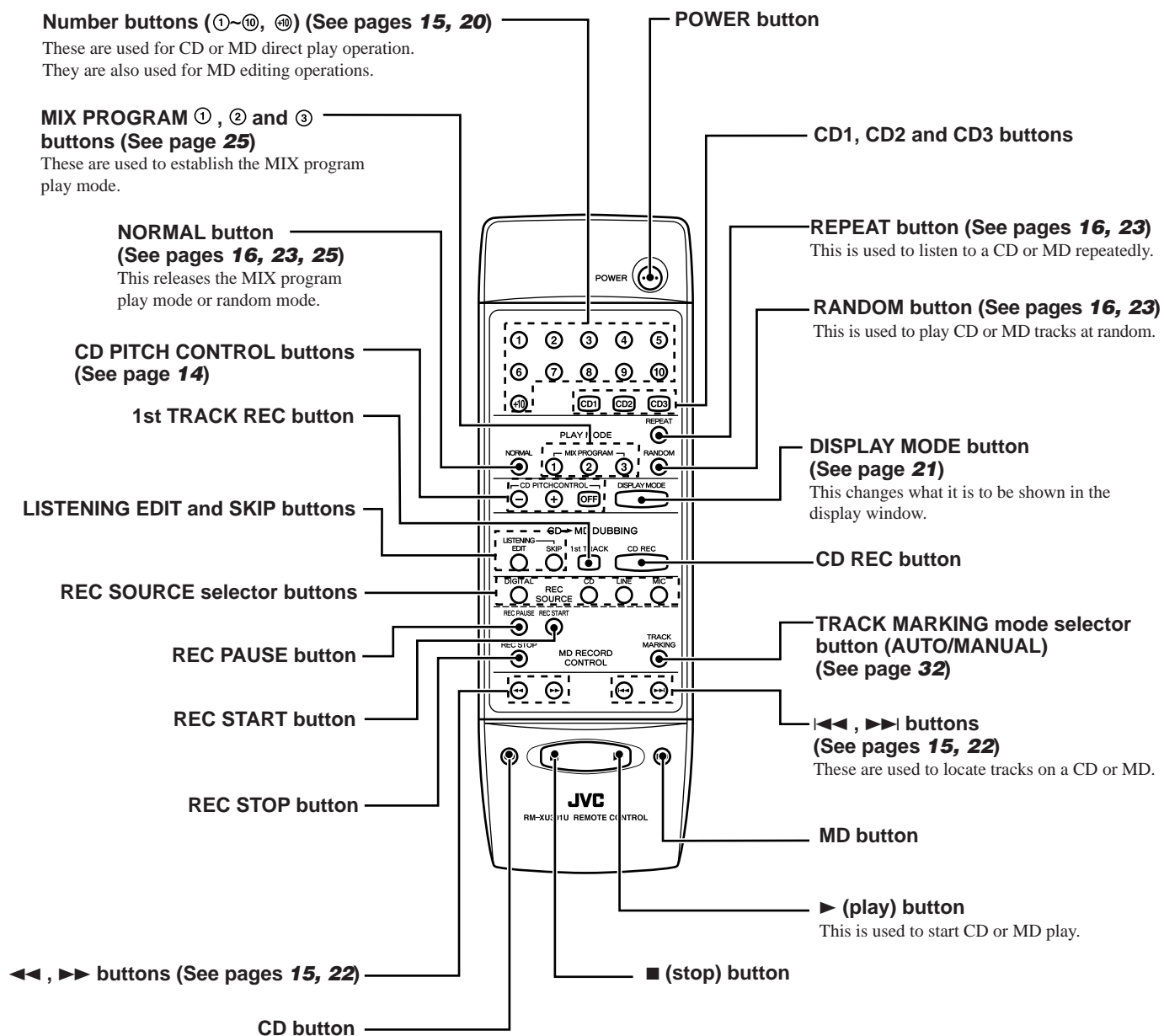

Buttons which are not described here function in the exactly same way as their counterparts on the main unit.

Names of the buttons (editing control panel)

Character input buttons (See page 43)

These enables characters to be input directly when titles are to be given to a CD or MD.

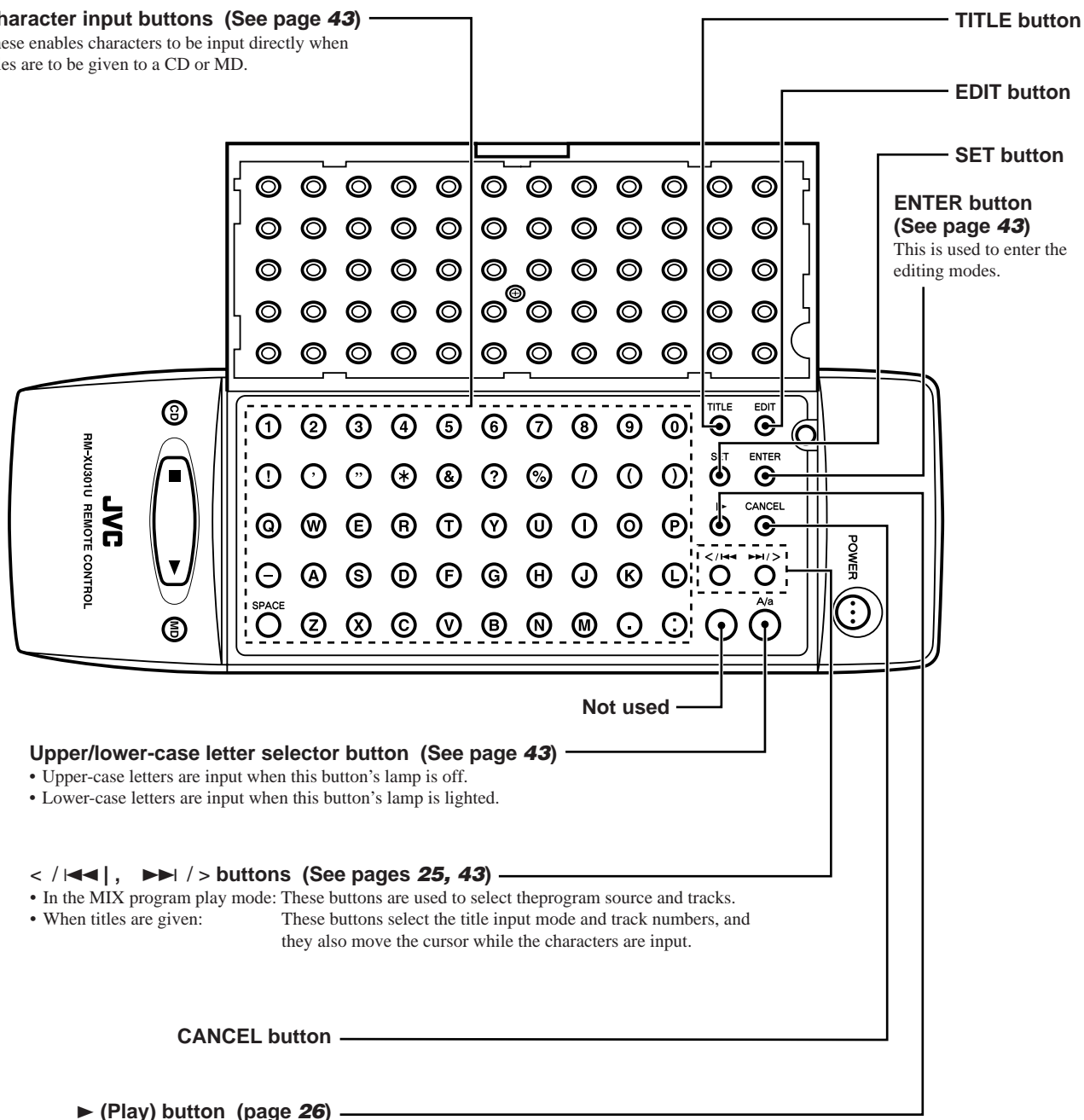

Buttons which are not described here function in the exactly same way as their counterparts on the main unit.

Power ON/OFF Operations

Power ON/OFF operations

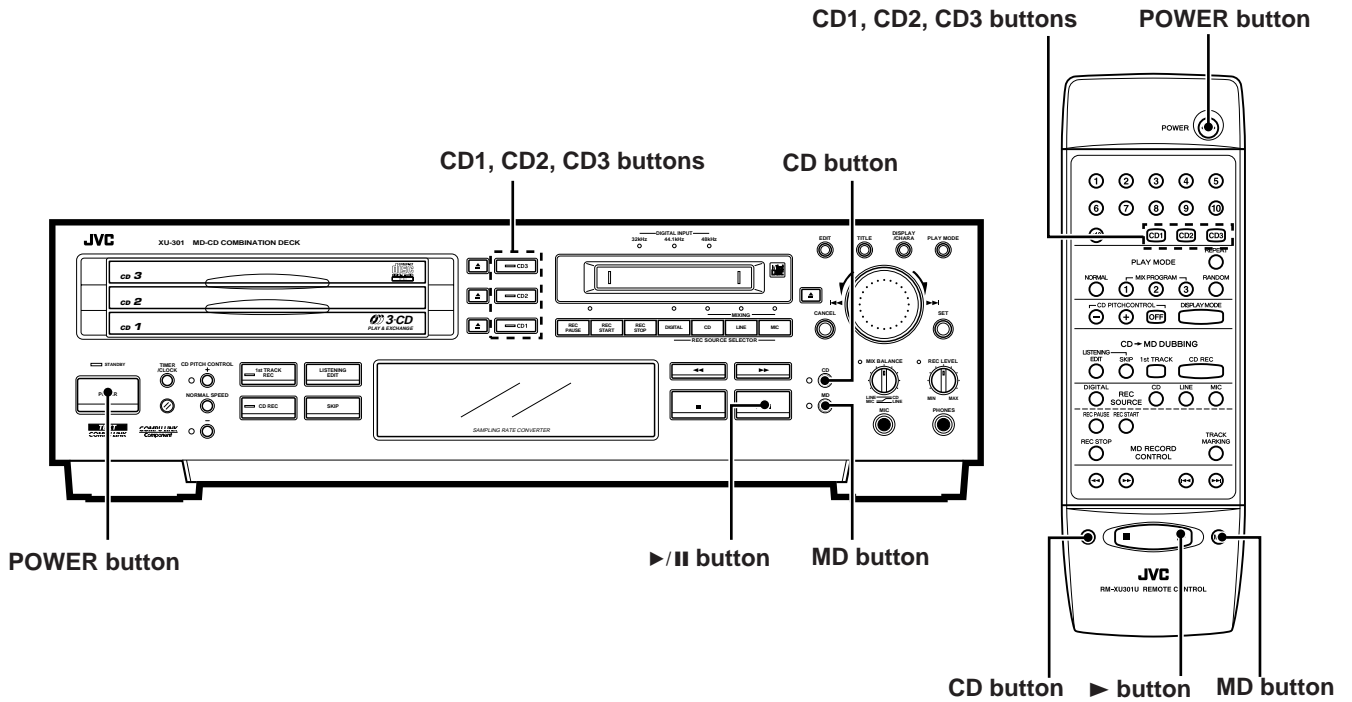

• To turn on the power

Main unit

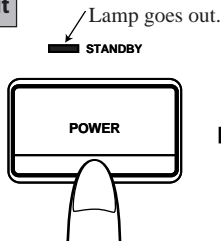

- The currently selected function ("CD" at the time of purchase) appears in the display window.

Remote control

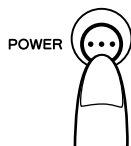

• To turn off the power

Main unit

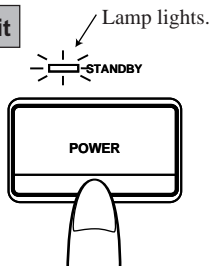

- The clock display appears in the display window. It flashes if the clock has not been set.

Remote control

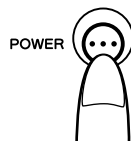

(The power can be turned OFF only by the POWER button.)

• To turn on the power by pressing a function button once

When the power is off, it can be turned on and a function can be selected simply by pressing one of the buttons shown in the figure below.

	Function	Operation
<p>Main unit</p> <p>Remote control</p>	"CD"	If one of these buttons is pressed when a CD is on the corresponding CD tray, continuous play starts from the CD tray which corresponds to the button which was pressed.
<p>Main unit</p> <p>Remote control</p>	"CD"	The function is set to "CD."
<p>Main unit</p> <p>Remote control</p>	"MD"	The function is set to "MD."

- When the >|| button (or the > button on the remote control) is pressed, the power is turned on, and the selected function is established. Play will start when the CD has been placed on the tray or the MD has been inserted in its slot.

■ When an MD is installed or one of the CD trays is opened, the power will be turned on but the function is not selected. If the ▲ (MD eject) button is pressed when an MD has been inserted in its slot, the power is switched off after the MD has been ejected.

Listening to CDs

Operate by following the steps below in numerical order.

Continuous Play (playing CD1, CD2 and CD3 through once each)

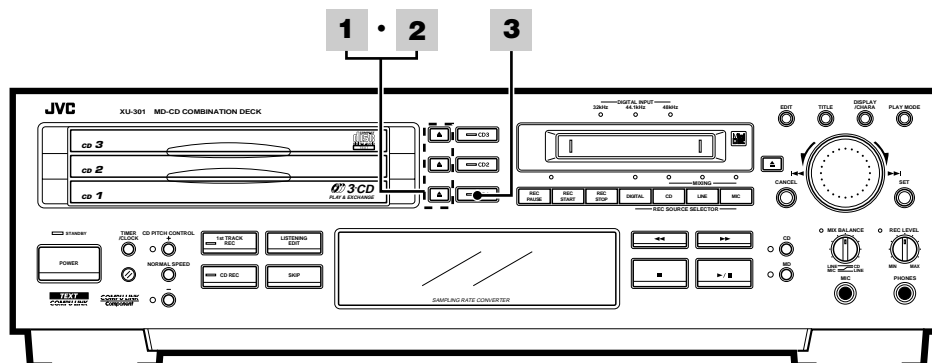

Example: When playing starting with CD1

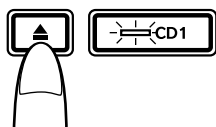

1 Open the CD tray (by pressing the CD1 ▲ button).

- The power comes on, and the CD1 tray opens.

2 Place the CD in position and close the tray.

Place the CD with its label side facing up.

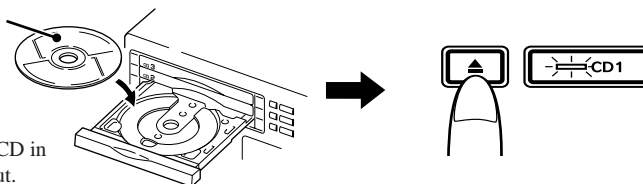

- Place an 8-cm CD in the center cutout.

- While referring to steps 1 and 2, press the CD2 ▲ button and CD3 ▲ button, and place CDs in position on the CD2 and CD3 trays.
- While the tray concerned is being opened or closed or while the CD selection is being changed internally, no operation will result even if the ▲ button is pressed.

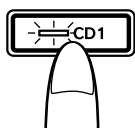

3 Press the CD1 button. → Play now starts.

- The function is set to "CD," and CD1 play starts from track No.1.

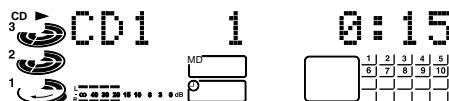

- The numbers of the tracks which have been played are cleared from the music calendar.

■ When CD3 has been played through, operation stops automatically.

• When one or more CDs are already on the trays.

Press the CD1, CD2 or CD3 button corresponding to the CD concerned directly. Continuous play starts with the CD corresponding to the number of the button pressed. If the button is pressed when the power is turned off, continuous play starts when the power is next turned on.

- When play starts from CD2

The CDs are played in the sequence of CD2 → CD3 → CD1, after which play is automatically stopped.

- When play starts from CD3

The CDs are played in the sequence of CD3 → CD1 → CD2, after which play is automatically stopped.

If one of the trays does not contain a CD, play skips to the CD in the next tray in the sequence.

• Playing CDs using the ▶/II button

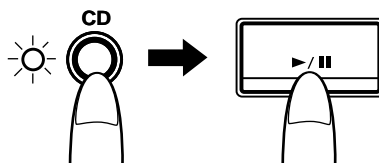

• First set the function to “CD.”

When the above button is then pressed, play starts from the CD on the tray for which “▶” is displayed.

Stopping CD play

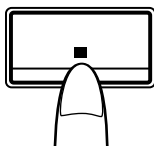

• Stopping play at any time

- When the button on the left is pressed after the function has been set to “CD,” the track number and play time appear on the display. When all the tracks on a CD have been played through, play will stop automatically.

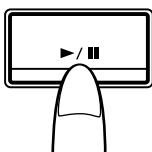

• Stopping play temporarily

- If the button on the left is pressed when the function has been set to the “CD” mode, the play status display and II indicator flash. When it is pressed again, play is resumed from the place where it was stopped.

• Concerning the CD numbers and play status display

The display shows for each CD tray whether or not a CD has been inserted as well as the play status of the CD.

This is displayed when CD text has been entered.



While a CD is playing, this lights in sequence, and it flashes in the pause mode. It goes off when “NO DISC” is displayed to indicate that a disc has not been inserted.

The CD on the CD tray for which this has lighted is playing.

■ Precaution concerning volume setting

Unlike analog records, CDs have very low levels of noise. If you set the volume on the basis of the level of the noise heard during the intro as you might with an analog record, an unexpectedly loud sound may be delivered as a result. Before turning off the power, turn down the volume to prevent this from happening.

- If, in step 2, the CD1 button is pressed first while the CD tray is open, the CD tray will close, and play will start from the first track on that CD.

■ Storing CDs

- Always ensure that each CD is stored in its own case.
- Do not place CDs in direct sunlight, near a heating appliance or any other location which is susceptible to high temperatures.

- If cellophane tape, an adhesive sticker or some other form of glue is present on the label side, clean it off before use.

- Do not stick adhesive labels or write anything on a CD.

- Do not bend CDs.

- Do NOT insert shaped CDs, such as CDs in a heart, flower or other shape, because their shape does not match the shape of the CD tray, and using them will give rise to malfunctioning.

CD PITCH CONTROL

The CD PITCH CONTROL buttons ⊕ and ⊖ can be used to vary the CD playback speed by up to ±12%. The CD play signals are output to any other device from DIGITAL OUT OPTICAL only when the play speed is set to NORMAL.

Normally, NORMAL SPEED should be set.

CD Text

“CD Text” is a new function featured by music CDs which CDs available to date did not have: it displays the album title, names of the tracks and artists, and other information.

This unit displays the CD Text data using alphanumerics. When material is digitally recorded onto an MD, the CD Text data is recorded together.

CDTEXT

- **To view the CD text information**

Press the DISPLAY/CHARA button (or the DISPLAY MODE button on the remote control) in the stop or play mode.

Main unit

DISPLAY
/CHARA



Remote control

DISPLAY MODE

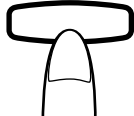

- What is displayed changes each time this button is pressed. Text containing more than 13 characters will be scrolled.

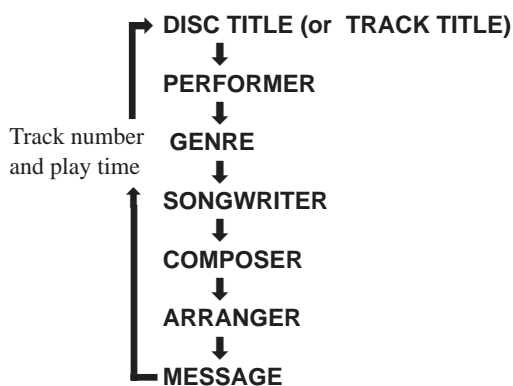

NOTICE

■ “NO DISC” may be displayed as shown if the CD is dusty or scratched or if it has been placed upside down on the tray. In a case like this, check whether the CD is upside down, and turn it over if it is. If it is not, check whether the CD is dusty or scratched and clean or replace it if it is.

- If there are no CDs inside the unit and the ►/|| button or CD1, CD2 or CD3 button is pressed, the “NO DISC” message will appear after the corresponding number of the CD.
- “NO DATA” is displayed for any item in the CD text for which no data has been recorded.
- When the REPEAT button of the remote control is pressed during continuous play, the continuous play mode is released and the repeat play mode is established instead.

Direct Play (starting play from a specific track)

CD play can be started from a specific track by pressing the corresponding number button(s) on the remote control.

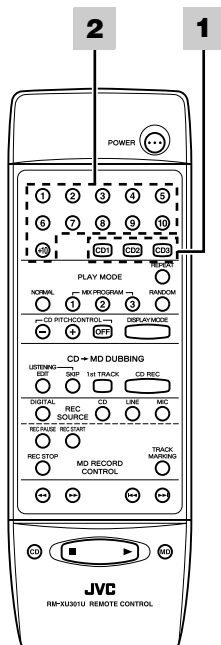

1 Press the CD button.



- Press the button corresponding to the CD whose track is to be heard.

2 Press the number button(s).

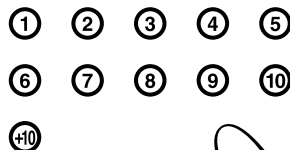

- To play a track from No.1 to No.10**

Press the number button (①~⑩) corresponding to the track.

- To play track No.11 or above**

First press the ④⑩ button, and then press one of the number buttons (①~⑩).

Example: Track No.15

Press ④⑩ followed by ⑤ .

Example: Track No.20

Press ④⑩ followed by ⑩ .

Example: Track No.25

Press ④⑩ twice followed by ⑤ .

⋮

The track number corresponding to the buttons pressed appears in the display window, and direct play now starts.

- Another track can be selected even during play.**

Press the number button(s) corresponding to the track which is to be heard. The display now changes to indicate the corresponding track No., and play starts from the beginning of the track concerned.

- To select a track of a CD on another tray, select the CD tray and then perform the same operation.

Reverse Search and Forward Search

After pressing the ④⑩ button.

- Reverse search or forward search is possible by holding down the corresponding button during play. A garbled sound will be heard during reverse search or forward search. Release your finger when the part to be heard is reached.

Main unit

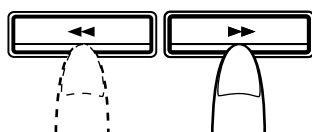

Reverse search Forward search

Remote control

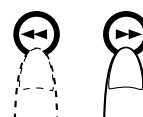

Reverse search Forward search

Skipping Tracks

- To skip to the previous or next track with this unit, turn the jog dial. With the remote control, tap the ►► or ◀◀ button once. When the operation is performed while the last track on the CD is playing, play moves on to the next CD.

Main unit

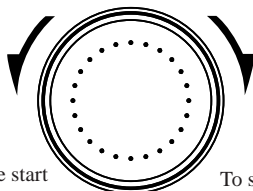

To skip to the start of the current or previous track

To skip to the start of the next track

Remote control

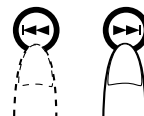

To skip to the start of the current or previous track

To skip to the start of the next track

- Direct play cannot be initiated by pressing the Ⓜ button alone: this button must be used with one of the number buttons (①~⑩). Neither can direct play be initiated when "MIX PROGRAM1-3" or "RANDOM" appears on the display. In this case, clear the display first.

Repeat Play (using the remote control)

REPEAT button

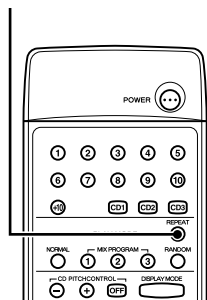

- The repeat play mode can be selected by pressing the REPEAT button on the remote control when the function is set to "CD." Each time, the button is pressed, a different display appears in the display window as shown below.

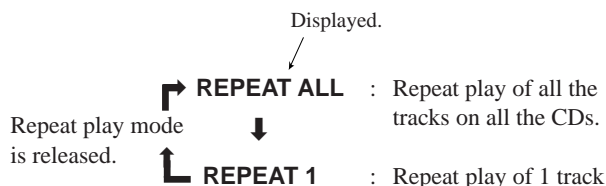

Play is repeated in the selected mode when the CD1, CD2 or CD3 button or ► button (or the ►/|| button on the main unit) is pressed.

Random Play

RANDOM button

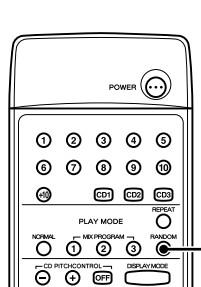

- The random play mode can be selected by pressing the RANDOM button on the remote control or the PLAY MODE button on the main unit when the function is in the CD stop mode.

Main unit



- Press this button in the stop mode.

Remote control



- Press this button in the stop mode.

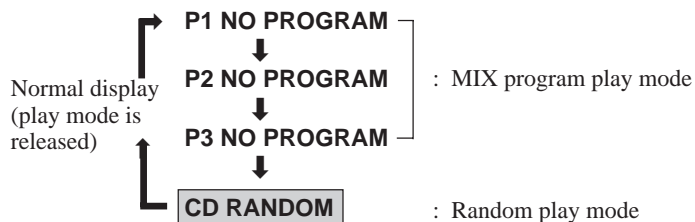

Normal display (random mode is released)



CD RANDOM
(Press the NORMAL button to return to the normal mode.)

Random play is started by pressing the ►/|| button (or the ► button on the remote control).

- To release the random play mode**

Press the PLAY MODE button in the stop mode.

"RANDOM" is cleared from the display window, and the random play mode is released.

The NORMAL button on the remote control can also be used to release this mode.



Giving a title to a CD

The CD can be given a title as well as the name of the artist and genre of music using up to 32 characters.

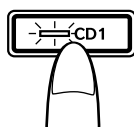
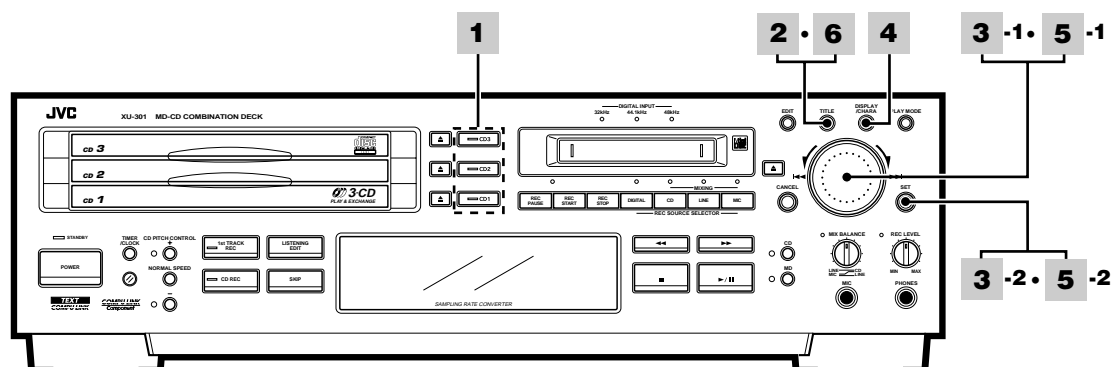

1 Select the CD which is to be given a title.

Example: CD1

- The title can be given while the CD is playing or when it has stopped.

2 Press the TITLE button.

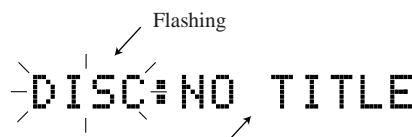

This appears when no title has been given.

- The disc title input mode is now established.

3 Use the jog dial to select the items and press the SET button.

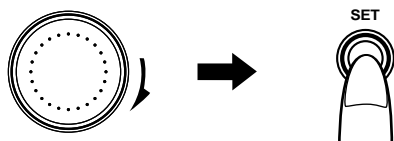

DISC TITLE : Disc name
↓
PERFORMER : Name of artist
↓
GENRE : Genre of music

- Turn the dial counterclockwise to go in the reverse direction
- If nothing has been entered when PERFORMER or GENRE has been selected, "NO DATA" is displayed.
- When genre has been selected, operation advances to step 5 on page 18.

To enter the title or name of the artist

4 Select the type of characters to be used for the title.



Each time this is pressed, the character type changes.

Upper-case letters/symbols
↓
Lower-case letters/symbols
↓
Numbers

For details, refer to the character layout table on page 44.

5 Input the title (using up to 32 characters).

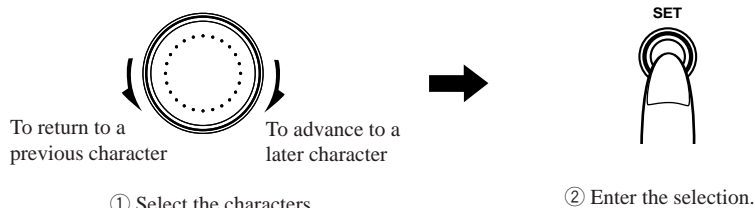

Example : Disc title

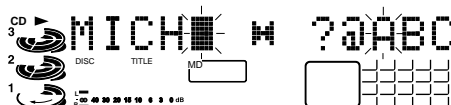

- If the wrong character has been input, clear it using the CANCEL button.
- The title of your choosing is input by repeating steps 4 and 5.
- To clear a particular character which has been input, use the ◀ button to align the cursor with the character, and press the CANCEL button. Then, select the correct character and press the SET button. In this way, any of the characters can be corrected.
- To input a space, press the ▶▶ button during the input procedure. A space can be input either by pressing the SPACE button on the remote control or by entering the space (positioned between Z and !) among the letters and symbols.

- Titles for up to 200 CDs can be stored in the unit's memory. When one of these CDs is inserted, its title will be displayed. Track titles and other CD text information is copied together during digital recording.
- To stop operation at any time
In the play mode, press the ■ (stop) button. In the stop mode, press the ▶/|| button.



• When the title or name of the artist has been entered

6 Press the TITLE button.

- "EDITING" appears, and the data is stored in the memory IC.
- To enter the name of the artist, repeat the procedure starting from step 1.

• Selecting and entering a genre (genres for up to 200 CDs can be stored)

Continued from step 1 on page 17

5 Use the jog dial to select and enter the genre.

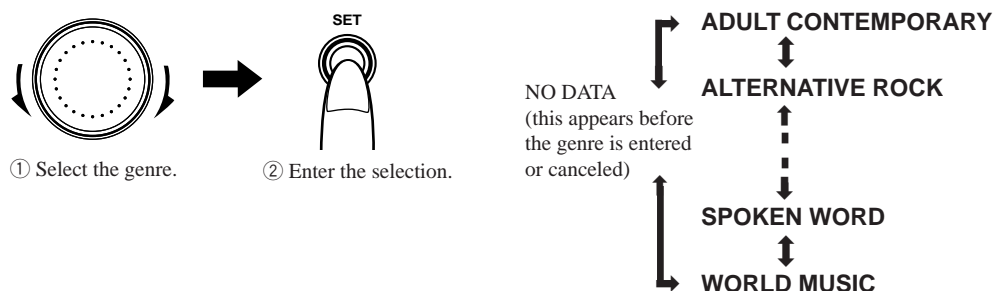

- Each time the jog dial is turned, one of the 27 genres can be selected. Genres contained 14 or more letters are scrolled on the display. (➔ See list of genres on the next page)



6 Press the TITLE button.

- "EDITING" appears, and the genre is stored in the memory IC.
- To cancel a genre which has been stored in the memory IC
Use the jog dial to select "NO DATA," press the SET button and then press the TITLE button. The genre is now canceled. A different genre can now be selected and stored.

List of Music Genres

Genre
ADULT CONTEMPORARY
ALTERNATIVE ROCK
CHILDRENS MUSIC
CLASSICAL
CONTEMPORARY CHRISTIAN
COUNTRY
DANCE
EASY LISTENING
EROTIC
FOLK
GOSPEL
HIP HOP
JAZZ
LATIN
MUSICAL
NEW AGE
OPERA
OPERETTA
POP MUSIC
RAP
REGGAE
ROCK MUSIC
RHYTHM EFFECTS
SOUND EFFECTS
SOUND TRACK
SPOKEN WORD
WORLD MUSIC

Disc Lock Function

To prevent children from taking out or inserting CDs

A Disc Lock function can be engaged to make it impossible for children to take CDs out or insert others.

- In the power standby mode, press CD1 ▲ button while holding down ■ button.



“LOCKED” appears for 3 seconds, and it is no longer possible to take out or insert CDs.

- **To release the Disc Lock function.**

Repeat the same step.



“UNLOCKED” appears for 3 seconds, and the Disc Lock function is released.

Listening to MDs

Operate by following the steps below in numerical order.

Playing all tracks

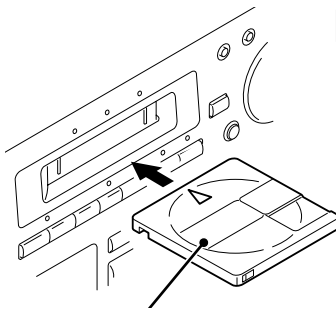
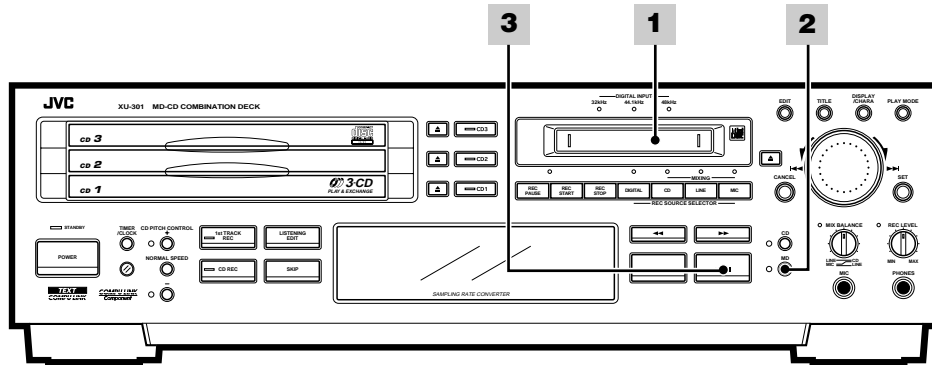

Place the MD with its label side facing up, and insert it in the direction of the ▷ or ⇨ mark.

1 Place the MD in position.

- Place the MD with its label side facing up. When it is inserted in the direction shown by the arrow, the power turns on and the MD is automatically drawn inside.
- When "MD" is already set as the function, the track numbers and play time are displayed after the "TOC READING" display.
- The  display appears to indicate that an MD has been inserted.

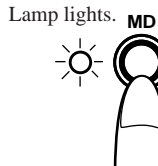

2 Set the function to "MD."

The display changes to track No.1 after 3 seconds.

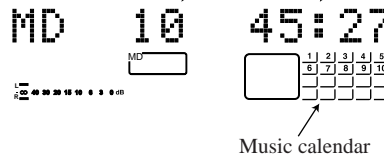

Music calendar

3 Press the ▶/|| button. → Play now starts.

- MD play starts from track No.1.

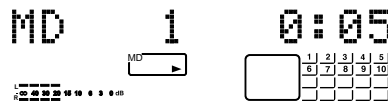

- The numbers of the tracks which have been played are cleared from the music calendar.

Stopping MD play

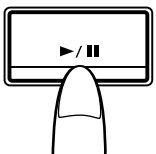
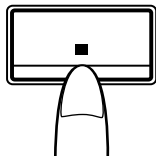

• Stopping play at any time

- When the button on the left is pressed, the track number and play time appear on the display. When all the tracks on an MD have been played through, play will stop automatically.

• Stopping play temporarily

- When the button on the left is pressed, || is displayed. When it is pressed again, play is resumed from the place where it was stopped.

When the MD has been placed inside

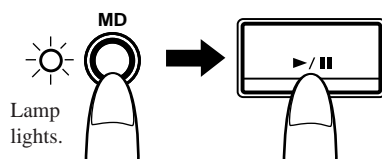

- When the button on the left is pressed, the power turns on, and play starts.

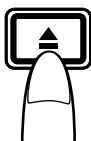

• To eject the MD

Press the MD ▲ button. “MD EJECT” appears in the display window, and the MD is ejected.

The  display is cleared.

The MD can be ejected even when the power is off. In this case, as soon as the MD is ejected, the power is automatically turned off.

■ Precaution concerning volume setting

Unlike analog records, MDs have very low levels of noise. If you set the volume on the basis of the level of noise heard during the intro as you might with an analog record, an unexpectedly loud sound may be delivered as a result. Before turning off the power, turn down the volume to prevent this from happening.

- If there is no MD inside the unit, “MD NO DISC” is displayed when the function is set to “MD” or the ►/|| button is pressed.

Changing the display in the display window

- Use the DISPLAY/CHARA button (or the DISPLAY MODE button on the remote control). Each time it is pressed, the display changes as shown below.



• When it is pressed in the stop mode

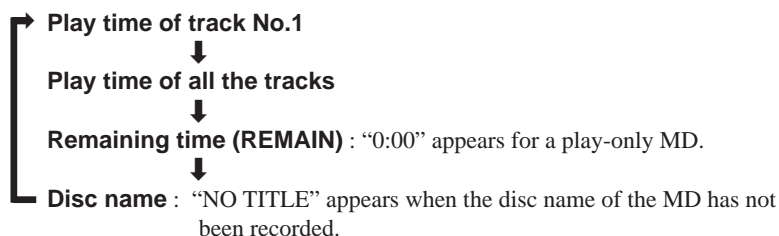

• When it is pressed during play

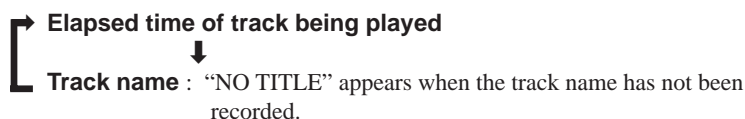

<Tips and Precautions>

• To ensure that the MD sound remains perfect

Each MD disc is housed inside a cartridge which protects it from dust and dirt and which ensures easy handling. However, bear in mind the following precautions to ensure that its sound remains perfect.

Do not open the shutter!

The shutter is locked to prevent it from opening. Forcing it open will break the disc.

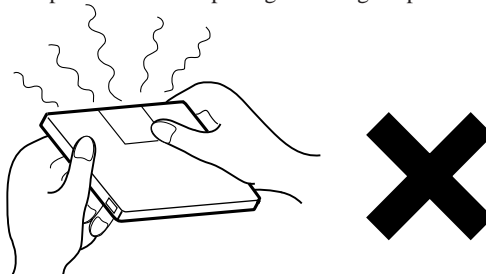

Keep MDs away from the following locations!

Do not place or keep MDs in any of the following locations.

- Any location exposed to direct sunlight, inside a car or wherever the temperature may increase to a very high level
Such locations will warp the discs and render them unusable.
- A bathroom or other extremely humid location
The disc may rust.
- A beach, sandbox or other sandy location
Fine particles will enter through the gaps in the cartridge, dirtying or scratching the disc surface.

Clean at regular intervals!

If the cartridge becomes dusty or dirty, wipe away the dust or dirt using a soft, dry cloth.

Direct Play (starting play from a specific track)

MD play can be started from a specific track by pressing the corresponding number button(s) on the remote control.

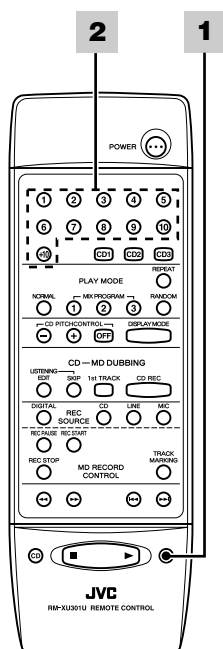
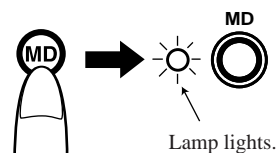
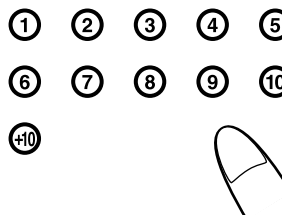
**1 Set the function to "MD."****2 Press the number button(s).**

- **To play a track from No.1 to No.10**

Press the number button (①~⑩) corresponding to the track.

- **To play track No.11 or above**

First press the +10 button, and then press one of the number buttons (①~⑩).

Example: Track No.15

Press +10 followed by ⑤ .

Example: Track No.20

Press +10 followed by ⑩ .

Example: Track No.25

Press +10 twice followed by ⑤ .

⋮

The track number corresponding to the buttons pressed appears in the display window, and direct play now starts.

- **Another track can be selected even during play.**

Press the number button(s) corresponding to the track which is to be heard. The display now changes to indicate the corresponding track No., and play starts from the beginning of the track concerned.

Reverse Search and Forward Search

After pressing the MD button.

- Reverse search or forward search is possible by holding down the corresponding button during play. A garbled sound will be heard during reverse search or forward search. Release your finger when the part to be heard is reached.

Main unit

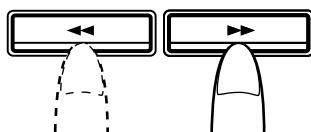

Reverse search

Forward search

Remote control

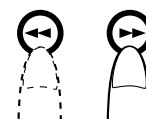

Reverse search

Forward search

Skipping Tracks

- To skip to the previous or next track with this unit, turn the jog dial. With the remote control, tap the $\blacktriangleright\blacktriangleleft$ or $\blacktriangleleft\blacktriangleright$ button once.

Main unit

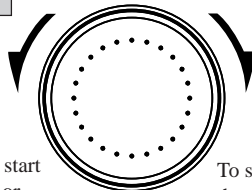

To skip to the start of the current or previous track

To skip to the start of the next track.

Remote control

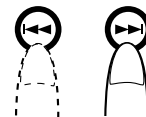

To skip to the start of the current or previous track

To skip to the start of the next track

- Direct play cannot be initiated by pressing the (Ⓢ) button alone: this button must be used with one of the number buttons (①~⑩). Neither can direct play be initiated when "MIX PROGRAM1-3" or "RANDOM" appears on the display. In this case, clear the display first.

Repeat Play (using the remote control)

REPEAT button

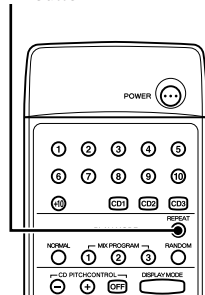

- The repeat play mode can be selected by pressing the REPEAT button on the remote control when the function is set to "MD." Each time, the button is pressed, a different display appears in the display window as shown below.

REPEAT

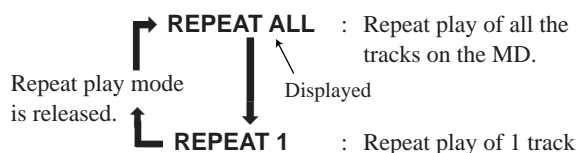

Play is repeated in the selected mode when the \blacktriangleright button (or the $\blacktriangleright\parallel$ button on the main unit) is pressed.

Random Play

RANDOM button

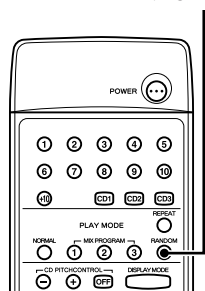

- The random play mode can be selected by pressing the RANDOM button on the remote control or the PLAY MODE button on the main unit when the function is set to "MD."

Main unit

PLAY MODE



- Press this button in the stop mode.

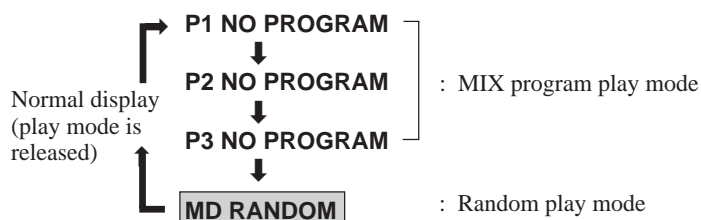

Remote control

RANDOM



- Press this button in the stop mode.

Normal display
(random mode is released)



MD RANDOM

(Press the NORMAL button to return to the normal mode.)

Random play is started by pressing the $\blacktriangleright\parallel$ button (or the \blacktriangleright button on the remote control).

NORMAL



- To release the random play mode**

Press the PLAY MODE button in the stop mode.

"RANDOM" is cleared from the display window, and the random play mode is released.

The NORMAL button on the remote control can also be used to release this mode.

6 Repeat steps 4 and 5 (this procedure can be repeated for up to 16 tracks).

- The tracks on the MD alone or only the tracks on the CDs can be programmed also.

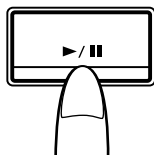

7 Press the ▶/|| button to start MIX PROGRAM play.

- The numbers of the tracks which have been played are cleared from the music calendar, and they are displayed when play is completed.

- Operation stops automatically when all the programmed tracks have been played. The same operating procedure is followed for programs 2 and 3.

- To cancel the programming
Press the CANCEL button. The last program setting is canceled. Press the CANCEL button repeatedly to cancel all the program settings.
- To check the programming
To check what has been programmed while the tracks are being programmed, press the ■ (stop) button, and use the jog dial to check.

Playing MIX PROGRAMS using the remote control

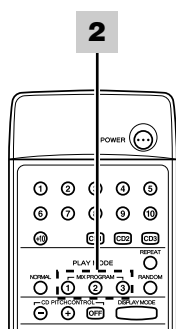

1 Insert the MD and CDs whose tracks are to be programmed into the main unit.

2 Select the program mode.

Example: Program 1

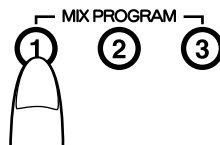

- "P1 NO PROGRAM" is displayed.

3 Press the SET button.

- "P1 S01 MD 1" is displayed.



4 Select and enter the program source.

- Select one of the sources.

→ MD → CD1 → CD2 → CD3 → (back to the beginning)

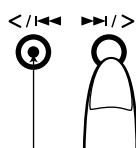

- ① This can select the source in the reverse direction.

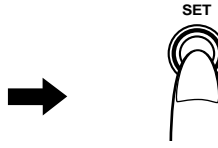

- ② Then press this button.

- When the SET button is pressed, the programming sequence and track number flash.

Open the remote control's cover.

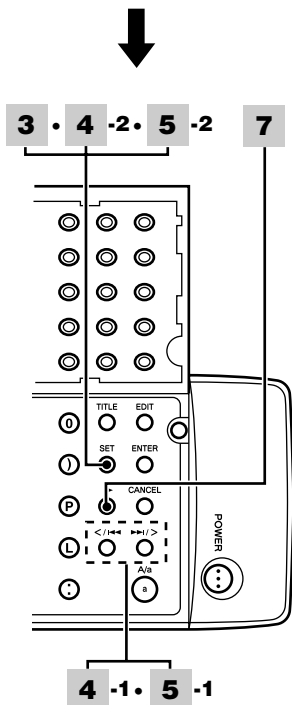

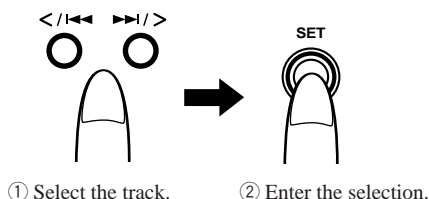
5 Select and enter the track.**6 Repeat steps 4 and 5 (this procedure can be repeated for up to 16 tracks).**

- The tracks on the MD alone or only the tracks on the CDs can be programmed also.

7 Press the ► button to start MIX PROGRAM play.

- Operation stops automatically when all the programmed tracks have been played. The same operating procedure is followed for programs 2 and 3.



- **To return the program mode to the normal status in the stop mode**

Main unit

PLAY MODE



- Repeatedly press this until the play time appears in the display window.

Remote control

NORMAL



- The play time display appears when this button is pressed.

Recording onto MDs

Read through this section before recording.**Types of recording**

The following 5 types of recording are possible with this unit.

- **Manual recording (page 28)**

One of the recording sources is selected, and its material is recorded.

- DIGITAL
- CD (CD1-CD3)
- LINE
- MIC

- **CD recording (single-action recording) (page 29)**

CD recording is initiated by a single action: just press the CD REC button.

- **CD recording (1st TRACK recording) (page 30)**

When the 1st TRACK REC button is pressed, only the first tracks on CD1, CD2 and CD3 are recorded. You can compile your own album of original hit numbers.

- **CD recording (LISTENING EDIT recording) (page 31)**

When the LISTENING EDIT button is pressed, only the tracks you want to hear can be programmed and recorded.

- **Mixing recording (page 32)**

This enables mixing recording for CD + LINE, CD + MIC or LINE + MIC.

TRACK
MARKING

Adding track numbers

- **Recording the numbers automatically**

With CD digital recordings, the numbers are added automatically following the numbers in the recording source.

- **Adding your own numbers (at any time except during synchro REC)**

When MANUAL is set using the TRACK MARKING button and the SET button on the main unit or remote control is pressed during recording, a number can be added exactly where desired.

Sampling rate converter

The unit incorporates a sampling rate converter to ensure that the original digital signals will be recorded regardless of the sampling frequency (32 kHz, 44.1 kHz or 48 kHz) of the recording source.

Microphone connections

Use a microphone equipped with a standard plug.

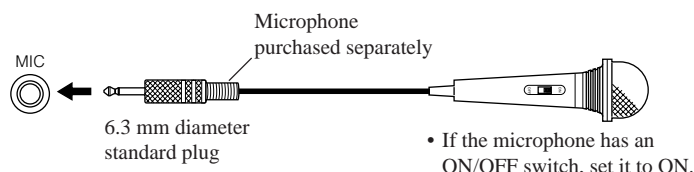

NOTICE

- **To prevent the erasure of important recordings**

Each recording MD comes with an accidental erasure prevention knob to ensure that important recordings will be not erased by mistake. After recording or editing material, slide the knob on the cartridge side to the open position. This prevents recording over or editing of the existing material. To proceed with recording over or editing, return the knob to the closed position.

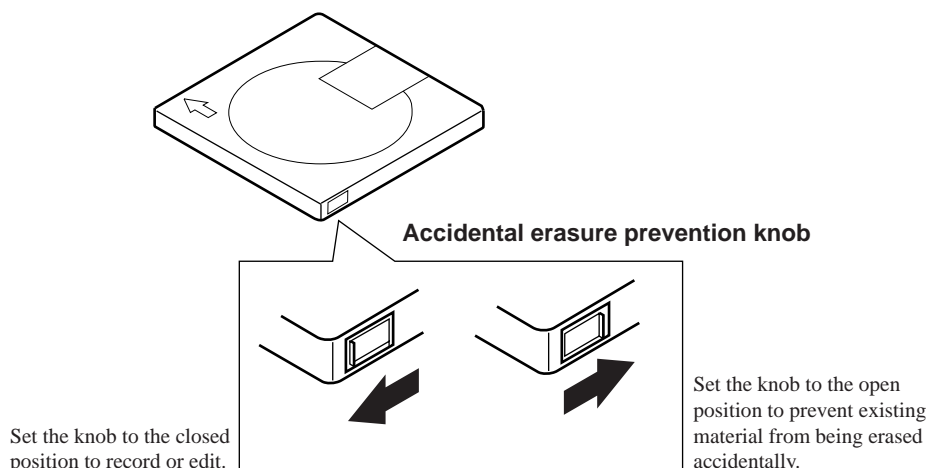

- **When sticking adhesive labels onto MD cartridges for use**

Adhere the label securely all the way to the edge of the cartridge so that it will not peel off. If the label protrudes from its adhesion area or is not adhered properly, it may not be possible to eject the MD or some other trouble may result.

- Analog signals are recorded when the line input and mic input signals are mixed and recorded. The recording input level must be adjusted.
- The "DISC PROTECTED" display appears 3 times and then is released when recording operations are performed for a MD whose accidental erasure prevention knob has been set to the open position.

Manual Recording

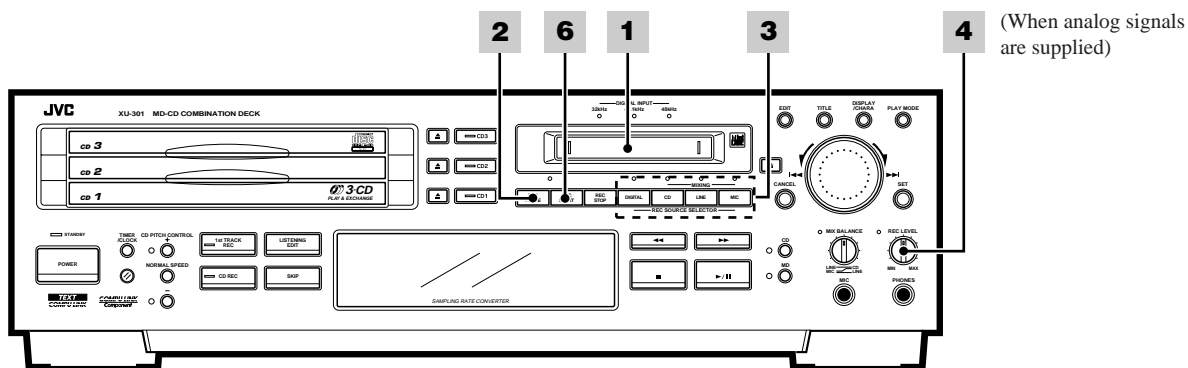

1 Insert the recording MD.

- Insert the MD with its label side facing up.

2 Establish the rec pause mode.

- The remaining recording time on the MD and appear in the display window. The record mode indicator lamp flashes.
- All the REC SOURCE SELECTOR lamps flash when none of the REC SOURCE SELECTOR buttons have been selected.

3 Select (one of) the recording sources.

- **DIGITAL** : For recording the sound of a unit which has been connected to the OPTICAL IN connector (digital input)
- **CD** : For recording the CDs inserted into CD1, CD2 and/or CD3 (when the CD pitch control is set to OFF for the digital input)
Note: Analog recording is performed for CD+LINE or CD+MIC mixing even when the CD pitch control has been set to OFF.
- **LINE** : For recording the sound of a unit which has been connected to the LINE IN connector (analog input)
- **MIC** : For recording the sound from a microphone which has been connected to the MIC jack (analog input)
- If a source has already been selected, its corresponding lamp will light. The lamp of the selected source stops flashing and lights. The other lamps go off.

4 When analog signals are supplied, adjust the recording level.

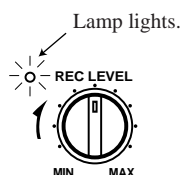

- Adjust the volume in such a way that the 0 dB display is not exceeded when the loudest sound is supplied.

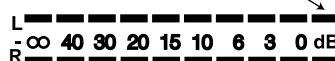

(The sound will be recorded with some distortion if the **OVER** display (red) lights continuously.)

5 Play the sound of the source to be recorded.

- If the CD1 button is pressed when CDs serve as the source, the tracks are recorded in the following sequence: **CD1** → **CD2** → **CD3**.

6 Press the REC START button to start the recording.

- Press the TRACK MARKING button on the remote control to allocate track numbers during recording.

• When MD recording is completed

After "UTOCH WRITING" is displayed, operation stops automatically. Press the REC STOP button to stop the recording at any time.

• DIGITAL INPUT lamps

These lamps light as follows in the rec pause or recording mode.

- **DIGITAL** : 32 kHz–48 kHz lights depending on the sampling frequency of the recording source.
- **CD** : 44.1 kHz lights

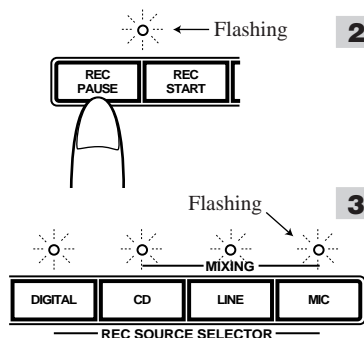

- Press the same button again to clear the selection.

- When DIGITAL IN UNLOCK is scrolled and displayed, the OPTICAL IN connector is not connected to the source unit.
- In the case of an MD with some remaining space, the end of the last track recorded is automatically searched, and recording is commenced immediately.
- To record over all the existing tracks, erase all the tracks using the ALL ERASE function (see page 40), and then proceed with the new recordings.
- Upon completion of the MD recording, "UTOC WRITING" is displayed. Operating any button while this message is displayed may render the MD unusable. Always wait for "UTOC WRITING" to be cleared before proceeding with the next operation.
- When digital input signals are supplied, they will be recorded in their original digital form. There is no need to adjust their recording level.

CD Recording (single-action recording)

CD play and MD recording are started simultaneously.

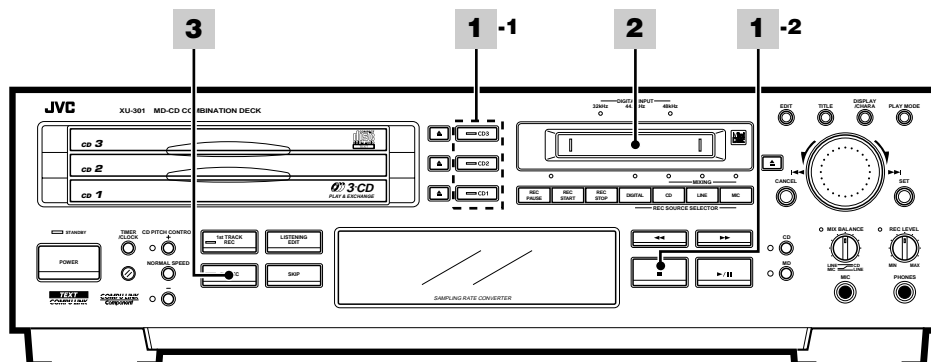

1 Select and stop the CD to be recorded.

Example: When recording CD1

- Only the selected CD is recorded.

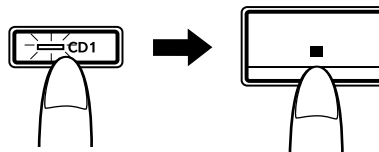

2 Insert the recording MD.

- Insert the MD with its label side facing up.

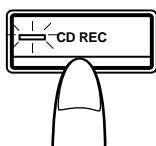

3 Press the CD REC button to start the recording.

- CD play and MD recording start simultaneously. This is called synchro recording. Recording starts from track 1.

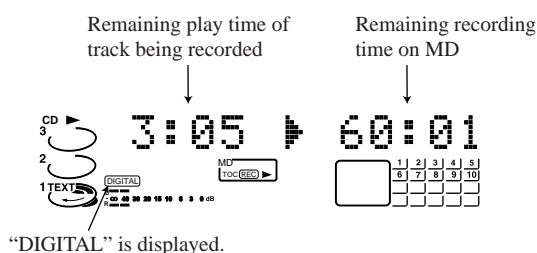

- When a CD is recorded, its digital signals are recorded in their original form. A track mark is automatically placed where one track changes to the next, and the track number also changes.

• When MD recording is completed

After "UTOC WRITING" is displayed, operation stops automatically. It also stops automatically when CD play finishes. CD play is transferred to the next tray.

• To check a track number during recording

Press DISPLAY/CHARA button (or DISPLAY MODE on the remote control).

Main unit

Remote control

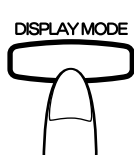

The mode changes each time this is pressed.

Remaining time of track being recorded

▶ Remaining recording time on MD



CD number and track number ▶ MD track number

- **To stop the recording at any time**

Press the ■ (stop) button. The recording mode is released after “UTOC WRITING” is displayed.

- There is no need to adjust the recording level (for a digital recording).
- Recording is not possible while a CD or MD is playing.
- When the CD REC button is pressed, the function is automatically switched to “CD.” This means that when the CD to be recorded has been selected, recording can proceed straightaway.
- Upon completion of the MD recording, “UTOC WRITING” is displayed. Operating any button while this message is displayed may render the MD unusable. Always wait for “UTOC WRITING” to be cleared before proceeding with the next operation.

CD Recording (1st TRACK recording)

Only the first tracks on the CDs can be recorded on the MD.

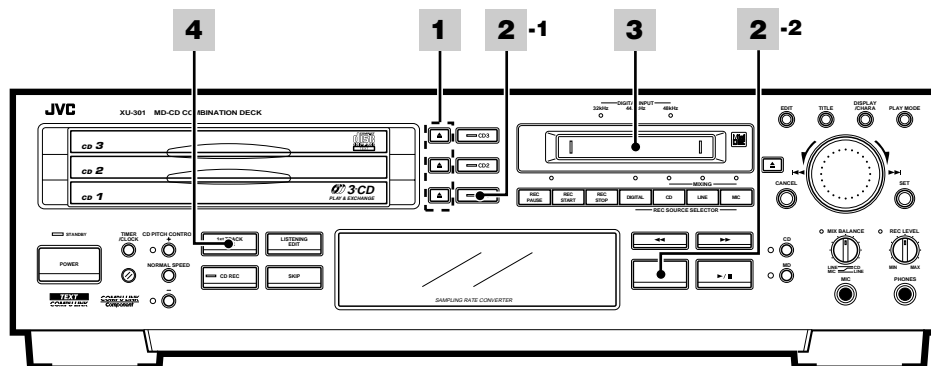

- 1 Insert CDs into CD1, CD2 and CD3 in the order in which their first tracks are to be recorded.**

- Once the first track of a CD has been recorded, another track on that CD can be substituted during recording. The substituted CD track is recorded after the last CD.

- 2 Select CD1 and establish the stop mode.**

Example: When recording from CD1 (CD whose first track is to be recorded first)

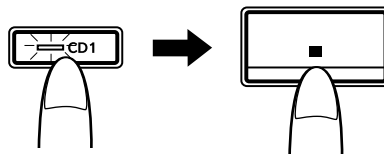

- 3 Insert the recording MD.**

- Insert the MD with its label side facing up.

- 4 Press the 1st TRACK REC button to start recording.**

- CD play and MD recording start simultaneously. Only the first track on the CD is recorded.

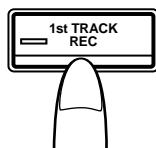

- When a CD is recorded, its digital signals are recorded in their original form. A track mark is automatically placed where one track changes to the next, and the track number also changes.
- **When MD recording is completed**
After “UTOC WRITING” is displayed, operation stops automatically. It also stops automatically when play of the last CD finishes.
- **To stop the recording at any time**
Press the ■ (stop) button.
The recording mode is released after “UTOC WRITING” is displayed.

- There is no need to adjust the recording level (for a digital recording).
- Upon completion of the MD recording, "UTOCH WRITING" is displayed. Operating any button while this message is displayed may render the MD unusable. Always wait for "UTOCH WRITING" to be cleared before proceeding with the next operation.
- This unit uses a microcomputer to perform a large number of operations. If the unit fails to operate no matter which button is pressed, disconnect the power cord, and then wait a few moments before re-connecting it.

CD Recording (LISTENING EDIT recording)

Selected tracks can be programmed and recorded.

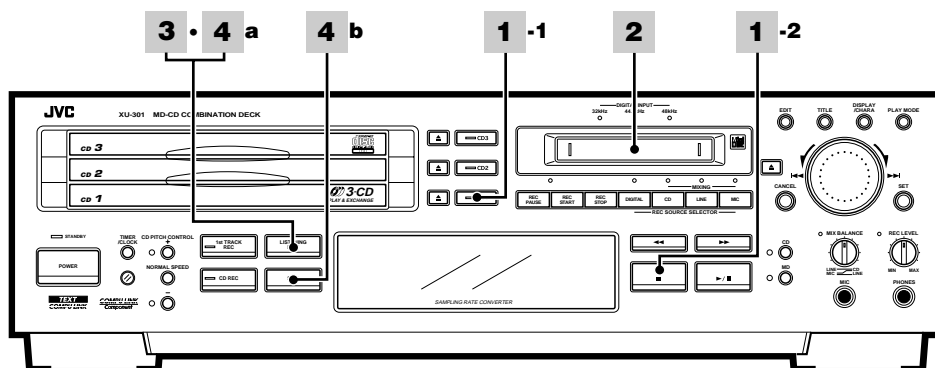

1 First, select and stop the CD to be recorded.

Example: When recording CD1

- Only the selected CD is recorded.

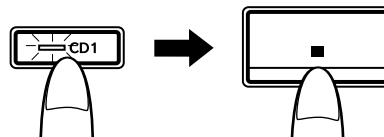

2 Insert the recording MD.

- Insert the MD with its label side facing up.

3 Press the LISTENING EDIT button.

- Start play from the first track, "LISTENING EDIT" is scrolled and displayed, and the play time of the first track and remaining recording time on the MD are displayed. MD is set to the rec pause mode.



4 Program the tracks (while the CD is playing).

- a. When the track now playing is to be recorded



- The track is stored in the memory, and operation moves on to the next track.

- b. When the track is not to be recorded

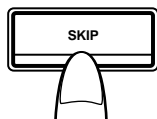

- The track is not stored in the memory, and operation moves on to the next track.

• When the first track has been stored in the memory

Play time of second track

Remaining recording time on MD

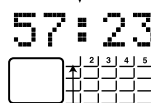

"1" is cleared from the music calendar.

- When there is not much recording time left on the MD, the tracks which can be recorded are automatically searched (on all the CDs).

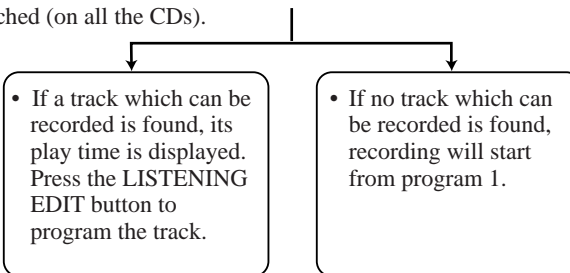

- When up to 32 tracks are programmed, recording starts from program 1. The same applies when the programming for all the CDs is completed.

When MD recording is completed

After "UTOC WRITING" is displayed, operation stops automatically. It also stops automatically when play of the last CD finishes.

To stop the recording at any time

Press the ■ (stop) button.

The recording mode is released after "UTOC WRITING" is displayed.



Track marking

The mode can be switched from AUTO to MANUAL or vice versa by pressing the TRACK MARKING button on the remote control.

When AUTO has been set:

- Whenever playback advances from one track to another during digital recording, the track number at the MD side is automatically incremented by 1.
- Whenever no sound at the playback side continues for 3 or more seconds during analog recording, the track number at the MD side is automatically incremented by 1.

When MANUAL has been set:

- The track number at the MD side remains unchanged whether digital recording or analog recording is performed.
- The track number at the MD side is automatically incremented by 1 by pressing the SET button on the remote control or unit at the desirable location.

- There is no need to adjust the recording level (for a digital recording).
- Up to 32 tracks can be included in the programming. The same track cannot be programmed twice.
- If a CD has no tracks which are to be recorded, remove it from the CD tray.
- Upon completion of the MD recording, "UTOC WRITING" is displayed. Operating any button while this message is displayed may render the MD unusable. Always wait for "UTOC WRITING" to be cleared before proceeding with the next operation.

Mixing Recording

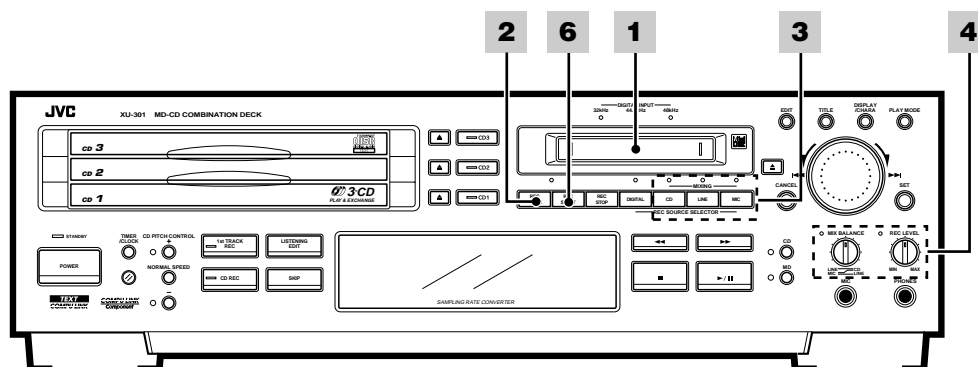

← Lamp lights.

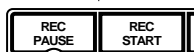

1 Insert the recording MD.

- Insert the MD with its label side facing up.

2 Establish the rec pause mode.

- The remaining recording time on the MD and MD appear in the display window. All the REC SOURCE SELECTOR lamps flash.

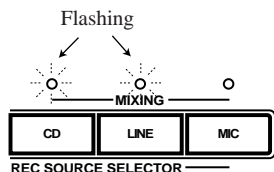

Example:
CD + LINE



- Press the same button again to clear the selection.

3 Select two recording sources.

- CD + LINE : To mix and record CD and line input signals
- CD + MIC : To mix and record CD and mic input signals
- LINE + MIC : To mix and record line input and mic input signals
- The lamps of the selected sources stop flashing and light. The other lamp goes off.
- Since analog signals are recorded, the REC LEVEL and MIX BALANCE lamps light.

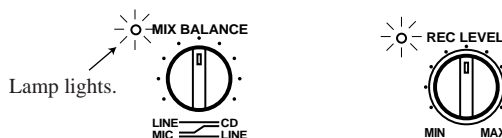

4 Adjust the recording level and mixing balance.

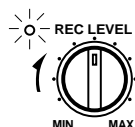

CD + LINE	CD volume is reduced.	Line input volume is reduced.
CD + MIC	CD volume is reduced.	Mic input volume is reduced.
LINE + MIC	Line input volume is reduced.	Mic input volume is reduced.

- Adjust the volume in such a way that the 0 dB display of the level meter is not exceeded when the loudest sound is supplied.

5 Play the sound of the source to be recorded.

- If the CD1 button is pressed when mixing with a CD and recording the result, the tracks are recorded in the following sequence: CD1 → CD2 → CD3.

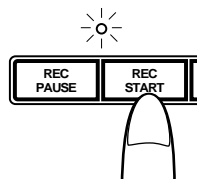

6 Press the REC START button to start the recording.

• When MD recording is completed

After "UTOOC WRITING" is displayed, operation stops automatically. Press the REC STOP button to stop the recording at any time.

- Upon completion of the MD recording, "UTOOC WRITING" is displayed. Operating any button while this message is displayed may render the MD unusable. Always wait for "UTOOC WRITING" to be cleared before proceeding with the next operation.

MD Editing Functions

Operate by following the steps below in numerical order.

In addition to its recording and play functions, the MD part of this combination unit comes with editing functions. Recorded tracks can be joined, divided or erased exactly where required.

Dividing tracks (DIVIDE function)

This involves adding a track mark (see Note) at some point during the track which is to be made into the start of an additional track so that the original track is divided into two tracks.

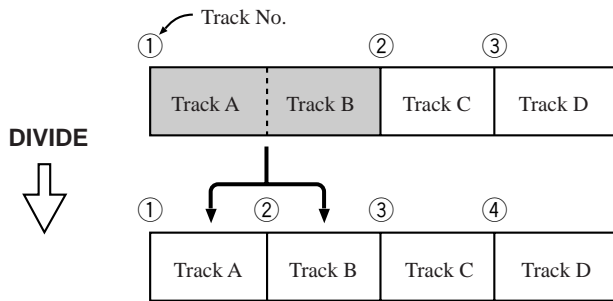

Erasing tracks (ERASE function)

This enables unnecessary tracks, narration, etc. to be erased speedily. The erased parts do not remain as silences but are closed up by the subsequent tracks.

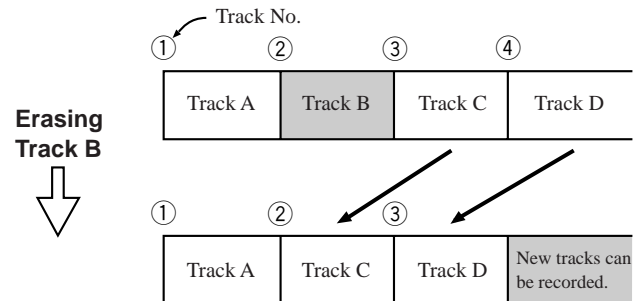

Joining tracks (JOIN function)

This involves erasing a track mark and turning two adjoining tracks into one track.

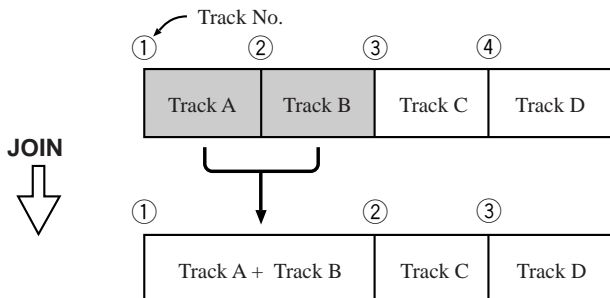

Erasing all the tracks (ALL ERASE function)

All the tracks can be erased at once without recording fresh material over them.

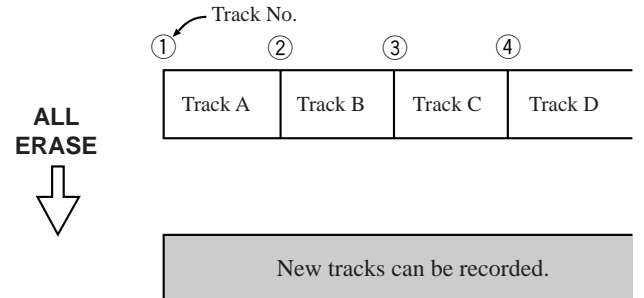

Moving tracks (MOVE function)

Tracks can be moved around so that they are in the desired sequence.

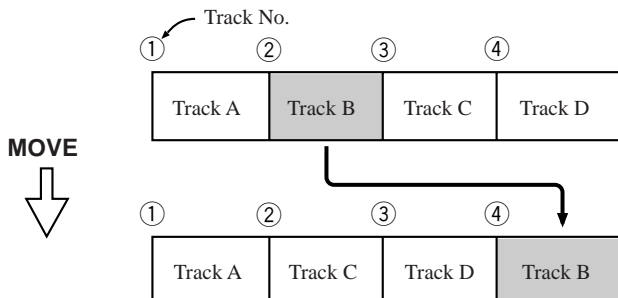

Giving titles to discs and tracks (TITLE function)

A title consisting of up to 32 characters can be given to a disc and a track. The title given appears in the display window.

■ **Note: Track marks**

These marks are provided to locate the start of each track. Whatever lies between one track mark and the next is considered to a track, and the numbers of the tracks (called "track numbers") are displayed in the sequence in which they are to be played.

Dividing tracks (DIVIDE function)

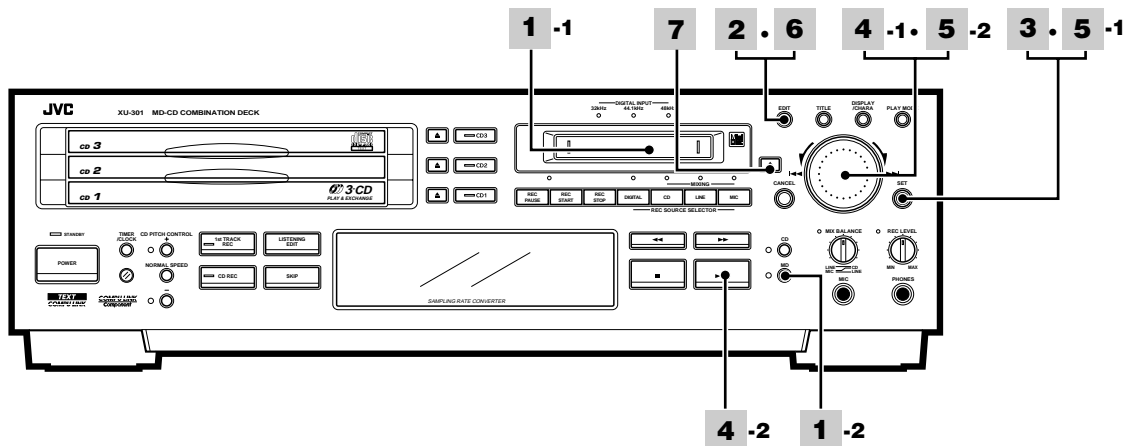

1 Insert the MD to be edited, and set the function to "MD."

- The number of tracks and play time are displayed.



2 Select "DIVIDE."

- The function changes each time this button is pressed.

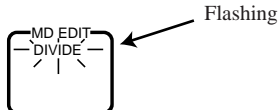

→ **DIVIDE** → JOIN → MOVE → ERASE → ALL ERASE →
(back to the beginning)

3 Press the SET button.



Now waiting for input
identifying track to be divided



4 Select the track to be divided and play it.



To return to a previous track To advance to a later track

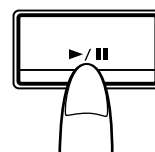

- When the track to be divided is selected using the number button on the remote control corresponding to the track number, the track is played directly.

5 Press the SET button at the point where the track is to be divided.

Example: When dividing the second track

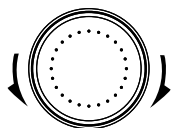

To return to a previous track To advance to a later track

- The numbers of the divided track and subsequent track flash on the music calendar, and the recording lasting for 4 seconds starting where the track was divided is repeatedly played.
- The jog dial can be used to finely adjust the position where the track is to be divided. Movement is possible within the POSITION -128 to 128 range (about 8 seconds before or after the position). The recording lasting for 4 seconds starting from the position to which the dividing point has been moved is repeatedly played.

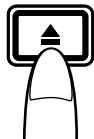

6 Press the EDIT button.

- “EDITING” appears, and the track number is incremented by 1. The change is stored in the memory IC.
- Play stops automatically.

7 Eject the MD. → The editing mode is now exited.

- After “UTOC WRITING” is displayed, the MD is ejected.
- The data in the memory IC has been recorded on the MD.

■ The editing mode can also be exited by pressing the POWER button in step 7 to turn off the power.

- When the wrong track is selected in step 4
Before pressing the SET button, turn the jog dial or use the number buttons on the remote control to select the track again.
- To stop DIVIDE at any time
Press the EDIT button. If the SET button has already been pressed as in step 5, first press the CANCEL button, and then press the EDIT button.
- Do not disconnect the power cord or subject the unit to the vibration while “UTOC WRITING” appears. Doing so may make it impossible to play the MD.

Joining tracks (JOIN function)

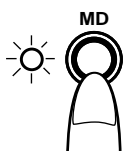
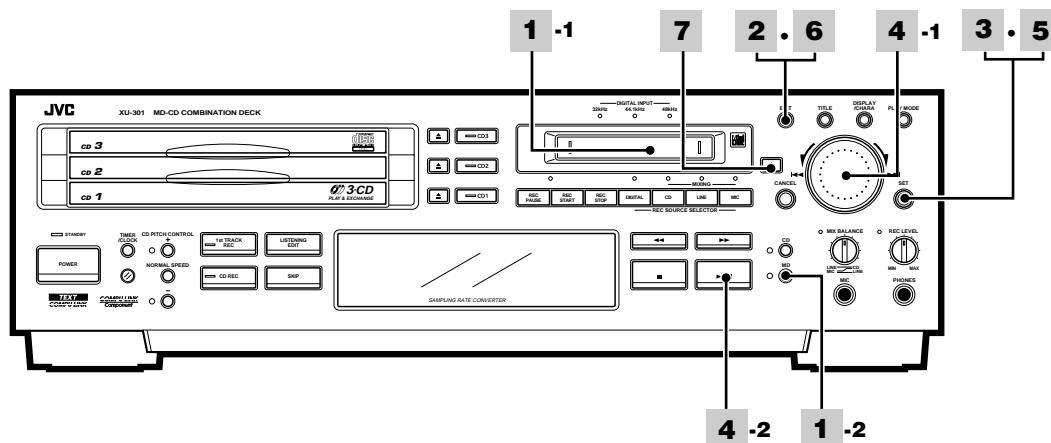

- The function changes each time this button is pressed.

1 Insert the MD to be edited, and set the function to “MD.”

- The number of tracks and play time are displayed.

2 Select “JOIN.”

Flashing → DIVIDE → **JOIN** → MOVE → ERASE → ALL ERASE →
(back to the beginning)

3 Press the SET button.

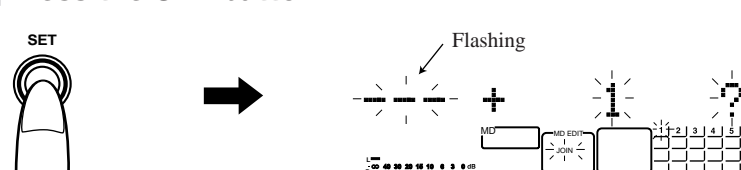

4 Select the track to be joined and play it.

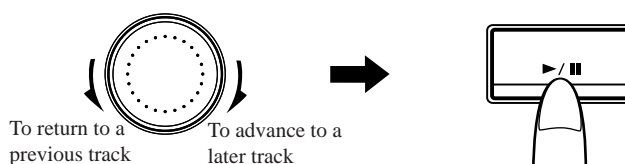

- When the track to be joined is selected using the number button on the remote control corresponding to the track number, the track is played directly.

5 Press the SET button.

Example: When joining the second track

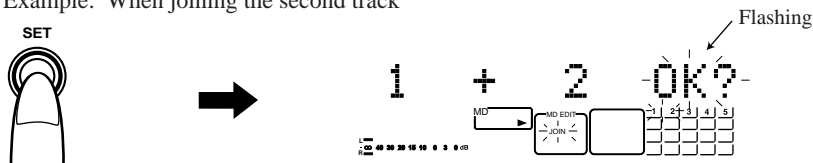

6 Press the EDIT button.

- “EDITING” appears, and the track number is decremented by 1. The change is stored in the memory IC.
- Play stops automatically.

7 Eject the MD. → The editing mode is now exited.

- After “UTOO WRITING” is displayed, the MD is ejected.
- The data in the memory IC has been recorded on the MD.

■ The editing mode can also be exited by pressing the POWER button in step 7 to turn off the power.

- When the wrong track is selected in step 4
Before pressing the SET button, turn the jog dial or use the number buttons on the remote control to select the track again.
- To stop JOIN at any time
Press the EDIT button. If the SET button has already been pressed as in step 5, first press the CANCEL button, and then press the EDIT button.
- Do not disconnect the power cord or subject the unit to the vibration while “UTOO WRITING” appears. Doing so may make it impossible to play the MD.

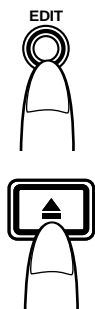

Moving tracks (MOVE function)

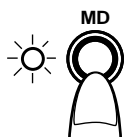
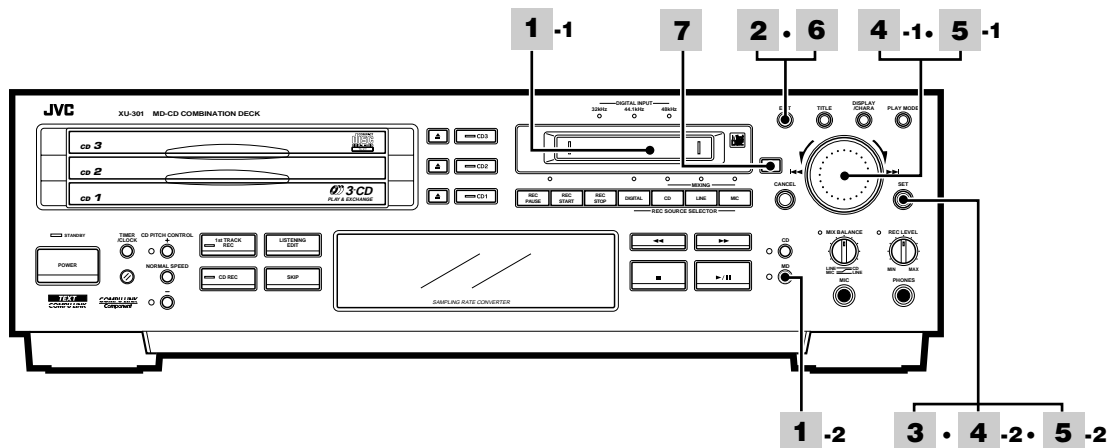

1 Insert the MD to be edited, and set the function to “MD.”

- The number of tracks and play time are displayed.



2 Select “MOVE.”

• The function changes each time this button is pressed.

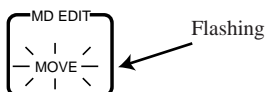

→ DIVIDE → JOIN → **MOVE** → ERASE → ALL ERASE →
(back to the beginning)

3 Press the SET button.



4 Select the track to be moved.

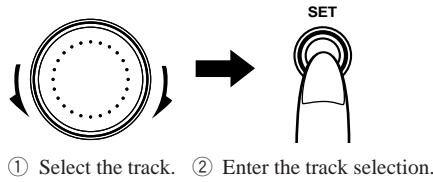

Example: When the second track has been selected

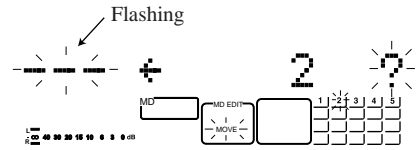

- When the track to be moved is selected using the number button on the remote control corresponding to the track number, the track is played directly.

5 Select the destination to which the track is to be moved.

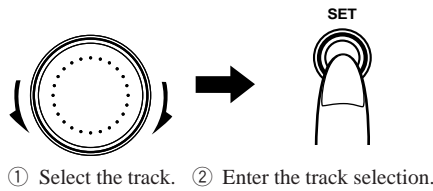

Example: When moving the track to the fourth track

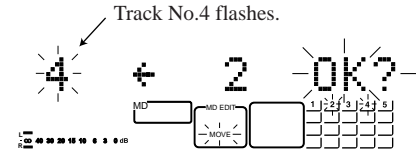

- When the movement destination is selected using the number button on the remote control corresponding to the track number at the destination, the track is played directly.

6 Press the EDIT button.

- “EDITING” appears, and the sequence of tracks is changed. The change is stored in the memory IC.



7 Eject the MD. → The editing mode is now exited.

- After “UTOC WRITING” is displayed, the MD is ejected.
- The data in the memory IC has been recorded on the MD.

■ The editing mode can also be exited by pressing the POWER button in step 7 to turn off the power.

- When the wrong track is selected in step 4 and/or step 5. Before pressing the SET button, turn the jog dial or use the number buttons on the remote control to select the track again.
- To stop MOVE at any time Press the EDIT button. If the movement destination has already been selected as in step 5, first press the CANCEL button, and then press the EDIT button.
- Do not disconnect the power cord or subject the unit to the vibration while “UTOC WRITING” appears. Doing so may make it impossible to play the MD.

Erasing a track (ERASE function)

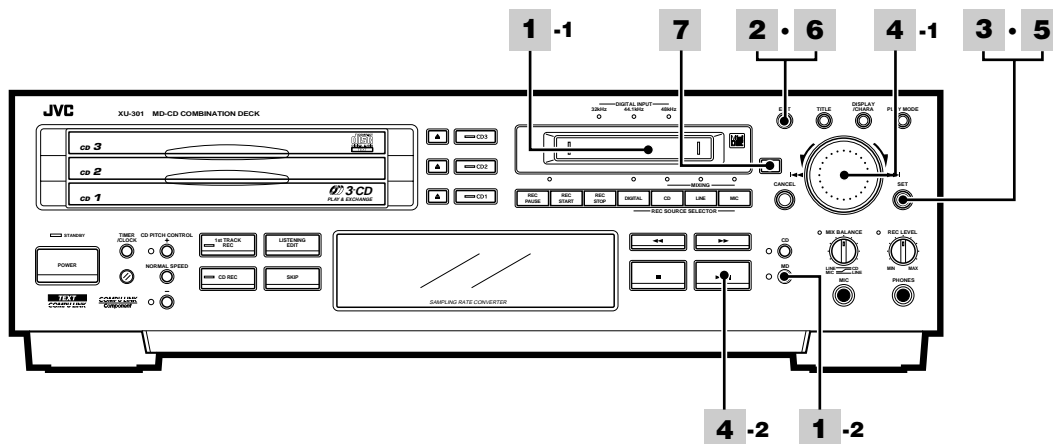

1 Insert the MD to be edited, and set the function to "MD."

- The number of tracks and play time are displayed.



2 Select "ERASE."

- The function changes each time this button is pressed.



→ DIVIDE → JOIN → MOVE → **ERASE** → ALL ERASE →
(back to the beginning)

3 Press the SET button.

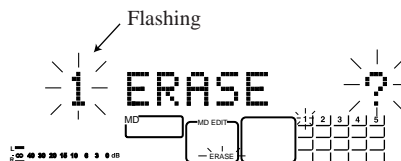

4 Select the track to be erased and play it.



To return to a previous track



To advance to a later track

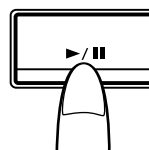

- When the number button on the remote control corresponding to the track number is pressed, the track to be erased is played directly.

5 Press the SET button.

Example: When erasing the second track

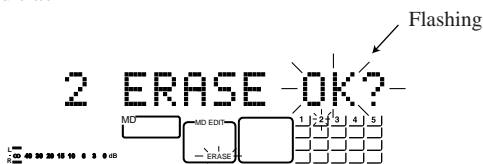

6 Press the EDIT button.

- "EDITING" appears, and the second track is erased. The change is stored in the memory IC.
- Play stops automatically.

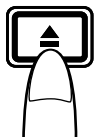

7 Eject the MD. → The editing mode is now exited.

- After “UTOCH WRITING” is displayed, the MD is ejected.
- The data in the memory IC has been recorded on the MD.

■ The editing mode can also be exited by pressing the POWER button in step 7 to turn off the power.

- Once a track is erased, the recording cannot be restored. Keep the accidental erasure prevention knob on an MD containing important recordings to the open position. → See page 27.
- When the wrong track is selected in step 4 Before pressing the SET button, turn the jog dial or use the number buttons on the remote control to select the track again.
- To stop ERASE at any time Press the EDIT button. If the track has already been selected as in step 5, first press the CANCEL button twice, and then press the EDIT button.
- Do not disconnect the power cord or subject the unit to the vibration while “UTOCH WRITING” appears. Doing so may make it impossible to play the MD.

Erasing all the tracks (ALL ERASE function)

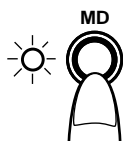
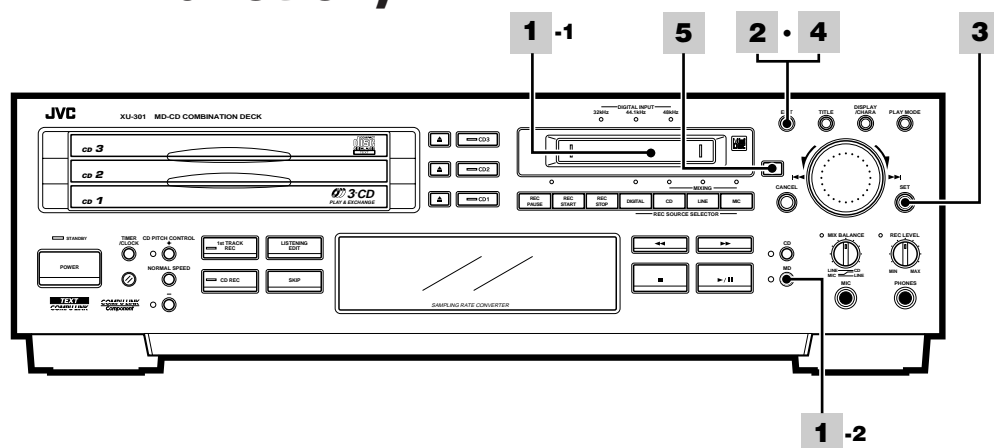

1 Insert the MD to be edited, and set the function to “MD.”

- The number of tracks and play time are displayed.



2 Select “ALL ERASE.”

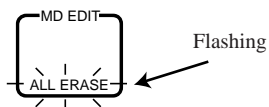

→ DIVIDE → JOIN → MOVE → ERASE → **ALL ERASE** → (back to the beginning)

- The function changes each time this button is pressed.

3 Press the SET button.



4 Press the EDIT button.

EDITING → MD BLANK DISC

- “MD BLANK DISC” appears, and all the tracks are erased. The change is stored in the memory IC.



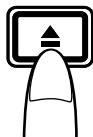

5 Eject the MD. → The editing mode is now exited.

- After “UTOC WRITING” is displayed, the MD is ejected.
- The data in the memory IC has been recorded on the MD.

■ The editing mode can also be exited by pressing the POWER button in step 5 to turn off the power.

■ To stop the ALL ERASE operation at any time
Press the EDIT button.

■ Do not disconnect the power cord or subject the unit to the vibration while “UTOC WRITING” appears. Doing so may make it impossible to play the MD.

Giving titles to discs and tracks (TITLE function)

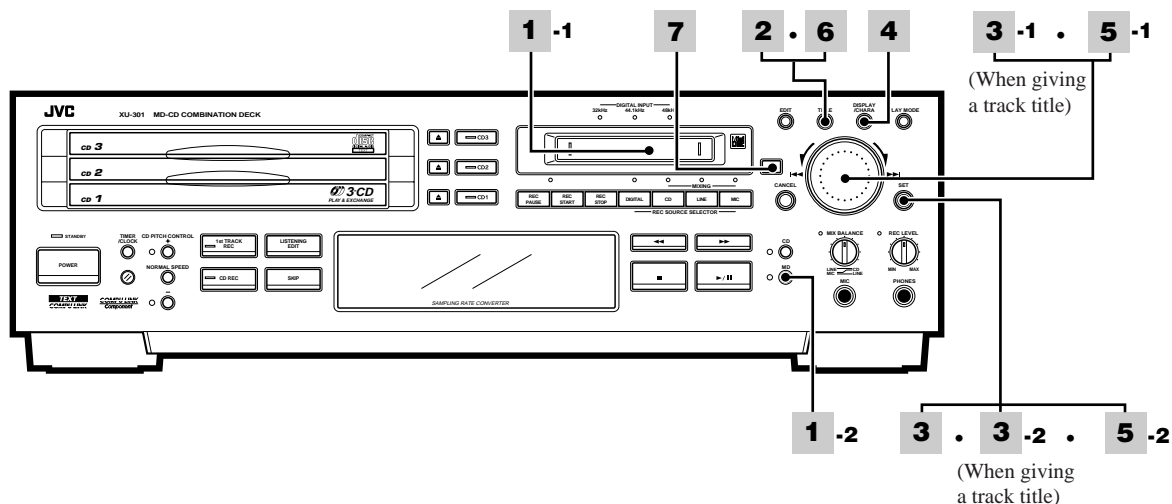

1 Insert the MD to be edited, and set the function to “MD.”

- The number of tracks and play time are displayed.

2 Press the “TITLE” button.

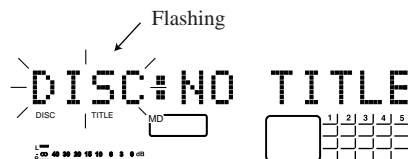

- Press this when the unit is in the stop mode.

3

- **To give a title to a disc (DISC TITLE). Press the SET button.**

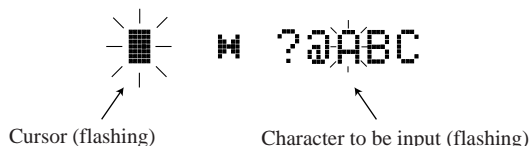

- **To give a title to a track (TRACK TITLE) Select the track which is to be given a title, and press the SET button.**

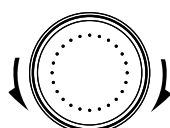

- The cursor flashes.

Example: Giving a title to track No.1

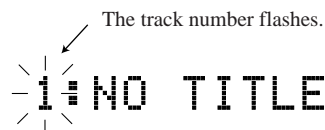

4 Select the type of characters to be used for the title.



Each time this is pressed, the character type changes. (The input characters appear in the display window.)

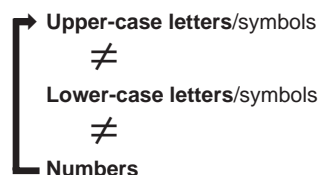

For details, refer to the character layout table on page 44.

5 Input the title (using up to 32 characters).

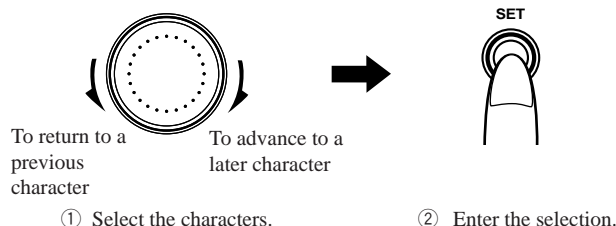

① Select the characters.

② Enter the selection.

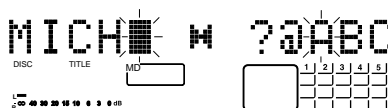

- If the wrong character has been input, clear it using the CANCEL button.
- The preferred title is input by repeating steps 4 and 5.
- To clear a particular character which has been input, use the ◀◀ button to align the cursor with the character, and press the CANCEL button. Then, select the correct character and press the SET button. In this way, the character can be corrected.
- If the ▶▶ button is pressed when the cursor is positioned as shown in the figure above, a space will be input.

6 Press the TITLE button.

- The title now appears after "EDITING." It is stored in the memory IC.
- To give other tracks titles, repeat the procedure starting with step 2.



7 Eject the MD. → The editing mode is now exited.

- After "UTOOC WRITING" is displayed, the MD is ejected.
- The data in the memory IC has been recorded on the MD.

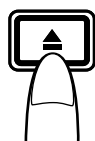

■ The editing mode can also be exited by pressing the POWER button in step 7 to turn off the power.

- In step 3, only those numbers of the tracks which are recorded on the MD can be selected by the jog dial as track numbers.
- To stop operation at any time
Press the TITLE button in step 2, 3, 4 or 5.
- Up to 5 characters which are being input can be displayed. When the sixth character is input, the characters are scrolled forward so that the first character is cleared from the display.
- Do not disconnect the power cord or subject the unit to the vibration while "UTOOC WRITING" appears. Doing so may make it impossible to play the MD.

Editing operations using the remote control

Buttons bearing the same markings as those on the main unit function in exactly the same way as their main unit counterparts. This section describes how to use the buttons on the remote control which are not provided on the main unit.

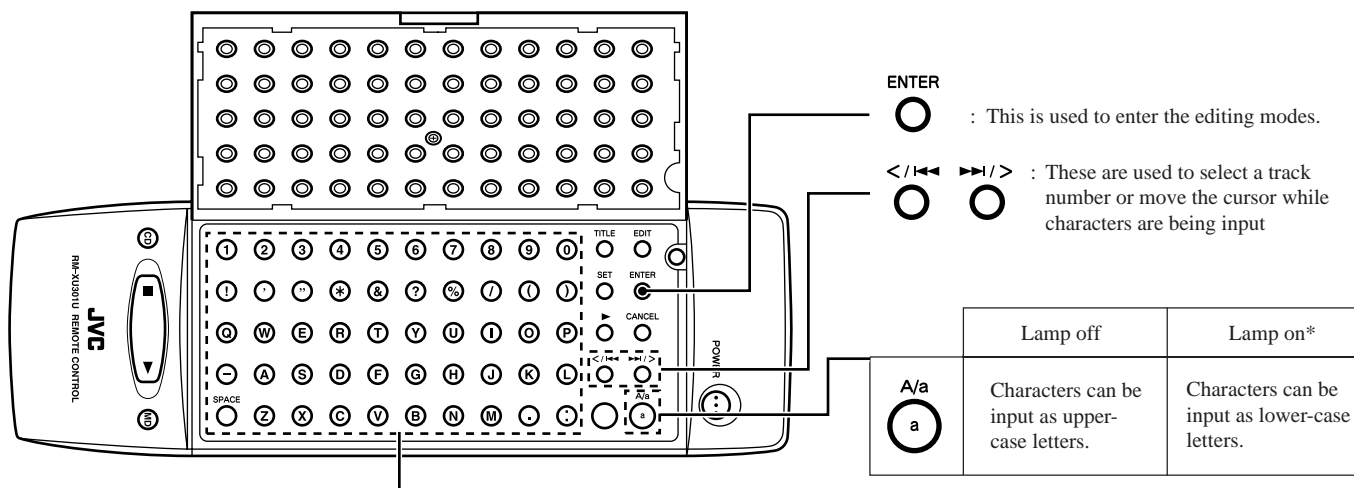





Character input buttons:

These are used to input alphanumerics directly as per the character input mode.
Spaces and “-” can be input regardless of the input mode which has been selected.

* The lamp automatically goes off if none of the button is pressed for two or more minutes.
The lamp can be turned on or off by pressing the  button.

Giving titles to discs and tracks using the remote control

- 1 Insert the MD to be edited, and press the MD button. Open the remote control's cover.**
- 2 Press the TITLE button.**
- 3 -1 (MD stop mode)**
 - **To give a title to a disc:**
Press the SET button.
 - **To give a title to a track:**
Select the track using , and press the SET button.
- 3 -2 (During MD play)**
Proceed to skipping step 4.
- 4 Select upper-case or lower-case letters using the  button.**
 -  (Lamp off) : Upper-case letters can be input.
 -  (Lamp on) : Lower-case letters can be input.
- 5 Input the title (containing up to 32 characters) using the character input buttons.**
 - The characters can be input directly.
- 6 Press the ENTER button.**
 - The procedure can also be completed by pressing the TITLE button again.
- 7 Eject the MD. → This completes the editing.**
 - UTOC WRITING flashes, and the MD is ejected.

■ When selecting a track using the number buttons on the remote control, keep the remote control's cover closed while using the buttons.

Character Layout Table

This unit enables the titles of the album and tracks to be written for the disc and tracks which have been recorded. The characters which can be used for this purpose are shown below.

Upper-case letters

A	B	C	D	E
F	G	H	I	J
K	L	M	N	O
P	Q	R	S	T
U	V	W	X	Y
Z				
(space)	!	”	#	\$
%	&	'	()
*	+	,	-	.
/	:	;	<	=
>	?	@		

Lower-case letters

a	b	c	d	e
f	g	h	i	j
k	l	m	n	o
p	q	r	s	t
u	v	w	x	y
z				
(space)	!	”	#	\$
%	&	'	()
*	+	,	-	.
/	:	;	<	=
>	?	@		

Numbers

0	1	2	3	4
5	6	7	8	9

Setting the Clock

Setting the Present Time

(to be performed when the unit is to be used for the first time)

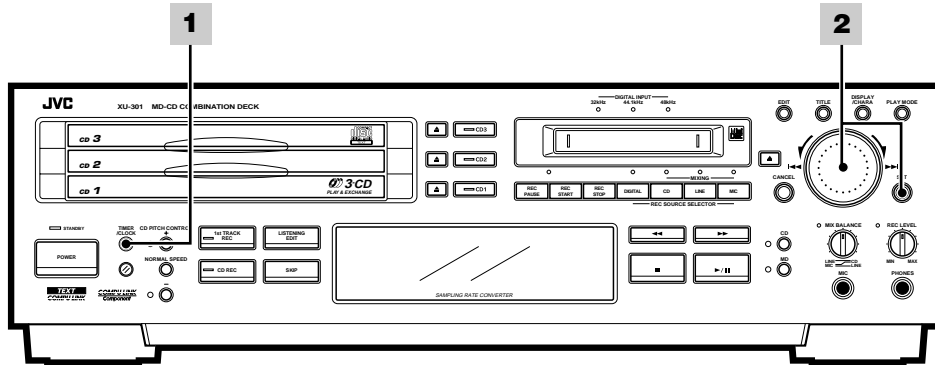

- **Example: Setting the time to 1:15 PM (while the power is OFF)**
This unit uses a 12-hour clock to indicate the time.

1 Press the **TIMER/CLOCK** button.

- The time display is illuminated, and the “hour” display starts flashing.

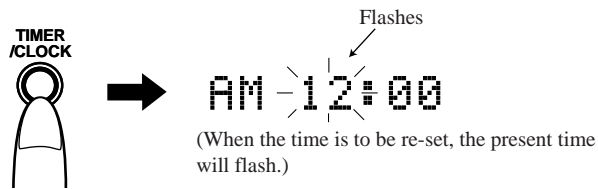

2 Set the clock. (The time changes continuously when the jog dial is turned.)

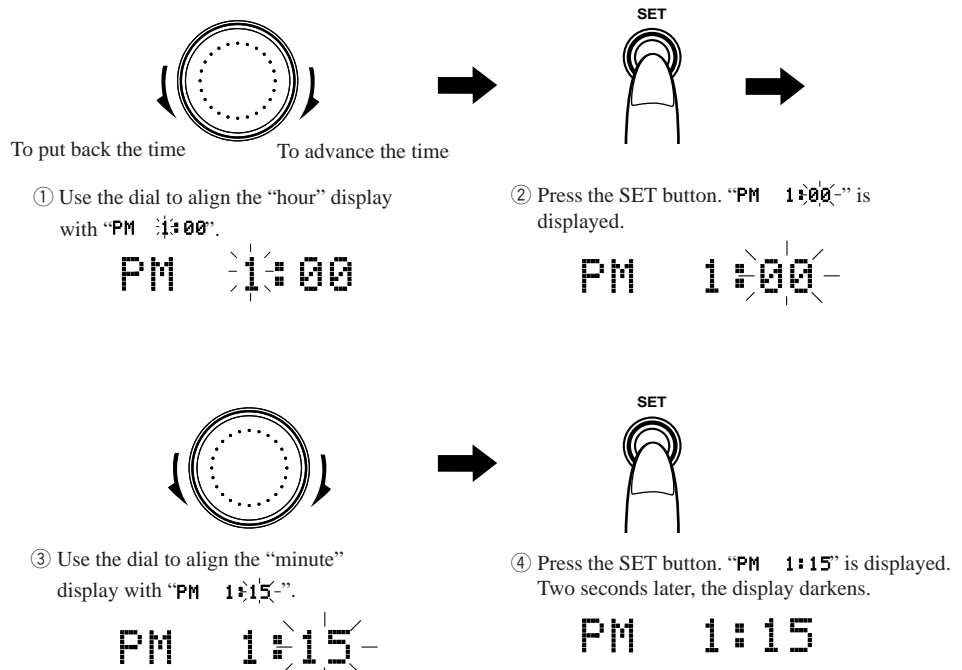

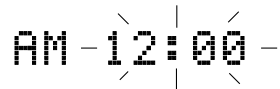

- **To ascertain the correct time**
Use the time display on your TV screen or call the speaking clock.
- **When a power failure has occurred or the power cord has been disconnected**
The time display is cleared, and the "AM 12:00" flashing display is returned. In a case like this, re-set the time by previous steps 1 and 2. When the power cord is left disconnected for an extended period of time, the time display returns to "0:00."
- **Setting the time while the power is ON**
After the power has been turned on, press the TIMER/CLOCK button, select the present time display, and set the time.

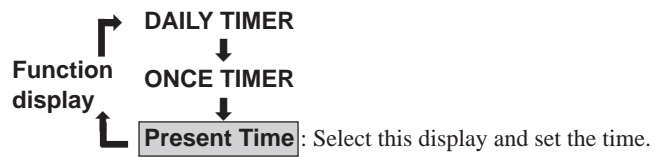

■ If the CANCEL button is pressed while setting the "minute" display, the flashing "hour" display is restored. This function comes in handy for correcting the "hour" display.

Timer Operations

Operate by following the steps below in numerical order.

Timer Play (wake-up play)

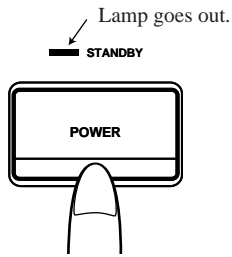
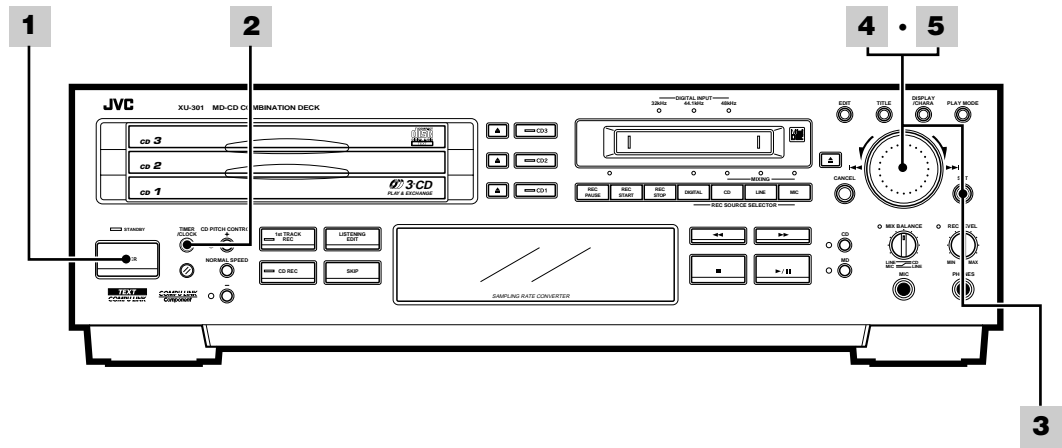

- 1 Turn on the power.**
 - The selected function ("CD" at the time of purchase) is displayed.
- 2 Select the timer mode (DAILY TIMER or ONCE TIMER).**

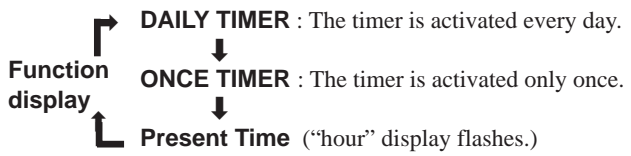

• The mode changes each time this button is pressed.

Operating examples

- Set DAILY TIMER for timer playback.
- Set ONCE TIMER for timer recording.

3 Press the SET button.



The start time flashes.
ON AM 12:00

4 Set the timer start time (this unit uses a 12-hour clock).

Example: When timer play is to start at 7:15AM



To put back the time To advance the time

① Use the dial to align the "hour" display with "AM 7:00".

AM 7:00

② Press the SET button. "AM 7:00" is displayed.

AM 7:00

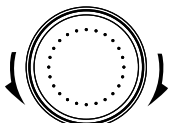

③ Use the dial to align the "minute" display with "AM 7:15".

AM 7:15

④ Press the SET button. "OFF AM 12:00" is displayed. The end time flashes.

OFF AM 12:00

5 Set the timer end time.

Example: When timer play is to end at 8:15AM

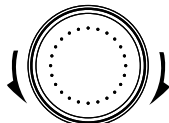

To put back the time To advance the time

① Use the dial to align the "hour" display with "AM 8:00".

AM 8:00

② Press the SET button. "AM 8:00" is displayed.

AM 8:00

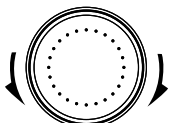

③ Use the dial to align the "minute" display with "AM 8:15".

AM 8:15

④ Press the SET button. "PLAY?" is displayed.

PLAY?

↓
Continues to page 48 or 49.

- Before proceeding with timer programming, make sure that the present time has been set correctly. → See page 45.
- If the CANCEL button is pressed while setting the "minute" display, the flashing "hour" display is restored. This function comes in handy for correcting the "hour" display.

Timer Play (wake-up play) (continued)

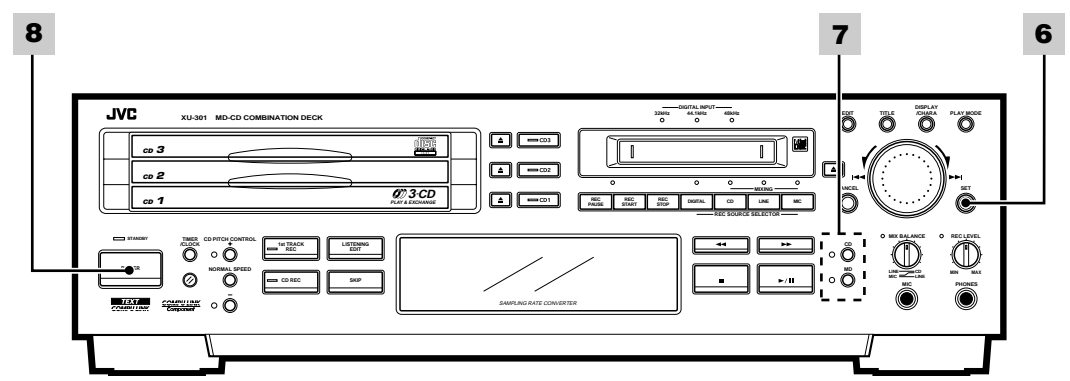

Continued from page 47 (while "PLAY?" is flashing)

6 Press the SET button.

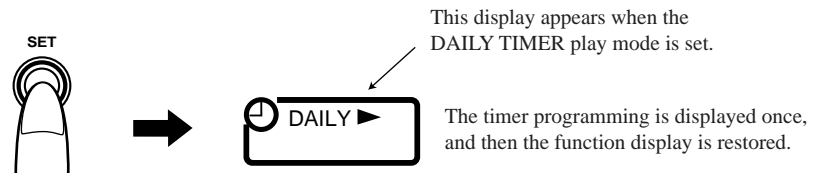

- When "REC?" flashes, turn the jog dial to select "PLAY?" flashing.
- The timer programming is displayed once, and then the function display is restored.

7 Set the function to "CD" or "MD"—whichever disc is to be heard—and place the MD or CD in position.

- When MD play is set.
 - Place the MD to be heard in position.
- When CD play is set.
 - Place the CD or CDs to be heard in position on the CD1, CD2 and/or CD3 tray.

8 Turn off the power.

The present time now appears in the display window.

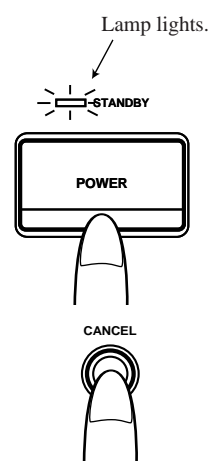

- Match the connected receiver or other source with the unit's setting, and adjust the volume to the appropriate level. Match the timer with the unit's timer setting.
 -
 -
- Timer play now starts at the programmed start time, and the power is turned off at the programmed end time.
- **Clearing a timer operation**

Turn on the power, press the TIMER/CLOCK button, select the timer mode, and press the CANCEL button.

The DAILY ► (or ONCE ►) display is cleared, and the timer operation is also cleared.

Timer Recording (unattended recording of the sound from a broadcast receiver or other component)

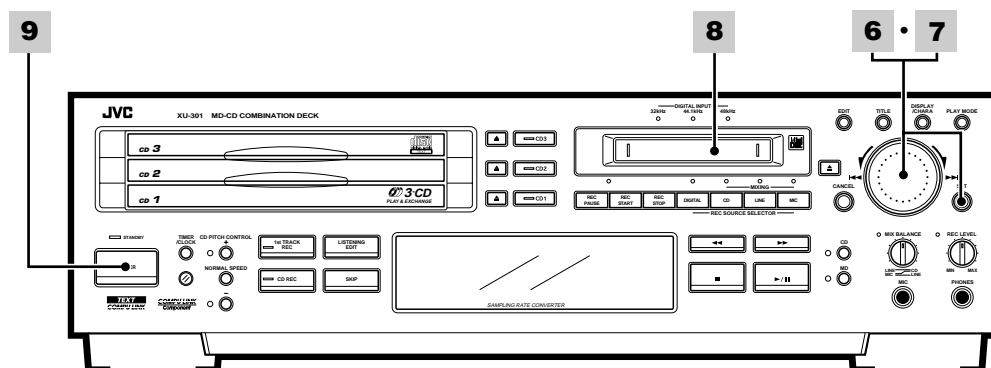

Continued from page 47 (while "PLAY?" is flashing)

6 Select "REC?" and press the SET button.

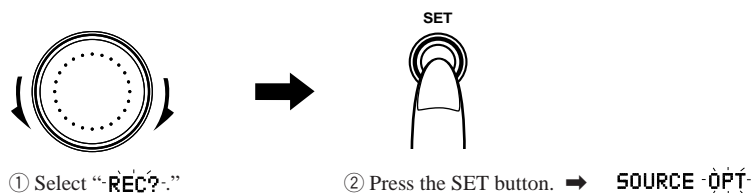

7 Select the sound source to be recorded, and press the SET button.

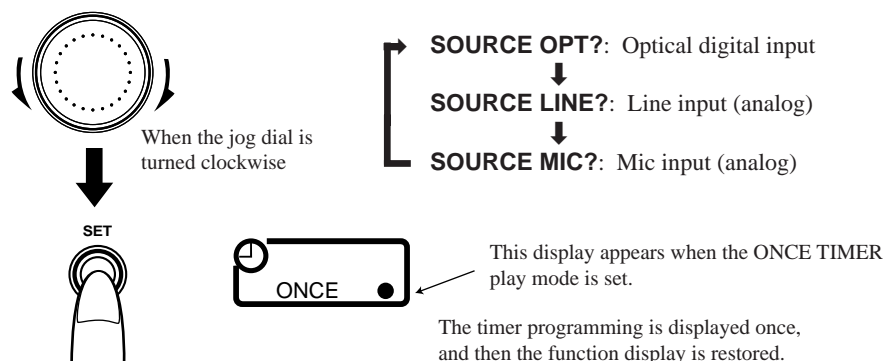

8 Place the recording MD in position.

- Place the MD with its label side facing up, and insert it in the direction of the ▷ or ⇒ mark.

9 Turn off the power.

The present time now appears in the display window.

- Match the timer of the connected source with the unit's setting. (In the case of the mic input, ensure that the microphone has been connected to the unit.)

⋮

- Recording will now start at the programmed start time, and the power will be turned off at the programmed end time.
When operation is completed once in the ONCE TIMER mode, the timer programming is cleared.

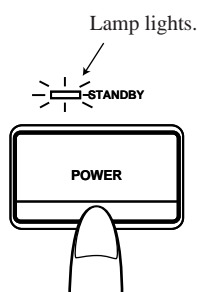

- If digital signals are not supplied when timer recording has been started with digital input signals, "DIGITAL IN UNLOCK" is scrolled on the display, and no signals will be recorded.
- When using the timer to record a BS program, for instance, check that the broadcast station with the desired program can be tuned in correctly before programming the timer start and end times.
- The timer programming is cleared when the power has failed or the power cord has been disconnected. In a case like this, reset the clock and repeat the timer programming.

COMPU LINK Function

• What is COMPU LINK?

The COMPU LINK remote control system (or, simply, "COMPU LINK") serves to enable the kind of simple operations provided by an integrated component to be conducted even though this unit is a discrete component.

These simple operations can be performed by connecting the COMPU LINK-3 SYNCHRO or COMPU LINK-1 SYNCHRO connector on each of the components involved.

Connections

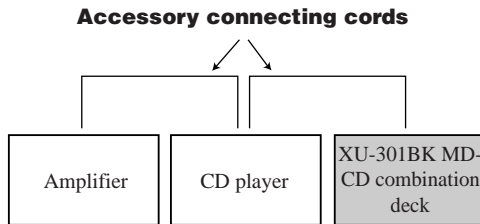

The COMPU LINK functions provided with JVC's products come in the form of COMPU LINK-3 or COMPU LINK-1. They are compatible, and the difference between them is that COMPU LINK-3 has the functions of COMPU LINK-1 and some additional functions as well.

• Synchro recording

With this function, recording starts automatically in synchronization with the start of the source playback.

How to identify the type of
COMPU LINK function provided

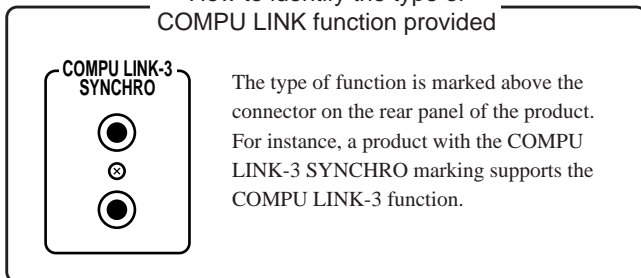

Operation To perform

• Synchro recording

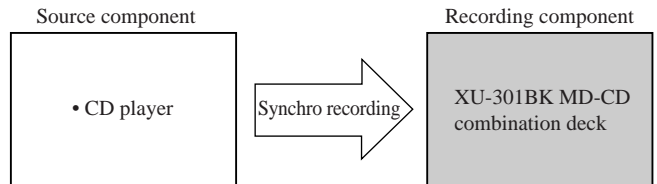

Example: CD player → MD-CD combination deck

1 Place the CD inside the CD player.

- Program the tracks if they are to be recorded in a programmed sequence.

2 Place the recording MD in the MD-CD combination deck.

3 Press the DIGITAL button (with digital connections).

- Press the LINE button when analog connections have been performed.

4 Press the REC PAUSE button.

- Always proceed to operate from the stop mode.

5 Press the PLAY button on the CD player.

- The CD play and MD-CD combination deck recording now start automatically.

TEXT COMPU LINK Control System

This system transfers text information back and forth between the individual components of an audio system, and it enables CD text and MD text information to be displayed on the receiver (or amplifier) or on the TV screen, in which case it uses the on-screen display function of the receiver (or amplifier). The following operations can be performed by connecting the unit using the TEXT COMPU LINK function.

- Tracks can be selected by checking their disc and track titles displayed on the TV screen.
- Disc or track titles can be input for recording MDs using the TV screen.
- When recording material from a CD which supports the CD TEXT function to an MD, the CD TEXT track title information is recorded in its original form onto the MD.

Connections with amplifier or receiver (refer to page 4)

To use this control system, the XU-301BK must be connected with the stereo receiver or stereo amplifier following the steps below.

1. If the stereo receiver or amplifier and this unit have already been plugged into the AC outlets, disconnect their AC power cords.
2. Connect the receiver and unit as described below using the COMPU LINK-3 (SYNCHRO) and TEXT COMPU LINK connectors.

- 1) COMPU LINK-3 (SYNCHRO) connectors: Use the cable with the monaural mini-plugs (black).

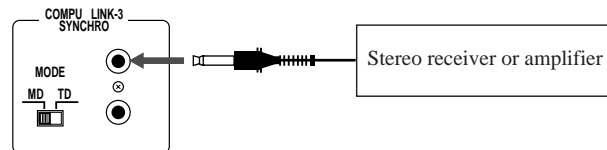

- 2) TEXT COMPU LINK connectors: Use the cable with the stereo mini-plugs (green).

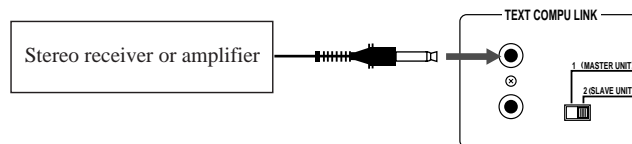

IMPORTANT:

Set the Master/Slave Selector on the rear panel to "2 (SLAVE UNIT)."

3. Connect the stereo receiver and unit using the cables with RCA pin plugs (see page 4) (and a digital cable if desired: see page 5).
4. Connect the AC power cords of these components to the AC outlets.

Notes:

- In order to use the TEXT COMPU LINK function, you must use a JVC receiver (or amplifier) which supports this function and you must connect it correctly using the designated cord.
- For further details on how to use the TEXT COMPU LINK function, refer to the Instruction Manual accompanying the receiver (or amplifier) which supports this function.

Connection to CD player or CD changer (refer to page 4 and 5)

This unit can record CD TEXT information onto an MD when it is directly connected to a CD changer made by JVC which supports the TEXT COMPU LINK function. The optical digital cables are used for this connection.

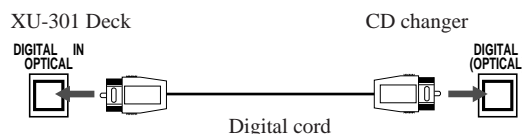

NOTES:

- Connect the COMPU LINK-3 (SYNCHRO) connector on the unit to the COMPU LINK-3 (SYNCHRO) connector on the CD changer.
- Connect the TEXT COMPU LINK connector on the unit to the TEXT COMPU LINK connector on the CD changer.
- Set the master/slave selector on the unit to "1 (MASTER UNIT)."

Information on MDs (Minidiscs)

This is a new digital audio disc format: it has a diameter of 64 mm and enables up to 74 minutes of playback and recording.

Function of the cartridge

The diameter of the actual disc is 64 mm, making it slightly smaller than CD singles. Each disc is housed in a cartridge. The pocket-size cartridge measures 68 x 72 mm and is 5 mm thick. It is easy to carry about and store. Since the disc is protected by the cartridge, it is kept free from dust and dirt, and there is no danger of the disc being scratched or exposed to fingerprints due to the shutter which is closed at all times except while the disc is being used. All in all, these features make the minidisc extremely easy to use.

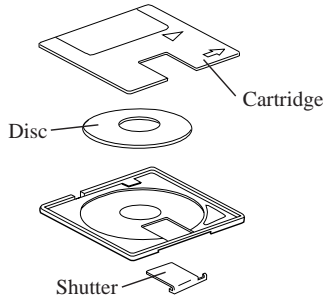

Two types of discs available

MDs come in two types: the recording MD which can be used for recording, and the play-only MD which can be used for playback only. Both types use the same system for playback: a laser beam is directed onto the disc and the signals are read out by its reflection. However, the system for recording is different.

Play-only MDs

This type of MD is used for pre-recorded MDs available on the market. It cannot be used for recording. As with CDs, data is recorded by the presence or absence of small indentations called pits. A disc with this kind of recording system is called an "optical disc."

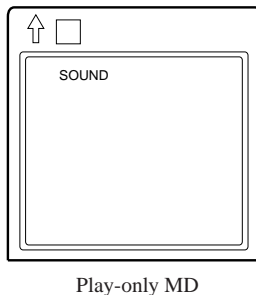

Recording MDs

This is the "blank" type of MD which can be used for recording. Its data is recorded using magnetism which is easily processed so that recordings can be made again and again. By using a laser beam to heat spots on its surface to cancel out the magnetism, the data is recorded using a magnetic head. A disc with this kind of recording system is called a "magneto-optical disc."

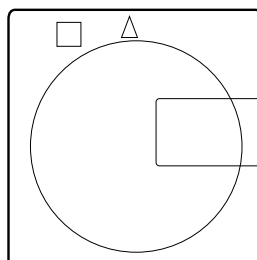

ATRAC (Adaptive Transform Acoustic Coding)

Sound contains some elements which are not actually very audible. For instance, when the sound is soft, it is hard to hear the bass and treble. Also, during or immediately after a passage of loud sound, soft sounds cannot be heard even though they may be there. A technique called ATRAC (Adaptive Transform Acoustic Coding) is used with MDs to select or dispense with sounds on the basis of our acoustic characteristics so that the data is compressed into a small quantity. It compresses the data to be recorded into about one-fifth of the original data so that it can be stored even on a small-size MD.

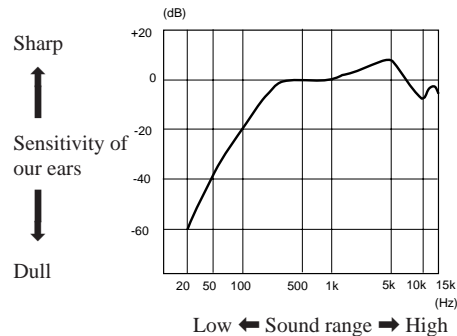

Sound range and sensitivity of our ears

Sound jump guard memory

When an MD is played, a function (sound jump guard memory) operates to store the data of the track being played instantly in a memory to prevent jumps in the sound due to vibration. When the disc signals cannot be read by the optical laser because of vibration, the function uses the data in the "sound jump guard memory" to ensure that there are no breaks in the sound actually heard.

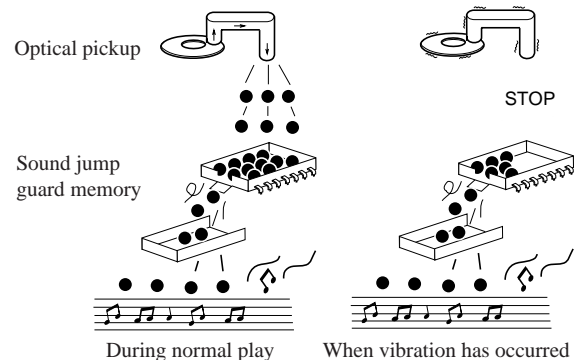

UTOC (User Table of Contents)

In addition to the data of its tracks, a recording MD comes with the UTOC contents facility. This records the position of each track, the breaks between the tracks, the track sequence, etc., and tracks can be searched quickly by viewing these contents. During editing, all that changes is the UTOC contents: the tracks themselves need not be re-recorded.

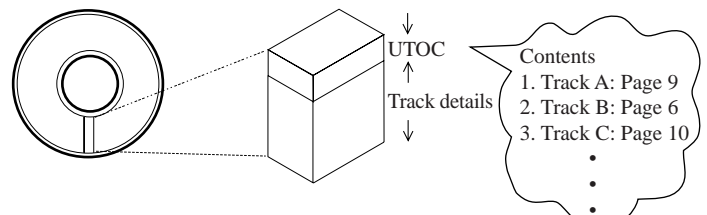

MD (Minidisc) Error Messages

Error message	Significance	Remedy
MD BLANK DISC	An MD with nothing recorded on it has been inserted.	Replace with a pre-recorded MD unless something is to be recorded onto the blank MD.
CANNOT JOIN	An attempt has been made to join tracks which cannot be joined.	This is due to limitations on the MD system. (See page 54 .)
DISC ERROR	Trouble with MD (damage).	Replace the MD.
DISC FULL	The MD does not have enough available time. The track number has exceeded 254.	Replace with another recording MD.
DISC PROTECTED	The MD has been set to the accidental erasure prevention mode.	Slide the MD's accidental erasure prevention knob so that the hole is blocked.
EMERGENCY STOP	An error occurred during recording.	Stop operation by pressing the ■ (stop) button, and perform the operation again.
MD NO DISC	An MD has not been inserted.	Insert an MD.
NON AUDIO CANNOT COPY	An attempt was made to digitally copy a CD-ROM (or video CD, etc.).	Stop the recording.
PLAYBACK DISC	An attempt was made to record or edit a play-only MD.	Replace with a recording MD.
TRACK PROTECTED	The track is protected.	This cannot be released by this unit. Release it at the unit which originally protected the track.
SCMS CANNOT COPY	An attempt was made to digitally record a digitally recorded source.	Set to analog recording.

Restrictions Imposed by MDs (Minidiscs)

MDs use their own system to record information which is different from conventional cassette tapes and DAT tapes. This system has a number of restrictions which sometimes give rise to the following symptoms. These symptoms do not, however, indicate that something is wrong with the product.

Symptom	Cause
"DISC FULL" is displayed even though the recording time displayed for the MD has not been used up.	The number of tracks which can be recorded on an MD is limited, and this has nothing to do with the recording time. Track numbers 255 and above cannot be recorded.
"DISC FULL" is displayed despite sufficient leeway in track numbers and recording time.	When some of the MD recordings are erased and replaced with new recording repeatedly, empty areas are formed on parts of the disc. When a recording is made on this kind of disc, the data of a track is divided in bits and pieces among and recorded on these empty areas. When the number of these divided areas increases, "DISC FULL" may be displayed during recording. If the data is divided so that some parts are less than 8 seconds in length, it may not be possible to use the JOIN function to join the track concerned. In addition, the remaining time will not increase even if these parts are erased. The sound of tracks which have been divided up in bits and pieces and recorded may break up during rapid advance or rapid reverse operations.
It is sometimes not possible to use the JOIN function.	
The remaining time is not increased even though tracks are deleted.	
The sound is sometimes skipped during rapid advance or rapid reverse operations.	
The recorded time and the remaining time together do not equal the recording time displayed for the MD.	Recording on an MD is not possible unless there are successive spaces at least 2 seconds in length. For this reason, a shorter recording time will be displayed for an MD with a large number of short empty areas.

Restriction on Copying Digital Material

Due to copyright and other considerations, the following restriction is now in place for MDs onto which the digital signals of CDs have been copied.

SCMS (Serial Copy Management System)

MDs can digitally record the clear sound of CDs. However, it is now not possible to copy the digital signals of an MD recorded in this way onto another MD using another unit. In other words, copies of copies cannot be made. This restriction is known as SCMS (Serial Copy Management System).

This unit is designed to comply with this restriction.

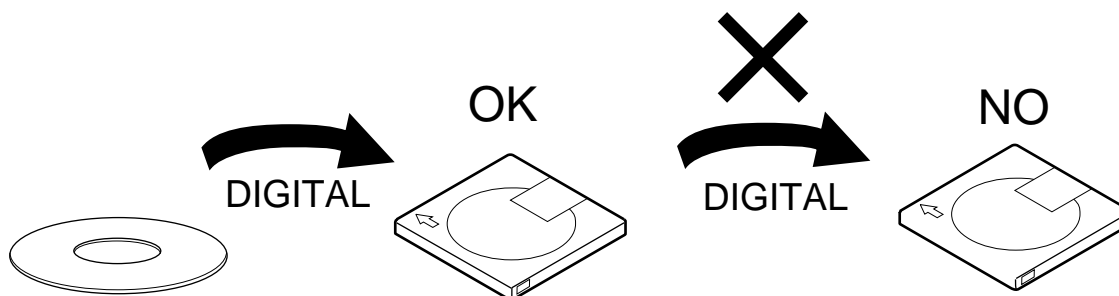

The copyright laws allow recordings to be made for the personal enjoyment of the individual user but they do not allow such recordings to be used for other any purposes without permission from the holder of the copyrights.

■ MDs on which CD sound has been recorded using this unit cannot be digitally copied by other units.

	Symptom	Cause	Remedial action/check	Ref.
COMMON	No sound.	• An MD with nothing recorded on it has been inserted. ("BLANK DISC" is displayed.)	• Replace the MD on which tracks have been recorded.	20
	The time display flashes in the display window.	• A power failure has occurred or the power cord has been disconnected.	• Set the clock and re-program the timer.	45-47
CD PLAYER	Play fails to start	• The CD has been inserted upside down.	• Insert it properly with the label side facing up.	12
		• Condensation has formed on the lens.	• Turn on the power and wait for a couple of hours.	
	Specific parts are not played properly.	• The CD is scratched.	• Replace the CD.	
MD RECORDER	The inserted MD is ejected.	• The MD was not inserted properly.	• Re-insert the MD by pushing it gently until it clicks into position.	20
	MD cannot be inserted.	• An MD has already been inserted.	• Press the ▲ button, eject the MD, and insert another MD.	21
	No recording.	• The MD is set to the accidental erasure prevention mode ("DISC PROTECTED" is displayed).	• Slide the accidental erasure prevention knob so that the hole is blocked.	27
TIMER	Timer fails to start.	• Present time is not correct.	• Set the time properly.	45
		• The timer display (⊖) fails to appear.	• Press the TIMER button so that the timer display (⊖) appears.	
REMOTE CONTROL	No remote control operations.	• The dry batteries in the remote control have discharged.	• Replace them with two fresh batteries (R03 or size "AAA" or UM4).	8
		• The remote control sensor is exposed to direct sunlight or some other intense source of light.	• Operate the remote control where it will not be exposed to direct sunlight, a lighting fixture or some other intense source of light.	9

• If the unit fails to operate properly even when the remedial action suggested above has been taken:

This unit uses a microcomputer to perform a large number of operations. If it fails to operate no matter which button is pressed, disconnect the power cord, and then wait a few moments before re-connecting it. Then set the time and re-program the timer.

- If something important is going to be recorded, always test-record first to check that the recording turns out properly before proceeding with the actual recording.
- The manufacturer assumes no liability whatsoever for any damages resulting from missed opportunities while conducting recording, playback or CD play operations due to malfunctioning of or trouble in the unit, or for any incidental damage.

Main Specifications

The unit's specifications and exterior are subject to change without notice due to improvements.

CD Player Section

System	Compact disc digital audio system
Readout system	Non-contact optical readout (using semiconductor laser)
Error correction system	CIRC
Number of channels	2
Pitch control	±12%
Total harmonic distortion (1 kHz)	0.009%
Dynamic range (1 kHz)	90 dB
Signal-to-noise ratio	94 dB
Frequency response	8Hz ~ 20 kHz
Wow and flutter	Less than measurable limit

MD Recorder Section

System	Mini-disc digital audio system
Recording system	Magnetic field modulation overwrite system
Signal readout system	Non-contact optical system using semiconductor laser ($\lambda = 780\text{nm}$)
Sound compression system	ATRAC system
Number of channels	2
Wow and flutter	Less than measurable limit
Sampling frequency	44.1 kHz
Frequency response	8 Hz ~ 20 kHz
Inputs: Analog (LINE IN)	Minimum input level: 300 mV (Full scale -12 dB)/50 k Ω
Digital (optical)	Input level: -23 dBm ~ -15 dBm
Microphone	Minimum input level: 3 mV (Full scale -12 dB)/600-10 k Ω matching impedance
Dynamic range (1 kHz)	88 dB (during play)
Signal-to-noise ratio	88 dB (during play)

Timer Section

Timer system	Once-a-day operation (ON/OFF timer)
Clock display	12-hour display

Common Specifications

Output connectors: Analog	LINE x 1 set, 2 V/5 k Ω (Full scale) Headphones x 1, 4 mW/32 Ω , 8 Ω - 1 k Ω matching impedance
Digital	OPTICAL x 1, -21 dBm ~ -15 dBm
Other connectors	COMPU LINK-3/SYNCHRO x 2 TEXT COMPU LINK x 2
Power requirements	AC 120 V (60 Hz)
Power consumption	15 W in power ON mode; 6 W in STANDBY mode
Dimensions	17-3/16" x 5 x 12-1/2" inches (W x H x D) (435 x 127 x 316 mm)
Mass	Approx. 13.3 lbs (6.0 kg)

Accessories

Remote control (RM-XU301U)	(1)
R03, size "AAA" or UM4 dry batteries (to check operation of remote control)	(2)
Pin cords	(2)
COMPU LINK-3 cable	(1)
TEXT COMPU LINK cable	(1)

- This unit is licensed under the U.S. and foreign patents of Dolby Laboratories Licensing Corporation.

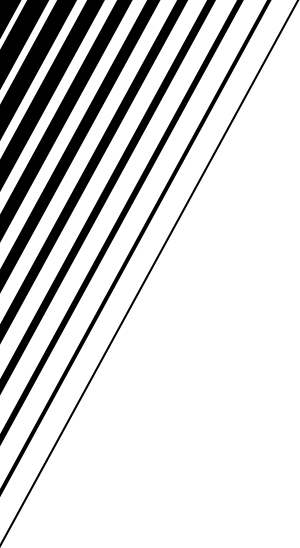

Free Manuals Download Website

<http://myh66.com>

<http://usermanuals.us>

<http://www.somanuals.com>

<http://www.4manuals.cc>

<http://www.manual-lib.com>

<http://www.404manual.com>

<http://www.luxmanual.com>

<http://aubethermostatmanual.com>

Golf course search by state

<http://golfingnear.com>

Email search by domain

<http://emailbydomain.com>

Auto manuals search

<http://auto.somanuals.com>

TV manuals search

<http://tv.somanuals.com>