

JVC



DVD DIGITAL CINEMA SYSTEM

TH-S3

Consists of XV-THS3, SP-WS3, and SP-THS3F

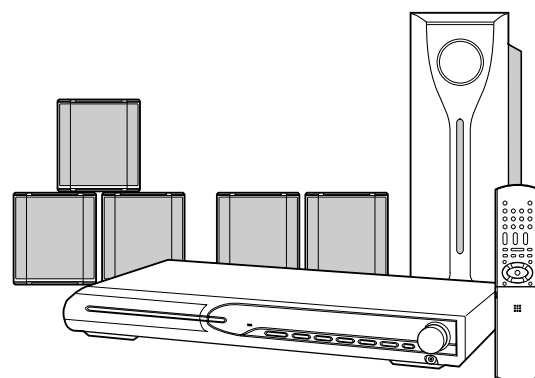

R-D-S



Digital Direct Progressive Scan

INSTRUCTIONS

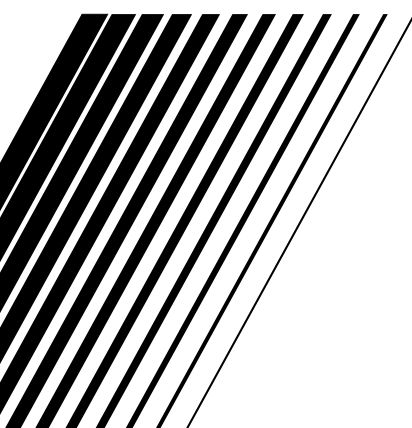

Warnings, Cautions and Others

IMPORTANT for the U.K.

DO NOT cut off the mains plug from this equipment. If the plug fitted is not suitable for the power points in your home or the cable is too short to reach a power point, then obtain an appropriate safety approved extension lead or consult your dealer.

BE SURE to replace the fuse only with an identical approved type, as originally fitted.

If nonetheless the mains plug is cut off ensure to remove the fuse and dispose of the plug immediately, to avoid a possible shock hazard by inadvertent connection to the mains supply.

If this product is not supplied fitted with a mains plug then follow the instructions given below:

IMPORTANT.

DO NOT make any connection to the terminal which is marked with the letter E or by the safety earth symbol or coloured green or green-and-yellow.

The wires in the mains lead on this product are coloured in accordance with the following code:

Blue: Neutral
Brown: Live

As these colours may not correspond with the coloured markings identifying the terminals in your plug proceed as follows:

The wire which is coloured blue must be connected to the terminal which is marked with the letter N or coloured black.

The wire which is coloured brown must be connected to the terminal which is marked with the letter L or coloured red.

IF IN DOUBT - CONSULT A COMPETENT ELECTRICIAN.

CAUTION

To reduce the risk of electrical shocks, fire, etc.:

1. Do not remove screws, covers or cabinet.
2. Do not expose this appliance to rain or moisture.

CAUTION— ϕ /I button! (XV-THS3)

Disconnect the mains plug to shut the power off completely (the STANDBY lamp goes off).

The ϕ /I button in any position does not disconnect the mains line.

- When the system is on standby, the STANDBY lamp lights red.
- When the system is turned on, the STANDBY lamp goes off. The power can be remote controlled.

CAUTION

- Do not block the ventilation openings or holes. (If the ventilation openings or holes are blocked by a newspaper or cloth, etc., the heat may not be able to get out.)
- Do not place any naked flame sources, such as lighted candles, on the apparatus.
- When discarding batteries, environmental problems must be considered and local rules or laws governing the disposal of these batteries must be followed strictly.
- Do not expose this apparatus to rain, moisture, dripping or splashing and that no objects filled with liquids, such as vases, shall be placed on the apparatus.

IMPORTANT FOR LASER PRODUCTS

1. CLASS 1 LASER PRODUCT
2. **CAUTION:** Do not open the top cover. There are no user serviceable parts inside the unit; leave all servicing to qualified service personnel.
3. **CAUTION:** Visible and invisible laser radiation when open and interlock failed or defeated. Avoid direct exposure to beam.
4. REPRODUCTION OF LABEL: CAUTION LABEL, PLACED INSIDE THE UNIT.

CAUTION : Visible and invisible laser radiation when open and interlock failed or defeated. AVOID DIRECT EXPOSURE TO BEAM. (e)	ADVARSEL : Synlig og usynlig laserstråling når maskinen er åben eller interlocken fejler. Undgå direkte eksponering til stråling. (d)	VARNING : Synlig och osynlig laserstrålning när den öppnas och spärren är urkopplad. Betrakta ej strålen. (s)	VARO : Avattaessa ja suojalukitus ohitettuna tai viallisena olet alttiina näkyvälle ja näkymättömälle lasersäteilylle. Vältä säteen kohdistumista suoraan itseesi. (f)
---	--	--	---

Caution: Proper Ventilation

To avoid risk of electric shock and fire and to protect from damage, place the apparatus on a level surface. The minimal clearances are shown below:

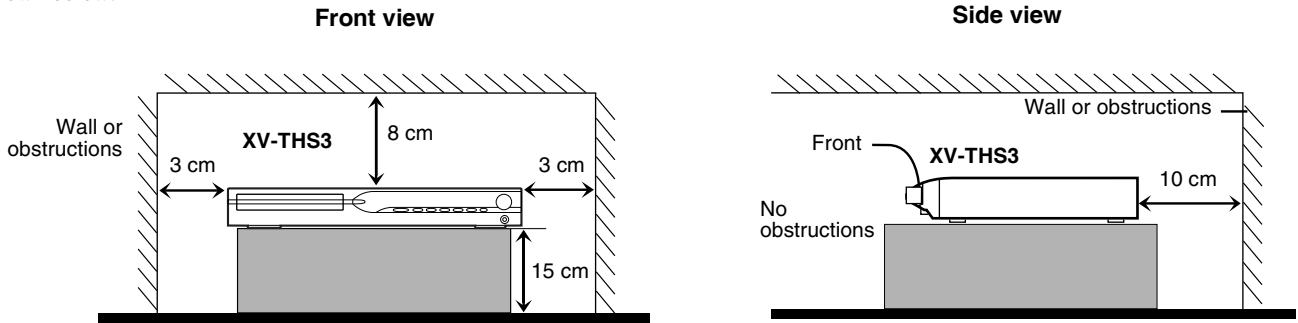

SAFETY INSTRUCTIONS

“SOME DOS AND DON'TS ON THE SAFE USE OF EQUIPMENT”

This equipment has been designed and manufactured to meet international safety standards but, like any electrical equipment, care must be taken if you are to obtain the best results and safety is to be assured.

Do read the operating instructions before you attempt to use the equipment.

Do ensure that all electrical connections (including the mains plug, extension leads and interconnections between pieces of equipment) are properly made and in accordance with the manufacturer's instructions. Switch off and withdraw the mains plug when making or changing connections.

Do consult your dealer if you are ever in doubt about the installation, operation or safety of your equipment.

Do be careful with glass panels or doors on equipment.

DON'T continue to operate the equipment if you are in any doubt about it working normally, or if it is damaged in any way — switch off, withdraw the mains plug and consult your dealer.

DON'T remove any fixed cover as this may expose dangerous voltages.

DON'T leave equipment switched on when it is unattended unless it is specifically stated that it is designed for unattended operation or has a standby mode.

Switch off using the switch on the equipment and make sure that your family know how to do this. Special arrangements may need to be made for infirm or handicapped people.

DON'T use equipment such as personal stereos or radios so that you are distracted from the requirements of traffic safety. It is illegal to watch television whilst driving.

DON'T listen to headphones at high volume as such use can permanently damage your hearing.

DON'T obstruct the ventilation of the equipment, for example with curtains or soft furnishings. Overheating will cause damage and shorten the life of the equipment.

DON'T use makeshift stands and NEVER fix legs with wood screws — to ensure complete safety always fit the manufacturer's approved stand or legs with the fixings provided according to the instructions.

DON'T allow electrical equipment to be exposed to rain or moisture.

ABOVE ALL

—NEVER let anyone, especially children, push anything into holes, slots or any other opening in the case — this could result in a fatal electrical shock.;

—NEVER guess or take chances with electrical equipment of any kind — it is better to be safe than sorry!

E43486-340B

Table of contents

Introduction 2

Notes on handling	2
Supplied accessories	2

About discs 3

Playable disc types	3
---------------------------	---

Index of parts and controls 5

Connections 7

Connecting the FM and AM (MW) antennas	7
Connecting the satellite (front, center, surround) speakers and the subwoofer	8
Speaker layout	9
Connecting a TV	9
Connecting to an analog component	10
Connecting to a digital component	10
Connecting the power cord	10

Operating external components with the remote control 11

Operating the TV	11
Operating the VCR	12

Basic operations 13

Turning the system on/off	13
Selecting the source to play	14
Adjusting the volume [VOLUME]	14
Listening with headphones (not supplied)	14
Turning off the sound temporarily [MUTING]	14
Adjusting the brightness of the indications [DIMMER]	14
Sleep Timer [SLEEP]	15
Adjusting the output level of the subwoofer and center/surround speakers [S.WFR, CENTER, L-SURR.-R]	15
Adjusting the treble sound [TREBLE]	15
Changing the scan mode	15

Playback 16

Basic playback	16
One Touch Replay	18
Fast-forward/fast-reverse search	18
Skip to the beginning of a desired selection	18
Locating a desired title/group using number buttons	19
Playing back a bonus group	19

Advanced operations 20

Using the surround mode	20
Using the on-screen bar	21
Playing from a specified position on a disc	23
Using the file control display	24
Resume Playback	25
Selecting a view angle	25
Selecting the subtitle	25
Selecting the audio	26
Special picture playback	26
Program Playback	28
Random Playback	28
Repeat Playback	29
Tray lock	30
Sound and other settings	30

Setting DVD preferences 31

Using the setup menus	31
Menu description	31

Tuner operations 35

Manual tuning	35
Preset tuning	35
Selecting the FM reception mode	36
Using the RDS (Radio Data System) when receiving FM stations	36

References 39

Maintenance	39
Troubleshooting	39
Specifications	40

Notes on handling

■ Important cautions

Installation of the system

- Select a place which is level, dry and neither too hot nor too cold; between 5°C and 35°C.
- Leave sufficient distance between the system and the TV.
- Do not use the system in a place subject to vibration.

Power cord

- Do not handle the power cord with wet hands!
- A small amount of power is always consumed while the power cord is connected to the wall outlet.
- When unplugging the power cord from the wall outlet, always pull on the plug, not the power cord.

To prevent malfunctions of the system

- There are no user-serviceable parts inside. If anything goes wrong, unplug the power cord and consult your dealer.
- Do not insert any metallic object into the system.
- Do not use any non-standard shape disc (like a heart, flower or credit card, etc.) available on the market, because it may damage the system.
- Do not use a disc with tape, stickers, or paste on it, because it may damage the system.

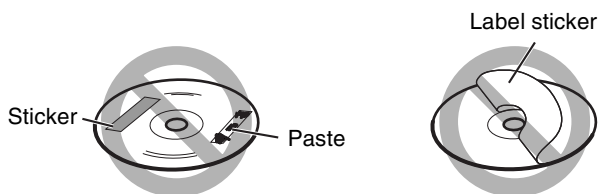

Note about copyright laws

Check the copyright laws in your country before recording from the discs. Recording of copyrighted material may infringe copyright laws.

Note about copyguard system

The discs are protected by copyguard system. When you connect the system to your VCR directly, the copyguard system activates and the picture may not be played back correctly.

■ Safety precautions

Avoid moisture, water and dust

Do not place the system in moist or dusty places.

Avoid high temperatures

Do not expose the system to direct sunlight and do not place it near a heating device.

When you are away

When away on travel or for other reasons for an extended period of time, disconnect the power cord plug from the wall outlet.

Do not block the vents

Blocking the vents may damage the system.

Care of the cabinet

When cleaning the system, use a soft cloth and follow the relevant instructions on the use of chemically-coated cloths. Do not use benzene, thinner or other organic solvents including disinfectants. These may cause deformation or discoloring.

If water gets inside the system

Turn the system off and disconnect the power cord plug from the wall outlet, then call the store where you made your purchase. Using the system in this condition may cause fire or electrical shock.

Supplied accessories

Check to be sure you have all of the supplied accessories. The number in parentheses is the quantity of the pieces supplied. If anything is missing, contact your dealer immediately.

- Remote control (1)
- Batteries (2)
- FM antenna (1)
- AM loop antenna (1)

About discs

Playable disc types

This system has been designed to play back the following discs: DVD VIDEO, DVD AUDIO, Video CD (VCD), Super Video CD (SVCD), Audio CD (CD), CD-R and CD-RW.

- This system accommodates the PAL system, and also can play discs recorded with NTSC system. Note that an NTSC video signal on a disc is converted to the PAL60 signal and output.
- This system can also play finalized DVD-R/-RWs recorded in DVD VIDEO format. However, some discs may not be played because of their disc characteristics or recording conditions.

Discs you can play:

<p>DVD VIDEO</p> 	<p>Audio CD</p> 
<p>DVD AUDIO</p> 	<p>CD-R</p> 
<p>VCD</p> 	<p>CD-RW</p> 
<p>SVCD</p> 	

- The following discs cannot be played back: DVD-ROM, DVD-RAM, CD-ROM, CD-I (CD-I Ready), Photo CD, SACD, etc. Playing back these discs will generate noise and damage the speakers.
- **On some DVD VIDEOS, DVD AUDIOS, VCDs or SVCDs, their actual operation may be different from what is explained in this manual. This is due to the disc programming and disc structure, not a malfunction of this system.**

DVD Logo is a trademark of DVD Format/Logo Licensing Corporation.

Region code of DVD VIDEO

DVD VIDEO players and DVD VIDEO discs have their own Region Code numbers. This system can play back DVD VIDEO discs whose Region Code numbers include the system's Region Code, which is indicated on the rear panel.

Example of playable DVD:



If a DVD with an improper Region Code number is loaded, "REGION CODE ERROR!" appears on the TV screen and playback cannot start.

About files (tracks) and folders (groups) on the disc

This system can also play MP3, WMA, JPEG and MPEG4 files recorded on CD-Rs and CD-RWs.

Files are sometimes grouped into folders on CD-Rs or CD-RWs by genre, album, etc.

In this manual, "group" is also referred to as "folder", and "track" as "file".

- This system recognizes up to 150 files per group, and 99 groups per disc. The total number of files this system can detect on a disc is up to 1000.

About discs

Notes on CD-R and CD-RW

- User-edited CD-Rs (Recordable) and CD-RWs (Rewritable) can be played back only if they are already “finalized”.
- When making your own disc, select ISO 9660 Level 1 or Level 2 for the disc format.
- This system supports “multi-session” discs (up to 20 sessions).
- This system cannot play “packet write” discs.
- Before playing CD-Rs or CD-RWs, read their instructions or cautions carefully.
- CD-RWs may require a longer readout time. This is caused by the fact that the reflectance of CD-RWs is lower than that of regular CDs.
- Some discs may not be played due to their disc characteristics, recording conditions, or damage or stain on them.
- This system can play CD-Rs or CD-RWs recorded in the audio CD format.

This system can also play CD-Rs or CD-RWs if MP3/WMA/JPEG/MPEG4 files are recorded on them.

Especially, the configuration and characteristics of an MP3/WMA/JPEG/MPEG4 disc are determined by the writing (encoding) software and hardware used for recording. Therefore, due to the software and hardware used, the following symptoms may occur:

- Some tracks/files on an MP3/WMA/JPEG/MPEG4 disc may be skipped or may not be played normally.
- Some files on a JPEG/MPEG4 disc may be played distortedly.

Notes on MP3/WMA/JPEG/MPEG4 discs

- MP3/WMA/JPEG/MPEG4 discs (either CD-R or CD-RW) require a longer readout time. (It differs due to the complexity of the directory/file configuration.)
- The system can only recognize files with one of the following extensions, which can be in any combination of upper and lower case:
 - MP3: “.MP3”, “.mp3”
 - WMA: “.WMA”, “.wma”
 - JPEG: “.JPG”, “.JPEG”, “.jpg”, “.jpeg”
 - MPEG4: “.ASF”, “.asf”
- If different kinds of the file are mixed on a disc, set the FILE TYPE setting in the PICTURE menu to the appropriate setting for the data to be read (“AUDIO”, “STILL PICTURE”, or “VIDEO”). (See page 32.)

Notes on MP3/WMA files

- Tag information (album name, artist name, and track name) can be shown on the TV. (See page 24.)
- The system can play back the MP3/WMA files recorded at 32 kbps to 320 kbps as a bit rate, and at 16 kHz, 22.05 kHz, (24 kHz for MP3 only) 32 kHz, 44.1 kHz, 48 kHz as a sampling frequency.
- We recommend to record each piece of material (song) at a sample rate of 44.1 kHz and at a data transfer rate of 128 kbps for MP3 files or 96 kbps for WMA files.

Notes on JPEG files

- We recommend to record a file at 640 x 480 resolution. (If a file has been recorded at a resolution of more than 640 x 480, it will take a longer time to be displayed.)
- This system can only play baseline JPEG files.

Notes on MPEG4 files

- The system can play back the MPEG4 files followed the conditions below:

File format: ASF

Visual profile: MPEG4 SP (Simple Profile)

Audio CODEC: G.726

Max. picture size: 352 x 288 (CIF)

Max. bit rate: 384 kbps

This product incorporates copyright protection technology that is protected by method claims of certain U.S. patents and other intellectual property rights owned by Macrovision Corporation and other rights owners. Use of this copyright protection technology must be authorized by Macrovision Corporation, and is intended for home and other limited viewing uses only unless otherwise authorized by Macrovision Corporation. Reverse engineering or disassembly is prohibited.

“CONSUMERS SHOULD NOTE THAT NOT ALL HIGH DEFINITION TELEVISION SETS ARE FULLY COMPATIBLE WITH THIS PRODUCT AND MAY CAUSE ARTIFACTS TO BE DISPLAYED IN THE PICTURE. IN CASE OF 525 OR 625 PROGRESSIVE SCAN PICTURE PROBLEMS, IT IS RECOMMENDED THAT THE USER SWITCH THE CONNECTION TO THE ‘STANDARD DEFINITION’ OUTPUT. IF THERE ARE QUESTIONS REGARDING OUR TV SET COMPATIBILITY WITH THIS MODEL 525p AND 625p DVD PLAYER, PLEASE CONTACT OUR CUSTOMER SERVICE CENTER.”

USE OF THIS PRODUCT IN ANY MANNER THAT COMPLIES WITH THE MPEG-4 VISUAL STANDARD IS PROHIBITED, EXCEPT FOR USE BY A CONSUMER ENGAGING IN PERSONAL AND NON-COMMERCIAL ACTIVITIES.

Index of parts and controls

The numbers in the figures indicate the pages where the details of the parts are described.

Front panel (center unit)

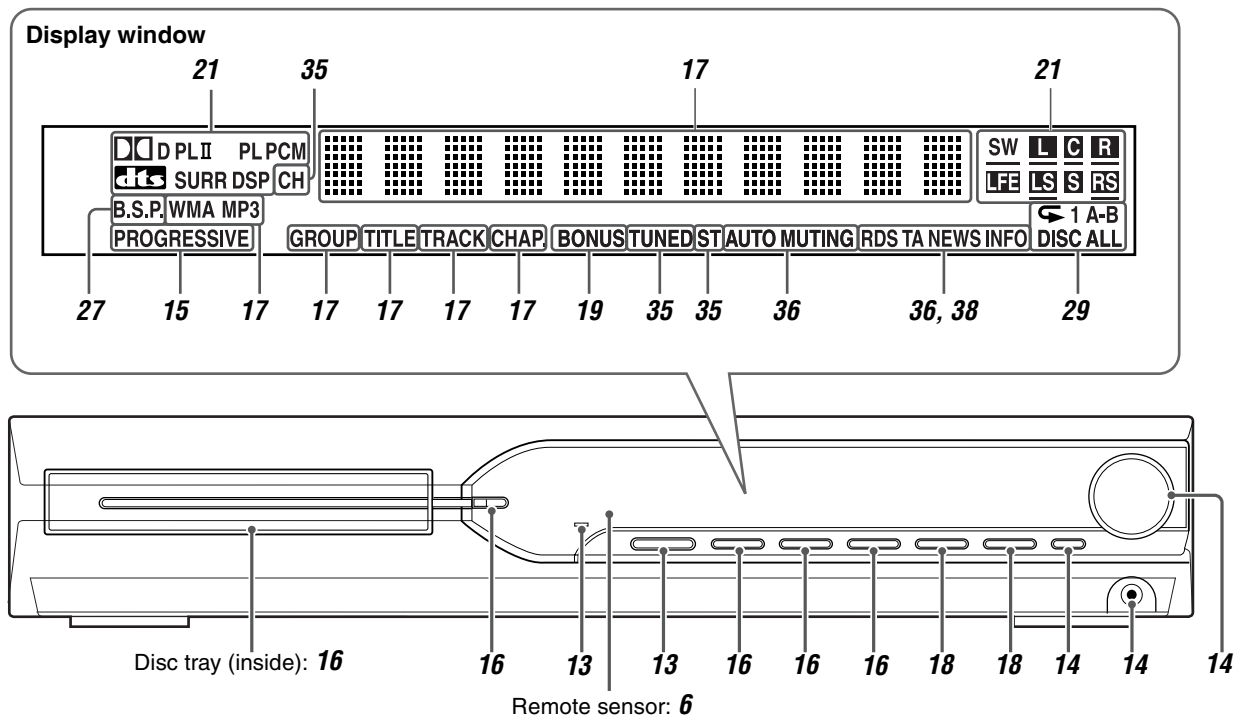

Rear panel (center unit)

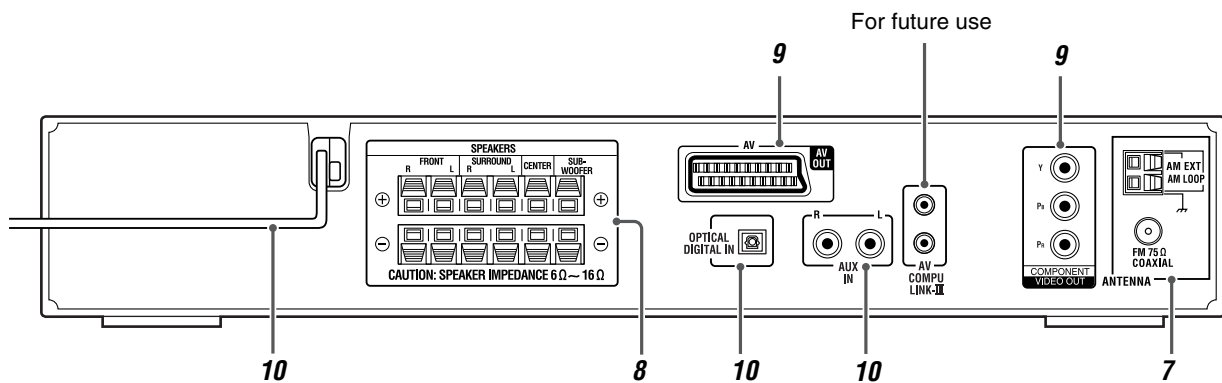

Remote control

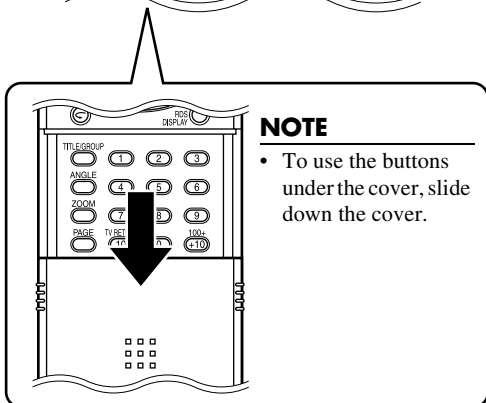
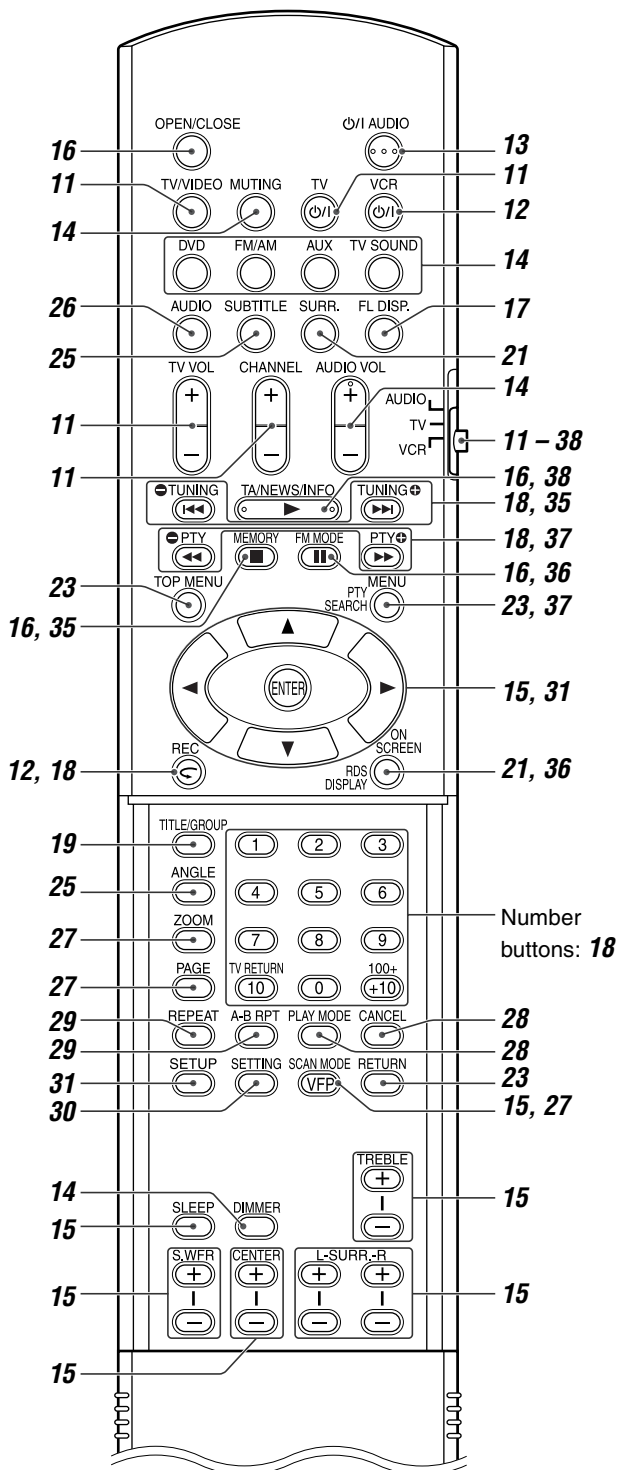

NOTE

- To use the buttons under the cover, slide down the cover.

Putting batteries in the remote control

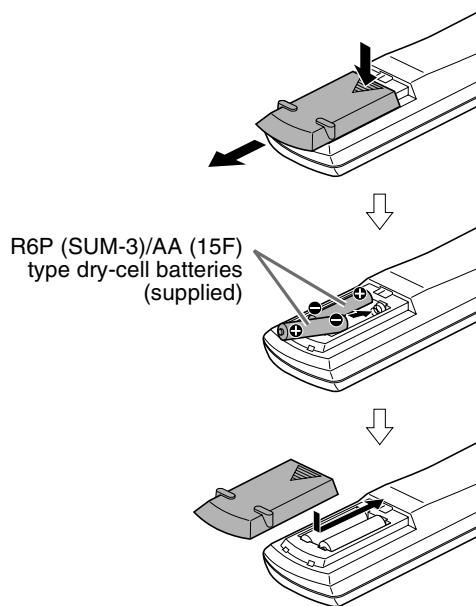

If the range or effectiveness of the remote control decreases, replace both batteries.

CAUTION

- Do not expose batteries to heat or flame.

Operating the system from the remote control

Aim the remote control directly to the front panel of the center unit.

- Do not hide the remote sensor.

Connecting the FM and AM (MW) antennas

■ AM (MW) loop antenna

Setting up supplied AM (MW) loop antenna

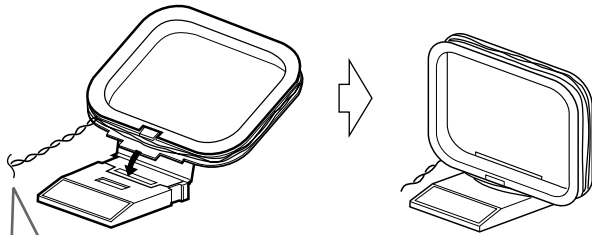

If the antenna cord is covered with the insulation coat, twist and pull the insulation coat off and remove.

Connecting AM (MW) loop antenna

1

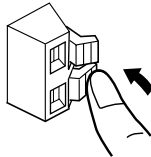

2

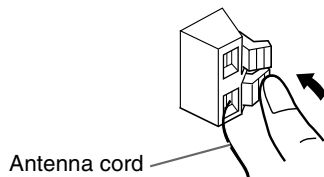

3

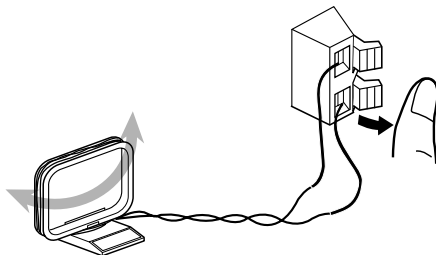

- Turn the loop antenna until you have the best reception during AM (MW) broadcast program reception.

NOTE

- Make sure the antenna conductors do not touch any other terminals, connecting cords and power cords. This could cause poor reception.

If reception is poor

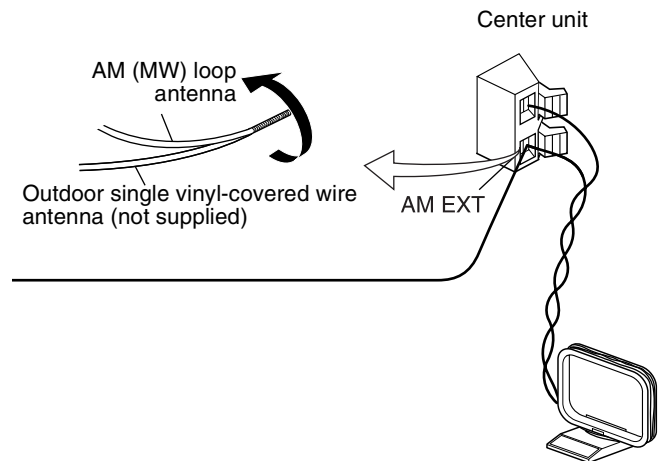

■ FM antenna

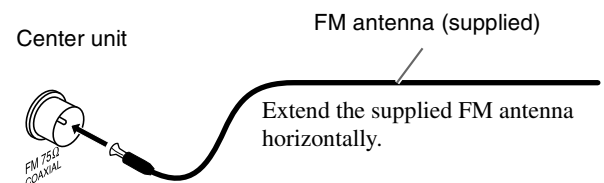

If reception is poor

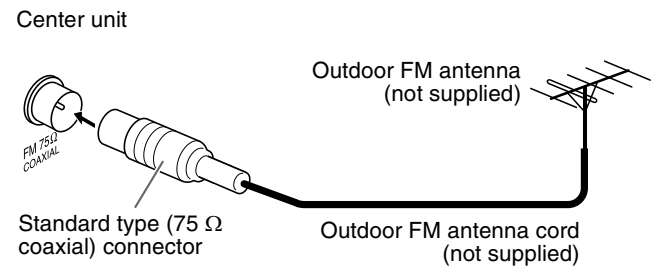

NOTE

- We recommend that you use coaxial cable for the FM antenna as it is well-shielded against interference.

Connecting the satellite (front, center, surround) speakers and the subwoofer

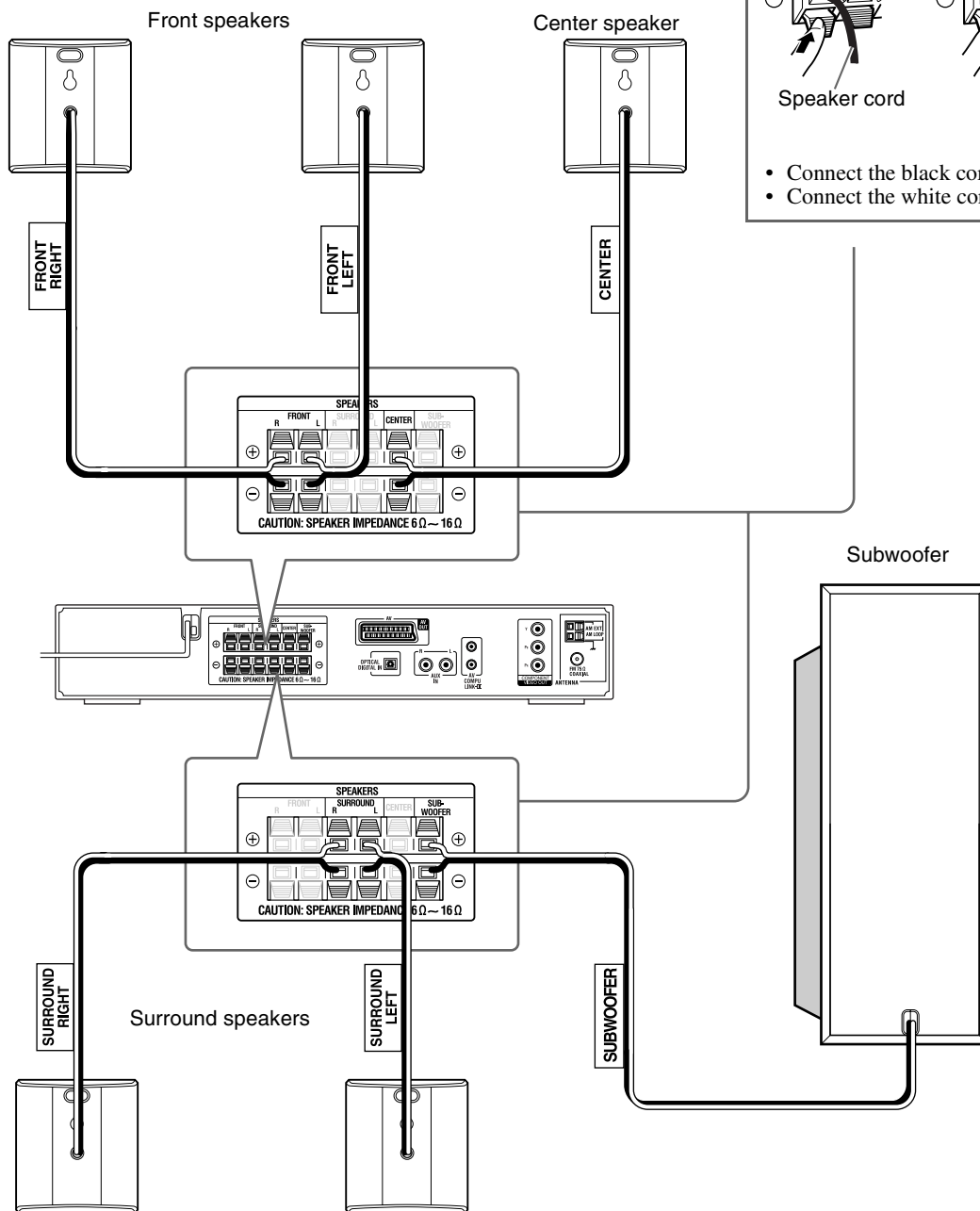

- Connect the black cords to the black (-) terminals.
- Connect the white cords to the red (+) terminals.

CAUTION

- When you connect speakers other than the supplied ones, use speakers of the same speaker impedance (SPEAKER IMPEDANCE) indicated on the rear of the center unit.
- DO NOT connect more than one speaker to one speaker terminal.

- When installing the satellite speakers on the wall;
 - Be sure to have them installed on the wall by a qualified personnel. DO NOT install the satellite speakers on the wall by yourself to avoid unexpected damage from their falling off the wall due to incorrect installation or weakness in wall structure.
 - Care must be taken in selecting a location for speaker installation on a wall. Injury to personnel or damage to equipment may result if the speakers installed interfere with daily activities.

Speaker layout

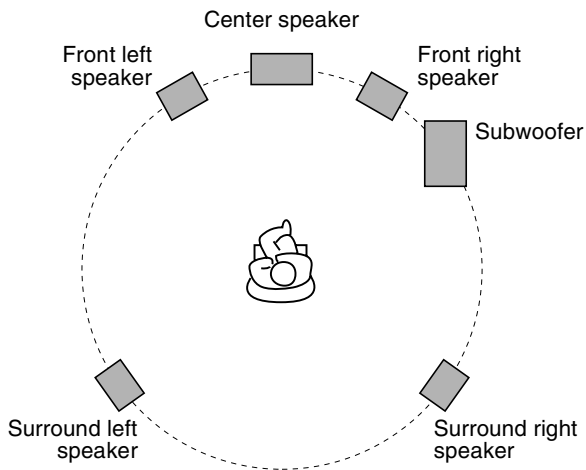

NOTE

- Although the satellite speakers and the subwoofer are magnetically shielded, the TV screen may appear mottled. In this case, keep enough distance between the speakers and the TV.
- The speakers are magnetically shielded to avoid color distortions on TVs. However, if not installed properly, it may cause color distortions. So, pay attention to the following when installing the speakers.
 - When placing the speakers near a TV set, turn off the TV's main power switch or unplug it before installing the speakers. Then wait at least 30 minutes before turning on the TV's main power switch again.
- Some TVs may still be affected even though you have followed the above. If this happens, move the speakers away from the TV.
- Place the satellite speakers on a flat and level surface.
- Be sure to place the subwoofer to the TV's right. If you place the subwoofer to the TV's left, keep sufficient distance between them to prevent the TV screen from appearing mottled.

Connecting a TV

- Distortion of picture may occur when connecting the TV via a VCR, or to a TV with a built-in VCR.
- You need to set "MONITOR TYPE" in the PICTURE menu correctly according to the aspect ratio of your TV. (See page 32.)

■ To connect a TV equipped with the component video input jacks

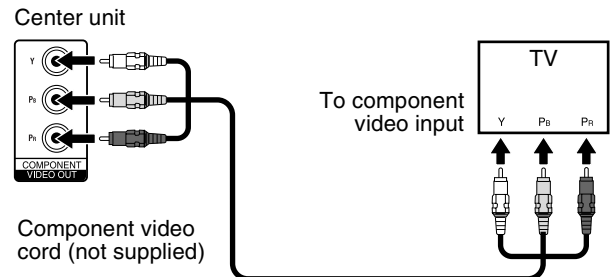

NOTE

- You need to set the scanning mode to "Y/C COMP." or "PROGRESSIVE" depending on the method to connect to your TV. (See page 15.)
- If your TV supports progressive video input, you can enjoy a high quality picture by setting the progressive scan mode to active. (See page 15.)
- If the component video input jacks of your TV are of the BNC type, use a plug adapter (not supplied) to convert the pin plugs to BNC plugs.
- The component video signals can be output only when you select "DVD" as the source to play. (See page 14.)

■ To connect a TV with the SCART connector

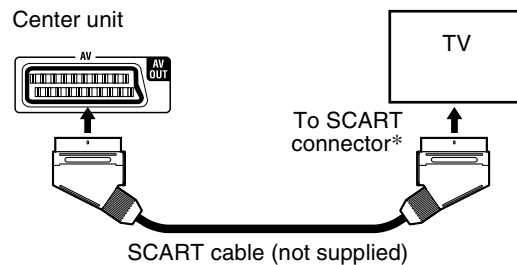

- * Some TV's SCART connectors output audio signal. In such a case, you can enjoy the TV sound through this system.

NOTE

- No sound signal comes out from "AV" (SCART) connector.
- Select the appropriate scan mode according to your TV. (See page 15.)

Connecting to an analog component

You can enjoy the sound of an analog component.

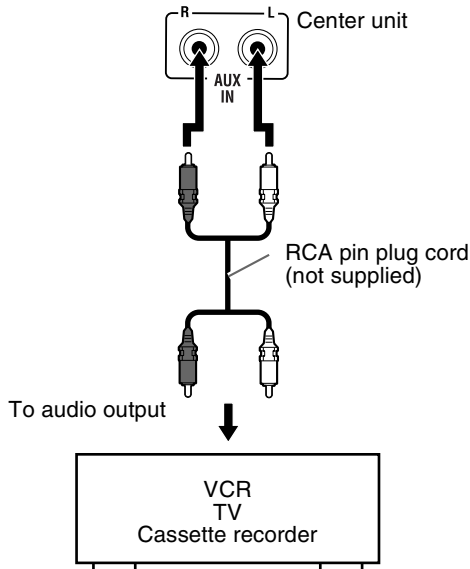

NOTE

- If you connect a sound-enhancing device such as a graphic equalizer between the source components and this system, the sound output through this system may be distorted.
- When playing a video component such as a VCR;
 - To listen to the sound, select "AUX" as the source to play. (See page 14.)
 - To see the picture, connect the video output jack of the component to the video input jack of the TV directly, and select the correct input mode on the TV.

Connecting to a digital component

You can enjoy the sound of a digital component.

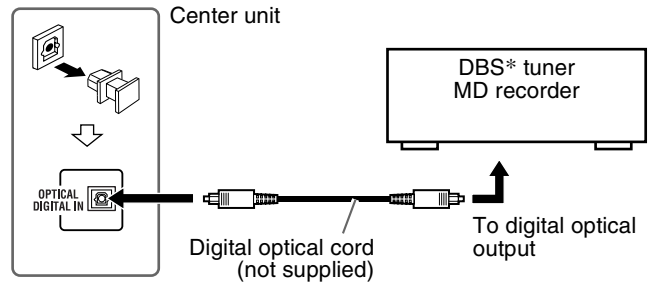

* DBS = Direct Broadcasting Satellite

NOTE

When playing a video component such as a DBS tuner;

- To listen to the sound, select "AUX DIGITAL" as the source to play. (See page 14.)
- To see the picture, connect the video output jack of the component to the video input jack of the TV directly, and select the correct input mode on the TV.

Connecting the power cord

Make sure that all other connections have been completed.

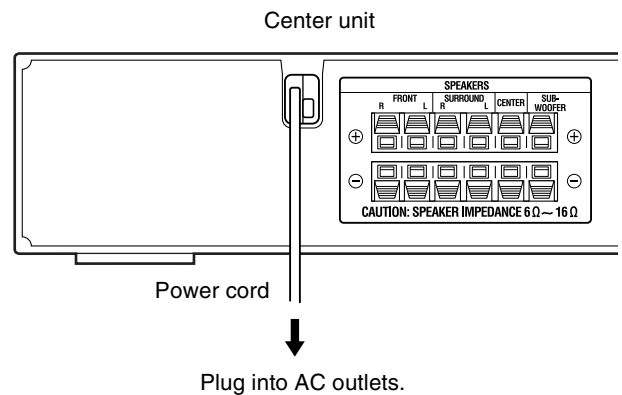

CAUTION

- Disconnect the power cord before cleaning or moving the system.
- Do not pull on the power cord to unplug the cord. When unplugging the cord, always grasp and pull the plug so as not to damage the cord.

NOTE

- Preset settings, such as preset stations and surround mode adjustment, may be erased in a few days in the following cases;
 - If you unplug the power cord of the center unit.
 - If a power failure occurs.

Operating external components with the remote control

The buttons described below are used on pages 11 and 12.

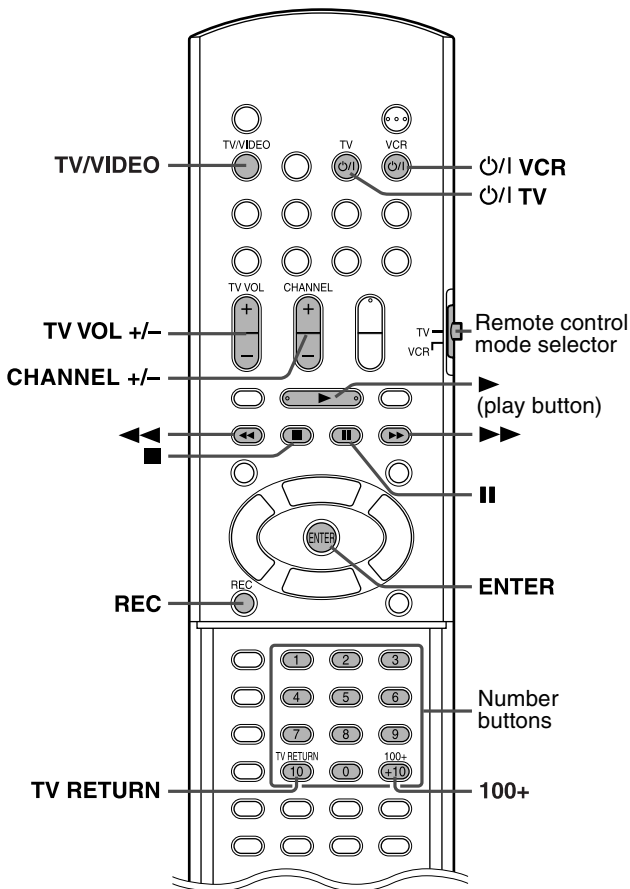

NOTE

- Manufacturers' codes are subject to change without notice.
- Set the codes again after replacing the batteries of the remote control.

Operating the TV

■ To set the manufacturer's code

You can operate a JVC TV without setting the manufacturer's code.

- 1 Slide the remote control mode selector to TV.**
- 2 Press and hold P/O TV.**
Keep the button pressed until step 4 is finished.
- 3 Press ENTER.**

4 Press number buttons (1-9, 0) to enter the manufacturer's code (2 digits).

Examples:

For a Hitachi TV:

Press 0, then 7.

For a Toshiba TV:

Press 2, then 9.

Manufacturer	Code	Manufacturer	Code
JVC	01	Nordmende	13, 14, 18, 26 – 28
Akai	02, 05	Okano	09
Blaupunkt	03	Orion	15
Daewoo	10, 31, 32	Panasonic	16, 17
Fenner	04, 31, 32	Philips	10
Fisher	05	Saba	13, 14, 18, 26 – 28
Grundig	06	Samsung	10, 19, 32
Hitachi	07, 08	Sanyo	05
Inno-Hit	09	Schneider	02, 05
Irradio	02, 05	Sharp	20
Magnavox	10	Sony	21 – 25
Mitsubishi	11, 33	Telefunken	13, 14, 18, 26 – 28
Miver	03	Thomson	13, 14, 18, 26 – 28, 30
Nokia	12, 34	Toshiba	29

5 Release P/O TV.

If there is more than one code listed for corresponding brand, try each one until you enter the correct one.

■ Operation

Aim the remote control at the TV.

IMPORTANT

Before using the remote control to operate a TV;

- Set the remote control mode selector to TV.

The following buttons are available:

P/O TV: Turns TV on and off.

TV VOL +/-: Adjusts the volume.

TV/VIDEO: Selects the input mode (either TV or VIDEO).

CHANNEL +/-: Changes the channels.

1-10, 0, +10 (100+): Selects the channel.

TV RETURN: Alternates between the previously selected channel and the current channel.

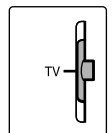

Operating the VCR

■ To set the manufacturer's code

- 1** Slide the remote control mode selector to VCR.
- 2** Press and hold  VCR.
Keep the button pressed until step 4 is finished.
- 3** Press ENTER.
- 4** Press number buttons (1-9, 0) to enter the manufacturer's code (2 digits).

Examples:
 For a Panasonic VCR:
 Press 2, then 1.
 For an Philips VCR:
 Press 0, then 5.

Manufacturer	Code	Manufacturer	Code
JVC	01	Nokia	16
Aiwa	02, 20	Nordmende	17 – 19, 31
Bell+Howell	03, 16	Orion	20
Blaupunkt	04	Panasonic	21
CGM	03, 05, 16	Philips	05, 22
Daewoo	34	Phonola	05
Digital	05	Saba	17 – 19, 23, 31
Fisher	03, 16	Samsung	24, 25
G.E.	06	Sanyo	03, 16
Grundig	07	Sharp	26, 27
Hitachi	08, 09	Siemens	07
Loewe	05, 10, 11	Sony	28 – 30, 35
Magnavox	04, 05	Telefunken	17 – 19, 31, 32
Mitsubishi	12 – 15	Toshiba	33

5 Release  VCR.

If there is more than one code listed for your brand, try each one until you enter the correct one.

■ Operation

Aim the remote control at the VCR.

IMPORTANT

Before using the remote control to operate a VCR; Set the remote control mode selector to VCR.

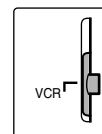

The following buttons are available:

 VCR: Turns VCR on and off.



 (play button): Starts playback.

■: Stops operation.

||: Pauses playback.

▶▶: Fast forwards video tape.

◀◀: Rewinds video tape.

REC: Press this button together with  (play button) to start recording or together with  to pause recording.

CHANNEL +/-: Changes the TV channels on the VCR.

Basic operations

The buttons on the remote control are used to explain most of the operations in this manual. You can use the buttons on the center unit same as on the remote control for operations unless otherwise noted.

IMPORTANT

Before using the remote control for the following operation,

- Set the remote control mode selector to AUDIO.

The buttons described below are used on pages 13 to 15.

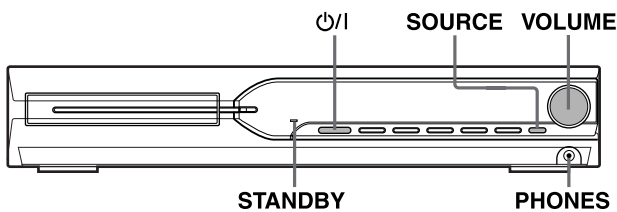
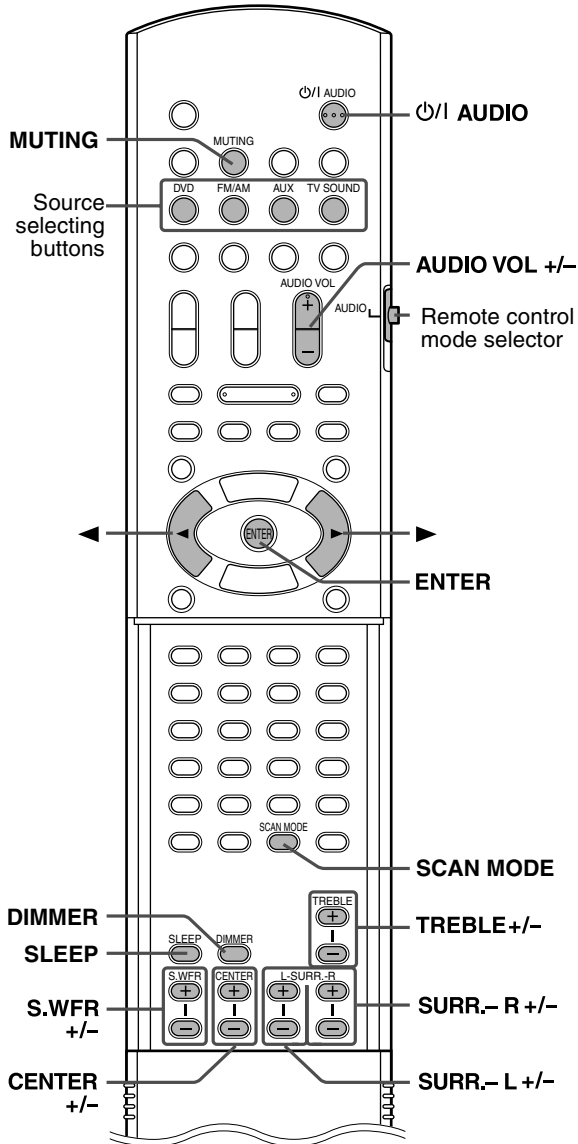
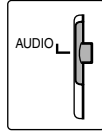

Turning the system on/off

On the remote control:

Press AUDIO.

On the center unit:

Press .

When DVD is selected as the source (see page 14), the following messages will appear on the TV screen.

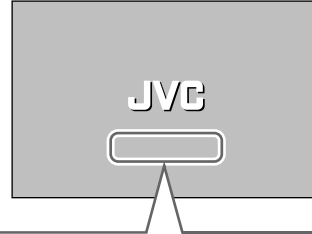

- "OPEN"/"CLOSE":
Appears when opening or closing the disc tray.
- "NOW READING":
Appears when the system is reading the disc information.
- "REGION CODE ERROR!":
Appears when the Region Code of the DVD VIDEO does not match the code the system supports. The disc cannot be played back.
- "NO DISC":
Appears when no disc is loaded.
- "CANNOT PLAY THIS DISC":
Appears when unplayable disc is loaded.

NOTE

- The STANDBY lamp goes off when the power is turned on, and the lamp lights when the power is turned off.
- A small amount of the power is consumed even when the power is turned off. This is called standby mode and the STANDBY lamp lights in this mode. Unplug the power cord from the AC outlet to turn the power off completely.
- You can also turn on the system by pressing the following buttons;
 - OPEN/CLOSE on the remote control or on the center unit
 - One of the source selecting buttons on the remote control
 - on the center unit. You can use the same buttons on the remote control except after pressing FM/AM.

Selecting the source to play

On the remote control:

Press one of the source selecting buttons (DVD, FM/AM, AUX or TV SOUND).

DVD: To play back a disc (DVD VIDEO, VCD etc.). (See page 16.)

FM/AM: To tune in an FM or AM (MW) station. (See page 35.)

Each time you press the button, the band alternates between FM and AM (MW).

AUX: To select the source from a component connected to the AUX IN jacks or DIGITAL IN jack. (See page 10.)

Each time you press the button, the source alternates between "AUX" and "AUX DIGITAL".

TV SOUND: To select the TV (that outputs sound signals) connected to the AV (SCART) connector. (See page 9.)

On the center unit:

Press SOURCE repeatedly until the source name you want appears on the display window.

NOTE

- When a source except DVD is selected, this system does not output video signals.
- It may take time to change the source.

Adjusting the volume [VOLUME]

CAUTION

- Always set the volume to minimum level before starting any source. If the volume is set at its high level, the sudden blast of sound could permanently damage your hearing and/or blow out the speakers.

On the remote control:

Press **AUDIO VOL +** or **-**.

On the center unit:

Turn **VOLUME**.

Listening with headphones (not supplied)

CAUTION

Be sure to turn down the volume;

- Before connecting or putting on headphones as high volume may damage both the headphones and your hearing.
- Before disconnecting headphones as high volume may be suddenly output from the speakers.

While connecting a pair of headphones to the PHONES jack on the center unit, the system automatically cancels the surround mode (see page 20) currently selected, deactivates the speakers, and activates the headphone mode. "HEADPHONE" appears on the display window.

Headphone mode

When using the headphones, the following signals are output regardless of your speaker setting;

- For 2 channel sources, the front left and right channel signals are output from the headphones.
- Multi-channel signals are down-mixed and output from the headphones.
- (DVD AUDIO) When the disc prohibits down-mixing, only the front left and right channels are output from the headphones. In this case, "L/R ONLY" appears on the display window for a few seconds.

Turning off the sound temporarily [MUTING]

Press **MUTING**.

To restore the sound

Perform one on the following:

- Press **MUTING** again.
- Press **AUDIO VOL +/-** (or turn **VOLUME** on the center unit).

Adjusting the brightness of the indications [DIMMER]

Press **DIMMER**.

Each time you press the button, the brightness level changes.

Sleep Timer [SLEEP]

The system turns off automatically when the specified period of time has passed.

Press SLEEP.

Each time you press the button, the shut-off time changes.

Example:



To check the remaining time

Press SLEEP once.

To change the remaining time

Press SLEEP repeatedly.

To cancel

Press SLEEP repeatedly until "SLEEP OFF" appears.

- Turning off the power also cancels the Sleep Timer.

Adjusting the output level of the subwoofer and center/surround speakers [S.WFR, CENTER, L-SURR.-R]

Press S.WFR +/- to adjust the subwoofer.

Press CENTER +/- to adjust the center speaker.

Press SURR.-L +/- to adjust the surround left speaker.

Press SURR.-R +/- to adjust the surround right speaker.

NOTE

- You can also make adjustments by using the setup menu shown on the TV screen. (See page 32.)
- The adjustments take effect for all sources.
- You cannot make this adjustment when FM or AM is selected as the source.

Adjusting the treble sound [TREBLE]

Press TREBLE +/-.

NOTE

- The adjustments take effect for all sources.

Changing the scan mode

The system can be accommodated to your TV's scan mode.

- To use the system in progressive mode, it is required that the center unit is connected to the TV using a component video cord (not supplied) in advance. (See page 9.)

- While DVD is selected as the source and before playback

1 Press and hold SCAN MODE for 2 seconds.

The current setting appears on the display window.

2 Press Cursor ▶/◀ to select the desired mode.

The indication on the display window starts flashing after pressing a button.

- RGB: Select when your TV accommodates the interlaced RGB/composite video signal.
- Y/C COMP.: Select when your TV accommodates the interlaced S-video signal.
- PROGRESSIVE: Select when your TV equipped with component jacks supports the progressive video input.

You can get better picture quality in the order — "PROGRESSIVE" > "RGB" > "Y/C COMP." > Composite.

3 Press ENTER while the indication is flashing.

When "PROGRESSIVE" is selected, the PROGRESSIVE indicator lights on the display window.

NOTE

- Although the picture may be distorted when you press ENTER, this is not a malfunction of the system.
- "RGB" is selected at your purchase.

- There are some progressive TVs and High-Definition TVs that are not fully compatible with this system, resulting in an unnatural picture when playing back a DVD VIDEO in the progressive scan mode. In such a case, change the scan mode to "RGB" or "Y/C COMP.". To check the compatibility of your TV, contact your local JVC customer service center.
- All JVC progressive TVs and High-Definition TVs are fully compatible with this system.

Playback

- The mark  shows the types of discs the operation is available for.

IMPORTANT

Before using the remote control for the following operation;

- 1 Set the remote control mode selector to AUDIO.
- 2 Press DVD.

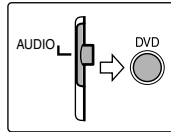

The buttons described below are used on pages 16 to 19.

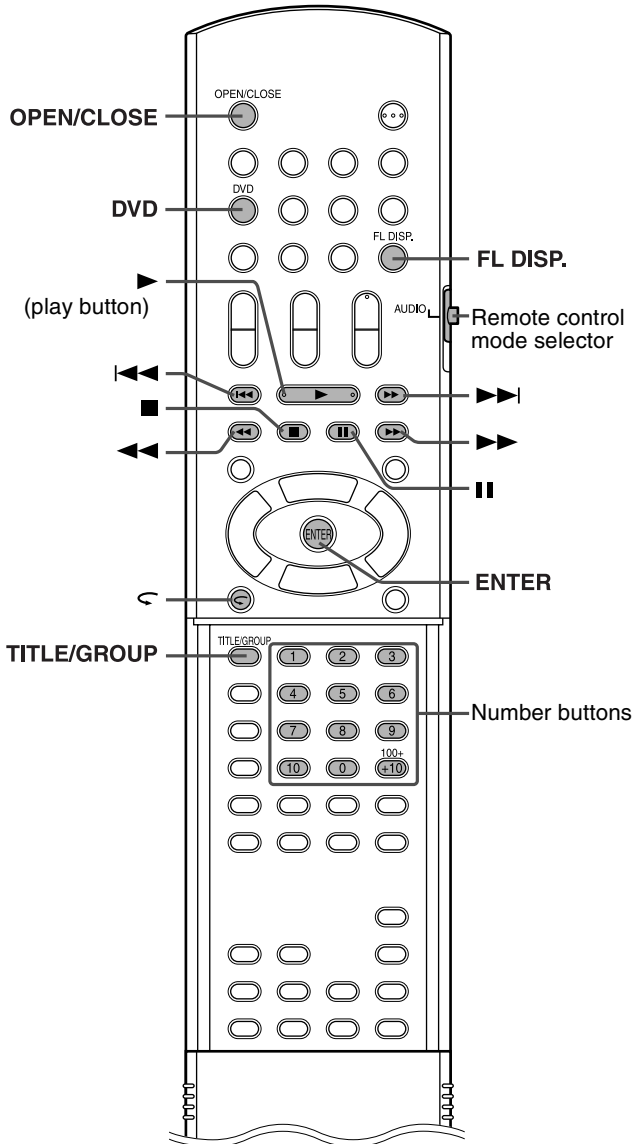

Basic playback

1 Press OPEN/CLOSE.

- The system turns on and the disc tray comes out.
-  on the center unit functions same as OPEN/CLOSE on the remote control.



2 Place a disc.

Label side up

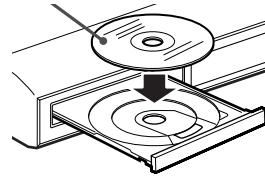

When placing an 8 cm (3 inches) disc

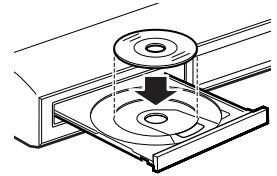

3 Press (play button).

For MP3/WMA

The file control display (see page 24) appears on the TV screen.

For JPEG

Each file (still pictures) is shown on the TV screen for about 3 seconds (slide-show). When stopping playback, the file control display (see page 24) appears on the TV screen.

For MPEG4 disc

Pressing TOP MENU or MENU shows the file control display (see page 24) on the TV screen during playback.

■ To pause

Press .











To return to playback, press .

■ To stop

Press .

■ On-screen guide icons

During DVD VIDEO playback, the following guide icons may appear for a while on the TV screen;

- : appears at the beginning of a scene containing multi-subtitle languages.
- : appears at the beginning of a scene containing multi-audio languages.
- : appears at the beginning of a scene containing multi-angle views.
-  (Play),  (Pause),  /  (Fast forward/fast-reverse),  /  (Slow-motion forward/reverse): appears when you perform each operation.
- : the disc cannot accept an operation you have tried to do.

NOTE

- (For JPEG) The system cannot accept operations even though you press any buttons before the entire picture appears on the TV screen.
- If you do not want the on-screen guide icons to appear, see page 33.

■ Playback information on the display window

DVD VIDEO

Example:

When a DVD VIDEO encoded with Dolby Digital 5.1ch is played

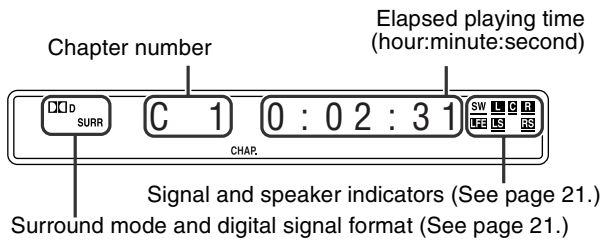

Pressing FL DISP.

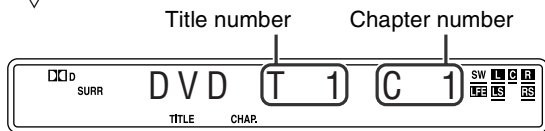

DVD AUDIO

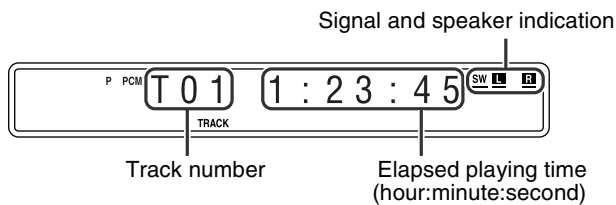

Pressing FL DISP.

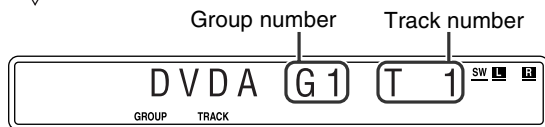

VCD/SVCD/CD

Example:

When a CD is played back

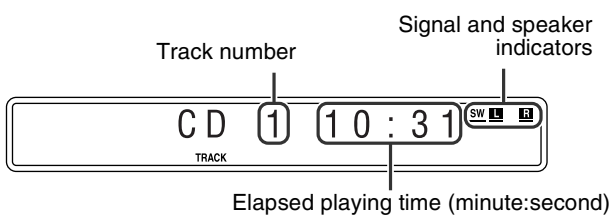

NOTE

- “VCD” appears instead of “CD” when loading a VCD or SVCD.
- When a VCD or SVCD with PBC function is played, the elapsed playing time does not appear, but “PBC” appears.

MP3/WMA disc

Example:

When an MP3 disc is played back

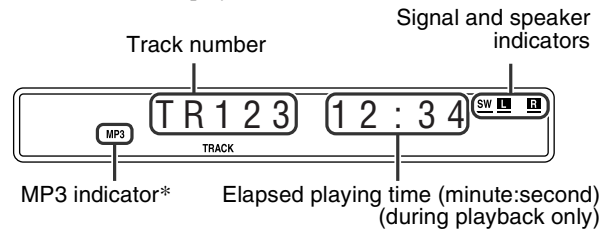

* WMA indicator lights for WMA disc.

Pressing FL DISP.

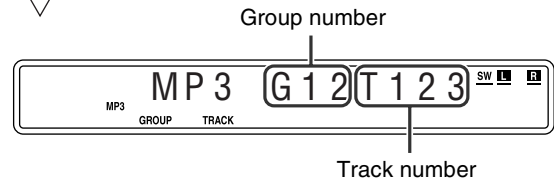

NOTE

- “WMA” appears instead of “MP3” when playing a WMA track .

JPEG disc

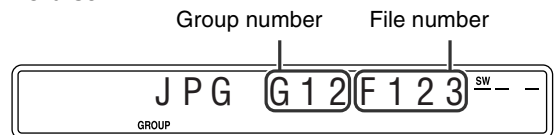

MPEG4

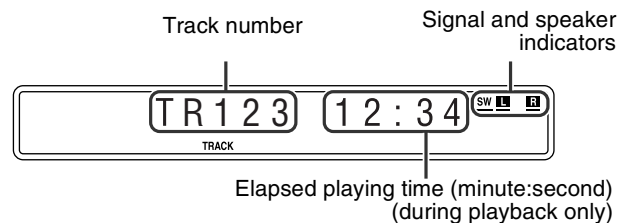

Pressing FL DISP.

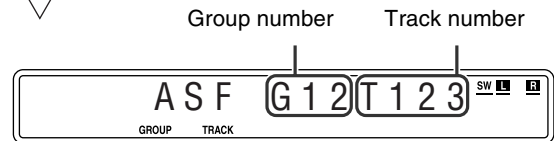

NOTE

- You can change the time information mode (except for MP3/WMA/JPEG/MPEG4). (See page 22.)
- You can also check the playback information on the TV screen. (See page 21.)

■ **Screen saver**

A TV screen may burn out if a static picture is displayed for a long time. To prevent this, the system automatically dims the screen if a static picture is displayed for over 5 minutes (the screen saver function).

- Pressing any button will cancel the screen saver function.
- If you do not want to use the screen saver function, see page 32.

One Touch Replay

You can move back the playback position by 10 seconds from the current position.



- During playback

On the remote control:

Press .

NOTE

- This function works in the same title.
- This feature may not work for some discs.

Fast-forward/fast-reverse search

- During playback



On the remote control:

Press or .

Each time you press the button, the search speed changes (x 2, x 5, x 10, x 20, x 60).

To return to normal speed playback

Press (play button).

On the center unit:

(This function does not take effect for MPEG4.)

Press and hold or .

Continuously pressing or increases the fast-forward/reverse search speed (x 5 → x 20).

NOTE

- When a DVD VIDEO, VCD, SVCD or MPEG4 is played back, no sound comes out during fast-forward/reverse search.
- When a DVD AUDIO or CD is played back, sound is intermittent and low during fast-forward/reverse search.
- This feature may not work for some discs.

Skip to the beginning of a desired selection

■ **Using / buttons**



- For DVD VIDEO (chapter):
During playback
- For VCD/SVCD (track):
During playback without PBC function
- For DVD AUDIO/CD/MP3/WMA/JPEG/MPEG4 (track/file):
During playback or while stopped

Press or repeatedly.

NOTE

- When playing back an MP3/JPEG disc, you can make operations using the file control display. (See page 24.)
- This feature may not work for some discs.

■ **Using number buttons on the remote control**

- For DVD VIDEO (title, chapter):
While stopped, the title number is selected.
During playback, the chapter number is selected.
- For DVD AUDIO (track):
During playback or while stopped
- For VCD/SVCD (track):
During playback without PBC function
- For CD/MP3/WMA/JPEG/MPEG4 (track/file):
During playback or while stopped

Press number buttons (0-10, +10) to select the desired number.

- For details on using the number buttons, see “How to use the number buttons” below.

How to use the number buttons

To select 3:	Press 3.
To select 14:	Press +10, then 4.
To select 24:	Press +10 twice, then 4.
To select 40:	Press +10 three times, then 10. Or press +10 four times, then 0.

Locating a desired title/group using number buttons

During playback or while stopped.



1 Press TITLE/GROUP.

“_ _” or “_” is shown in the title/group display area in the display window.

Example:

During DVD VIDEO playback

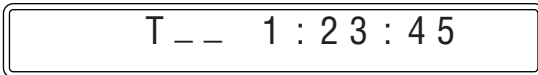

2 While the display window shows “_ _” or “_”, use number buttons (0-10, +10) to enter the desired title or group number.

The system starts playback from the first chapter/track/file of the selected title/group.

- For details on using the number buttons, see “How to use the number buttons”. (See page 18.)

NOTE

- This feature may not work for some discs.

Playing back a bonus group

Some DVD AUDIOS have a special group called “bonus group” whose contents are not open to the public. The bonus group is always assigned to the last group of a disc.



To play back a bonus group, you have to enter the specific “key number” (a password). The way of getting the key number depends on the disc. After getting the key number, you can play back the bonus group by following the procedure below.

- While the BONUS indicator lights up on the display window

1 Select the bonus group.

For selecting the group, see “Locating a desired title/group using number buttons”.

The key number entry indication appears.

On the TV



On the display window

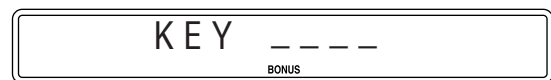

2 Press number buttons (0-9) to enter the key number, then press ENTER.

When you enter the correct key number, playback starts and the BONUS indicator goes off.

- If you enter the wrong number, the key number entry indication still appears on the TV screen. In this case, reenter the correct number.

To clear the key number entry

Perform whichever one of the following:

- Press ■.
- Open the disc tray.
- Turn off the system.

NOTE

- If you specify a track in the bonus group for Program Playback, the key number entry indication in step 1 appears for entering the key number.
- In Random Playback, tracks in the bonus group are not played back.

Advanced operations

- The mark  shows the types of discs the operation is available for.

The buttons described below are used on pages 20 to 30.

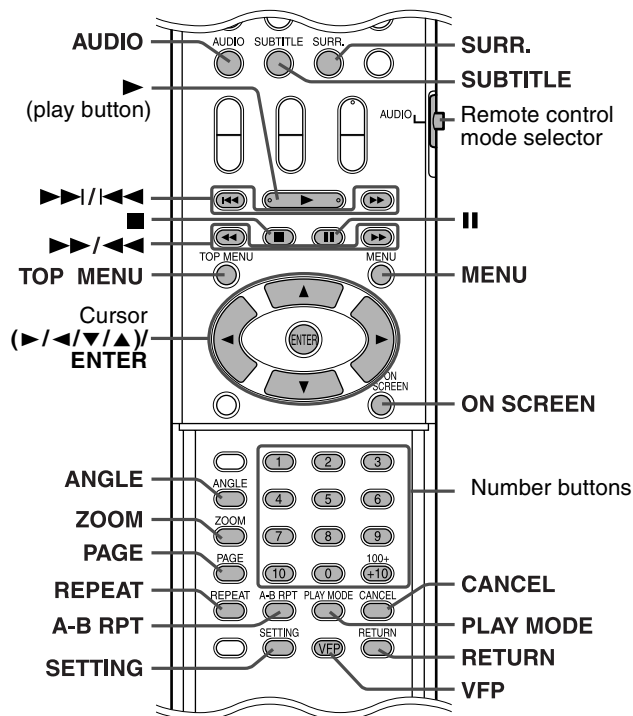

IMPORTANT

Before using the remote control for the following operation;

- 1 Set the remote control mode selector to AUDIO.
- 2 Press DVD.

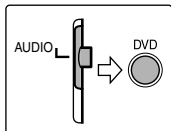

Using the surround mode

■ Auto Surround (AUTO SURR)

This function automatically selects the appropriate surround mode according to the input signals. For example, a multichannel source is automatically reproduced in multichannel audio.

■ Dolby Surround

Dolby Pro Logic II*1

Dolby Pro Logic II has a developed multichannel playback format to decode all 2 channel sources — stereo source and Dolby Surround encoded source — into a 5.1 channel.

Dolby Pro Logic II has two modes — Movie mode and Music mode:

- **Pro Logic II Movie (PL II MOVIE)**

Suitable for reproduction of Dolby Surround encoded sources bearing the mark .

- **Pro Logic II Music (PL II MUSIC)**

Suitable for reproduction of any 2 channel stereo music sources.

Dolby Digital*1

Used to reproduce multichannel soundtracks of the software encoded with Dolby Digital (.

■ DTS Digital Surround*2

Used to reproduce multichannel soundtracks of the software encoded with DTS Digital Surround (.

DTS Digital Surround (DTS) is another discrete multichannel digital audio format available on CD and DVD software.

Available Surround modes for each input signal

The √ marks show available surround modes.

Signal	Mode	Surround off	Auto Surround	Dolby Surround			DTS Digital Surround	DSP
		SURR OFF	AUTO SURR	PL II MOVIE*3	PL II MUSIC*3	Dolby Digital	DTS	ALL CH ST.*3
Dolby Digital (Multichannel)		√	√	—	—	√	—	—
Dolby Digital (2 channel)		√	√	√	√	—	—	√
DTS Digital Surround (Multichannel)		√	√	—	—	—	√	—
DTS Digital Surround (2 channel)		√	√	√	√	—	—	√
Packed PCM (Multichannel)		√	√	—	—	—	—	—
Packed PCM (2 channel)		√	√	√	√	—	—	√
Analog (VCR) or Linear PCM		√	√	√	√	—	—	√

*1 Manufactured under license from Dolby Laboratories. “Dolby”, “Pro Logic”, “MLP Lossless”, and the double-D symbol are trademarks of Dolby Laboratories.

*2 “DTS” and “DTS Digital Surround” are registered trademarks of Digital Theater Systems, Inc.

*3 You can select these modes by pressing SURR. (See page 21.)

Continued on next page

■ All Channel Stereo (DSP)

All Channel Stereo (ALL CH ST.) mode can reproduce a larger stereo sound field using all the connected (and activated) speakers. All Channel Stereo can be used while reproducing 2 channel stereo source.

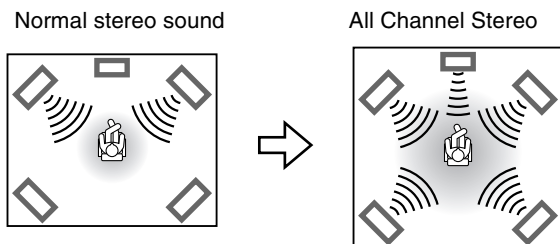

■ Indicators on the display window

Digital signal format indicators

- PPCM: Lights when DVD AUDIO packed PCM signals comes in.
- LPCM: Lights when Linear PCM signal comes in.
- DD: Lights when Dolby Digital signals come in.
- DTS: Lights when DTS Digital (Surround) signals come in.
- No indication: No digital signal indicator lights when analog signals come in.

Dolby Surround/DSP mode indicators

- PLII: Lights when Dolby Pro Logic II mode is activated.
- DSP: Lights when All Channel Stereo mode is activated.

Source signal indicators, etc.



- Light to indicate the incoming signals.
- L**: Lights when the front left channel signal comes in.
- C**: Lights when the center channel signal comes in.
- R**: Lights when the front right channel signal comes in.
- LFE**: Lights when the LFE channel signal comes in.
- LS**: Lights when the surround left channel signal comes in.
- RS**: Lights when the surround right channel signal comes in.
- S**: Lights when the monaural surround channel signal or 2 channel Dolby Surround signal comes in.
- SW**: Always lights.

The channel with “—” shows that the corresponding speakers are reproducing the channels’ sound. If the channels’ sound decoded into 5.1 channel is reproduced, only “—” lights.

Selecting the surround mode

The system is set up to automatically select the optimal surround mode for input signal from digital multichannel software. When playing back 2 channel source, you can select the desired surround mode manually.

NOTE

- This function also takes effect for the sources other than DVD.
- The surround mode does not take effects for MPEG4 files.

■ When playing back digital multichannel software (except during SURR OFF mode)

The appropriate multichannel surround mode (Dolby Digital, DTS Digital Surround or Linear/Packed PCM) is automatically selected.

■ When playing back 2 channel source

You can select either mode of Dolby Pro Logic II (PL II MOVIE/ PL II MUSIC) or the DSP (ALL CH ST.) mode.

Press SURR. repeatedly to select the desired mode.

The surround mode is turned on and the current surround mode appears on the display window. Each time you press the button, the surround mode changes.

For details on each mode, see page 20.

To turn off the surround mode

Press SURR. repeatedly until SURR OFF appears on the display window.

Storing adjustments — auto memory

When you turn the power off, the system memorizes the current surround mode. The memorized mode is automatically recalled when you turn the power on.

NOTE

- When FM or AM is selected as the source, you cannot select any surround mode.
- For a down-mixing prohibited DVD AUDIO disc, the system continues to output multi-channel signals with “MULTI CH” shown on the display window even if the surround mode is turned off during playback. On the other hand, the system outputs only the front left and front right channel signals with “LR ONLY” shown on the display window when you start playback with the surround mode having been set to “SURR OFF”.

Using the on-screen bar

You can check disc information and you can use some functions using the on-screen bar.

Showing the on-screen bar

■ Whenever a disc is loaded

Press ON SCREEN.

Each time you press the button, the on-screen bar changes as follows on the TV screen.

Example:

During DVD VIDEO playback

↓
OFF
(The on-screen bar disappears)
↓
(back to the beginning)

- The currently selected item shows green.

■ Contents of the on-screen bar during playback

DVD VIDEO

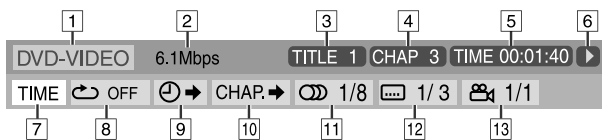

DVD AUDIO

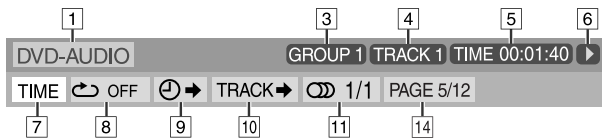

VCD

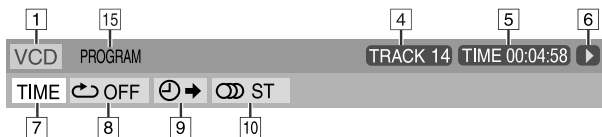

SVCD

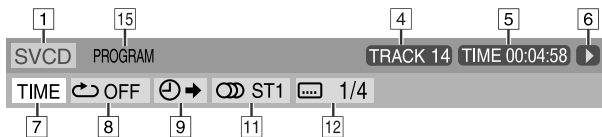

CD



MPEG4*



* [7] — [14] are not available.

- [1] Shows disc type.
- [2] Shows current transfer rate (Megabits per second).
- [3] Shows current title (for DVD VIDEO) or group (for DVD AUDIO) number.
- [4] Shows current chapter number (for DVD VIDEO) or track number (for other type of discs).
- [5] Shows time information. See “Changing the time information”.

- [6] Shows playback status.
 - ▶: appears during playback.
 - ▶▶ / ◀◀: appears during fast forward/reverse.
 - ▶◀ / ◀▶: appears during playback in forward slow-motion/ reverse slow-motion.
 - ⏸: appears when paused.
 - ⏹: appears when stopped.
- [7] Select this to change time information ([5]). See “Changing the time information”.
- [8] Select this for Repeat Playback. (See page 29.)
- [9] Select this for time search function. (See page 24.)
- [10] Select this for chapter (for DVD VIDEO) or track (for DVD AUDIO) search function. (See page 23.)
- [11] Select this to change audio language, channel, or stream. (See page 26.)
- [12] Select this to change subtitle language. (See page 25.)
- [13] Select this to change view angle. (See page 25.)
- [14] Select this to change the page. (See page 27.)
- [15] Shows Playback Mode status.
 - PROGRAM**: appears during Program Playback. (See page 28.)
 - RANDOM**: appears during Random Playback. (See page 28.)
- [16] Shows Repeat Mode status. (See page 29.)

Changing the time information

You can change the time information in the on-screen bar on the TV screen and the display window of the center unit.



- During playback
- 1 Press ON SCREEN twice.**
The on-screen bar appears on the TV screen.
- 2 Press Cursor ▶/◀ to highlight TIME .**
- 3 Press ENTER repeatedly to select the desired information.**

Example:
When elapsed playing time of disc is selected.

TOTAL 1:25:58

- TIME: Elapsed playing time of current chapter/track
- REM: Remaining time of current chapter/track
- TOTAL: Elapsed time of disc
- T. REM: Remaining time of disc

- 4 Press ON SCREEN.**
The on-screen bar disappears.

Playing from a specified position on a disc

You can start playing a title, chapter or track you specify. You can also play a disc from specified time.

Locating a desired scene from the DVD menu

DVD VIDEOS generally have their own menus which show disc contents and you can display them on the TV screen. You can locate a desired scene by using these menus.



- Whenever a DVD VIDEO is loaded

1 Press TOP MENU or MENU.

The menu appears on the TV screen.

Example:

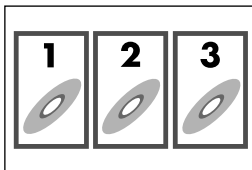

Normally, a DVD VIDEO which contains more than one title will have a "top" menu which lists the titles. Press TOP MENU to show the title menu.

Some DVD VIDEO may also have a different menu which is shown by pressing MENU.

See the instructions for each DVD VIDEO regarding its particular menu.

2 Use Cursor ►/◄/▼/▲ to select a desired item.

3 Press ENTER.

- With some discs, you can also select items by entering the corresponding number using number buttons.

Locating a desired scene using a VCD/SVCD menu with PBC

A VCD or SVCD recorded with PBC has its own menus such as a list of contained songs. You can locate a specific scene by using these menus.



- During playback with PBC function

1 Press RETURN repeatedly until the menu appears on the TV screen.

Example:

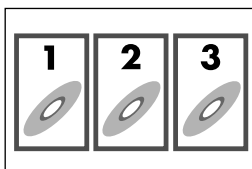

2 Press number buttons (1-10, +10) to select the number of the desired item.

- For details on using the number buttons, see "How to use the number buttons". (See page 18.).

To return to the menu

Press RETURN repeatedly until the menu screen appears.

When "NEXT" or "PREVIOUS" is shown on the TV screen:

- To go to the next page, press ►►.
- To return to the previous page, press ◄◄.

NOTE

- If you want to play a PBC-compatible VCD/SVCD without using the PBC function, perform any of the following:
 - Start playback by pressing number buttons while stopped.
 - Press ►► repeatedly until the desired track number is displayed, then start playback by pressing ► (play button). The track number appears on the display window instead of "PBC".
- To activate the PBC function when playing a PBC-compatible VCD/SVCD without using the PBC function, perform any of the following:
 - Press TOP MENU or MENU.
 - Press ■ twice to stop playback, then press ► (play button).

Locating a desired chapter/track using the on-screen bar



- During playback

1 Press ON SCREEN twice.

The on-screen bar appears on the TV screen.

2 Press Cursor ►/◄ to highlight CHAP.►/ TRACK►.

3 Press ENTER.

Example:

During DVD VIDEO playback



4 Press number buttons (0-9) to enter the desired chapter number.

Example:

- To select 8: Press 8.
- To select 10: Press 1, then 0.
- To select 37: Press 3, then 7.

To correct a misentry

Repeat step 4.

5 Press ENTER.

6 Press ON SCREEN.

The on-screen bar disappears.

NOTE

- You can select up to the 99th chapter/track.

Locating a desired position by specifying the time

You can locate a desired position by specifying the time from the beginning the disc (while stopped) or the current title/track (during playback).

- For DVD VIDEO/DVD AUDIO:  During playback
- For VCD/SVCD: While stopped or during playback without PBC function
- For CD: During playback or while stopped

1 Press ON SCREEN twice.

The on-screen bar appears on the TV screen.

2 Press Cursor ▶/◀ to highlight ⌚→.

3 Press ENTER.



4 Use number buttons (0-9) to enter the time.

You can specify the elapsed playing time from the beginning of the disc (while stopped) or from the beginning of the current title/track (during playback).

Example:

To play back from a point 2 (hours): 34 (minutes): 08 (seconds) elapsed

TIME _ : _ : _ ⇒ TIME 2 : _ : _ ⇒
Press 2 Press 3

TIME 2 : 3 _ : _ ⇒ TIME 2 : 3 4 : _ ⇒
Press 4 Press 0

TIME 2 : 3 4 : 0 _ ⇒ TIME 2 : 3 4 : 0 8
Press 8

To cancel a misentry

Press Cursor ◀ repeatedly.

5 Press ENTER.

6 Press ON SCREEN.

The on-screen bar disappears.

NOTE

- You can specify time in hours/minutes/seconds for DVD VIDEO/DVD AUDIO and in minutes/seconds for VCD/SVCD/CD.

Using the file control display

You can search and play desired groups and tracks/files using the file control display on the TV screen.



Current group /total group number Playback mode (PROGRAM, RANDOM, REPEAT)

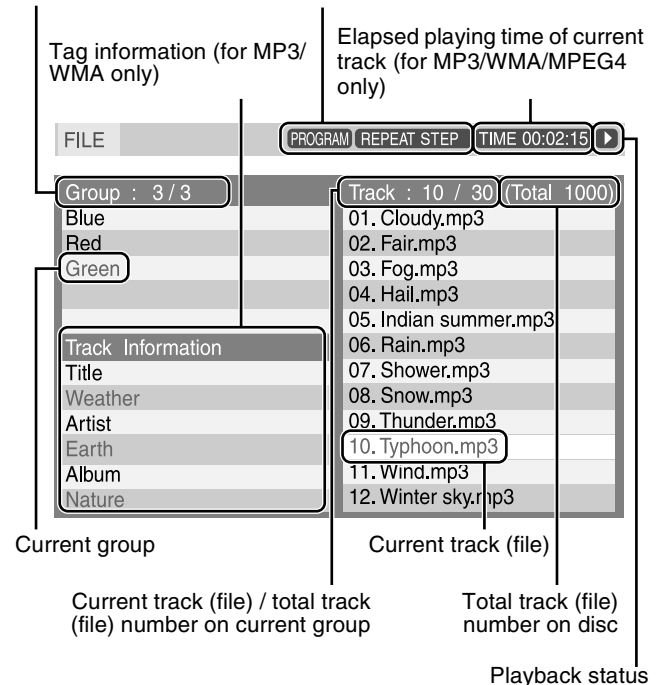

The file control display appears automatically during playback (for MP3/WMA) or while stopped.

- For MP3/WMA:
During playback or while stopped
- For JPEG/MPEG4:
While stopped

1 Press Cursor ►/◄/▼/▲ to select the desired group/track/file.

- For MP3/WMA, playback starts from the selected track.

2 Press ► (play button) or ENTER.

- Track playback/slide-show starts from the selected track/file.
- When you press ENTER for JPEG, only the selected file is played back.

To skip the file during playback

Press ►►/◄◄ or Cursor ▲/▼.

NOTE

- You can also check playback information on the display window. (See page 17.)
- Some group, track and file names may not be displayed correctly depending on recording conditions.
- The order of groups, tracks and files may be displayed differently from the order displayed on your personal computer.

Resume Playback

When Resume Playback is set to "ON" (see page 33) and you stop playback by the following operations, the position where playback has been stopped is stored. ("RESUME" appears on the display window.)

- Turning off the power (see page 13)
- Pressing ■ once
- Changing the source (see page 14)

To start playback from the stored position

("RESUME" disappears.)

- Press ► (play button) on the remote control or the center unit.
- Select DVD as the source again if you changed the source.

To clear the stored position

Press ■ again or open the disc tray.

Selecting a view angle

- During playback of a disc containing multi-view angles



When using the ANGLE button:

1 Press ANGLE.

Example:

The first view angle is selected out of 3 view angles recorded.

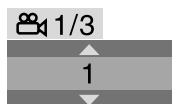

2 Press ANGLE repeatedly or Cursor ▼/▲ to select the desired view angle.

When using the on-screen bar:

1 Press ON SCREEN twice.

The on-screen bar appears on the TV screen.

2 Press Cursor ►/◄ to highlight 1/3.

3 Press ENTER.



4 Press Cursor ▼/▲ to select the desired view angle.

5 Press ENTER.

6 Press ON SCREEN.

The on-screen bar disappears.

NOTE

- During playback of DVD AUDIO, this feature is available only for the video part.

Selecting the subtitle

- During playback of a disc containing subtitles in several languages



When using the SUBTITLE button:

1 Press SUBTITLE.

Example (DVD VIDEO):

"ENGLISH" is selected out of 3 subtitle languages recorded.

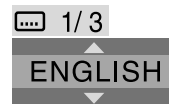

2 Press Cursor ▼/▲ to select the desired subtitle.

For SVCD

- An SVCD can contain up to four subtitles. Pressing SUBTITLE changes the subtitles regardless of whether the subtitles are recorded or not. (Subtitles will not change if no subtitle is recorded.)

NOTE

- Each time you press SUBTITLE, the subtitle appears and disappears alternately.

When using the on-screen bar:

- 1 Press ON SCREEN twice.**
The on-screen bar appears on the TV screen.
- 2 Press Cursor ►/◀ to highlight**  1/3 .
- 3 Press ENTER.**

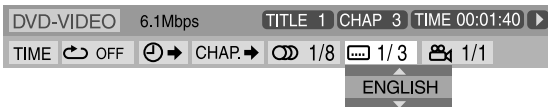

- 4 Press Cursor ▼/▲ repeatedly to select the desired subtitle.**

- 5 Press ENTER.**

- 6 Press ON SCREEN.**

The on-screen bar disappears.

NOTE

- Some subtitle or audio languages are abbreviated in the pop-up window. See “The language codes list”. (See page 31.)
- Each time you press SUBTITLE, the subtitle appears and disappears alternately.
- During DVD AUDIO playback, this feature is available only for the video part.

Selecting the audio

- During playback of a disc containing audio in several languages



When using the AUDIO button:

- 1 Press AUDIO.**

Example (DVD VIDEO):

“ENGLISH” is selected out of 3 audio languages recorded.

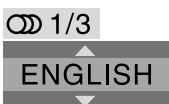

- 2 Press AUDIO repeatedly or Cursor ▼/▲ to select the desired audio.**

When using the on-screen bar:

- 1 Press ON SCREEN twice.**
The on-screen bar appears on the TV screen.
- 2 Press Cursor ►/◀ to highlight**  1/3 .
- 3 Press ENTER.**

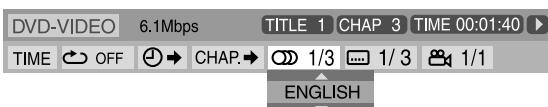

- 4 Press Cursor ▼/▲ to select the desired audio.**

- 5 Press ENTER.**

- 6 Press ON SCREEN.**

The on-screen bar disappears.

NOTE

- Some subtitle or audio languages are abbreviated in the pop-up window. See “The language codes list”. (See page 31.)
- “ST”, “L” and “R” is displayed when playing a VCD or SVCD respectively representing “stereo”, “left sound” and “right sound”.

Special picture playback

Frame-by-frame playback

- During playback

Press II repeatedly.



Each time you press the button, the still picture advances by one frame.

To return to normal playback

Press ► (play button).

NOTE

- During playback of DVD AUDIO, this feature is available only for the video part.

Playing back in slow-motion

- During playback

- 1 Press II at the point where you want to start playback in slow-motion from.**



The system pauses playback.

- 2 Press ►►.**

- Playback in forward slow-motion starts.

For DVD VIDEO/DVD AUDIO only:

- To play back in reverse slow-motion, press ◀◀.

Each time you press the button, the playback speed become faster.

To return to normal playback

Press ► (play button).

NOTE

- Sound cannot be heard during slow-motion playback.
- During DVD AUDIO playback, this feature is available only for the video part.

Selecting browsable still picture recorded on DVD AUDIO

Most DVD AUDIOS include browsable still pictures (B.S.P), which usually appear by turns automatically during playback according to the playback sequence. You can change the picture (turn the page) manually when the current group/track has selectable pictures (pages).



- During playback and while the B.S.P. indicator lights up on the display window

When using the PAGE button:

Press PAGE repeatedly to select a desired still picture.

When using the on-screen bar:

1 Press ON SCREEN twice.

The on-screen bar appears on the TV screen.

2 Press Cursor ▶/◀ to highlight .

3 Press ENTER.

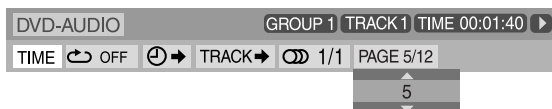

4 Press Cursor ▲/▼ to select the desired still picture.

5 Press ENTER.

6 Press ON SCREEN.

The on-screen bar disappears.

Zooming in

- During playback or while paused



1 Press ZOOM.

Each time you press ZOOM, scene magnification changes.

2 While zoomed in, press Cursor ▶/◀/▼/▲ to move zoom-in area.

To return to normal playback

Press ZOOM repeatedly to select OFF.

NOTE

- The number of the magnification steps varies depending on the disc type.
- During slide-show playback of a JPEG disc, zooming in is not available. In such a case, press **||** to pause slide-show playback, then zoom in.
- During playback of DVD AUDIO, this feature is available only for the video part.
- During playback of JPEG/MPEG4, there may be a case where Cursor (▶/◀/▼/▲) does not work in step 2.

Changing the VFP setting

The VFP (Video Fine Processor) function enables you to adjust



the picture character according to the type of programming, picture tone or personal preference.

- During playback

1 Press VFP.

The current VFP settings appear on the TV screen.

Example:

NORMAL	
GAMMA	0
BRIGHTNESS	0
CONTRAST	0
SATURATION	0
TINT	0
SHARPNESS	0

2 Press Cursor ▶/◀ repeatedly to select the VFP mode.

- NORMAL: Normally select this.
- CINEMA: Suitable for movies.

When you select "NORMAL" or "CINEMA", press VFP to complete the setting.

- USER 1 and USER 2:

You can adjust parameters that affect picture appearance.

Only when selecting "USER 1" or "USER 2" in step 2, proceed to perform the following operation;

3 Press Cursor ▼/▲ repeatedly to select a parameter you want to adjust.

Adjust gradually and confirm picture appearance results are as preferred.

- GAMMA: Controls brightness of neutral tints while maintaining brightness of dark and bright portions.
- BRIGHTNESS: Controls screen brightness.
- CONTRAST: Controls screen contrast.
- SATURATION: Controls screen color depth.
- TINT: Controls screen tint.
- SHARPNESS: Controls screen sharpness.

4 Press ENTER.

Example:

**5 Press Cursor ▼/▲ to change the setting.****6 Press ENTER.**

The current VFP settings appear again.

7 Repeat steps 3 to 6 to adjust other parameters.**8 Press VFP.****NOTE**

- Although the setting display disappears in the middle of the procedure, the setting at that time will be stored.

Program Playback

- While stopped

**1 Press PLAY MODE repeatedly until program window appears on the TV screen.**

PROGRAM		
No.	Group/Title	Track/Chapter
1		
2		
3		
4		
5		
6		
7		
8		
9		
10		

USE NUMERIC KEYS TO PROGRAM TRACKS.
USE CANCEL TO DELETE THE PROGRAM.

2 Follow the instructions that appears on the TV screen to program the desired chapters/ tracks.

- For details on using the number buttons, see "How to use the number buttons". (See page 18.)
- The content's numbers that you have to specify for programming varies depending on the disc type:
 - DVD VIDEO: Titles and chapters
 - VCD, SVCD, CD: Tracks
 - DVD AUDIO, MP3, WMA, MPEG4: Groups and tracks
- Before you program the tracks in bonus group on a DVD AUDIO, perform the procedure of "Playing back a bonus group" (see page 19) to turn on the BONUS indicator on the display window.
- You can specify the chapters/tracks whose number is up to 99.
- (For CD, SVCD or VCD) When the total playback time exceeds 99 minutes 59 seconds, "-:--" will appear on the display window. But, it is possible to continue programming.

To clear the programs one by one from the last entered number

Press CANCEL repeatedly.

To clear all programs

Press ■.

You can also clear the program by turning off the system.

3 Press ► (play button) to start Program Playback.

If all of the programmed tracks/files have been played back, playback stops and the program window appears again. Note that program setting remains.

To check the program contents

During playback, press ■. Playback stops and the program window appears.

To quit the Program mode

While stopped, press PLAY MODE repeatedly until both program window and "RANDOM" disappears from the TV screen.

NOTE

- The Resume function cannot be used with Program Playback.
- Program Playback may not work for some discs.

Random Playback

You can play titles or tracks on a disc in random order.



- While stopped

1 Press PLAY MODE repeatedly until "RANDOM" appears on the TV screen.**2 Press ► (play button).**

After playing all titles/tracks on the disc, the system stops playback and quits the Random mode.

To quit the Random mode

While stopped, press PLAY MODE repeatedly until both program window and "RANDOM" disappear from the TV screen.

You can also clear the Random mode by turning off the system.

NOTE

- The same title/track will not be played back more than once during Random Playback.

Repeat Playback

Repeating the current selection

- For DVD VIDEO:
During playback
- For VCD/SVCD:
During playback without PBC function
- For DVD AUDIO/CD/MP3/
JPEG/MPEG4:
During playback or stopped



When using the REPEAT button:
Press REPEAT.

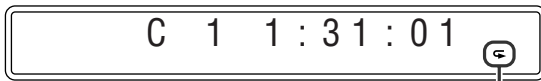

Repeat mode indicator

Each time you press REPEAT, the Repeat mode changes.

Display window	TV screen	Meanings
↻	↻GROUP	Repeats the current group for DVD AUDIO/MP3/WMA/JPEG/MPEG4 disc.
	REPEAT GROUP*	
	↻TITLE	Repeats the current title for DVD VIDEO.
	↻ALL	Repeats all tracks/files for VCD/SVCD/CD/MP3/WMA/JPEG/MPEG4 disc.
REPEAT ALL*		
↻ 1	↻TRACK ↻STEP	Repeats the current track for DVD AUDIO/VCD/SVCD/CD/MP3/WMA/MPEG4 disc.
	REPEAT TRACK, REPEAT STEP	
	↻CHAP ↻STEP	Repeats the current chapter for DVD VIDEO.
	REPEAT STEP	
No indication	↻OFF	Repeat mode is off. The system plays back the disc normally.

* During playback of a JPEG disc, "REPEAT GROUP" and "REPEAT ALL" do not appear on the TV screen.

NOTE

- When the Program mode is active with a DVD AUDIO, VCD, SVCD, or CD, the Repeat mode changes in the same manner. Note that, however, in the "↻" mode the system repeats all the programmed tracks, instead of all tracks on the disc.
- For DVD VIDEO and DVD AUDIO, REPEAT ALL may not be available depending on the disc.

When using the on-screen bar (except for MP3/WMA/JPEG/MPEG4 disc):

- 1 Press ON SCREEN twice.
The on-screen bar appears on the TV screen.
- 2 Press Cursor ▶/◀ to highlight OFF.
- 3 Press ENTER.

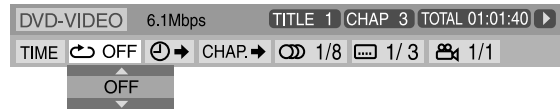

- 4 Press Cursor ▼/▲ repeatedly to select the Repeat mode.
- 5 Press ENTER.
- 6 Press ON SCREEN.

The on-screen bar disappears.

To cancel Repeat Playback
Select "OFF" in step 4.

Repeating a desired part [A-B Repeat]

You can repeat playback of a desired part by specifying the beginning (point A) and ending (point B).



- During playback

When using the A-B RPT button:

- 1 Press A-B RPT at the beginning of the part you want to repeat (point A).
The repeat mode indicator "↻ A -" appears on the display window.
- 2 Press A-B RPT again at the end of the part you want to repeat (point B).
The repeat mode indicator on the display window changes to "↻ A - B" and A-B Repeat Playback starts. The selected part of the disc (between point A and B) is played repeatedly.



To cancel

Press A-B RPT during A-B Repeat Playback.

When using the on-screen bar:

1 Press ON SCREEN twice.

The on-screen bar appears on the TV screen.

2 Press Cursor ►/◄ to highlight .

3 Press ENTER.

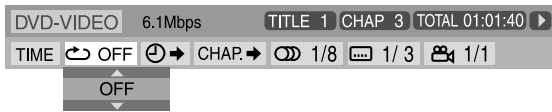

4 Press Cursor ▼/▲ repeatedly to select "A-B".

5 Press ENTER at the beginning of the part you want to repeat (point A).



6 Press ENTER at the end of the part you want to repeat (point B).

A-B Repeat Playback starts.

7 Press ON SCREEN.

The on-screen bar disappears.

To cancel

Select "OFF" in step 4, then press ENTER.

NOTE

- When playing back a DVD VIDEO, A-B Repeat Playback is possible only within the same title.
- "A-B" cannot be selected during Program and Random Playback.

Tray lock

You can lock the tray and prohibit the unwanted disc ejection.

On the center unit ONLY:

While the system is turned off

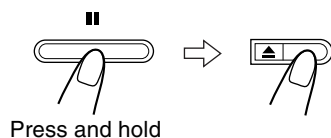

- The system turns on and "LOCKED" appears on the display window.
- If you try to eject the disc, "LOCKED" appears to indicate that the tray is locked.

To cancel

Carry out the same operation again.

- The system turns on and "UNLOCKED" appears on the display window.

Sound and other settings

NOTE

- This function also takes effect for the sources other than DVD.
- Before you start operation; There is a time limit when doing the following steps. If the setting is cancelled before you finish, start from step 1 again.

1 Press SETTING.

Example:



2 Press Cursor ▼/▲ to select the item you want to set.

- BAL (Balance): You can adjust the balance between the front left and front right speakers.
- DEC (Decode): When you play an external source (AUX DIGITAL is selected as a source) that was encoded with Dolby Digital or DTS Digital Surround, the following symptoms may occur;
 - No sound comes out at the beginning of playback.
 - Noise comes out while searching for or skipping chapters or tracks.
- AUT (Auto)/PCM: Normally select this. The system automatically detects the incoming signals.
- DOLBY D: Select this if the symptoms above occur when playing a disc (or software) encoded with Dolby Digital.
- DTS: Select this if the symptoms above occur when playing a disc (or software) encoded with DTS Digital Surround.

- A. POS (Audio Position): Set the audio position of subwoofer so that the subwoofer level can be automatically adjusted properly. (The smaller the number becomes, the more the level decreases automatically when listening in stereo.)



3 Press Cursor ►/◄ to make an adjustment or selection.

Example:



The adjustment display automatically disappears a few seconds later with the current setting.

NOTE

- When "DOLBY D" or "DTS" is selected, if a signal encoded with another digital format comes in, you cannot listen to the sound. (The  DIGITAL or  indicator flashes.)

Setting DVD preferences

Using the setup menus

- You can change the language used in the setup menus. See "Menu description".

Basic operation on the setup menus

IMPORTANT

Before using the remote control for the following operation;

- Set the remote control mode selector to AUDIO.
- Press DVD.

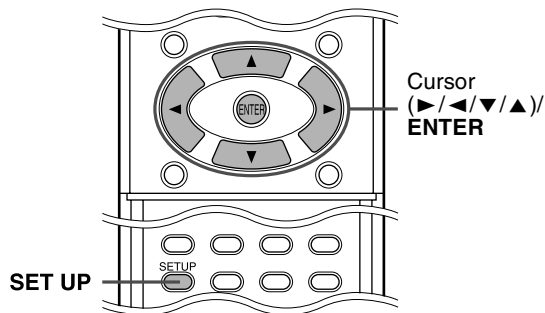
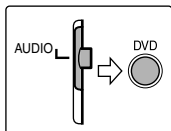

- While stopped

1 Press SET UP.

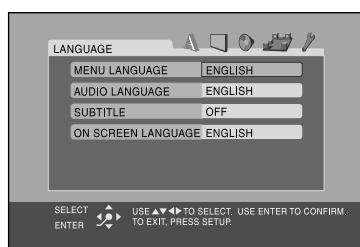

2 Follow the instructions that appears on the TV screen.

Menu description

A: Language menu (LANGUAGE)

■ MENU LANGUAGE

Some DVDs have their own menus in multiple languages.

- Select the initial menu language*.

■ AUDIO LANGUAGE

Some DVDs have multiple audio languages.

- Select the initial audio language*.

■ SUBTITLE

Some DVDs have multiple subtitle languages.

- Select the initial subtitle language*.

■ ON SCREEN LANGUAGE

- Select the language shown on the TV screen when operating this system.

* When the language you have selected is not recorded to a disc, the original language is automatically used as the initial language.

NOTE

- See the following "The language codes list" for the code of each language, such as "AA", etc.

The language codes list

AA	Afar	IK	Inupiak	RN	Kirundi
AB	Abkhazian	IN	Indonesian	RO	Rumanian
AF	Afrikaans	IS	Icelandic	RU	Russian
AM	Ameharic	IW	Hebrew	RW	Kinyarwanda
AR	Arabic	JI	Yiddish	SA	Sanskrit
AS	Assamese	JW	Javanese	SD	Sindhi
AY	Aymara	KA	Georgian	SG	Sangho
AZ	Azerbaijani	KK	Kazakh	SH	Serbo-Croatian
BA	Bashkir	KL	Greenlandic	SI	Singhalese
BE	Byelorussian	KM	Cambodian	SK	Slovak
BG	Bulgarian	KN	Kannada	SL	Slovenian
BH	Bihari	KO	Korean (KOR)	SM	Samoan
BI	Bislama	KS	Kashmiri	SN	Shona
BN	Bengali, Bangla	KU	Kurdish	SO	Somali
BO	Tibetan	KY	Kirghiz	SQ	Albanian
BR	Breton	LA	Latin	SR	Serbian
CA	Catalan	LN	Lingala	SS	Siswati
CO	Corsican	LO	Laothian	ST	Sesotho
CS	Czech	LT	Lithuanian	SU	Sundanese
CY	Welsh	LV	Latvian, Lettish	SV	Swedish
DA	Danish	MG	Malagasy	SW	Swahili
DZ	Bhutani	MI	Maori	TA	Tamil
EL	Greek	MK	Macedonian	TE	Telugu
EO	Esperanto	ML	Malayalam	TG	Tajik
ET	Estonian	MN	Mongolian	TH	Thai
EU	Basque	MO	Moldavian	TI	Tigrinya
FA	Persian	MR	Marathi	TK	Turkmen
FI	Finnish	MS	Malay (MAY)	TL	Tagalog
FJ	Fiji	MT	Maltese	TN	Setswana
FO	Faroese	MY	Burmese	TO	Tonga
FY	Frisian	NA	Nauru	TR	Turkish
GA	Irish	NE	Nepali	TS	Tsonga
GD	Scots Gaelic	NL	Dutch	TT	Tatar
GL	Galician	NO	Norwegian	TW	Twi
GN	Guarani	OC	Occitan	UK	Ukrainian
GU	Gujarati	OM	(Afan) Oromo	UR	Urdu
HA	Hausa	OR	Oriya	UZ	Uzbek
HI	Hindi	PA	Panjabi	VI	Vietnamese
HR	Croatian	PL	Polish	VO	Volapuk
HU	Hungarian	PS	Pashto, Pushto	WO	Wolof
HY	Armenian	PT	Portuguese	XH	Xhosa
IA	Interlingua	QU	Quechua	YO	Yoruba
IE	Interlingue	RM	Rhaeto-Romance	ZU	Zulu

: Picture menu (PICTURE)

■ MONITOR TYPE

You can select the monitor type to match your TV when you play DVDs recorded in the picture's height/width ratio of 16:9.

- **16:9 (Wide television conversion)**
Select this when the aspect ratio of your TV is 16:9 (wide TV).
- **4:3 LB (Letter Box conversion)**
Select this when the aspect ratio of your TV is 4:3 (conventional TV). While viewing a wide screen picture, the black bars appear on the top and the bottom of the screen.
- **4:3 PS (Pan Scan conversion)**
Select this when the aspect ratio of your TV is 4:3 (conventional TV). While viewing a wide screen picture, the black bars do not appear, however, the left and right edges of the pictures will not be shown on the screen.

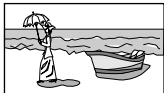

Ex.: 16:9



Ex.: 4:3 LB



Ex.: 4:3 PS

NOTE

- Even if "4:3 PS" is selected, the screen size may become "4:3 LB" with some DVDs. This depends on how DVDs are recorded.

■ PICTURE SOURCE

When you set the scan mode to PROGRESSIVE (see page 15), you can obtain optimal picture quality by selecting whether the content on the disc is processed by field (video source) or by frame (film source).

Normally set to "AUTO".

- **VIDEO**
Suitable for playing back a video source disc.
- **FILM**
Suitable for playing back a film source disc.
- **AUTO**
Used to play a disc containing both video and film source materials.
This system recognizes the source type (video or film) of the current disc according to the disc information.
 - If the playback picture is unclear or noisy, or the oblique lines of the picture are rough, try to change to other modes.

■ SCREEN SAVER (See page 18.)

You can activate or deactivate Screen Saver function.

■ FILE TYPE

When several types of files are recorded on a disc, you can select which files to play.

After changing FILE TYPE setting, be sure to turn the power off, then turn the power on to enable the new setting.

- **AUDIO**
Select this to play MP3/WMA files.
- **STILL PICTURE**
Select this to play JPEG files.
- **VIDEO**
Select this to play MPEG4 files.

: Audio menu (AUDIO)

■ D. RANGE COMPRESSION

(Dynamic range compression)

You can enjoy low level recorded sound clearly at night even at a low volume when listening to the sound with Dolby Digital.

- **ON**
Select this when you want to fully apply the compression effect (useful at midnight).
- **AUTO**
Select this when you want to enjoy surround sound with its full dynamic range (no effect applied).

NOTE

- When you play a multichannel Dolby Digital source with the surround mode is off, the setting of D. RANGE COMPRESSION is set to ON automatically.

: Speaker setting menu (SPK. SETTING)

■ Level menu (LEVEL)

CENTER SPEAKER/SURROUND LEFT SPEAKER/ SURROUND RIGHT SPEAKER/SUB WOOFER

Adjust the output level of related speakers.

TEST TONE*

Outputs the test tone.

RETURN

Returns to the SPK. SETTING menu.

- * The test tone comes out of all of the activated speakers in the following sequence:

⇒ Front left speaker ⇒ Center speaker ⇒ Front right speaker ⇒ Surround right speaker ⇒ Surround left speaker ⇒ (back to the beginning)

Setting DVD preferences

■ Distance menu (DISTANCE)

Example:

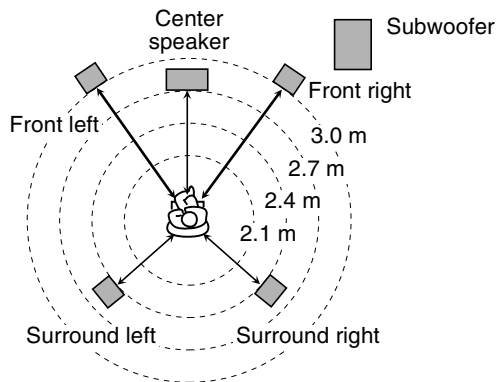

In this case, set the distance of each speaker as follows;

- Distance of front speakers: 3.0 m
- Distance of center speaker: 2.7 m
- Distance of surround speakers: 2.4 m

FRONT SPEAKER/CENTER SPEAKER/SURROUND SPEAKER

Adjust the distance from the listening position to the speakers.

Within the range from 0.3 m to 9.0 m. (by 0.3 m)

RETURN

Returns to the SPK. SETTING menu.

Other setting menu (OTHERS)

■ RESUME (See page 25.)

You can activate or deactivate Resume Playback function.

■ ON SCREEN GUIDE

You can activate or deactivate the on-screen guide icons. (See page 16.)

■ Parental lock menu (PARENTAL LOCK)

You can restrict playback of a DVD VIDEO containing violent scenes that is not suitable for your other family members.

- This setting takes effect only for DVDs containing the Parental Lock level information — Level 1 (most restrictive) to Level 8 (least restrictive).

COUNTRY CODE

Select this when you set the code for your resident. (See page 34.)

SET LEVEL

Select this when you set the level of restriction.

PASSWORD

This item is selected automatically when some changes are made on Parental Lock setting. Enter a four-digit number as your password with number buttons 0-9, then press ENTER.

- If you have failed to enter your correct password three times, you cannot select an item other than EXIT. In such a case, press ENTER to exit the mode, then try the setting again.

EXIT

Returns to OTHERS menu.

- Be sure to exit the Parental Lock setting mode after entering your password. Otherwise, the changes you made won't be stored.
- If you forget your password, enter "8888" instead of your password.

NOTE

- When you enter wrong passwords three times, you can select "EXIT" only.

Country/Area codes list for Parental Lock

AD	Andorra	ER	Eritrea	LA	Lao People's Democratic Republic	RW	Rwanda
AE	United Arab Emirates	ES	Spain	LB	Lebanon	SA	Saudi Arabia
AF	Afghanistan	ET	Ethiopia	LC	Saint Lucia	SB	Solomon Islands
AG	Antigua and Barbuda	FI	Finland	LI	Liechtenstein	SC	Seychelles
AI	Anguilla	FJ	Fiji	LK	Sri Lanka	SD	Sudan
AL	Albania	FK	Falkland Islands (Malvinas)	LR	Liberia	SE	Sweden
AM	Armenia	FM	Micronesia (Federated States of)	LS	Lesotho	SG	Singapore
AN	Netherlands Antilles			LT	Lithuania	SH	Saint Helena
AO	Angola	FO	Faroe Islands	LU	Luxembourg	SI	Slovenia
AQ	Antarctica	FR	France	LV	Latvia	SJ	Svalbard and Jan Mayen
AR	Argentina	FX	France, Metropolitan	LY	Libyan Arab Jamahiriya	SK	Slovakia
AS	American Samoa	GA	Gabon	MA	Morocco	SL	Sierra Leone
AT	Austria	GB	United Kingdom	MC	Monaco	SM	San Marino
AU	Australia	GD	Grenada	MD	Moldova, Republic of	SN	Senegal
AW	Aruba	GE	Georgia	MG	Madagascar	SO	Somalia
AZ	Azerbaijan	GF	French Guiana	MH	Marshall Islands	SR	Suriname
BA	Bosnia and Herzegovina	GH	Ghana	ML	Mali	ST	Sao Tome and Principe
BB	Barbados	GI	Gibraltar	MM	Myanmar	SV	El Salvador
BD	Bangladesh	GL	Greenland	MN	Mongolia	SY	Syrian Arab Republic
BE	Belgium	GM	Gambia	MO	Macau	SZ	Swaziland
BF	Burkina Faso	GN	Guinea	MP	Northern Mariana Islands	TC	Turks and Caicos Islands
BG	Bulgaria	GP	Guadeloupe	MQ	Martinique	TD	Chad
BH	Bahrain	GQ	Equatorial Guinea	MR	Mauritania	TF	French Southern Territories
BI	Burundi	GR	Greece	MS	Montserrat	TG	Togo
BJ	Benin	GS	South Georgia and the South Sandwich Islands	MT	Malta	TH	Thailand Code Language
BM	Bermuda			MU	Mauritius	TJ	Tajikistan
BN	Brunei Darussalam	GT	Guatemala	MV	Maldives	TK	Tokelau
BO	Bolivia	GU	Guam	MW	Malawi	TM	Turkmenistan
BR	Brazil	GW	Guinea-Bissau	MX	Mexico	TN	Tunisia
BS	Bahamas	GY	Guyana	MY	Malaysia	TO	Tonga
BT	Bhutan	HK	Hong Kong	MZ	Mozambique	TP	East Timor
BV	Bouvet Island	HM	Heard Island and McDonald Islands	NA	Namibia	TR	Turkey
BW	Botswana			NC	New Caledonia	TT	Trinidad and Tobago
BY	Belarus	HN	Honduras	NE	Niger	TV	Tuvalu
BZ	Belize	HR	Croatia	NF	Norfolk Island	TW	Taiwan
CA	Canada	HT	Haiti	NG	Nigeria	TZ	Tanzania, United Republic of
CC	Cocos (Keeling) Islands	HU	Hungary	NI	Nicaragua	UA	Ukraine
CF	Central African Republic	ID	Indonesia	NL	Netherlands	UG	Uganda
CG	Congo	IE	Ireland	NO	Norway	UM	United States Minor Outlying Islands
CH	Switzerland	IL	Israel	NP	Nepal		
CI	Côte d'Ivoire	IN	India	NR	Nauru	US	United States
CK	Cook Islands	IO	British Indian Ocean Territory	NU	Niue	UY	Uruguay
CL	Chile	IQ	Iraq	NZ	New Zealand	UZ	Uzbekistan
CM	Cameroon	IR	Iran (Islamic Republic of)	OM	Oman	VA	Vatican City State (Holy See)
CN	China	IS	Iceland	PA	Panama	VC	Saint Vincent and the Grenadines
CO	Colombia	IT	Italy	PE	Peru		
CR	Costa Rica	JM	Jamaica	PF	French Polynesia	VE	Venezuela
CU	Cuba	JO	Jordan	PG	Papua New Guinea	VG	Virgin Islands (British)
CV	Cape Verde	JP	Japan	PH	Philippines	VI	Virgin Islands (U.S.)
CX	Christmas Island	KE	Kenya	PK	Pakistan	VN	Vietnam
CY	Cyprus	KG	Kyrgyzstan	PL	Poland	VU	Vanuatu
CZ	Czech Republic	KH	Cambodia	PM	Saint Pierre and Miquelon	WF	Wallis and Futuna Islands
DE	Germany	KI	Kiribati	PN	Pitcairn	WS	Samoa
DJ	Djibouti	KM	Comoros	PR	Puerto Rico	YE	Yemen
DK	Denmark	KN	Saint Kitts and Nevis	PT	Portugal	YT	Mayotte
DM	Dominica	KP	Korea, Democratic People's Republic of	PW	Palau	YU	Yugoslavia
DO	Dominican Republic			PY	Paraguay	ZA	South Africa
DZ	Algeria	KR	Korea, Republic of	QA	Qatar	ZM	Zambia
EC	Ecuador	KW	Kuwait	RE	Réunion	ZR	Zaire
EE	Estonia	KY	Cayman Islands	RO	Romania	ZW	Zimbabwe
EG	Egypt	KZ	Kazakhstan	RU	Russian Federation		
EH	Western Sahara						

Tuner operations

IMPORTANT

Before using the remote control for the following operation;

- 1 Set the remote control mode selector to AUDIO.
- 2 Press FM/AM.

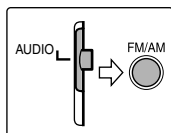

The buttons described below are used on pages 35 to 38.

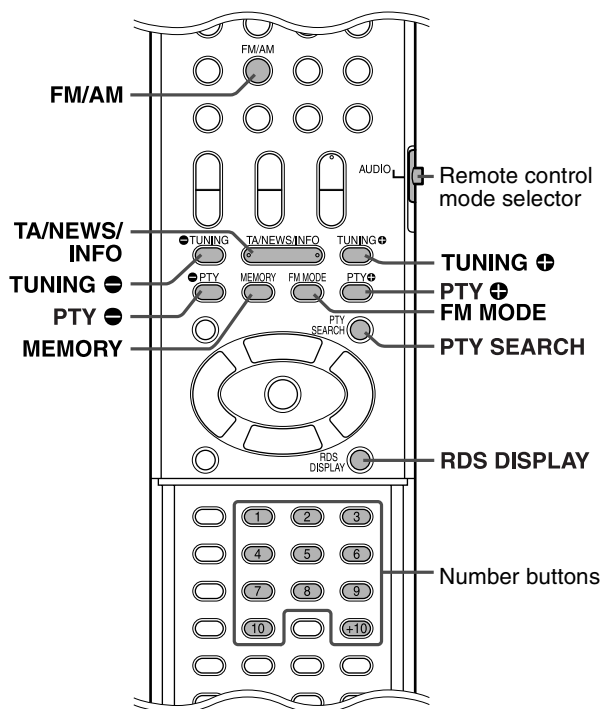

Manual tuning

1 Press FM/AM repeatedly to select the band.

Example:

When the system is tuned in to 810 kHz.

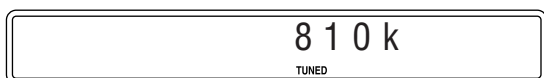

2 Press TUNING +/– repeatedly until you find the frequency you want.

When you hold down the button until the system starts searching for stations and then release it, the system stops searching automatically when a station of sufficient signal strength is tuned in to.

NOTE

- When a station of sufficient signal strength is tuned in, the TUNED indicator lights on the display window.
- When an FM stereo program is received, the ST indicator lights on the display window.

Preset tuning

Once a station is assigned to a channel number, the station can be quickly tuned in. You can preset 30 FM and 15 AM (MW) stations.

■ To preset the stations

1 Tune in the station you want to preset.

- If you want to store the FM reception mode for an FM station, select the reception mode you want. See “Selecting the FM reception mode”. (See page 36.)

Example:

When the system is tuned in to 103.5 MHz.

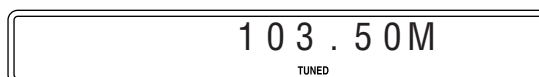

2 Press MEMORY.

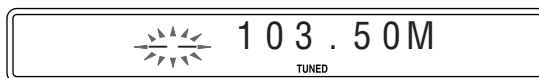

While “–” are flashing:

3 Press number button(s) (1-10, +10) to select a preset number you want.

- For details on using the number buttons, see “How to use the number buttons”. (See page 18.)

Example:

When the preset channel 1 is selected.

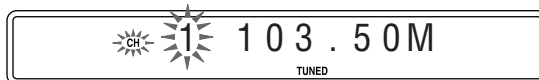

If the setting is cancelled before you finish, start from step 2 again.

While the selected number is flashing:

4 Press MEMORY.

The selected number stops flashing.

The station is assigned to the selected preset number.

If the setting is cancelled before you finish, start from step 2 again.

5 Repeat steps 1 to 4.

- Storing a new station to a used number erases the previously stored one.

■ To tune in to a preset station

1 Press FM/AM repeatedly to select FM or AM.

2 Press number button(s) (1-10, +10) to select a preset number.

- For details on using the number buttons, see “How to use the number buttons”. (See page 18.)

Selecting the FM reception mode

When the stereo FM program currently tuned in is noisy, you can change the FM reception mode to improve the reception.

- While listening to an FM station

Press FM MODE.

The FM reception mode appears on the display window.

Each time you press the button, the FM reception mode changes.

- **AUTO MUTING:**

When a program is broadcast in stereo, you will hear stereo sound. (The ST indicator lights on the display window.) When in monaural, you will hear monaural sound. This mode is also useful to suppress static noise between stations. The AUTO MUTING indicator lights on the display window.

- **MONO:**

Reception will be improved although you will lose the stereo effect. (The ST indicator goes off.) In this mode, you will hear noise until you are tuned in to a station. (The AUTO MUTING indicator also goes off.)

Using the RDS (Radio Data System) when receiving FM stations

RDS allows FM stations to send an additional signal along with their regular program signals. For example, the stations send their station names, as well as information about what type of program they broadcast, such as sports or music, etc.

When tuned in to an FM station which provides the RDS service, the RDS indicator lights up on the display window.

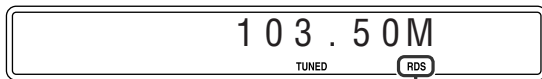

RDS indicator

With the system, you can receive the following types of RDS signals:

- PS (Program Service): Shows commonly known station names.
- PTY (Program Type): Shows types of broadcast programs.
- RT (Radio Text): Shows text messages the station sends.
- Enhanced Other Network: See page 38.

NOTE

- RDS is not available for AM (MW) broadcasts.
- RDS may not operate correctly if the station tuned is not transmitting RDS signal properly or if the signal strength is weak.

IMPORTANT

Before using the remote control for the following operation;

- 1 Set the remote control mode selector to AUDIO.
- 2 Press FM/AM.

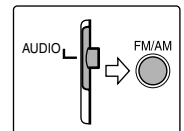

■ To show the RDS signals information

Press RDS DISPLAY while listening to an FM station.

Each time you press the button, the indication on the display window changes.

PS (Program Service):

While searching, "PS" appears and then the station names will be displayed. "NO PS" appears if no signal is sent.

PTY (Program Type):

While searching, "PTY" appears and then the type of the broadcast program will be displayed. "NO PTY" appears if no signal is sent.

RT (Radio Text):

While searching, "RT" appears and then text messages the station sends will be displayed. "NO RT" appears if no signal is sent.

Frequency:

Station frequency (non-RDS service).

About characters shown on the display window

When PS, PTY, or RT signals appear on the display window, some special characters and marks may not be displayed correctly.

NOTE

- If searching finishes at once, "PS", "PTY", and "RT" will not appear on the display window.

Searching for a program by PTY codes

One of the advantages of the RDS service is that you can locate a particular kind of program from the preset channels (see page 35) by specifying the PTY codes.

■ To search for a program using the PTY codes

NOTE

Before you start operation;

- The PTY Search is only applicable to preset stations.
- To stop searching any time during the process, press PTY SEARCH while searching.
- There is a time limit in doing the following steps. If the setting is canceled before you finish, start from step 1 again.

1 Press PTY SEARCH while listening to an FM station.

“PTY SELECT” flashes on the display window.

While “PTY SELECT” is flashing:

2 Press PTY ⊕ or PTY ⊖ until the PTY code you want appears on the display window.

- For details, see “Description of the PTY codes”.

While the PTY code selected in step 2 is still on the display window:

3 Press PTY SEARCH again.

While searching, “SEARCH” and the selected PTY code alternate on the display window.

The system searches 30 preset FM stations, stops when it finds the one you have selected, and tunes in that station.

To continue searching after the first stop

Press PTY SEARCH again while the indications on the display window are flashing.

If no program is found, “NOT FOUND” appears on the display window.

Description of the PTY codes

News:	News.
Affairs:	Topical program expanding or enlarging upon the news — debate, or analysis.
Info:	Programs the purpose of which is to impart advice in the widest sense.
Sport:	Programs concerned with any aspect of sports.
Educate:	Educational programs.
Drama:	All radio plays and serials.
Culture:	Programs concerning any aspect of national or regional culture, including language, theater, etc.
Science:	Programs about natural sciences and technology.
Varied:	Used for mainly speech-based programs such as quizzes, panel games and personality interviews.
Pop M:	Commercial music of current popular appeal.
Rock M:	Rock music.
Easy M:	Current contemporary music considered to be “easy-listening”.
Light M:	Instrumental music, and vocal or choral works.
Classics:	Performances of major orchestral works, symphonies, chamber music, etc.
Other M:	Music not fitting into any of the other categories.
Weather:	Weather reports and forecasts.
Finance:	Stock Market reports, commerce, trading etc.
Children:	Programs targeted at a young audience.
Social:	Programs about sociology, history, geography, psychology and society.
Religion:	Religious programs.
Phone In:	Involving members of the public expressing their views either by phone or at a public forum.
Travel:	Travel information.
Leisure:	Programs about recreational activities.
Jazz:	Jazz music.
Country:	Songs which originate from, or continue the musical tradition of the American Southern States.
Nation M:	Current popular music of the nation or region in that country’s language.
Oldies:	Music from the so-called “golden age” of popular music.
Folk M:	Music which has its roots in the musical culture of a particular nation.
Document:	Programs concerning factual matters, presented in an investigative style.
TEST:	Broadcasts for testing emergency broadcast equipment or unit.
Alarm !:	Emergency announcement.
None:	No program type, undefined program, or difficult to categorize into particular types.

NOTE

- Classification of the PTY codes for some FM stations may be different from the above list.

Switching to broadcast program of your choice temporarily

Another convenient RDS service is called "Enhanced Other Network".

This allows the system to switch temporarily to a broadcast program of your choice (TA, NEWS, and/or INFO) from a different station except in the following cases:

- When you are listening to non-RDS stations (all AM – MW stations, some FM stations and other sources).
- When the system is in standby mode.

NOTE

Before you start operations;

- The Enhanced Other Network function is only applicable to preset stations.

IMPORTANT

Before using the remote control for the following operation;

- 1 Set the remote control mode selector to AUDIO.
- 2 Press FM/AM.

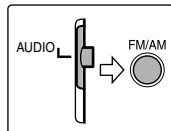

Press TA/NEWS/INFO repeatedly until the program type indicator (TA/NEWS/INFO) you want appears on the display window.

Each time you press the button, the indicator on the display window changes.

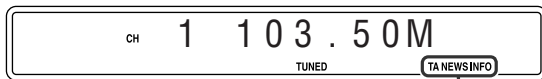

The program type indicator

- TA: Traffic Announcement in your area.
 NEWS: News.
 INFO: Program the purpose of which is to impart advice in the widest sense.

To stop listening to the program selected by Enhanced Other Network

Press TA/NEWS/INFO repeatedly again so that the program type indicator (TA/NEWS/INFO) goes off from the display window. The system exits from Enhanced Other Network standby mode and goes back to the previously selected station.

When an emergency broadcast (Alarm ! signal) is sent from an FM station

The system automatically tunes in to the station and "Alarm !" appears on the display window while the system receiving the emergency broadcast.

Note that an emergency broadcast cannot be received in the following cases;

- When you are listening to non-RDS stations (all AM — MW stations, some FM stations and other sources).
- When the system is in standby mode.

The TEST signal is used for equipment test — whether it can receive the Alarm signal correctly

The TEST signal makes the system work in the same way as the Alarm signal does. If the TEST signal is received, the system automatically switches to the station broadcasting the TEST signal. While receiving the TEST signal, "TEST" appears on the display window.

How the Enhanced Other Network function actually works

Case 1

If there is no station broadcasting the program you have selected

The system continues tuning in to the current station.



When a station starts broadcasting the program you have selected, the system automatically switches to the station. The indicator of received PTY code starts flashing.



When the program is over, the system goes back to the previously tuned station, but the Enhanced Other Network function still remains activated.

Case 2

If the FM station you are listening to is broadcasting the program you have selected

The system continues to receive the station but the indicator of received PTY code starts flashing.



When the program is over, the indicator of received PTY code stops flashing and remains lit, but the Enhanced Other Network function still remains activated.

NOTE

- In Enhanced Other Network standby mode, if you change the source to play, Enhanced Other Network standby mode is canceled temporarily.
If you change the source to FM again, the system returns to Enhanced Other Network standby mode.
- Enhanced Other Network data sent from some stations may not be compatible with this system.
- Enhanced Other Network does not function for some FM stations with RDS service.
- While listening to a program tuned in by the Enhanced Other Network function, the station does not change even if another network station starts broadcasting a program of the same Enhanced Other Network data.
- While listening to a program tuned in by the Enhanced Other Network function, you can only use TA/NEWS/INFO and RDS DISPLAY as the tuner operation buttons.

Maintenance

■ Handling Discs

- Remove the disc from its case by holding it at the edge while pressing the center hole lightly.
- Do not touch the shiny surface of the disc or bend the disc.
- Put the disc back in its case after use to prevent warping.
- Be careful not to scratch the surface of the disc when placing it back in its case.
- Avoid exposure to direct sunlight, temperature extremes and moisture.

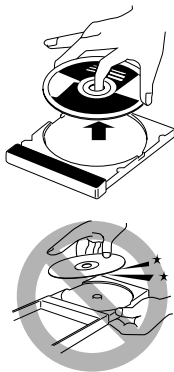

To clean the disc

Wipe the disc with a soft cloth in a straight line from center to edge.

- **DO NOT use any solvent — such as conventional record cleaner, spray, thinner or benzine — to clean the disc.**



■ Cleaning the system

- Stains on the system should be wiped off with a soft cloth. If the system is heavily stained, wipe it with a cloth soaked in water diluted neutral detergent and wrung well, then wipe clean with a dry cloth.
- Since the system may deteriorate in quality, become damaged or get its paint peeled off, be careful about the following.
 - DO NOT wipe it with a hard cloth.
 - DO NOT wipe it strong.
 - DO NOT wipe it with thinner or benzine.
 - DO NOT apply any volatile substance such as insecticides to it.
 - DO NOT allow any rubber or plastic to remain in contact with it for a long time.

Troubleshooting

PROBLEM	POSSIBLE CAUSE	SOLUTION
Power does not come on.	The power cord is not connected.	Connect the power cord correctly. (See page 10.)
The remote control does not work.	The batteries are exhausted.	Replace the batteries. (See page 6.)
	Sunlight is falling directly on the remote sensor.	Hide the remote sensor from direct sunlight.
The remote control does not work as expected.	The remote control mode is not for the desired source.	Before operation, press one of the source selecting buttons for the desired source.
	The position of the remote control mode selector is incorrect.	Set the selector to the correct position.
No sound.	The speaker cord is not connected.	Check the connection. (See page 8.)
	The audio cord is not connected to AUX IN and/or DIGITAL IN correctly.	Connect the cord correctly. (See page 10.)
	An incorrect source has been selected.	Select the correct source. (See page 14.)
	The decode mode is not set correctly.	Select the proper decode mode. (See page 30.)
No picture is displayed on the TV screen.	The video cord is not connected correctly.	Connect the cord correctly. (See page 9.)
	The disc is not playable.	Use a playable disc. (See page 3.)
No picture is displayed on the TV screen, the picture is blurred, or the picture is divided into two parts.	The scan mode is set to "PROGRESSIVE" though the center unit is connected to the TV which does not support the progressive video input.	Change the scan mode to "RGB" or "Y/C COMP.". (See page 15.)
No sound from the speakers and "NO AUDIO" is displayed on the display window.	Water-mark on DVD AUDIO is detected and playback has been prohibited.	Consult the selling agency of the disc.
Video and audio are distorted.	The disc is scratched or dirty.	Replace or clean the disc.
	A VCR is connected between the center unit and the TV.	Connect the center unit and TV directly. (See page 9.)
The picture does not fit the TV screen.	The monitor type is not set correctly.	Set "MONITOR TYPE" properly. (See page 32.)
Hard to listen to broadcast because of noise.	Antennas are disconnected.	Reconnect the antennas correctly and securely. (See page 7.)

Specifications

■ Center unit (XV-THS3)

Audio section

Total Harmonic Distortion 0.02 %

Audio input sensitivity/Impedance (at 1 kHz)

Digital input*:

OPTICAL DIGITAL IN:
-21 dBm to -15 dBm(660 nm ±30 nm)

* Corresponding to Linear PCM, Dolby Digital, and DTS Digital Surround (with sampling frequency — 32 kHz, 44.1 kHz, 48 kHz)

Video section

Video System: PAL

Horizontal Resolution: 500 lines

Signal-to-Noise Ratio: 64 dB

(Composite signal when "RGB" is selected)

Video output level

Composite: 1.0 V(p-p)/75 Ω

S-video-Y: 1.0 V(p-p)/75 Ω

S-video-C: 0.3 V(p-p)/75 Ω

Component-Y: 1.0 V(p-p)/75 Ω

Component-Pb/Pr: 0.7 V(p-p)/75 Ω

Tuner section

Tuning Range

FM: 87.50 MHz to 108.00 MHz

AM: 522 kHz to 1 629 kHz

General

Power Requirements: AC 230 V ~, 50 Hz

Power Consumption: 75 W (at operation)

1.0 W (in standby mode)

Dimensions (W × H × D):

360 mm × 65 mm × 370 mm

Mass: 5.3 kg

■ Front speakers (SP-THS3F)

Type: 1-Way Bass-Reflex Type
(Magnetically-shielded Type)

Speaker: 8.0 cm cone × 1

Power Handling Capacity: 52 W

Impedance: 6 Ω

Frequency Range: 85 Hz to 20 000 Hz

Sound Pressure Level: 82 dB/W·m

Dimensions (W × H × D):

105 mm × 118 mm × 98 mm

Mass: 0.60 kg each

■ Center speaker (SP-THS3F)

Type: 1-Way Bass-Reflex Type
(Magnetically-shielded Type)

Speaker: 8.0 cm cone × 1

Power Handling Capacity: 52 W

Impedance: 6 Ω

Frequency Range: 85 Hz to 20 000 Hz

Sound Pressure Level: 82 dB/W·m

Dimensions (W × H × D):

105 mm × 118 mm × 98 mm

Mass: 0.65 kg

■ Surround speakers (SP-THS3F)

Type: 1-Way Bass-Reflex Type
(Magnetically-shielded Type)

Speaker: 8.0 cm cone × 1

Power Handling Capacity: 52 W

Impedance: 6 Ω

Frequency Range: 85 Hz to 20 000 Hz

Sound Pressure Level: 80 dB/W·m

Dimensions (W × H × D):

105 mm × 118 mm × 98 mm

Mass: 0.55 kg each

■ Subwoofer (SP-WS3)

Type: 1-Way Bass-Reflex Type
(Magnetically-shielded Type)

Speaker: 16.0 cm cone × 1

Power Handling Capacity: 52 W

Impedance: 6 Ω

Frequency Range: 40 Hz to 1 800 Hz

Sound Pressure Level: 85 dB/W·m

Dimensions (W × H × D):

139 mm × 350 mm × 408 mm

Mass: 4.0 kg

Designs & specifications are subject to change without notice.



Free Manuals Download Website

<http://myh66.com>

<http://usermanuals.us>

<http://www.somanuals.com>

<http://www.4manuals.cc>

<http://www.manual-lib.com>

<http://www.404manual.com>

<http://www.luxmanual.com>

<http://aubethermostatmanual.com>

Golf course search by state

<http://golfingnear.com>

Email search by domain

<http://emailbydomain.com>

Auto manuals search

<http://auto.somanuals.com>

TV manuals search

<http://tv.somanuals.com>