

# JVC<sup>®</sup>

*For model:  
AV-20FD24*

## TV/DVD COMBO USER'S GUIDE

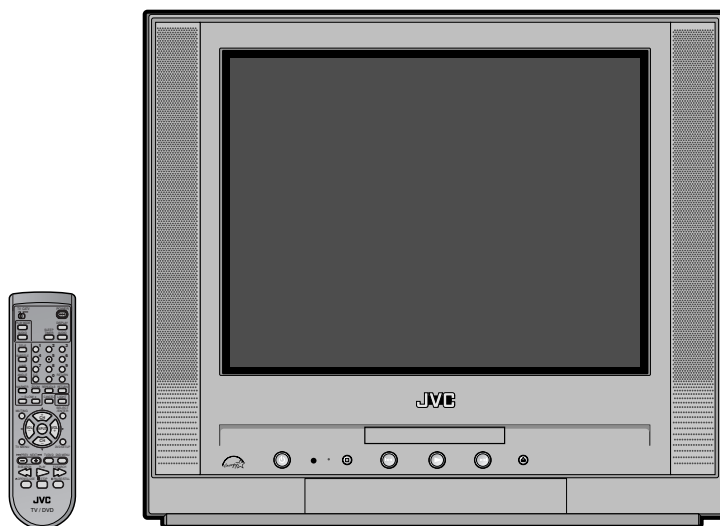



### **IMPORTANT NOTE TO THE CUSTOMER:**

In the space below, enter the serial number for your television (located on the rear of the television cabinet).  
Staple your sales receipt or invoice to the inside cover of this guide.  
Keep this user's guide in a convenient place for future reference.  
Keep the carton and original packaging for future use.

---

Serial Number

	<b>CAUTION</b> <b>RISK OF ELECTRIC SHOCK</b> <b>DO NOT OPEN</b>	
<p><b>CAUTION:</b> TO REDUCE THE RISK OF ELECTRIC SHOCK, DO NOT REMOVE COVER (OR BACK). NO USER-SERVICEABLE PARTS INSIDE. REFER SERVICING TO QUALIFIED SERVICE PERSONNEL.</p>		

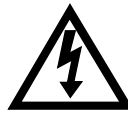

The lightning flash with arrowhead symbol, within an equilateral triangle is intended to alert the user to the presence of uninsulated dangerous voltage within the product's enclosure that may be of sufficient magnitude to constitute a risk of electric shock.



The exclamation point within an equilateral triangle is intended to alert the user to the presence of important operating and maintenance (servicing) instructions in the literature accompanying the appliance.

<p><b>WARNING:</b> TO PREVENT FIRE OR SHOCK HAZARD, DO NOT EXPOSE THIS APPLIANCE TO RAIN OR MOISTURE.</p>
<p><b>CAUTION:</b> TO PREVENT ELECTRIC SHOCK DO NOT USE THIS POLARIZED PLUG WITH AN EXTENSION CORD, RECEPTACLE OR OTHER OUTLET UNLESS THE BLADES CAN BE FULLY INSERTED TO PREVENT BLADE EXPOSURE.</p>

**WARNING:** This equipment has been tested and found to comply with the limits for a Class B digital device, pursuant to Part 15 of the FCC Rules. These limits are designed to provide reasonable protection against harmful interference in a residential installation. This equipment generates, uses and can radiate radio frequency energy and, if not installed and used in accordance with the instructions, may cause harmful interference to radio communications. However, there is no guarantee that interference will not occur in a particular installation. If this equipment does cause harmful interference to radio or television reception, which can be determined by turning the equipment off and on, the user is encouraged to try to correct the interference by one or more of the following measures:

- Reorient or relocate the receiving antenna.
- Increase the separation between the equipment and receiver.
- Connect the equipment into an outlet on a circuit different from that to which the receiver is connected.
- Consult the dealer or an experienced radio/TV technician for help.

**CAUTION:** Changes or modifications not expressly approved by the party responsible for compliance with the FCC Rules could void the user's authority to operate this equipment.

<p><b>CAUTION:</b> THIS DIGITAL VIDEO PLAYER EMPLOYS A LASER SYSTEM.</p> <p>TO ENSURE PROPER USE OF THIS PRODUCT, PLEASE READ THIS USER'S GUIDE CAREFULLY AND RETAIN FOR FUTURE REFERENCE. SHOULD THE UNIT REQUIRE MAINTENANCE, CONTACT A JVC AUTHORIZED SERVICE CENTER.</p> <p>USE OF CONTROLS, ADJUSTMENTS OR THE PERFORMANCE OF PROCEDURES OTHER THAN THOSE SPECIFIED HEREIN MAY RESULT IN HAZARDOUS RADIATION EXPOSURE.</p> <p>TO PREVENT DIRECT EXPOSURE TO LASER BEAM, DO NOT TRY TO OPEN THE ENCLOSURE. VISIBLE LASER RADIATION MAY BE PRESENT WHEN THE ENCLOSURE IS OPENED. DO NOT STARE INTO BEAM.</p>
---

**Location of the required Marking**

The rating sheet and the safety caution are on the rear of the unit.

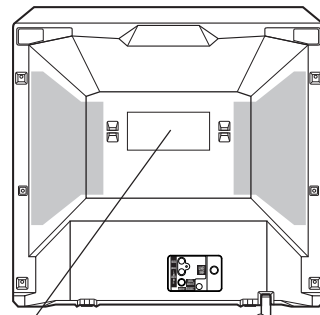

CERTIFICATION: COMPLIES WITH FDA RADIATION PERFORMANCE STANDARDS, 21 CFR SUBCHAPTER J.

# IMPORTANT SAFEGUARDS

## 1. READ INSTRUCTIONS

All the safety and operating instructions should be read before the unit is operated.

## 2. RETAIN INSTRUCTIONS

The safety and operating instructions should be retained for future reference.

## 3. HEED WARNINGS

All warnings on the unit and in the operating instructions should be adhered to.

## 4. FOLLOW INSTRUCTIONS

All operating and use instructions should be followed.

## 5. CLEANING

Unplug this unit from the wall outlet before cleaning. Do not use liquid cleaners or aerosol cleaners.

Use a damp cloth for cleaning the exterior cabinet only.

## 6. ATTACHMENTS

The manufacturer of this unit does not make any recommendations for attachments, as they may cause hazards.

## 7. WATER AND MOISTURE

Do not use this unit near water. For example, near a bathtub, washbowl, kitchen sink, laundry tub, in a wet basement, or near a swimming pool.

## 8. ACCESSORIES

Do not place this unit on an unstable cart, stand, tripod, bracket, or table.

The unit may fall, causing serious injury, and serious damage to the unit.

- 8A.** An appliance and cart combination should be moved with care. Quick stops, excessive force, and uneven surfaces may cause the appliance and cart combination to overturn.

## 9. VENTILATION

Slots and openings in the cabinet back or bottom are provided for ventilation, and to ensure reliable operation of the unit, and to protect it from overheating.

These openings must not be blocked or covered. The openings should never be blocked by placing the unit on a bed, sofa, rug, or other similar surface. This unit should never be placed near or over a radiator or heat source. This unit should not be placed in a built-in installations such as a bookcase or rack unless proper ventilation is provided or the manufacturer's instructions have been adhered to.

## 10. POWER SOURCES

This unit should be operated only from the type of power source indicated on the rating plate. If you are not sure of the type of power supply to your home, consult your appliance dealer or local power company. For units intended to operate from battery power, or other sources, refer to the operating instructions.

## 11. GROUNDING OR POLARIZATION

This unit is equipped with a polarized alternating-current line plug (a plug having one blade wider than the other). This plug will fit into the power outlet only one way. This is a safety feature. If you are unable to insert the plug fully into the outlet, try reversing the plug. If the plug should still fail to fit, contact your electrician to replace your obsolete outlet. Do not defeat the safety purpose of the polarized plug, if your unit is equipped with a 3-wire grounding-type plug, a plug having a third (grounding) pin. This plug will only fit into a grounding-type power outlet. This too, is a safety feature. If you are unable to insert the plug into the outlet, contact your electrician to replace your obsolete outlet.

Do not defeat the safety purpose of the grounding-type plug.

PORTABLE CART WARNING  
(symbol provided by RETAC)



## 12. POWER-CORD PROTECTION

Power-supply cords should be routed so that they are not likely to be walked on or pinched by items placed upon or against them, paying particular attention to cords at plugs, convenience receptacles, and the point where they exit from the appliance.

## 13. LIGHTNING

To protect your unit from a lightning storm, or when it is left unattended and unused for long periods of time, unplug it from the wall outlet and disconnect the antenna or cable system. This will prevent damage to the unit due to lightning and power line surges.

## 14. POWER LINES

An outside antenna system should not be located in the vicinity of overhead power lines or other electric light or power circuits, or where it can fall into such power lines or circuits. When installing an outside antenna system, extreme care should be taken to keep from touching such power lines or circuits, as contact with them might be fatal.

## 15. OVERLOADING

Do not overload wall outlets and extension cords, as this can result in a risk of fire or electric shock.

## 16. OBJECT AND LIQUID ENTRY

Do not push objects through any openings in this unit, as they may touch dangerous voltage points or short out parts that could result in fire or electric shock. Never spill or spray any type of liquid into the unit.

## 17. OUTDOOR ANTENNA GROUNDING

If an outside antenna or cable system is connected to the unit, be sure the antenna or cable system is grounded to provide some protection against voltage surges and built-up static charges. Section 810 of the National Electrical Code, ANSI/NFPA 70, provides information with respect to proper grounding of the mast and supporting structure, grounding of the lead-in wire to an antenna discharge unit, size of grounding conductors, location of antenna discharge unit, connection to grounding electrodes, and requirements for the grounding electrode.

## 18. SERVICING

Do not attempt to service this unit yourself as opening or removing covers may expose you to dangerous voltage or other hazards. Refer all servicing to qualified service personnel.

## 19. DAMAGE REQUIRING SERVICE

Unplug this unit from the wall outlet and refer servicing to qualified service personnel under the following conditions:

- a. When the power-supply cord or plug is damaged.
- b. If liquid has been spilled, or objects have fallen into the unit.
- c. If the unit has been exposed to rain or water.
- d. If the unit does not operate normally by following the operating instructions. Adjust only those controls that are covered by the operating instructions, as an improper adjustment of other controls may result in damage and will often require extensive work by a qualified technician to restore the unit to its normal operation.
- e. If the unit has been dropped or the cabinet has been damaged.
- f. When the unit exhibits a distinct change in performance, this indicates a need for service.

## 20. REPLACEMENT PARTS

When replacement parts are required, be sure the service technician uses replacement parts specified by the manufacturer or those that have the same characteristics as the original part.

Unauthorized substitutions may result in fire, electric shock or other hazards.

## 21. SAFETY CHECK

Upon completion of any service or repairs to this unit, ask the service technician to perform safety checks to determine that the unit is in proper operating condition.

## 22. HEAT

The product should be situated away from heat sources such as radiators, heat registers, stoves, or other products (including amplifiers) that produce heat.

## 23. DISC TRAY

Keep your fingers well clear of the disc tray as it is closing. It may cause serious personal injury.

## 24. CONNECTING

When you connect the product to other equipment, turn off the power and unplug all of the equipment from the wall outlet. Failure to do so may cause an electric shock and serious personal injury. Read the owner's manual of the other equipment carefully and follow the instructions when making any connections.

## 25. SOUND VOLUME

Reduce the volume to the minimum level before you turn on the product. Otherwise, sudden high volume sound may cause hearing or speaker damage.

## 26. SOUND DISTORTION

Do not allow the product output distorted sound for a longtime. It may cause speaker overheating and fire.

## 27. HEADPHONES

When you use the headphones, keep the volume at a moderate level. If you use the headphones continuously with high volume sound, it may cause hearing damage.

## 28. LASER BEAM

Do not look into the opening of the disc tray or ventilation opening of the product to see the source of the laser beam. It may cause sight damage.

## 29. DISC

Do not use a cracked, deformed, or repaired disc. These discs are easily broken and may cause serious personal injury and product malfunction.

## 30. NOTE TO CATV SYSTEM INSTALLER

This reminder is provided to call the CATV system installer's attention to Article 820-40 of the NEC that provides guidelines for proper grounding and, in particular, specifies that the cable ground shall be connected to the grounding system of the building, as close to the point of cable entry as practical.

### EXAMPLE OF ANTENNA GROUNDING AS PER THE NATIONAL ELECTRICAL CODE

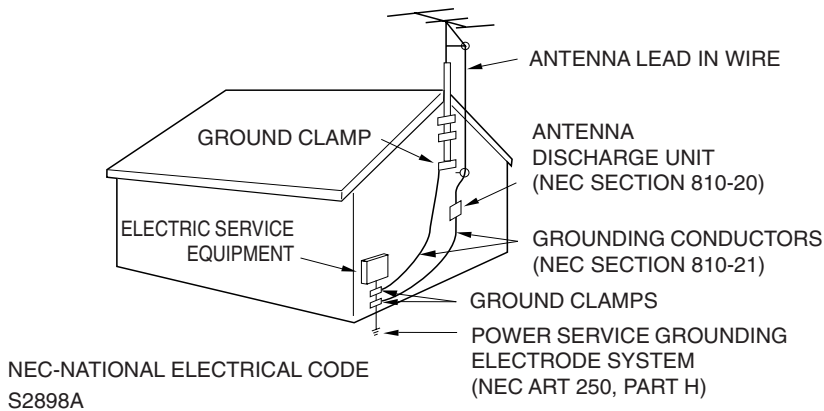

## CONDENSATION

Moisture will form in the operating section of the player if the player is brought from cool surroundings into a warm room or if the temperature of the room rises suddenly. When this happens, player's performance will be impaired.

To prevent this, let the player stand in its new surroundings for about an hour before switching it on, or make sure that the room temperature rises gradually.

Condensation may also form during the summer if the player is exposed to the breeze from an air conditioner. In such cases, change the location of the player.

## Power Source

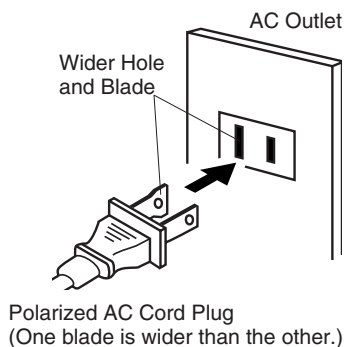

### TO USE AC POWER SOURCE

Use the AC polarized line cord provided for operation on AC. Insert the AC cord plug into a standard 120V 60Hz polarized AC outlet.

### NOTES:

- Never connect the AC line cord plug to other than the specified voltage (120V 60Hz). Use the attached power cord only.
- If the polarized AC cord does not fit into a non-polarized AC outlet, do not attempt to file or cut the blade. It is the user's responsibility to have an electrician replace the obsolete outlet.
- If you cause a static discharge when touching the unit and the unit fails to function, simply unplug the unit from the AC outlet and plug it back in. The unit should return to normal operation.

# Features

---

## Color TV With DVD/CD player

Unique space saving design combines a 20" flat color TV and a DVD/CD player.

The DVD disc has much more capacity, but is the same size as the audio CD disc. Picture/Audio quality of the DVD exceeds other software. Picture quality is higher than Super VHS. Audio quality is higher than audio CD. The DVD also has special options; audio language selection, subtitle language selection or multi-angle, etc.

The DVD PLAYER can play back audio CDs.

## High Quality Picture

### Horizontal Resolution

More than 500 lines. It exceeds Super VHS (400 lines) or Laser Disc (430 lines) in resolution.

## Compatible with a wide range of DVD audio outputs

### Digital Audio Jack (Coaxial)

- When a component with a built-in Dolby Digital decoder is connected, Dolby Digital sound can produce the effect of being in a movie theater or a concert hall.
- Surround standard different from Dolby Digital. This format is already in use in many theaters. By connecting this unit to a DTS decoder or an AV amplifier with a built-in DTS decoder, the DTS audio of DVD discs recorded in this format can be enjoyed. However, audio will not be output from the analog audio output jacks.
- By connecting this unit to an AV amplifier with a built-in MPEG decoder, the MPEG audio of DVD discs recorded in this format can be enjoyed.
- The Linear PCM sound of a 48 kHz/16 bit through 96 kHz/20 bit exceeds audio CD sound.

## Convenience Features

**Frame Advance** - The **PAUSE/STILL** moves one frame at a time.

**Slow Motion** - The **SLOW** moves you back and forth through the program by 4 steps of 1/8-1/2 times.

**Repeat Playback** - You can repeat chapter track or title between two selected points.

**Program Playback** - You can play back tracks in programmed sequences.

**Zoom (DVD only)** - You can zoom in the selected subject on the screen during playback.

**Note:** Make sure that discs are suitable for the following functions.

**Multi-Language** - Maximum 32 language subtitles and maximum 8 language soundtracks can be played back for movies or programs.

**Multi-Angle** - Pictures of Sports or a Live Concert are recorded with many cameras. When you play such a disc, you can change the angles during playback.

**Parental Control** - You can limit the play back of scenes or sounds of adult DVD discs which have parental level.

**Video Aspect Ratio** - You can change the aspect ratio of the screen for your monitor.

## TV Features

**Flat Picture Tube** - It reduces the influence of surrounding light resulting in outstanding image detail and clarity.

**181 Channel Tuner** - Receives standard VHF and UHF broadcast channels and up to 113 cable channels. The actual number of channels received depends upon channel reception in your area or your cable system.

**Closed Caption Decoder With Full Text Mode** - Displays text captions or full screen text on the screen for hearing impaired viewers.

**Picture Adjustments Using The Remote Control** - The On-Screen display allows precise remote control adjustment of BRIGHTNESS, CONTRAST, COLOR, TINT and SHARPNESS.

**Programmable TV Sleep Timer** - Operable from the remote control, the TV can be programmed up to 120 minutes to turn off automatically.

**On-Screen 3 Language Display** - You can select one of 3 languages, English, Spanish or French for on-screen programming.

**V-Chip** - The V-Chip function can read the rating of a TV program or movie content if the program is encoded with this information. V-chip will allow you to set a restriction level.

This product incorporates copyright protection technology that is protected by method claims of certain U.S. patents and other intellectual property rights owned by Macrovision Corporation and other rights owners. Use of this copyright protection technology must be authorized by Macrovision Corporation, and is intended for home and other limited viewing uses only unless otherwise authorized by Macrovision Corporation. Reverse engineering or disassembly is prohibited.



ENERGY STAR

- As an “ENERGY STAR®” partner, JVC has determined that this product or product model meets the “ENERGY STAR®” guidelines for energy efficiency.

## IMPORTANT RECYCLING INFORMATION

**This product utilizes both a Cathode Ray Tube (CRT) and other components that contain lead. Disposal of these materials may be regulated in your community due to environmental considerations. For disposal or recycling information, please contact your local authorities, or the Electronic Industries Alliance: <http://www.eiae.org>**

## Contents

### Before using your unit

IMPORTANT SAFEGUARDS .....	3
Power source .....	5
Features .....	6
Contents .....	7
Parts and functions .....	8
Remote control .....	9
Antenna connections .....	11
Cable TV connections .....	12

### TV operation

Setting the language .....	13
TV operation .....	14
Closed captions .....	16
To memorize channels .....	17
Setting the V-Chip .....	19
Picture control adjustment .....	22
Stereo and separate audio program (SAP) ..	23
Sound control adjustment .....	24

### Playback operation

Disc .....	25
Preparation/Status display of disc .....	26
Playback procedure .....	27
Special playback .....	28
MP3 playback .....	29

### Advanced Function

Zooming/Locating desired scene .....	30
Repeat, Random and Program playback/ Repeat A-B .....	31
Marking desired scenes .....	32
Changing soundtrack language/Subtitles .....	33
Changing angles/Title selection/DVD menu ...	34

### Additional Information

Setting language .....	35
Setting the aspect ratio of TV screen/ Setting on screen display .....	36
Dynamic Range Control .....	37
Parental control setting .....	38
To change the parental level .....	39
Temporary disabling of rating level by DVD disc .....	40
Language code list .....	41
Connections to other equipments .....	42
Problems and troubleshooting .....	44
Reception disturbances .....	46
Specifications .....	47
Appendix (Remote programming) .....	48

# Parts and functions

## Front

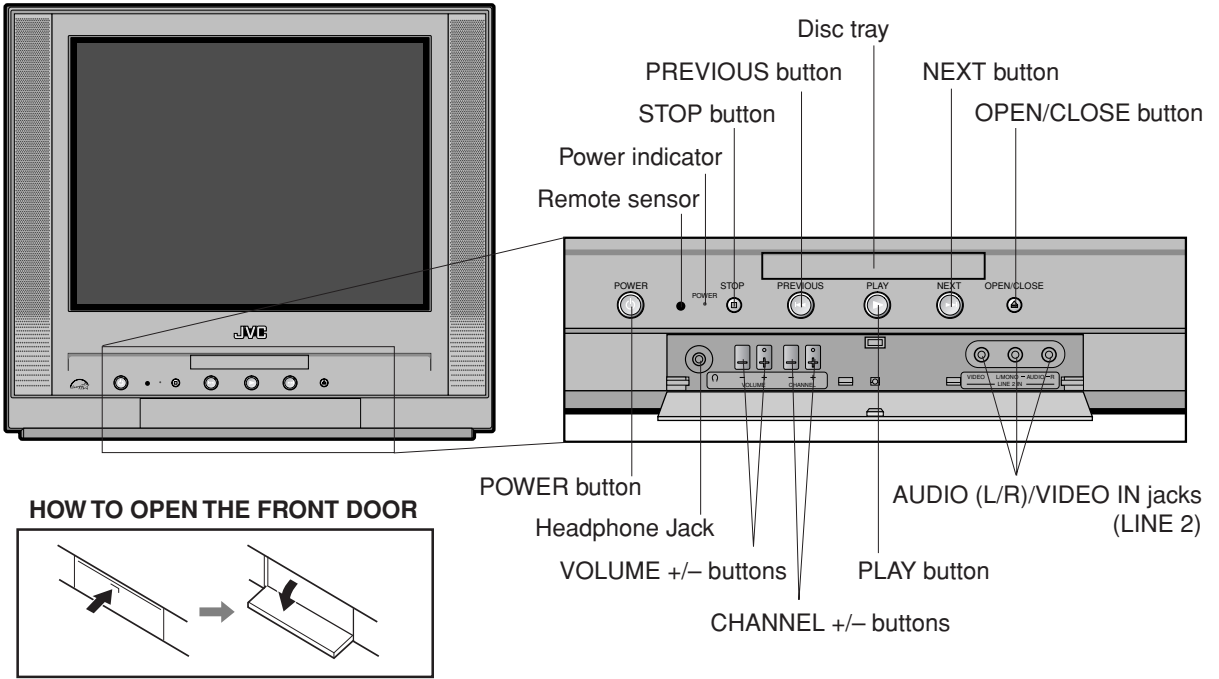

## Rear

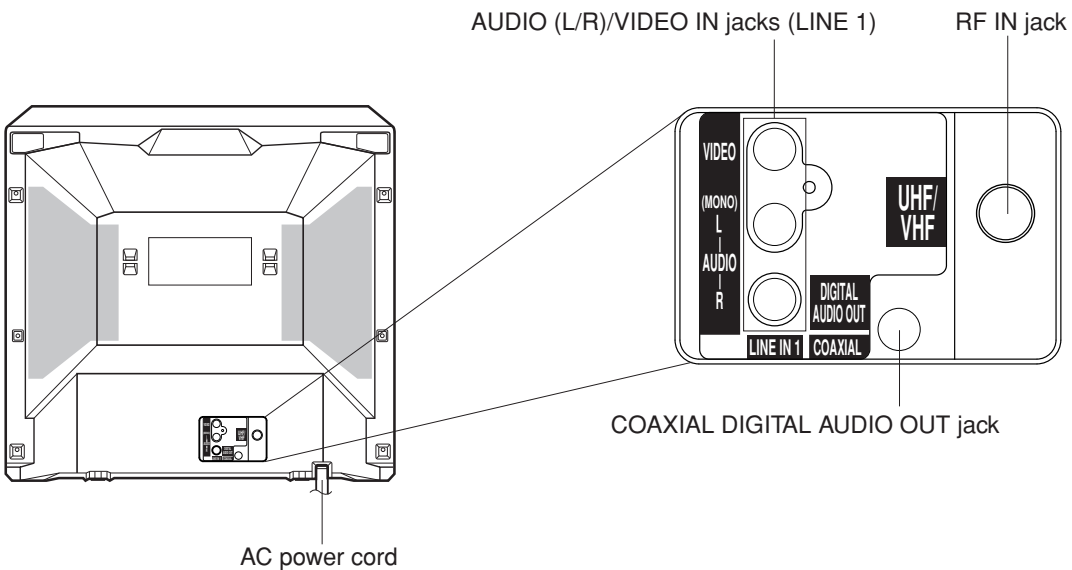



# Remote control

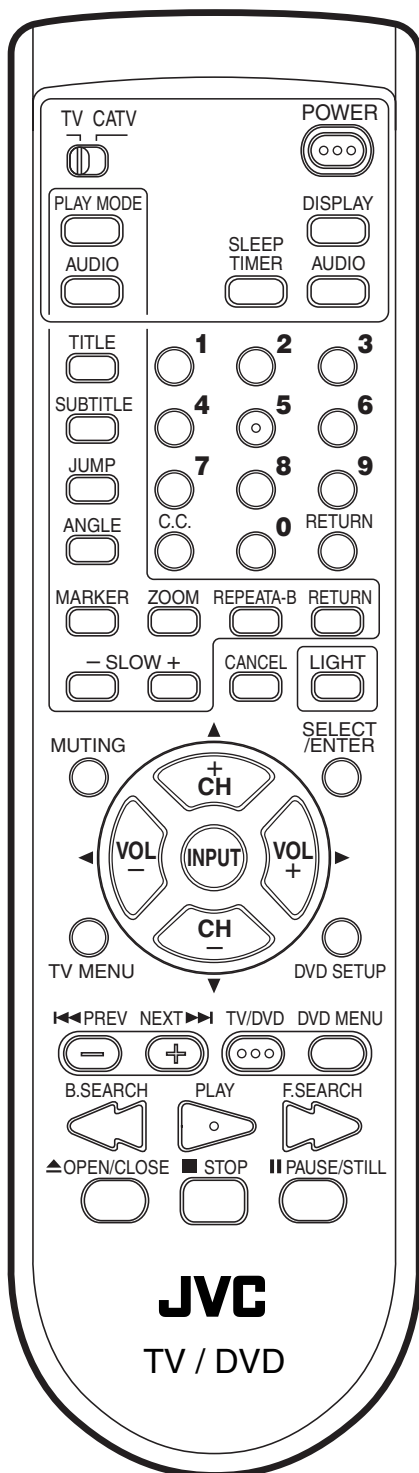

		Page
TV/CATV switch	Switch to operate TV or CATV	10,48
POWER	Power on/off	10,13,14,26
PLAY MODE	Select playback mode	31
DISPLAY	Call information	15,26
AUDIO (for DVD)	Change sound track language of DVD	33
SLEEP TIMER	Set sleep timer	15
AUDIO (for TV)	Switch the sound of TV	23
TITLE	Select title	34
0-9	Direct channel selection of TV Input setting Enter a password	14,18 29~31 19,21,38~40
SUBTITLE	Set Subtitle	33
JUMP	Locating desired scene	30
ANGLE	Change playback angle	34
C.C.	Switch between TV/Caption/Text in Closed Caption mode	16
RETURN (for TV)	Switch between present/last channels	15
MARKER	Index	32
ZOOM	Zoom	30
REPEAT A-B	Repeat playback between A and B	31
RETURN (for DVD)	Remove DVD set up menu	35~40
SLOW +/-	Forward/Reverse-slow motion	28
CANCEL	Reset information in the menu	22,24,30~32,38,39
LIGHT	Turn the illumination on for CH and VOL	10
MUTING	Turn the sound on and off	14
SELECT/ENTER	Enter information in the menu Select option in the menu	13,19,21, 27,29~32,34~40
CH +/- (▲▼)	Select channel of TV Cursor buttons	10,15 13,17~22,24,27,29,30,32,34~39
VOL +/- (◀▶)	Adjust volume Cursor buttons	10,14 13,17~22,24,27,29,30,32,34~39
INPUT	Switch between TV channel/LINE	43
TV MENU	Display menu of TV setup	13,17~22,24
DVD SETUP	Display menu of DVD setup	35~39
PREV/NEXT	Skip chapter to forward or reverse direction	28
TV/DVD	Switch between the TV mode/DVD mode	10,26
DVD MENU	Display menu of DVD software	34
B.SEARCH/F.SEARCH	Fast Forward/Review playback	28
PLAY	Playback	27~29,31,34,40
OPEN/CLOSE	Open the tray/ Close the tray	27,29,40
STOP	Stop	27,29,31
PAUSE/STILL	Pause CD sound/Still picture of DVD	28

# Remote control

## Inserting Batteries

- 1 Slide the battery compartment cover in the direction of the arrow.

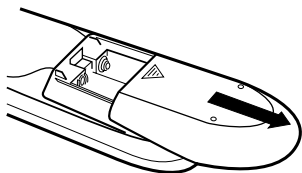

- 2 Install two "AA" batteries (supplied), paying attention to the polarity diagram in the battery compartment.

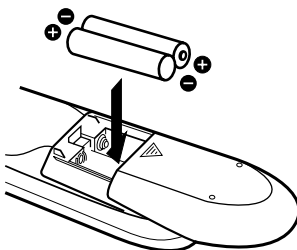

- 3 Replace the compartment cover.

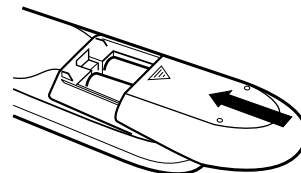

## BATTERY PRECAUTIONS

The precautions below should be followed when using batteries in this device:

1. Use only the size and type of batteries specified.
2. Be sure to follow the correct polarity when installing the batteries as indicated in the battery compartment. Reversed batteries may cause damage to the device. To avoid a potential short circuit, insert the "–" end first.
3. Do not mix different types of batteries together (e.g. Alkaline and Carbon-zinc) or old batteries with fresh ones.
4. If the device is not to be used for a long period of time, remove the batteries to prevent damage or injury from possible battery leakage.
5. Do not try to recharge batteries not intended to be recharged; they can overheat and rupture. (Follow battery manufacturer's directions.)
6. When you change the batteries, try to complete the task within three minutes. If you take longer than three minutes, the remote control codes for your Cable Box may have to be reset (see page 48).

## REMOTE CONTROL BASICS

- Before you can operate the remote control, you must first install the batteries (included). See "Inserting Batteries" on this page above for instructions.
- Press the POWER button to turn the television on or off.
- Make sure the TV/CATV switch is set to TV. Move the switch to CATV only if you need to operate a cable box. (You must set the remote control to operate a cable box. Please see page 48 for instructions.)
- Press the CH + and CH – buttons to scan through the channels. Tap the CH + or CH – button to move through the channels one channel at a time.
- Press VOL + or VOL – to raise or lower the volume. An indicator bar will appear on screen to show you the television volume level.
- The CH +/- and VOL +/- buttons are also used to navigate JVC's on screen menu system.
- You can directly access specific channels using the 10-key pad.
- This remote includes illuminated buttons for key features like CH +/- buttons, and VOL +/- buttons. Press the LIGHT button to turn the illumination on.
- Each press of TV/DVD on the remote control, switches the screen between the TV screen (TV mode) and the DVD screen (DVD mode). You can operate a TV and TV menu in the TV mode, and a DVD and DVD SETUP menu in the DVD mode.

## Operation

- Aim the remote control at the remote sensor and press control buttons to operate.
- Operate the remote control within 30° angle on either side of the remote sensor, up to a distance of Approx. 5 meters.

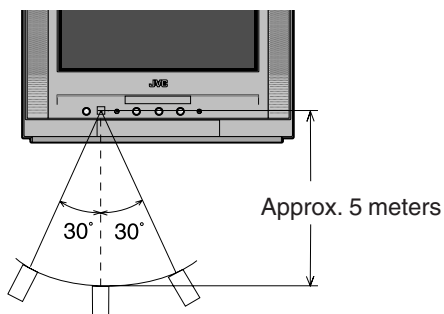

# Antenna connections

If you are using an indoor or outdoor antenna, follow the instructions below that correspond to your antenna system. If you are using a cable TV service (CATV), see page 12 for Cable TV connections.

## Combination VHF/UHF Antenna (Single 75 ohm Cable or 300 ohm Twin-lead Wire)

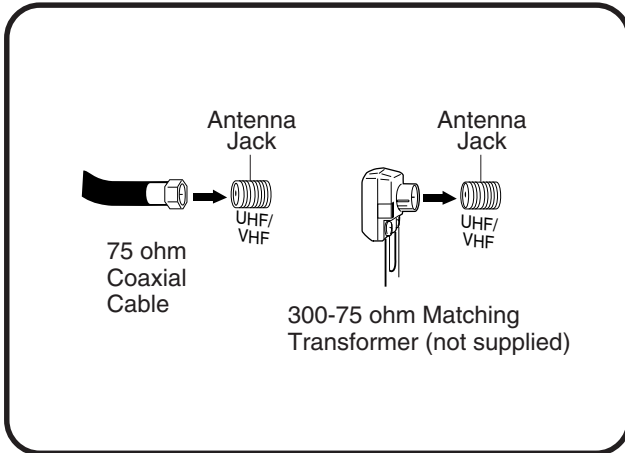

Connect the 75 ohm Cable from the Combination VHF/UHF Antenna to the Antenna Jack.

If your Combination VHF/UHF Antenna has a 300 ohm Twin-lead Wire, the use of the 300-75 ohm Matching Transformer may be necessary.

## Combination VHF/UHF Antenna (Separate VHF and UHF 300 ohm Twin-lead Wires)

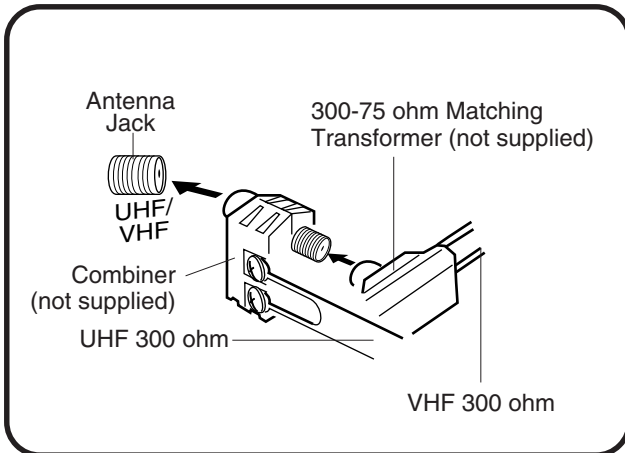

Connect the UHF 300 ohm Twin-lead Wire to the Combiner (not supplied). Connect the VHF 300 ohm Twin-lead Wire to the 300-75 ohm Matching Transformer. Attach the Transformer to the Combiner, then attach the Combiner to the Antenna Jack.

## Separate VHF/UHF Antennas (75 ohm VHF Cable and 300 ohm UHF Twin-lead Wires)

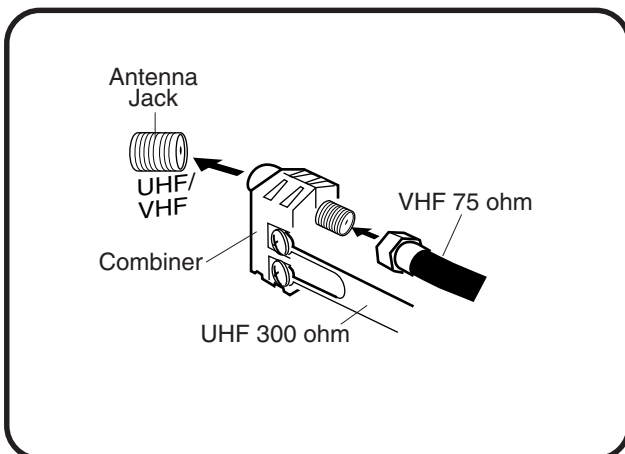

Connect the VHF 75 ohm cable and UHF 300 ohm Twin-lead Wire to the Combiner. Attach the Combiner to the Antenna Jack.

# Cable TV connections

This TV/DVD has an extended tuning range and can tune most cable channels without using a Cable TV Converter box. Some cable companies offer "premium pay channels" in which the signal is scrambled. Descrambling these signals for normal viewing requires the use of a descrambler device which is generally provided by the cable company.

## FOR SUBSCRIBERS TO BASIC CABLE TV SERVICE

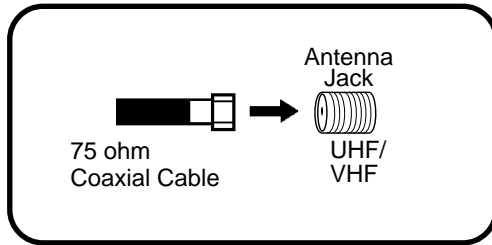

For basic cable service not requiring a Converter/Descrambler box, connect the CATV 75 ohm Coaxial Cable directly to the Antenna Jack on the back of the TV/DVD.

## FOR SUBSCRIBERS TO SCRAMBLED CABLE TV SERVICE

If you subscribe to a cable TV service which requires the use of a Converter/Descrambler box, connect the incoming 75 ohm Coaxial Cable to the Converter/Descrambler box. Using another 75 ohm Coaxial Cable, connect the output jack of the Converter/Descrambler box to the Antenna Jack on the TV/DVD. Follow the connections shown below. Set the TV/DVD to the output channel of the Converter/Descrambler box (usually channel 3 or 4) and use the Converter/Descrambler box to select channels.

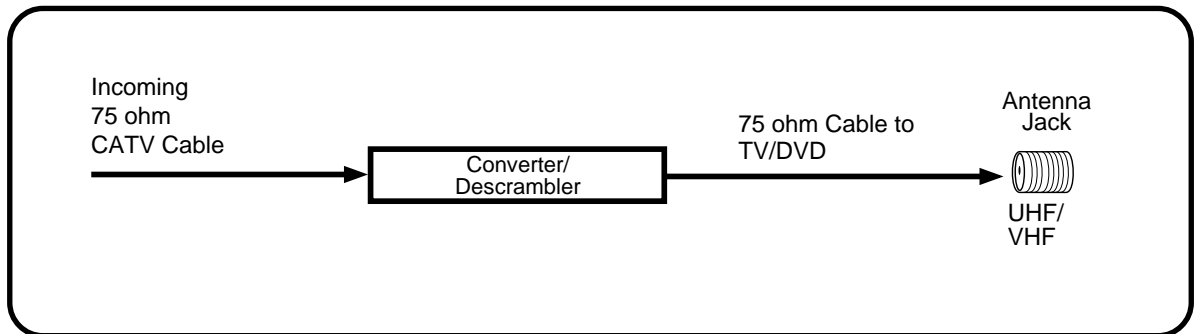

## FOR SUBSCRIBERS TO UNSCRAMBLED BASIC CABLE TV SERVICE WITH SCRAMBLED PREMIUM CHANNELS

If you subscribe to a cable TV service in which basic channels are unscrambled and premium channels require the use of a Converter/Descrambler box, you may wish to use a signal Splitter and an A/B Switch box (available from the Cable company or an electronics supply store). Follow the connections shown below. With the switch in the "B" position, you can directly tune any nonscrambled channels on your TV/DVD. With the switch in the "A" position, tune your TV/DVD to the output of the Converter/Descrambler box (usually channel 3 or 4) and use the Converter/Descrambler box to tune scrambled channels.

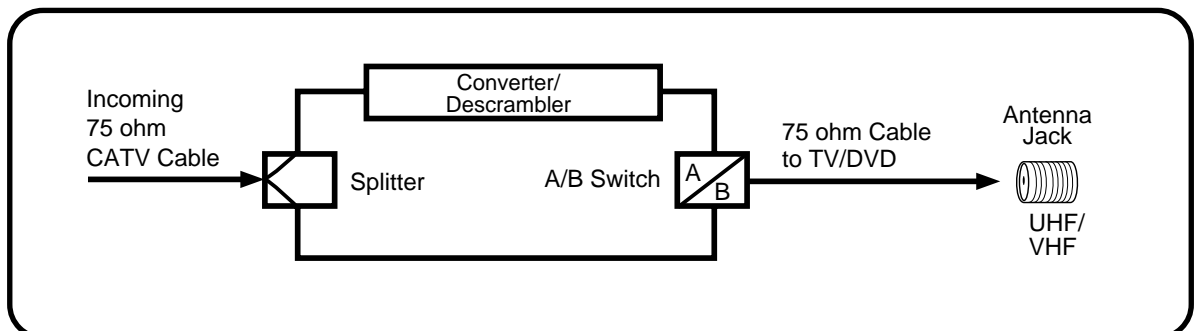

# Setting the language

You can choose from three different languages (English, French and Spanish) for the on-screen displays. Adjustment menus and messages will appear in the language of your choice. On-screen language selection (step 5) will automatically appear on the screen when you press the MENU button initially. Select the language you prefer first, then proceed with the other menu options.

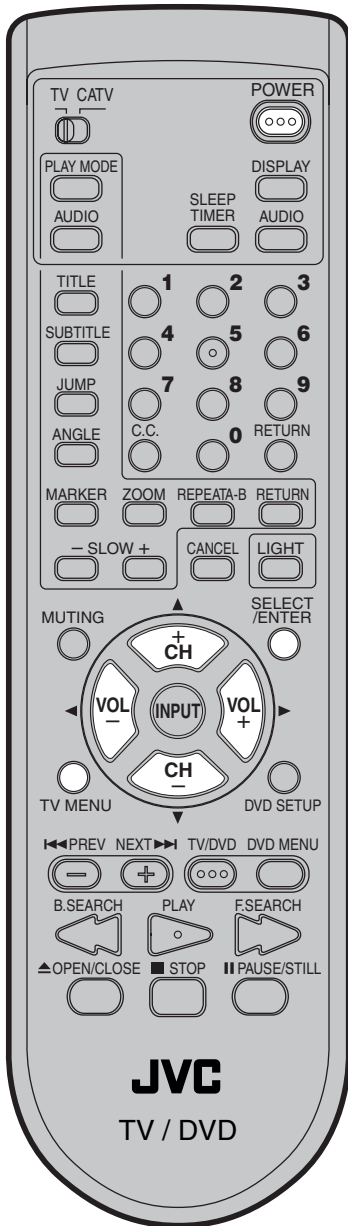

**1** To turn on the TV/DVD, press **POWER**. The Power indicator will light.

**2** Press **TV MENU**. The TV menu screen will appear.

**3** Press **◀** or **▶** until the SET-UP menu appears.



**4** Press **▲** or **▼** to select the "LANGUAGE" option, then press **◀** or **▶** button.



**5** Press **▲** or **▼** to select the desired language: English (ENGLISH), Spanish (ESPAÑOL) or French (FRANCAIS), then press **ENTER**.

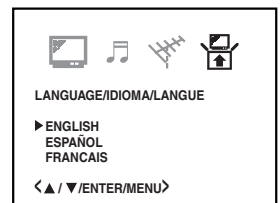

Press **TV MENU** until the MENU screen is cleared.

## NOTE:

- If the unit does not operate properly, or No key operation (by the unit and/or the remote control): Static electricity, etc., may affect the player's operation. Disconnect the AC power cord once, then connect it again.
- The TV section has its own menu and also DVD section has its own menu (see page 35).

# TV operation

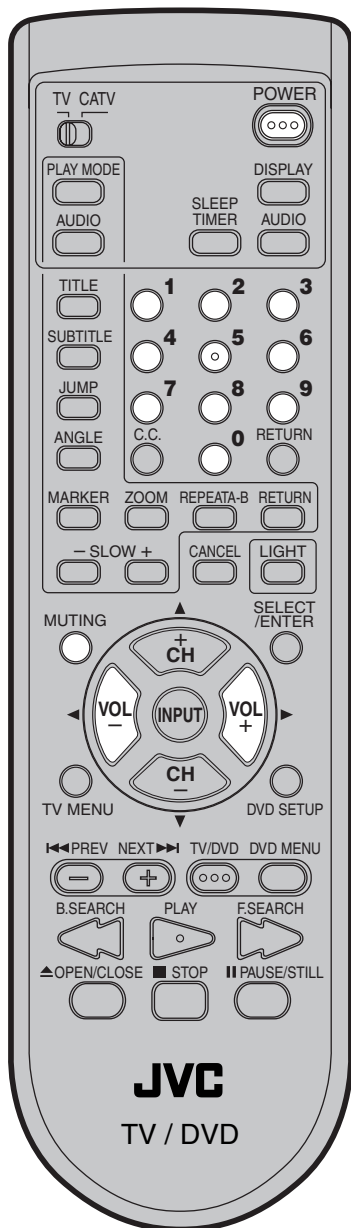

- 1 To turn on the TV/DVD, press **POWER**.
- 2 Adjust the volume level by pressing **VOL +** or **-**. The volume level will be indicated on the screen by green bars. As the volume level increases, so do the number of bars. If the volume decreases, the number of green bars also decreases.

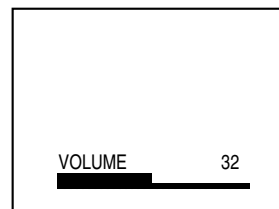

- 3 Set the TV/CATV menu option to the appropriate position. (See page 17.)

TV - VHF/UHF channels  
CATV - CABLE TV channels

- 4 Press the Direct Channel selection buttons to select the channel.  
**TV Mode Direct Channel Selection**  
When the TV/CATV menu option is in the TV position, all channels can be instantly selected by using two buttons. (for example, to select channel 2, press "0", then "2". If you press only "2", channel selection will be delayed for a few seconds.) For channels 10 and above, press the 2 digits in order.

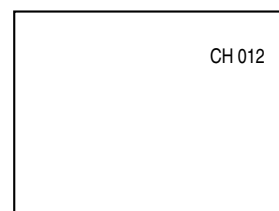

## CATV Mode Direct Channel Selection

When the TV/CATV menu option is in the CATV position, channels can be selected as follows:

### TO SELECT CATV CHANNELS:

- 1-9: Press "0" twice, then 1-9 as needed. Example, to select channel 2, press "002".
- 10-12: Press "0", then the remaining 2 digits. Example, to select channel 12, press "012".
- 13-99: Press the 2 digits in order. Example, to select channel 36, press "36".
- 100-125: Press the 3 digits in order. Example, to select channel 120, press "120".

### NOTE FOR CHANNELS 1-12:

If only 1 or 2 buttons are pressed, the corresponding channel will be selected in 2 seconds.

## MUTING

The **MUTING** button instantly turns the volume down completely when you press it.

Press **MUTING** button and the volume level will instantly go to zero. To restore the volume to its previous level, press **MUTING** button again.

## NOTES:

- If a channel with no broadcast is selected, the sound will automatically be muted.
- If a station being viewed stops broadcasting, the TV will automatically shut itself off after 15 minutes.

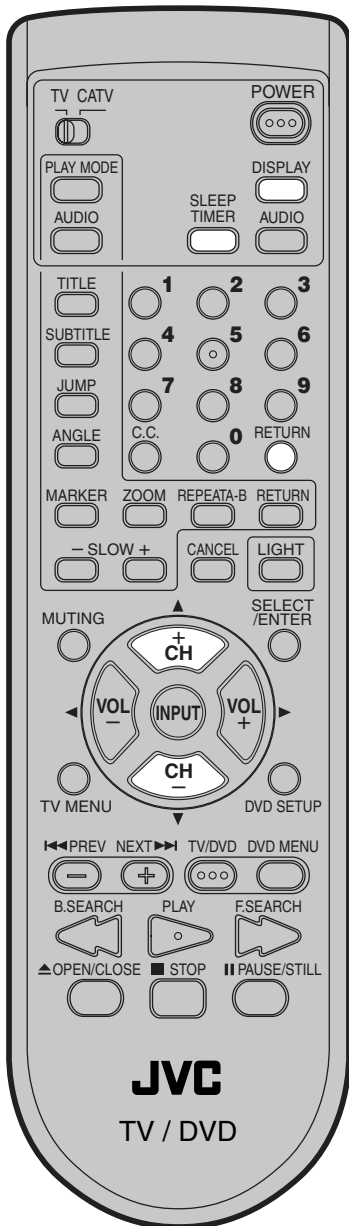

## CHANNEL UP/DOWN

Press and release **CH +** or **-**. The channel automatically stops at the next channel set into memory.

For proper operation, before selecting channels, they should be set into the memory. See pages 17 and 18 "To memorize channels"

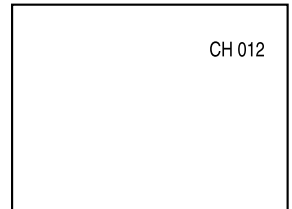

## DISPLAY

Press **DISPLAY** to display the current informations on the screen. Press **DISPLAY** again to disappear the call display.

- Channel number or VIDEO mode
- Stereo or SAP (second audio program) audio status
- Audio output status

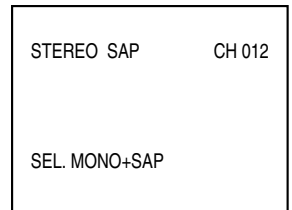

## RETURN

This button allows you to go back to the last channel selected by pressing **RETURN**. Press **RETURN** again to return to the last channel you were watching.

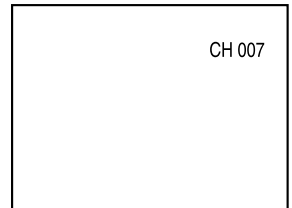

## SLEEP TIMER

To set the TV/DVD to turn off after a preset amount of time, press **SLEEP TIMER** on the remote control. The clock will count down 10 minutes for each press of **SLEEP TIMER** (120, 110, ...10, 0). After the sleep time is programmed, the display will appear briefly every ten minutes to remind you that the sleep timer is operating. To confirm the sleep timer setting, press **SLEEP TIMER** and the remaining time will be displayed for a few seconds. To cancel the sleep timer, press **SLEEP TIMER** repeatedly until the display turns to 0.

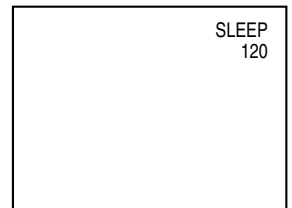

# Closed captions

## WHAT IS CLOSED CAPTIONING?

This television has the capability to decode and display Closed Captioned television programs. Closed Captioning will display text on the screen for hearing impaired viewers or it will translate and display text in another language.

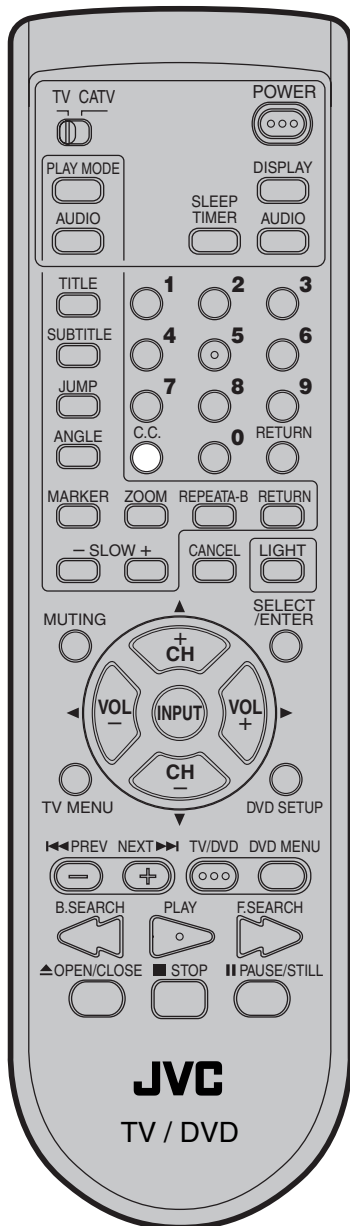

**Captions:** This Closed Caption Mode will display text on the screen in English or another language (depending on the setting of the Closed Captions CH 1/2).

Generally, Closed Captions in English are transmitted on Captions Channel 1 and Closed Captions in other languages are transmitted on Captions Channel 2.

**Text:** The Text Closed Caption Mode will usually fill the screen with a programming schedule or other information.

After selecting a Closed Caption Mode, it will stay in effect until it is changed, even if the channel is changed.

If the Captions signal is lost due to a commercial or a break in the signal, the Captions will reappear when the signal is received again. If the channels are changed, the Captions will be delayed approximately 10 seconds. The Captions will appear in places on the screen where they will least interfere with the picture, usually on the bottom of the screen. News programs will usually show three-line Closed Captions which scroll onto the screen.

Most other shows provide two or three lined Captions placed near the character who is speaking so the viewer can follow the dialogue. Words in italics or underlined describe titles, words in foreign languages or words requiring emphasis. Words that are sung usually appear enclosed by musical notes.

For television programs broadcasting with Closed Captions, look in your TV guide for the Closed Captions symbol (CC).

## TO VIEW CLOSED CAPTIONS

Press **C.C.** to switch between normal TV and the two closed caption modes (captions and full screen text). Closed captioning will display text on the screen for hearing impaired viewers.

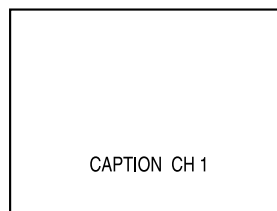

## NOTES:

- When selecting Closed Captions, the captioning will be delayed approximately 10 seconds.
- If no caption signal is received, no captions will appear, but the television will remain in the Caption Mode.
- Misspellings or unusual characters may occasionally appear during Closed Captioning. This is normal with Closed Captioning, especially with live programs. This is because during live programs, captions are also entered live. These transmissions do not allow time for editing.
- When Captions are being displayed, on-screen displays, such as volume and mute may not be seen or may interfere with Closed Captions.
- Some cable systems and copy protection systems may interfere with the Closed Captioned signal.
- If using an indoor antenna or if TV reception is very poor, the Closed Caption Decoder may not appear or may appear with strange characters or misspelled words. In this case, adjust the antenna for better reception or use an outdoor antenna.



# To memorize channels

This TV/DVD is equipped with a channel memory feature which allows channels to skip up or down to the next channel set into memory, skipping over unwanted channels. Before selecting channels, they must be programmed into the TV/DVD's memory. In addition to normal VHF and UHF channels, this TV/DVD can receive up to 113 Cable TV channels. To use this TV/DVD with an antenna, set the TV/CATV menu option to the TV mode. When shipped from the factory, this menu option is in the CATV mode.

## TV/CATV SELECTION

1 Press **TV MENU** in the TV mode.  
The TV menu screen will appear.

2 Press **◀** or **▶** until the CHANNEL-  
SETUP menu appears.

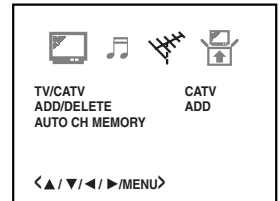

3 Press **▲** or **▼** to select the "TV/  
CATV".

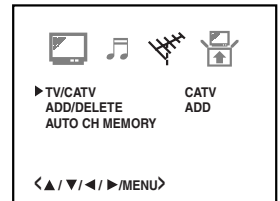

4 Press **◀** or **▶** to select the TV  
or CATV mode.

**TV - VHF/UHF channels**  
**CATV - CABLE TV channels**

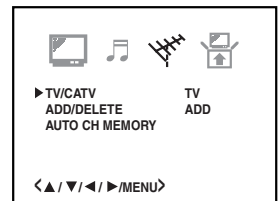

5 Press **TV MENU** until the MENU  
screen is cleared.

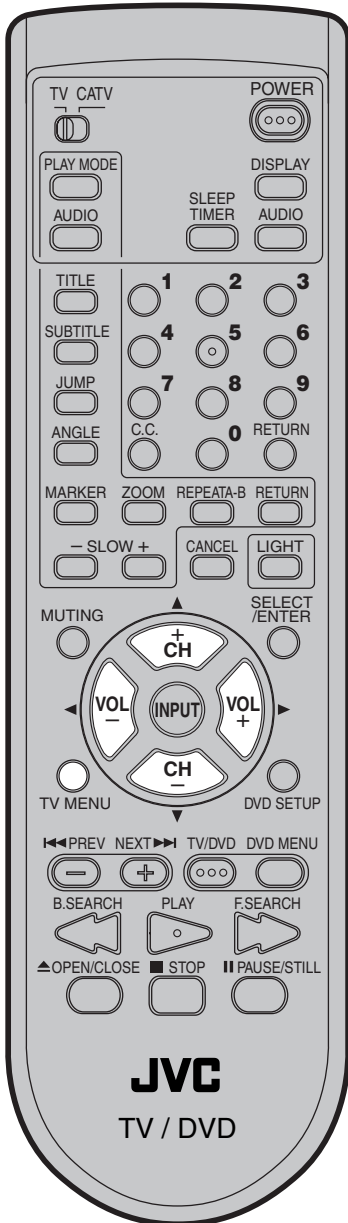

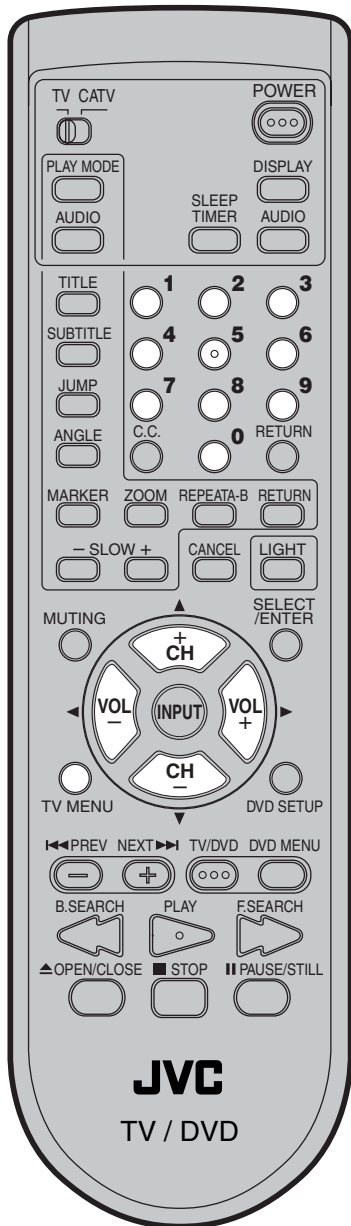

## AUTOMATIC MEMORY TUNING

- 1 Press **TV MENU** in the TV mode. The TV menu screen will appear.
- 2 Press **◀** or **▶** until CHANNEL-SETUP menu appears.

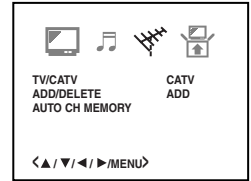

- 3 Press **▲** or **▼** to select the "AUTO CH MEMORY", then press **◀** or **▶**. The TV will begin memorizing all the channels available in your area.

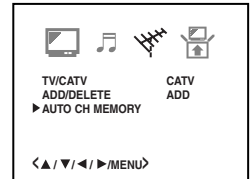

- 4 Press **TV MENU** until the MENU screen is cleared.

## TO ADD/DELETE CHANNELS

- 1 Select the desired channel to be memorized or deleted using **Direct Channel Selection (0-9)**, or **CH +** or **-**.

- 2 Press **TV MENU** in the TV mode. The TV menu screen will appear.

- 3 Press **◀** or **▶** until CHANNEL-SETUP menu appears.

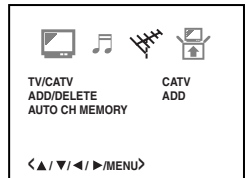

- 4 Press **▲** or **▼** to select the "ADD/DELETE".

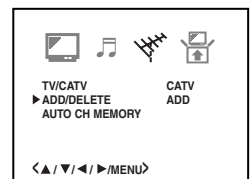

- 5 Press **◀** or **▶** to select ADD or DELETE, whichever function you want to perform.

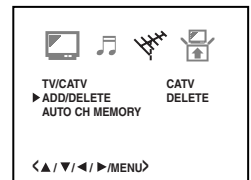

- 6 Press **TV MENU** until the MENU screen is cleared.

- 7 Repeat steps 1-6 for other channels you want to add or delete.

# Setting the V-Chip

An age limitation can be set to forbid children to see and hear violent scenes or pictures for adults, etc. The TV/DVD corresponds to "TV RATING" and "MOVIE RATING". To use the V-Chip function, you must register a password.

## TO REGISTER PASSWORD

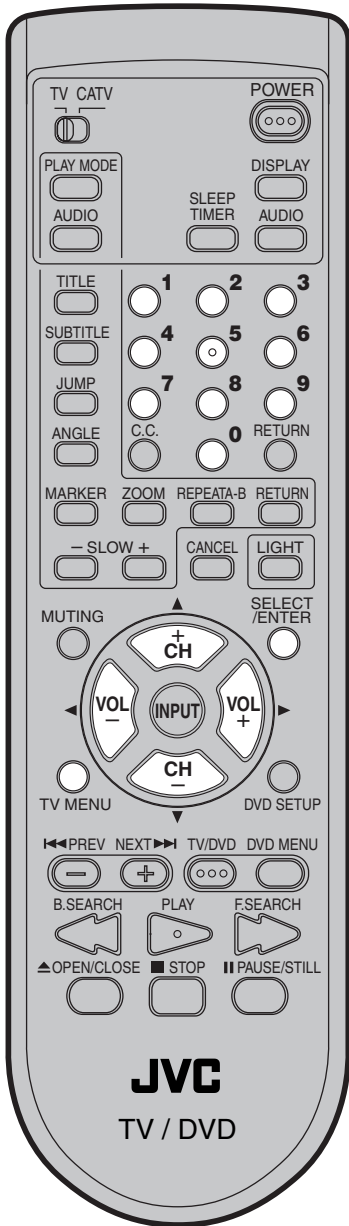

1 Press **TV MENU** in the TV mode. The TV menu screen will appear.

2 Press ◀ or ▶ until the **SETUP** menu appears.



3 Press ▲ or ▼ to select the "V-CHIP SET", then press ◀ or ▶.



4 Enter the password (4 digits) using **Direct Channel Selection (0-9)**, then press **ENTER**.

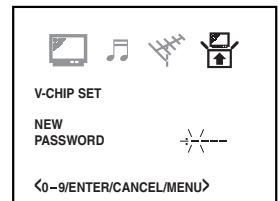

"\*" appears instead of the number.

5 Enter the same password again for the safety, then press **ENTER**. Now the password was registered and V-Chip setting menu will appear on the display.

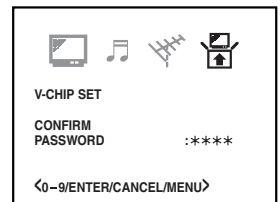

### NOTES:

- If you forget the password, you cannot set the V-Chip.
- To avoid forgetting the password, write it down and keep in the safe place.



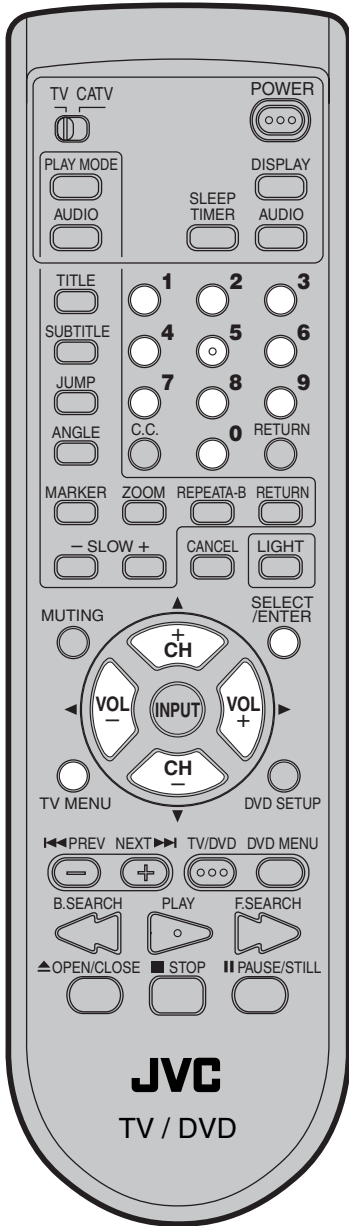

5 Press ▲ or ▼ to select “V-CHIP”. Press ◀ or ▶ to display “ON” to activate the V-Chip function.

6 Press **TV MENU** until the MENU screen is cleared.

### TO CHANGE PASSWORD

1 Press **TV MENU** in the TV mode. The TV menu screen will appear.

2 Press ◀ or ▶ until **SETUP** menu appears.

3 Press ▲ or ▼ to select the “V-CHIP SET”, then press ◀ or ▶.

4 Enter the Password using **Direct Channel Selection (0-9)**, then press **ENTER**.

5 Press ▲ or ▼ to select “CHANGE PASSWORD”, then press ◀ or ▶.

6 Enter the new password using **Direct Channel Selection (0-9)**, then press **ENTER**.

7 Enter the same password again for safety, then press **ENTER**.

8 Press **TV MENU** repeatedly to return to normal screen.

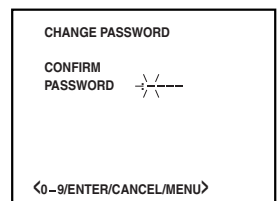
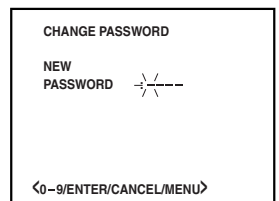
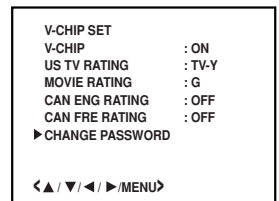
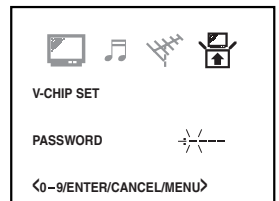
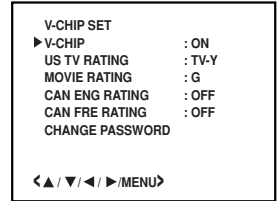

# Picture control adjustment

Picture controls are factory preset but you can adjust them individually as follows:

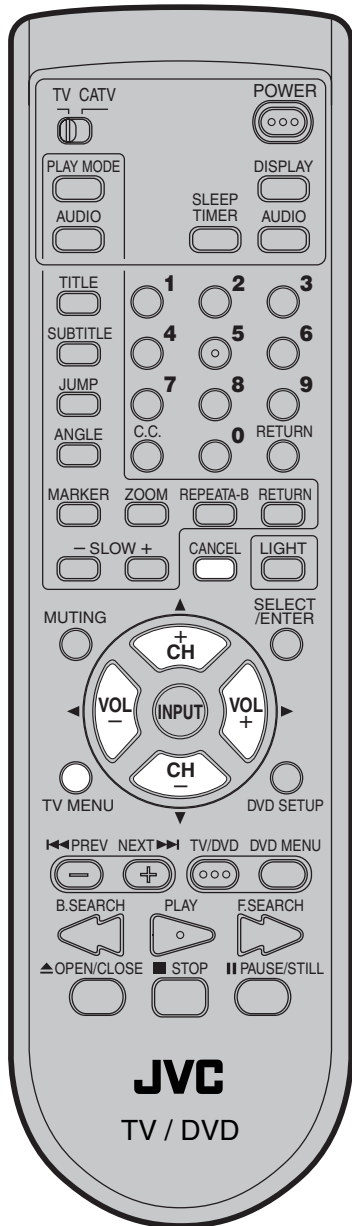

1 Press **TV MENU** in the TV mode. The TV menu screen will appear.

2 Press **◀** or **▶** until PICTURE menu appears.

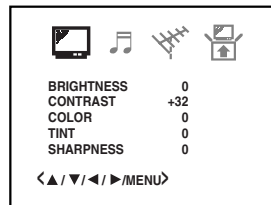

3 Press **▲** or **▼** to select the item you want to adjust.

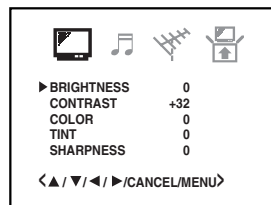

4 Press **◀** or **▶** to adjust the setting.

	▶	◀
<b>BRIGHTNESS</b>	increase brightness	decrease brightness
<b>CONTRAST</b>	increase contrast	decrease contrast
<b>COLOR</b>	be brilliant color	be pale color
<b>TINT</b>	be greenish color	be reddish color
<b>SHARPNESS</b>	makes picture clearer	makes picture softer

5 After your desired setting press **TV MENU** until the MENU screen is cleared.

## CANCEL

Pressing **CANCEL** while making picture adjustments will return all adjustments to the factory preset levels.

## NOTE:

The **CONTRAST** default setting is set to maximum at the factory.

# Stereo and separate audio program (SAP)

The TV/DVD is equipped with a feature known as Multi-channel TV Sound or MTS. MTS broadcasts greatly enhance TV viewing by bringing you programs with high fidelity stereo sound. MTS also provides an extra channel called the Separate Audio Program or SAP which broadcasters can use to transmit a second language for bilingual transmission or for other purposes.

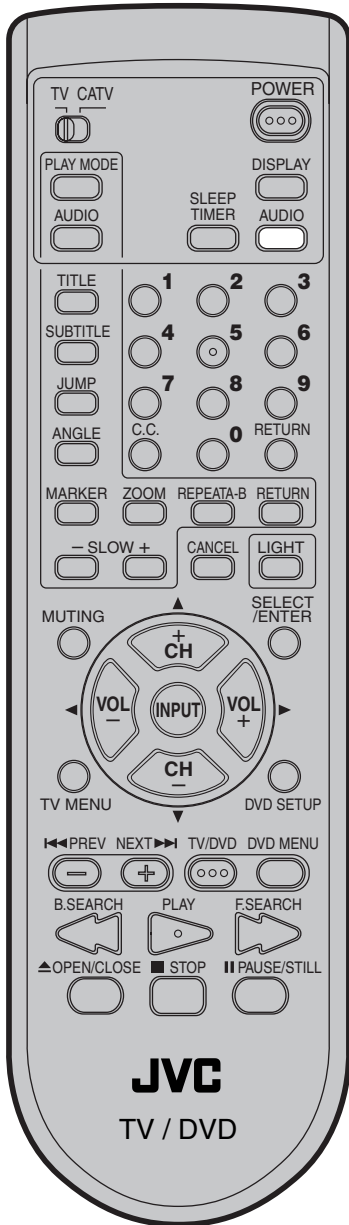

## LISTENING TO STEREO SOUND

When the TV is turned on or a channel selection is made, make certain the STEREO appears on the screen. This means that "Stereo" broadcasting is available. You can enjoy stereo sound from the left and right speakers.

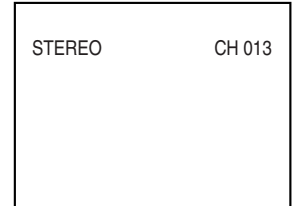

- When "Mono" broadcasting is received, no indication is displayed.
- If the broadcast signal is not strong enough or clear stereo sound is not available, press **AUDIO** on the center of the remote control to change to mono sound. The noise should be eliminated. Press it again to return to the stereo sound.

## LISTENING TO SAP (SEPARATE AUDIO PROGRAM)

When the TV is turned on or a channel selection is made, make certain the SAP appears on the screen. This means that the "Separate Audio Program" broadcasting is available.

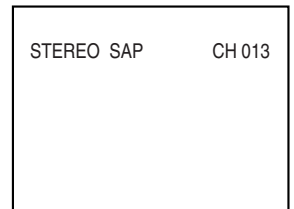

## TO SELECT DESIRED SOUND

Press **AUDIO** to select the desired sound.

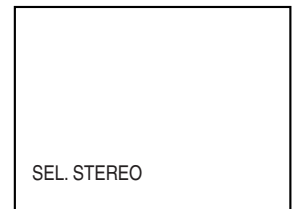

## MONO+SAP BROADCASTING

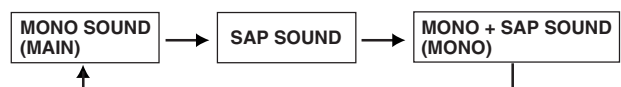

## STEREO+SAP BROADCASTING

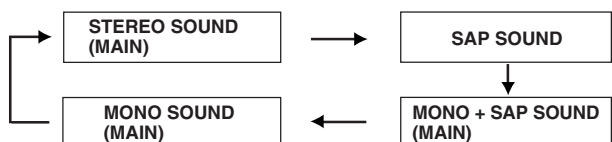

# Sound control adjustment

Sound controls are factory preset but you can adjust them individually as follows:

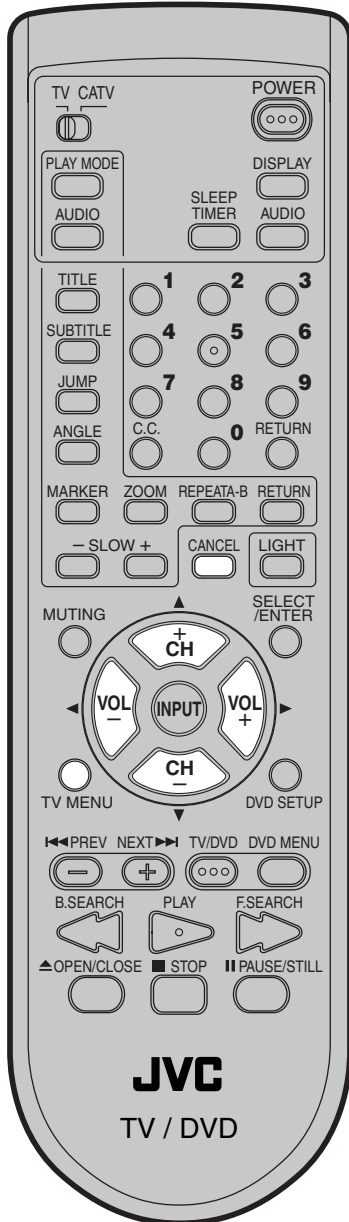

1 Press **TV MENU** in the TV mode.  
The TV menu screen will appear.

2 Press ◀ or ▶ until the **AUDIO** menu appears.

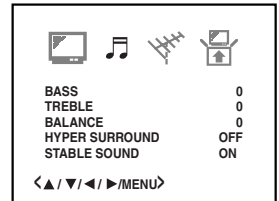

3 Press ▲ or ▼ to select the item you want to adjust.

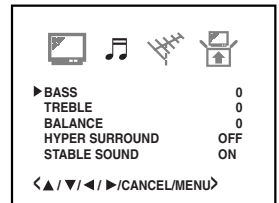

4 Press ◀ or ▶ to adjust the setting.

#### **BASS:**

Press ◀ or ▶ to adjust the bass sound.

#### **TREBLE:**

Press ◀ or ▶ to adjust the treble sound.

#### **BALANCE:**

Press ◀ or ▶ to obtain an equal sound level from both speakers.

#### **HYPER SURROUND:**

Press ◀ or ▶ to set the hyper surround feature "ON" or "OFF".

#### **STABLE SOUND:**

Press ◀ or ▶ to set the stable sound feature "ON" or "OFF".

#### **Hyper surround feature**

The hyper surround feature expands the audio listening field wider and deeper to create exceptional sound quality from the TV's speakers. The feature uses stereo signals from a TV broadcast or video input.

#### **Stable sound feature**

When the loud sound is made, the stable sound feature automatically lower the sound.



5 After your desired setting press **TV MENU** until the MENU screen is cleared.

#### **CANCEL**

Pressing **CANCEL** while making sound adjustments will return all adjustments to the factory preset levels.



The following types of discs can be played on this unit.

Disc type and logo mark	Recorded content	Disc size
DVD Video 	Audio + Video	5 inches (12 cm)
		3 inches (8 cm)
Audio CD 	Audio	5 inches (12 cm)
		3 inches (8 cm)
CD-R/CD-RW 	CD-DA/MP3 file	5 inches (12 cm)
		3 inches (8 cm)

- DVD-ROM, Video CD, SVCD, CVD, Photo CD, etc. cannot be played.
- Some CD-R/RWs can not be played back depending on the recording conditions.
- This unit is to be used exclusively with the NTSC color system. PAL and SECAM system discs cannot be used with this unit.

## Region Number

Region number (Regional restriction code) is built-in to the unit and DVD video discs. Region number "1" or "ALL" of DVD video discs can be used on this unit.



## Title

When two or more movies are recorded on a disc, the disc is divided into two or more sections. Each section is called a "TITLE".

## Chapter

The titles can be subdivided into many sections. Each section is called a "CHAPTER".

## Audio CD Track

An Audio CD can contain several items. These are assigned to the tracks.

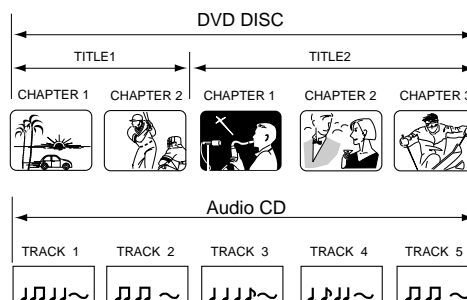

## Removing Disc from Case

Be sure to hold the edge of disc. Do not touch the surface of the disc. Pick up the disc gently from the case.

- Do not scratch the disc.
- Do not get dirt on the surface of the disc.
- Do not stick a label or adhesive tape on the disc.
- Do not drop or bend the disc.

## Storing Disc

- Store the disc in the case to avoid risk of scratches, dirt or damage.
- Do not leave disc exposed to direct sunlight or in hot or humid places.

## Cleaning Disc

- Wipe the disc with a clean, dry cloth from center to edge.
- Do not wipe the disc round.
- Do not use liquid or aerosol cleaners.

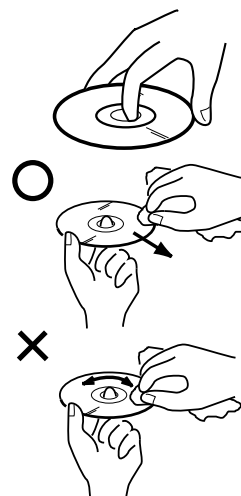

# Preparation/Status display of disc

The following pages describe the setup/operation in DVD mode.

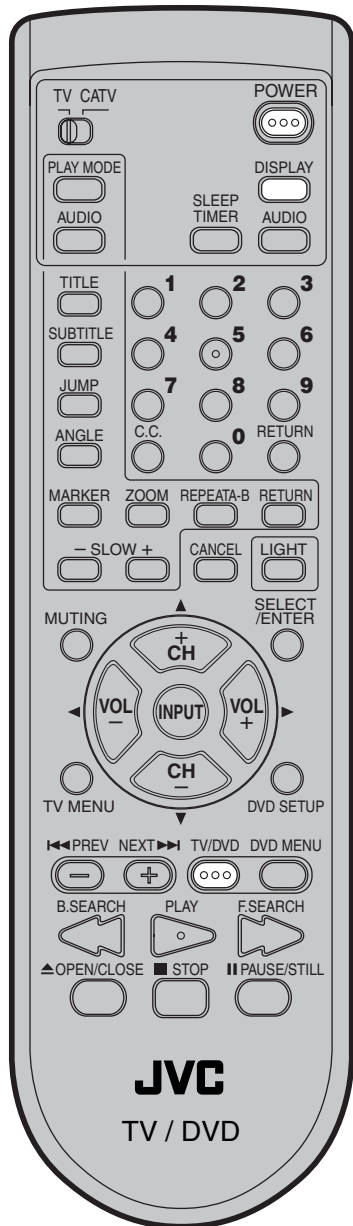

## NOTE:

**If the unit does not operate properly:** Static electricity, etc., may affect the player's operation. Disconnect the AC power cord once, then connect it again.

## Preparation

Before DVD/CD operation, please make preparations as follows.

- 1 Insert the AC cord plug into a standard 120V 60Hz polarized AC outlet.
  - If the AC cord plug is plugged in for the first time, wait for about 5 seconds before pressing **POWER**.
- NOTE:** When connecting to other equipment, unplug the unit from the AC outlet.
- 2 Press **POWER** on the unit or on the remote control to turn on the unit. The POWER indicator will light.
  - Every time you press **POWER**, the TV/DVD starts from TV mode.
  - When using an amplifier, switch on the amplifier.
- 3 Press **TV/DVD** to select DVD mode. The DVD startup screen will appear on the screen.



## Status display of disc

Press **DISPLAY**. The status display of the disc will appear on the screen.

### DVD

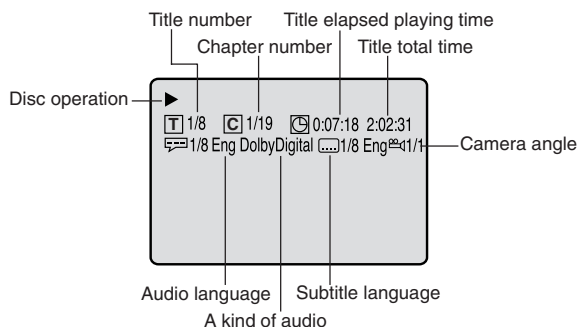

To make status display disappear, press **DISPLAY** again.

### Audio CD

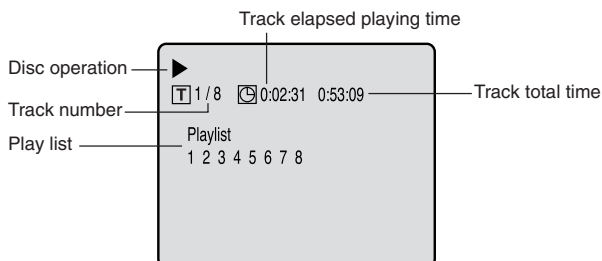

- When you play a CD disc, the status display will appear and remain on the screen.

# Playback procedure

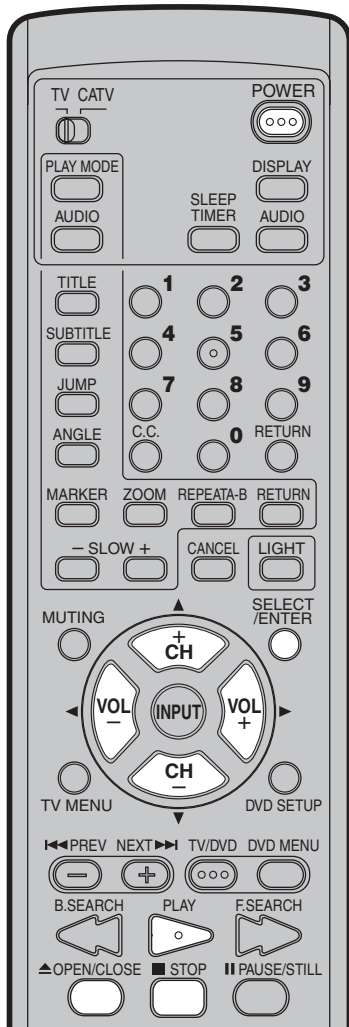

- 1 Press **OPEN/CLOSE** on the unit or the remote control. The disc tray will open.

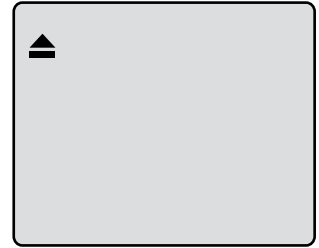

- 2 Place a disc onto the tray. Position it with the printed label side up, align it with the guides, and place it in its proper position.

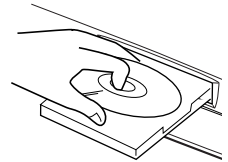

- 3 Press **OPEN/CLOSE** or **PLAY**. The disc tray closes automatically. On the TV-screen, “▲” changes to “Ⓢ” and then playback commences.

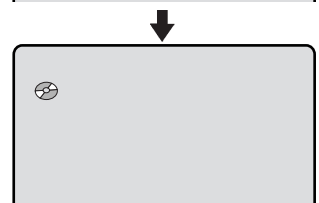
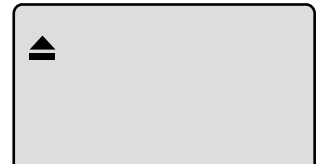

- A menu screen will appear on the TV screen, if the disc has a menu feature.

- 4 Press ▲/▼ or ◀/▶ to make a selection.

- 5 Press **SELECT**.
  - Title is selected and play commences.

- 6 Press **STOP** to end playback.
  - The unit memorizes the stopped point, depending on the disc. “■” appears on the screen. Press **PLAY** to resume playback (from the scene point).
  - If you press **STOP** again or unload the disc (“■” appears on the screen.), the unit will clear the stopped point.

- 7 To stop the playback, press **STOP**. Then press **OPEN/CLOSE**. The disc tray opens. Remove the disc and then press **POWER**. The disc tray closes automatically and unit turns off.

## NOTES:

- If a non-compatible disc is loaded, “Incorrect Disc”, “Region Code Error” or “Parental Error” will appear on the TV screen according to the type of loaded disc. If these appear, check your disc again (see pages 25 and 38).
- Some discs may take a minute or so to start playback.
- When you set a single-faced disc label downwards (ie. the wrong way up) and press **PLAY** or **OPEN/CLOSE** on the unit, “Ⓢ” will appear on the display for about 5 seconds and then “No Disc” or “Incorrect Disc” will be displayed.
- Some playback operations of DVDs may be intentionally fixed by software producers. Since this unit plays DVDs according to the disc contents the software producers designed, some playback features may not be available. Also refer to the instructions supplied with the DVDs.

# Special playback

**Note:** There may be a slight delay between when you press the button and the function activating.

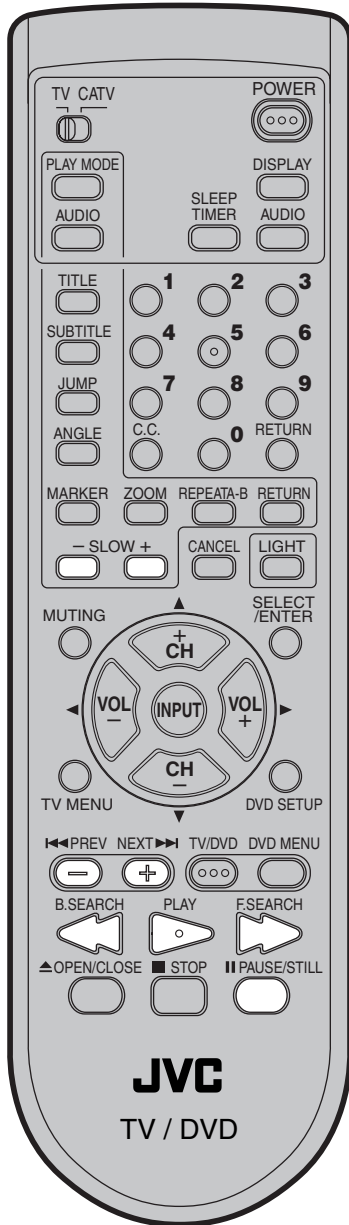

## NOTE:

The unit is capable of holding a still video image or On screen display image on your television screen indefinitely. If you leave the still video image or On screen display image displayed on your TV for an extended period of time, you risk permanent damage to your television screen. Projection televisions are very susceptible.

## Fast Forward Playback

Press **F.SEARCH** during normal playback.

Each press of **F.SEARCH** will increase the speed of the search

▶▶ (x 2), ▶▶▶ (x 4), ▶▶▶▶ (x 8), ▶▶▶▶▶ (x 15).

(CD: ▶▶ (x 2), ▶▶▶ (x 4), ▶▶▶▶ (x 8), ▶▶▶▶▶ (x 20))

- To resume normal playback, press **PLAY**.

## Review Playback

Press **B.SEARCH** during normal playback.

Each press of **B.SEARCH** will increase the speed of the search

◀◀ (x 2), ◀◀◀ (x 4), ◀◀◀◀ (x 8), ◀◀◀◀◀ (x 15).

(CD: ◀◀ (x 2), ◀◀◀ (x 4), ◀◀◀◀ (x 8), ◀◀◀◀◀ (x 20))

- To resume normal playback, press **PLAY**.

## Still Playback

Press **PAUSE/STILL** during normal playback to pause playback.

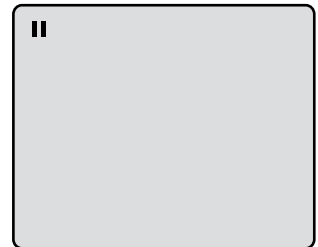

To resume normal playback, press **PLAY**.

## Frame Advance

Press **PAUSE/STILL** during still playback.

One frame is advanced each time you press **PAUSE/STILL**.

To resume normal playback, press **PLAY**.

## Slow-motion Playback

Press **SLOW(-)** Reverse or **SLOW(+)** Forward during normal playback or still playback.

Each press of **SLOW** will change the speed of the slow x1/2, x1/4, x1/6, x1/8.

- To resume normal playback, press **PLAY**.
- To resume the still playback, press **PAUSE/STILL**.

## Locating a chapter or track

Press **NEXT(▶▶▶)** or **PREV(◀◀◀)** during playback to locate a chapter that you want to watch.

Each time you press the button, a chapter or track is skipped.

This player can play back the MP3-data which has been recorded on CD-R or CD-RW. To produce the MP3-data, you need a Windows-PC with CD-ROM drive and a MP3-encoding Software (not supplied). The Apple-HFS-System can not be played.

## MP3 CD Information

### Limitations on MP3 CD playback

- MP3 CD is the disc that is standardized by ISO9660, its file name must include 3-digits extension letters, "mp3".
- The directory and file names of the MP3 CD must correspond to the ISO standardized files.
- This unit can read 200 files per disc. If one directory has more than 200 files, it reads up to 200 files, the remaining files will be omitted.
- MP3 CD's cannot be used for playback for the purpose of recording.
- It may take more than one minute for this unit to read MP3 files depending on its structure.
- Music recorded by "Joliet Recording Specification" can be played back, the file name is displayed on the screen. Long file names will be condensed.
- The music files recorded by "Hierarchical File System" (HFS) cannot be played.

### Notes on MP3 files

To play back MP3 CD in the recorded order,

1. Use MP3 software that records data alphabetically or numerically.
2. Name each file including two-digit or three-digit number (e.g. "01" "02" or "001" "002").
3. Refrain from making too many sub-folders.

### CAUTION:

- Some MP3 CDs can not be played back depending on the recording conditions.
- The CD-R/RW that has no music data or non-MP3 files can not be played back.

- 1 Press **OPEN/CLOSE**.  
The disc tray will open.  
Place a disc onto the tray.

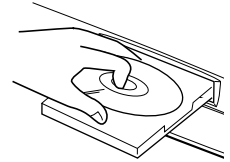

- 2 Press **PLAY** or **OPEN/CLOSE**.  
The disc tray closes automatically. On the TV-screen, "Scanning..." will appear. Scanning will take as much time as the number of file.

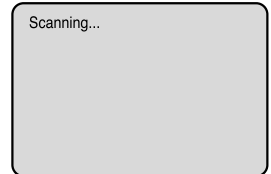

- 3 A MP3 menu screen will appear on the TV screen.  
Press **▲/▼** or **◀/▶** or **Number buttons (0-9)** to select the desired track, then press **ENTER**. Track is selected and play commences.

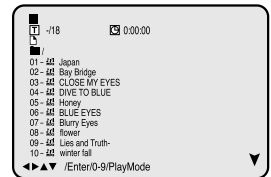

- In case the folder includes more than 11 tracks, press **◀** or **▶** to display next track list.

- 4 Press **STOP** to end playback.
  - The unit records the stopped point. "■" appears on the screen. Press **PLAY** to resume playback (from the scene point).
  - If you press **STOP** again or unload the disc, the unit will clear the stopped point.

- 5 Then press **OPEN/CLOSE**.  
The disc tray opens.  
Remove the disc and press **POWER**.  
The disc tray closes automatically and the unit turns off.

### NOTES:

- During MP3-Playback, you can not use SEARCH, A-B Repeat functions.
- You can use Repeat (Track or All), Random functions and Program playback for MP3 CD Playback (see page 31).

# Zooming/Locating desired scene

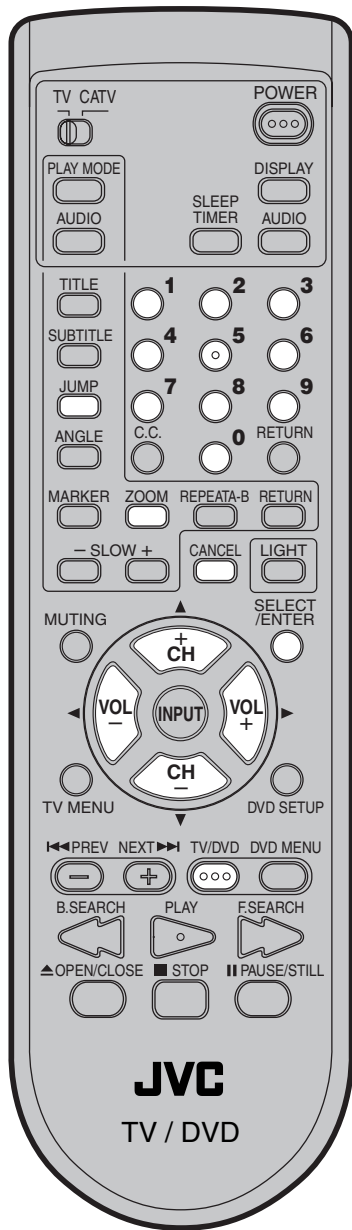

## NOTES:

- You can select the Pause, Slow or Search playback in the zoom mode.
- Some discs may not respond to zoom feature.

## Zooming

This unit will allow you to zoom in on the frame image. You can then make selections by switching the position of the frame.

- 1 Press **TV/DVD** to select DVD mode.  
Press **ZOOM** during playback.  
The center part of the image will be zoomed in.  
Each press of **ZOOM** will change the ZOOM Q1 (x 2), Q2 (x 3) and Q3 (x 4).

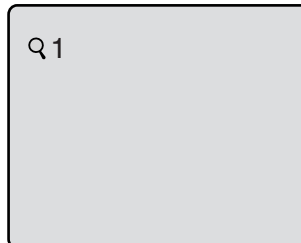

- 2 Press **▲/▼/◀/▶** to view a different part of the frame.  
You may move the frame from the center position to UP, DOWN, LEFT or RIGHT direction.
- 3 In the zoom mode press **ZOOM** repeatedly to return to a 1:1 view (Q Off).

## Locating Desired Scene

Use the title, chapter and time recorded on the disc to locate the desired point to play back.

- 1 Press **JUMP** during playback.

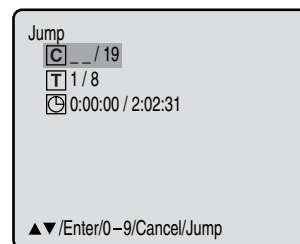

- 2 Press **▲** or **▼** to select the "**C**" (Chapter), "**T**" (Title/Track) or "**⌚**" (Time)".
- 3 Press **Number buttons (0-9)** to input the number.
  - If you input a wrong number, press **CANCEL**.
  - Refer to the package supplied with the disc to check the numbers.
- 4 Press **ENTER**.
  - Playback starts.
  - When you change the title, playback starts from Chapter 1 of the selected title.
  - Some discs may not work in the above operation.

# Repeat, Random and Program playback/Repeat A-B

Press **PLAY MODE** during playback or stop mode.

Each time you press **PLAY MODE**, playback mode changes as follows.

## DVD

On screen display	Operation
→  Title:	Repeats the current title.
↓ Chapter:	Repeats the current chapter.
↓ Off:	Resumes normal playback.

- During stop mode, **PLAY MODE** key is not effective.

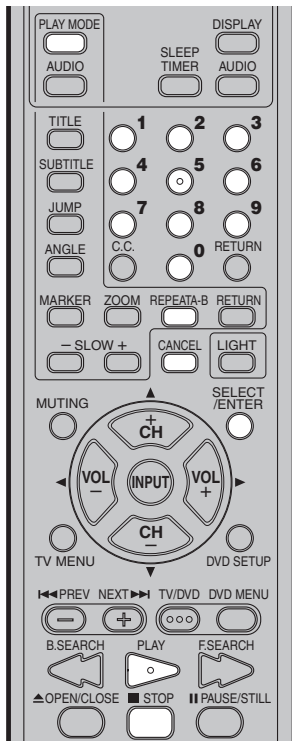

## Audio CD/MP3 CD

On screen display	Operation
→  All:	Repeats entire disc.
↓ Track:	Repeats the current track.
↓ Random Play:	Plays the tracks in random order.
↓ *Program:	Plays the tracks in program order.
↓ (Status display):	Resumes normal playback.

- During stop mode, you can not select " Track".

## \*Program menu

Use **number buttons (0-9)** to enter the track's number you want to program, then press **ENTER**. The track number and total time are displayed. Repeat this step to enter additional tracks. When you have finished entering tracks, press **PLAY** to start Program playback.

A playlist of your programmed tracks is displayed.

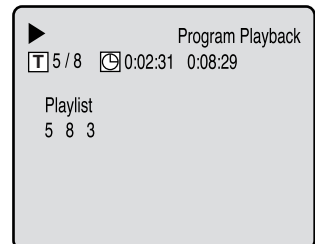
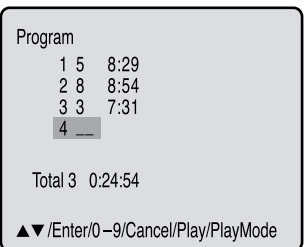

## NOTES:

- If you enter a wrong number – press **CANCEL**.
- To cancel program play, press **STOP** 3 times.
- To clear the programs on the program menu – press **CANCEL** until all programs are cleared.
- The program is cancelled when you open the disc tray or turn off the power.

## Repeat A-B

**Repeat A-B playback allows you to repeat material between two selected points.**

**1** Press **REPEAT A-B** during playback.  
The start point is selected.

**2** Press **REPEAT A-B** again.  
The end point is selected. Playback starts at the point that you selected. Playback stops at the end point, returns to Point A automatically, then starts again.

To resume normal playback press **REPEAT A-B** again. " Off" appears on the screen.

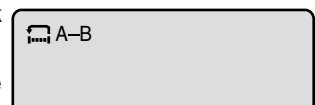
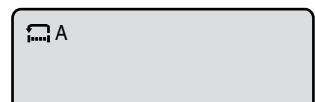

## NOTES:

- Some discs may not work with the repeat operation.
- In Repeat A-B mode, subtitles near point A or B may not appear.
- You may not be able to set Repeat A-B, depending on the scenes of the DVD.
- Repeat A-B does not work with MP3 CD and interactive DVDs.

# Marking desired scenes

The TV/DVD stores the points that you want to watch again. You can resume playback from that scene.

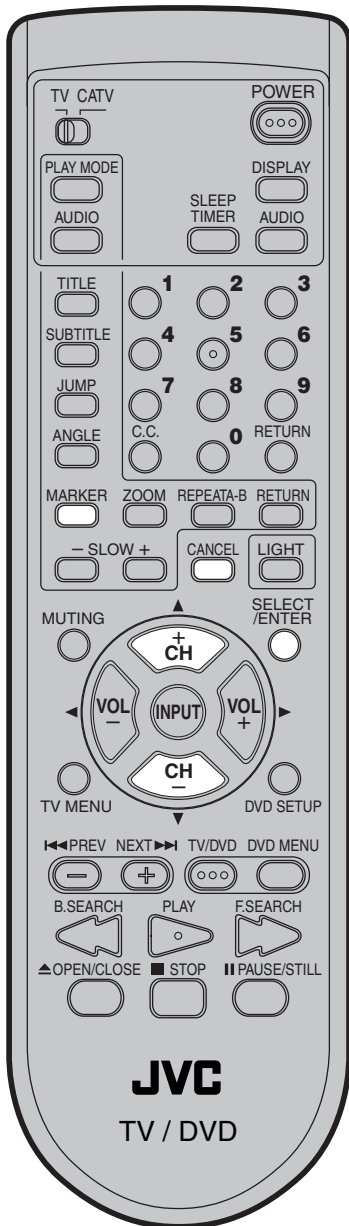

## NOTES:

- The marking is canceled when you open the disc tray or turn the power off.
- Some subtitles recorded around the marker may fail to appear.

## Marking the Scenes

- 1 Press **MARKER** during playback.

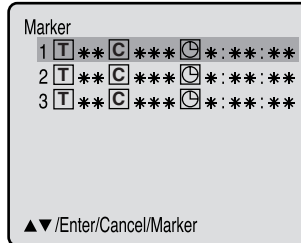

- 2 Select the blank Marker using ▲/▼, then press **ENTER** at the desired scene.

- Up to 3 scenes can be selected.
- Repeat this procedure to set the other 2 scenes.

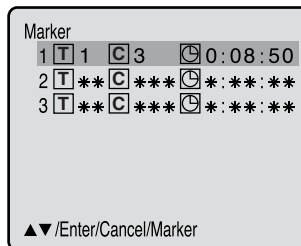

- 3 Press **MARKER** to remove this display.

## Returning to the Scenes

- 1 Press **MARKER** during playback or stop mode.

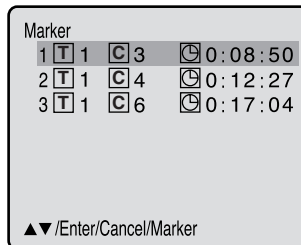

- 2 Press ▲ or ▼ to select the Marker 1-3.

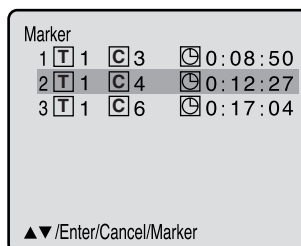

- 3 Press **SELECT**. Playback starts from the marked scene.

## To Cancel the Mark

- 1 Press **MARKER**.
- 2 Press ▲ or ▼ to select the Marker 1-3.
- 3 Press **CANCEL**.



# Changing soundtrack language/Subtitles

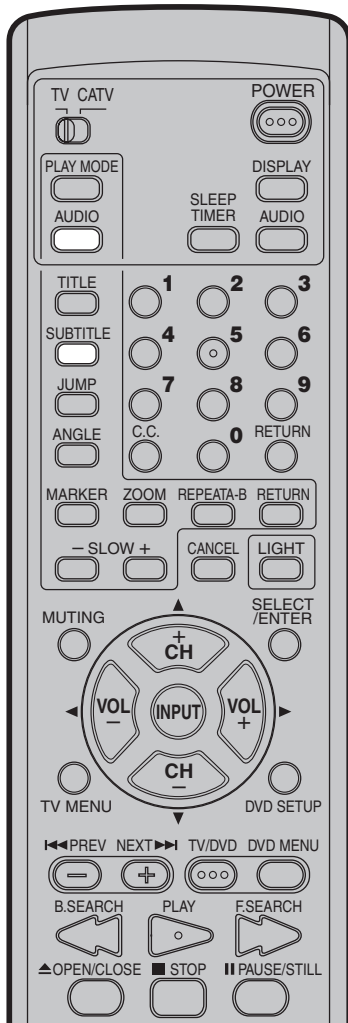

## NOTES:

- If the desired language is not heard after pressing the SUBTITLE button several times, the language is not recorded on the disc.
- Changing soundtrack language is cancelled when you open the disc tray. The initial default language or available language will be heard if the disc is played back again.
- Changing subtitle language is cancelled when you open the disc tray.
- Some functions may not work on some DVDs. You may not be able to turn subtitles on or off or change subtitles. While playing the DVD, the subtitle may change when:
  - you open or close the disc tray
  - you change the title.
- In some cases, the subtitle language is not changed to the selected one immediately.

## Changing soundtrack language

You can select the language when you play a multilingual disc.

- 1 Press **AUDIO** during playback.

2/8 Fra Dolby Digital

The current soundtrack language will appear.

- 2 Press **AUDIO** repeatedly until the desired language is selected.

1/8 Eng Dolby Digital

The on-screen display will disappear after a few seconds.

## Subtitles

### Turning the Subtitles On and Off

When playing back a disc recorded with subtitles, you can turn the subtitles on or off.

Press **SUBTITLE** during playback until "Off" appears.

Off

### Changing the subtitle language

You can select the language when playing back a disc recorded with multi-lingual subtitles.

- 1 Press **SUBTITLE** repeatedly during playback until your desired language appears.

1/32 Eng

- 2 The on-screen display will disappear after a few seconds.

# Changing angles/Title selection/DVD menu

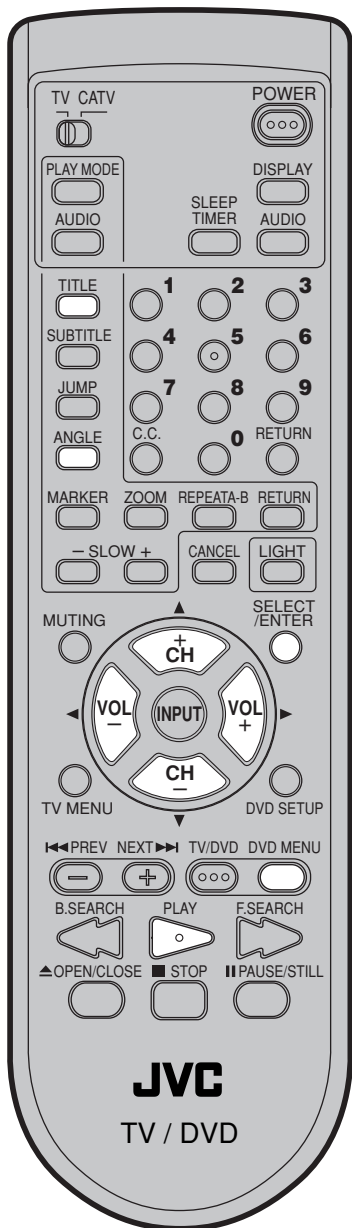

## Changing angles

When playing back a disc recorded with multi-angle facility, you can change the view angle.

- 1 Press **ANGLE** during playback.

The current angle will appear.

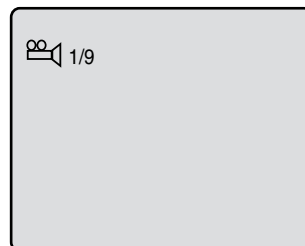

- 2 Press **ANGLE** repeatedly until the desired angle is selected.

## Title selection

Two or more titles are recorded on some discs. If the title menu is recorded on the disc, you can select the desired title.

- 1 Press **TITLE** during playback.  
Title menu appears on the screen.
- 2 Press **▲/▼** or **◀/▶** to select the desired title.
- 3 Press **ENTER** or **PLAY**.  
The playback of the selected title will start.

## DVD menu

Some DVDs allow you to select the disc contents using the menu.

When you play back these DVDs, you can select the subtitle language and sound-track language, etc. using the DVD menu.

- 1 Press **DVD MENU** during playback.  
The DVD menu appears on the screen.
  - Press **DVD MENU** again to resume playback at the scene when you pressed **DVD MENU**.
- 2 Press **▲/▼** or **◀/▶** to select the desired item.
- 3 Press **ENTER**.  
The menu continues to another screen. Repeat steps 2 and 3 to set additional items if any.

### NOTES:

- Depending on the DVD, you may not be able to change the angles even if multi-angles are recorded on the DVD.
- Depending on the DVD, you may not be able to select the title. Depending on the DVD, a "title menu" may simply be called a "menu" or "title" in the instructions supplied with the disc.

# Setting language

You can change the default settings to customise performance to your preference.

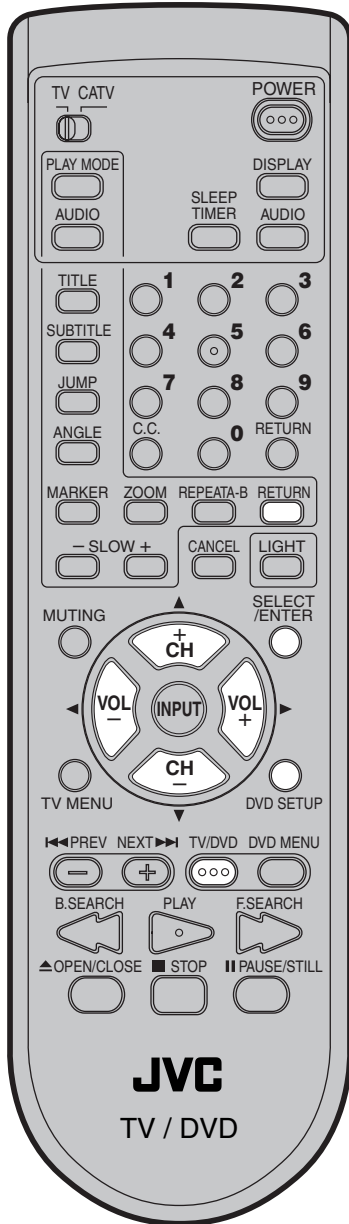

## NOTES:

- If the selected soundtrack language is not recorded on the disc, the original language will be heard.
- If the selected subtitle language is not recorded on the disc, the first-priority language is selected.

- 1 Press **TV/DVD** to select DVD mode.  
Press **DVD SETUP** in the stop mode or No Disc.  
Press **▲** or **▼** to select "Language", then press **▶** or **ENTER**.

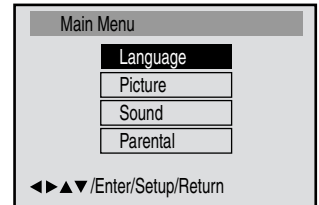

- 2 Press **▲** or **▼** to select "OSD Language", then press **▶** or **ENTER**.

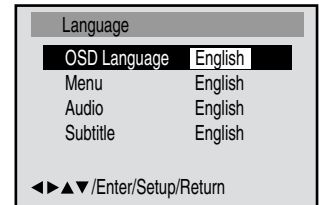

- 3 Press **▲** or **▼** to select desired language (e.g. English), then press **ENTER**.  
The menu returns to "Language" menu automatically.

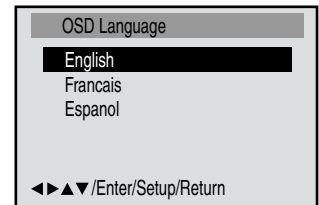

- If you want to return to the previous menu, press **◀** or **RETURN**.

- 4 Repeat steps 2-3 for other "Language" setting.

### Other: (Menu/Audio/Subtitle)

If you want to select another language, enter the language code (see the Language code list on page 41).

### Off: (subtitle)

Subtitles do not appear.

- 5 Press **DVD SETUP** to remove the Menu screen.

# Setting the aspect ratio of TV screen/Setting on screen display

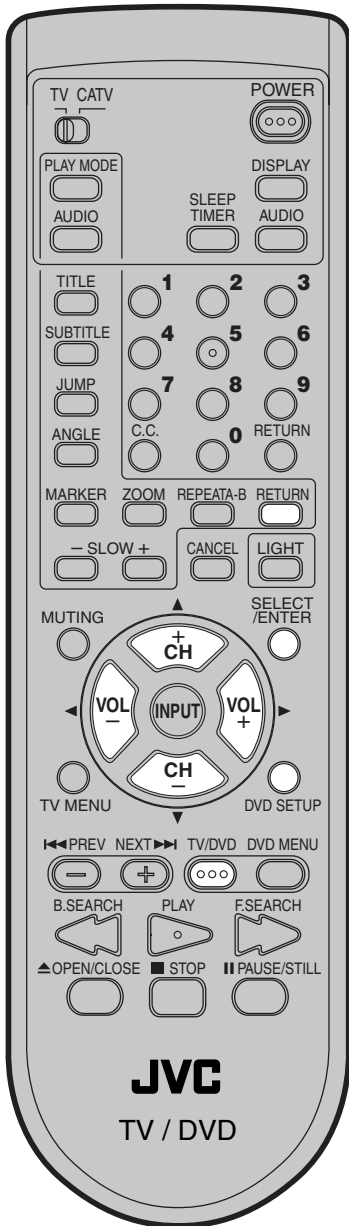

## NOTE:

If the DVD disc is not formatted in the pan & scan style, it displays 4:3 style.

## Setting the aspect ratio of TV screen

You can select the aspect ratio for your TV.

- 1 Press **TV/DVD** to select DVD mode.  
Press **DVD SETUP** in the stop mode or No Disc.  
Press **▲** or **▼** to select "Picture", then press **▶** or **ENTER**.

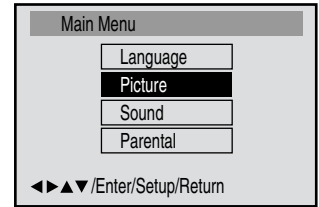

- 2 Press **▲** or **▼** to select "TV Screen", then press **▶** or **ENTER**.

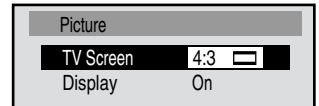

- 3 Press **▲** or **▼** to select your desired screen type, then press **ENTER**.

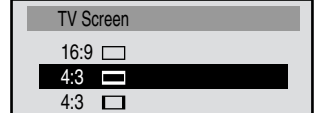

You have the following screen sizes to choose from:

### 16:9 Wide screen

Select this mode when connecting to a wide-screen TV. A wide screen picture is displayed full size.

### 4:3 Letterbox

Select this mode when connecting to a conventional TV. When playing back a wide screen-DVD disc, it displays the wide picture with black bands at the top and bottom of screen.

### 4:3 Panscan

It displays the wide picture on the whole screen with left and right edges automatically cut off.

- If you want to return to the previous menu, press **◀** or **RETURN**.

- 4 Press **DVD SETUP** to remove the Menu screen.

## Status on screen display

On screen display can be switched on or off when you press the buttons.

- 1 Press **DVD SETUP** in the stop mode or No Disc.  
Press **▲** or **▼** to select "Picture", then press **▶** or **ENTER**.

- 2 Press **▲** or **▼** to select "Display".

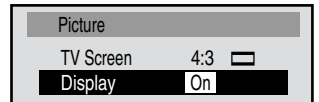

- 3 Press **▶** or **ENTER** to select "On" or "Off".

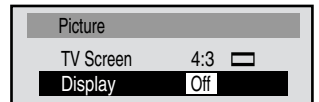

**On:** On screen displays appear when you press the buttons (factory setting).

**Off:** On screen displays do not appear when you press any buttons.

- If you want to return to the previous menu, press **◀** or **RETURN**.

- 4 Press **DVD SETUP** to remove the Menu screen.

# Dynamic Range Control

**DRC (Dynamic Range Control)** enables you to control the dynamic range so as to achieve a suitable sound for your equipment.

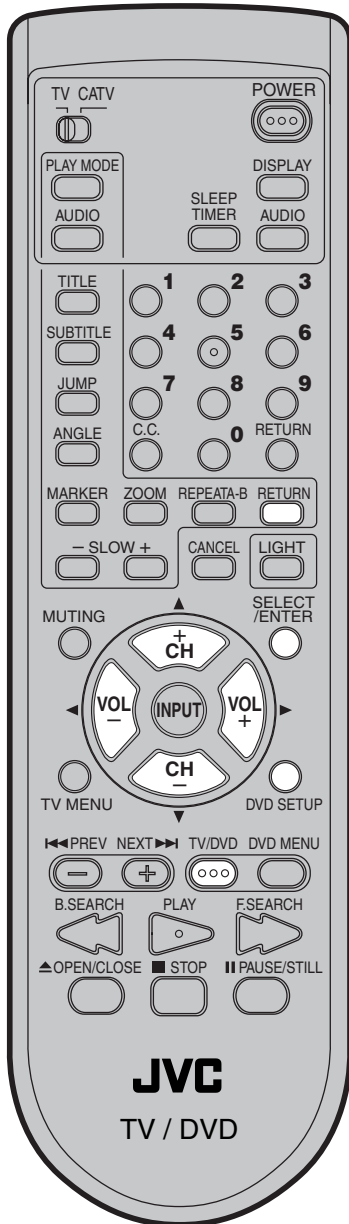

## NOTES:

- This function works only during playback of Dolby Digital recorded discs.
- The level of Dynamic Range Reduction may differ depending on DVD video disc.

- 1 Press **TV/DVD** to select DVD mode.  
Press **DVD SETUP** in the stop mode or No Disc.  
Press **▲** or **▼** to select "Sound".

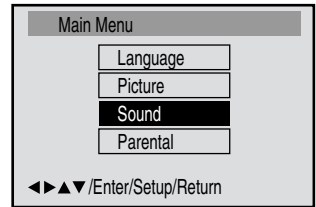

- 2 Press **▶** or **ENTER** to select "DRC".

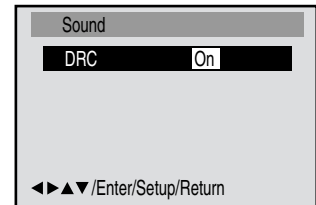

- 3 Press **▶** or **ENTER** to select "On" or "Off".

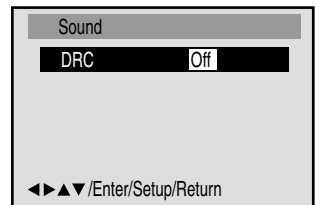

- If you want to return to the previous menu, press **◀** or **RETURN**.

- 4 Press **DVD SETUP** to remove the Menu screen.

# Parental control setting

Some discs are specified not suitable for children. Such discs can be prevented from play back with the unit.

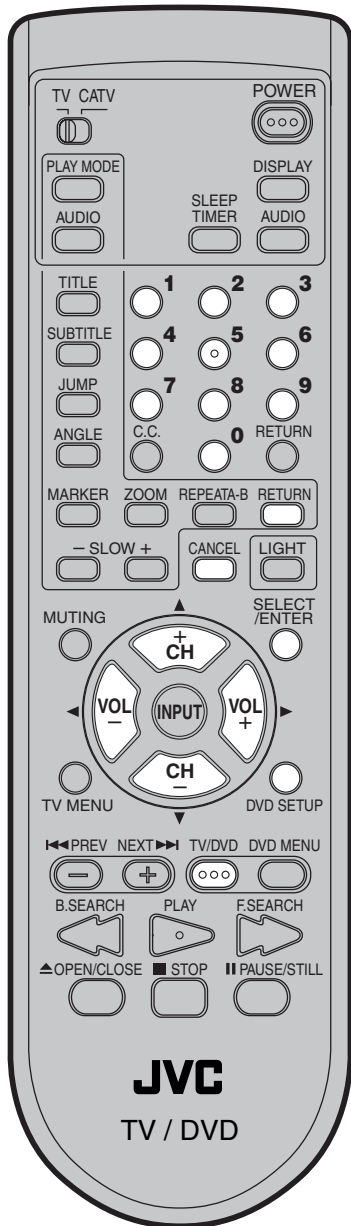

## NOTES:

- If each setup (P.35–39) has been completed, the unit can always be operated under the same conditions (especially with DVD discs). Each setup will be retained in the memory when you turn the power off.
- Depending on the discs, the unit cannot limit playback.
- Some discs may not be encoded with specific rating level information though its disc jacket says “adult.” For those discs, the age restriction will not work.

- 1 Press **TV/DVD** to select DVD mode.  
Press **DVD SETUP** in the stop mode or No Disc.  
Press **▲** or **▼** to select “Parental”, then press **▶** or **ENTER**.

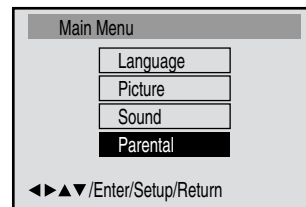

- 2 Press **▲** or **▼** to select “Parental Level”, then press **▶** or **ENTER**.

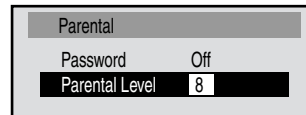

- 3 Press **▲** or **▼** to select a level from Off or 1–8. Press **▶** or **ENTER** to set the selected level.

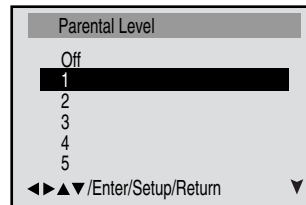

- **Level Off:** The parental control setting does not function.
- **Level 8:** Almost all DVD software can be played back.
- **Level 1:** DVD software for adults cannot be played back.
- Select from the level 1 to level 8. The limitation will be more severe as the level number is lower.

- 4 Press **▲** or **▼** to select “Password”, then press **▶** or **ENTER**.

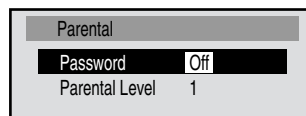

- 5 Press **number buttons (0–9)** for the password. Don't forget the password.  
• If you input a wrong number, press **CANCEL**.

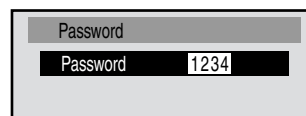

- 6 Press **ENTER** to store the password.  
**Note:** Now the rating is locked and the setting cannot be changed unless you enter the correct password.

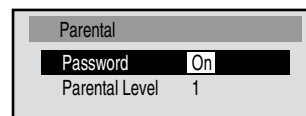

- If you want to return to the previous menu, press **◀** or **RETURN**.

- 7 Press **DVD SETUP** to remove the parental control screen.

# To change the parental level

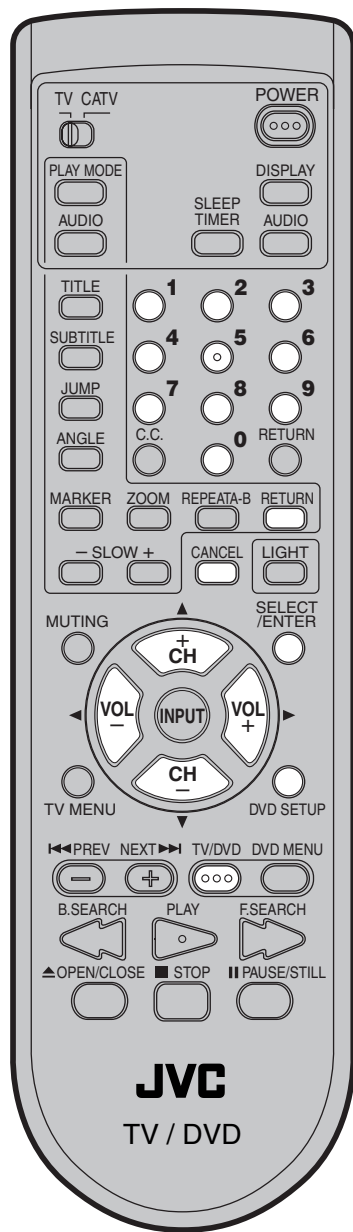

## NOTE:

Do not forget the password. If you forget the password, contact the dealer that you purchased the unit from.

- 1 Press **TV/DVD** to select DVD mode.  
Press **DVD SETUP** in the stop mode or No Disc.  
Press **▲** or **▼** to select "Parental", then press **▶** or **ENTER**.

- 2 Press **▲** or **▼** to select "Password", then press **▶** or **ENTER**.

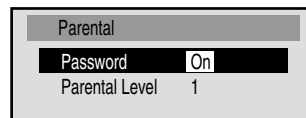

- 3 Press **number buttons (0–9)** to enter the password you have stored.

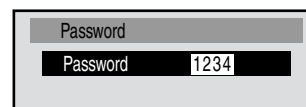

- If you input a wrong number, press **CANCEL**.

- 4 Press **ENTER**.  
The password is now Off.

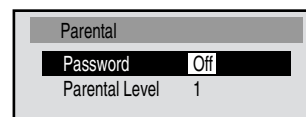

- 5 Press **▲** or **▼** to select "Parental Level". Then press **▶** or **ENTER**. The Parental Level screen is displayed.

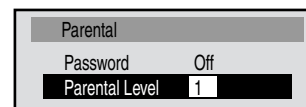

- 6 Press **▲** or **▼** to select a level from Off or 1–8 and then press **▶** or **ENTER**.

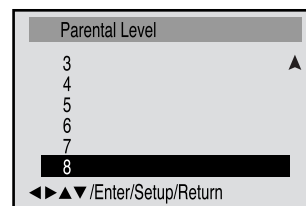

- 7 Press **▲** or **▼** to select "Password" and then press **▶** or **ENTER**.

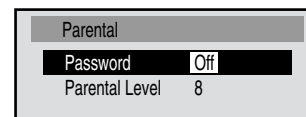

- 8 Press **number buttons (0–9)** to enter a 4-digit password.

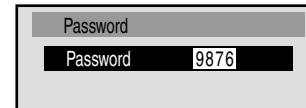

**Note:** You can enter a new password.

- 9 Press **ENTER**.  
The parental level is now changed and locked.

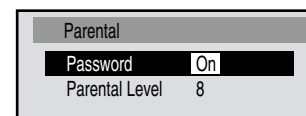

- If you want to return to the previous menu, press **◀** or **RETURN**.

- 10 Press **DVD SETUP** to remove the parental control screen.

# Temporary disabling of rating level by DVD disc

Depending on the DVD disc, the disc may try to temporarily cancel the rating level that you have set. It is up to you to decide whether to cancel the rating level or not.

- 1 Load a DVD disc and press **PLAY** (see page 27).

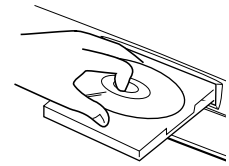

- 2 If the DVD disc has been designed to temporarily cancel the Rating level, the screen which appears after inserting a DVD will change, depending on which disc is played. If you select "YES" with the **ENTER** key, "Your disc exceeds the parental control level." screen will then appear.

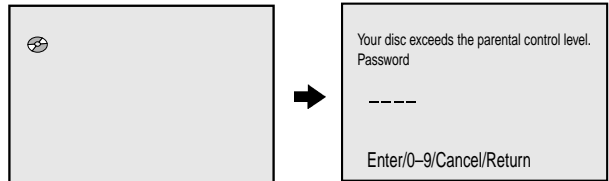

- 3 If you wish to cancel the set rating level temporarily, enter the 4-digit password. Then press **ENTER**.  
Alternatively, if the password has not been set, playback will commence. If you don't know (or have forgotten) the password, select "STOP".  
The setting screen will disappear. Press **OPEN/CLOSE** to remove the disc.

To quit entering, press **RETURN**.

- 4 Playback will commence if the entered password was correct.

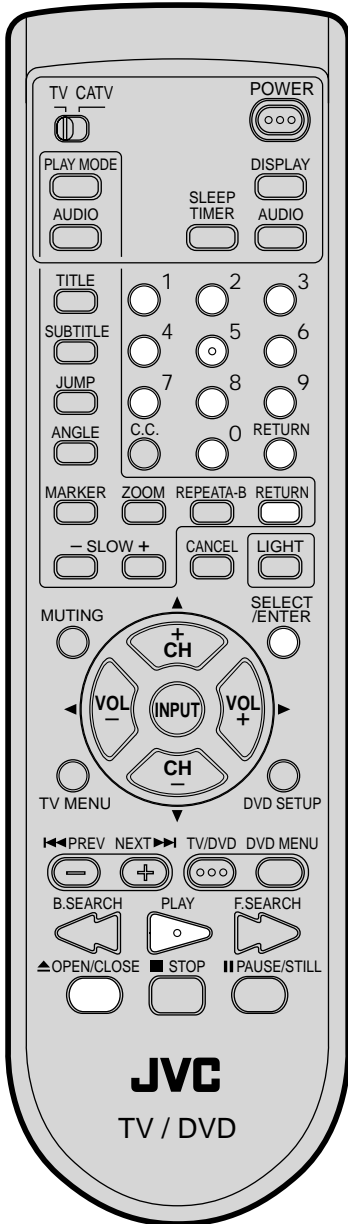

## NOTE:

The rating level will remain disabled until the disc is ejected.

When the disc is ejected, the original rating level will be set again automatically.



# Language code list

Enter the appropriate code number for the initial settings "Menu", "Audio" and/or "Subtitle" (see page 35).

Language Name	Code	Language Name	Code	Language Name	Code	Language Name	Code
Abkhazian	1112	Fiji	1620	Lingala	2224	Singhalese	2919
Afar	1111	Finnish	1619	Lithuanian	2230	Slovak	2921
Afrikaans	1116	French	1628	Macedonian	2321	Slovenian	2922
Albanian	2927	Frisian	1635	Malagasy	2317	Somali	2925
Amharic	1123	Galician	1722	Malay	2329	Spanish	1529
Arabic	1128	Georgian	2111	Malayalam	2322	Sundanese	2931
Armenian	1835	German	1415	Maltese	2330	Swahili	2933
Assamese	1129	Greek	1522	Maori	2319	Swedish	2932
Aymara	1135	Greenlandic	2122	Marathi	2328	Tagalog	3022
Azerbaijani	1136	Guarani	1724	Moldavian	2325	Tajik	3017
Bashkir	1211	Gujarati	1731	Mongolian	2324	Tamil	3011
Basque	1531	Hausa	1811	Nauru	2411	Tatar	3030
Bengali; Bangla	1224	Hebrew	1933	Nepali	2415	Telugu	3015
Bhutani	1436	Hindi	1819	Norwegian	2425	Thai	3018
Bihari	1218	Hungarian	1831	Oriya	2528	Tibetan	1225
Breton	1228	Icelandic	1929	Panjabi	2611	Tigrinya	3019
Bulgarian	1217	Indonesian	1924	Pashto, Pushto	2629	Tonga	3025
Burmese	2335	Interlingua	1911	Persian	1611	Turkish	3028
Byelorussian	1215	Irish	1711	Polish	2622	Turkmen	3021
Cambodian	2123	Italian	1930	Portuguese	2630	Twi	3033
Catalan	1311	Japanese	2011	Quechua	2731	Ukrainian	3121
Chinese	3618	Javanese	2033	Rhaeto-Romance	2823	Urdu	3128
Corsican	1325	Kannada	2124	Romanian	2825	Uzbek	3136
Croatian	1828	Kashmiri	2129	Russian	2831	Vietnamese	3219
Czech	1329	Kazakh	2121	Samoan	2923	Volapük	3225
Danish	1411	Kirghiz	2135	Sanskrit	2911	Welsh	1335
Dutch	2422	Korean	2125	Scots Gaelic	1714	Wolof	3325
English	1524	Kurdish	2131	Serbian	2928	Xhosa	3418
Esperanto	1525	Laothian	2225	Serbo-Croatian	2918	Yiddish	2019
Estonian	1530	Latin	2211	Shona	2924	Yoruba	3525
Faroese	1625	Latvian, Lettish	2232	Sindhi	2914	Zulu	3631

# Connections to other equipments

The exact arrangement you use to interconnect various video and audio components to the TV/DVD is dependent on the model and features of each component. Check the Owner's Manual provided with each component for the location of video and audio inputs and outputs.

## Using an AV Amplifier with built-in digital surround

If you are using an Amplifier with a built-in digital surround as follows, you can enjoy the various audio systems including Dolby Digital Surround audio that sounds just like the movie.

**Connect an AV amplifier with built-in Dolby Digital decoder, DTS decoder, MPEG decoder or etc as shown below.**

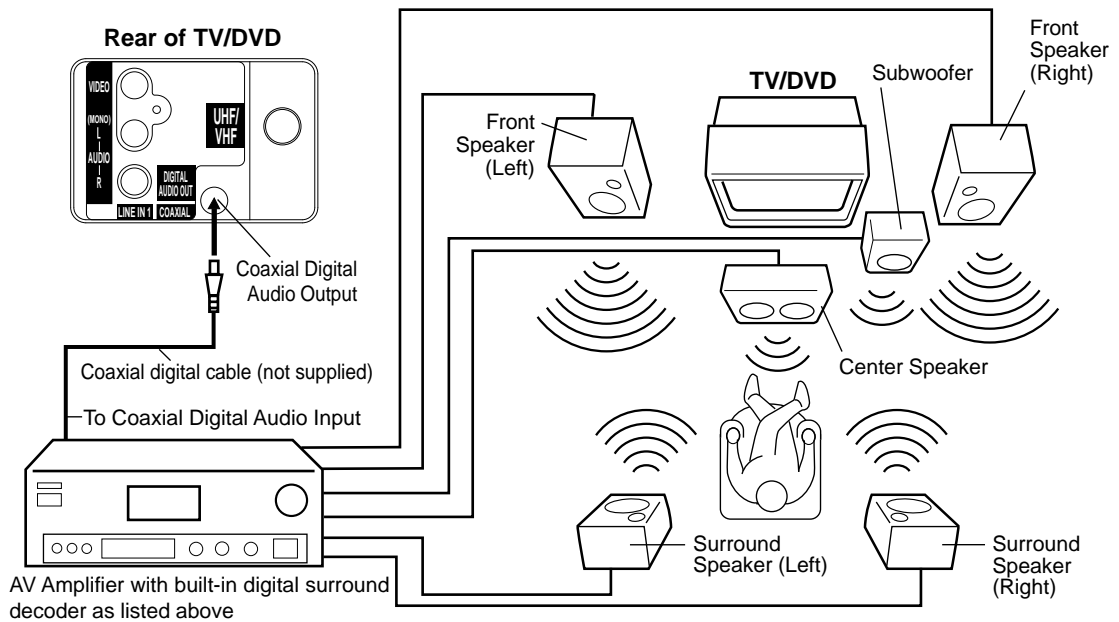

\* Manufactured under license from Dolby Laboratories. "Dolby" and the double-D symbol are trademarks of Dolby Laboratories. Confidential unpublished works. © 1992-1997 Dolby Laboratories, Inc. All rights reserved.

\* "DTS" and "DTS Digital Out" are trademarks of Digital Theater Systems, Inc.

### NOTE:

- When you make the connections above, do not set DOLBY DIGITAL to DOLBY DIGITAL, MPEG to MPEG to ON on the AV Amplifier. If you do, a loud noise will suddenly come out from the speakers, affecting your ears or causing the speakers to be damaged.
- When playing DTS-encoded CDs, only noise will be heard from the speakers or analogue stereo outputs.
- Some DTS decoders which do not support DVD-DTS interface may not work properly with the unit.

## Using the audio/video inputs

If you connect the TV/DVD to VCR, camcorder or TV game, you can select by pressing **INPUT**.

Press **INPUT** repeatedly to select the desired mode.

"LINE1", "LINE2" or TV channel will display on the screen for 4 seconds.

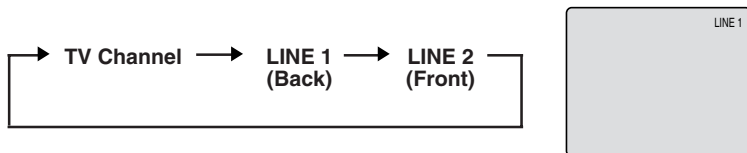

**NOTE:** In the DVD mode this key will not operate.

### 1. To connect the TV/DVD to a VCR

Press the **INPUT** to select the desired mode to use the TV as a monitor.

Operate your VCR as usual.

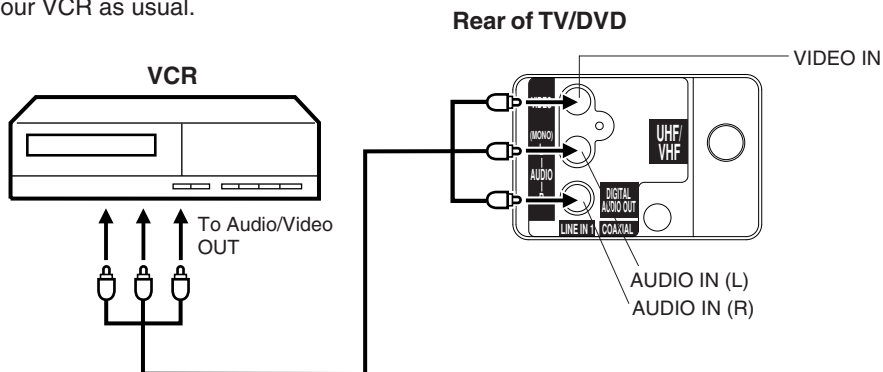

### 2. To connect the TV/DVD to a camcorder

To playback from the camcorder, connect the camcorder to the TV/DVD as shown.

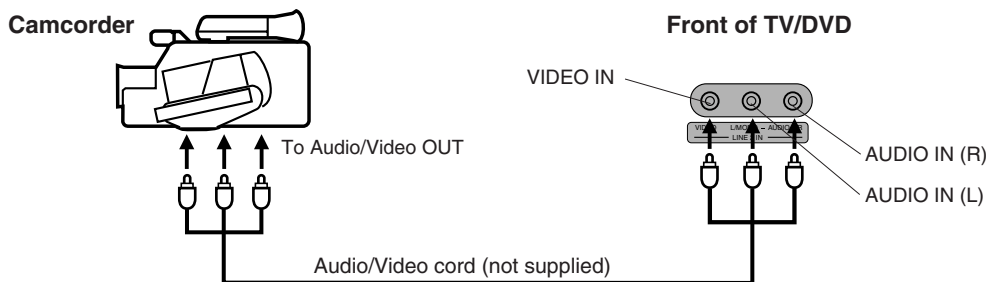

### 3. To connect the TV/DVD to a TV Game

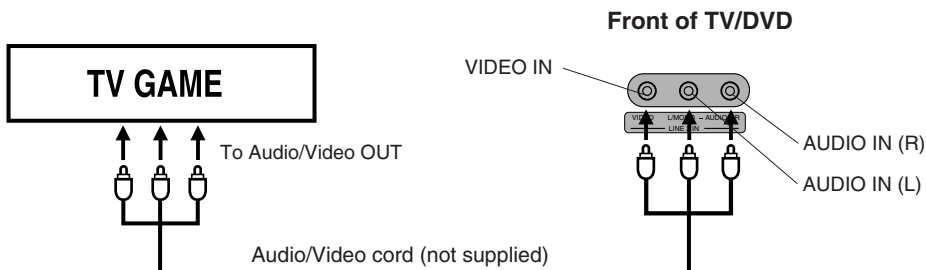

# Problems and troubleshooting

Use the following check list for troubleshooting when you have problems with your unit. Consult your local dealer or service outlet if problems persist.

Be sure all connections are properly made when using with other units.

SYMPTOMS	POSSIBLE SOLUTIONS	PAGE
<b>POWER</b>		
TV/DVD does not operate.	• Make sure the power cord is plugged in.	5
	• Try another AC outlet.	10
	• Power is off, check fuse or circuit breaker.	–
	• Unplug unit, then plug it back in.	5
<b>TV BROADCAST RECEPTION</b>		
Poor sound or No sound	• Station or CATV experiencing problems, tune to another station.	14
	• Check Volume adjustments (Volume and Muting).	14
	• Check for sources of possible interference.	46
Poor picture or No picture	• Station or CATV experiencing problems, tune to another station.	14
	• Check antenna or CATV connections, reorient antenna.	11,12
	• Check for sources of possible interference.	46
	• Check picture control adjustments.	22
Poor reception on some channels	• Station or CATV experiencing problems, tune to another station.	14
	• Station signal is weak, reorient antenna to receive weaker station.	11,12
	• Check for sources of possible interference.	46
Poor color or no color	• Station or CATV experiencing problems, tune to another station.	14
	• Make sure channels are set into memory.	18
	• Check picture control adjustments.	22
	• Check antenna or CATV connections, reorient antenna.	11,12
	• Check for sources of possible interference.	46
Picture wobbles or drifts	• Station or CATV experiencing problems, tune to another station.	14
	• Make sure channels are set into memory.	18
	• CATV company is scrambling signal.	–
	• Check antenna orientation.	11
No CATV reception	• Check all CATV connections.	12
	• Set TV/CATV menu option to the CATV mode.	17
	• Station or CATV system problems, try another station.	14
Horizontal or diagonal bars on screen	• Check antenna connections, reorient antenna.	11,12
	• Check for sources of possible interference.	46
No reception above channel 13	• Make sure TV/CATV menu option is in the appropriate mode.	17
	• If using antenna, check UHF antenna connections.	11
TV shuts off	• No broadcast on station tuned.	18
	• Sleep Timer is set.	15
	• Power interrupted.	–
Closed - Caption is not activated.	• TV station experiencing problems or program tuned is not closed captioned. Try another channel.	18
	• Check CATV connection or VHF/UHF antenna, reposition or rotate antenna.	11,12
	• Press C.C. button to turn on the closed caption decoder.	16
Display is not shown in your language.	• Select proper language in the menu options.	13

SYMPTOMS	POSSIBLE SOLUTIONS	PAGE
<b>DVD</b>		
Playback doesn't start.	<ul style="list-style-type: none"> <li>• No disc is inserted.</li> <li>• The disc may be dirty. Clean up the disc.</li> <li>• The unit cannot play CD-ROMs, etc.</li> </ul>	27 25 –
No picture	<ul style="list-style-type: none"> <li>• TV/DVD selector is not set correctly.</li> </ul>	26
No sound	<ul style="list-style-type: none"> <li>• Check the input selector of the amplifier is set properly.</li> <li>• The unit is in the Special playback mode.</li> <li>• Select the correct Audio Output position on AV amplifier.</li> </ul>	– 28 42
Picture is distorted during CUE or REVIEW.	<ul style="list-style-type: none"> <li>• The picture will be distorted occasionally.</li> </ul>	–
Stopping playback, search, slow-motion play, repeat play, or program play, etc. cannot be performed.	<ul style="list-style-type: none"> <li>• Some discs may not do some of the functions.</li> </ul>	–
No 4:3 (16:9) picture	<ul style="list-style-type: none"> <li>• The setup does not match your TV.</li> </ul>	36
No on-screen display	<ul style="list-style-type: none"> <li>• Select Display On.</li> </ul>	36
No surround sound	<ul style="list-style-type: none"> <li>• The setup does not match your stereo system.</li> </ul>	42
The unit or remote operation key is not functioning.	<ul style="list-style-type: none"> <li>• Turn off the unit and unplug the AC power cord for several minutes, then replug it.</li> </ul>	–
Playback does not start when the title is selected.	<ul style="list-style-type: none"> <li>• Check the RATING LEVEL setup.</li> </ul>	38~40
Audio soundtrack and/or subtitle language is not changed when you play back a DVD.	<ul style="list-style-type: none"> <li>• Multilingual language is not recorded on the DVD disc.</li> </ul>	35
No subtitle	<ul style="list-style-type: none"> <li>• Some discs have no subtitles.</li> <li>• Subtitles are cleared. Press SUBTITLE.</li> </ul>	33
Angle cannot be changed.	<ul style="list-style-type: none"> <li>• Multi-angles are not recorded on the DVD disc.</li> </ul>	34
“⊘” appears on the screen.	<ul style="list-style-type: none"> <li>• The function is prohibited with the unit or the disc.</li> </ul>	–
<b>REMOTE CONTROL</b>		
The remote control does not function.	<ul style="list-style-type: none"> <li>• Aim at the remote control at the remote sensor.</li> <li>• Operate within Approx. 5 Meters or reduce the light in the room.</li> <li>• Clear the path of the beam.</li> <li>• The batteries are weak. Replace the batteries.</li> <li>• Check the batteries are inserted correctly.</li> </ul>	10

# Reception disturbances

Most types of television interference can be remedied by adjusting the height and position of the VHF/UHF antenna. Outdoor antennas are recommended for best results. The most common types of television interference are shown below. If one of these symptoms appear when the TV/DVD is connected to a Cable TV system, the disturbance may be caused by the local Cable TV company broadcast.

## IGNITION

Black spots or horizontal streaks may appear, the picture may flutter or drift. Usually caused by interference from automobile ignition systems, neon lamps or AC powered tools and appliances such as drills or hair dryers.



## GHOSTS

Ghosts are caused by the television signal following two paths. One is the direct path and the other is reflected by tall buildings, hills or other large objects. Changing the direction or position of the antenna may improve the reception.



## SNOW

If the TV/VCR is located far from the TV station, in a fringe reception area where the signal is weak, small dots may appear in the picture. If the signal is extremely weak, the installation of a larger external antenna may be necessary.



## RADIO FREQUENCY INTERFERENCE (RFI)

Caused by two-way radios, this type of interference produces moving ripples or diagonal streaks in the picture. Some cases may cause a loss of contrast in the picture. Changing the direction and position of the antenna or installing an RFI filter may improve the picture.

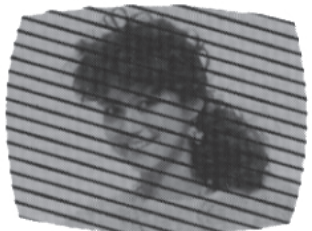

## PICTURE SIZE VARIATION

A slight picture size variation is normal when you adjust the CONTRAST or BRIGHTNESS settings.



## CARE AND MAINTENANCE

To prevent fire or shock hazard, disconnect the TV/DVD from the power source before cleaning. The finish on the cabinet may be cleaned with mild soap and a soft, damp cloth and cared for as other furniture. Use caution when cleaning or wiping the plastic parts.

## GENERAL

Power supply:	AC 120V 60Hz
Power consumption:	Operation: 115W Stand by: 4W
Weight:	56.1lbs (25.5 kg)
Dimensions:	Width : 22-5/8 inches (574 mm) Height: 20-3/8 inches (515 mm) Depth : 19-1/8 inches (483 mm)

## TELEVISION

Picture tube:	Type 20 (508 mm diagonal)
Tuner type:	Quartz PLL Frequency Synthesized
Receiving channels:	VHF 2-13 UHF 14-69 CATV 14-36 (A)-(W) 37-59 (AA)-(WW) 60-85 (AAA)-(ZZZ) 86-94 (86)-(94) 95-99 (A-5)-(A-1) 100-125 (100)-(125) 01 (5A)
Antenna input:	VHF/UHF In 75 ohm coaxial
Speaker:	1-13/16 x 3-7/8 inches (46 x 99 mm), 8 ohm x 2
Audio output power:	2.5W + 2.5W

## DVD/CD player

Signal system:	NTSC
Applicable disc:	1. DVD (12cm, 8cm) 2. CD (12cm, 8cm)
Frequency response:	DVD: 4Hz - 22KHz CD: 4Hz - 20KHz
Input:	Video : (RCA) 1 Vp-p/75ohm Audio : (RCA) -8 dB/50Kohm
Headphone Jack:	3.5mm Stereo mini-jack
Digital audio out:	0.5Vp-p 75ohms terminated
Pickup:	CD : Wavelength: 775 - 815 nm Maximum output power: 0.5 mW DVD : Wavelength: 650 - 666 nm Maximum output power: 2.0 mW

<b>ACCESSORIES:</b>	Remote control x 1 Batteries (2 x AA)
---------------------	--

# Appendix (Remote programming)

## REMOTE PROGRAMMING

### Setting the CATV Codes

You can program your remote to operate your cable box, satellite receiver by using the instructions and codes listed below. If the equipment does not respond to any of the codes listed below or to the code search function, use the remote control supplied by the manufacturer.

#### Cable Box or Satellite setup

The remote control is programmed with CATV and/or Satellite codes for power on, power off, channel up, channel down, and 10 key operation.

- 1) Find the CATV/Satellite brand from the list of codes shown below.
  - 2) Slide the 2-way selector switch to "CATV".
  - 3) Press and hold down the DISPLAY button.
  - 4) With the DISPLAY button held down, enter the first code number listed using the 10 key pad.
  - 5) Release the DISPLAY button.
  - 6) Confirm the operation of the Cable Box/Satellite receiver.
- If your CATV or Satellite box does not respond to the first code, try the others listed. If it does not respond to any code, try the Search Codes Function as shown below.

Cable Box	CODES	Cable Box	CODES
ABC	024	Pulsar	051, 032
Archer	032, 025	Puser	032
Cableview	051, 032	RCA	061, 070
Citizen	022, 051	Realistic	032
Curtis	058, 059	Regal	058, 064, 040, 041, 042, 045, 068
Diamond	024, 032, 025	Regency	034
Eagle	029	Rembrandt	037, 032, 051, 038
Eastern	034	Samsung	051
GC Brand	032, 051	Scientific Atlanta	057, 058, 059
Gemini	022, 043	SLMark	051, 047
General Instrument	065, 024, 025, 026, 027, 020, 021, 022, 057, 023	Sprucer	051, 056
Hamlin	040, 041, 042, 045, 058, 064	Stargate	032, 051
Hitachi	049, 024	Telecaption	067
Jerrold	065, 024, 025, 026, 027, 020, 021, 022, 057, 023	Televue	047, 051
Macom	049, 050, 051, 054	Texscan	044
Magnavox	033	Tocom	035, 036, 066
Memorex	030	Toshiba	050
Movietime	032, 051	Unika	032, 025
Oak	039, 037, 048	Universal	022, 032
Panasonic	055, 056, 060, 071	Videoway	052
Paragon	063	Viewstar	029, 030
Philips	028, 029, 030, 052, 053, 031, 069	Zenith	063, 046
Pioneer	047, 062	Zenith/Drake Satellite	046

Digital Satellite Systems	CODES	Digital Satellite Systems	CODES
Echostar	100, 113, 114	Philips	102, 103
Express VU	100, 113	Primestar	108
G.E.	106	Proscan	106, 109, 110
G.I.	108	RCA	106, 109, 110
Gradiente	112	Sony	107
Hitachi	104, 111	Star Choice	104, 108
HNS (Hughes)	104	Toshiba	101
Panasonic	105	Uniden	102, 103

#### Cable/Satellite Search Codes Function:

- 1) Slide the 2-Way Mode Selector switch to CATV.
- 2) Press the TV POWER and RETURN buttons. Hold for at least three seconds and release.
- 3) Press TV POWER, see if the CATV or Satellite box responds.
- 4) If there was a response, press RETURN. The operating codes are now set. If there was no response, repeat Step 3.  
If you repeat Step 3 a total of 52 times without a response, use the remote control which came with the equipment.
- 5) Press RETURN to exit.



# Memo

---

A series of horizontal dotted lines for writing.



**JVC COMPANY OF AMERICA**

Division of U.S. JVC CORP.  
1700 Valley Road  
Wayne, New Jersey 07470

**JVC CANADA, INC.**

21 Finchdene Square  
Scarborough, Ontario  
Canada M1X 1A7



## Free Manuals Download Website

<http://myh66.com>

<http://usermanuals.us>

<http://www.somanuals.com>

<http://www.4manuals.cc>

<http://www.manual-lib.com>

<http://www.404manual.com>

<http://www.luxmanual.com>

<http://aubethermostatmanual.com>

Golf course search by state

<http://golfingnear.com>

Email search by domain

<http://emailbydomain.com>

Auto manuals search

<http://auto.somanuals.com>

TV manuals search

<http://tv.somanuals.com>