

# JVC



## VIDEO CASSETTE RECORDER

# HR-S5950EU

**FIRST**  
See  
**AUTO SET UP**  
on **PAGE 10**

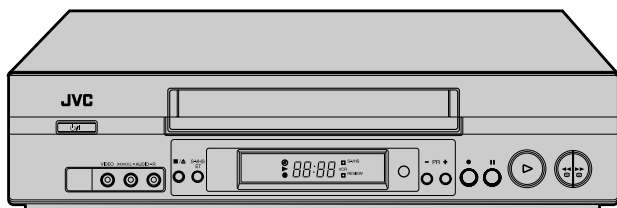

**SHOWVIEW<sup>®</sup> Hi-Fi SVHS**  
625  
**Super VHS ET**

## ENGLISH

### CONTENTS

<b>SAFETY FIRST</b>	<b>2</b>
Safety Precautions .....	2
<b>INDEX</b>	<b>4</b>
<b>INSTALLING YOUR NEW RECORDER</b>	<b>9</b>
Basic Connections .....	9
<b>INITIAL SETTINGS</b>	<b>10</b>
Auto Set Up .....	10
Language .....	13
<b>PLAYBACK</b>	<b>14</b>
Basic Playback .....	14
Playback Features .....	15
<b>RECORDING</b>	<b>18</b>
Basic Recording .....	18
Recording Features .....	19
B.E.S.T. Picture System .....	21
<b>TIMER RECORDING</b>	<b>22</b>
SHOWVIEW <sup>®</sup> Timer Programming .....	22
Express Timer Programming .....	24
<b>EDITING</b>	<b>28</b>
Edit From A Camcorder .....	28
Edit To Or From Another Video Recorder .....	29
Output/Input Set .....	30
<b>SYSTEM CONNECTIONS</b>	<b>32</b>
Connecting To A Satellite Receiver .....	32
Connecting/Using A Decoder .....	34
Connecting/Using A Stereo System .....	35
<b>SUBSIDIARY SETTINGS</b>	<b>36</b>
Mode Set .....	36
Tuner Set .....	40
Clock Set .....	46
Video Channel Set .....	48
SHOWVIEW <sup>®</sup> System Setup .....	49
<b>TROUBLESHOOTING</b>	<b>50</b>
<b>QUESTIONS AND ANSWERS</b>	<b>53</b>
<b>SPECIFICATIONS</b>	<b>54</b>
<b>LIST OF TERMS</b>	<b>55</b>

## INSTRUCTIONS

# EN

LPT0649-001B

# Safety Precautions

The rating plate and the safety caution are on the rear of the unit.

**WARNING: DANGEROUS VOLTAGE INSIDE**

**WARNING: TO PREVENT FIRE OR SHOCK HAZARD, DO NOT EXPOSE THIS UNIT TO RAIN OR MOISTURE.**

## CAUTION

- When you are not using the recorder for a long period of time, it is recommended that you disconnect the power cord from the mains outlet.
- Dangerous voltage inside. Refer internal servicing to qualified service personnel. To prevent electric shock or fire hazard, remove the power cord from the mains outlet prior to connecting or disconnecting any signal lead or aerial.

## WARNING

There are two different types of SECAM colour systems: SECAM-L, used in FRANCE (also called SECAM-West), and SECAM-B, used in Eastern European countries (also called SECAM-East).

1. This recorder can also receive SECAM-B colour television signals for recording and playback.
2. Recordings made of SECAM-B television signals produce monochrome pictures if played back on a video recorder of SECAM-L standard, or do not produce normal colour pictures if played back on a PAL video recorder with SECAM-B system incorporated (even if the TV set is SECAM-compatible).
3. SECAM-L prerecorded cassettes or recordings made with a SECAM-L video recorder produce monochrome pictures when played back with this recorder.
4. This recorder cannot be used for the SECAM-L standard. Use a SECAM-L recorder to record SECAM-L signals.

## IMPORTANT

- Please read the various precautions on pages 2 and 3 before installing or operating the recorder.
- It should be noted that it may be unlawful to re-record pre-recorded tapes, records, or discs without the consent of the owner of copyright in the sound or video recording, broadcast or cable programme and in any literary, dramatic, musical, or artistic work embodied therein.



- Cassettes marked "S-VHS" and "VHS" can be used with this video cassette recorder. However, S-VHS recordings are possible only with cassettes marked "S-VHS".  
By using the S-VHS ET function, it is possible to record and play back with S-VHS picture quality on VHS cassettes with this recorder.
- SHOWVIEW is a registered trademark of Gemstar Development Corporation. The SHOWVIEW system is manufactured under licence from Gemstar Development Corporation.

**For Italy:**

"It is declared that this product, brand JVC, conforms to the Ministry Decree n. 548 of 28 Aug.'95 published in the Official Gazette of the Italian Republic n. 301 of 28 Dec.'95"

The STANDBY/ON  $\phi$ /I button does not completely shut off mains power from the unit, but switches operating current on and off. " $\phi$ " shows electrical power standby and "I" shows ON.

Video tapes recorded with this video recorder in the LP (Long Play) mode cannot be played back on a single-speed video recorder.

When the equipment is installed in a cabinet or a shelf, make sure that it has sufficient space on all sides to allow for ventilation (10 cm or more on both sides, on top and at the rear.)

When discarding batteries, environmental problems must be considered and the local rules or laws governing the disposal of these batteries must be followed strictly.

**Failure to heed the following precautions may result in damage to the recorder, remote control or video cassette.**

**1. DO NOT place the recorder ...**

- ... in an environment prone to extreme temperatures or humidity.
- ... in direct sunlight.
- ... in a dusty environment.
- ... in an environment where strong magnetic fields are generated.
- ... on a surface that is unstable or subject to vibration.

**2. DO NOT block the recorder's ventilation openings or holes.**

(If the ventilation openings or holes are blocked by a newspaper or cloth, etc., the heat may not be able to get out.)

**3. DO NOT place heavy objects on the recorder or remote control.**

**4. DO NOT place anything which might spill on top of the recorder or remote control.**

(If water or liquid is allowed to enter this equipment, fire or electric shock may be caused.)

**5. DO NOT expose the apparatus to dripping or splashing.**

**6. DO NOT use this equipment in a bathroom or places with water. Also DO NOT place any containers filled with water or liquids (such as cosmetics or medicines, flower vases, potted plants, cups, etc.) on top of this unit.**

**7. DO NOT place any naked flame sources, such as lighted candles, on the apparatus.**

**8. AVOID violent shocks to the recorder during transport.**

**MOISTURE CONDENSATION**

Moisture in the air will condense on the recorder when you move it from a cold place to a warm place, or under extremely humid conditions—just as water droplets form in the surface of a glass filled with cold liquid. Moisture condensation on the head drum will cause damage to the tape. In conditions where condensation may occur, keep the recorder turned on for a few hours to let the moisture dry.

**ATTENTION**

**To mobile phone users:**

Using a mobile phone in the vicinity of the recorder may cause picture vibration on the TV screen or change the screen to a blue back display.

**On placing the recorder:**

Some TVs or other appliances generates strong magnetic fields. Do not place such appliance on top of the recorder as it may cause picture disturbance.

## FRONT VIEW

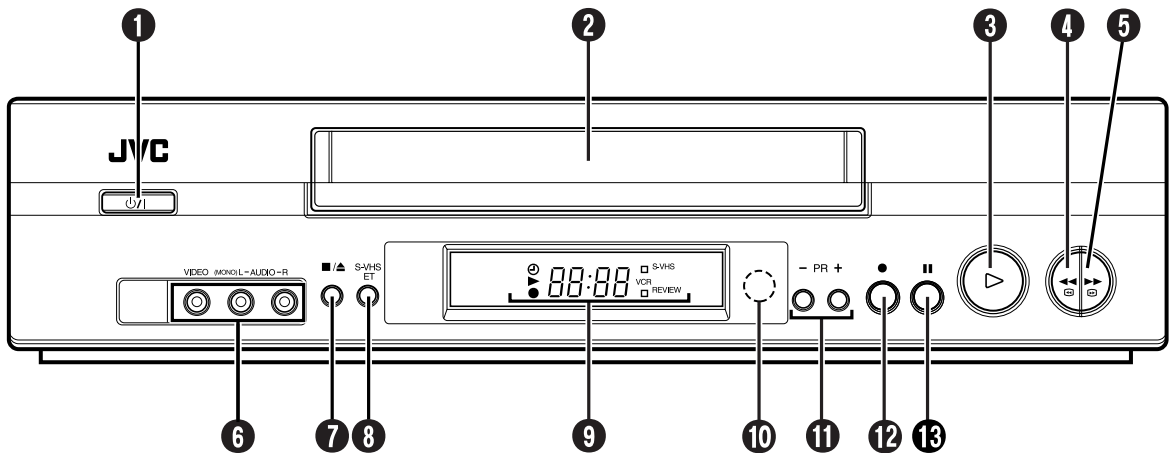

- ❶ STANDBY/ON ⏻/⏻ Button ☞ pg. 10
- ❷ Cassette Loading Slot
- ❸ Play ▶ Button ☞ pg. 14
- ❹ Rewind ◀◀ Button ☞ pg. 14, 15
- ❺ Fast Forward ▶▶ Button ☞ pg. 14, 15
- ❻ VIDEO/AUDIO Input Connectors ☞ pg. 28
- ❼ Stop/Eject ■/▲ Button ☞ pg. 14, 18
- ❽ S-VHS ET Button ☞ pg. 20
- ❾ Front Display Panel ☞ pg. 6
- ❿ Infrared Beam Receiving Window
- ⓫ PR +/- Buttons ☞ pg. 18
- ⓬ Record ● Button ☞ pg. 18
- ⓭ Pause || Button ☞ pg. 15

## REAR VIEW

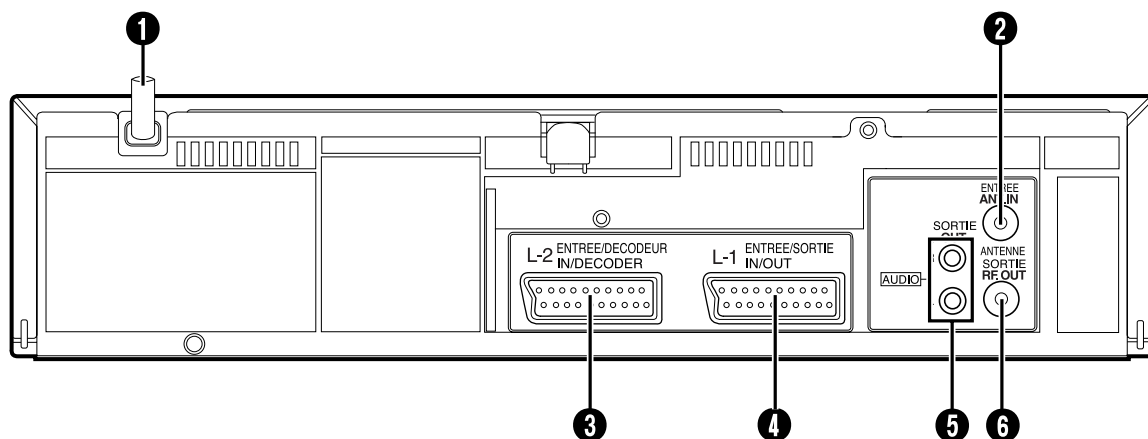

- ❶ Mains Power Cord ➤ pg. 9
- ❷ ANT. IN Connector ➤ pg. 9
- ❸ L-2 IN/DECODER Connector ➤ pg. 29, 32, 33, 34

- ❹ L-1 IN/OUT Connector ➤ pg. 9, 29, 32, 33, 34
- ❺ AUDIO OUT (L/R) Connectors ➤ pg. 35
- ❻ RF OUT Connector ➤ pg. 9

## FRONT DISPLAY PANEL

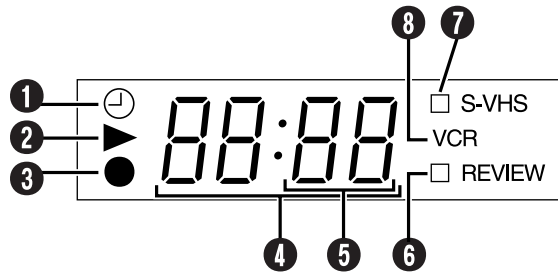

❶ "Timer" Indicator ☞ pg. 23, 25

❷ Play Indicator

❸ Record Indicator

❹ Channel/Clock Display ☞ pg. 12

To switch display, press --:--. Channel position is not displayed during playback.

Mode Display (L-1, L-2, F-1 or SAT\*)

\* When "L-2 SELECT" is set to "SAT" (☞ pg. 31), "SAT" appears instead of "L-2".

❺ Tape speed SP/LP/EP

\* EP is for NTSC playback only.

❻ Instant REVIEW Indicator ☞ pg. 16

❼ S-VHS Indicator ☞ pg. 20, 39

❽ VCR Indicator ☞ pg. 19

## ON-SCREEN DISPLAY

When "O.S.D." is set to "ON" (☞ pg. 37), various operational indicators appear on the TV screen.

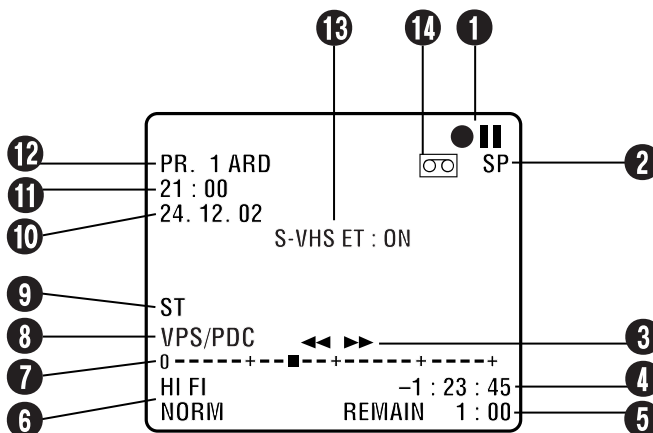

- ❶ Operation Mode Indicators
- ❷ Tape speed SP/LP/EP  
\* EP is for NTSC playback only.
- ❸ Tape Direction
- ❹ Counter Display
- ❺ Tape Remaining Time Indicator ☞ pg. 19
- ❻ Audio Mode Display ☞ pg. 17
- ❼ Tape Position Indicator
- ❽ VPS/PDC Indicator ☞ pg. 23, 25
- ❾ Type of broadcast ☞ pg. 20
- ❿ Current Day/Month/Year
- ⓫ Clock Display
- ⓬ Channel Position Number and Station Name/  
Auxiliary Input Indicator (L-1, L-2, F-1 or SAT\*)  
\* When "L-2 SELECT" is set to "SAT" (☞ pg. 31), "SAT" appears  
instead of "L-2".
- ⓭ S-VHS ET Indicator  
(S-VHS ET : ON/S-VHS ET : OFF) ☞ pg. 20, 39
- ⓮ "Cassette Loaded" Mark

The tape position indicator appears on the TV screen when you press ◀◀ or ▶▶ from the Stop mode or perform an Index Search (☞ pg. 16). The position of "■" in relation to "0" (beginning) or "+" (end) shows you where you are on the tape.

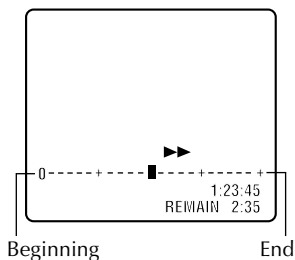

### NOTE:

Depending on the type of tape being used, the tape position indicator may not appear correctly.

## REMOTE CONTROL

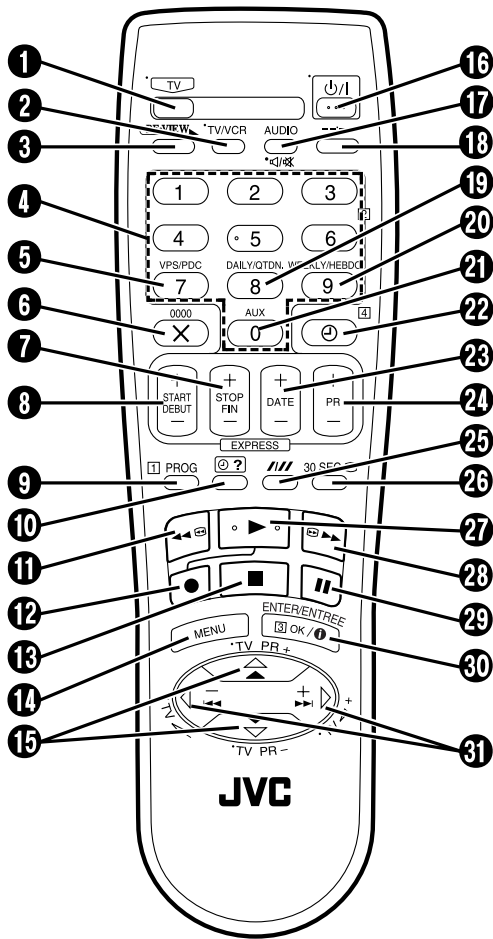

Buttons with a small dot on the left side of the name can also be used to operate your JVC TV while holding down the TV button. (☞ "Operating JVC TVs" in the right column)

This remote control transmits A code signals only; it is not applicable to B code signals.

- ① TV Button ☞ "Operating JVC TVs" in the right column
- ② TV/VCR Button ☞ pg. 19 and "Operating JVC TVs" in the right column
- ③ REVIEW Button ☞ pg. 16
- ④ Number Keys ☞ pg. 18, 22
- ⑤ VPS/PDC Button ☞ pg. 23, 25
- ⑥ Cancel X Button ☞ pg. 27
- ⑦ 0000 Button ☞ pg. 19
- ⑧ STOP +/- Button ☞ pg. 24
- ⑨ START +/- Button ☞ pg. 24
- ⑩ PROG Button ☞ pg. 22
- ⑪ Programme Check ? Button ☞ pg. 26

- ⑫ Rewind ◀◀ Button ☞ pg. 14, 15
- ⑬ Record ● Button ☞ pg. 18
- ⑭ Stop ■ Button ☞ pg. 14, 18
- ⑮ MENU Button ☞ pg. 13
- ⑯ △ ▽ Button ☞ pg. 10
- ⑰ TV PR +/- Button ☞ "Operating JVC TVs" below
- ⑱ STANDBY/ON ⏻ Button ☞ pg. 10
- ⑲ AUDIO Button ☞ pg. 17
- ⏸ (TV Muting) Button ☞ "Operating JVC TVs" below
- ⑳ Display -- : -- Button ☞ pg. 19
- ㉑ DAILY Button ☞ pg. 23, 25
- ㉒ WEEKLY Button ☞ pg. 23, 25
- ㉓ AUX Button ☞ pg. 28
- ㉔ Timer ⌚ Button ☞ pg. 23, 25
- ㉕ DATE +/- Button ☞ pg. 24
- ㉖ PR +/- Button ☞ pg. 18
- ㉗ Auto Tracking /// Button ☞ pg. 17
- SP/LP Button ☞ pg. 18
- ㉘ 30 SEC Button ☞ pg. 16
- ㉙ Play ▶ Button ☞ pg. 14
- ㉚ Fast Forward ▶▶ Button ☞ pg. 14, 15
- ㉛ Pause || Button ☞ pg. 15
- ㉜ OK Button ☞ pg. 11
- Information ⓘ Button\*
- \* If you press this button when "O.S.D." is set to "ON" (☞ pg. 37), you can see the current recorder status on the TV screen.
- ㉝ ◀ ▶ Button ☞ pg. 15, 16
- TV ◀ +/- Button ☞ "Operating JVC TVs" below

### How To Use

The remote control can operate most of your video recorder's functions, as well as basic functions of JVC TV sets. (☞ "Operating JVC TVs" below)

- Point the remote control toward the receiving window.
- The maximum operating distance of the remote control is about 8 m.

### Operating JVC TVs

To operate your TV, while holding down the TV button, press the corresponding button: ⏻, TV/VCR, TV PR +/-, TV ◀ +/-, ⏸ (TV Muting).

### NOTES:

- When inserting the batteries, be sure to insert in the correct directions as indicated under the battery cover.
- Depending on the type of JVC TV, some or all functions may not be operated using the remote control.
- If the remote control doesn't work properly, remove its batteries, wait a short time, replace the batteries and then try again.



# Basic Connections

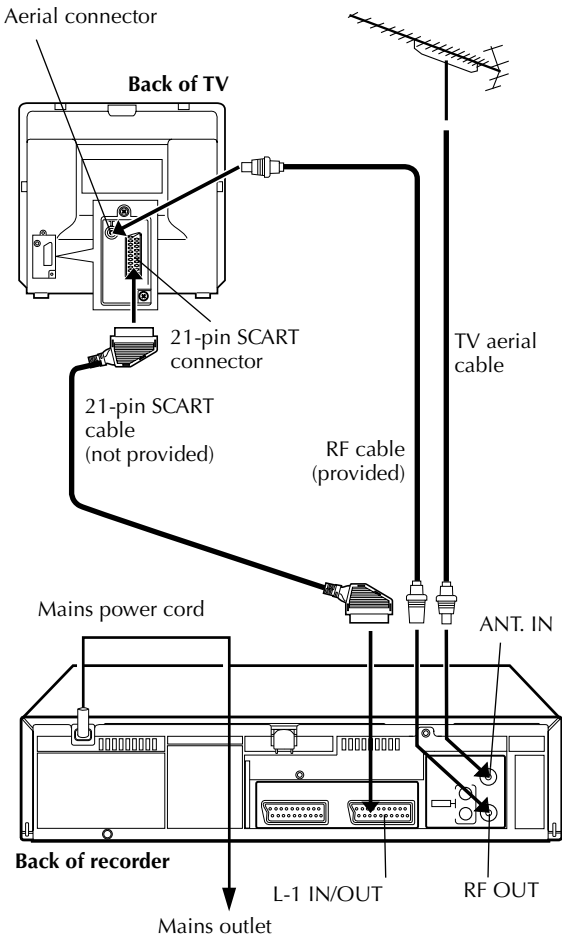

Make AV connection if your TV has a 21-pin AV input connector (SCART) in order to reduce the possibility of interference. With AV connection, you can enjoy stereo playback of video tapes if you are using a stereo TV.

## NOTES:

- The L-1 IN/OUT connector accepts only a composite signal (regular video signal) and delivers either a composite signal (regular video signal) or a Y/C signal (a signal in which the luminance and chrominance signals are separated). If your TV's 21-pin AV input connector (SCART) is compatible with the Y/C signal, set "L-1 OUTPUT" to "S-VIDEO" after the connection and the initial settings are completed (pg. 30). You can obtain high-quality S-VHS pictures. (For connection, be sure to use a 21-pin SCART cable that is compatible with the Y/C signal.)
- Set your TV to the VIDEO (or AV), Y/C, or RGB mode according to the type of your TV's SCART connector.
- For switching the TV's mode, refer to the instruction manual of your television.

It's essential that your video recorder be properly connected.

THESE STEPS MUST BE COMPLETED BEFORE ANY VIDEO OPERATION CAN BE PERFORMED.

## 1 Check the contents.

Make sure the package contains all of the accessories listed in "SPECIFICATIONS" on page 54.

## 2 Situate the recorder.

Place the recorder on a stable, horizontal surface.

## 3 Connect the recorder to TV.

The connection method you use depends on the type of TV you have.

### RF Connection

- To connect to a TV with NO AV input connectors . . .
- 1 Disconnect the TV aerial cable from the TV.
- 2 Connect the TV aerial cable to the ANT. IN connector on the rear panel of the recorder.
- 3 Connect the provided RF cable between the RF OUT connector on the rear panel of the recorder and the TV's aerial connector.

### AV Connection

- To connect to a TV with AV input connectors . . .
- 1 Connect the aerial, recorder and TV as per "RF Connection".
- 2 Connect an optional 21-pin SCART cable between the L-1 IN/OUT connector on the rear panel of the recorder and the TV's 21-pin SCART connector.

## 4 Connect the recorder to mains.

Plug the end of the mains power cord into a mains outlet.

After the connection is completed, perform "Auto Set Up" on page 10.

# Auto Set Up

## Auto Channel Set/Auto Clock Set/ Auto Guide Program Number Set



After the  $\odot/1$  button on the recorder or remote control is pressed for the first time to power on the recorder, by simply selecting your country\*, the Auto Set Up function sets the tuner channels, clock\*\* and Guide Program numbers automatically.

\* If you live in Belgium (BELGIUM) or Switzerland (SUISSE), you also need to select your language.

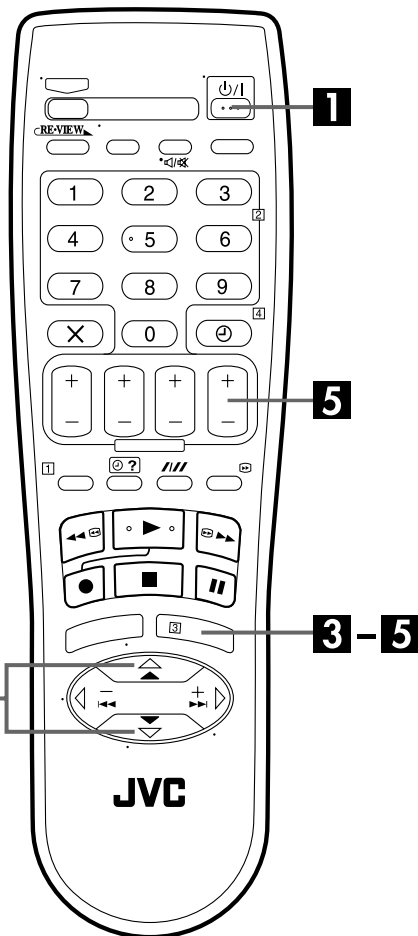
\*\* If you live in Hungary (MAGYARORSZÁG), Czech Republic (ČESKÁ REPUBLIKA), Poland (POLSKA) or other countries in Eastern Europe (OTHER EASTERN EUROPE), set the clock manually.



### Before starting, make sure of the following:

- The TV aerial cable should be connected to the recorder.
- The recorder's mains power cord should be connected to a mains outlet.
- The TV should be set to its AV mode (with AV connection  pg. 9) or UHF channel 36 (with RF connection  pg. 9).

## 1 Turn on the recorder.

Press  $\odot/1$  on the recorder or remote control. The Country Set display appears on the TV screen.

### NOTE:

If you have connected your TV to the recorder with RF connection and the on-screen display appearing on UHF channel 36 looks distorted, perform "Video Channel Set" on page 48.



## 2 Select your country.

Press  $\Delta/\nabla$  to move the highlight bar (pointer) to your country's name.

(Example) DEUTSCHLAND is selected.



### NOTES:

- If you have selected BELGIUM or SUISSE, go to step 3.
- If you have selected MAGYARORSZÁG, ČESKÁ REPUBLIKA, POLSKA or OTHER EASTERN EUROPE, press **OK**. The Clock Set screen will appear. Set the clock manually ( pg. 46), then go to step 4.
- If you have selected any other country name, go to step 4.

### 3 Select the language.

Press **OK**. The Language Set display appears on the TV screen.

Press  $\Delta \nabla$  to move the highlight bar (pointer) to the language of your choice.

(Example) DEUTSCH is selected.



### 4 Perform Auto Set Up.

Press **OK**.

“Auto” blinks on the front display panel; do NOT press any button on the recorder or remote control until the front display panel shows clock time, “(CH) 1” or “- - - -” as illustrated on page 12.

- If you are using the on-screen display, the AUTO SET screen will appear. As Auto Set Up progresses, the “█” mark on the TV screen moves from left to right.

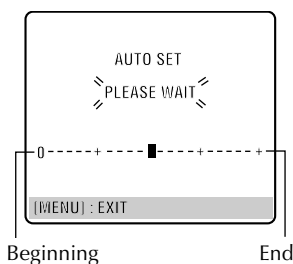

### ATTENTION

Once you have performed Auto Set Up, even if the recorder's memory backup has expired, all the stored stations and their Guide Program numbers remain in the recorder's memory and the recorder will not perform Auto Set Up again. You only need to set the clock. (☞ pg. 46)

If you have moved to a different area, perform each setting as required.

- Video channel setting (for RF connection users) ☞ pg. 48
- Tuner setting ☞ pg. 40
- Clock setting ☞ pg. 46

If a new station starts broadcasting in your area, perform tuner setting (☞ pg. 40) and, if necessary, video channel setting (☞ pg. 48).

### NOTES:

- In the area where no TV station transmits a PDC (Programme Delivery Control) signal, the recorder can perform neither Auto Clock Set nor Auto Guide Program Number Set.
- If there is a power cut, or if you press  $\psi/1$  or **MENU** while Auto Set Up is in progress, Auto Set Up will be interrupted; be sure to turn off the recorder power once and try again from step 1.
- Auto Clock Set may not function properly depending on the reception condition.
- If no sound accompanies the picture or the audio sounds unnatural on some channels that have been stored by Auto Set Up, the TV system setting for those channels may be incorrect. Select the appropriate TV system for those channels (☞ pg. 43, “INFORMATION”).

### 5 Confirm/Set video channel.

#### With RF connection

The video channel that is shown on the display panel is your video channel. Press **OK**.

- If you have selected MAGYARORSZÁG, ČESKÁ REPUBLIKA, POLSKA or OTHER EASTERN EUROPE in step 2 on page 10, “2” appears instead of “1”.
- To view picture signals from the recorder, set your TV to the video channel.

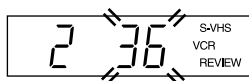
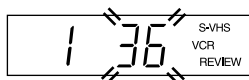

#### With AV connection

Press **PR** – until the display panel shows “1 - -” (or “2 - -”). Now the video channel is set to off. Then press **OK**.

- To view picture signals from the recorder, set your TV to its AV mode.

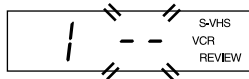

## Results of Auto Set Up appear on the front display panel

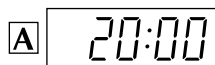

**If both Auto Channel Set and Auto Clock Set have been performed successfully, the correct current time is displayed.**

Turn on the TV and select its video channel or AV mode, then make sure that all necessary stations have been stored in the recorder's memory by using the **PR** button(s).

- If station names (ID –  pg. 45) have also been stored in the recorder's memory, the station name will be displayed at the top left corner of the TV screen for about 5 seconds when the recorder is tuned to a different station.
- If you want to set the tuner manually such as to add or skip channels, to change channel positions, or to set or change station names, see pages 42 – 45.



**If Auto Channel Set has succeeded but Auto Clock Set has not, "1" (channel position) is displayed.**

**1** Turn on the TV and select its video channel or AV mode, then make sure that all necessary stations have been stored in the recorder's memory by using the **PR** button(s).

- If station names (ID –  pg. 45) have also been stored in the recorder's memory, the station name will be displayed at the top left corner of the TV screen for about 5 seconds when the recorder is tuned to a different station.
- If you want to set the tuner manually such as to add or skip channels, to change channel positions, or to set or change station names, see pages 42 – 45.

**2** Perform "Clock Set" on page 46.

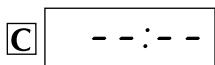



**If both Auto Channel Set and Auto Clock Set have failed, "--:--" is displayed.**

Make sure the cables are connected properly and turn off the recorder's power once, then turn the recorder's power back on again.

The Country Set display appears on the front display panel and/or on the TV screen; perform "Auto Set Up" on page 10 again.

### IMPORTANT

- To check if the Guide Program numbers have been set correctly, perform the SHOWVIEW Timer Programming ( pg. 22).
- In certain reception conditions, station names may not be stored correctly, and auto Guide Program Number Set may not work properly. If the Guide Program numbers are not set properly when you timer-record a TV programme using the SHOWVIEW system, the recorder will record a TV programme of a different station. When programming the timer using the SHOWVIEW system, be sure to check the desired channel is selected correctly ( pg. 22, "SHOWVIEW" Timer Programming).
- Your video recorder memorizes all detected stations even if reception of some of them is poor. You can delete those stations with an unacceptable picture ( pg. 43, "Delete A Channel").

### INFORMATION

#### Language for the on-screen display

Auto Set Up also selects the language automatically for the on-screen display depending on the Country setting you have made in step **2** on page 10 (unless you have selected BELGIUM or SUISSE), as shown below.

SUOMI	→ SUOMI	DANMARK	→ DANSK	NEDERLAND	→ NEDERLANDS
PORTUGAL	→ ENGLISH	ÖSTERREICH	→ DEUTSCH	GREECE	→ ENGLISH
DEUTSCHLAND	→ DEUTSCH	ČESKÁ REPUBLIKA	→ ČEŠTINA	OTHER WESTERN EUROPE	→ ENGLISH
POLSKA	→ POLSKI	ITALIA	→ ITALIANO	OTHER EASTERN EUROPE	→ ENGLISH
NORGE	→ NORSK	MAGYARORSZÁG	→ MAGYAR		
SVERIGE	→ SVENSKA	ESPAÑA	→ CASTELLANO		

If you want to change the language setting manually, see "Language" on page 13.

#### Just Clock

Your recorder is equipped with the Just Clock function which provides accurate time keeping through automatic adjustments at regular intervals, by reading data from a PDC signal. If you want to take advantage of this function, simply set it to "ON" ( pg. 46, "Just Clock").

# Language

Turn on the TV and select the video channel (or AV mode).

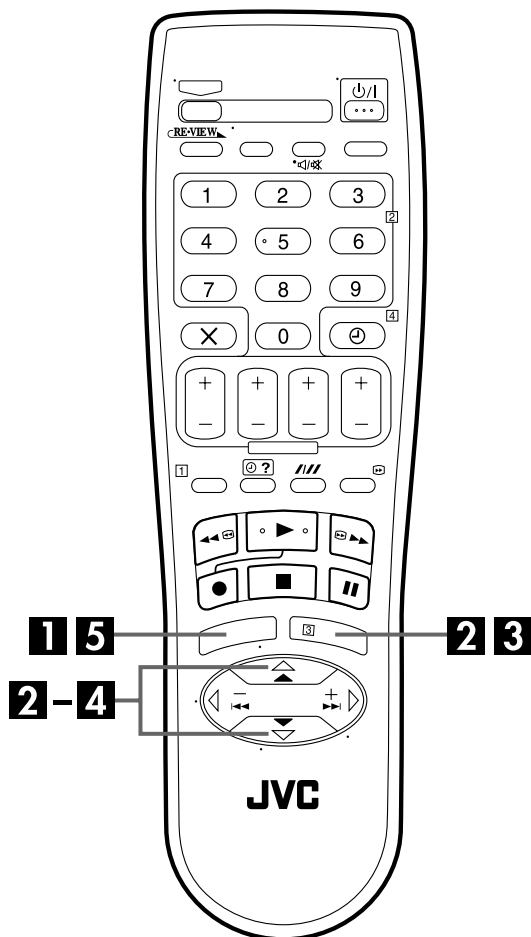

This recorder offers you the choice to view on-screen messages in 13 different languages. Though Auto Set Up selects the language automatically (pg. 12), you can change the language setting manually as required.

## 1 Access the Main Menu screen.

Press MENU.

## 2 Access the Country Set screen.

Press  $\Delta$ / $\nabla$  to move the highlight bar (pointer) to "AUTO CH SET", then press OK or  $\triangleright$ .

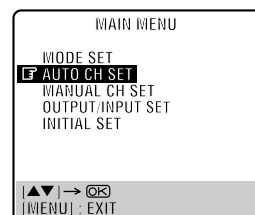

## 3 Select your country.

Press  $\Delta$ / $\nabla$  to move the highlight bar (pointer) to your country's name, then press OK or  $\triangleright$ .

## 4 Select the language.

Press  $\Delta$ / $\nabla$  to move the highlight bar (pointer) to the language of your choice.

- You do not have to press OK; pressing OK starts Auto Channel Set.



## 5 Return to the normal screen.

Press MENU.

# Basic Playback

Turn on the TV and select the video channel (or AV mode).

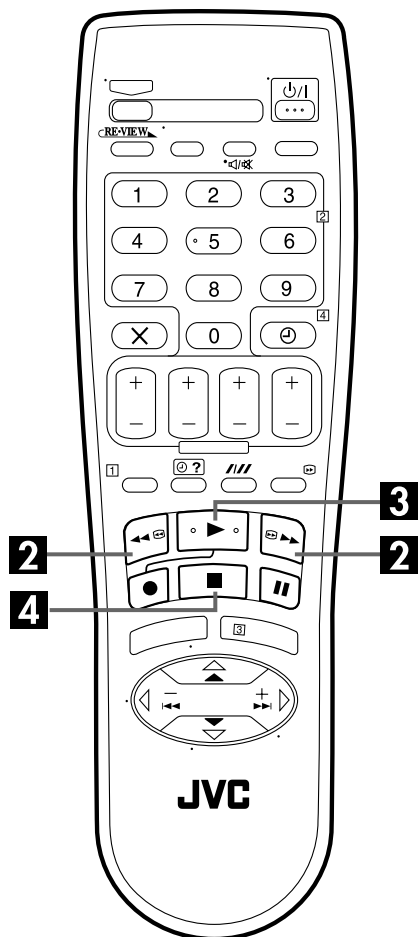
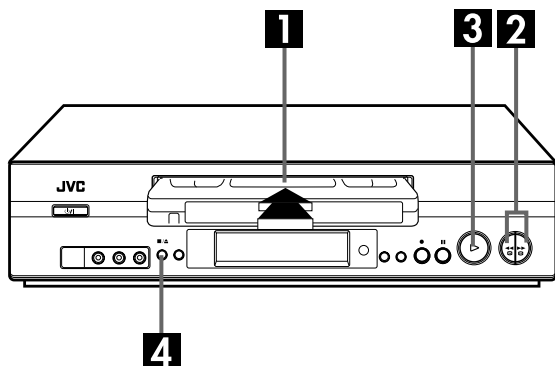

## 1 Load a cassette.

Make sure the window side is up, the rear label side is facing you and the arrow on the front of the cassette is pointed toward the recorder.

- Do not apply too much pressure when inserting.
- If the record safety tab has been removed, playback begins automatically.
- The recorder's power comes on automatically and the counter is reset to 0:00:00.

## 2 Find the programme start point.

If the tape is advanced past the start point, press ◀. To go forward, press ▶.

## 3 Start playback.

Press ▶. "bEST" appears blinking in the recorder's front display panel during automatic tracking. (☞ pg. 21)

## 4 Stop playback.

Press ■ on the remote control or ■/▲ on the recorder's front panel. Then press ■/▲ to remove the cassette.

### Clean the video heads using a dry cleaning cassette — TCL-2 — when:

- Rough, poor picture appears while a tape is played back.
- The picture is unclear or no picture appears.
- "USE CLEANING CASSETTE" appears on the screen (only with "O.S.D." set to "ON" (☞ pg. 37)).

### NOTE:

The heads get dirty in the following cases:

- in an environment prone to extreme temperature or humidity
- in a dusty environment
- flaw, dirt or mold on video tapes
- continuous usage for a long time

### Usable cassettes

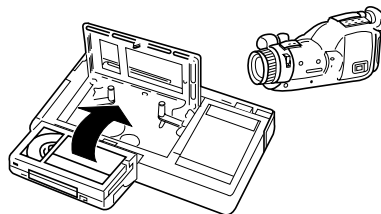

- Compact VHS camcorder recordings can be played on this video recorder. Simply place the recorded cassette into a VHS Cassette Adapter and it can be used just like any full-sized VHS cassette.
- This video recorder can record on regular VHS and Super VHS cassettes. While only VHS signals can be recorded on regular VHS cassettes\*, both VHS and Super VHS signals can be recorded and played back using Super VHS cassettes.

\* By using the S-VHS ET function, it is possible to record and play back with S-VHS picture quality on VHS cassettes with this recorder.

# Playback Features

## NOTE:

Refer to the illustrations below as you read the following procedures.

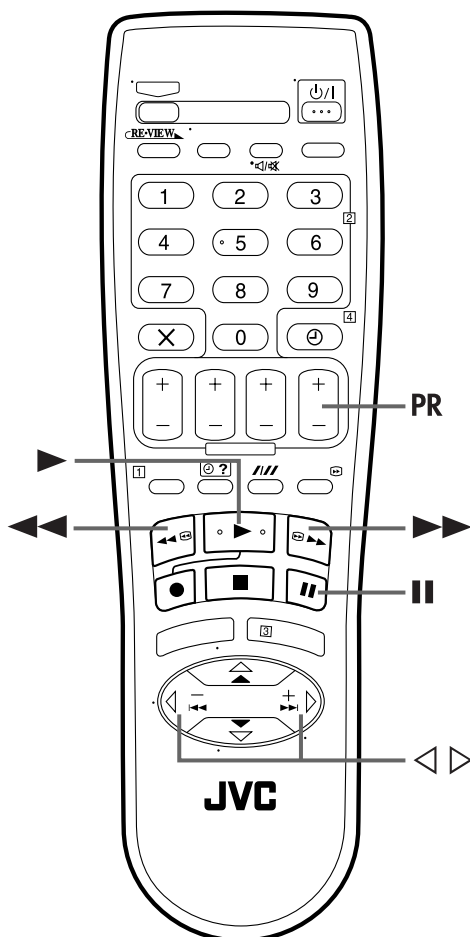
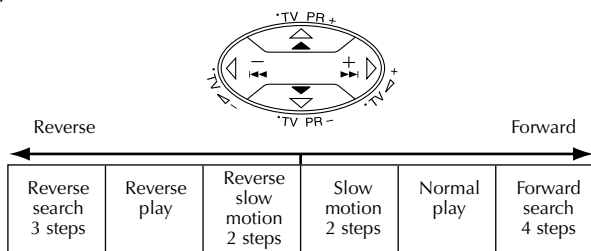

## ATTENTION

In the search, still, slow-motion or frame-by-frame playback mode,

- the picture will be distorted
- the noise bars will appear
- there will be a loss of color with an LP-recorded tape

## Still Picture/Frame-By-Frame Playback

### 1 Pause during playback.

Press **II**.

- If there is vertical jitter, use the **PR** buttons on the remote control to correct the picture.

### 2 Activate frame-by-frame playback.

Press **II**.

**OR**

Press **◀** or **▶**.

## Slow Motion

During still picture, press and hold **II** for 2 seconds, then release. Press **II** and release again to return to still picture.

**OR**

During still picture, press and hold **◀** or **▶**. Release to return to still picture.

## NOTE:

During slow motion playback, some noise may appear on the TV screen. Press **PR +** or **-** on the remote control to eliminate the noises.

## High-Speed (Turbo) Search

During playback or still, press **▶▶** for forward high-speed search, or **◀◀** for reverse high-speed search.

## NOTE:

For short searches, press and hold **▶▶** or **◀◀** for over 2 seconds during playback or still picture. When released, normal playback resumes.

To resume normal playback, press **▶**.

## Variable Speed Search

During playback, press ◀ or ▶.

- The more times you press, the faster the playback picture moves.
- To decrease speed, press the button for the opposite direction.

To resume normal playback, press ▶.

## Index Search

Your recorder automatically marks index codes at the beginning of each recording. This function gives you quick access to any one of 9 index codes in either direction.

### NOTE:

Before starting, make sure the recorder is in the Stop mode.



### Activate Index Search.

Press ◀ or ▶ (◀◀◀ or ▶▶▶). "◀◀◀ 1" or "▶▶▶ 1" is displayed on the TV screen and search begins in the corresponding direction.

- To access index codes 2 through 9, press ◀ or ▶ repeatedly until the correct index number is displayed.

#### Example:

To locate the beginning of B from the current position, press ◀ twice.

To locate the beginning of D from the current position, press ▶ once.

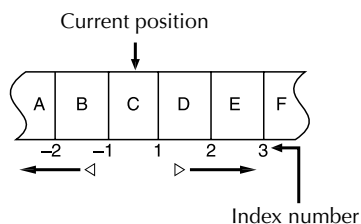

- When the specified index code is located, playback begins automatically.

## Skip Search

During playback, press **30 SEC** 1 to 4 times to skip over unwanted sections.

Each press initiates a 30-second period of fast-motion playback. Normal playback resumes automatically.

To resume normal playback during a Skip Search, press ▶.

## Instant ReView

Simply by pressing a single button, the recorder power comes on, rewinds, and begins playback of the last timer-recorded programme. If you have several programmes recorded, you can easily access any of them.

### NOTE:

Before starting, make sure that the recorder is off and that the Timer mode is disengaged.

### Activate Instant ReView.

Press **REVIEW**. The recorder power comes on and the recorder searches for the index code indicating the start of the last timer-recorded programme. Once it's found, playback begins automatically.

- The front display panel tells you how many programmes have been timer-recorded. If you have, for example, 3 programmes, the Instant REVIEW indicator and "3" blink. To watch the first of the 3 programmes, press **REVIEW** three times. The recorder searches and begins playback automatically. You can access a programme as far as 9 index codes away from the current tape position.



## Next Function Memory

The Next Function Memory "tells" the recorder what to do after rewinding. Before continuing, make sure the recorder is in the Stop mode.

- a- For Automatic Start Of Playback  
Press ◀◀, then press ▶ within 2 seconds.
- b- For Automatic Power Off  
Press ◀◀, then press ⏻ within 2 seconds.
- c- For Automatic Timer Standby  
Press ◀◀, then press ⊕ (TIMER) within 2 seconds.

## Repeat Playback

Your recorder can automatically play back the whole tape 100 times repeatedly.

### 1 Start playback.

Press ▶.

### 2 Activate Repeat Playback.

Press ▶ and hold for over 5 seconds, then release.

- The Play indicator (▷) on the front display panel blinks slowly.
- After playing back a tape 100 times, the recorder stops automatically.

### 3 Stop Repeat Playback.

Press ■ at any time.

- Pressing ▶, ◀◀, ▶▶ or || also stops Repeat Playback.

## Manual Tracking

Your recorder is equipped with automatic tracking control. During playback, you can override this and adjust the tracking manually by pressing the PR buttons.

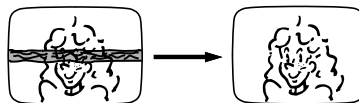

### 1 Override automatic tracking.

Press **///** on the remote control.

### 2 Adjust the tracking manually.

Press **PR +** or **-** on the remote control.

- Press **///** again to return to automatic tracking.

### NOTE:

*When a new tape is inserted, the recorder enters the automatic tracking mode automatically.*

## Soundtrack Selection

Your recorder is capable of recording three soundtracks (HI-FI L, HI-FI R and NORM) and will play back the one you select.

### During Playback

Pressing **AUDIO** changes the soundtrack as follows:

TRACK	USE
<b>On-Screen Display</b>	
HI FI L ▶ ◀ R	For Hi-Fi stereo tapes
HI FI L ▶	For main audio of Bilingual tapes
HI FI ◀ R	For sub audio of Bilingual tapes
NORM	For audio-dubbed tapes
HI FI NORM	For audio-dubbed tapes

### NOTES:

- "HI FI L ▶ ◀ R" should normally be selected. In this mode, Hi-Fi stereo tapes are played back in stereo, and the normal audio track is played back automatically for tapes with only normal audio.
- For instructions on recording stereo and bilingual programmes, refer to page 20.
- "O.S.D." must be set to "ON" or the on-screen displays will not appear (☞ pg. 37).

# Basic Recording

Turn on the TV and select the video channel (or AV mode).

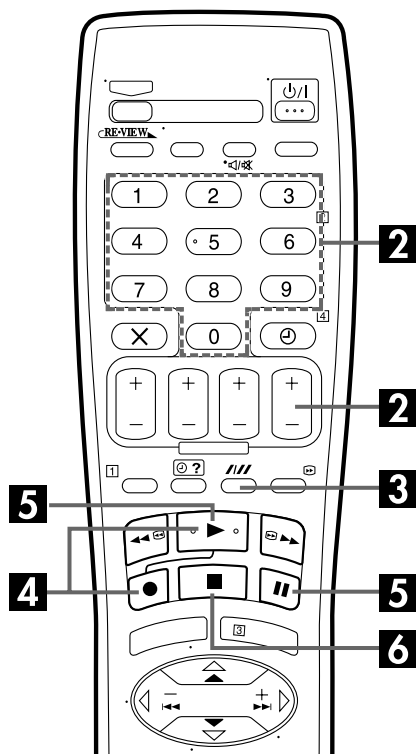
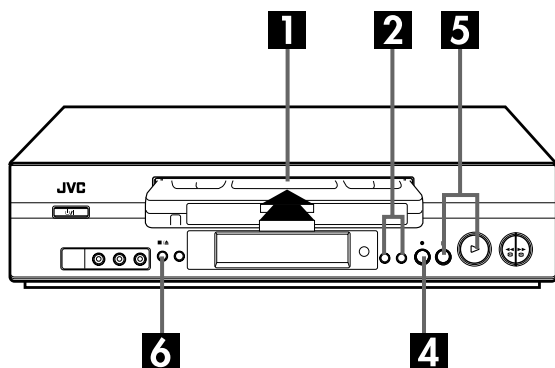

## Recording Resume Function

If there is a power outage during recording, Instant Timer Recording (pg. 19) or timer recording (pg. 22, 24), the recording will resume automatically when power is restored to the recorder unless the recorder's memory backup has expired.

### NOTE:

If a power outage exceed the recorder's memory backup time, Recording Resume Function does not work.

## 1 Load a cassette.

Insert a cassette with the record safety tab intact.

- The recorder's power comes on automatically and the counter is reset to 0:00:00.

## 2 Choose a programme.

Press **PR +/-** or the **number keys** to select the channel you wish to record.

## 3 Set the tape speed.

Press **SP/LP (//)**. The current setting appears on the front display panel or TV screen. Press **SP/LP (//)** again to change the setting while the tape speed is displayed on the TV screen.

## 4 Start recording.

Press and hold **●** and press **▶** on the remote control, or press **●** on the recorder.

B.E.S.T. takes place at the beginning of both the first SP and the first LP recording after inserting the cassette. (pg. 21)

## 5 Pause/Resume recording.

Press **||**. Press **▶** to resume recording.

## 6 Stop recording.

Press **■** on the remote control or **■/▲** on the recorder. Then press **■/▲** to remove the cassette.

### Accidental erasure prevention

To prevent accidental recording on a recorded cassette, remove its safety tab. To record on it later, cover the hole with adhesive tape.

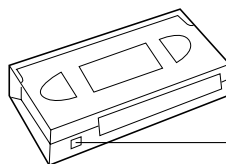

# Recording Features

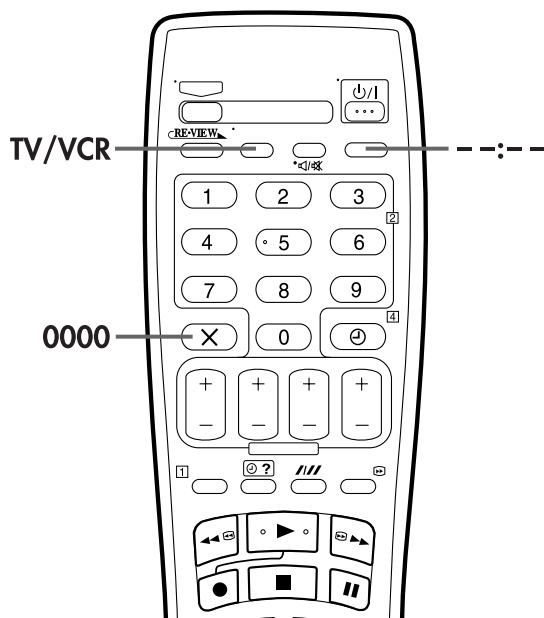
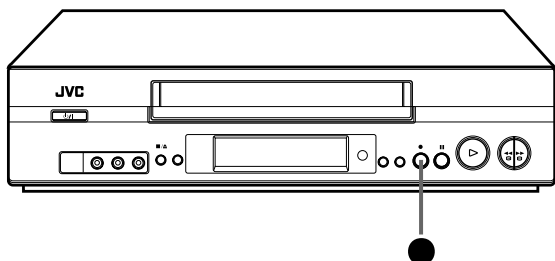

## Record One Programme While Watching Another

If your recorder is connected to the TV via the AV connection, press **TV/VCR**. The recorder's VCR indicator and the TV broadcast being recorded disappear. Once recording is in progress, all you need to do is to set the channel controls on the TV for the station you wish to view.

- The programme selected with the TV's channel controls appears on the TV screen, while the one selected with the recorder's **PR** buttons is recorded on the tape.
- If a decoder is connected to the recorder (see pg. 34), you can select a scrambled channel as well with the TV channel controls.

## Instant Timer Recording (ITR)

This easy method lets you record for from 30 minutes to 6 hours (selectable in 30-min. increments), and shuts the recorder off after recording is finished.

### 1 Start recording.

Press ● on the recorder.

### 2 Engage the ITR mode.

Press ● again. "O" blinks and "0:30" appears on the front display panel.

### 3 Set the recording duration.

If you want to record for more than 30 minutes, press ● to extend the time. Each press extends recording time by 30 minutes.

### NOTE:

You can only perform ITR using the ● button on the recorder's front panel.

## Elapsed Recording Time Indication

### 1 Display the counter.

Press --:-- so that a counter reading appears on the TV screen.

### 2 Reset the counter.

Press 0000 before starting recording or playback.

- The counter is reset to "0:00:00" and shows the exact elapsed time as the tape runs. You can check the exact time of a recording or playback.

## Tape Remaining Time

Press --:-- so that the time remaining on the tape appears on the TV screen.

### NOTE:

Depending on the type of tape being used, the tape remaining time reading may not appear right away, or is not correct. "--:--" may sometimes appear, or the display may blink on occasion.

## Super VHS ET (S-VHS ET)

### — Recording on VHS cassettes with S-VHS quality

You can record in SP mode on VHS cassettes with S-VHS picture quality. Tapes recorded using this function can be played back on a recorder equipped with the S-VHS ET function.

- You can activate the S-VHS ET function only before you start recording on a VHS cassette.
- Before recording, make sure that "B.E.S.T." is set to "ON". (☞ pg. 37)

### Engage the S-VHS ET mode.

Press **S-VHS ET** on the recorder. You can check the current setting ("S-VHS ET : ON" or "S-VHS ET : OFF") if "O.S.D." is set to "ON" (☞ pg. 37). If "S-VHS ET : OFF" appears on the TV screen, press **S-VHS ET** again in about 5 seconds to set it to "ON".

- The S-VHS indicator lights up on the front display panel.

### NOTES:

- You cannot activate the S-VHS ET function ...
  - ... while recording is in progress.
  - ... while timer-recording or Instant Timer Recording (☞ pg. 19) is in progress.
  - ... while B.E.S.T. (☞ pg. 21) is in progress.
- The S-VHS ET function does not work ...
  - ... with S-VHS cassettes.
  - ... with recordings in LP mode.
- To keep the highest quality recording and playback pictures over a long period of time, S-VHS recording on S-VHS cassettes is recommended.
- Use of high grade tapes is recommended for S-VHS ET recordings. On some tapes, picture quality will not improve even if the S-VHS ET function is used. Check the recording quality before you start important recordings.
- You can play back a tape recorded using the S-VHS ET function on most of S-VHS recorders and of VHS recorders equipped with SQPB (S-VHS QUASI PLAYBACK) function. (Notice some recorders are not compatible with the S-VHS ET function.)
- While playing back a tape recorded using the S-VHS ET function on some recorders, noise may appear. (If playback picture becomes blurred or interrupted, use a cleaning cassette.)
- In the high-speed search, still, slow-motion or frame-by-frame playback modes (☞ pg. 15), noise may appear. If these modes are performed frequently on a tape recorded using the S-VHS ET function, the tape may be damaged and the picture may be deteriorated.

## Receiving Stereo and Bilingual Programmes

Your recorder is equipped with a Sound-Multiplex decoder (A2) and a Digital stereo sound decoder (NICAM) making reception of stereo and bilingual broadcasts possible.

When the channel is changed, the type of broadcast being received will be displayed on the TV screen for a few seconds.

Type of Broadcast Being Received	On-screen Display
A2 Stereo	ST
A2 Bilingual	BIL.
Regular Monaural	(none)
NICAM Stereo	ST NICAM
NICAM Bilingual	BIL. NICAM
NICAM Monaural	NICAM

- To listen to a stereo programme, press **AUDIO** until "HIFI L [ ] R" appears on the TV screen.
- To listen to a bilingual programme, press **AUDIO** until "HIFI L [ ] R" or "HIFI [ ] R" appears on the TV screen.
- To listen to the standard (Regular Monaural) audio while receiving a NICAM broadcast, press **AUDIO** until "NORM" appears on the TV screen.

### NOTE:

"O.S.D." must be set to "ON" or the on-screen displays will not appear (☞ pg. 37).

### To Record Stereo and Bilingual Programmes (A2)

Stereo programmes are automatically recorded in stereo on the Hi-Fi audio track (with the normal audio track recording mixed L and R channel sound).

- Bilingual programmes are automatically recorded in bilingual on the Hi-Fi audio track. The main soundtrack will be recorded on the normal audio track.

### To Record NICAM Stereo and Bilingual Programmes

The NICAM audio programme will be recorded on the Hi-Fi audio track, and the standard audio programme will be recorded on the normal audio track.

### NOTES:

- If the quality of stereo sound being received is poor, the broadcast will be received in monaural with better quality.
- Before playing back a programme recorded in stereo, or a bilingual programme, refer to "Soundtrack Selection" on page 17.

# B.E.S.T. Picture System

The B.E.S.T. (Biconditional Equalised Signal Tracking) system checks the condition of the tape in use during playback and recording, and compensates to provide the highest-possible playback and recording pictures. You can set "B.E.S.T." to "ON" or "OFF" to your preference (ⓘ pg. 37).

## Playback

The recorder assesses the quality of the tape once you initiate playback.

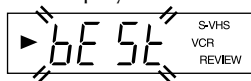

- The recorder adjusts the playback picture quality based on the quality of the tape in use.
- B.E.S.T. is active during automatic tracking. "bEst" appears blinking on the recorder's front display panel.

### NOTES:

- When watching a tape recorded with "B.E.S.T." set to "ON", it is recommended that you leave B.E.S.T. on during playback as well.
- When watching a rental tape or one recorded on another video recorder, or when using this recorder as the player for editing, set B.E.S.T. to your preference (ⓘ pg. 37).
- "bEst" only appears at the beginning of automatic tracking. Even though it doesn't appear after that, the B.E.S.T. function is operative.

## Recording

The recorder assesses the quality of the tape once you initiate recording.

### DURING B.E.S.T.

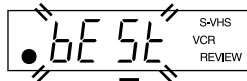

### B.E.S.T. COMPLETE



- The recorder spends approximately 7 seconds assessing the condition of the tape, then begins recording.

### NOTES:

- The B.E.S.T. system works for both SP and LP modes only after a tape has been inserted and the Record mode is first initiated. It does not work during recording.
- In the case of timer recordings, the B.E.S.T. system works before recording is initiated.
- Once the cassette is ejected, the B.E.S.T. data is cancelled. The next time the cassette is used for recording, B.E.S.T. is re-performed.
- Pressing the recorder's ● button while "bEst" is displayed does not start Instant Timer Recording (ⓘ pg. 19).

### ATTENTION

Since the B.E.S.T. system works before recording actually starts, there is a delay of approximately 7 seconds after ● and ► on the remote control are pressed, or ● on the recorder is pressed. To make sure you record the desired scene or programme in its entirety, first perform the following steps:

- 1 Press and hold **II** and press ● to engage the Record Pause mode.
  - The recorder then automatically checks the condition of the tape and, after approximately 7 seconds, re-enters Record Pause mode.
  - 2 Press ► to start recording.
- If you want to bypass the B.E.S.T. system and begin recording immediately, set "B.E.S.T." to "OFF" (ⓘ pg. 37).

# SHOWVIEW® Timer Programming

## Before performing the SHOWVIEW Timer Programming:

- Make sure that the recorder's built-in clock is set properly.
- Insert a cassette with the safety tab in place. The recorder will come on automatically.
- Turn on the TV and select the video channel (or AV mode).

With the SHOWVIEW system, timer programming is greatly simplified because each TV programme has a corresponding code number which your recorder is able to recognize.

## 1 Access the SHOWVIEW screen.

Press **PROG.**

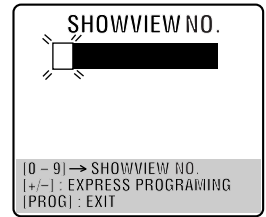

## 2 Enter the SHOWVIEW number.

Press the **number keys** to enter the SHOWVIEW number of a programme you wish to record.

- If you make a mistake, press **X** and input the correct number.

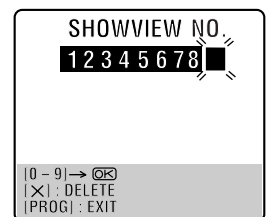

## 3 Access the SHOWVIEW Program screen.

Press **OK**, then the SHOWVIEW Program screen appears (if you're just starting out, "P1" appears).

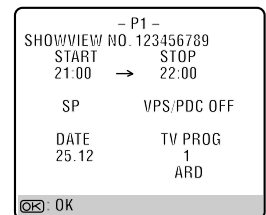

### IMPORTANT

Make sure the channel position number you wish to record is displayed; if not, see "SHOWVIEW" System Setup" on page 49 and set the Guide Program number correctly.

- If the number you entered is invalid, "ERROR" appears on the TV screen. Press **X** and input a valid SHOWVIEW number.
- If the "GUIDE PROG SET" screen appears, see "ATTENTION" on page 23.

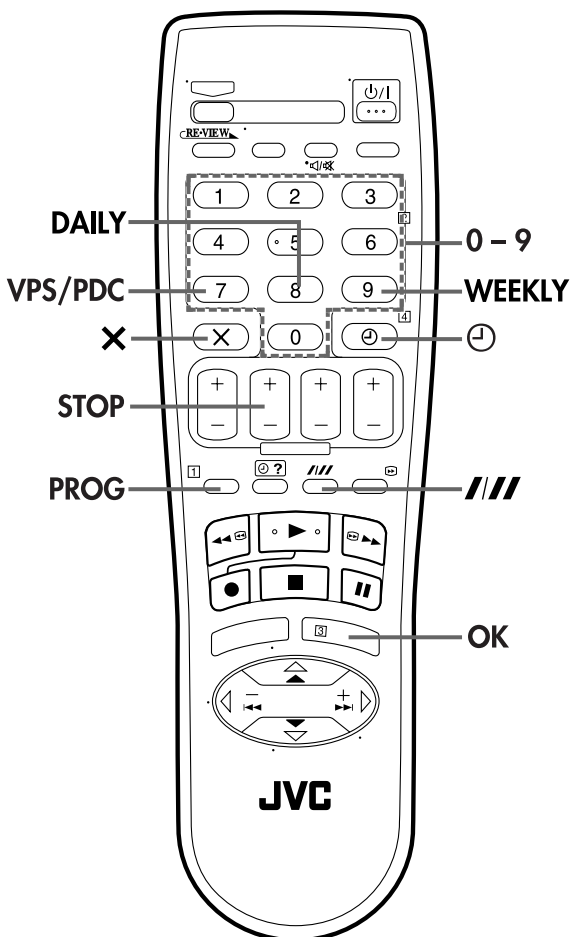

## 4 Set the tape speed.

Press **SP/LP** (//).

## 5 Set the VPS/PDC mode.

Press **VPS/PDC** to select "ON" or "OFF".

- If "VPS/PDC ON" is displayed on the TV screen, VPS/PDC is set to ON.
  - If "VPS/PDC OFF" is displayed on the TV screen, VPS/PDC is set to OFF.
- ☞ "VPS/PDC Recording" on page 25.

## 6 Return to the normal screen.

Press **PROG** or **OK**. "PROGRAM COMPLETED" appears on the TV screen for about 5 seconds, then the normal screen appears.

- Repeat steps 1 – 6 for each additional programme.

## 7 Engage the recorder's timer mode.

Press **⊖ (TIMER)**. The recorder turns off automatically and "⊖" appears on the front display panel.

- To disengage the timer mode, press **⊖ (TIMER)** again.

## NOTES:

- To Change The Stop Time . . .  
. . . press **STOP +/-** after pressing **OK** in step 3. You can compensate for anticipated programme schedule delays.
- To Timer-Record Weekly Or Daily Serials . . .  
. . . after pressing **OK** in step 3, press **WEEKLY** (number key "9") for weekly serials or **DAILY** (number key "8") for daily serials (Monday — Friday). Either "WEEKLY" or "DAILY" appears on the TV screen. Pressing the button again makes the corresponding indication disappear.
- You can programme this recorder to timer-record as many as 8 programmes. If you try to programme the recorder to record a ninth, "PROGRAM FULL" appears on the TV screen. To record the extra programme, you must first cancel any unnecessary programmes (☞ pg. 26).
- It is not possible to timer-record a TV programme with a SHOWVIEW number which starts with "0".
- If there is a conflict in the timer schedule and one programme overlaps with another, the programme starting earlier or programme with the lower programme number will be recorded.

### Satellite Receiver Users

To timer-record a satellite broadcast using the SHOWVIEW system:

- 1 Set "L-2 SELECT" to "AN" (☞ pg. 31).
- 2 Perform steps 1 – 7.
- 3 Set the satellite receiver to the appropriate channel before the selected programme begins.
- 4 Leave the satellite receiver's power on.

## ATTENTION

### Guide Program Number Set

"GUIDE PROG SET" appears after performing step 3 if the Guide Program number for the SHOWVIEW number you entered has not been set.

- Press the **number keys** or **△▽** to input the channel position number on which your recorder receives that station, then press **OK** or **▷** to set the Guide Program number. The SHOWVIEW Program screen appears.

(Example)  
To timer-record a ZDF programme with the SHOWVIEW system.

\* If your recorder receives ZDF on the channel position 2, press **OK** or **▷** after entering "2".

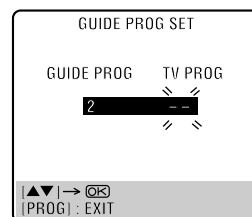

# Express Timer Programming

## Before performing Express Timer Programming:

- Make sure that the recorder's built-in clock is set properly.
- Insert a cassette with the safety tab in place. The recorder will come on automatically.
- Turn on the TV and select the video channel (or AV mode).

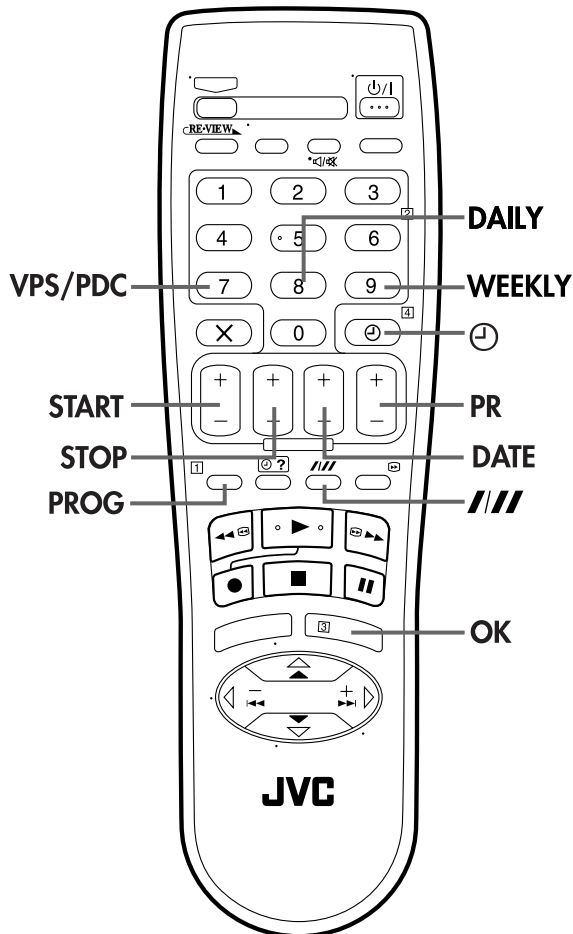

If you do not know the SHOWVIEW number for the programme you wish to record, use the following procedure to set your recorder to timer-record the programme.

## 1 Access the SHOWVIEW screen.

Press **PROG**.

## 2 Access the Programme screen.

Press **START+/-**. (If you're just starting out, "P1" appears.)

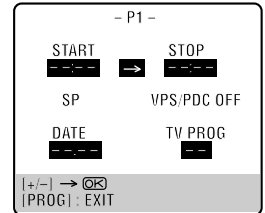

## 3 Enter the programme start time.

Press **START+/-** to enter the time you want recording to start.

- Press and hold **START+/-** to move in 30-minute increments, or press and release repeatedly to move 1 minute at a time.

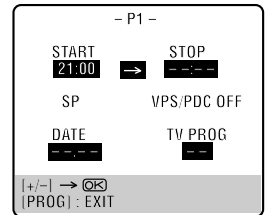

## 4 Enter the programme stop time.

Press **STOP+/-** to enter the time you want recording to stop.

- Press and hold **STOP+/-** to move in 30-minute increments, or press and release repeatedly to move 1 minute at a time.

## 5 Enter the programme date.

Press **DATE+/-**.

- The current date appears on the TV screen. The date you enter appears in its place.



## 6 Enter the channel position.

Press **PR+/-**.

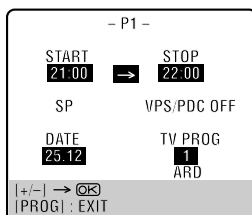

## 7 Set the tape speed.

Press **SP/LP (//)**.

## 8 Set the VPS/PDC mode.

Press **VPS/PDC** to select "ON" or "OFF".

- If "VPS/PDC ON" is displayed on the TV screen, VPS/PDC is set to ON.
  - If "VPS/PDC OFF" is displayed on the TV screen, VPS/PDC is set to OFF.
- ☞ "VPS/PDC Recording" in the right column.

## 9 Return to the normal screen.

After confirming all information is correct, press **PROG** or **OK**. "PROGRAM COMPLETED" appears on the TV screen for about 5 seconds, then the normal screen appears.

- Repeat steps 1 – 9 for each additional programme.

## 10 Engage the recorder's timer mode.

Press **⊖ (TIMER)**. The recorder turns off automatically and "⊖" appears on the front display panel.

- To disengage the timer mode, press **⊖ (TIMER)** again.

### To Timer-Record Weekly Or Daily Serials . . .

. . . anytime during steps 2 through 8, press **WEEKLY** (number key "9") for weekly serials or **DAILY** (number key "8") for daily serials (Monday – Friday). Either "WEEKLY" or "DAILY" appears on the TV screen. Pressing the button again makes the corresponding indication disappear.

## NOTES:

- You can programme this recorder to timer-record as many as 8 programmes. If you try to programme the recorder to record a ninth, "PROGRAM FULL" appears on the TV screen. To record the extra programme, you must first cancel any unnecessary programmes (☞ pg. 26).
- If there is a conflict in the timer schedule and one programme overlaps with another, the programme starting earlier or programme with the lower programme number will be recorded.

### Satellite Receiver Users

To timer-record a satellite broadcast using Express Timer Programming:

- 1 Set "L-2 SELECT" to "A/N" (☞ pg. 31).
- 2 Perform steps 1 – 10. Enter "L-2" for the channel position in step 6.
- 3 Set the satellite receiver to the appropriate channel before the selected programme begins.
- 4 Leave the satellite receiver's power on.

## VPS/PDC Recording

Now available from some TV stations, PDC (Programme Delivery Control) and VPS (Video Programme System) are service designed to assure safe, accurate timer recording. With this system, special code signals are transmitted together with the audio/video signals. These code signals control your video recorder and have precedence over the advertised times you may have preset into the timer. This means that your recorder will start and stop recording when the preset TV programmes actually start and end — even if the broadcast time of a preset TV programme is changed.

## NOTES:

- When you use *Express Timer Programming*, set the start time (VPS or PDC time) exactly as advertised in the TV listing. A different time than advertised will result in no recording.
- VPS/PDC recording is also possible when a satellite receiver or a cable system is connected to L-2 IN/DECODER connector on your recorder.
- VPS/PDC recording is also possible via the L-1 IN/OUT connector.

### How to check if the station being received transmits a VPS/PDC signal

- 1 Press **--:--** until the channel position appears on the front display panel.
- 2 Hold down **START+** for about 5 seconds. "VPS/PDC" appears blinking on the TV screen. If a VPS/PDC signal is detected from the station, "VPS/PDC" will stop blinking. If no VPS/PDC signal is detected from the station, "VPS/PDC" will blink at a slower rate.
- 3 Press **--:--** or **START+** again to return to normal display.

## Check, cancel and change programmes

### 1 Disengage the timer mode.

Press  $\ominus$  (TIMER), then press  $\psi/!$ .

### 2 Access the Programme Check screen.

Press  $\ominus ?$ .

	START	STOP	CH	DATE
1	8:00	10:00	3	24.12
2	10:00	10:45	2	25.12
3	11:30	13:00	1	25.12
4				
5				
6				
7				
8				

$\ominus ?$  : NEXT

### 3 Access the Programme screen.

Press  $\ominus ?$  again to check more information. Each time you press  $\ominus ?$ , the next programme's information appears.

- P1 -	
START	STOP
8:00	→ 10:00
SP	VPS/PDC OFF
DATE	TV PROG
24.12	3
	WDR

$\ominus ?$  : NEXT

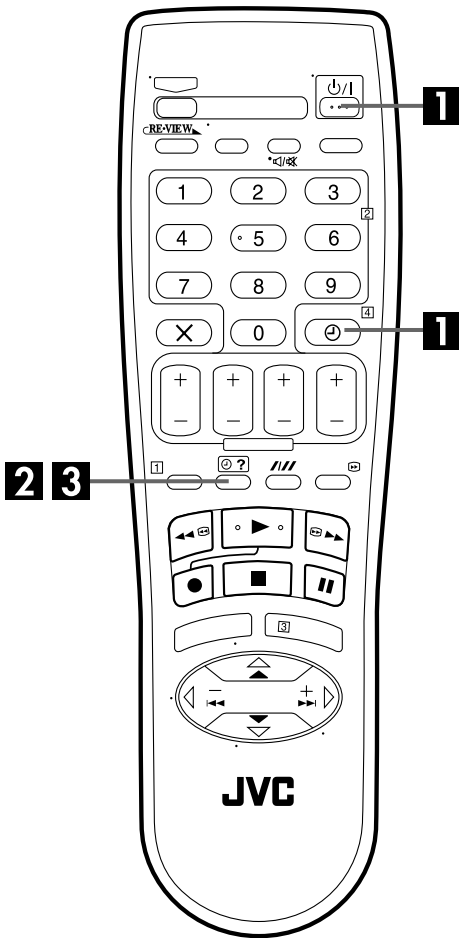

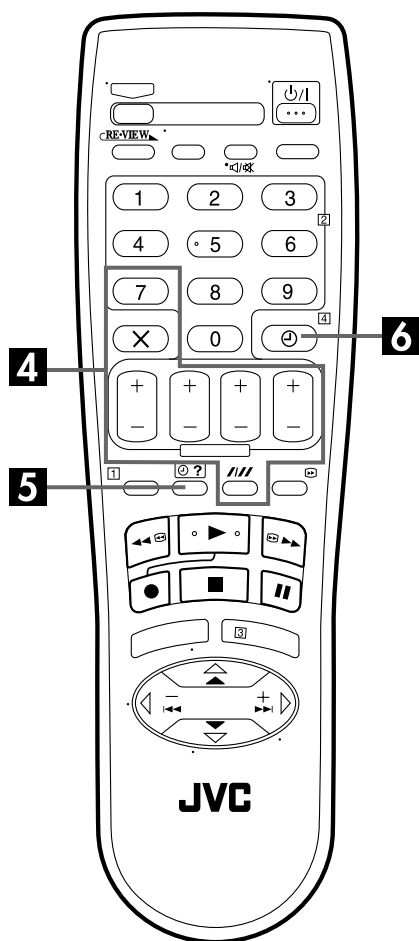

## To cancel or change a programme...

### 4 Cancel or change a programme.

Press **X** to cancel a programme. To change programme settings, press the appropriate button: **START+/-**, **STOP+/-**, **DATE+/-**, **PR+/-**, **VPS/PDC** and/or **SP/LP (///)**.

### 5 Return to the normal screen.

Press **⊖ ?** as many times as necessary. If there are still some programmes remaining, go on to step 6.

### 6 Return to the timer mode.

Press **⊖ (TIMER)**.

# Edit From A Camcorder

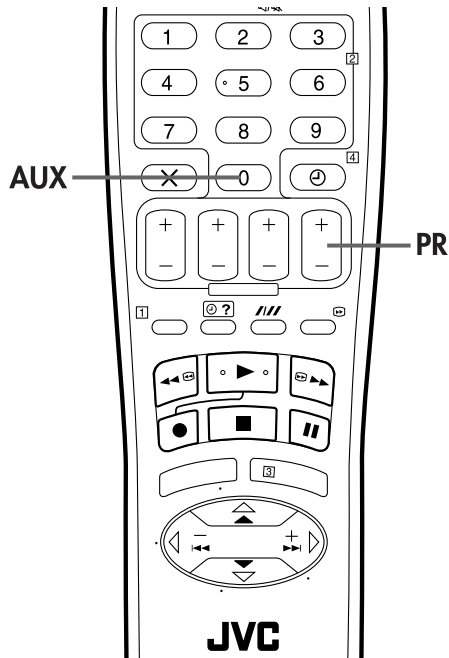

You can use a camcorder as the source player and your recorder as the recording deck.

## 1 Make connections.

Connect the camcorder's AUDIO OUT and VIDEO OUT connectors to the recorder's front panel AUDIO and VIDEO input connectors.

- When using a monaural camcorder, connect its AUDIO OUT connector to the AUDIO L input connector on your recorder.

## 2 Set the recorder's input mode.

Press **AUX** (number key "0") and/or **PR** to select "F-1".

## 3 Set the edit mode.

See "PICTURE CONTROL" on page 37.

## 4 Start the camcorder.

Engage the Play mode of the camcorder.

## 5 Start the recorder.

Engage the Record mode of the recorder.

### NOTES:

- All necessary cables can be obtained from your dealer.
- When you select "EDIT" to dub tapes in step 3, be sure to select "AUTO" (or "NORM" when "B.E.S.T." is set to "OFF") after you finish dubbing the tapes.

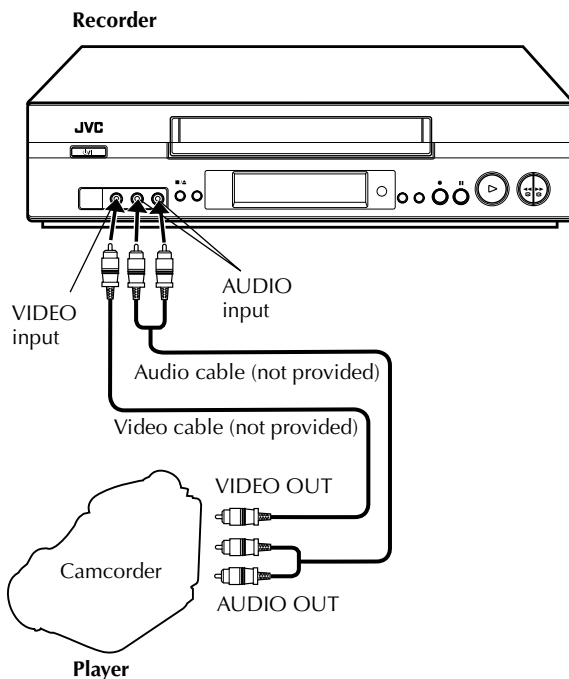

# Edit To Or From Another Video Recorder

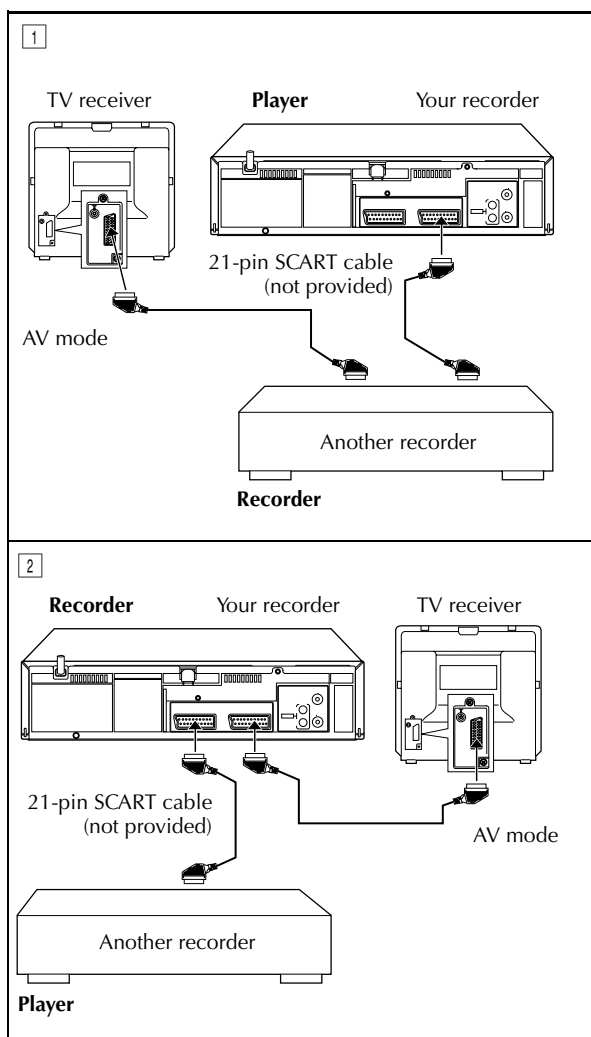

## Advantages of S-VHS video recorders

You can edit from VHS to S-VHS, S-VHS to VHS, or, from S-VHS to S-VHS.

- From VHS to S-VHS: Record VHS playback signals in the S-VHS mode. Although the picture quality is inherently limited by that of the original, the edited tape has better picture quality than those made by VHS-to-VHS editing.
- From S-VHS to VHS: Because the picture quality of the source material is very high, the edited tape has better picture quality than those made by VHS-to-VHS editing.
- From S-VHS to S-VHS: All signals will be transferred with minimum degradation.

You can use your recorder as the source player or as the recording deck.

## 1 Make connections.

Connect the player's 21-pin SCART connector to the recorder's 21-pin SCART connector as illustrated.

- 1 When using your recorder as the source player ...  
... connect its L-1 IN/OUT connector to the recording deck.
  - 2 When using your recorder as the recording deck ...  
... connect its L-2 IN/DECODER connector to the source player.
- If another recorder is compatible with the Y/C signal ...  
... when using your recorder as the source player, set "L-1 OUTPUT" to "S-VIDEO" (☞ pg. 30).  
... when using your recorder as the recording deck, set "L-2 INPUT" to "S-VIDEO" (☞ pg. 31).

## 2 Set the input mode of recording deck.

With this video recorder, press **AUX** (number key "0") and/or **PR** to select "L-2" for the L-2 IN/DECODER connector.

- When using the L-2 IN/DECODER connector, set "L-2 SELECT" to "AV" (☞ pg. 31).

## 3 Set the edit mode.

See "PICTURE CONTROL" on page 37.

## 4 Start the source player.

Engage the Play mode of the source player.

## 5 Start the recording deck.

Engage the Record mode of the recording deck.

## NOTES:

- All necessary cables can be obtained from your dealer.
- For Y/C signal input/output, be sure to use a 21-pin SCART cable that is compatible with the Y/C signal.
- When you select "EDIT" to dub tapes in step 3, be sure to select "AUTO" (or "NORM" when "B.E.S.T." is set to "OFF") after you finish dubbing the tapes.
- When you use this recorder as the source player for editing, be sure to set "O.S.D." to "OFF" before starting (☞ pg. 37).

# Output/Input Set

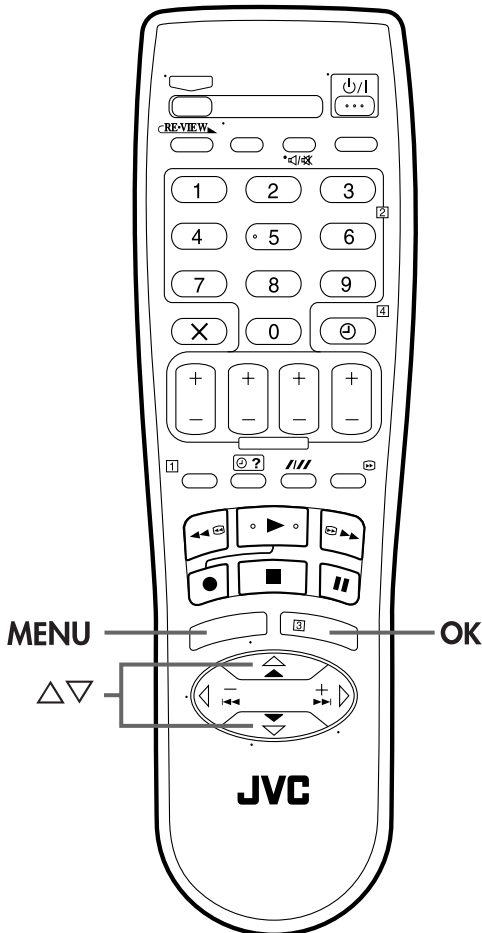

## L-1 OUTPUT Setting

The L-1 IN/OUT connector accepts only a composite signal (regular video signal) and delivers either a composite signal (regular video signal) or a Y/C signal (a signal in which the luminance and chrominance signals are separated). Set "L-1 OUTPUT" to the appropriate mode depending on the type of appliance connected to the recorder's L-1 IN/OUT connector.

### 1 Access the Main Menu screen.

Press **MENU**.

### 2 Access the Output/Input Set screen.

Press  $\Delta$ / $\nabla$  to move the highlight bar (pointer) to "OUTPUT/INPUT SET", then press **OK** or  $\triangleright$ .

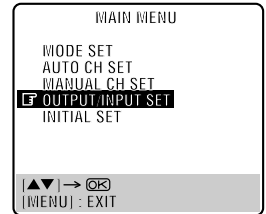

### 3 Select the output or input mode for the L-1 IN/OUT connector.

Press  $\Delta$ / $\nabla$  to move the highlight bar (pointer) to "L-1 OUTPUT". Then, press **OK** or  $\triangleright$  to select the appropriate setting.

\* The default setting is **bold** in the table below.

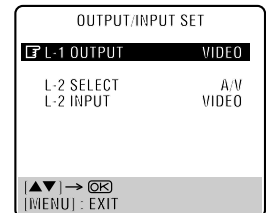

#### ■ L-1 OUTPUT

- VIDEO:** If a connected appliance's input is compatible only with regular video signals, set to "VIDEO".
- S-VIDEO:** If a connected appliance's input is compatible with Y/C signals, set to "S-VIDEO". You can obtain high-quality S-VHS picture. (For connection, be sure to use a 21-pin SCART cable that is compatible with the Y/C signal.)

### 4 Return to the normal screen.

Press **MENU**.

## L-2 SELECT and L-2 INPUT Setting

The L-2 IN/DECODER connector accepts either a composite signal (regular video signal) or a Y/C signal (a signal in which the luminance and chrominance signals are separated). Set "L-2 SELECT" to the appropriate mode depending on the type of appliance connected to the recorder's L-2 IN/DECODER connector. Set "L-2 INPUT" to the appropriate mode depending on the output signals of the connected appliance.

Perform steps 1 and 2 of "L-1 OUTPUT Setting" on page 30.

### 1 Select the input mode for the L-2 IN/DECODER connector.

Press  $\Delta$ / $\nabla$  to move the highlight bar (pointer) to "L-2 SELECT" or "L-2 INPUT". Then, press **OK** or  $\triangleright$  to select the appropriate setting.

\* The default setting is **bold** in the table below.

OUTPUT/INPUT SET	
L-1 OUTPUT	VIDEO
<b>L-2 SELECT</b>	<b>A/V</b>
L-2 INPUT	VIDEO

$\blacktriangle$   $\blacktriangledown$   $\rightarrow$   $\leftarrow$   $\text{OK}$   
 [MENU] : EXIT

#### ■ L-2 SELECT

**A/V:** To use this recorder as the recording deck with the player connected to the L-2 IN/DECODER connector, or to use the satellite receiver connected to the L-2 IN/DECODER connector.

**DECODER:** To use a decoder connected to the L-2 IN/DECODER connector.

**SAT:** To view a satellite programme with the TV set while the recorder is turned off. (pg. 32)

#### ■ L-2 INPUT

**VIDEO:** If a connected appliance's output is compatible only with regular video signals, set to "VIDEO".

**S-VIDEO:** If a connected appliance's output is compatible with Y/C signals, set to "S-VIDEO". You can obtain high-quality S-VHS picture. (For connection, be sure to use a 21-pin SCART cable that is compatible with the Y/C signal.)

## NOTES:

- If you have a satellite receiver or a decoder connected to the L-2 IN/DECODER connector, be sure to set "L-2 SELECT" back to appropriate mode after editing.
- If you are not connecting a satellite receiver or a decoder to the L-2 IN/DECODER connector, leave "L-2 SELECT" set to "A/V".
- The default setting is "A/V"; if the recorder's memory backup has expired due to a power cut or because the AC was removed from the recorder, "A/V" will be automatically selected when the power is restored to the recorder. If you are using a satellite receiver or a decoder, be sure to set "L-2 SELECT" back to appropriate mode.
- When "L-2 SELECT" is set to "SAT", "SAT" or "SAT" appears on TV screen or front display panel instead of "L-2" or "L2".
- If "L-2 SELECT" is set to "DECODER", it is impossible to set "L-2 INPUT" to "S-VIDEO".
- If "L-1 OUTPUT" is set to "S-VIDEO", it is impossible to set "L-2 SELECT" to "DECODER".

### 2 Return to the normal screen.

Press **MENU**.

# Connecting To A Satellite Receiver

## Simple Connections

This is an example of simple connection if your TV has one 21-pin AV input (SCART) connector. Connect the satellite receiver to the L-2 IN/DECODER connector, then connect the L-1 IN/OUT connector to the TV's connector.

## NOTES:

- Set "L-2 SELECT" to "AV" (☞ pg. 31).
- To record a programme via the satellite receiver, select L-2 mode by pressing **AUX (number key "0")** and/or **PR** so that "L-2" appears on the front display panel.
- For details, refer to the instruction manual of the satellite receiver.

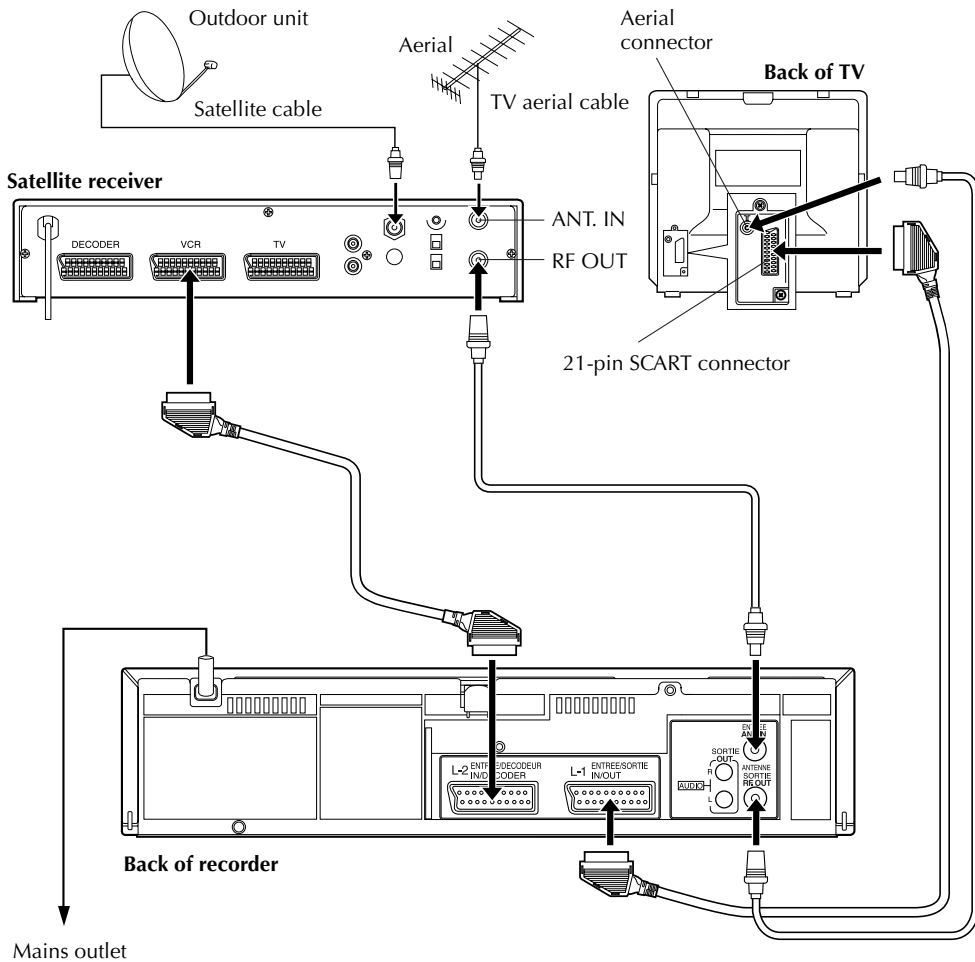

## IMPORTANT

When you set "L-2 SELECT" to "SAT" (☞ pg. 31), it is possible to view a satellite broadcast with the TV set to its AV mode even if the recorder is turned off. When the recorder is in Stop mode or recording, press **TV/VCR** on the remote control to turn off the VCR indicator on the front display panel.

- If you turn on the recorder when the satellite receiver's power is off, nothing appears on the TV screen. In this case, turn on the satellite receiver, or set the TV to its TV mode, or press **TV/VCR** on the remote control to set the recorder to the video mode.



## Perfect Connections

This is an example of recommended connection if your TV has two 21-pin AV input (SCART) connectors.

Connect the decoder to the satellite receiver's connector if you have a decoder, L-1 IN/OUT connector to TV's connector, and L-2 IN/DECODER connector to the satellite receiver's connector. Then connect the satellite receiver and TV.

### NOTES:

- Set "L-2 SELECT" to "AV" (pg. 31).
- To record a programme via the satellite receiver, select L-2 mode by pressing **AUX** (number key "0") and/or **PR** so that "L-2" appears on the front display panel.
- To receive a scrambled broadcast, descramble the signal with the satellite receiver.
- For details, refer to the instruction manual of the satellite receiver and decoder.

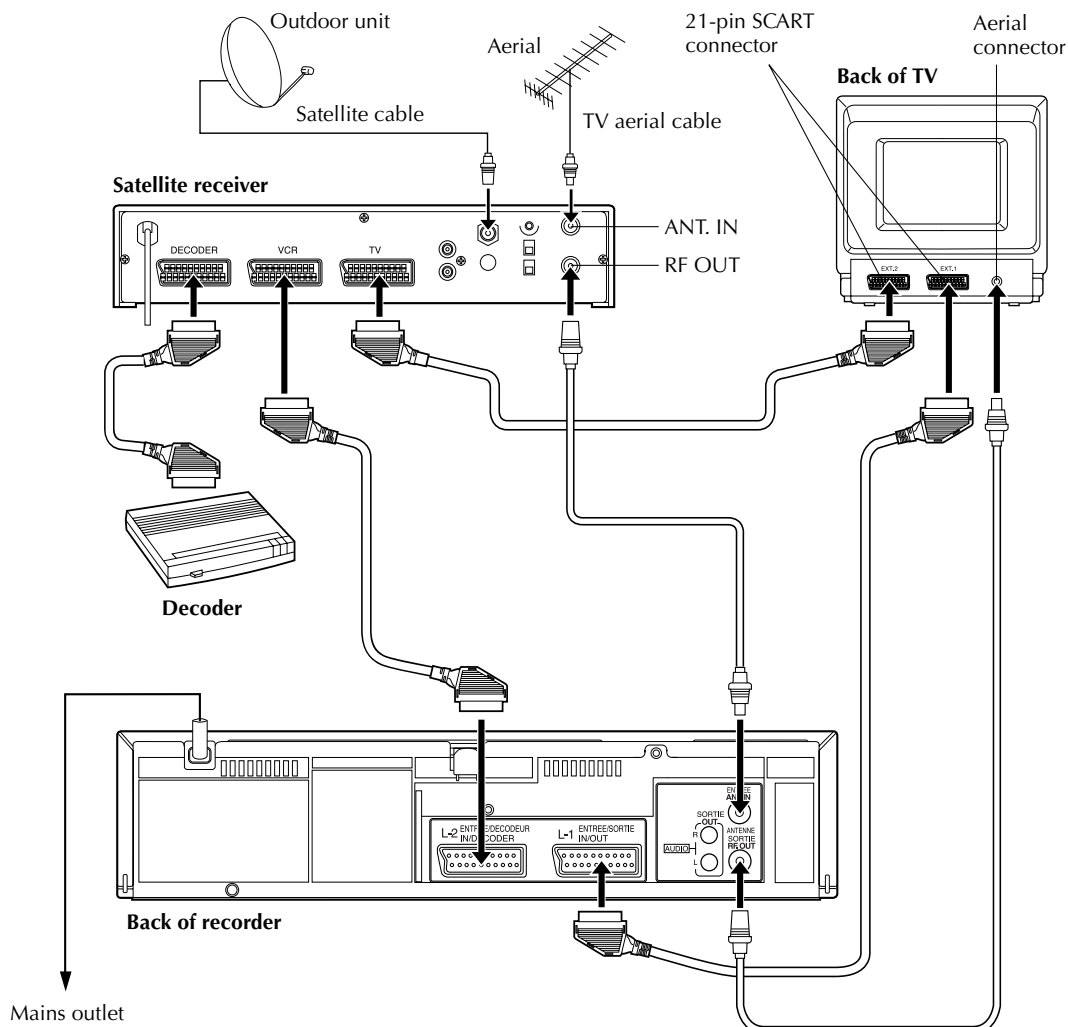

# Connecting/Using A Decoder

The L-2 IN/DECODER connector can be used as an input connector for an external decoder (descrambler). Simply connect a decoder and you can enjoy the variety of programming that is available through scrambled channels.

## 1 Select the input mode.

Set "L-2 SELECT" to "DECODER". (☞ pg. 31)

## 2 Connect the decoder.

Connect your recorder's L-2 IN/DECODER connector to the decoder's 21-pin SCART connector using a 21-pin SCART cable.

## 3 Set the tuner.

Perform the procedure as described in "When Receiving A Scrambled Broadcast" on page 43.

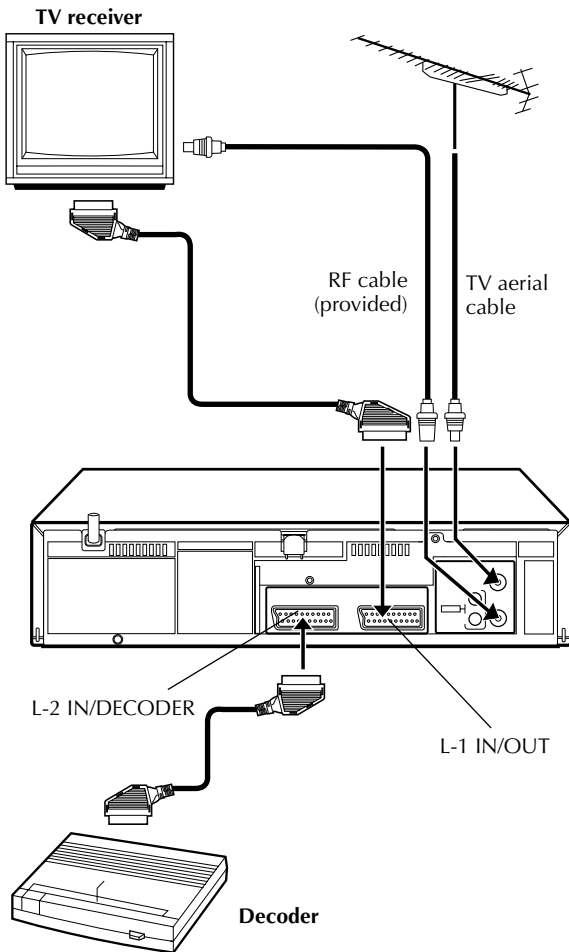

# Connecting/Using A Stereo System

These instructions enable you to connect your video recorder to your Hi-Fi stereo system (if you have one) and listen to the soundtrack through the stereo.

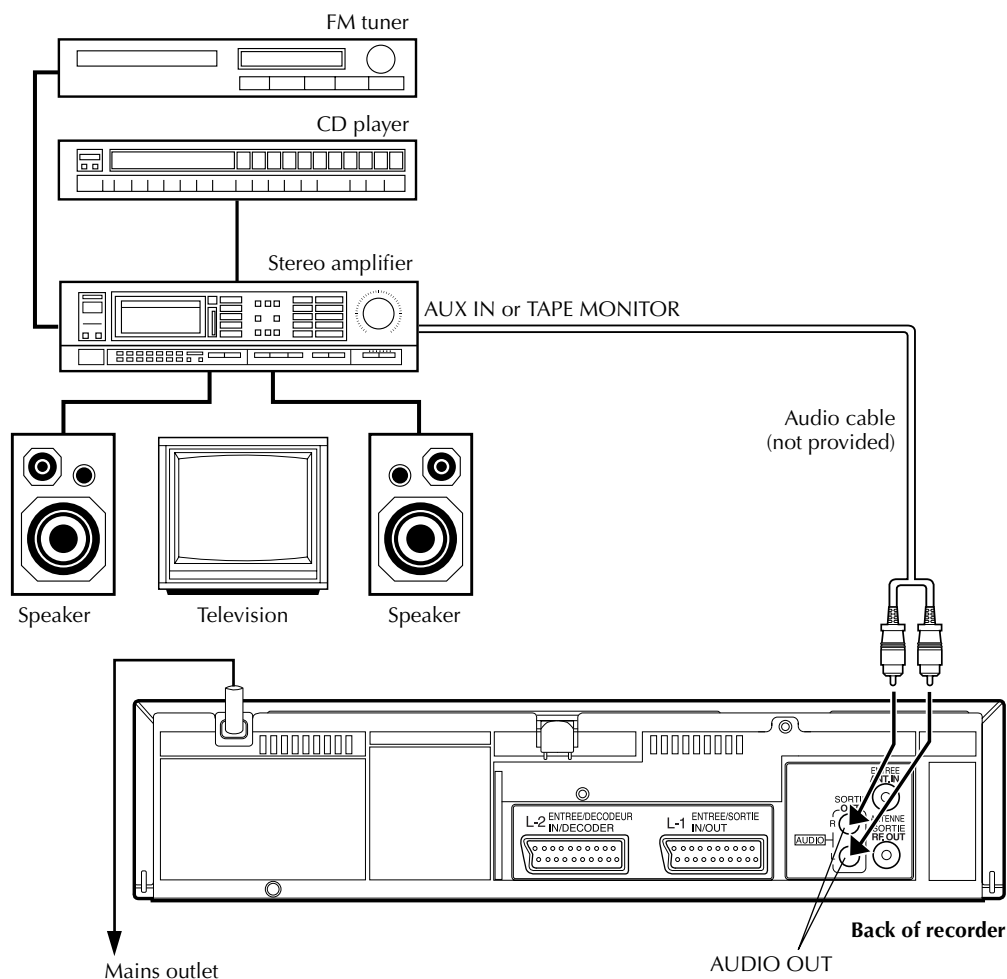

## Make connections.

Connect the AUDIO OUT L and R connectors on your video recorder to the AUX IN or TAPE MONITOR connectors on your stereo system's receiver or amplifier.

### NOTE:

When listening to sound through the connected stereo system, turn the TV's volume down completely.

## CAUTIONS:

- This recorder has a dynamic range of more than 80 dB with regards to its Hi-Fi audio capability. It is recommended that you check the maximum level if you are going to listen to the Hi-Fi audio signals through a stereo amplifier. A sudden surge in the input level to the speakers may damage them.
- Some speakers and televisions are specially shielded to prevent television interference. If both are of the non-shielded type, do not place the speakers adjacent to the TV set as this can adversely affect the video playback picture.

# Mode Set

Turn on the TV and select the video channel (or AV mode).

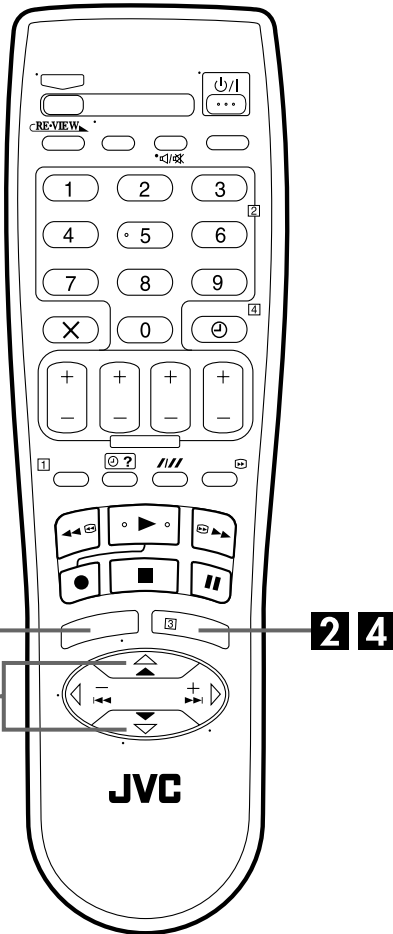

You can change various mode settings on the Mode Set screen by following the procedure described below.

- For each mode setting, see pages 37 to 39.

## 1 Access the Main Menu screen.

Press MENU.

## 2 Access the Mode Set screen.

Press  $\Delta$ / $\nabla$  to move the highlight bar (pointer) to "MODE SET", then press OK or  $\triangleright$ .

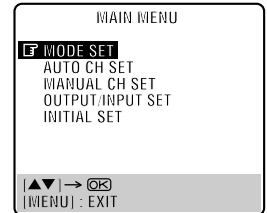

## 3 Select the mode.

Press  $\Delta$ / $\nabla$  to move the highlight bar (pointer) to the item you want to change.

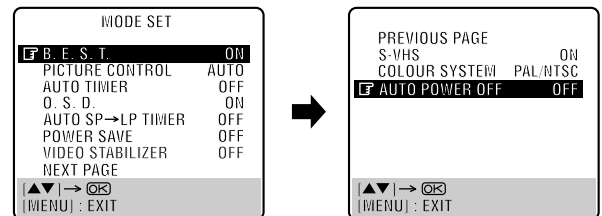

## 4 Select the mode setting.

Press OK or  $\triangleright$ .

## 5 Return to the normal screen.

Press MENU.

\* The default setting is **bold** in the table below.

<p>■ <b>B.E.S.T.</b> ON OFF</p>	<p>You can set the B.E.S.T. (Biconditional Equalised Signal Tracking) system to "ON" or "OFF" (☞ pg. 21).</p>
<p>■ <b>PICTURE CONTROL</b> AUTO EDIT SOFT SHARP</p>	<p>This feature helps you to adjust the playback picture quality according to your preference. Normally select "AUTO".</p> <p><b>AUTO:</b> Provides the optimised picture benefits of the B.E.S.T. Picture System.  <b>EDIT:</b> Minimizes picture degradation during editing (recording and playback).  <b>SOFT:</b> Reduces image coarseness when viewing overplayed tapes containing a lot of noise.  <b>SHARP:</b> Clearer, sharper-edged picture when viewing images with lots of flat, same-coloured surfaces such as cartoons.</p> <p><b>NOTES:</b></p> <ul style="list-style-type: none"> <li>• When you select "EDIT", "SOFT" or "SHARP", the selected mode will not change until you select another mode.</li> <li>• When you select "EDIT" to dub tapes, be sure to select "AUTO" after you finish dubbing the tapes.</li> <li>• When "B.E.S.T." is "OFF", "PICTURE CONTROL" switches automatically from "AUTO" to "NORM".</li> </ul>
<p>■ <b>AUTO TIMER</b> ON OFF</p>	<p>When this function is set to "ON", the timer is automatically engaged when the recorder power is turned off, and automatically disengaged when the recorder is powered back on.</p> <p><b>NOTE:</b>  For safety, when "AUTO TIMER" is set to "OFF", all other recorder functions are disabled while the Timer mode is engaged. To disengage the timer, press ⏻ (TIMER).</p>
<p>■ <b>O.S.D.</b> ON OFF</p>	<p>When this function is set to "ON", various operational indicators appear on the TV screen. Messages appear in the selected language (☞ pg. 12, 13).</p> <p><b>NOTES:</b></p> <ul style="list-style-type: none"> <li>• When you use this recorder as the source player for editing, be sure to set "O.S.D." to "OFF" before starting.</li> <li>• During playback, the operation mode indicators may be disturbed depending on the type of tape being used.</li> </ul>

\* The default setting is **bold** in the table below.

<p>■ <b>AUTO SP→LP TIMER</b> ON OFF</p>	<p>When this function is set to "ON", the recorder automatically switches to LP mode to allow complete recording if there is not enough tape to record the entire programme while timer-recording in SP mode.</p> <p><b>For Example . . .</b> Recording a programme of 210 minutes in length onto a 180-minute tape</p> <table border="1" data-bbox="471 349 1059 407"> <tr> <td style="text-align: center;">Approximately 150 minutes SP mode</td> <td style="text-align: center;">Approximately 60 minutes LP mode</td> </tr> </table> <p style="text-align: center;">Total 210 minutes</p> <p>Make sure you set this function to "ON", before the timer-recording starts.</p> <p><b>NOTES:</b></p> <ul style="list-style-type: none"> <li>● If you have programmed the recorder to timer-record 2 or more programmes, the second programme and those thereafter may not fit on the tape if you set "AUTO SP→LP TIMER" to "ON". In this case, make sure the mode is not engaged, then set the tape speed manually during timer programming.</li> <li>● In order to ensure that the recording fits on the tape, this feature may leave a slight non-recorded section at the end of the tape.</li> <li>● There may be some noise and sound disturbance at the point on the tape where the recorder switches from SP to LP mode.</li> <li>● The Auto SP→LP Timer feature is not available during ITR (Instant Timer Recording), and the feature will not work properly with any tapes longer than E-180, or with some tapes of shorter lengths.</li> <li>● If you perform timer recording with both VPS/PDC and the Auto SP→LP Timer activated, and the programme goes beyond its originally scheduled length, there may be times when the programme cannot be recorded in its entirety.</li> </ul>	Approximately 150 minutes SP mode	Approximately 60 minutes LP mode
Approximately 150 minutes SP mode	Approximately 60 minutes LP mode		
<p>■ <b>POWER SAVE</b> ON OFF</p>	<p>When this function is set to "ON", you can reduce the power consumption while the recorder is turned off.</p> <p><b>NOTES:</b></p> <ul style="list-style-type: none"> <li>● During Power Save mode ... <ul style="list-style-type: none"> <li>... the front display panel will be turned off.</li> <li>... the Just Clock function (⏰ pg. 46) does not work.</li> <li>... the picture may be distorted momentarily when you turn on/off the recorder.</li> </ul> </li> <li>● Power Save does not work when ... <ul style="list-style-type: none"> <li>... the recorder is in the Timer mode.</li> <li>... the recorder's power is turned off after timer-recording or Instant Timer Recording.</li> <li>... "L-2 SELECT" is set to "DECODER" or "SAT" (⏸ pg. 31).</li> </ul> </li> </ul>		
<p>■ <b>VIDEO STABILIZER</b> ON OFF</p>	<p>When this function is set to "ON", you can automatically correct vertical vibration in the picture when playing back unstable recordings made on another recorder.</p> <p><b>NOTES:</b></p> <ul style="list-style-type: none"> <li>● When you finish viewing a tape, be sure to set this function to "OFF".</li> <li>● Regardless of the setting, this function has no effect during recording and during special effects playback.</li> <li>● The on-screen display may jitter vertically when this function is set to "ON".</li> <li>● To watch recordings with close-caption, set this function to "OFF".</li> </ul>		

\* The default setting is **bold** in the table below.

<p>■ <b>S-VHS</b> ON OFF</p>	<p>Your recorder can record in S-VHS (Super VHS), S-VHS ET or VHS.</p> <p>● <b>To record in S-VHS:</b> Set "S-VHS" to "ON". Then, insert a cassette marked "S-VHS". The S-VHS indicator lights up on the front display panel. The S-VHS recording mode is selected.</p> <p>● <b>To record in S-VHS ET on a VHS cassette:</b> See "Super VHS ET (S-VHS ET)" on page 20.</p> <p>● <b>To record in VHS:</b> Insert a cassette marked "VHS". Press <b>S-VHS ET</b> on the recorder. You can check the current setting ("S-VHS ET : ON" or "S-VHS ET : OFF") if "O.S.D." is set to "ON" (☞ pg. 37). If "S-VHS ET : ON" appears on the TV screen, press <b>S-VHS ET</b> again in about 5 seconds to set it to "OFF". The VHS recording mode is automatically selected regardless of the "S-VHS" mode setting.</p> <p>● <b>To record in VHS on an S-VHS cassette:</b> Insert a cassette marked "S-VHS". The S-VHS indicator lights up on the front display panel. Then, set "S-VHS" to "OFF". The S-VHS indicator goes off. The VHS recording mode is selected.</p> <p><b>NOTE:</b> <i>When playing back a tape that has been recorded in S-VHS or S-VHS ET, the S-VHS indicator lights up on the front display panel regardless of the "S-VHS" mode setting.</i></p>
<p>■ <b>COLOUR SYSTEM</b> PAL/NTSC MESECAM</p>	<p>You can play back PAL, NTSC and MESECAM tapes, or record PAL and SECAM* signals on this recorder. Select the appropriate colour system.</p> <p>* SECAM signals will be recorded as MESECAM on this recorder; MESECAM is the designation for tapes with SECAM signals that have been recorded on a MESECAM-compatible PAL video cassette recorder.</p> <p><b>PAL/NTSC:</b> To record PAL signals, or play back a PAL or NTSC tape. <b>MESECAM:</b> To record SECAM signals, or play back a MESECAM tape.</p> <p><b>NOTES:</b></p> <ul style="list-style-type: none"> <li>● It is not possible to record in S-VHS if "MESECAM" is selected. The recording mode is forced to change to VHS.</li> </ul> <p><b>About NTSC Playback</b></p> <ul style="list-style-type: none"> <li>● Some TVs shrink the picture vertically and place black bars at the top and bottom of the TV screen. This is not a malfunction on the part of either the video recorder or the TV.</li> <li>● The picture may roll up and down. This can be corrected using the V-HOLD control found on some TVs. (This cannot be corrected if the TV does not have a V-HOLD control.)</li> <li>● The counter and tape remaining time readings will be incorrect.</li> <li>● During search, still, or frame-by-frame playback, the picture will be distorted, and there may be a loss of colour.</li> <li>● Depending on the type of TV, the top and bottom portions of superimposed displays may be cut off during NTSC playback.</li> </ul>
<p>■ <b>AUTO POWER OFF</b> 3H OFF</p>	<p>When this function is set to "3H", the recorder is turned off automatically if no operation is done within 3 hours. "AUTO POWER OFF IN 3 MIN" appears on the screen 3 minutes before the recorder is turned off.</p>

# Tuner Set

Turn on the TV and select the video channel (or AV mode).

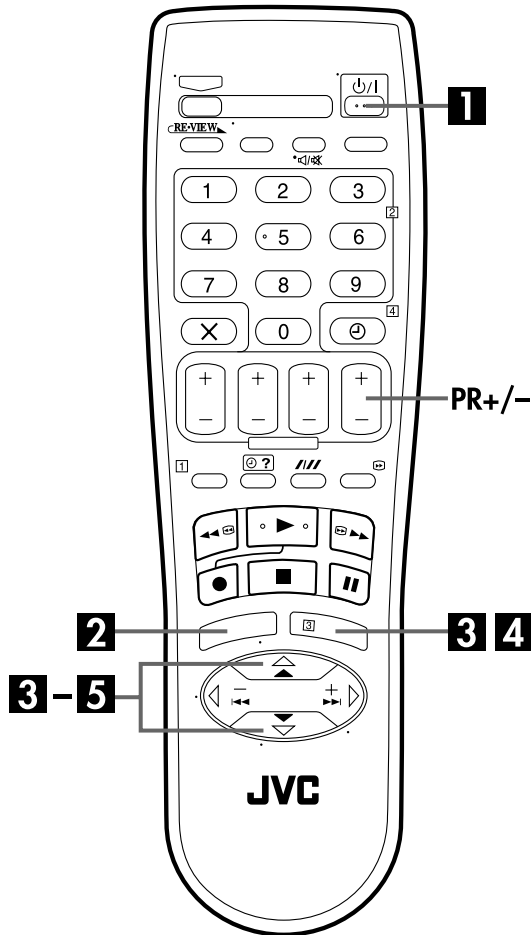

## IMPORTANT

Perform the following steps only if —  
 — Auto Channel Set has not been set correctly by Auto Set Up (see pg. 10).  
 — you have moved to a different area or if a new station starts broadcasting in your area.

Your recorder needs to memorize all necessary stations in channel positions in order to record TV programmes. Auto Channel Set automatically assigns all receivable stations in your area to call them up by using the **PR** buttons without going through any vacant channels.

## Auto Channel Set

### 1 Turn on the recorder.

Press **power**.

### 2 Access the Main Menu screen.

Press **MENU**.

### 3 Access the Auto Channel Set screen.

Press **up/down** to move the highlight bar (pointer) to "AUTO CH SET", then press **OK** or **right**.

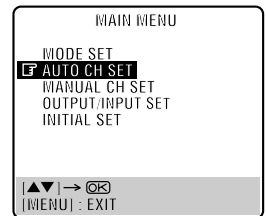

### 4 Select your country.

Press **up/down** to move the highlight bar (pointer) to your country's name, then press **OK** or **right**.

### 5 Select the language.

Press **up/down** to move the highlight bar (pointer) to the language of your choice.



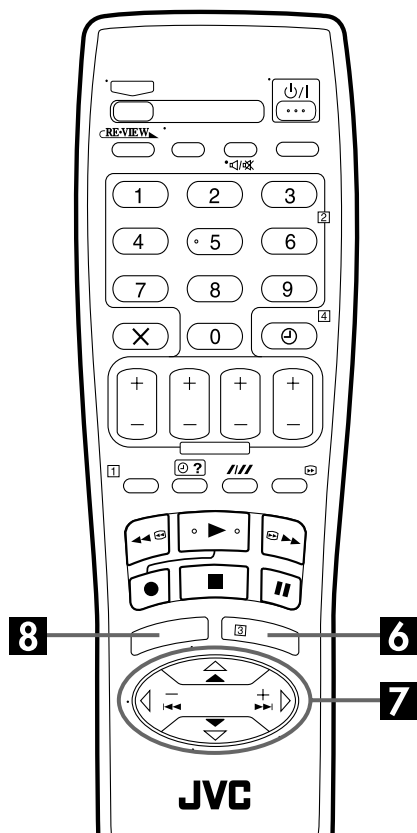

## 6 Perform Auto Channel Set.

Press **OK**.

- The Auto Set screen appears, and remains on screen while the recorder searches for receivable stations.

As Auto Channel Set progresses, the "■" mark on the TV screen moves from left to right. Wait until the TV screen as shown in step 7 appears.

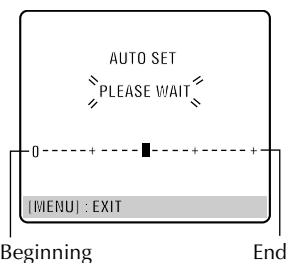

## 7 View the Confirmation screen.

After "SCAN COMPLETED" is displayed on the TV screen for about 5 seconds, the Confirmation screen looking like the one to the right appears. The stations your recorder located appear on a

Confirmation screen — channel positions (PR),

channels (CH) and station names (ID — pg. 45). The blueback screen and the programme currently being broadcast by the blinking station appear alternately for 8 seconds each. To view the next page, use the  $\Delta \nabla \triangleleft \triangleright$  button on the remote control.

PR	CH	ID	PR	CH	ID
01	25	ARD	08	C26	E-SP
02	C08	SKY1	09	55	WEST
03	10	ZDF	10	C24	SAT1
04	C65	RAI1	11	C23	OSF
05	C31	BBC1	12		
06	C32	BBC2	13		
07	C33	3SAT	14		

$\Delta$  : EDIT  
 $\nabla$  : DELETE  
 [MENU] : EXIT

- The stations located in the selected country appear at the top of the list.
- The Guide Program numbers will also be set automatically during Auto Channel Set.

## 8 Return to the normal screen.

Press **MENU**.

- Using the Confirmation screen, you can skip or add channel positions, enter station names and perform other operations. Refer to pages 42 – 44 for the procedures.
- Depending on reception conditions, the stations may not be stored in order, and the station names may not be stored correctly.
- For information on scrambled broadcasts, refer to page 43.

### IMPORTANT

- In certain reception conditions, station names may not be stored correctly, and Auto Guide Program Number Set may not work properly. If the Guide Program numbers are not set properly when you timer-record a TV programme using the SHOWVIEW system, the recorder will record a TV programme of a different station. When programming the timer using the SHOWVIEW system, be sure to check the desired channel is selected correctly (pg. 22, "SHOWVIEW" Timer Programming).
- Your video recorder memorizes all detected stations even if reception of some of them is poor. You can delete those stations with an unacceptable picture (pg. 43, "Delete A Channel").

### NOTES:

- Fine tuning is performed automatically during Auto Channel Set. If you want to perform tuning manually, refer to page 44.
- If you perform Auto Channel Set when the aerial cable is not connected properly, "SCAN COMPLETED –NO SIGNAL–" appears on the TV screen in step 7. When this happens, make sure of the aerial connection and press **OK**; Auto Channel Set will take place again.
- If no sound accompanies the picture or the audio sounds unnatural on some channels that have been stored by Auto Set Up, the TV system setting for those channels may be incorrect. Select the appropriate TV system for those channels (pg. 43, "INFORMATION").

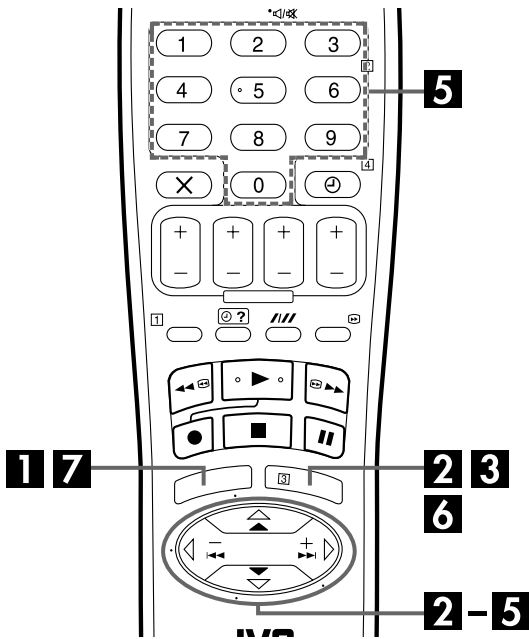

## Manual Channel Set

Store channels that were not stored during Auto Set Up (☞ pg. 10) or Auto Channel Set (☞ pg. 40).

### 1 Access the Main Menu screen.

Press **MENU**.

### 2 Access the Confirmation screen.

Press  $\Delta \nabla$  to move the highlight bar (pointer) to "MANUAL CH SET", then press **OK** or  $\triangleright$ . The Confirmation screen appears.

### 3 Select the channel position.

Press  $\Delta \nabla \triangleleft \triangleright$  until an open position in which you want to store a channel begins blinking, then press **OK**. The Manual Channel Set screen appears.

(Example) To store in position 12.

PR	CH	ID	PR	CH	ID
01	25	ARD	08	C26	E-SP
02	C08	SKY1	09	55	WEST
03	10	ZDF	10	C24	SAT1
04	C65	RAI1	11	C23	OSF
05	C31	BBC1	12	---	---
06	C32	BBC2	13	---	---
07	C33	3SAT	14	---	---

$\uparrow \downarrow \leftarrow \rightarrow$  : SELECT  
 $\leftarrow \rightarrow$  : CURSOR  
 $\text{OK}$  : OK  
 $\text{MENU}$  : EXIT

The blueback screen and the programme currently being broadcast by the selected channel appear alternately for 8 seconds each.

### 4 Select the band.

Press  $\Delta \nabla$  to change the band between CH (regular) and CC (cable), then press  $\triangleright$ .

PR	CH	ID	FINE	DECODER
12	CH01	----	+/-	OFF

$\uparrow \downarrow$  : SELECT  
 $\leftarrow \rightarrow$  : CURSOR  
 $\text{OK}$  : OK  
 $\text{MENU}$  : EXIT

### 5 Input the channel.

Press the **number keys** to input the channel number you want to store.

- Input "0" before any single number entries.
- To input the registered station name (ID – ☞ pg. 45), press  $\Delta \nabla$  until "----" (ID setting) begins blinking, then press  $\Delta \nabla$ .
- For fine tuning adjustment, press  $\triangleright$  until "+/-" begins blinking, then press  $\Delta \nabla$ . While tuning, "+" or "-" appears.
- When storing a channel that sends scrambled broadcasts, press  $\triangleright$  until "OFF" (Decoder setting) blinks, then press  $\Delta \nabla$  to set "DECODER" to "ON" ("OFF" is the default setting).
- When "L-2 SELECT" is set to "A/V" or "SAT", the "DECODER" setting cannot be changed (☞ pg. 31).

### 6 Enter new channel information.

Press **OK** and the Confirmation screen appears.

- Repeat steps 3 – 6 as necessary.

### 7 Close the Confirmation screen.

Press **MENU**.

- To change positions, see "Change Station Channel Position" (☞ pg. 43).
- If you wish to set station names other than the ones registered in your recorder, see "Set Stations (B)" (☞ pg. 44).

## ATTENTION

Guide Program numbers are not set when channels are stored manually. If an attempt is made at timer programming with the SHOWVIEW system in this state, the "GUIDE PROG SET" screen appears; set the Guide Program numbers on this screen. (☞ pg. 23, "ATTENTION — Guide Program Number Set")

Or perform "Guide Program Number Set" (☞ pg. 49).

## Delete A Channel

Perform steps 1 and 2 of "Manual Channel Set" on page 42 to access the Confirmation screen before continuing.

### 1 Select the item.

Press  $\Delta \nabla \triangleleft \triangleright$  until the item you want to delete begins blinking.

### 2 Delete a channel.

Press X.

- The item directly beneath the cancelled one moves up one line.
- Repeat steps 1 and 2 as necessary.

### 3 Close the Confirmation screen.

Press MENU.

## Change Station Channel Position

Perform steps 1 and 2 of "Manual Channel Set" on page 42 to access the Confirmation screen before continuing.

### 1 Select the item.

Press  $\Delta \nabla \triangleleft \triangleright$  until the item you want to move begins blinking. Then press OK and the station name (ID) and its channel (CH) number begin blinking.

### 2 Select the new position.

Press  $\Delta \nabla \triangleleft \triangleright$  to move the station to the new channel position, then press OK.

Example: If you moved the station in position 4 to position 2, the stations originally in positions 2 and 3 each move down one space.

PR	CH	ID	PR	CH	ID
01	25	ARD	08	C26	E-SP
02	C08	SKY1	09	55	WEST
03	10	ZDF	10	C24	SAT1
04	C65	RAI1	11	C23	OSF
05	C31	BBC1	12	C25	ESPN
06	C32	BBC2	13		
07	C33	3SAT	14		

➔

PR	CH	ID	PR	CH	ID
01	25	ARD	08	C26	E-SP
02	C65	RAI1	09	55	WEST
03	C08	SKY1	10	C24	SAT1
04	10	ZDF	11	C23	OSF
05	C31	BBC1	12	C25	ESPN
06	C32	BBC2	13		
07	C33	3SAT	14		

- Repeat steps 1 and 2 as necessary.

### 3 Close the Confirmation screen.

Press MENU.

## When Receiving A Scrambled Broadcast

### 1 Select the decoder mode.

Set "L-2 SELECT" to "DECODER" (pg. 31).

### 2 Access the Confirmation screen.

Perform steps 1 and 2 of "Manual Channel Set" on page 42.

### 3 Select the position.

Press  $\Delta \nabla \triangleleft \triangleright$  to select the channel position broadcasting scrambled programmes, then press OK twice.

### 4 Change the decoder setting.

Press  $\triangleright$  until "OFF" (decoder setting) begins blinking, and set it to "ON" by pressing  $\Delta \nabla$ .

### 5 Return to the Confirmation screen.

Press OK.

- Repeat steps 3 – 5 as necessary.

### 6 Close the Confirmation screen.

Press MENU.

## INFORMATION

If you live in Eastern Europe, "TV SYSTEM" setting appears instead of "DECODER" setting on the Manual Channel Set screen. When you can see the picture but can hear no audio, select appropriate TV system (D/K or B/G). Normally, TV programmes are broadcasted as follows.

For Eastern Europe : D/K

For Western Europe : B/G

- 1 Select a country in Eastern Europe in step 4 on page 40.
- 2 Press  $\triangleright$  until the TV system (D/K or B/G) blinking on the Manual Channel Set screen in step 4 on page 42.
- 3 Press  $\Delta \nabla$  to select appropriate TV System (D/K or B/G).

## Set Stations (A)

Set station names that are registered in your recorder.

Perform steps 1 and 2 of "Manual Channel Set" on page 42 to access the Confirmation screen before continuing.

### 1 Select the item.

Press  $\Delta \nabla \triangleleft \triangleright$  until the item you want begins blinking.

### 2 Access the Manual Channel Set screen.

Press **OK** twice.

### 3 Select the new station.

Press  $\triangleright$  until the station name (ID) begins blinking, then press  $\Delta \nabla$  until the new station's name (ID) you want to store begins blinking. Registered station names (pg. 45) appear as you press  $\Delta \nabla$ .

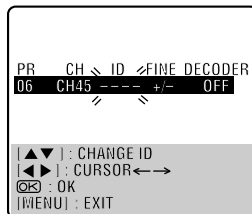

### 4 Switch the stations.

Press **OK**.

- The Confirmation screen appears.
- Repeat steps 1 – 4 as necessary.

### 5 Close the Confirmation screen.

Press **MENU**.

## Set Stations (B)

Set station names other than the ones registered in your recorder.

Perform steps 1 and 2 of "Manual Channel Set" on page 42 to access the Confirmation screen and then perform steps 1 and 2 of "Set Stations (A)" above before continuing.

### 1 Select the character for station name.

Press  $\triangleright$  until the first letter of the station name begins blinking.

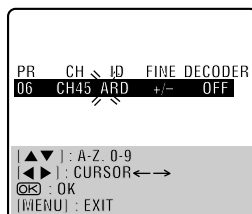

### 2 Enter the new character.

Press  $\Delta \nabla$  to cycle through the characters (A–Z, 0–9, –, \*, +, \_ (space) ) and stop when the desired character is indicated, then press  $\triangleright$  to enter. Enter the remaining characters the same way (maximum of 4). After entering all characters, press **OK**.

- The Confirmation screen appears.
- If you make a mistake, press  $\triangleleft$  until the incorrect character begins blinking. Then enter the correct character by pressing  $\Delta \nabla$ .

### 3 Close the Confirmation screen.

Press **MENU**.

#### NOTE:

The characters available for the station name (ID) are A–Z, 0–9, –, \*, +, \_ (space) (maximum of 4).

## Fine-Tuning Channels Already Stored

Perform steps 1 and 2 of "Manual Channel Set" on page 42 to access the Confirmation screen before continuing.

### 1 Select the channel to fine-tune.

Press  $\Delta \nabla \triangleleft \triangleright$  until the channel you want to tune begins blinking.

### 2 Access the Manual Channel Set screen.

Press **OK** twice. The Manual Channel Set screen appears.

### 3 Perform tuning.

Press  $\triangleright$  until "+/-" begins blinking, then press  $\Delta \nabla$  until the picture is its clearest. Then press **OK**.

- The Confirmation screen appears.
- Repeat steps 1 – 3 as necessary.

### 4 Close the Confirmation screen.

Press **MENU**.

## TV Station And ID List

ID*	STATION NAME
1000	TV1000
3SAT	3SAT
9LIV	9LIVE
ADLT	ADULT
ANT3	ANTENA3
ARD	ARD
ARTE	ARTE
B1	BERLIN1
BBC	BBC GROUP
BBC1	BBC1
BBC2	BBC2
BR3	BAYERN3
C+	CANAL PLUS
C1	PORTUGUSES
CAN5	CANALE5
CANV	KETNET CANVAS
CH4	CHANNEL4
CH5	CHANNEL5
CHLD	CHILD
CINE	CINEMA
CLUB	TELECLUB
CMT	CMT
CNN	CNN
CSUR	ANDALUCIA
DISC	DISCOVERY
DR	DR TV
DR2	DR2
DRS	DRS
DSF	DSF
ETB1	ETB1
ETB2	ETB2
EURO	EURONEWS
EUSP	EUROSPORTS
FEMM	FEMMAN
FILM	FILM
FNET	FILMNET
FR2	France2
FR3	France3
GALA	GALAVISION
HR3	HESSEN3
INFO	INFO-KANAL
ITA1	ITALIA1
ITA7	ITALIA7
ITV	ITV
JSTV	JSTV
KA2	KA2
KAB1	KABEL1
KAN2	KANAL2
LOCA	LOCAL
M6	M6
MBC	MBR
MCM	MCM
MDR	MDR
MOVE	MOVIE
MTV	MTV
MTV3	MTV3
N3	NORD3
N-TV	N-TV
NBC	NBC SUPER
NDR3	NDR3
NED1	NED1
NED2	NED2
NED3	NED3
NEWS	
NICK	NICKELODEON
NRK	NRK
NRK2	NRK2
ODE	ODEON
ORF1	ORF1

ID*	STATION NAME
ORF2	ORF2
ORF3	ORF3
OWL3	OWL3
PREM	PREMIERE
PRO7	PRO7
RAI1	RAI1
RAI2	RAI2
RAI3	RAI3
RET4	RETE4
21	TELE21
RTBF	RTBF1 or 2
RTL	RTL
RTL2	RTL2
RTL4	RTL4
RTL5	RTL5
RTP	RTP
S4	SCHWEIZ4
SAT1	SAT1
SBS	SBS
SF1	SF1
SF2	SF2
SHOW	SHOW
SIC	SOCIEDADE
SKY	SKY CHANNEL
SKYN	SKY NEWS
SPRT	SPORT
SRTL	SUPER RTL
STAR	STAR-TV
SVT1	SVT1
SVT2	SVT2
SWR	SUEDWEST3
TCC	TCC
TELE	TELE
TEL5	TELE5
TF1	TF1
TMC	TELEMONTECARLO
TNT	TNT INT
TRT	TRT INT
TSI	TSI
TSR	TSR
TV1	BRTN TV1
TV2	TV2
TV3	TV3
TV4	TV4
TV5	TV5
TV6	TV6
TVE1	TVE1
TVE2	TVE2
TVG	TV GALICIA
TVI	TV INDEPENDENT
TVN	TV NORGE
VCR	VIDEO
VERO	VERONICA
VH-1	VH-1
VIVA	VIVA
VIV2	VIVA2
VMTV	VIDEO MUSIC
VOX	VOX
VT4	VT4
VTM	VTM
WDR1	West1
WDR3	West3
YLE1	YLE1
YLE2	YLE2
ZDF	ZDF
ZTV	ZTV

\* The "ID" abbreviation is what is shown on-screen in lieu of the station name. The "ID" abbreviation is listed in the Confirmation screen and is displayed on the TV screen when the recorder is tuned to a different

# Clock Set

Turn on the TV and select the video channel (or AV mode).

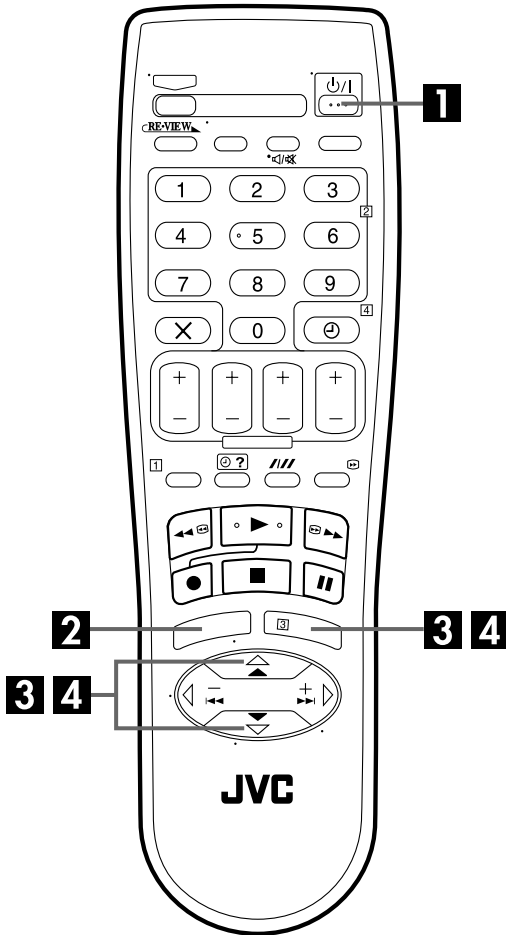

## Just Clock

The Just Clock function provides accurate time keeping through automatic adjustments at regular intervals, by reading data from a PDC signal.

The Just Clock option can be set "ON" or "OFF" at the Clock Set screen (the default setting is "OFF"). Press **OK** until the Just Clock setting begins blinking, then press  $\Delta/\nabla$  to change the setting.

**IMPORTANT:** If you turn off Just Clock, the accuracy of your recorder's built-in clock may be reduced, which could adversely effect timer recording. We recommend you to keep Just Clock on. In cases where the clock setting data from a PDC signal is incorrect, however, you are advised to keep Just Clock set to "OFF".

## IMPORTANT

If you performed Auto Set Up (ⓘ pg. 10) or Auto Channel Set (ⓘ pg. 40), without ever having set the clock previously, the recorder's built-in clock is also set automatically.

Perform the following steps only if —

—Auto Clock Set has not been performed correctly by Auto Set Up or Auto Channel Set.

**OR**

—the recorder's memory backup has expired.

**OR**

—you want to change Just Clock setting (ⓘ "Just Clock" in the left column).

### 1 Turn on the recorder.

Press  $\text{⏻/⏪}$ .

### 2 Access the Main Menu screen.

Press **MENU**.

### 3 Access the Initial Set screen.

Press  $\Delta/\nabla$  to move the highlight bar (pointer) to "INITIAL SET", then press **OK** or  $\triangleright$ .

### 4 Access the Clock Set screen.

Press  $\Delta/\nabla$  to move the highlight bar (pointer) to "CLOCK SET", then press **OK** or  $\triangleright$ . The Clock Set screen appears.

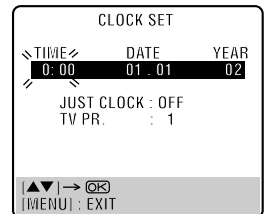
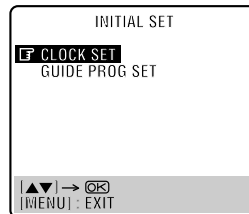

## NOTE:

When you have selected *MAGYARORSZÁG, ČESKÁ REPUBLIKA, POLSKA* or *OTHER EASTERN EUROPE* for the country setting (ⓘ pg. 10, 13), you cannot use Just Clock function. Skip steps 6 and 7 on page 47.

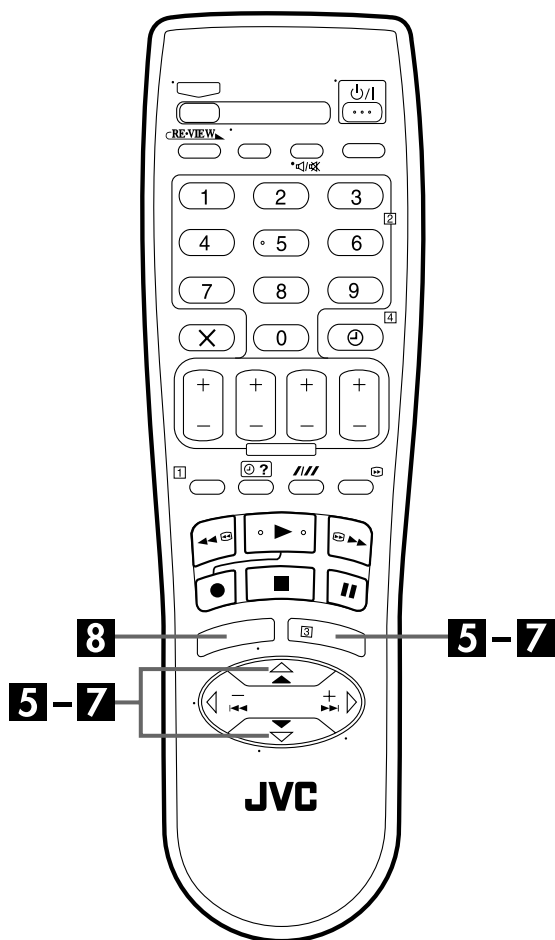

## 5 Set the date and time.

Press  $\Delta\nabla$  to set the time, then press **OK** or  $\triangleright$ . The "DATE" display begins blinking. Repeat the same procedure to set the date and year.

- When you set the time, press and hold  $\Delta\nabla$  to change the time by 30 minutes.
- When you set the date, press and hold  $\Delta\nabla$  to change the date by 15 days.

## 6 Set Just Clock.

The default setting is "OFF". Set as desired by pressing  $\Delta\nabla$ , then press **OK** or  $\triangleright$ .

- For the Just Clock function, refer to "Just Clock" on page 46.
- If you set to "OFF", you can disregard the next step as you won't be able to receive regular clock adjustments.

## 7 Set the source channel position for clock data.

The recorder is preset to receive clock setting and adjustment data from channel position 1.

Press  $\Delta\nabla$  to set the channel position to the number representing the station transmitting clock setting data, then press **OK** or  $\triangleright$ .

## 8 Start the clock operation.

Press **MENU**.

### NOTES:

- *Just Clock* (when set to "ON") adjusts the recorder's built-in clock every hour, except for 23:00, 0:00, 1:00 and 2:00.
- *Just Clock* is not effective when ...
  - ... the recorder's power is on.
  - ... the recorder is in the Timer mode.
  - ... a difference of more than 3 minutes exists between the built-in clock's time and the actual time.
  - ... the recorder is in the Power Save mode (☞ pg. 38).
  - ... "L-2 SELECT" is set to "SAT" (☞ pg. 31).
- If *Just Clock* is set to "ON", the recorder's clock is automatically adjusted at the start/end of Summer Time.
- *Just Clock* may not function properly depending on the reception condition.

# Video Channel Set

Video channel (RF output channel) is the channel on which your TV receives picture and sound signals from the recorder through the RF cable.

## IMPORTANT

Perform the following steps only if —

- Video Channel Set has not been done correctly by the Auto Set Up function (☞ pg. 10),
- interference appears in the TV picture after you have moved to a different area or a new station has started broadcasting in your area.
- you change the connection between your recorder and TV from RF connection to AV connection, or vice versa.

If you have connected the recorder to your TV via the AV connection (☞ pg. 9), since you do not need the video channel you have to set the video channel to off.

If you have connected the recorder to your TV via the RF connection (☞ pg. 9), you have to set the correct video channel.

### Before performing the following steps:

Make sure the recorder's power is off and there is no cassette inserted in the recorder.

## 1 Access the Video Channel Set mode.

Hold down **■/▲** on the recorder until the front display panel shows the following.

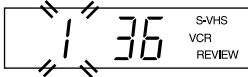

## 2 Set the RF output system.

The blinking number on the display indicates the RF output system of your country.

- If you have selected MAGYARORSZÁG, ČESKÁ REPUBLIKA, POLSKA or OTHER EASTERN EUROPE for the country setting (☞ pg. 10, 13), press **△▽** to set to "2".
- For other countries, set to "1". Then press **OK**.  
(1: B/G 2: D/K)

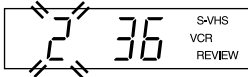

## 3 Set the video channel.

### With AV Connection

Press **PR -** until the front display panel shows "1 --" (or "2 --").

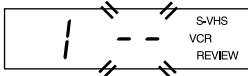

- Now the video channel is set to off.

### With RF Connection

Press **PR +** or **-** to set the video recorder to a vacant channel between 22 and 69 which is not occupied by any local station in your area.

(Example) If channel 50 is available in your area

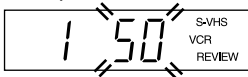

Then set your TV to UHF channel 50.

- If the two vertical white bars appear clearly on the TV screen as shown to the right, go to step 4.
- If the two vertical white bars do not appear clearly, re-set the video recorder to another vacant channel and try again.

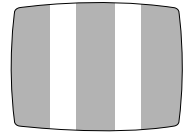

## NOTES:

- If you set the video recorder to a channel which is occupied by a local station or has neighbouring channels that are occupied by local stations, the picture reception quality will be affected and some interference noise will appear on the TV screen. Be sure to select a vacant channel which has no broadcast on neighbouring channels.
- If you cannot obtain the two vertical white bars clearly with any channel between 22 and 69, consult your JVC dealer.

## 4 Exit the Video Channel Set mode.

Press **OK** on the remote control.

### With AV Connection

To view picture signals from the video recorder, set your TV to its AV mode.

### With RF Connection

The channel on which the TV screen in step 3 appears clearly is your video channel.

To view picture signals from the video recorder, set your TV to the video channel.



# SHOWVIEW® System Setup

## IMPORTANT

Normally, Auto Set Up (pg. 10) or Auto Channel Set (pg. 40) sets the Guide Program numbers automatically. You need to set the Guide Program numbers manually only in the following cases.

- When timer-programming with the SHOWVIEW system, the channel position, where the station you wish to record is received on your recorder, is not selected,  
**OR**  
when you add a channel after Auto Set Up or Auto Channel Set has taken place,  
—Set the Guide Program number for that station manually.
- When you wish to timer-record a satellite programme with the SHOWVIEW system,  
—Set the Guide Program numbers for all satellite broadcasts received on your satellite receiver.

Turn on the TV and select the video channel (or AV mode).

## Guide Program Number Set

### 1 Access the Main Menu screen.

Press **MENU**.

### 2 Access the Initial Set screen.

Press  $\Delta\nabla$  to move the highlight bar (pointer) to "INITIAL SET", then press **OK** or  $\triangleright$ .

### 3 Access the Guide Program Set screen.

Press  $\Delta\nabla$  to move the highlight bar (pointer) to "GUIDE PROG SET", then press **OK** or  $\triangleright$ .

### 4 Enter the Guide Program number.

Press  $\Delta\nabla$  or **number keys** to enter the Guide Program number for the desired station as shown in the TV listings. Then press **OK** or  $\triangleright$ .

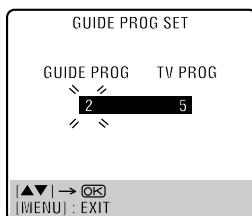

(Example) When inputting the Guide Program number 2 for ZDF.

### 5 Enter the receiving channel position number.

Press  $\Delta\nabla$  or **number keys** to input the number of the recorder's channel position on which the Guide Program number's broadcast is received by the recorder. Then press **OK** or  $\triangleright$ .

- If the satellite broadcast is received on your recorder's auxiliary channel "L-2", select "L-2" for the channel position.
- Repeat steps 4 and 5 as necessary.

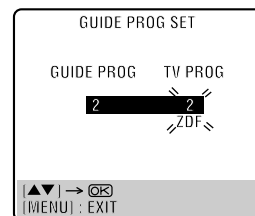

(Example) If ZDF is received on channel position 2.

### 6 Return to the normal screen.

Press **MENU**.

## Guide Program Number

"Guide Program (GUIDE PROG) number" refers to the assigned TV station numbers, according to broadcast area, for the SHOWVIEW timer recording. The Guide Program numbers can be found in most TV listings.

Before requesting service for a problem, use this chart and see if you can repair the trouble yourself. Small problems are often easily corrected, and this can save you the trouble of sending your video recorder off for repair.

## POWER

SYMPTOM	POSSIBLE CAUSE	CORRECTIVE ACTION
1. No power is supplied to the recorder.	• The mains power cord is disconnected.	Connect the mains power cord.
2. The clock is functioning properly, but the recorder cannot be powered.	• "⊖" is displayed on the front display panel with "AUTO TIMER" set to "OFF".	Press the ⊖ button to turn the "⊖" indicator off.
3. The remote control won't function.	• The batteries are discharged.	Replace the dead batteries with new ones.

## TAPE TRANSPORT

SYMPTOM	POSSIBLE CAUSE	CORRECTIVE ACTION
1. During recording, the tape does not run. "⊖" lights up and the channel display blinks on the front display panel.	• The recorder is in the Record Pause mode.	Press ► to resume recording.
2. The tape will not rewind or fast-forward.	• The tape is already fully rewound or fast-forwarded.	Check the cassette.

## PLAYBACK

SYMPTOM	POSSIBLE CAUSE	CORRECTIVE ACTION
1. The playback picture does not appear while the tape is running.	<ul style="list-style-type: none"> <li>• If you are using the RF connection, . . . the TV receiver's channel selector is not set to the video channel. . . . the recorder's video channel has not been correctly set.</li> <li>• If you are using the AV connection, the TV receiver is not set to the AV mode.</li> </ul>	<p>If you are using the RF connection, . . . set the TV receiver to the video channel. . . . perform "Video Channel Set" (ⓘ pg. 48).</p> <p>If you are using the AV connection, set the TV to its AV mode.</p>
2. Noise appears during visual search.	• This is normal.	
3. Noise appears during normal playback.	• The automatic tracking mode is engaged.	Try manual tracking. (ⓘ pg. 17)
4. The playback picture is blurred or interrupted while TV broadcasts are clear or "USE CLEANING CASSETTE" message appears on the screen.	• The video heads may be dirty.	Use a dry cleaning cassette TCL-2 or consult your JVC dealer.
5. Breaks are noticeable in Hi-Fi soundtrack.	• The automatic tracking mode is engaged.	Try manual tracking. (ⓘ pg. 17)

## RECORDING

SYMPTOM	POSSIBLE CAUSE	CORRECTIVE ACTION
1. Recording cannot be started.	<ul style="list-style-type: none"> <li>There is no cassette loaded, or the cassette loaded has had its record safety tab removed.</li> </ul>	Insert a cassette, or using adhesive tape, cover the hole where the tab was removed.
2. TV broadcasts cannot be recorded.	<ul style="list-style-type: none"> <li>"L-1", "L-2", "F-1" or "SAT" has been selected as the input mode.</li> </ul>	Set to the desired channel.
3. Tape-to-tape editing is not possible.	<ul style="list-style-type: none"> <li>The source (another video recorder, camcorder) has not been properly connected.</li> <li>All necessary power switches have not been turned on.</li> <li>The input mode is not correct.</li> </ul>	<p>Confirm that the source is properly connected.</p> <p>Confirm that all units' power switches are turned on.</p> <p>Set the input mode to "L-1", "L-2" or "F-1".</p>
4. Camcorder recording is not possible.	<ul style="list-style-type: none"> <li>The camcorder has not been properly connected.</li> <li>The input mode is not correct.</li> </ul>	<p>Confirm that the camcorder is properly connected.</p> <p>Set the input mode to "L-1", "L-2" or "F-1".</p>
5. "O" and "▷" on the front display panel won't stop blinking.	<ul style="list-style-type: none"> <li>The end of the tape was reached during recording.</li> </ul>	The programme may not have been recorded in its entirety. Next time make sure you have enough time on the tape to record the entire programme.

## TIMER RECORDING

SYMPTOM	POSSIBLE CAUSE	CORRECTIVE ACTION
1. Timer recording won't work.	<ul style="list-style-type: none"> <li>The clock and/or the timer have been set incorrectly.</li> <li>The timer is not engaged.</li> </ul>	<p>Re-perform the clock and/or timer settings.</p> <p>Press ⊖ and confirm that "⊖" is displayed on the front display panel.</p>
2. Timer programming is not possible.	<ul style="list-style-type: none"> <li>Timer recording is in progress.</li> </ul>	Timer programming can't be performed while a timer recording is in progress. Wait until it finishes.
3. "⊖" on the front display panel won't stop blinking.	<ul style="list-style-type: none"> <li>The timer is engaged but there's no cassette loaded.</li> </ul>	Load a cassette with the record safety tab intact.
4. "⊖", "O" and "▷" on the front display panel won't stop blinking.	<ul style="list-style-type: none"> <li>The loaded cassette has had its record safety tab removed.</li> <li>The end of the tape was reached during timer recording.</li> </ul>	<p>Remove the cassette and cover the hole with adhesive tape, or insert a cassette with the record safety tab intact.</p> <p>The programme may not have been recorded in its entirety. Next time make sure you have enough time on the tape to record the entire programme.</p>
5. "⊖" blinks for 10 seconds and the Timer mode is disengaged.	<ul style="list-style-type: none"> <li>⊖ has been pressed when there are no programs in memory, or the timer record information has been programmed incorrectly.</li> </ul>	Check the programmed data and re-program as necessary, then press ⊖ again.
6. The SHOWVIEW system does not timer-record properly.	<ul style="list-style-type: none"> <li>The recorder's channel positions have been set incorrectly.</li> </ul>	Refer to "Guide Program Number Set" (☞ pg. 49) and re-perform the procedure.
7. "O" and "▷" on the front display panel won't stop blinking.	<ul style="list-style-type: none"> <li>The end of the tape was reached during Instant Timer Recording.</li> </ul>	The programme may not have been recorded in its entirety. Next time make sure you have enough time on the tape to record the entire programme.

## OTHER PROBLEMS

SYMPTOM	POSSIBLE CAUSE	CORRECTIVE ACTION
1. Whistling or howling is heard from the TV during camcorder recording.	<ul style="list-style-type: none"> <li>• The camcorder's microphone is too close to the TV.</li> <li>• The TV's volume is too high.</li> </ul>	<p>Position the camcorder so its microphone is away from the TV.</p> <p>Turn the TV's volume down.</p>
2. When scanning channels, some of them are skipped over.	<ul style="list-style-type: none"> <li>• Those channels have been designated to be skipped.</li> </ul>	<p>If you need the skipped channels, restore them (☞ pg. 42).</p>
3. The channel cannot be changed.	<ul style="list-style-type: none"> <li>• Recording is in progress.</li> </ul>	<p>Press <b>  </b> to pause the recording, change channels, then press <b>▶</b> to resume recording.</p>
4. Channel settings that were made manually seem to have changed or disappeared.	<ul style="list-style-type: none"> <li>• After the manual settings were made, Auto Channel Set was performed.</li> </ul>	<p>Perform manual setting again.</p>
5. No channels are stored in the recorder's memory.	<ul style="list-style-type: none"> <li>• The TV aerial cable was not connected to the recorder when Auto Set Up was performed.</li> </ul>	<p>Turn off the recorder once and connect the TV aerial cable to the recorder properly, then turn on the recorder again. Then perform Auto Set Up again (☞ pg. 10).</p>

### ATTENTION

This recorder contains microcomputers. External electronic noise or interference could cause malfunctioning. In such cases, switch the recorder off and unplug the mains power cord. Then plug it in again and turn the recorder on. Take out the cassette. After checking the cassette, operate the unit as usual.

## PLAYBACK

**Q. What happens if the end of the tape is reached during playback or search?**

A. The tape is automatically rewound to the beginning.

**Q. During search, slow, still and frame-by-frame playback, I can't hear any audio. What's the problem?**

A. This is normal.

**Q. Can the video recorder indefinitely remain in the still mode?**

A. No. It stops automatically after 5 minutes to protect the heads.

**Q. When returning from variable-speed search to normal playback, the picture is disturbed. Should I be concerned about this?**

A. No, it is normal.

**Q. Noise bar appear during variable-speed search. What's the problem?**

A. This is normal.

**Q. Sometimes, during Index Search, the video recorder can't find the programme I want to see. Why not?**

A. There may be index codes too close together.

## RECORDING

**Q. When I pause and then resume a recording, the end of the recording before the pause is overlapped by the beginning of the continuation of recording. Why does this happen?**

A. This is normal. It reduces distortion at the pause and resume points.

**Q. Can the video recorder indefinitely remain in the Record-Pause mode?**

A. No. The video recorder goes to its Stop mode automatically after 5 minutes to protect the heads.

**Q. What happens if the tape runs out during recording?**

A. The video recorder stops recording, and "○" and "▷" on the front display panel won't stop blinking.

## TIMER RECORDING

**Q. "○" and "⊖" remain lit on the front display panel. Is there a problem?**

A. No. This is a normal condition for a timer recording in progress.

**Q. Can I programme the timer while I'm watching a tape or a TV broadcast?**

A. You won't see the picture as it is replaced by the on-screen menu, but the audio from the programme or tape you're viewing can be heard.

**GENERAL**

Power requirement	: AC 220 V – 240 V~, 50 Hz/60 Hz
Power consumption	
Power on	: 18 W
Power off	: 3.3 W
Temperature	
Operating	: 5°C to 40°C
Storage	: -20°C to 60°C
Operating position	: Horizontal only
Dimensions (WxHxD)	
	: 400 mm x 94 mm x 270 mm
Weight	: 3.2 kg
Format	: S-VHS/VHS PAL standard
Maximum recording time	
(SP)	: 240 min. with E-240 video cassette
(LP)	: 480 min. with E-240 video cassette

**VIDEO/AUDIO**

Signal system	: PAL-type colour signal and CCIR monochrome signal, 625 lines 50 fields
Recording system	: DA4 (Double Azimuth) head helical scan system
Signal-to-noise ratio	: 45 dB
Horizontal resolution	
	: 250 lines (VHS) 400 lines (S-VHS)
Frequency range	: 70 Hz to 10,000 Hz (Normal audio) 20 Hz to 20,000 Hz (Hi-Fi audio)
Input/Output	: 21-pin SCART connectors: IN/OUT x 1, IN/DECODER x 1 RCA connectors: VIDEO IN x 1, AUDIO IN x 1, AUDIO OUT x 1

**TUNER/TIMER**

TV channel storage capacity	: 99 positions (+AUX position)
Tuning system	: Frequency synthesized tuner
Channel coverage	: VHF 47 MHz – 89 MHz/ 104 MHz – 300 MHz/ 302 MHz – 470 MHz UHF 470 MHz – 862 MHz
Aerial output	: UHF channels 22 – 69 (Adjustable)
Memory backup time	: Approx. 10 min.

**ACCESSORIES**

Provided accessories	
	: RF cable, Infrared remote control unit, "R6" battery x 2

*Specifications shown are for SP mode unless otherwise specified.*

*E. & O.E. Design and specifications subject to change without notice.*

<b>A</b>	
AUTO POWER OFF .....	39
Auto Channel Set .....	40
Auto Set Up .....	10
AUTO SP→LP TIMER .....	38
AUTO TIMER .....	37
<b>B</b>	
B.E.S.T. Picture System .....	21, 37
<b>C</b>	
Change Station Channel Position .....	43
Check, cancel and change programmes .....	26
Clock Set .....	46
COLOUR SYSTEM .....	39
Connecting To A Satellite Receiver .....	32
<b>D</b>	
Delete A Channel .....	43
<b>E</b>	
EDITING .....	28
Elapsed Recording Time Indication .....	19
Express Timer Programming .....	24
<b>F</b>	
Fine-Tuning Channels Already Stored .....	44
<b>G</b>	
Guide Program Number Set .....	23, 49
<b>H</b>	
High-Speed (Turbo) Search .....	15
<b>I</b>	
Index Search .....	16
Instant ReView .....	16
Instant Timer Recording (ITR) .....	19
<b>J</b>	
Just Clock .....	46
<b>L</b>	
L-1 OUTPUT .....	30
L-2 INPUT .....	31
L-2 SELECT .....	31
Language .....	13
<b>M</b>	
Manual Channel Set .....	42
Manual Tracking .....	17
Mode Set .....	36
<b>N</b>	
Next Function Memory .....	17
<b>O</b>	
O.S.D. ....	37
ON-SCREEN DISPLAY .....	7
Output/Input Set .....	30
<b>P</b>	
PICTURE CONTROL .....	37
PLAYBACK .....	14
POWER SAVE .....	38
<b>R</b>	
Record One Programme While Watching Another ....	19
RECORDING .....	18
Recording Resume Function .....	18
Repeat Playback .....	17
<b>S</b>	
Set Stations (A) .....	44
Set Stations (B) .....	44
SHOWVIEW® System Setup .....	49
SHOWVIEW® Timer Programming .....	22
Skip Search .....	16
Slow Motion .....	15
Soundtrack Selection .....	17
Still Picture/Frame-By-Frame Playback .....	15
Super VHS ET (S-VHS ET) .....	20, 39
S-VHS .....	29, 39
<b>T</b>	
Tape Position Indicator .....	7
Tape Remaining Time .....	19
TIMER RECORDING .....	22
Tuner Set .....	40
TV Station And ID List .....	45
<b>V</b>	
Variable Speed Search .....	16
Video Channel Set .....	48
VIDEO STABILIZER .....	38
VPS/PDC Recording .....	25
<b>W</b>	
When Receiving A Scrambled Broadcast .....	43



VICTOR COMPANY OF JAPAN, LIMITED



## Free Manuals Download Website

<http://myh66.com>

<http://usermanuals.us>

<http://www.somanuals.com>

<http://www.4manuals.cc>

<http://www.manual-lib.com>

<http://www.404manual.com>

<http://www.luxmanual.com>

<http://aubethermostatmanual.com>

Golf course search by state

<http://golfingnear.com>

Email search by domain

<http://emailbydomain.com>

Auto manuals search

<http://auto.somanuals.com>

TV manuals search

<http://tv.somanuals.com>