



# JVC®

**CAUTION**

This section of instruction manual is specially edited for service purpose with modified contents.

# JVC®

**CAUTION**

This section of instruction manual is specially edited for service purpose with modified contents.

## DV VIDEO CASSETTE RECORDER

# BR-DV3000U INSTRUCTION MANUAL



## DV VIDEO CASSETTE RECORDER DV VIDEOKASSETTENREKORDER ENREGISTREUR A CASSETTE DIGITAL VIDEO DV VIDEOREGISTRATORE UNIDAD GRABADORA DE VÍDEO DV

# BR-DV3000E INSTRUCTION MANUAL BEDIENUNGSANLEITUNG MODE D'EMPLOI ISTRUZIONI PER L'USO MANUAL DE INSTRUCCIONES

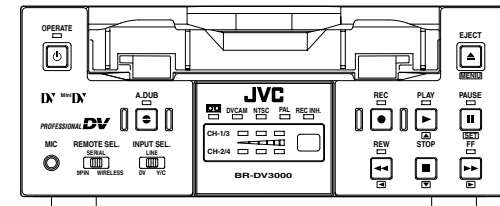
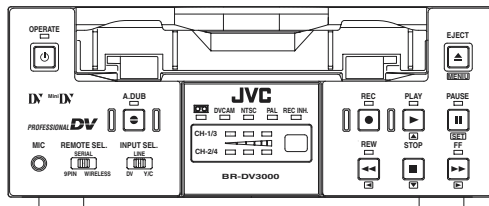

This instruction book is made from 100% recycled paper.

Thank you for purchasing this JVC product. Before operating this unit, please read the instructions carefully to ensure the best possible performance.

**For Customer Use:**

Enter below the Serial No. which is located on the rear of cabinet. Retain this information for future reference.

Model No. BR-DV3000U

Serial No. \_\_\_\_\_

Thank you for purchasing this JVC product. Before operating this unit, please read the instructions carefully to ensure the best possible performance.

This instruction book is made from 100% recycled paper.

## IMPORTANT SAFEGUARDS

1. Read all of these instructions.
2. Save these instructions for later use.
3. All warnings on the product and in the operating instructions should be adhered to.
4. Unplug this appliance system from the wall outlet before cleaning. Do not use liquid cleaners or aerosol cleaners. Use a damp cloth for cleaning.
5. Do not use attachments not recommended by the appliance manufacturer as they may cause hazards.
6. Do not use this appliance near water – for example, near a bathtub, washbowl, kitchen sink, or laundry tub, in a wet basement, or near a swimming pool, etc.
7. Do not place this appliance on an unstable cart, stand, or table. The appliance may fall, causing serious injury to a child or adult, and serious damage to the appliance.  
Use only with a cart or stand recommended by the manufacturer, or sold with the appliance.  
Wall or shelf mounting should follow the manufacturer's instructions, and should use a mounting kit approved by the manufacturer.  
An appliance and cart combination should be moved with care. Quick stops, excessive force, and uneven surfaces may cause the appliance and cart combination to overturn.
8. Slots and openings in the cabinet and the back or bottom are provided for ventilation, and to insure reliable operation of the appliance and to protect it from overheating, these openings must not be blocked or covered. The openings should never be blocked by placing the appliance on a bed, sofa, rug, or other similar surface. This appliance should never be placed near or over a radiator or heat register. This appliance should not be placed in a built-in installation such as a bookcase unless proper ventilation is provided.
9. This appliance should be operated only from the type of power source indicated on the marking label. If you are not sure of the type of power supplied to your home, consult your dealer or local power company. For appliance designed to operate from battery power, refer to the operating instructions.
10. This appliance system is equipped with a 3-wire grounding type plug (a plug having a third (grounding) pin). This plug will only fit into a grounding-type power outlet. This is a safety feature. If you are unable to insert the plug into the outlet, contact your electrician to replace your obsolete outlet. Do not defeat the safety purpose of the grounding plug.
11. For added protection for this product during a lightning storm, or when it is left unattended and unused for long periods of time, unplug it from the wall outlet and disconnect the antenna or cable system. This will prevent damage to the product due to lightning and power-line surges.
12. Do not allow anything to rest on the power cord. Do not locate this appliance where the cord will be abused by persons walking on it.
13. Follow all warnings and instructions marked on the appliance.
14. Do not overload wall outlets and extension cords as this can result in fire or electric shock.
15. Never push objects of any kind into this appliance through cabinet slots as they may touch dangerous voltage points or short out parts that could result in a fire or electric shock. Never spill liquid of any kind on the appliance.
16. Do not attempt to service this appliance yourself as opening or removing covers may expose you to dangerous voltage or other hazards. Refer all servicing to qualified service personnel.
17. Unplug this appliance from the wall outlet and refer servicing to qualified service personnel under the following conditions:
  - a. When the power cord or plug is damaged or frayed.
  - b. If liquid has been spilled into the appliance.
  - c. If the appliance has been exposed to rain or water.
  - d. If the appliance does not operate normally by following the operating instructions. Adjust only those controls that are covered by the operating instructions as improper adjustment of other controls may result in damage and will often require extensive work by a qualified technician to restore the appliance to normal operation.
  - e. If the appliance has been dropped or the cabinet has been damaged.
  - f. When the appliance exhibits a distinct change in performance – this indicates a need for service.
18. When replacement parts are required, be sure the service technician has used replacement parts specified by the manufacturer that have the same characteristics as the original part. Unauthorized substitutions may result in fire, electric shock, or other hazards.
19. Upon completion of any service or repairs to this appliance, ask the service technician to perform routine safety checks to determine that the appliance is in safe operating condition.

PORTABLE CART WARNING  
(symbol provided by RETAC)



## Supplement

This equipment is in conformity with the provisions and protection requirements of the corresponding European Directives. This equipment is designed for professional video appliances and can be used in the following environments:

- Residential (including both of the location type class 1 and 2 found in IEC 1000-2-5)
- Commercial and light industrial (including, for example, theatres)
- Urban outdoors (based on the definition of location type class 6 in IEC 1000-2-5)

This apparatus is designed for rack mounting or is used close to other apparatus.

In order to keep the best performance and furthermore for electromagnetic compatibility we recommend to use cables not exceeding the following lengths:

| Port   | Cable                     | Length    |
|--------|---------------------------|-----------|
| AUDIO  | SHIELDED CABLE            | 10 meters |
| LINE   | COAXIAL CABLE             | 10 meters |
| Y/C    | COAXIAL CABLE             | 10 meters |
| DV     | SHIELDED TWIST PAIR CABLE | 4 meters  |
| REMOTE | TWIST PAIR CABLE          | 5 meters  |

The inrush current of this apparatus is 1.7 amperes.

### Caution:

- Where there are strong electromagnetic waves or magnetism, for example near a radio or TV transmitter, transformer, motor, etc., the picture and sound may be disturbed. In such a case, please keep the apparatus away from the sources of the disturbance.



## SAFETY PRECAUTIONS

**CAUTION**  
RISK OF ELECTRIC SHOCK  
DO NOT OPEN

CAUTION: TO REDUCE THE RISK OF ELECTRIC SHOCK,  
DO NOT REMOVE COVER (OR BACK).  
NO USER-SERVICEABLE PARTS INSIDE.  
REFER SERVICING TO QUALIFIED SERVICE PERSONNEL

 The lightning flash with arrowhead symbol, within an equilateral triangle, is intended to alert the user to the presence of uninsulated "dangerous voltage" within the product's enclosure that may be of sufficient magnitude to constitute a risk of electric shock to persons.

 The exclamation point within an equilateral triangle is intended to alert the user to the presence of important operating and maintenance (servicing) instructions in the literature accompanying the appliance.

**WARNING:**  
TO REDUCE THE RISK OF FIRE OR  
ELECTRIC SHOCK, DO NOT EXPOSE THIS  
APPLIANCE TO RAIN OR MOISTURE.

This unit should be used with 120 V AC only.

**CAUTION:**  
To prevent electric shocks and fire hazards, DO  
NOT use any other power source.

### NOTE:

The rating plate (serial number plate) is on the rear of the unit.

### INFORMATION

This equipment has been tested and found to comply with the limits for a Class B digital device, pursuant to Part 15 of the FCC Rules. These limits are designed to provide reasonable protection against harmful interference in a residential installation. This equipment generates, uses, and can radiate radio frequency energy and, if not installed and used in accordance with the instructions, may cause harmful interference to radio communications. However, there is no guarantee that interference will not occur in a particular installation. If this equipment does cause harmful interference to radio or television reception, which can be determined by turning the equipment off and on, the user is encouraged to try to correct the interference by one or more of the following measures:

- Reorient or relocate the receiving antenna.
- Increase the separation between the equipment and receiver.
- Connect the equipment into an outlet on a circuit different from that to which the receiver is connected.
- Consult the dealer or an experienced radio/TV technician for help.

### CAUTION

CHANGES OR MODIFICATIONS NOT APPROVED  
BY JVC COULD VOID USER'S AUTHORITY TO  
OPERATE THE EQUIPMENT.

THIS DEVICE COMPLIES WITH PART 15 OF THE  
FCC RULES. OPERATION IS SUBJECT TO THE  
FOLLOWING TWO CONDITIONS: (1) THIS DEVICE  
MAY NOT CAUSE HARMFUL INTERFERENCE, AND  
(2) THIS DEVICE MUST ACCEPT ANY INTERFER-  
ENCE RECEIVED, INCLUDING INTERFERENCE  
THAT MAY CAUSE UNDESIRABLE OPERATION.

**ATTENTION**  
RISQUE D'ELECTROCUTION  
NE PAS OUVRIR

ATTENTION: POUR EVITER TOUT RISQUE D'ELECTROCUTION  
NE PAS OUVRIR LE BOITIER.  
AUCUNE PIECE INTERIEURE N'EST  
A REGLER PAR L'UTILISATEUR.  
SE REFERER A UN AGENT QUALIFIE EN CAS DE PROBLEME.

 Le symbole de l'éclair à l'intérieur d'un triangle équilatéral est destiné à alerter l'utilisateur sur la présence d'une "tension dangereuse" non isolée dans le boîtier du produit. Cette tension est suffisante pour provoquer l'électrocution de personnes.

 Le point d'exclamation à l'intérieur d'un triangle équilatéral est destiné à alerter l'utilisateur sur la présence d'opérations d'entretien importantes au sujet desquelles des renseignements se trouvent dans le manuel d'instructions.

\*Ces symboles ne sont utilisés qu'aux Etats-Unis.

**AVERTISSEMENT:**  
POUR EVITER LES RISQUES D'INCENDIE  
OU D'ELECTROCUTION, NE PAS EX-  
POSER L'APPAREIL A L'HUMIDITE OU A  
LA PLUIE.

Ce magnétoscope ne doit être utilisé que sur  
du courant alternatif en 120 V.

**ATTENTION:**  
Afin d'éviter tout resque d'incendie ou  
d'électrocution, ne pas utiliser d'autres sources  
d'alimentation électrique.

### REMARQUE:

La plaque d'identification (numéro de série) se  
trouve sur le panneau arrière de l'appareil.

### WARNING:

The battery used in the BR-DV3000U must be  
replaced by a JVC authorized service dealer only.

This digital apparatus does not exceed the Class B  
limits for radio noise emissions from digital  
apparatus as set out in the interference-causing  
equipment standard entitled "Digital Apparatus",  
ICES-003 of the Department of Communications.

Cet appareil numérique respecte les limites de  
bruits radioélectriques applicables aux appareils  
numériques de Classe B prescrites dans la norme  
sur le matériel brouilleur: "Appareils Numériques",  
NMB-003 édictée par le ministre des Communica-  
tions.

## SAFETY PRECAUTIONS

### Warning Notice FOR YOUR SAFETY (Australia)

1. Insert this plug only into effectively earthed three-pin power outlet.
2. If any doubt exists regarding the earthing, consult a qualified electrician.
3. Extension cord, if used, must be three-core correctly wired.

### IMPORTANT (In the United Kingdom) Mains Supply (AC 230 V ~) WARNING – THIS APPARATUS MUST BE EARTHED

The wires in this mains lead are coloured in accordance with the following code;

GREEN-and-YELLOW : EARTH  
BLUE : NEUTRAL  
BROWN : LIVE

As the colours of the wires in the mains lead of this apparatus may not correspond with the coloured markings identifying the terminals in your plug, proceed as follows.

The wire which is coloured GREEN-AND-YELLOW must be connected to the terminal in the plug which is marked with the letter E or by the safety earth symbol  $\perp$  or coloured GREEN or GREEN-AND-YELLOW. The wire which is coloured BLUE must be connected to the terminal which is marked with the letter N or which is coloured BLACK. The wire which is coloured BROWN must be connected to the terminal which is marked with the letter L or coloured RED.

### POWER SYSTEM

**Connection to the mains supply**  
This unit operates on voltage of 220 V to  
240 V AC, 50 Hz/60 Hz.

### WARNING:

**TO REDUCE THE RISK OF FIRE OR  
ELECTRIC SHOCK, DO NOT EXPOSE  
THIS APPLIANCE TO RAIN OR  
MOISTURE.**

### CAUTION

To prevent electric shock, do not open the cabinet. No user serviceable parts inside. Refer servicing to qualified service personnel.

### Note:

The rating plate and the safety caution are on the rear of the unit.

The OPERATE button does not completely shut off mains power from the unit, but switches operating current on and off.

### WARNING

It should be noted that it may be unlawful to re-record pre-recorded tapes, records, or discs without the consent of the owner of copyright in the sound or video recording, broadcast, or cable programme and in any literary, dramatic, musical or artistic work embodied therein.

### Caution for AC Mains Lead

#### FOR YOUR SAFETY PLEASE READ THE FOLLOWING TEXT CAREFULLY.

This product is equipped with 2 types of AC cable. One is for continental Europe, etc. and the other one is only for U.K.

Appropriate mains cable must be used in each local area, since the other type of mains cable is not suitable.

#### FOR CONTINENTAL EUROPE, ETC.

Not to be used in the U.K.

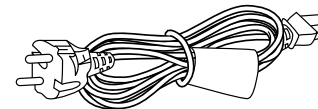

#### FOR U.K. ONLY

If the plug supplied is not suitable for your socket outlet, it should be cut off and appropriate one fitted.

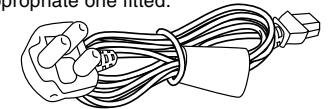

Thank you for purchasing our DV  
Video Cassette Recorder BR-DV3000.



As this is a DV-format video cassette recorder, video cassettes with the DV or Mini DV logos can be used with it. DVCAM cassettes can be recorded in DV format.

This VTR features dual support for NTSC and PAL. Certain functions however, are supported by only one signal system. They are indicated with (NTSC only) or (PAL only).

- In order to prevent crumpling due to tape slack, please do not perform important recording within the first and last 2 – 3 minutes run of the tape.
- Recorded video (music) is meant for personal entertainment only and must not be used for other purposes without the prior consent of the copyright owner.
- Our company shall not guarantee the content of any recording effort should this VTR fail to record normally due to defects, either of the main unit itself or the video cassette tape.

## MAIN FEATURES

- **DV format**  
High picture and sound quality by digital technology.
- **Compatible mechanisms for standard/mini DV cassettes**  
It records on and plays back DV cassettes of the standard and mini size. (SP mode only)  
DVCAM cassettes can be recorded in DV format.  
A tape recorded with the DVCAM format can be used only for playback for this VTR.
- **Equipped with composite and Y/C input & output terminal devices.**
- **Equipped with DV IN/OUT terminals. (IEEE1394)**  
It can exchange digital signals with IEEE1394-compatible devices.
- **Dual support for NTSC/PAL**  
It automatically determines the signal system when playing back or receiving DV signal input. It supports composite or Y/C signal input with the use of a switch.
- **Wireless/wired remote control**  
It can be controlled with the provided wireless remote controller or the optional wired remote controller RM-G30.
- **Support for RS-422A interface**  
It can be used as a player for an editing system that uses the RS-422A-compatible editing remote controller RM-G820.
- **Recording/playback of time codes**
- **Audio-dubbing (after-recording) function**  
Audio dubbing at a sampling frequency of 32kHz is allowed on CH3 and CH4 (except during DV input).
- **Backup recording function**  
By linking with other DV devices, long-duration continuous recording is possible.
- **Indexed search and blank search function**  
It can search for indexed signal recorded positions or unrecorded parts.
- **Repeat play function**  
There are 3 types of repeat function. (Index/Video End/ Tape End)
- **Can be placed in an upright position**  
With the use of the provided stand, it can be positioned upright.

## TABLE OF CONTENTS

### INTRODUCTION

|  |   |
|--|---|
| Precautions .....                              | 6 |
| Daily maintenance and regular inspection ..... | 7 |
| Precautions on the use of cleaning tape .....  | 8 |
| Cassette tape .....                            | 8 |
| Condensation .....                             | 9 |

### NAMES AND FUNCTIONS OF VARIOUS PARTS

|                                  |    |
|----------------------------------|----|
| Front panel .....                | 10 |
| Rear panel .....                 | 14 |
| Wireless remote controller ..... | 16 |

### ON-SCREEN DISPLAY

|                                   |    |
|-----------------------------------|----|
| Regarding on-screen display ..... | 18 |
| Status display .....              | 19 |
| Event display .....               | 21 |
| Alarm display .....               | 22 |

### PREPARATION

|  |    |
|--|----|
| Provided wireless remote controller .....  | 24 |
| Power .....                                | 26 |
| Selecting the NTSC/PAL signal system ..... | 28 |
| OPERATION LOCK mode .....                  | 29 |
| Loading/ejecting cassettes .....           | 30 |
| Setting/displaying date and time .....     | 31 |

### RECORDING

|  |    |
|--|----|
| Connection and setting .....                   | 33 |
| Setting time codes .....                       | 36 |
| Recording method .....                         | 38 |
| Audio dubbing .....                            | 39 |
| Backup recording function .....                | 40 |
| Recording using the serial remote terminal ... | 41 |

### PLAYBACK

|                                       |    |
|---------------------------------------|----|
| Connection/setting .....              | 42 |
| Basic playback method .....           | 44 |
| Special playback function .....       | 45 |
| Locate function .....                 | 47 |
| Repeat playback .....                 | 48 |
| Selecting playback audio output ..... | 49 |

### EDIT

|   |    |
|---|----|
| Using the unit in an editing system ..... | 50 |
|---|----|

### MENU SCREEN

|                             |    |
|-----------------------------|----|
| Structure of the menu ..... | 53 |
| Setting the menu .....      | 54 |
| Contents of the menus ..... | 56 |

### OTHERS

|   |    |
|---|----|
| Placing the unit in an upright position ..... | 65 |
| Warning display .....                         | 66 |
| Troubleshooting .....                         | 68 |
| Checking the hour meter .....                 | 69 |
| Specification .....                           | 70 |

# INTRODUCTION

## Precautions

### ■ Place of storage and use

Please avoid storing or using this VTR in the following places:

- Extremely hot or cold places beyond the allowable temperature for operation (5°C – 40°C)
- Humid or dry places beyond the allowable humidity range for operation (30% – 80% RH)
- Dusty or sandy places
- Places exposed to oil, smoke or steam, such as the kitchen vicinity
- Intensely vibrating or unstable places
- Places prone to condensation
- Places that generate strong magnetic fields, e.g., transformer or motor
- Places near devices that generate electric waves, e.g., transceiver or mobile phone
- Places that generate radiation, X-rays or corrosive gases

### ■ Handling the unit

- Please do not place heavy objects on the VTR, like a monitor or TV.
- Please do not insert foreign objects into the cassette slot.
- Mind your finger when loading the cassette. Please be careful not to get your fingers clamped when loading the cassette to prevent injury.
- Place this VTR out of reach of young children. As injury may result from fingers getting clamped when loading the cassette, please keep this VTR out of reach of young children.
- Please do not block the ventilation openings.
- Avoid violent shocks to the unit. Do not drop the unit.
- Please remove the cassette tape from the cassette slot when transporting the unit.
- Please remove the AC adapter to save energy when the unit is not in use.

### ■ Maintaining the unit (Please turn off the power before performing maintenance work.)

Please wipe the unit with a soft cloth. Do not wipe it with thinner or benzene lest the surface melts or becomes dull. For stubborn stains, wipe first with a water-diluted neutral detergent and then wipe dry.

### ■ Please use the provided AC adapter to connect the VTR to a power source.

## Daily maintenance and regular inspection

This unit uses consumables or components that will wear off. If a worn-out or deteriorated component continues to be used, it may cause the unit to break down. To prevent this, please perform daily maintenance using the head-cleaning tape. With the head-cleaning tape alone, however, the entire tape-winding mechanism cannot be completely cleaned. Please perform regular maintenance of the components as shown below.

### ■ Regular inspection (maintenance)

The tasks of maintenance involved are similar to that of replacing the engine oil or tire of a car. Depending on the number of usage hours, please clean, inspect or replace the components as follows:

| Number of hours                | 500H | 1000H | 1500H | 2000H | 4000H |
|--------------------------------|------|-------|-------|-------|-------|
| Drum assembly (including head) | ○    | ○     | ○     | ●     | ●     |
| Head cleaner                   | ☆    | ●     | ☆     | ●     | ●     |
| Tape guide, roller             | ○    | ☆     | ☆     | ●     | ●     |
| Rotary encoder                 | —    | —     | —     | ☆     | ●     |
| Gears                          | —    | ☆     | —     | ●     | ●     |
| Driving components             | —    | —     | —     | ☆     | ●     |

- : Inspection
- : Cleaning, inspection and adjustment
- ☆ : Cleaning and inspection; Replacement if necessary
- : Replacement

Maintenance necessity and frequency depends on the environment and usage. The above information serves only as a guide.

### Usage Time

: You can check the drum usage time via the hour meter display. For details, please refer to page 69, "Checking the hour meter".

### Maintenance consultation

: For details on the maintenance plan and fee, please consult with your nearest JVC-authorized service agent.

### ■ Head cleaning

- Recording or playing back with a stained head will result in block noise or disrupted sound. Please perform regular head cleaning to maintain superior image and sound quality.

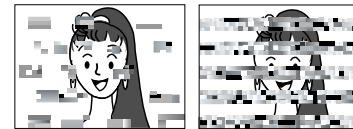

Block noise

- If dust adheres on the head, "HEAD CLEANING REQUIRED!" will be displayed on the monitor when this unit plays a tape.

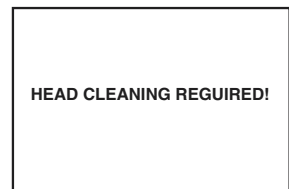

- For information on how to use the head cleaning tape and the relevant precautions, please refer to page 8, "Precautions on the use of cleaning tape".

## INTRODUCTION

### Precautions on the use of cleaning tape

Please use cleaning tape produced by JVC.

Please follow the instructions below when using the cleaning tape.

- The tape will run for 10 seconds in the PLAY mode. (Thereafter, it stops automatically and enters the STOP mode.)
  - After loading the cleaning tape, press the PLAY button.
- For a single cleaning session, use it up to 4 times.
- Please refer to the following table as a guide for cleaning:

#### Memo:

- Under low humidity conditions, (10% RH to 30% RH), please perform head cleaning at intervals of half of the following stated periods.
- If M-DV80 is used immediately after cleaning, the VTR warning ("HEAD CLEANING REQUIRED!") may disappear only after the tape has run for some time.
- Please use the cleaning tape at room temperature (10°C to 35°C).
- Instructions for using the cleaning tape are stated inside its case. The contents may be slightly different from those stated here. Please follow the instructions in this manual.

| Operating environment of the unit | Low temperature<br>5°C to 10°C | Room temperature<br>10°C to 35°C  | High temperature<br>35°C to 40°C |
|-----------------------------------|--------------------------------|-----------------------------------|----------------------------------|
| Guide for using cleaning tape     | 1 to 2 times every 5 hours     | 1 to 2 times every 20 to 30 hours | 1 to 2 times every 5 hours       |

### Cassette tape

This unit can record onto and playback standard DV and mini DV cassette tapes (for SP mode only). Please use the following JVC cassettes with the **DV** or the **mini DV** logos.

- Standard DV cassettes**
  - LA-DV276
  - LA-DV186
  - LA-DV124
- Mini DV cassettes**
  - M-DV63PR0
  - M-DV60
  - M-DV30

#### Memo

- DVCAM cassettes can be recorded in DV format. Tapes recorded in DVCAM format can be played (SP Mode).
- M-DV80 cassettes (Mini DV 80min tape) cannot be used with this unit.

#### Precautions on the use of tape

- Reverse sides of videotapes cannot be used.
- Please store the tape only after it has been fully rewound, so as to avoid damaging the tape.
- Please store the cassette in places low in humidity, well-ventilated and fungus-proof.
- When a cassette is used repeatedly, noise may increase due to e.g., dropout, etc. hence affecting its performance. Please do not use dirty or damaged tapes as they will shorten the life span of the rotation head.

#### Erasure prevention

DV cassettes have a safety slide at the back to prevent accidental erasure.

- To prevent accidental erasure of important records, push the slide to the "SAVE" position.
- To record, push the slide to the "REC" position.

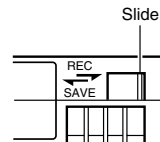

### Condensation

- When this unit is moved from a cold to a warm place abruptly, the vapor in the warm air will come into contact with the head drum or the tape guides. When chilled, the vapor turns into droplets of water. This state is known as condensation. When condensation occurs, the videotape will adhere to the head drum or the tape guides and will be damaged.
- Condensation occurs on this unit in the following circumstances:
  - It is moved abruptly from a cold place to a warm place.
  - It is used in a room immediately after the heater has been turned on, or when cold breeze from an air-conditioner blows onto it.
  - It is used at a place of high humidity.

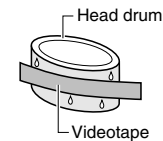

When a cassette tape is loaded, please do not transport e.g., from an external cold place to a warm room thereby subjecting the unit to drastic temperature changes. After moving the unit, please do not use it until the innards are stabilized.

- When condensation occurs, the monitor displays the following warning:

CONDENSATION ON DRUM

To remedy, leave the unit with the power ON and wait until the WARNING indicator disappears.

- Prevention of condensation

When transporting the BR-DV3000 from a cold to a warmer place abruptly, first take out the cassette. Then place the BR-DV3000 in a plastic bag and seal it before transporting the camera. Leave the BR-DV3000 in the sealed plastic bag until the camera has the same temperature as the surroundings. This will prevent condensation.



# NAMES AND FUNCTIONS OF VARIOUS PARTS

## - Front panel -

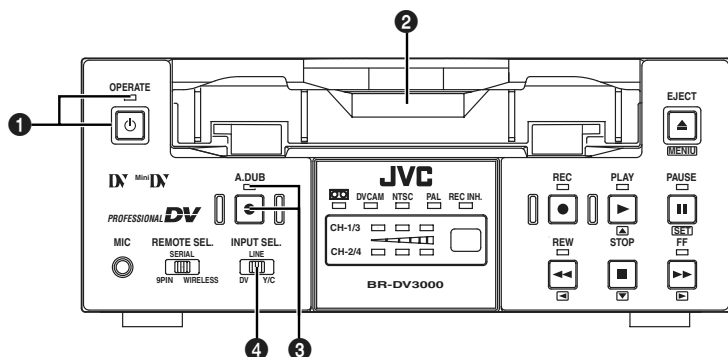

### 1 [OPERATE] Operate button/LED

- Press this button to turn on the power and operate the unit. (Operate ON)  
Press this button again to turn off the power. (Operate OFF)
- The OPERATE LED lights up as follows.  
Operate ON : the LED lights up green  
Operate OFF : the LED lights up red  
VTR error : the LED blinks in red

#### Memo

- When the DC IN MODE item of the SYSTEM menu is set to "OPE ON" and power is supplied to the 1 [DC IN] terminal located at the rear panel, the unit goes into the OPERATE ON state even if this button is not pressed.
- Even when the power has been turned off with this button, a small amount of electricity will still be channeled into the unit. Therefore, if the unit is not going to be used for a long period of time, please remove the AC adapter to reduce energy consumption.

### 2 Cassette slot

- Load a cassette into or unload it from the slot. Please insert a standard DV or a mini DV cassette. Page 30
- When the unit is in the OPERATE OFF state and if a cassette is loaded, it goes into the ON state.

### 3 [A. DUB] Audio dubbing button/LED

- Press this button for audio dubbing (after-recording).  
For audio dubbing, set the AUDIO MODE item of the AUDIO/VIDEO menu to "32K".  
Sound produced by the 6 MIC terminal or the 9 AUDIO IN terminal at the rear panel is recorded on CH3 and CH4 channels.
- During audio dubbing, the A. DUB LED lights up red.
- If the INPUT SEL switch is set at DV, audio dubbing is not possible.  
Page 39, "Audio dubbing"

### 4 [INPUT SEL] Input video signal selection switch

- Select the video signal input with this switch.  
Y/C : YC separate video signals from the Y/C IN terminal  
LINE : composite video signals from the LINE IN terminal  
DV : DV signals from the DV IN/OUT terminal (IEEE1394)

#### Note

During recording, please do not manipulate this switch. Even if you do, it will not work.

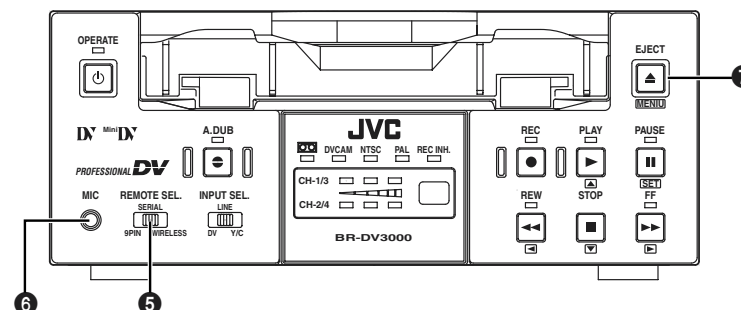

### 5 [REMOTE SEL.] Remote select switch

Use this switch to select the remote controller type.

- 9 PIN : Select this to use the RS-422A-compatible editing remote controller (RM-G820) that connects to the 4 9 PIN REMOTE terminal located at the rear panel. Please use this unit as a player.

\* This setting is valid only when the REMOTE item of the REMOTE menu is set to ON.

- SERIAL : Select this to use the serial remote controller (RM-G30) that connects to the 3 SERIAL REMOTE terminal located at the rear panel.

\* This setting is valid only when the REMOTE item of the REMOTE menu is set to ON.

- WIRELESS : Select this to use the provided wireless remote controller.

#### Memo

- When 9 PIN or SERIAL is selected, the buttons on the unit you wish to render operable can be selected from the LOCAL FUNCTION item of the REMOTE menu. Page 59
- During OPERATION LOCK, this switch will not be effective.
- Control via the DV IN/OUT terminal is possible (ie unaffected by the switch setting).

### 6 [MIC] Microphone input terminal

This is the mini jack for monaural microphone input. When this terminal is connected to a microphone, sound input via the AUDIO IN terminal located on the rear panel is not recorded. Sound from this terminal is recorded on CH1/CH2 in the RECORD mode and CH3/CH4 in the AUDIO DUBBING mode.

### 7 [EJECT] Eject button

- Press this button to eject the cassette.

#### Memo

It takes about 6 seconds for the cassette to be ejected.

- If no cassette is loaded and this button is pressed for at least 2 seconds, a menu will be displayed on the monitor connected to the VIDEO LINE OUT or Y/C OUT terminal.
- When the menu is displayed, pressing this button will resume the usual screen.  
Page 54, "Setting the menu"

## NAMES AND FUNCTIONS OF VARIOUS PARTS

### - Front panel - (continued)

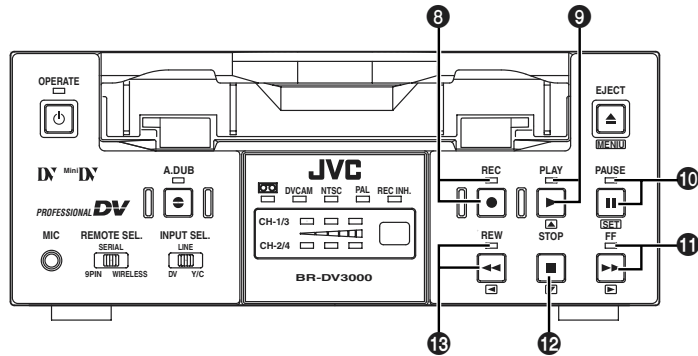

#### 8 [REC] Record button/LED

- Hold down this button and press the 9 PLAY button to start recording. During recording, the LED lights up red.
  - Hold down this button and press the 10 PAUSE button to pause the recording.
  - When this button is pressed during recording, an index signal is recorded on the tape (valid when the INDEX WRITE item in the SYSTEM menu is set to ON).
  - When recording is stopped, the time code generator value can be verified by holding this button down.
- If the TC DUPLICATE menu item is set to AUTO or NON DROP, EE signals of the DV Input time code and Date/Time can be verified.

#### 9 [PLAY] Play button/LED

- Press this button to start playing back a tape. During playback, the LED lights up green.
- When recording is paused, press this button to resume recording.
- When the menu is displayed, use this button to select the menu items or setting values.

#### 10 [PAUSE] Pause button/LED

- During recording, press this button to pause it. During playback or STOP mode, press this button to enter the STILL mode. When recording is paused or when the unit is in the STILL mode, the LED lights up green.
- If this button is pressed simultaneously with the A.DUB button in the STILL mode, the Audio Dubbing Pause mode will be engaged.
- When the menu is displayed, use this button to confirm the menu items or setting values.

#### 11 [FF] Fast forward button/LED

- When the unit is in the STOP mode, press this button to execute fast-forward winding of the tape.
- When the unit is in the PLAYBACK or STILL mode, press this button to execute fast-forward playback. The Fast-forward playback speed changes in the following sequence each time this button is pressed:  
X20→X5→X9→X20...  
In the DVCAM mode, the maximum speed is 15X.
- During fast-forward winding or fast-forward playback, the LED lights up green.
- When the menu is displayed, use this button to display selected menu items.
- When setting up the date, time or time code, use this button to select the data segment.

#### 12 [STOP] Stop button/LED

- Press this button to stop operation. (of rewind, playback, etc.)
- When the menu is displayed, use this button to select the menu items or setting values.

#### 13 [REW] Rewind button/LED

- When the unit is in the STOP mode, press this button to rewind the tape.
- When the unit is in the PLAYBACK or STILL mode, press this button to execute reverse playback. The Reverse playback speed changes in the following sequence each time this button is pressed:  
X20→X5→X9→X20...  
In the DVCAM mode, the maximum speed is 15X.
- During rewinding or reverse playback, the LED lights up green.
- When the menu is displayed, press this button to return to the previous screen. When setting up the date, time or time code, use this button to select the data segment.

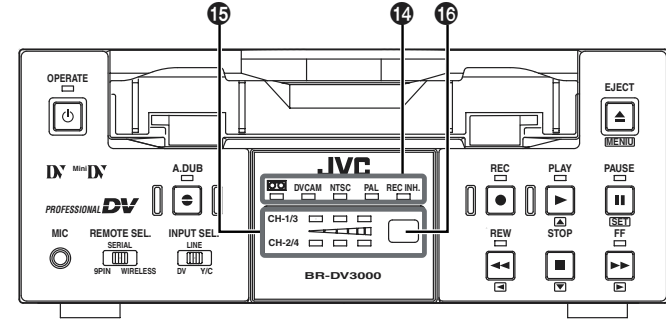

#### 14 Indicator



: When a cassette is loaded, the LED lights up green. (Likewise when the unit is in the OPERATE OFF state.)  
When a cassette is being loaded or ejected, the LED blinks.

**DVCAM** : When the unit plays back a tape recorded in the DVCAM format, the LED lights up green.

**NTSC** : The LED lights up green in the following cases:

- In the composite video or YC video signal input mode and the 2 NTSC/PAL switch located at the rear panel is set as "NTSC".
- A tape recorded with NTSC signals is played back.
- When NTSC signals are input while the INPUT SEL switch is set at DV.

**PAL** : The LED lights up green in the following cases:

- In the composite video or YC video signal input mode and the 2 NTSC/PAL switch located at the rear panel is set as "PAL".
- A tape recorded with PAL signals is played back.
- When PAL signals are input while the INPUT SEL switch is set at DV.

**REC INH** : The LED lights up red for about 5 seconds when the unit is set to the recording mode but fails to record. E.g. when the rear slide of the cassette is pushed to the "SAVE" position.

#### 15 Audio indicator

This indicator allows the user to check the availability of audio signals. 3 indicators each are available to CH1/3 and Ch2/4.

#### 16 Sensor for wireless remote controller

When using the provided wireless remote controller, please point it to this sensor. (See Page 25, "USING THE WIRELESS REMOTE CONTROLLER")



## NAMES AND FUNCTIONS OF VARIOUS PARTS

### - Rear panel -

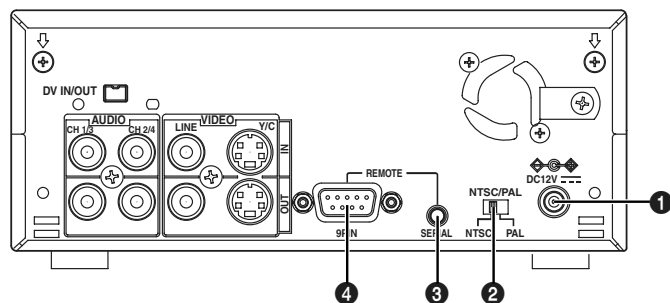

#### 1 DC power input terminal (2P)

This is used for DC12V input. It connects the DC power cord of the provided AC adapter.

##### Memo

- When power is supplied to this terminal, the OPERATE indicator located at the front panel lights up. (The LED lights up red when the OPERATE indicator is OFF.)
- Setting this unit to OPERATE ON, OPERATE OFF or PLAY mode when the power is supplied to this terminal can be done by making the appropriate selections from the DC IN MODE item in the SYSTEM menu.

#### 2 [NTSC/PAL] NTSC/PAL signal selection switch

Use this switch to select NTSC or PAL as the signal system. Use it to make a selection when composite video signals or YC separate video signals are input.

**NTSC** : Use this setting for NTSC signal input. The NTSC indicator on the front panel lights up.

**PAL** : Use this setting for PAL signal input. The PAL indicator on the front panel lights up.

##### Memo

- For playback or DV signal input, signals are determined automatically and not affected by the status of this switch.
- Please turn the unit to OPERATE OFF before using this switch. If switching is performed when the VTR is in the OPERATE ON mode, the VTR will automatically go into the OFF mode before engaging the ON mode.
- It cannot be used for NTSC/PAL conversion.

#### 3 [SERIAL REMOTE] serial remote terminal (mini jack)

Connect this terminal to the serial remote controller RM-G30, which is available separately. To control this unit via this terminal, please set it up as follows.

- Set the REMOTE item of the REMOTE menu to ON.
- Set the [REMOTE SEL.] switch on the front panel to "SERIAL".

##### Memo

To use this terminal as the FOOT switch input terminal, please set the FOOTSW item of the REMOTE (2/2) menu. Page 60

#### 4 [9 PIN REMOTE] 9-pin remote terminal (D-SUB)

Use this terminal to connect to the RS-422A-compatible editing remote controller (RM-G820). Please use this unit as a player. To control this unit with this terminal, please set it up as follows:

- Set the REMOTE item of the REMOTE menu to ON.
- Set the [REMOTE SEL.] switch on the front panel to "9 PIN".

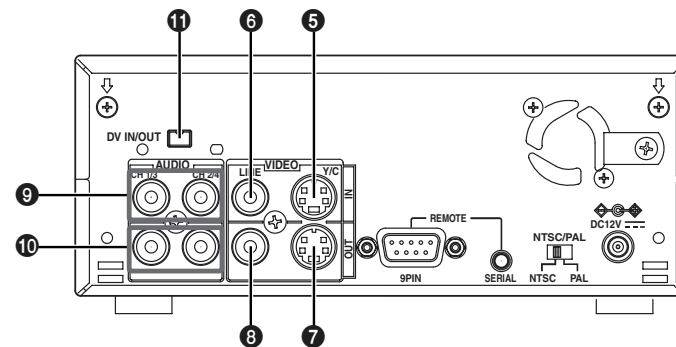

#### 5 [VIDEO Y/C IN] Video Y/C input terminal (4P)

This is the input terminal for YC separate video signals.

- To input video signals from this terminal, set the [INPUT SEL.] switch on the front panel to "Y/C".
- When Wide discriminating signals are input, ID signals for Wide discriminating signals are recorded.

#### 6 [VIDEO LINE IN] Video line input terminal (RCA)

This is the input terminal for composite video signals.

- To input video signals from this terminal, set the [INPUT SEL.] switch on the front panel to "LINE".

#### 7 [VIDEO Y/C OUT] Video Y/C output terminal (4P)

This is the output terminal for YC separate video signals.

#### 8 [VIDEO LINE OUT] Video line output terminal (RCA)

This is the output terminal for composite video signals. When tapes recorded with Wide discriminating signals are played, ID signals for discriminating signals are output.

##### Memo

- Besides video signals, the following signals from the [VIDEO Y/C OUT] terminal and [VIDEO LINE OUT] terminal are displayed on-screen.
  - Menu screen signals
  - Character display of date, time or operation modes (Status screen)
- By pressing the DISPLAY button on the wireless remote controller or by setting the DISPLAY item in the DISPLAY menu, the user can choose to turn the status display on/off.
- The SETUP item of the AUDIO/VIDEO menu can be set to determine whether setup will be added to the signals of [VIDEO Y/C OUT] terminal and [VIDEO LINE OUT] terminal. (NTSC only).

#### 9 [AUDIO IN] Audio input terminal (RCA x 2)

This is the audio signal (analogue) input terminal.

For audio dubbing, sounds from the CH1/3 terminal are recorded on the CH3 channel while those from the CH2/4 channel are recorded on the CH4 channel.

##### Memo

When the MIC terminal on the front panel is connected to a microphone, sounds from this terminal will not be recorded.

#### 10 [AUDIO OUT] Audio output terminal (RCA x 2)

This is the audio signal (analogue) output terminal.

##### Memo

- The audio channel to play back tapes recorded in the 32k mode can be selected with the OUT SELECT button on the wireless remote controller or by setting the AUDIO OUT SEL. item of the AUDIO/VIDEO menu.
- The output level of the playback audio can be selected with the OUT LEVEL button of the wireless remote controller or by setting the AUDIO OUT LEVEL item of the AUDIO/VIDEO menu (NORMAL or ATT).

#### 11 [DV IN/OUT] DV input/output terminal

This is the input/output terminal for digital signals of IEEE1394 standard. It is connected to video devices with DV terminals.

- To input signals from this terminal, please set the [INPUT SEL.] switch on the front panel to "DV".
- Signals from this terminal are output regardless of the INPUT SEL. switch setting.

## NAMES AND FUNCTIONS OF VARIOUS PARTS

## - Wireless remote controller -

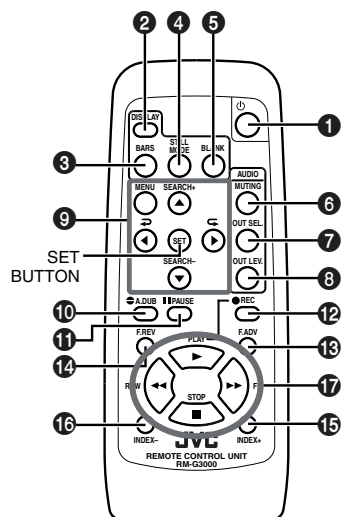

### 1 OPERATE button $\odot$

Press this button to turn on the power of the unit. (OPERATE ON)  
Press this button again to turn off the power. (OPERATE OFF)

### 2 DISPLAY button

Use this button to turn on/off, the on-screen (e.g. status screen) display on the monitor connected to the VIDEO LINE OUT terminal and Y/C OUT terminal. Each time this button is pressed, the display mode changes in the following sequence: ON (always display) → AUTO (display when switching mode) → OFF.  
☞ Page 18, "On-screen display"

### 3 BARS button

When this button is pressed in the Stop or REC-Pause mode, the color bar of the built in signal generator will be output. When it is pressed again, the screen returns to the usual display. During DV signal input, the color bar will not be output.

#### Note

Please do not use it as the standard signal because the signals are simplified.

### 4 STILL MODE button

Use this button to select images in the STILL mode.  
When the unit is in the STILL mode, press this button to toggle images in the following sequence.  
Field image (1st/2nd alternate still) → 1st field image → 2nd field image → frame image

### 5 BLANK button

When the unit enters the STOP mode, press this button to begin a blank search. Once it finds a blank part of the tape, it will enter the STILL mode. ☞ Page 47

### 6 AUDIO MUTING button

During playback, press this button to mute the audio output. Press this button again to re-enable audio output.

### 7 AUDIO OUT SEL. button

When playing back tapes recorded in the 32k mode, use this button to select the audio channel that allows output from the AUDIO OUT terminal.  
CH1/2 → CH3/4 → MIX

### 8 AUDIO OUT LEV button

Use this button to switch the standard level of the playback or EE audio output (NORMAL or ATT). When it is set to ATT, the output level is reduced by 8dB.

### 9 Buttons related to menu setting and variable speed playback

#### ■ MENU button

When the unit enters the STOP mode and this button is pressed, a menu will be displayed on the monitor connected to the VIDEO LINE OUT or Y/C OUT terminal. When the menu is displayed, press this button to return to the usual screen display.

#### ■ SEARCH+ / ▲ button

- During playback, STILL mode or variable speed playback in the forward direction, press this button to speed up playback.
- During reverse playback or variable speed playback in the reverse direction, press this button to slow down the playback speed. (☞ page 46)
- When the menu is displayed, use this button to select the menu items or setting values.

#### ■ SEARCH- / ▼ button

- During playback, STILL mode or variable speed playback in the forward direction, press this button to slow down the playback speed.
- During reverse playback or variable speed playback in the reverse direction, press this button to speed up the playback speed. (☞ page 46)
- When the menu is displayed, use this button to select the menu items or setting values.

#### ■ ⏪ / ▶ button

- During reverse playback/ variable-speed playback, press this button to execute forward playback.
- When the menu is displayed, use this button to display the selected menu items. During date/time or time code setup, press this button to move the cursor to the right.

#### ■ ⏩ / ◀ button

- During forward playback/ variable-speed playback, press this button to execute reverse playback.
- When the menu is displayed, press this button to display the previous menu. During date/time or time code setup, press this button to move the cursor to the left.

#### ■ SET button

During menu display, press this button to confirm the menu items or setting values.

### 10 A. DUB button

Press this button to perform audio dubbing (after-recording). ☞ Page 39, "Audio dubbing"

### 11 PAUSE button

During recording, audio dubbing or playback, press this button to pause recording or enter the STILL mode.  
If this button is pressed in the STOP mode, the STILL mode will be engaged.

### 12 REC button

- Hold down this button and press the PLAY button to begin recording.
- During recording, press this button to record an index on the tape (when the INDEX WRITE item of the SYSTEM menu is set to ON).
- When the unit enters the STOP mode, holding this button down will enable you to check the value of the time code generator.

### 13 F. ADV button

Each time this button is pressed in the STILL mode, the image is advanced one frame. When holding down this button, the image is advanced continuously frame by frame.

### 14 F. REV button

Each time this button is pressed in the STILL mode, the image is reversed one frame. When holding down this button, the image is reversed continuously frame by frame.

#### Memo

The image of frame advance playback or frame reverse playback can be selected with the STL/FADV MODE item of the SYSTEM menu or the STILL MODE button on the wireless remote controller.

### 15 INDEX+ button

Press this button to perform an index search in the forward direction. ☞ Page 47

### 16 INDEX- button

Press this button to perform an index search in the reverse direction. ☞ Page 47

### 17 Operation buttons

#### ■ PLAY (▶) button

- Press this button to play back.
- Press this button to resume recording from the PAUSE mode.

#### ■ FF (▶▶) button

- Press this button to fast-forward the tape when the unit is in the STOP mode.
- Press this button to execute fast-forward playback in the PLAY or STILL mode.

#### ■ REW (◀◀) button

- Press this button to rewind the tape when the unit is in the STOP mode.
- Press this button to execute reverse playback in the PLAY or STILL mode.

#### ■ STOP (■) button

- Press this button to stop the tape.

## ON-SCREEN DISPLAY - Regarding on-screen display -

Besides E-E images and playback images, the monitor connected to the VIDEO LINE OUT terminal and Y/C OUT terminal provides the following on-screen information.

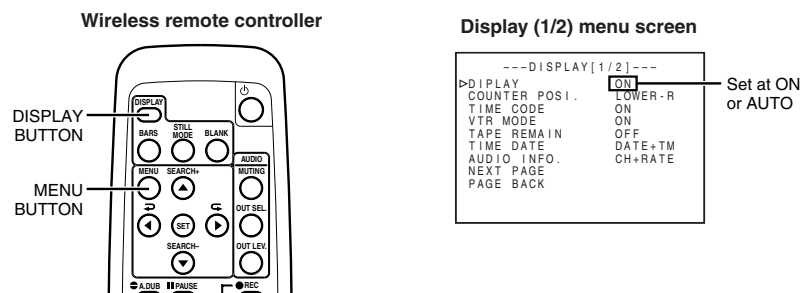

| On-screen display      | Contents  | Method  |
|------------------------|---|---|
| <b>Status display</b>  | It displays the setting status of date/time, time code and VTR operation mode.                                | <p><b>Main unit</b></p> <p>Set the DISPLAY item of the DISPLAY (1/2) menu as follows:</p> <p>ON : Always display. Depending on the items, Event and Alarm displays are shown for about 3 seconds.</p> <p>AUTO : It displays for about 4 seconds after switching between modes.</p> <p>OFF : No on-screen display.</p> |
| <b>Event display</b>   | It displays the operating status of the blank search, index recording/search, or the wireless remote control. |   |
| <b>Alarm display</b>   | It displays alarm messages upon operation errors or if the unit is in a poor state for operation.             | <p><b>Remote controller</b></p> <p>The display can be turned ON/OFF with the DISPLAY button. Each time the DISPLAY button is pressed, the display mode changes in the following sequence: ON (Always display) → AUTO → OFF.</p> <p>*The settings for the DISPLAY menu items will also change accordingly.</p>         |
| <b>Warning display</b> | It displays warning messages with error codes in the event of VTR anomalies. (Page 66)                        | It is displayed automatically when anomalies happen.  |
| <b>Menu display</b>    | It displays the menu setting screen. (Page 53)  | <p><b>Main unit</b></p> <p>If no cassette is loaded and the EJECT button is pressed for at least 2 seconds, the menu will be displayed.</p> <p><b>Remote controller</b></p> <p>If the unit is in the STOP mode and the MENU button is pressed, the menu screen will be displayed.</p>                                 |

## ON-SCREEN DISPLAY - Status display -

■ **Status display:** It displays the current settings and operating status.

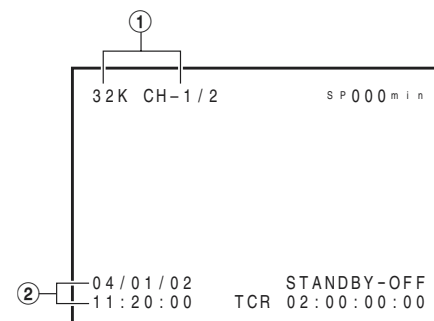

| No. | Item                                      | Content   |
|-----|---|---|
| ①   | <b>Sampling frequency/audio output CH</b> | <ul style="list-style-type: none"> <li>Sampling frequency<br/>During recording, the setting value of the AUDIO MODE item of the AUDIO/VIDEO menu is displayed (32k or 48k).<br/>During playback, the sampling frequency of the sound recorded on the tape is displayed (32k, 48k, 44.1k).<br/>During DV signal input, the sampling frequency of the sound input is displayed.</li> <li>A.LOCK<br/>Lights up when the video and audio sampling clocks (at 48kHz) are synchronized in the PLAY mode. Lights up in the RECORDING mode and EE mode. Does not light up when the sampling rate is 32kHz or 44.1 kHz.</li> <li>Audio output channel<br/>During recording, the audio channel recorded on the tape is displayed.<br/>During playback, the audio channel output from the AUDIO OUT terminal is displayed (CH1/2, CH3/4, MIX). (only in 32k mode)</li> <li>The AUDIO INFO item of the DISPLAY menu can be set to activate/deactivate the display.</li> </ul> |
| ②   | <b>Date/time</b>                          | <ul style="list-style-type: none"> <li>It displays the date (MM/DD/YY) and time (HR:MM:SS).</li> <li>When the unit is in the RECORDING or STOP mode, it displays the data of the built-in clock.</li> <li>During playback, fast forward or rewind, the data recorded on the tape is displayed.</li> <li>During DV signal recording, the data from the DV terminal is displayed. If the REC button is pressed in the STOP mode, the input data from the DV terminal will be displayed.</li> <li>The style for displaying the date and time can be selected from the DATE STYLE and TIME STYLE items of the DISPLAY menu.</li> <li>The TIME/DATE setting of the DISPLAY menu can be set to turn on/off the date and time display or to select the style.</li> <li>When the date/time is not set, "--" will be displayed.<br/>If a tape with no date and time data is played, "--" will be displayed.</li> </ul>   |

## ON-SCREEN DISPLAY - Status display - (continued)

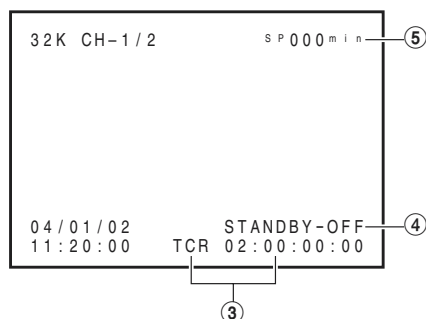

| No. | Item               | Content  |
|-----|--------------------|--|
| ③   | Time code          | <ul style="list-style-type: none"> <li>It displays the time codes (hour, minute, second and frame). During playback, the time codes recorded on the tape are displayed. <ul style="list-style-type: none"> <li>TCR : time code reader data</li> <li>TCG : time code generator data</li> <li>DTCG : time code data input from a DV IN terminal</li> </ul> </li> <li>The symbols for the second and frame differ according to the framing modes. (NTSC only) <ul style="list-style-type: none"> <li>00 : 00 : 00 [00] <ul style="list-style-type: none"> <li>dot (.) is used for a dropped frame.</li> <li>colon (:) is used for a non-dropped frame.</li> </ul> </li> </ul> </li> <li>The time code display position can be set via the COUNTER POSI. item of the DISPLAY menu.</li> <li>The TIME CODE item can be set to turn on/off the time code display.</li> <li>The user's bit is not displayed.</li> </ul> |
| ④   | VTR operation mode | <p>It displays the VTR operation modes, including: PLAY, EJECT, FF, REW, STANDBY-ON, STANDBY-OFF, STILL, REC, REC PAUSE, A. DUB, A. DUB PAUSE, SHTL (shuttle search), JOG (F.ADV, R.ADV), BLANK SRH (blank search), NO CASSETTE (cassette not loaded), OPERATE OFF.</p> <p>When SHTL or JOG is displayed, the speed will also be displayed at the same time.</p> <ul style="list-style-type: none"> <li>The VTR MODE item of the DISPLAY menu can be set to turn on/off the VTR operation mode display.</li> </ul>   |
| ⑤   | Remaining tape     | <p>It displays the remaining tape duration (minutes). If it is not identified, " --- " is displayed.</p> <ul style="list-style-type: none"> <li>The TAPE REMAIN item in the DISPLAY menu can be set to turn on/off the remaining tape duration display.</li> <li>The SP display disappears when the DVCAM cassette is being played back.</li> <li>Please use the remaining tape time as a gauge.</li> </ul>  |

**Memo**  
If the display position of the time code is set to the upper right, this item will be displayed on the lower right

## ON-SCREEN DISPLAY - Event display -

■ **Event display** : When a specific function is in activation or when the operation status is changed with the remote controller, etc, the events will be displayed at the positions shown below.

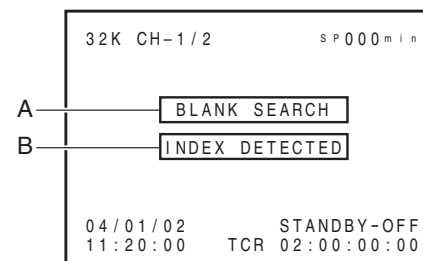

### ■ Display at position A ...Operation in progress

| Display      | Contents  |
|--------------|---|
| BLANK SEARCH | Blank search in progress.   |
| INDEX + 1    | Index search in progress. The number indicates the index search position. |
| INDEX MARK   | When an index is written on the tape during recording.                    |

### ■ Display at position B ...Display for about 3 seconds

| Display            | Contents  |
|--------------------|---|
| INDEX DETECTED     | Index is found during an index repeat operation.        |
| VIDEO END DETECTED | Video end is found during a video end repeat operation. |
| AUDIO MUTING ON    | Audio is muted with the remote controller.              |
| AUDIO MUTING OFF   | Audio is de-muted with the remote controller.           |

| Display              | Contents   |
|----------------------|--|
| AUDIO OUT LEVEL NORM | The standard level of the playback or EE audio level is set to NORMAL or ATT with the remote controller.   |
| AUDIO OUT LEVEL ATT  |  |
| AUDIO OUT CH-1/2     | The playback audio channel is set to CH1/2, CH3/4 or MIX with the remote controller.   |
| AUDIO OUT CH-3/4     |  |
| AUDIO OUT MIX        |  |
| DISPLAY ON           | The on-screen display is turned on with the remote controller.   |
| DISPLAY AUTO         | The on-screen display is set to AUTO with the remote controller. In the AUTO mode, the on-screen display is shown for about 4 seconds between mode switches.   |
| DISPLAY OFF          | The on-screen display is set to OFF with the remote controller.  |
| FIELD STEP           | Field by field advance playback is selected with the remote controller.  |
| 1ST FIELD STILL      | When still or frame advance playback is selected with the remote controller, the type of still image is displayed. <ul style="list-style-type: none"> <li>• 1st FIELD STILL</li> <li>• 2nd FIELD STILL</li> <li>• FRAME STILL</li> </ul> |
| 2ND FIELD STILL      |  |
| FRAME STILL          |  |

## ON-SCREEN DISPLAY - Alarm display -

■ **Alarm display** : Alarm messages are displayed as shown below, when an operation error has occurred or when the unit is in a poor condition for operation. E.g., dirty head.

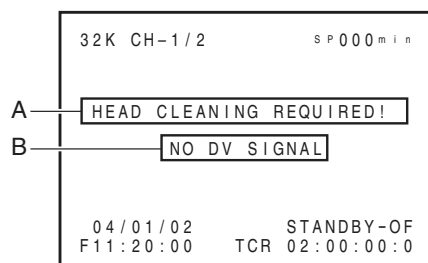

■ **Display at position A** : Displays which show the state of the unit (and which are not set via the DISPLAY mode) continues to be displayed here until the conditions are rectified.

| Display                        | Contents   |
|--------------------------------|--|
| <b>LOW VOLTAGE</b>             | The voltage of the DC input power is low. Continued operation will bring the unit to the Operate OFF mode.   |
| <b>HEAD CLEANING REQUIRED!</b> | The video head is dirty. Please clean it with the dedicated head-cleaning tape. (Page 8)<br>If the head is clogged, it will be detected in the PLAYBACK mode and displayed. When the unit enters the STOP mode or the cassette is ejected, the display goes off. |
| <b>OVERHEATING!</b>            | The temperature inside the unit has exceeded the regulated value. Please disconnect the power and place the unit in a cool place. If this message is displayed again, damage may have occurred. Please consult with your JVC-authorized service agent.           |

■ **Display at position B** : Messages indicating operation errors are displayed for about 3 seconds. They are displayed when the DISPLAY mode is ON or AUTO.

| Display              | Contents   |
|----------------------|--|
| <b>INVALID TAPE!</b> | Data tapes for PC use or DVC PRO tapes has been inserted. The cassette will be ejected.                        |
| <b>LP TAPE!</b>      | The user attempts to play back a tape recorded in the LP mode. This unit cannot record or play in the LP mode. |
| <b>NO DV SIGNAL</b>  | The user attempts to record without DV signal input.   |

For servicing  
The possibility of FAN motor failure

For servicing  
Refer to the servicemanual page. 1-9 "1.8.7 Error Rate Monitor"

| Display                          | Contents   |
|----------------------------------|--|
| <b>COPY INHIBIT</b>              | The user attempts to record signals protected with the copy guard.   |
| <b>REC INHIBIT</b>               | The user attempts to record on a write protected cassette tape. (The rear slide is pushed to SAVE.)  |
| <b>A. DUB INHIBIT (REC TAB)</b>  | The user attempts to perform audio dubbing on a write protected cassette tape. (The rear slide is pushed to SAVE.)   |
| <b>A. DUB INHIBIT (48K)</b>      | This message is displayed when audio dubbing is attempted under the following conditions: <ul style="list-style-type: none"> <li>• The AUDIO MODE item of the AUDIO/VIDEO menu is set to 48k.</li> <li>• The tape is recorded with a sample frequency of 48kHz.</li> </ul> |
| <b>A. DUB INHIBIT (LP)</b>       | The user attempts to perform audio dubbing on a tape recorded in the LP mode.  |
| <b>A. DUB INHIBIT (BLANK)</b>    | The user attempts to perform audio dubbing on a blank tape.  |
| <b>A. DUB INHIBIT (DV)</b>       | The user attempts to perform audio dubbing during DV signal input. (The INPUT SEL switch is set to DV)   |
| <b>A. DUB INHIBIT (NTSC/PAL)</b> | This message is displayed when the signal system is changed during audio dubbing (NTSC or PAL).  |
| <b>A. DUB INHIBIT (DVCAM)</b>    | The user attempts to perform audio dubbing on a DVCAM format tape.   |
| <b>OPERATION LOCK</b>            | This message is displayed when a button on the unit is pressed while the OPERATION LOCK function is engaged (ie, the OPERATION item of the SYSTEM (2/2) menu is set as ON).  |

■ **Warning display** : When anomalies occur in the VTR, warning messages with error codes will be displayed.

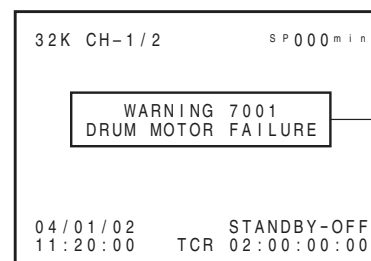

**Warning display**  
For details, please refer to page 66, "Warning Display".



## PREPARATION - Provided wireless remote controller -

### LOADING THE BATTERIES

Before using the wireless remote controller, please load 2 batteries (AA) in.

- 1** Lift up the cover of the battery compartment.
- 2** Load in 2 batteries (AA).  
• Please insert the  $\ominus$  pole in first.
- 3** Close the cover.

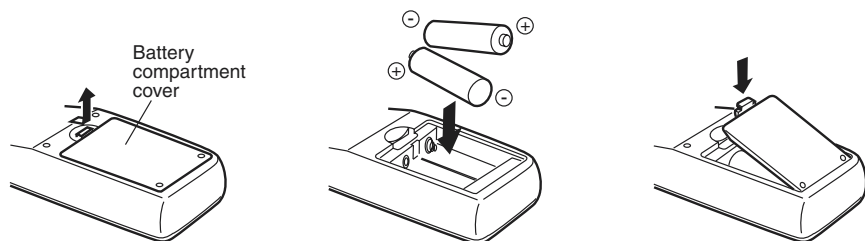

#### Memo

##### Guide on battery replacement.

When the operable distance of the remote controller is decreased, the batteries have become exhausted. Please replace them. Guide for replacement: Approx 3 months based on average usage of 1000 times a day.

##### When replacing the batteries

- Please use AA batteries.
- Please use 2 new batteries. (Do not mix new and old batteries.)
- Please load the batteries correctly according to the  $\oplus$  and  $\ominus$  signs.
- Please read the precautions printed on the batteries.

#### Precautions on the use of battery

- The provided batteries are for confirmation of operation.
- If the remote controller is not to be used for a long period of time, please remove the batteries from the compartment.
- If the remote controller does not work as expected, please remove the batteries and reload them after 5 minutes.

#### Note

If fluid leaks from the battery, please wipe the battery compartment thoroughly. If the fluid comes into contact with your body, please rinse the affected parts with water thoroughly.

#### Gebruikte batterijen:

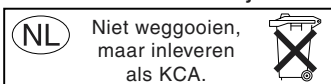

For Netherlands only.  
Uitsluitend voor Nederlands.

E model only

### USING THE WIRELESS REMOTE CONTROLLER

Before using the wireless remote controller, please set the REMOTE SEL. switch to "WIRELESS".

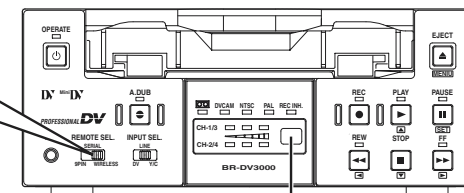

Sensor for the wireless remote controller

#### Caution on using the wireless remote controller

When more than 2 VTRs are being individually operated in the same place, please ensure that the front panel REMOTE SEL. switches of all VTRs except the one to be manipulated, are NOT set at WIRELESS.

#### Operable scope of the wireless remote controller

Sensor for the wireless remote controller

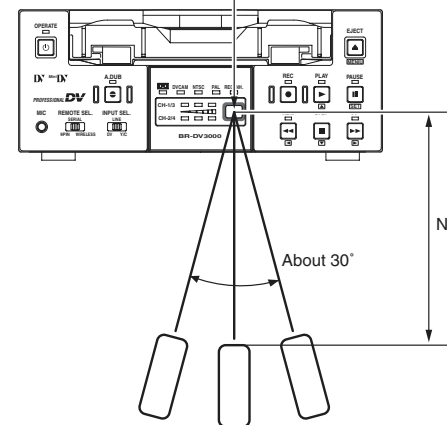

Maximum distance to the sensor of the unit : 6m  
Angle : within 30°

Not further than 6m

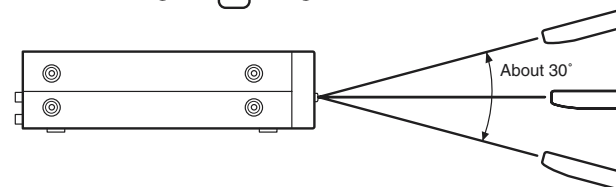

#### Notes

- The remote controller will hardly work if there are obstructive objects between the remote control sensor of the main unit and the remote controller.
- The remote controller will hardly work when sunlight or strong light shines directly on the remote control sensor of the main unit.
- Do not press the buttons on the main unit and the remote controller simultaneously for this may cause malfunction.



## PREPARATION - Power -

### Connecting to the AC adapter

Connect the provided AC adapter to the main unit.

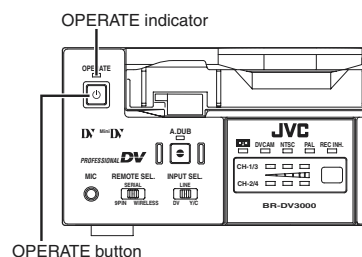
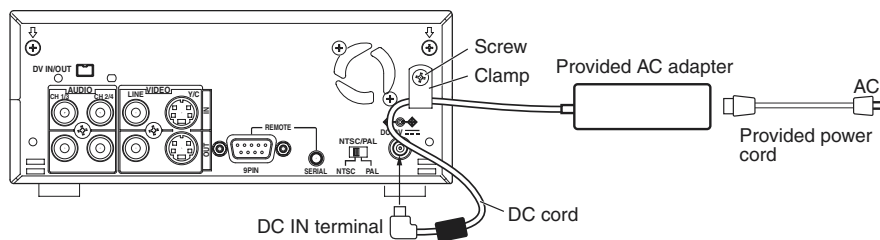

#### Memo

- Even in the OPERATE OFF mode, a small amount of electricity will still flow into the unit.
- When the unit is in the OPERATE OFF mode, no operation can be performed except that of the OPERATE buttons (on the main unit and the remote controller) and cassette loading/ejecting.

#### Notes

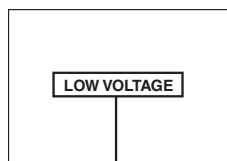

Alarm message

- Please supply power to the unit via the provided AC adapter. Do not use other power sources.
- During recording or playback, please do not unplug the DC or power cord.
- When the supply voltage is low, the "LOW VOLTAGE" alarm message will be displayed. Page 66

**1. Connect the DC cord of the AC adapter to the DC IN terminal of the main unit.**

**2. To prevent accidental disconnection of the DC cord, fasten the DC cord with a clamp.**

- ① Remove 1 screw followed by the clamp.
- ② Insert the DC cord into the clamp and fasten the clamp unto the main unit.

**3. Connect the provided power cord to the AC IN terminal of the AC adapter.**

**4. Connect the power cord to the power socket.**

- Power is channeled into the unit and the OPERATE indicator lights up red (OPERATE OFF mode).
- If the DC IN MODE item of the SYSTEM (2/2) menu is set to OPE ON or PLAY, the OPERATE indicator will light up green (OPERATE ON mode). If it is set to PLAY, the VTR will automatically start to play the loaded tape.

### Switching on the power

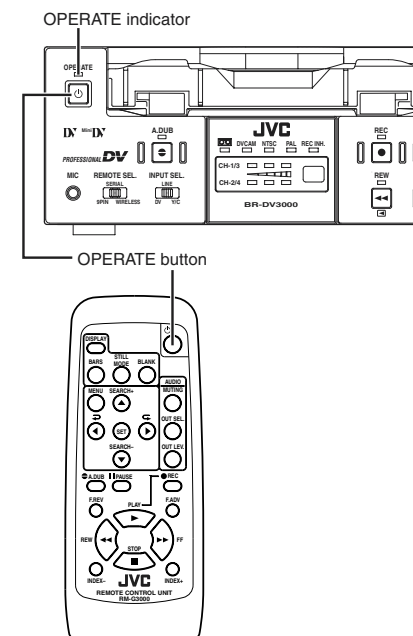

■ **When the unit is in the OPERATE OFF mode (the OPERATE indicator lights up red), press the OPERATE button on the unit or the remote controller.**

- The power is turned on and the OPERATE indicator lights up green. The unit is now ready for operation. (OPERATE ON mode)

#### Memo

- Once a cassette has been loaded in the OPERATE OFF mode, power will be turned on and the OPERATE ON mode will be engaged.
- The remote controller is only effective when the REMOTE SEL. switch is set to WIRELESS.

### Turning off the power

■ **Stop all operational activities of the unit.**

**1. Press the OPERATE button on the unit or the remote controller.**

- The unit will enter the OPERATE OFF mode and the OPERATE indicator will light up red.

**2. If the unit is not to be used for a long period of time, please unplug the AC adapter.**

- To disconnect the AC adapter, please unplug the power cord from the socket first.

## PREPARATION - Selecting the NTSC/PAL signal system -

This unit supports both the NTSC and PAL signal system. Before inputting analogue signals (composite or YC separate video signals), please select the signal system.

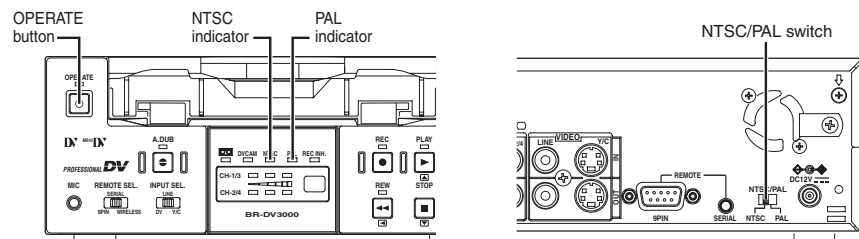

### STEPS

1. Set the unit to the OPERATE OFF mode.
2. Please select the signal system with the NTSC/PAL switch on the rear panel.
3. Press the OPERATE button to engage the OPERATE ON mode. Either the NTSC or PAL indicator on the front will then light up, according to the NTSC/PAL switch setting.

### Memo

- In the playback mode, the signal system of the tape is automatically identified, regardless of the NTSC/PAL switch setting.
- During DV signal input, the signal system of the input signal is automatically identified, regardless of the NTSC/PAL switch setting.
- When the unit enters the STOP mode, the NTSC/PAL switch setting will be engaged.
- If a tape recorded in both NTSC & PAL signal systems is played, the video, audio or time code may be distorted at the position where the signal system is switched.
- When the signal system of the tape and the NTSC/PAL setting differ, video and sound output will be upset for about 5 seconds after playback starts or stops.
- NTSC/PAL signal system conversion is not possible.

## PREPARATION - OPERATION LOCK mode -

This unit comes with an operation lock function to prevent unintended, erroneous operation. In the OPERATE LOCK mode, the buttons on the main unit and the slide switch are invalid. However, OPERATE ON and MENU operations are still possible.

### SYSTEM (2/2) menu

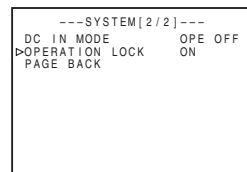

### ■ To set the unit to the OPERATION LOCK mode:

Set the OPERATION LOCK item of the SYSTEM (2/2) menu to ON. Page 54, "Setting the Menu"

- In the OPERATION LOCK mode, when a button on the unit is pressed, "OPERATION LOCK" will be displayed on the monitor for about 3 seconds.

### ■ To turn off the OPERATION LOCK mode:

Set the OPERATE LOCK item of the SYSTEM(2/2) menu to OFF.

If the EJECT button is pressed while the VTR is in the OPERATE LOCK mode, "OPERATION LOCK" will be displayed. However, pressing the EJECT mode button persistently will eventually bring on the MENU screen.

OPERATION LOCK

## PREPARATION - Loading/ejecting cassettes -

Please use standard DV cassettes or mini DV cassettes.

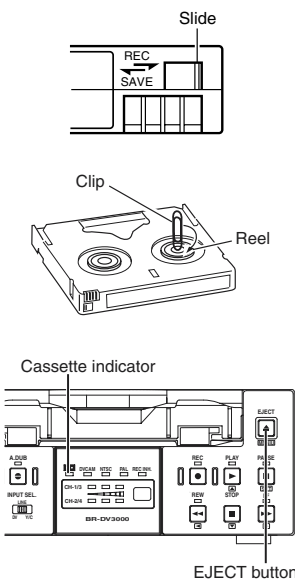
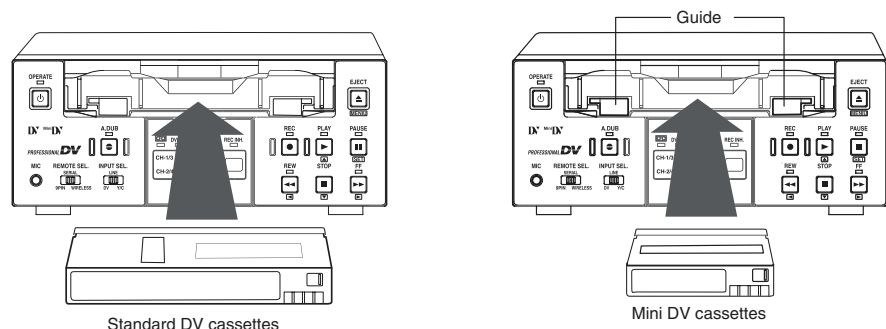

### Loading the cassette

#### 1. Check the cassette.

- Set the rear slide. Push it to "REC" for recording or "SAVE" to prevent its contents from being erased accidentally.
- Check that the tape is not slackened. Use an object, such as a clip, to turn the reel in the direction of the arrow. If the tape is taut, the reel will not rotate.

#### 2. Check that the cassette indicator on the unit is unlit. When a cassette is loaded, the cassette indicator will lit up.

#### 3. Load the cassette.

- For the standard DV cassette, just align it with the cassette slot and insert.
- For the mini DV cassette, load it in between the left and right guides. Set the tape, window face up, and push the cassette in slowly until it is drawn in automatically.
  - While the cassette is being loaded, the cassette indicator blinks. The indicator lights up when cassette loading is complete.

### Ejecting the cassette

#### 1. Press the EJECT button on the unit.

- Ejection begins. During ejection, the cassette indicator blinks.

#### 2. Eject the cassette.

#### Memo

- The cassette can be loaded/ejected even when the unit is in the OPERATE OFF mode.
- The loading/ejection process takes about 6 seconds.
- Ejection cannot be done with the wireless remote controller.

## PREPARATION - Setting/displaying date and time -

This function sets up the date and time data of the built-in clock. With the built-in chargeable battery, the configured date and time data is maintained even after the main power is turned off. The data will be displayed on the monitor according to the menu setting. During tape recording, the time and date data is registered.

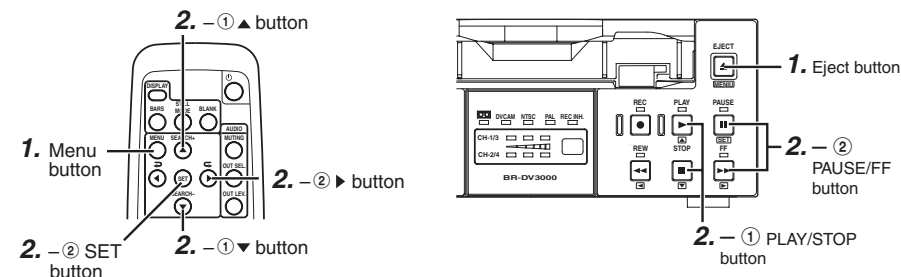

### Setting the date and time

The date and time data is set up via the CLOCK ADJUST menu. Setting can be performed while viewing the monitor screen connected to the VIDEO LINE OUT or Y/C OUT terminal.

- The date and time can be set up using either the remote controller or the unit.

#### ■ Press the OPERATE button on the unit or the remote controller to turn on the power and enter the STOP mode.

\* When setting it using the main unit, eject the loaded cassette, if any.

#### 1. Displaying the TOP MENU.

##### Remote controller

Press the MENU button.

##### Main unit

Press the EJECT button for at least 2 seconds.

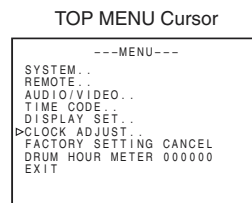

#### CLOCK ADJUST menu

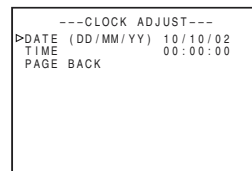

#### 2. Displaying the CLOCK ADJUST menu.

##### Remote controller

- ① Press the ▲ or ▼ button and bring the cursor to the CLOCK ADJUST item.
- ② Press the SET or ► button.

##### Main unit

- ① Press the PLAY or STOP button and bring the cursor to the CLOCK ADJUST item.
- ② Press the PAUSE or FF button.

## PREPARATION - Setting/displaying date and time - (continued)

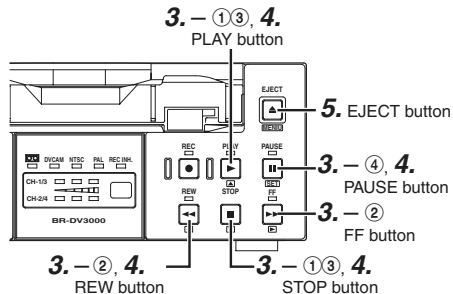
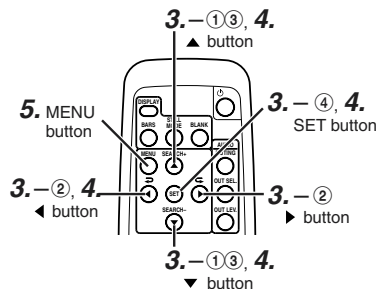

### 3. Set the date or time on the CLOCK ADJUST menu.

#### Remote controller

- Press the ▲ or ▼ button and bring the cursor to the date or time setting. Then press the ► or SET button.
- Press the ► or ◀ button and select the data segment to set up.
  - The selected data segment blinks.
- Press the ▲ or ▼ to set the value.
- Repeat step ① - ③. After completing the necessary settings, press the SET button.

#### Main unit

- Press the PLAY or STOP button and bring the cursor to the DATE or TIME setting. Then press the FF or PAUSE button.
- Press the FF or REW button and select the data segment to be set up.
  - The selected value blinks.
- Press the PLAY or STOP button to set the value.
- Repeat step ① - ③. After completing the necessary settings, press the PAUSE button.

#### Memo

The 'seconds' segment cannot be set up. After the 'minute' segment is set up, please press the SET button (remote controller) or the PAUSE button (main unit) in synchronization with a separate time indicator (clock).

### 4. To return to the TOP MENU after completing all settings, do the following:

#### Remote controller

- Press the ◀ button.
- Or
- Press the ▲ or ▼ button to bring the cursor to PAGE BACK and then press the SET button.

#### Main unit

- Press the REW button.
- Or
- Press the PLAY or STOP button to bring the cursor to PAGE BACK and then press the PAUSE button.

### 5. To return to the usual menu, do the following:

#### Remote controller

- Press the MENU button
- Or
- Bring the cursor to the EXIT item of the TOP MENU and press the SET button.

#### Main unit

- Press the EJECT button.
- Or
- Bring the cursor to the EXIT item of the TOP MENU and press the PAUSE button.

## SELECTING DATE/TIME DISPLAY

The date and time data is displayed on the monitor screen connected to the VIDEO LINE OUT terminal and Y/C OUT terminal. Setup can be performed via the DISPLAY (1/2) menu to turn on/off the date & time display and via the DISPLAY (2/2) menu to determine the display style. (For details on setup method: Page 54)

### SETTING

#### 1. Select DISPLAY SET item from the TOP MENU and display the DISPLAY (1/2) menu.

#### 2. Set the TIME/DATE setting on the DISPLAY (1/2) menu.

##### ■ TIME DATE

- OFF : Does not display date or time.
- TIME : Displays time only.
- DATE : Displays date only.
- DATE + TM : Displays both the time and date.

#### 3. Select the NEXT PAGE item of the DISPLAY (1/2) menu to engage the DISPLAY (2/2) menu.

#### 4. Set the DATE STYLE and TIME STYLE items of the DISPLAY (2/2) menu.

##### ■ DATE STYLE... Set the order of the date display.

- YY/MM/DD: Year / month / day
- MM/DD/YY: Month / day / year
- DD/MM/YY: Day / month / year

##### ■ TIME STYLE... Select the style of time display.

- 24H: 24-hour time mode
- 12H: 12-hour time mode

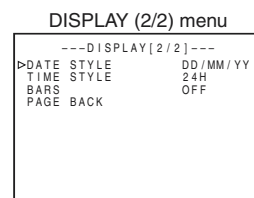
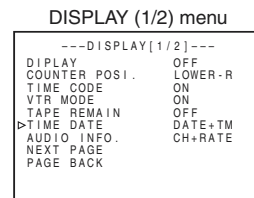
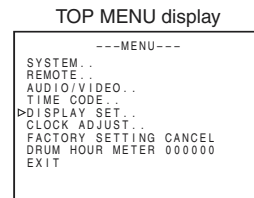

DISPLAY button

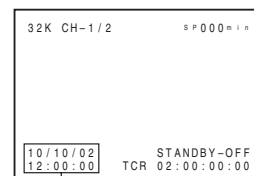

Date/time display

### Enabling on-screen display:

#### Remote controller

- Press the DISPLAY button.

#### Main unit

- Set the DISPLAY item of the DISPLAY (1/2) menu to ON or AUTO.

#### Memo

- RECORDING or STOP mode : Data in the built-in clock is displayed.
- During Playback : The date/time recorded on the tape is displayed.
- During DV signal recording : The date/time data from the DV terminal is displayed.

## RECORDING - Connection and setting -

This chapter explains the connection, setting and operation methods required to use this unit as a recorder.

This unit cannot be used as an editing system recorder.

### Connection

#### When connected to a video device equipped with a DV terminal

Images can be recorded with almost no deterioration of image quality.

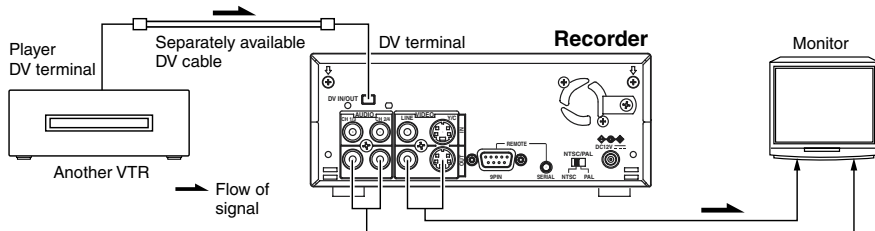

#### Memo

- When signals are input from the DV terminal, the sound recording mode of the recorder is the same as that of the player.
- The Date and time data from the DV terminal will be recorded.
- To record the time code data from the DV terminal, set the TC DUPLICATE item of the TIME CODE menu to AUTO or NON DROP. (Page 62)
- For the BR-DV600 player, when the mode is changed from STILL to PLAY, the audio output will be muted for a while shortly after coming on. Thereafter, it will resume as per normal. (This does not occur with BR-DV600A.)
- When it is connected to D9VTR (equipped with SA-DV60), exchanging of the date/time information is not possible.

#### This unit is connected to a video device with no DV terminal (analogue input):

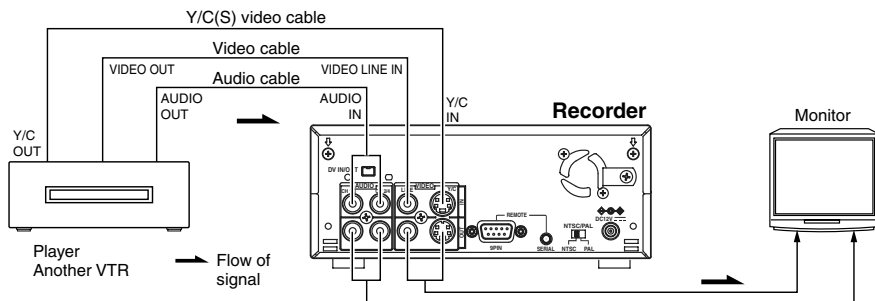

#### Memo

When search pictures or low-quality video signals are input, video and sound output may be temporarily distorted. Please input stable signals via a TBC, etc..

### Setting

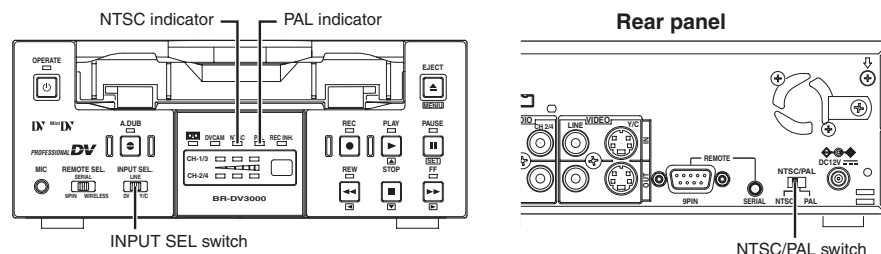

#### Memo

- For DV signal input, the signal system (NTSC/PAL) is identified automatically.
- For DV signal input, the AUDIO MODE item cannot be set. It will be the same mode as that of the input signal (48k or 32k).

#### Setting the signal system (NTSC/PAL)

The signal system for analogue input is set with the NTSC/PAL switch located at the rear panel. Either the NTSC or the PAL indicator on the front lights up, depending on the setting.

\* Before setting the NTSC/PAL switch, please set the unit to the OPERATE OFF mode.

#### Selecting the video input signal

Please use the INPUT SEL. switch on the front panel.

Y/C : Input Y/C separate video signals.

LINE : Input composite video signals.

DV : Input DV signals.

#### Setting the AUDIO/VIDEO menu (Page 61)

##### AUDIO MODE

Use this menu item to set the audio sampling frequency for recording.

32k : Perform recording with an audio sampling frequency of 32kHz. Use this setting when performing audio dubbing on CH3 and CH4.

48k : Perform recording with an audio sampling frequency of 48kHz. Audio dubbing is not available.

##### SET UP (NTSC only)

Set this item to enable/disable setup to composite signals or Y/C separate video during recording.

#### Setting the SYSTEM menu (Page 57)

##### LONG PAUSE TIME

Sets the time period, after the lapse of which the unit will enter the tape protection mode when pause is activated for an extended period of time.

##### INDEX WRITE

This setting turns on/off automatic recording of index signals when recording begins.

#### Setting the time code recording during DV signal input

Set the TC DUPLICATE item of the TIME CODE menu to determine whether to use the time code from the built in time code generator and clock or the data from the DV terminal.

(Page 62)

#### AUDIO/VIDEO menu

```

---AUDIO VIDEO---
>AUDIO MODE          48K
A OUT AT SEARCH     ON
AUDIO OUT SEL       CH-1/2
AUDIO OUT LEVEL     NORM
SET UP (NTSC)       OFF
PAGE BACK
    
```

#### System (1/2) menu

```

---SYSTEM[1/2]---
STL/F ADV           2ND
BACKUP REC TIME    OFF
>LONG PAUSE TIME   5MIN
LONG PAUSE MODE    F.ADV
INDEX WRITE        ON
REPEAT MODE        BLANK
NEXT PAGE
PAGE BACK
    
```

## RECORDING - Setting time codes -

### Time code recording

This unit has a built-in time code reader/ generator. It records time codes during recording. It does not record the user's bit.

Time codes are recorded according to the recording condition as follows:

Time codes are recorded in the REC RUN mode. (REC RUN: time codes run only during recording.)

| Condition                                  | Time code recording  |
|--|--|
| <b>Time code is preset with this unit.</b> | <ul style="list-style-type: none"> <li>Time codes preset in the built-in time code generator are recorded. (First time only)</li> <li>When recording ends, the set time codes becomes void and regeneration occurs.</li> </ul> <p>— Memo —</p> <p>The framing mode is selected from the NDF/DF item of the TIME CODE menu. (NTSC only)</p> |
| <b>Time code is not preset.</b>            | <ul style="list-style-type: none"> <li>It reads the time codes recorded on the tape and continues recording time codes from these values. (Regeneration)</li> <li>If no time code is recorded, it starts from "00".</li> </ul> <p>* Sometimes, the time codes recorded at the beginning of the tape may not be read.</p>                   |

### Preset time codes.

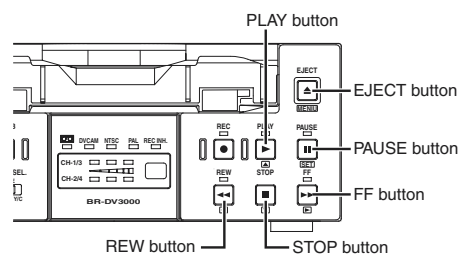
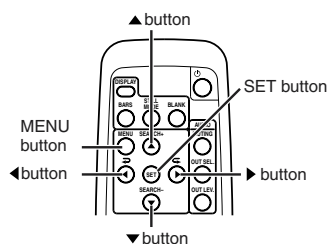

#### Memo

When the REC button is held down in the STOP mode, the value of the built-in time code generator is displayed.

Time codes are preset via the TIME CODE menu. It can be set via either the remote controller or the Main unit.

- Press the OPERATE button on the Main unit or the remote controller to turn on the power and set the unit to the STOP mode.

\* To set it with the main unit, first remove the cassette from the unit if it is loaded.

#### TOP MENU

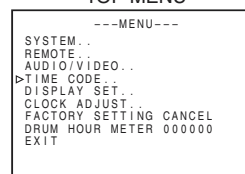

#### TIME CODE MENU

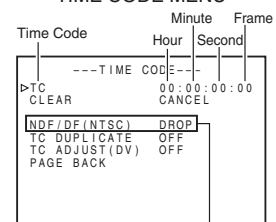

Framing mode (NTSC only)

#### Resetting the time code to zero:

- Select the CLEAR menu item.
- Set the value to EXECUTE and press the SET button (remote controller) or the PAUSE button (Main unit).

#### Memo

Framing mode (NTSC only)  
**DROP**

: Time codes that match the actual time.

**NON DROP**

: Use this setting if the number of frames is important.

### 1. Display the TOP MENU.

**Remote controller**

Press the MENU button.

**Main unit**

Press the EJECT button for at least 2 seconds.

### 2. Display the TIME CODE menu.

**Remote controller**

Select the TIME CODE item with the ▲/▼ button and press the SET or ► button.

**Main unit**

Select the TIME CODE item with the PLAY/STOP button and press the PAUSE or FF button.

### 3. Preset the time code (hour, minute, second and frame).

**Remote controller**

- Select the TC item with the ▲/▼ button and press the SET or ► button.  
→ The hour digits blink.
- Press the ►/◄ button to shift to the next digit segment.
- Press the ▲/▼ button to change the value of the blinking digits.
- Repeat steps ② and ③ above and set all the values. Press the SET button.

**Main unit**

- Select the TIME CODE item with the PLAY/STOP button and press the PAUSE or FF button.
- Press the FF or REW button to shift to the next digit segment
- Press the PLAY/STOP button to change the value of the blinking digits.
- Repeat ② and ③ steps above and set all the values. Press the PAUSE button.

### 4. Set the framing mode (NON DROP / DROP) ... (NTSC only)

**Remote controller**

- Select the NDF/DF item with the ▲/▼ button and press the SET or ► button.
- Press the ▲/▼ button to select the value.
- Press the SET button to confirm the setting value.

**Main unit**

- Select the NDF/DF item with the PLAY/STOP button and press the SET or FF button.
- Press the PLAY/STOP button to select the value.
- Press the PAUSE button to confirm the setting.

### 5. Return to the usual screen.

**Remote controller**

Press the MENU button.

**Main unit**

Press the EJECT button.

### Recording time codes of a DV input terminal:

- Set the TC DUPLICATE item of the TIME CODE menu to AUTO.
- To record time codes in the non-drop frame mode from BR-DV600, GY-DV500 or GY-DV700W, set the TC DUPLICATE setting to NON DROP.

#### Memo

If the REC button is held down in the STOP mode when the TC DUPLICATE item is set to AUTO or NON DROP, the EE signals of the time codes from the DV input terminal can be checked.



## RECORDING - Recording method -

### Remote controller

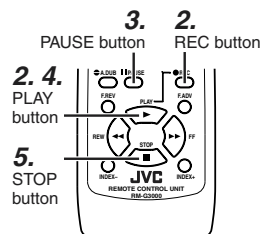

### Main unit

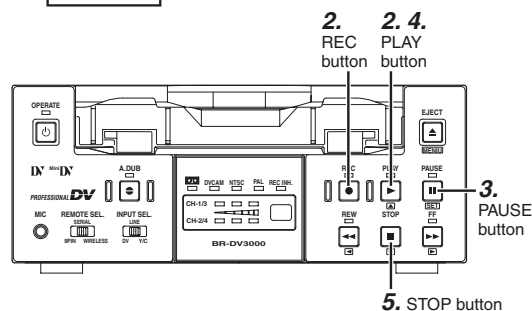

### Memo

- If recording has been paused for an extended period of time, the unit will automatically go into the STOP mode to protect the tape. The time period after the lapse of which the unit will enter the STOP mode can be configured via the LONG PAUSE TIME item of the SYSTEM (1/2) menu.
- This unit cannot perform editing functions.

### 1. Load the cassette.

- Before loading the cassette, please check that the rear slide of the cassette is pushed to REC.

→ The Main unit is powered on.

### 2. Start recording.

- Hold down the REC button and press the PLAY button.

### 3. Pause recording.

- Press the PAUSE button.

### 4. Resume recording.

- Press the PLAY button.

### 5. Stop recording.

- Press the STOP button.

## Recording index signals

When the INDEX WRITE item of the SYSTEM (1/2) menu is set as ON, an index signal is recorded at the starting position of recording.

In the PLAYBACK mode, the position where the index signal is recorded can be detected. (Index search)

### ■ During recording, please press the REC button to record the index signal.

\* Please allow at least an interval of 1 minute between recording of index signals.

Recording of index signals after tape recording is not possible.

## RECORDING - Audio dubbing -

For tapes recorded in the 32kHz audio mode, audio dubbing can be performed on the CH3 and CH4 channel after the recording. (After-recording)

### Notes

- For tapes recorded in the 48kHz audio mode, audio dubbing cannot be performed.
- Audio dubbing cannot be performed for DV input signals.

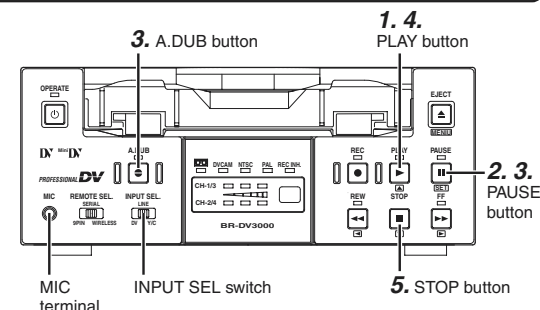
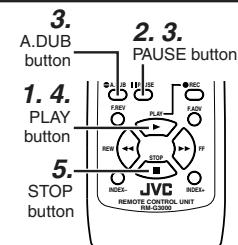

### Connection

Audio dubbing sounds are input from the AUDIO IN terminal on the rear panel or the MIC terminal on the front panel. MIC terminal prevail over the AUDIO IN terminal.

### Setting

- Set the AUDIO item of the AUDIO/VIDEO menu to 32k.
- Do not set the INPUT SEL switch on the front panel to DV.

### Operation

#### 1. Press the PLAY button to play the tape.

#### 2. At the position where you want to audio dub, press the PAUSE button.

→ The unit goes into the STILL mode.

#### 3. Hold down the PAUSE button and press the A.DUB button.

→ The unit goes into the audio dubbing pause mode.

#### 4. Press the PLAY button.

→ Audio dubbing begins. Audio signals are recorded on the CH3 and CH4 channel.

### ■ To stop audio dubbing temporarily, press the PAUSE button.

### 5. To end audio dubbing, press the STOP button.

### Memo

- During audio dubbing, if the tape comes to a part recorded in a non dubbing-feasible mode (such as LP mode or 48kHz audio mode), the VTR will enter the STOP mode. When this happens, high-volume noise from the DV output will occur. Hence, before audio-dubbing, please check the recording mode of the tape.
- In the case that a microphone is connected to the MIC terminal, sound output from this terminal will be recorded. In the absence of MIC input, signals from the CH1/3, CH2/4 AUDIO IN terminal on the rear panel will be recorded.
- When audio dubbing cannot be performed, an alarm message will be displayed on the monitor. (Page 23)
- Audio dubbing PAUSE cannot be executed directly in the STOP mode. Please execute it in the STILL mode.

During audio dubbing pause, sound from the CH3/CH4 channel is output via the monitor but sound output from the DV terminal is not possible.

- If audio dubbing is repeated on a short section of the tape, noise may occur for an instant when the section is played.
- During audio dubbing, noise may be produced on the playback video or EE sound but the recording is normal.
- The playback sound of CH1/2 cannot be recorded on CH3/4 (sound on sound).
- During backspace operation of audio dubbing, audio dubbing cannot be performed on unrecorded parts.
- When audio dubbing is performed on tapes recorded on other devices, it may not record correctly. Please record with this unit before performing audio dubbing.

## RECORDING - Backup recording function -

By linking this unit to other DV devices, this unit can perform continuous, long-hour recording. This unit can be set as a backup unit connected to a DV camcorder (GY-DV300/DV500/DV550/DV5000, etc.). When the recording tape of the source unit ends, this unit can start recording. This enables long-hour recording.

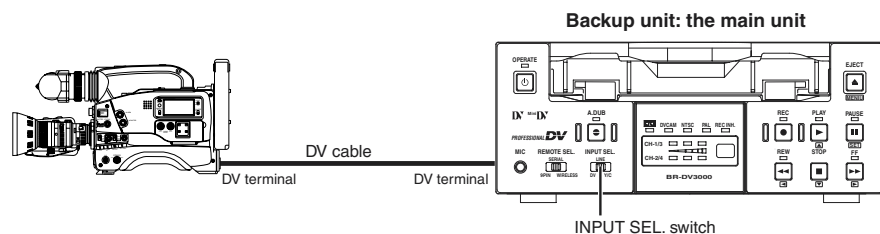

### Connection

Connect the DV terminal of the source unit to the DV terminal of this unit with a DV cable.

### Setting up this unit

- Set the **INPUT SEL.** switch on the front panel to **DV**.

- Set the **BACKUP REC TIME** item of the **SYSTEM (1/2)** menu.

Use the following settings according to the length of the tape of the source unit.

For DV or mini DV cassettes:

|        |                       |
|--------|-----------------------|
| 25MIN  | : 30-minute tape      |
| 55MIN  | : 60-minute tape      |
| 75MIN  | : 80-minute tape      |
| 115MIN | : 120-minute tape     |
| 175MIN | : 180-minute tape     |
| 265MIN | : 270-minute tape     |
| OFF    | : No backup recording |

- Set the **TC DUPLICATE** item of the **TIME CODE** menu to **OFF**.

- It records the data of the built-in time code generator or the built-in clock.
- When the **TC DUPLICATE** menu item is set to **AUTO** or **NON DROP**, the time code of the DV camcorder will stop advancing. If the DV cable is disconnected, the time code of the backup recording will stop advancing.

### Operation

- Recording begins on the source unit.**  
\* Please record from the beginning of the recording tape.
- This unit begins recording when the tape of the source unit is near the end (about 5 minutes before the end of the tape).**

- This unit begins recording when the recording time of the source unit reaches the time configured by the **BACKUP REC TIME** setting.

#### Memo

- Backup recording records the video and sound from the source unit to the main unit. While this unit is performing backup recording, please continue shooting from the source unit.
- The audio mode is the mode configured in the source unit. (32k/48k)
- Please set the **BACKUP REC TIME** item to **OFF** if the unit is not performing backup recording.

## RECORDING - Recording using the serial remote terminal -

Recording can be turned ON/OFF with the serial remote controller or the footswitch connected to the SERIAL REMOTE terminal on the rear panel.

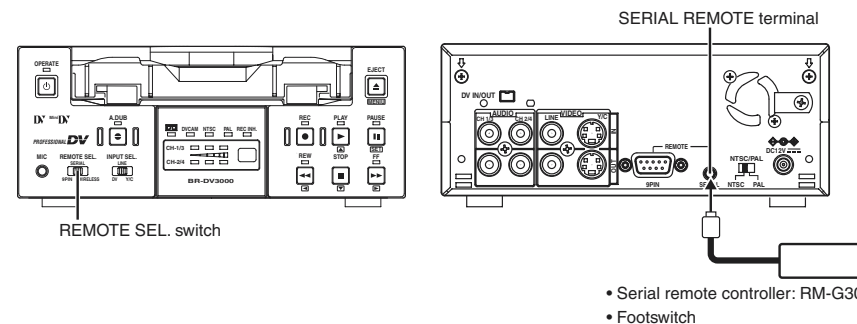

- Serial remote controller: RM-G30
- Footswitch

### Connection

Connect the serial remote controller (available separately; RM-G30) or the footswitch to the SERIAL REMOTE terminal on the rear panel.

### Setting

- Set the **REMOTE SEL.** switch on the front panel to **SERIAL**.

- Set the **REMOTE** item of the **REMOTE (1/2)** menu to **ON**.

- Set the **FOOT SW** item of the **REMOTE (2/2)** menu according to the way in which the serial remote terminal is used.

|         |  |
|---------|--|
| OFF     | : Set to OFF when the serial remote controller is used. The footswitch cannot be used.             |
| L EDGE  | : Recording and recording pause operations are switched at the LOW edge of the footswitch signal.  |
| H EDGE  | : Recording and recording pause operations are switched at the HIGH edge of the footswitch signal. |
| L LEVEL | : Record at the LOW edge and pause recording at the HIGH edge of the footswitch signal.            |

### Operation

Before using the footswitch, first engage the recording or recording pause mode via the buttons on the main unit.

#### Memo

- The footswitch can only be used for switching the recording operation ON/OFF.
- The footswitch functions irrespectively of the REMOTE SEL switch settings.

#### REMOTE (1/2) menu

```

---REMOTE[1/2]---
>REMOTE                ON
LOCAL FUNCTION         ALL KEYS
PREROLL                SS
REM FF/REW MODE        FF/REW
REM STOP SEL           EE
PB START DELAY         OF
SYNCHRONIZATION       ON
NEXT PAGE
PAGE BACK
    
```

#### Memo

- The serial remote controller can perform operations other than recording.
- The buttons on the unit to be rendered operable can be set via the **LOCAL FUNCTION** item of the **REMOTE(1/2)** menu.

#### REMOTE (2/2) menu

```

---REMOTE[2/2]---
CONTROLLER SEL TYPE1
>FOOT SW                OFF
PAGE BACK
    
```

## PLAYBACK - Connection/setting -

This section explains the required connection, setting and operation method for using this unit as a player.

### Connection

#### Using this unit as a standalone device

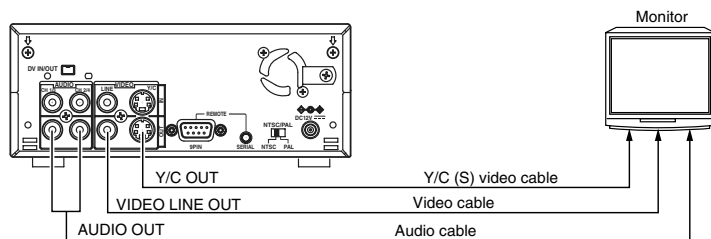

#### Connecting this unit to a video device with a DV terminal

It can record with almost no loss in image or sound quality.

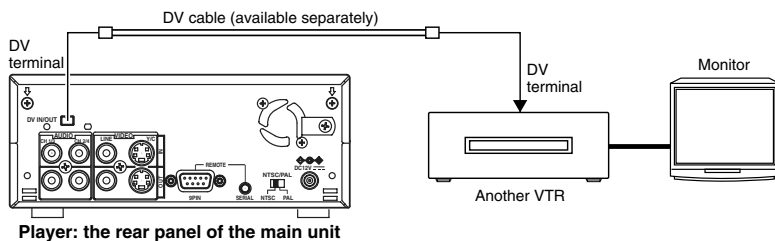

#### Memo

- If the recorder is a GY-DV500 or GY-DV700W, and BR-DV3000 is put to PLAY from the STOP mode, the phase of the EE audio output from the camcorder will be displaced. There is no problem with the recorded signals.
- For GY-DV300E, GY-DV500E and GY-DV700W, DV input is not possible. **( E model only )**

#### Connecting this unit to a video device with no DV terminal (analogue signal):

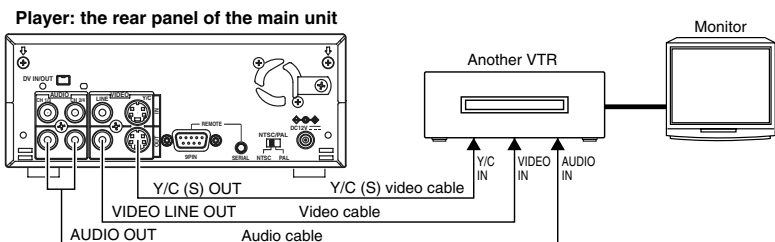

### Setting

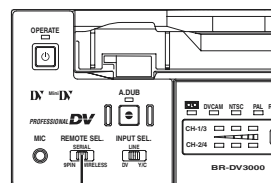

REMOTE SEL. switch

#### REMOTE SEL. switch on the front panel

To use the wireless remote controller, set the switch to WIRELESS.

#### Memo

To control the unit with the 9 PIN REMOTE or the SERIAL REMOTE terminal, set the REMOTE menu item to ON.

#### SYSTEM menu

##### STL/F.ADV MODE

Use this to select the image type for still image playback or frame advance playback.

(Field image, 1st field image, 2nd field image and frame image)

**Note:** Still images can also be selected with the STILL MODE button of the wireless remote controller.

##### LONG PAUSE TIME

Use this menu item to set the time interval, after the lapse of which, the unit will go into the tape protection mode. (5, 3, 2 or 1 minute, 30 seconds)

##### LONG PAUSE MODE

Use this mode to select the operation state when tape protection mode is engaged after an extended period of being in the STILL mode. (F.ADV or STBY-OFF)

##### REPEAT MODE

Use this menu item to turn ON/OFF the REPEAT PLAYBACK function or select the type of REPEAT PLAYBACK. To disable REPEAT PLAYBACK, set it to OFF. (OFF, INDEX, VIDEO END, TAPE END)

#### SYSTEM (1/2) Menu

```

---SYSTEM[1/2]---
▶STL/F.ADV          2ND
BACKUP REC TIME   OFF
LONG PAUSE TIME   5MIN
LONG PAUSE MODE   F.ADV
INDEX WRITE       ON
REPEAT MODE       BLANK
NEXT PAGE
PAGE BACK
    
```

#### AUDIO/VIDEO Menu

```

---AUDIO VIDEO---
AUDIO MODE         48K
▶A OUT AT SEARCH  ON
AUDIO OUT SEL     CH-1/2
AUDIO OUT LEVEL   NORM
SET UP (NTSC)    OFF
PAGE BACK
    
```

#### AUDIO/VIDEO menu

##### A. OUT AT SEARCH

Use this menu item to turn ON/OFF audio output during variable speed playback.

##### AUDIO OUT SEL

Use this menu item to select the output audio channel when playing tapes recorded in the 32kHz mode. (CH1/2, CH3/4, MIX)

##### AUDIO OUT LEVEL

Use this menu item to select the audio output level (NORM, ATT). Set it to ATT when playing tapes recorded at -12dB with consumer DV devices.

##### SETUP (NTSC only)

Use this setting to determine whether to apply the setups to the composite video or Y/C separate video output signals.

#### Memo

AUDIO OUT SEL or AUDIO OUT LEVEL items can also be set via the AUDIO OUT SEL or AUDIO OUT LEV button on the wireless remote controller.

## PLAYBACK - Basic playback method -

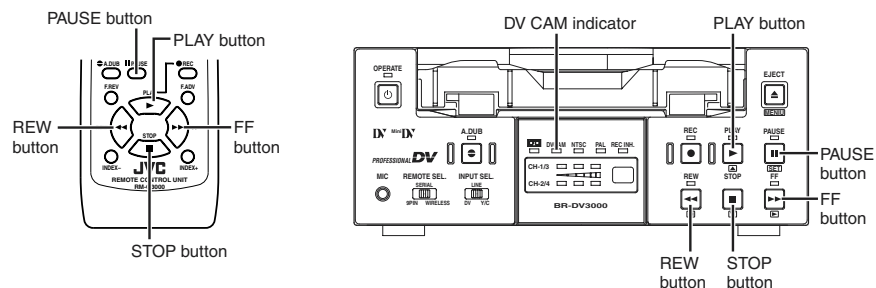

### Note

Tapes recorded in the LP mode cannot be played back. The monitor will display the alarm message: "LP TAPE!"

### Memo

When output of still image continues for a prolonged period, the unit will automatically go into the tape protection mode. The lapse time can be selected from the LONG PAUSE TIME item of the SYSTEM menu.

### 1. Load a recorded tape.

→ The unit is powered on.

### 2. Start playback.

Press the PLAY button.

→ Start playback. If the tape is recorded in the DVCAM format, the DVCAM indicator will light up.

### 3. Pause

Press the PAUSE button.

→ A still image is output.

### ■ To change the still image type

#### Remote controller

Press the STILL MODE button. The still image changes as follows each time the button is pressed.

Field image → 1st Field image → 2nd Field image → Frame image

### 4. Resume playback.

Press the PLAY button.

### 5. Stop playback.

Press the STOP button.

#### Fast forward/rewind

■ When the unit is in the STOP mode, pressing the FF button will fast-forward the tape.

■ When the unit is in the STOP mode, pressing the REW button will rewind the tape.

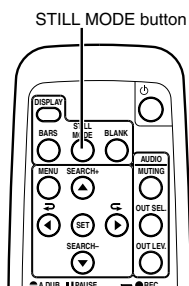

## PLAYBACK - Special playback function -

### Frame advance (reverse) playback

Use the remote controller.

#### Setting

#### ■ The STL/F. ADV MODE item of the SYSTEM menu

Select the amount of frame advance playback and still image.

**FIELD** : Image is advanced field by field. (1st /2nd alternate)  
**1st FIELD** : Image is advanced frame by frame and the 1st field image is displayed.

**2nd FIELD** : Image is advanced frame by frame, and 2nd field image is displayed.

**FRAME** : Image is advanced frame by frame, and frame image is displayed.

#### Operation

#### 1. Set the unit to the STILL mode.

#### 2. Frame advance in the forward direction.

Press the F. ADV button.

When the F. ADV button is held down, the image will advance continuously in the forward direction.

#### ■ Frame reverse in the reverse direction.

Press the F. REV button.

When the F. REV button is held down, the image will reverse continuously in the reverse direction.

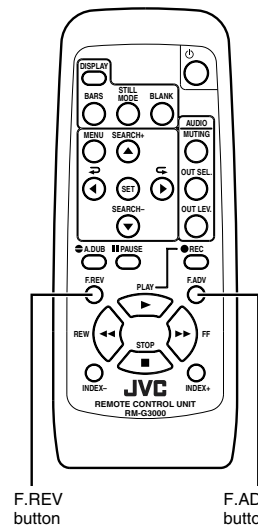

### Memo

When pressing the PAUSE button on the main unit in the STILL mode, the image is advanced frame-by-frame.

## PLAYBACK - Special playback - (continued)

### Variable speed playback

Use the remote controller.

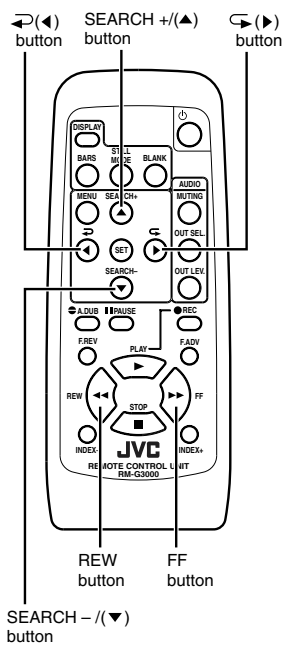

#### Memo

- The A. OUT AT SEARCH item of the AUDIO/VIDEO menu can be set to turn on/off audio output during the search mode.
- If 0.1 X speed playback (step slow) has been continued for about 40 seconds, the unit will automatically change to the 0.2 X speed playback (linear slow) in order to protect the tape.

### Set the unit to the search mode.

The main unit button can also be used to set the unit to the search mode.

1. Set the unit to the **PLAYBACK** or the **STILL** mode.
2. Press the **FF** button to execute fast-forward playback. Press the **REW** button to execute reverse playback.

■ The search speed changes according to the following sequence each time the **FF** or **REW** button is pressed:

X20 → X5 → X9 → X20

In DVCAM mode, the maximum speed is 15X.

### Changing the speed of fast-forward playback or reverse playback:

■ **During normal playback or forward search:**

If the **SEARCH + (▲)** buttons are pressed, the playback speed increases.

If the **SEARCH - (▼)** buttons are pressed, the playback speed decreases.

■ **During reverse playback or reverse search:**

If the **SEARCH + (▲)** buttons are pressed, the playback speed decreases.

If the **SEARCH - (▼)** buttons are pressed, the playback speed increases.

The variable playback speed changes as follows in the forward and reverse direction.

0 → 0.1 → 0.33 → 0.5 → 1 → 2 → 5 → 9 → 20X speed (Still)

\* 0.1 X speed indicates step slow playback (continuous frame advance).

■ **During the STILL mode:**

If the **SEARCH + (▲)** buttons are pressed, the tape will play in the forward direction.

If the **SEARCH - (▼)** buttons are pressed, the tape will play in the reverse direction.

### Changing the direction of playback

■ **To change from normal or fast-forward playback to reverse playback:**

- Press the **↶ (◀)** button.

If this button is pressed during playback, reverse playback will be engaged.

■ **To change from reverse or rewind playback to forward playback:**

- Press the **↷ (▶)** button.

If this button is pressed during reverse playback, normal playback will be engaged.

If this button is pressed during rewind playback, fast-forward playback will be engaged.

## PLAYBACK - Locate function -

### Index search

This function locates and advances/rewinds to the position where the index signal is recorded. Use the remote controller.

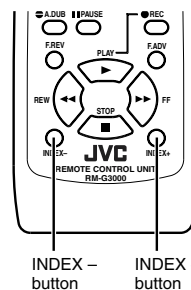

Monitor screen

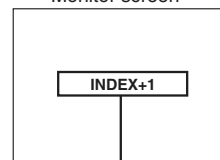

During index search, this message is displayed on the monitor (the number represents the position of the index).

■ **To locate an index in the forward direction vis-a-vis the current tape position:**

- Press the **INDEX +** button.

The index position to be located can be specified by the number of times this button is pressed. (Max: 99)

■ **To locate an index in the reverse direction vis-a-vis the current tape position:**

- Press the **INDEX -** button.

The index position to be located can be specified by the number of times this button is pressed. (Max: 99)

■ **When the INDEX + or INDEX - button is pressed, the unit will fast-forward or rewind to the specified indexed position and start playing.**

#### Memo

- If the interval between index signals is less than 1 minute, the function may not work well.
- The specifications for index signal recording varies with the device used.

### Blank search

This function locates the unrecorded parts of the tape. Use the remote controller.

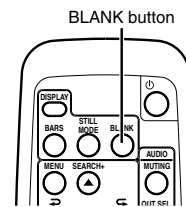

Monitor screen



■ **In the STOP mode, press the BLANK button.**

- If the current position is at a recorded part of the tape, the unit fast-forwards until an unrecorded part is reached and goes into the STOP mode.
- If the current position of the tape is unrecorded, the unit will first advance the tape in the forward direction for confirmation and thereafter rewind and go into the STILL mode at the last recorded position.
- During a blank search, "BLANK SEARCH" is displayed on the monitor.

## PLAYBACK - Repeat playback -

This unit is capable of 3 types of repeat playback.  
The repeat playback function is set via the REPEAT MODE item of the SYSTEM (1/2) menu.

### SYSTEM (1/2) menu

```

---SYSTEM[1/2]---
STL/F.ADV      2ND
BACKUP REC TIME OFF
LONG PAUSE TIME 5MIN
LONG PAUSE MODE F.ADV
INDEX WRITE    ON
REPEAT MODE    BLANK
NEXT PAGE
PAGE BACK
    
```

### Setting

#### REPEAT MODE item of the SYSTEM (1/2) menu

- OFF** : No repeat playback  
**INDEX** : Repeat playback between positions where index signals are recorded.  
**VIDEO END** : Repeat playback from the beginning of the tape to the position where video signal recording ends.  
**TAPE END** : Repeat playback from the beginning to the end of the tape.

### Operation

- Press the **REW** button and rewind the tape to the beginning.
  - Press the **PLAY** button to begin replay.  
 → When it reaches the position set at the REPEAT MODE menu item, the tape rewinds and plays back again.
- To abort the repeat playback function, press the **STOP** button.

### Repeat operation

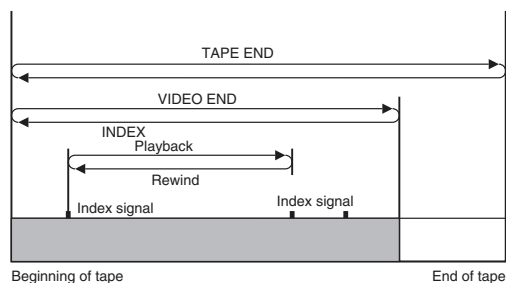

### INDEX repeat playback

- If no index signal is detected during playback, the tape will run till the end. If no index signal is detected during rewind, the tape will rewind till the beginning.
- If the interval between index signals is less than 1 minute, the function may not work well.

### Memo

If there is dust adhered to the head, repeat playback may not work well.

## PLAYBACK - Selecting playback audio output -

The output mode for audio playback can be selected with the remote controller.

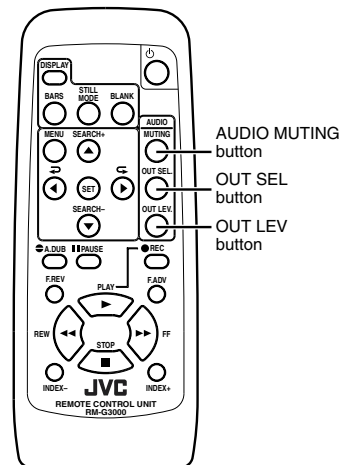

#### To turn the audio muting function ON/OFF or to mute the EE audio, press the AUDIO MUTING button.

To resume the audio output, press the button again.

#### Selecting the audio output channel for playback of tapes recorded in the 32kHz mode.

Each time the OUT SEL. button is pressed, the channel changes in the following sequence:

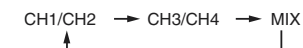

- CH3/CH4: CH3 audio is output via the CH1/3 AUDIO OUT terminal whereas CH4 audio is output via the CH2/4 AUDIO OUT terminal.
- MIX: Sounds mixed from CH1 and CH3 are output via the CH1/3 AUDIO OUT terminal whereas Sounds mixed from CH2 and CH4 are output via the CH2/4 AUDIO OUT terminal.

### Note

Depending on the sound source, noise may occur in the MIX mode. In this case, please use CH1/CH2 or CH3/CH4.

### Memo

- The output channel for playback audio of tapes recorded in the 32kHz mode can also be set via the AUDIO OUT SEL item of the AUDIO/VIDEO menu of the main unit.
  - The audio output level can be set via the AUDIO OUT LEVEL item of the AUDIO/VIDEO menu.
- ☞ Page 61 "AUDIO/VIDEO menu"

#### Select the output level for audio playback

Each time the OUT LEV button is pressed, the standard level for the output audio level changes. (NORMAL or ATT)

- To play back tapes recorded at a standard level of -12dB (using a consumer DV device), set the output level to ATT. In so doing, the audio output level decreases.
- To play back tapes recorded on this unit, set the output level to NORMAL.



# EDIT - Using the unit in an editing system -

## Cut-edit system

This unit can be used as a feeder (player) for an editing system that uses a RS-422A-compatible editing remote controller (RM-G820).

### Applicable model

- Editing remote controller :** RM-G820  
**Recorder :** VHS/S-VHS ..... BR-S800 (equipped with SA-K26 or SA-R50), BR-S822  
 \* DV signals cannot be input.  
 D9 (digital S) ..... BR-D80, BR-D85, BR-D750  
 \* To input DV signals, please install SA-DV60 to D9VTR.

### Example of connection

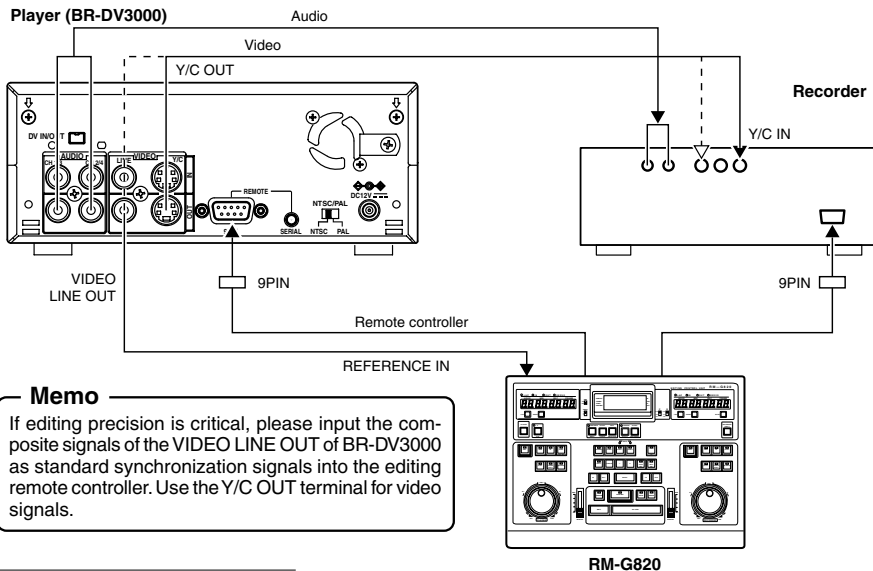

### Memo

If editing precision is critical, please input the composite signals of the VIDEO LINE OUT of BR-DV3000 as standard synchronization signals into the editing remote controller. Use the Y/C OUT terminal for video signals.

### Setting the main unit

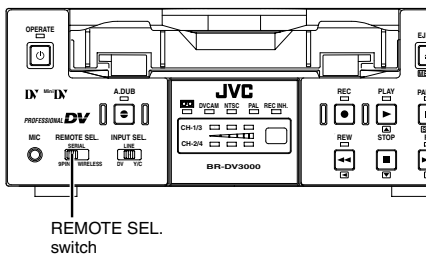

- Set the REMOTE SEL. switch of the front panel to 9 PIN.
- Set the NTSC/PAL switch according to the playback signals.
- Set the REMOTE menu.

- REMOTE : Set it to ON.
- PREROLL : Set the pre-roll time (second). The setting is recommended to be at least 7 seconds.

### Memo

The setting will be that which is set (if any) via the editing remote controller.

### REMOTE (1/2) menu

```

---REMOTE[1/2]---
>REMOTE LOCAL FUNCTION ALL KEYS
PREROLL 5S
REM FF/REW MODE FF/REW
REM STOP SEL EE
PB START DELAY OF
SYNCHRONIZATION ON
NEXT PAGE
PAGE BACK
    
```

- **REM STOP SEL:**  
Use this menu item to set the operation mode upon reception of a standby-on signal.  
**EE** : EE mode (STOP mode)  
**PB** : PLAYBACK mode (STILL mode)
- **PB START DELAY:**  
Use this menu item to set the edit timing. If delay occurs at the start of editing, correct this time discrepancy by adjusting the timing for starting playback.  
**0F** : No compensation. Usually, this option is selected.  
**1F to 15F** : Delay by the number of frames set by the user. In the case that the unit is connected to an editing remote controller with no BUMP function, use this setting to adjust editing precision.

### Memo

#### LOCAL FUNCTION

For controlling with the REMOTE terminal, use this menu item to select the action to be executed when an FF or REW command is received during playback. (FF/FEW or search)

#### REM FF/REM MODE:

Use this menu item to select the action to be executed when an FF or REW command is received during playback. (FF/FEW or search)

#### SYNCHRONIZATION

Use this menu item to turn on/off the synchronize function (BUMP) to enhance editing precision.  
**OFF** : No adjustments to synchronize.  
**ON** : Execute adjustments to synchronize. The editing operation may take more time.

#### CONTROLLER SEL [REMOTE (2/2) menu]

Use this menu item to set the type of controller connected. (Page 60)  
 Set it to TYPE 1 when RM-G820 is used.

### Setting the TC ADJUST item of the TIME CODE menu

To edit DV signals, set the timing of the time code output from BR-DV3000 to the editing controller.  
 • Usually, it is set to 0F.  
 • To edit DV signal with D9 VTR (equipped with SA-DV60), set it to -2F.

### RM-G820 Settings

- PREROLL : At least 7 sec is recommended.  
 BUMP : ON  
 COUNTER : LCT (Player)  
 After setting has been done, activate the LEARN function.  
 MENU NO. 18 BUMP SELECT  
 Select PLAYER if the recorder used is not equipped with the BUMP function.

### Notes

- Please do not use this unit as a recorder.
- It does not support AB roll editing.
- It does not support the following editing tasks.  
 Variable search  
 Slow-motion edit  
 CTL edit
- When performing jog operation using the editing remote controller, do it slowly. Otherwise, the VTR may not be able to keep up.
- For certain controllers, the LEARN function will not work normally.  
 SONY : RM-450, PVE-500  
 Enabling the LEARN function:  
 Insert the tape with time code recorded till 23:59:00:00-00:01:00:00 into the BR-DV3000 before activating the LEARN function.

## EDIT - Using the unit in an editing system - (continued)

### Using the unit in a non-linear system

This is a system that captures the content of the source tape on a non-linear editing system and records the non-linear edited contents onto the main unit.

### Connection

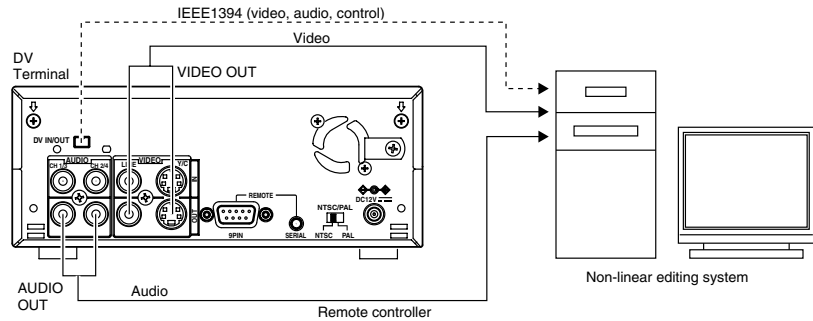

### Setting this unit

■ The REMOTE SEL switch on the front panel can be set at any position.

■ Set the REMOTE menu.

- REMOTE:  
Set it to ON.
- REMOTE FF/REW MODE:  
Use this menu item to select the action to be executed when an FF or REW command is received during playback (FF/REW or search). If the search and locate function does not work well, set it to SEARCH.
- CONTROLLER TYPE (REMOTE 2/2 menu):  
Set it to TYPE 1.

### Memo

If an error occurs to the time code of BR-DV3000 when the tape is advanced/reversed by 1 frame by the non-linear edit system, please set the STILL mode of the main unit to "FRAME".

## MENU SCREEN - Structure of the menu -

Hierarchical menus are displayed on the monitor.

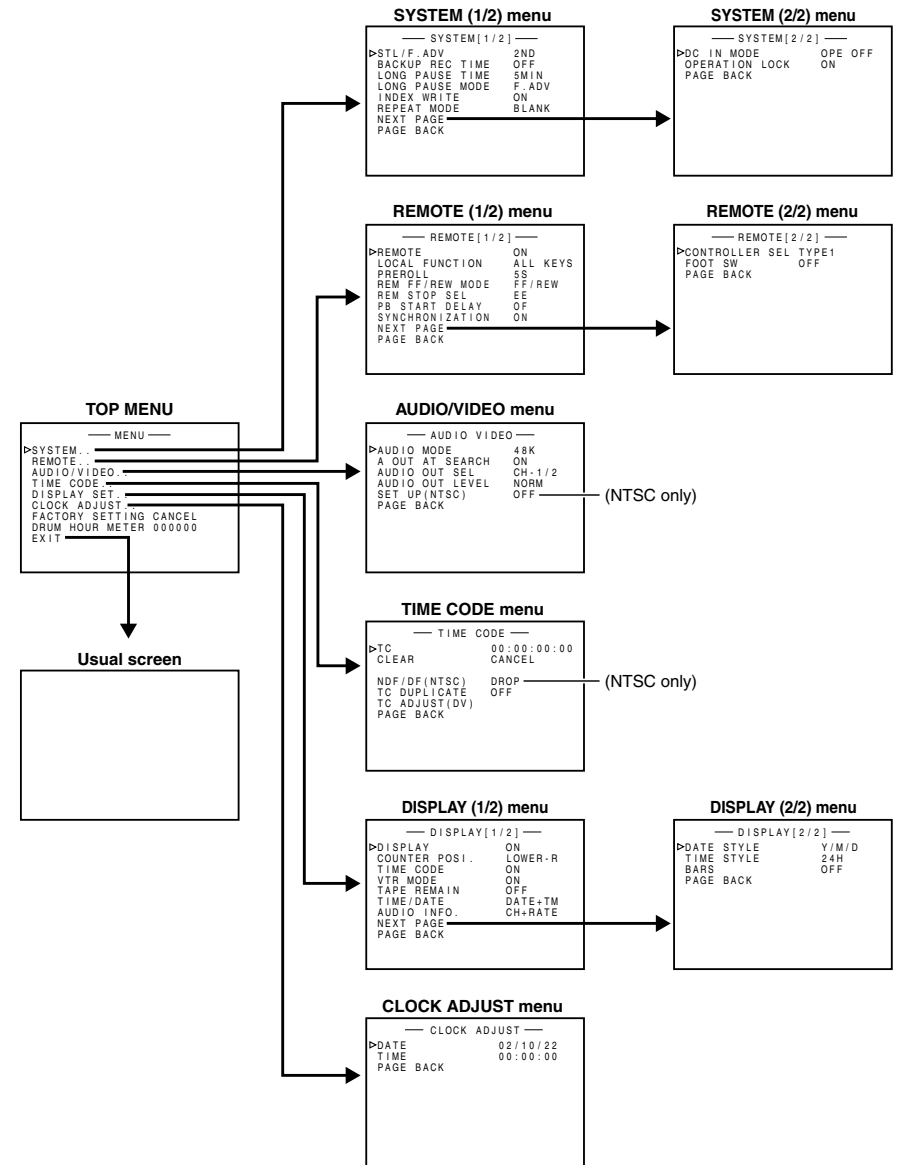

# MENU SCREEN - Setting the menu -

The various functions of this unit can be set from the menu. The configured settings are saved in the unit's memory and are maintained even after the power is turned off.

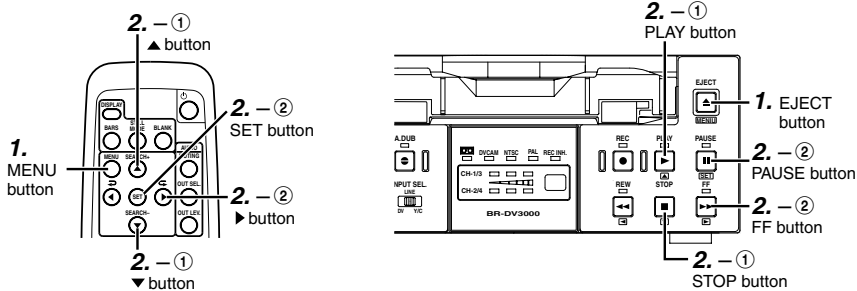

The menu screen settings can be done while viewing the monitor connected to the VIDEO LINE OUT or Y/C OUT terminal, using either the remote controller or the buttons on the main unit.

## ■ Set the unit to the STOP mode.

To perform setting with the operation buttons on the main unit, first remove the cassette if one is loaded.

### 1. Display the TOP MENU.

#### Remote controller

Press the MENU button.

#### Main unit

Press the EJECT button for at least 2 seconds.

### 2. Display the menu for setting.

#### Remote controller

- ① Press the ▲/▼ button and bring the cursor to the item to be set.
- ② Press the SET or ► button.

#### Main unit

- ① Press the PLAY/STOP button and bring the cursor to the menu item.
- ② Press the PAUSE or FF button.

- If the EXIT item of the TOP MENU is selected, the usual screen resumes.
- If the FACTORY SETTING item of the TOP MENU is set to EXECUTE, the set values on the menu will be reset to those initially set at manufacture. (Except DRUM HOUR METER)
- The DRUM HOUR METER item cannot be set.

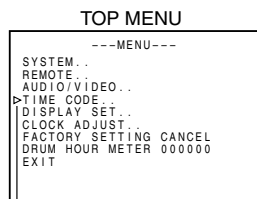

Cursor

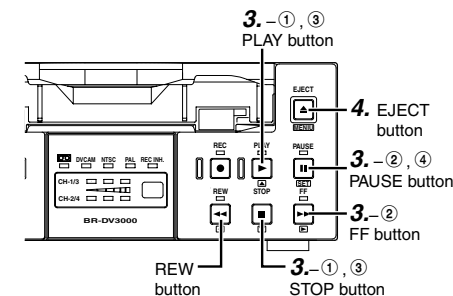
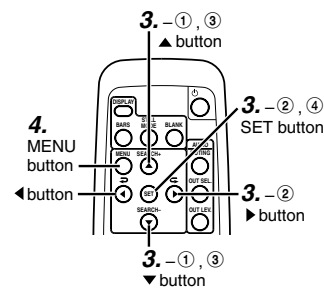
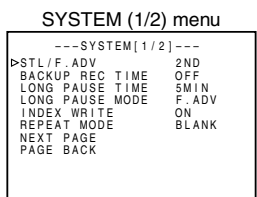

### 3. Set the items on the menu.

#### Remote controller

- ① Press the ▲/▼ button and bring the cursor to the item to be set.
- ② Press the SET or ► button.

→ The selected value blinks and becomes available for changing.

- ③ Press the ▲/▼ button to change the value as desired.
- ④ Press the SET button to confirm the value.

→ The value stops blinking and is confirmed.

- ⑤ Repeat steps ① - ④ above and perform the necessary settings.

#### Main unit

- ① Press the PLAY/STOP button and bring the cursor to the item to be set.
- ② Press the PAUSE or FF button.

- ③ Press the PLAY/STOP button to change the value as desired.
- ④ Press the PAUSE button to confirm the value.

### ■ To display the menu of the next level of the hierarchy, select NEXT PAGE.

### ■ To return to the previous screen, do either of the following:

#### Remote controller

- Press the ◀ button.
- Or
- Select PAGE BACK.

#### Main unit

- Press the REW button.
- Or
- Select PAGE BACK.

### 4. To return to the usual screen, do either of the following:

#### Remote controller

- Press the MENU button.
- Or
- Select EXIT from the TOP MENU.

#### Main unit

- Press the EJECT button.
- Or
- Select EXIT from the TOP MENU.

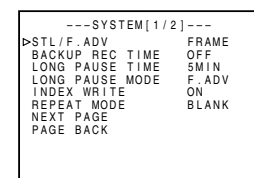
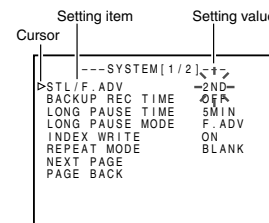

#### TOP MENU

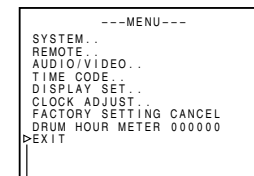

Cursor

## MENU SCREEN - Contents of the menus -

In the menu descriptions below, settings with “●” marks are factory settings.

### TOP MENU

| Items           | Setting             | Contents   |
|-----------------|---------------------|--|
| SYSTEM          |                     | Displays the menus related to the operation system of this unit.   |
| REMOTE          |                     | Displays the menus related to the remote controller.   |
| AUDIO/VIDEO     |                     | Displays the menus related to the audio and video.   |
| TIME CODE       |                     | Displays the menu for setting time codes.  |
| DISPLAY         |                     | Displays the menu related to the displays on the monitor connected to the VIDEO LINE OUT or Y/C OUT terminal.  |
| CLOCK ADJUST    |                     | Displays the menu for setting date/time.<br>For information on the setting method, please refer to page 31 “Setting date/time”.  |
| FACTORY SETTING | ● CANCEL<br>EXECUTE | Sets whether to return the values on the menu to those initially set at manufacture.<br>CANCEL : Do not use the factory settings<br>EXECUTE : Use the factory settings |
| DRUM HOUR METER |                     | Displays the drum usage time.<br>*The cursor cannot be moved to this item.   |
| EXIT            |                     | Return to the usual screen.  |

### SYSTEM Menu

The SYSTEM menu consists of the following 2 screens. (1/2 and 2/2 menu)

#### ■ SYSTEM (1/2) menu

| Items           | Setting  | Contents   |
|-----------------|--|--|
| STL/FADV MODE   | FIELD<br>1st<br>● 2nd<br>FRAME                                 | Use this item to select the still image type during the STILL mode or frame advance playback.<br>FIELD : Displays field image. During frame advance playback, 1st and 2nd field images are displayed alternately.<br>1st : displays the 1st field image.<br>2nd : displays the 2nd field image.<br>FRAME : displays the frame image.<br><b>— Memo —</b><br>The image type for the STILL mode can also be selected with the STILL MODE button on the wireless remote controller.  |
| BACKUP REC TIME | ● OFF<br>25MIN<br>55MIN<br>75MIN<br>115MIN<br>175MIN<br>265MIN | Set this item according to the recording time of the source tape during DV signal input backup recording.<br>OFF : No backup recording.<br>25MIN : Use this setting if the recording time of the source tape is 30 mins<br>55MIN : Use this setting if the recording time of the source tape is 60 mins<br>75MIN : Use this setting if the recording time of the source tape is 80 mins<br>115MIN : Use this setting if the recording time of the source tape is 120 mins<br>175MIN : Use this setting if the recording time of the source tape is 180 mins<br>265MIN : Use this setting if the recording time of the source tape is 270 mins<br>☞ Page 40 “Backup recording function” |
| LONG PAUSE TIME | 30SEC<br>1MIN<br>2MIN<br>3MIN<br>● 5MIN                        | Sets the interval after the lapse of which the tape protection mode will be engaged during an extended STILL mode, STOP mode or recording pause. The setting for the STILL mode can be made via the LONG PAUSE MODE menu item.<br>30SEC: 30 seconds<br>1MIN : 1 minute      3MIN : 3 minutes<br>2MIN : 2 minutes      5MIN : 5 minutes<br><b>— Memo —</b><br>To prevent damage, please set as short a time interval as possible.   |
| LONG PAUSE TIME | ● F.ADV<br>STBY-OFF  | Use this menu item to set the action to be done when the unit has been left in the STILL mode for an extended period of time. In the case that the unit had been left in the recording pause or STOP mode, the unit will go into the Standby Off mode.<br>F.ADV: It advances in the forward direction. On the 6th advancement, it goes into the STOP state.<br>STBY-OFF: Goes into the STOP state.   |

## MENU SCREEN - Contents of the menus - (continued)

### SYSTEM Menu (continued)

| Items       | Setting                                 | Contents   |
|-------------|---|--|
| INDEX WRITE | OFF<br>● ON                             | Use this setting to enable/disable index signal recording.<br>OFF : No recording of index signal.<br>ON : Use this setting to record index signals. An index signal is automatically registered at the position where recording starts.  |
| REPEAT MODE | ● OFF<br>INDEX<br>VIDEO OUT<br>TAPE END | Use this setting to enable/disable repeat playback.<br>OFF : No repeat playback<br>INDEX : Repeat playback between the positions where index signals are recorded.<br>VIDEO END : Repeat playback from the beginning of the tape to the position where recording of video signals ends.<br>TAPE END : Repeat playback from the beginning to the end of the tape. |
| NEXT PAGE   |   | Display the SYSTEM (2/2) menu.   |
| PAGE BACK   |   | Return to the TOP MENU.  |

### SYSTEM (2/2) menu

| Items          | Setting                     | Contents   |
|----------------|-----------------------------|--|
| DC IN MODE     | ● OPE OFF<br>OPE ON<br>PLAY | Select the action to perform when power is supplied via the DC IN terminal.<br>OPE OFF : Sets the unit to OPERATE OFF<br>OPE ON : Sets the unit to OPERATE ON.<br>PLAY : If a tape has been inserted, the VTR will go into the PLAY mode. (AUTO PLAY)  |
| OPERATION LOCK | ● OFF<br>ON                 | Turn ON/OFF the OPERATION LOCK.<br>OFF : Turns off the OPERATION LOCK and enables the buttons on the main unit.<br>ON : VTR goes into the OPERATE LOCK mode. The buttons and the slide switch on the main unit are inhibited. However, OPERATE ON and menu operations are still possible.<br><b>— Memo —</b><br>Even when this setting is OFF, disabling the buttons on the main unit while it is controlled via a remote controller connected to the 9 PIN REMOTE or SERIAL REMOTE terminal is possible, by setting the LOCAL FUNCTION item of the REMOTE menu. |
| PAGE BACK      |                             | Return to the SYSTEM (1/2).  |

### REMOTE menu

The REMOTE menu consists of 2 menus. (1/2 and 2/2 menu)

#### REMOTE (1/2) menu

| Items           | Setting                                    | Contents  |
|-----------------|--|---|
| REMOTE          | OFF<br>● ON                                | Use this menu item to enable/disable the REMOTE SEL. switch on the front panel.<br>OFF : Disables the 9 PIN/SERIAL setting of the REMOTE SEL. switch.<br>ON : Enables the 9 PIN/SERIAL setting of the REMOTE SEL. switch. Use this setting when remote controlling the unit via the 9 PIN and SERIAL terminal.  |
| LOCAL FUNCTION  | NO KEY<br>EJECT<br>STP + EJT<br>● ALL KEYS | Use this to select the buttons on the main unit to be rendered operable when remote controlling the unit via the 9 PIN REMOTE terminal or the SERIAL REMOTE terminal.<br>NO KEY : No button enabled.<br>EJECT : Only the EJECT button enabled.<br>STP + EJT : Only the STOP button and the EJECT button are enabled.<br>ALL KEYS : All operation buttons are enabled.<br><b>— Memo —</b><br>If the OPERATION LOCK item of the SYSTEM (2/2) menu is set as ON, the buttons on the main unit will be disabled regardless of the setting here. |
| PREROLL         | 3SEC<br>5SEC<br>● 7SEC<br>10SEC            | When remote controlling the unit via the 9 PIN REMOTE terminal, use this item to set the PREROLL time of the unit. Configurations done via the editing remote controller prevail over other settings.<br>3SEC : 3 seconds<br>5SEC : 5 seconds<br>7SEC : 7 seconds<br>10SEC : 10 seconds<br><b>— Memo —</b><br>To enhance editing precision, please set it to at least 7 seconds.  |
| REM FF/REW MODE | ● FF/REW<br>SEARCH                         | Use this menu item to set the action to be performed when an FF/REW command is received via the 9 PIN REMOTE terminal or DV terminal.<br>FF/REW : Sets the unit to execute FF/REW when a command is received. This is the usual setting.<br>SEARCH : Sets the unit to go into the SEARCH state when a command is received. Use this setting if the locate(cue up) function does not work well.  |

## MENU SCREEN - Contents of the menus - (continued)

### REMOTE menu

| Items           | Setting          | Contents   |
|-----------------|------------------|--|
| REM STOP SEL    | ● EE<br>PB       | Use this menu item to set the action to be performed when a STANDBY ON command is received via the 9 PIN REMOTE terminal or DV terminal.<br>EE: Sets the unit to the EE mode. (The unit will go into the STOP mode.)<br>PB: Sets the unit to the PLAY mode. (The unit will go into the STILL mode.)  |
| PB START DELAY  | ● 0F<br> <br>15F | Use this menu item to adjust the edit timing. When the remote controller is used, there will be a slight delay time before edit starts. To rectify the time discrepancy, adjust the timing for starting playback.<br>0F : No compensation<br>1F to 15F : Delay by the number of frames set by the user. When this unit is connected to an editing remote controller with no BUMP (synchronization) function, use this setting to adjust the editing precision. |
| SYNCHRONIZATION | OFF<br>● ON      | Use this setting to turn on/off the BUMP function when the unit is connected to an editing remote controller.<br>OFF : No synchronization<br>ON : Execute synchronization. The editing precision is enhanced. Please set the pre-roll time to at least 7 seconds.  |
| NEXT PAGE       |                  | Display the REMOTE (2/2) menu.   |
| PAGE BACK       |                  | Return to the TOP MENU.  |

### ■ REMOTE (2/2) menu

| Items          | Setting                              | Contents   |
|----------------|--------------------------------------|--|
| CONTROLLER SEL | ● TYPE1-<br>TYPE7                    | When remote control is executed via the RS-422A interface, use this menu item to set the type of controller connected.<br>TYPE1 : RM-G820<br>TYPE2 : RM-G860<br>TYPE3 : AG-A850<br>TYPE4 : RM-450,PVE-500<br>TYPE5 - TYPE7 : not in use  |
| FOOT SW        | ● OFF<br>L EDGE<br>H EDGE<br>L LEVEL | Set this menu item when an external switch (e.g., a footswitch) is connected to the SERIAL REMOTE terminal. Before using an external switch (footswitch), please engage the recording pause or recording mode.<br>OFF: Use this setting if the external switch is not used.<br>L EDGE : Recording and recording pause is switched at the LOW edge of the external switch signal.<br>H EDGE : Recording and recording pause is switched at the HIGH edge of the external switch signal.<br>L LEVEL : Record at the LOW edge and pause recording at the HIGH edge of the external switch signal. |
| PAGE BACK      |                                      | Return to the REMOTE (1/2) menu.   |

### AUDIO/VIDEO menu

| Items  | Setting                     | Contents   |
|--|-----------------------------|--|
| AUDIO MODE   | ● 48k<br>32k                | Select the audio sampling frequency for recording.<br>48k : Records at 48kHz. It records in the 2-channel stereo mode. No audio dubbing.<br>32k : Records at 32kHz. It records in the 4-channel mode. To perform audio dubbing on CH3 and CH4 later, use this setting.<br>- <b>Memo</b> _____<br>This setting is not required for DV signal input.   |
| A.OUT AT SERCH   | OFF<br>● ON                 | Use this menu item to enable/disable audio output from the AUDIO OUT terminal during a search.<br>OFF : No output.<br>ON : Output  |
| AUDIO OUT SEL  | ● CH1/CH2<br>MIX<br>CH3/CH4 | Use this menu item to select the audio channel output from the AUDIO OUT terminal when playing back tapes recorded in the 32k mode.<br>CH1/CH2 : Outputs CH1 and CH2 audio.<br>MIX : Outputs mixed audio of CH1 and CH3 and mixed audio of CH2 and CH4.<br>CH3/CH4 : Outputs CH3 and CH4 audio.<br>- <b>Memo</b> _____<br>This setting can also be selected from the AUDIO OUT SEL. button on the wireless remote controller.                          |
| <b>Memo</b><br>When it is set to the MIX mode, noise may be produced. If this occurs, please set it to CH1/CH2 or CH3/CH4. |                             |  |
| AUDIO OUT LEVEL  | ATT<br>● NORM               | Use this menu item to select the standard level for audio playback output.<br>ATT : Attenuates the standard level to -12db. Use this setting when playing tapes recorded at the standard level of -12dB. The playback level is decreased by 8db.<br>NORM : Sets the standard level to -20dB. Usually, this is selected.<br>- <b>Memo</b> _____<br>This setting can also be selected with the AUDIO OUT LEVEL button on the wireless remote controller. |
| SET UP (NTSC only)   | ● OFF<br>ON                 | Use this setting to determine whether to apply the setups to the analogue video signals (composite, Y/C). (For recording and playback).<br>OFF : does not apply the setups.<br>ON : applies the setups<br>- <b>Memo</b> _____<br>• If dubbing is repeatedly done with the settings of the playback or recording video signals differing from the setting here, the hue and brightness of the video may turn out abnormal.                              |
| PAGE BACK  |                             | Return to the TOP MENU.  |



## MENU SCREEN - Contents of the menus - (continued)

### TIME CODE menu

| Items                 | Setting  | Contents   |
|-----------------------|--|--|
| TC                    |  | Presets the time code.<br>For details, please refer to Page 36 "Presetting Time Codes".  |
| CLEAR                 | <input checked="" type="radio"/> CANCEL<br><input type="radio"/> EXECUTE   | Use this menu item to choose whether to clear the time code values.<br>CANCEL : Do not clear<br>EXECUTE : clear  |
| NDF/DF<br>(NTSC ONLY) | <input type="radio"/> NDF<br><input checked="" type="radio"/> DF   | Select the framing mode for the time code generator.<br>NDF : Sets the unit to the non-drop mode. Use this setting when the number of frames of the time code is important.<br>DF : Sets the unit to the drop-frame mode. Use this setting for real-time based time codes.   |
| TC DUPLICATE          | <input checked="" type="radio"/> OFF<br><input type="radio"/> AUTO<br><input type="radio"/> NON DROP   | Use this menu item to select the type of time code to be recorded for DV signal input.<br>OFF : Records the time codes of the built-in time code generator of the main unit.<br>AUTO : Records the time code input to the DV IN terminal. The framing mode of the time code will be automatically set to the framing of the input time code.<br>NON DROP : Records the time code input to the DV IN terminal. The framing mode of the time code will be fixed as non-drop framing. Use this setting when dubbing on tapes recorded with BR-DV600, GY-DV500, GY-DV550, or GY-DV700W in the non-drop frame mode. (NTSC only) |
| TC ADJUST (DV)        | <input checked="" type="radio"/> OFF<br><input type="radio"/> +1F<br><input type="radio"/> +2F<br><input type="radio"/> -2F<br><input type="radio"/> -1F | Use this menu item to set the timing to output time codes from the 9PIN REMOTE terminal of the main unit to the editing remote controller.<br>OFF : Usually, this is selected.<br>+1F : Sets the timing to 1 frame faster.<br>+2F : Sets the timing to 2 frames faster.<br>-2F : Sets the timing to 2 frames slower. Use this setting when editing video or audio using DV signals.<br>-1F : Sets the timing to 1 frame slower.  |
| PAGE BACK             |  | Return to the TOP MENU.  |

### DISPLAY menu

The DISPLAY menu consists of 2 menus (1/2 and 2/2 menu)

#### ■ DISPLAY (1/2) menu

| Items         | Setting   | Contents  |
|---------------|---|---|
| DISPLAY       | <input type="radio"/> OFF<br><input checked="" type="radio"/> ON<br><input type="radio"/> AUTO  | Use this menu item to choose whether to have the characters of the status screen displayed on the monitor connected to VIDEO LINE OUT or Y/C OUT terminal.<br>OFF : No on-screen display. Video display only.<br>ON : Always provide on-screen display.<br>AUTO : Provide on-screen display for about 4 seconds on switching modes.<br><br>- Memo<br>This setting can also be selected from the DISPLAY button of the wireless remote controller. |
| COUNTER POSI. | <input checked="" type="radio"/> LOWER-R<br><input type="radio"/> LOWER-L<br><input type="radio"/> UPPER-R<br><input type="radio"/> UPPER-L<br><input type="radio"/> CENTER | Use this menu item to select the position on the monitor for time code display.<br>LOWER-R : Lower right<br>LOWER-L : Lower left<br>UPPER-R : Upper right<br>UPPER-L : Upper left<br>CENTER : Center  |
| TIME CODE     | <input type="radio"/> OFF<br><input checked="" type="radio"/> ON  | Use this menu item to turn on/off the display of time codes on the monitor.<br>OFF : No display<br>ON : Display   |
| VTR MODE      | <input type="radio"/> OFF<br><input checked="" type="radio"/> ON  | Use this menu item to turn on/off the display of the VTR mode on the monitor.<br>OFF : No display<br>ON : Display   |
| TAPE REMAIN   | <input type="radio"/> OFF<br><input checked="" type="radio"/> ON  | Use this menu item to turn on/off the display of remaining tape on the monitor.<br>OFF : No display<br>ON : Display   |
| TIME/DATE     | <input type="radio"/> OFF<br><input type="radio"/> TIME<br><input type="radio"/> DATE<br><input checked="" type="radio"/> DATE +TM  | Use this menu item to turn on/off the date/time display on the monitor and to select the display format.<br>OFF : No display of date/time.<br>TIME : Display the time only.<br>DATE : Display the date only.<br>DATE +TM : Display the date/time.   |

## MENU SCREEN - Contents of the menus - (continued)

### DISPLAY menu (continued)

| Items       | Setting     | Contents   |
|-------------|-------------|--|
| AUDIO INFO. | OFF<br>● ON | Use this setting to turn on/off the display of audio channel or sampling frequency on the monitor.<br>OFF : No display<br>ON : Display |
| NEXT PAGE   |             | Display the DISPLAY (2/2) menu.  |
| PAGE BACK   |             | Return to the TOP MENU.  |

### ■ DISPLAY (2/2) menu

| Items      | Setting  | Contents   |
|------------|--|--|
| DATE STYLE | YY/MM/DD<br>● MM/DD/YY (U model)<br>● DD/MM/YY (E model) | Select the date format.<br>YY/MM/DD : Display year/month/day.<br>MM/DD/YY : Display month/day/year.<br>DD/MM/YY : Display day/month/year.  |
| TIME STYLE | ● 24HOUR<br>12HOUR                                       | Select the time format.<br>24HOUR : Display in the 24-hour mode.<br>12HOUR : Display in the 12-hour mode.  |
| BARS       | ● OFF<br>ON  | Use this menu item to choose whether to output, as test signals, color bar signals from the built-in signal generator.<br>OFF : No output<br>ON : Output<br>— Memo —<br>• This color bar cannot be used as the standard signal for hue calibration.<br>• This setting can also be selected from the BARS button on the wireless remote controller.<br>• During DV signal input, the color bar will not be output even if this item is set to ON. |
| PAGE BACK  |  | Return to the DISPLAY (1/2) menu.  |

## OTHERS - Placing the unit in an upright position -

With the use of the provided stand, the main unit can be placed in an upright position as shown in the following diagram.  
The left side should be at the bottom.

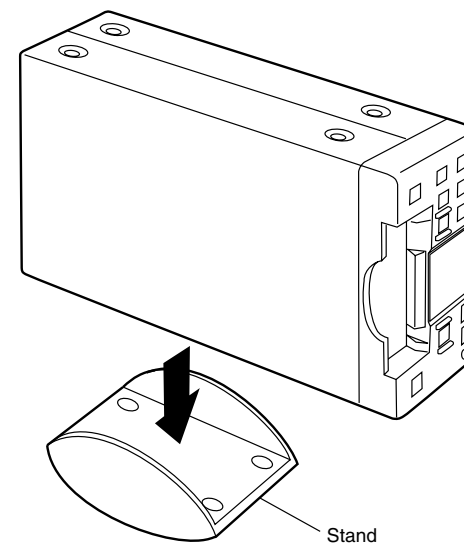

### Notes

- To place the VTR in an upright position, please use the provided stand. If the stand is not used, the unit may topple and result in injuries or breakdown.
- Please place the unit on a leveled place.

## OTHERS - Warning display -

When an anomaly occurs, this unit automatically identifies the cause and displays an error-coded warning message on the monitor.

If the unit is in a state needing rectification, or if an operation error has occurred, an alarm display will be shown on the monitor.

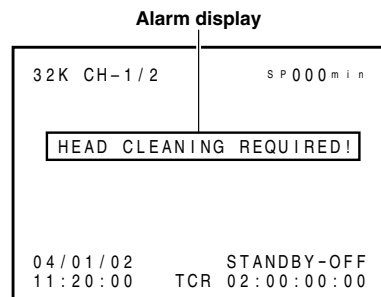
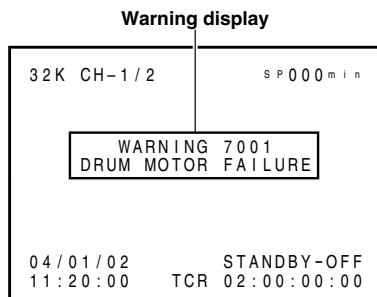

### ■ Alarm display (Displayed regardless of the DISPLAY mode)

| Display                 | Status  | Action   |
|-------------------------|---|--|
| LOW VOLTAGE             | The DC power voltage is low. The unit will eventually go into the OPERATE OFF mode if operation is continued.   | Please check the power voltage.  |
| HEAD CLEANING REQUIRED! | The video head is dirty. If the head is clogged, it will be detected and the alarm message will be displayed during the PLAYBACK mode. When the STOP mode is engaged or when the cassette is ejected, the display will go off. When the head clog is cleared, the message will disappear. | Please clean it with the dedicated head-cleaning tape. (Page 8)<br>If the message persists despite cleaning, it could be due to bad recording condition, bad tape or lifespan of the head. |
| OVER HEATING!           | The internal temperature of the unit has exceeded the regulated value.  | Please disconnect the power and place the unit in a cool place. If this message is displayed again, the unit may have been damaged. Please consult your JVC authorized dealer.             |

• For alarm displays resulting from operation errors, please refer to page 22.

**For servicing**  
The possibility of FAN motor failure

**For servicing**  
Refer to the servicemanual page. 1-9 "1.8.7 Error Rate Monitor"

### ■ Warning display (Displayed regardless of the DISPLAY mode)

When a warning display appears, this unit stops operation and cease to accept any operation commands. When TAPE DEFFECTIVE (5605 - 5609) is displayed, the unit similarly stops operation but accepts one command, viz EJECT.

| Display                                  | Status                              | Action   |
|--|-------------------------------------|--|
| CONDENSATION ON DRUM                     | Condensation                        | Please leave the power on and wait for the display to disappear.   |
| WARNING 3200 LOADING FAILURE             | Unable to load tape                 | This error can be resolved by restarting the unit. However, doing so may damage the tape in some cases. Please consult your JVC authorized dealer. |
| WARNING 3300 LOADING FAILURE             | Unable to eject tape                |  |
| WARNING 4100 CASSETTE EJECT FAILURE      | Eject error                         |  |
| DEFFECTIVE TAPE!<br>5605 - 5609          | Tape is cut                         | Press the EJECT button and retrieve the cassette. Then replace the tape.   |
| WARNING 5702 TAPE END DET. ERROR!        | Tape ending sensor error            | This error can be resolved by restarting the unit. However, doing so may damage the tape in some cases. Please consult your JVC authorized dealer. |
| WARNING 5802 TAPE BEGIN DET. ERROR!      | Tape begin sensor error             |  |
| WARNING 7001 DRUM MOTOR FAILURE          | Drum rotation error                 |  |
| WARNING 7101 CAP MOTOR FAILURE           | Capstan rotation error              |  |
| WARNING 7202 - 7203 SUPPLY REEL FAILURE  | Supply reel rotation error          |  |
| WARNING 7302 - 7303 TAKE UP REEL FAILURE | Take up reel rotation error.        |  |
| WARNING 7305 TAKE UP REEL FAILURE        | Tape winding error during unloading |  |
| WARNING 7401 REEL MOTOR FAILURE          | Reel motor rotation error           |  |

#### Memo

This unit uses a microcomputer. It may not function correctly if there is external noise. If this happens, please turn off the power and then on again.

**For servicing**  
Refer to the servicemanual page. 1-10 "1.8.7 Error history menu"

## OTHERS - Troubleshooting -

| Symptom  | Action   |
|--|--|
| The power does not come on.  | Is the AC adapter correctly connected?   |
| The cassette cannot be loaded.   | Is the cassette indicator lit? If so, a cassette is already loaded. Please unload the cassette first. Push the center of the cassette and make sure that the cassette enters levelly.  |
| Unable to record.  | Is the slide of the cassette set to "REC"? Please set it to "REC" if it is at the "SAVE" position.   |
| The operation buttons of the main unit do not work.  | Is the OPERATION LOCK item of the SYSTEM (2/2) menu set to ON? Please set it to OFF so that the operation buttons of the main unit can be used. During REMOTE mode, please use the LOCAL function menu item to select the buttons to be rendered operable. |
| The 9 PIN REMOTE or SERIAL REMOTE cannot be engaged with the REMOTE SEL switch.                                | Is the REMOTE item of the REMOTE (1/2) menu set to OFF? To use the 9 PIN REMOTE or the SERIAL REMOTE, please set it to ON. When the OPERATE LOCK item of the SYSTEM(2/2) menu is set to ON, the REMOTE SEL switch will not function.                       |
| Noise appears on the playback screen. Playback audio is disrupted.   | <ul style="list-style-type: none"> <li>Is the tape damaged? Please replace the cassette.</li> <li>Is the head dirty? Please clean it with the dedicated head-cleaning tape. (Page 8)</li> </ul>  |
| During DV signal input, the time codes are not recorded correctly.   | Is the TC DUPLICATE item of the TIME CODE menu set correctly?  |
| After holding down the EJECT button of the main unit for 2 seconds or longer, the menu screen does not appear. | Is a cassette loaded? Before attempting to display the menu screen with the EJECT button, please remove the cassette.  |
| Video and sound are distorted for a few seconds after starting playback.                                       | This occurs if the signal system of the playback tape is different from the NTSC/PAL setting.  |
| The wireless remote controller does not work at all.   | <ul style="list-style-type: none"> <li>Is the REMOTE SEL switch on the main unit set to WIRELESS?</li> <li>Are the batteries exhausted?</li> </ul>   |
| Power is not supplied even when the OPERATE button is pressed.   | Is the REMOTE SEL switch set at either SERIAL or 9 PIN when the LOCAL FUNCTION item of the REMOTE menu is set to something other than ALL KEYS? Please set the REMOTE SEL switch to WIRELESS.  |

## OTHERS - Checking the hour meter -

This unit displays the drum usage time on the DRUM HOUR METER item of the TOP MENU. Please use it as a guide for regular maintenance. Page 7

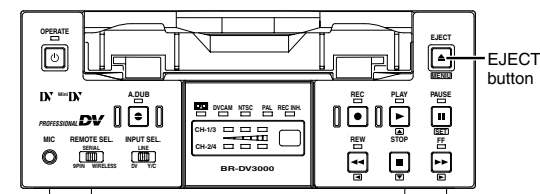
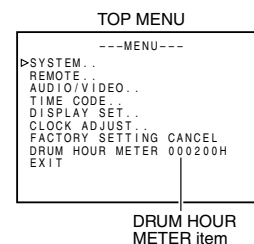
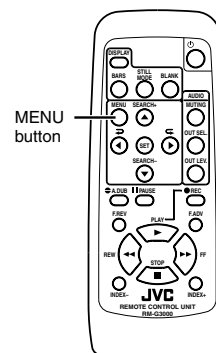

### Operation

#### ■ To set the unit to the STOP mode:

When operating with the buttons on the main unit, unload the cassette.

#### 1. Display the TOP MENU.

**Remote controller**

Press the MENU button.

**Main unit**

Press the EJECT button for at least 2 seconds.

- Display the drum usage time on the DRUM HOUR METER item of the TOP MENU.

#### 2. To return to the usual screen:

**Remote controller**

Press the MENU button.

**Main unit**

Press the EJECT button.

## OTHERS - Specification -

### ■ General

Recording system : DV system (SP mode only)  
 Signal system : NTSC/PAL  
 Cassette : Standard/ mini DV cassette  
 Tape width : 6.35mm  
 Tape speed : 18.812mm/s (NTSC)  
 18.831mm/s (PAL)

### Recording/ playback time

: 276 minutes (LA-DV276)  
 60 minutes (M-DV60)

### Fast forward/ rewind time

: About 3 minutes (LA-DV276)  
 About 1 minute (M-DV60)

### Power

: DC12V (supplied via the provided AC adapter)

Power consumption : 14W, 1.17A

External dimension : 174mm × (W) × 68mm (H)  
 × 260mm (D) (Excluding protruding parts, e.g., foot)

### Weight

: About 2.5 kg

### Allowable operating temperature

: 5°C to 40°C

### Allowable storage temperature

: -20°C to 60°C

### Allowable operating RH

: 30%RH to 80%RH

### ■ Video

Recording format : 8 bit, 13.5MHz,  
 4:1:1 (NTSC)  
 4:2:0 (PAL)

### Video input

Line (composite) : 1.0V (p-p), 75Ω unbalance

Y/C Y : 1.0V (p-p), 75Ω unbalance  
 C : 0.286V (p-p) (NTSC) /  
 0.3V (p-p) (PAL)  
 75Ω unbalance

### Video output

Line (composite) : 1.0V (p-p), 75Ω unbalance

Y/C Y : 1.0V (p-p), 75Ω unbalance  
 C : 0.286V (p-p) (NTSC) /  
 0.3V (p-p) (PAL)  
 75Ω unbalance

### Horizontal resolution

: 500 line or more

S/N : 48dB or higher

### ■ Audio

Recording format : 16 bit, 48kHz, 2 channels  
 PCM audio/12 bit, 32kHz,  
 4-channel PCM audio

Number of track : 2 (16 bit, 4 8kHz) /

4 (12 bit, 32kHz)

Audio input : -8dBs, 10kΩ unbalance

Mike input : -60dBs, 3kΩ unbalance

Audio output : -8dBs, 1kΩ unbalance

### Frequency characteristics

: 20Hz to 20kHz (48kHz)

20Hz to 16kHz (32kHz)

### ■ DV interface

Input/output : IEEE1394

### ■ AC adapter section

Power : AC 100V to 240V~,  
 50Hz/60Hz.

### Power consumption

: 1.0A to 0.5A

Output : DC 12V ≒ 3.5A

### ■ Accessories

Wireless remote controller ..... × 1  
 AC adapter ..... × 1  
 Power Cable ..... × 1  
 Battery(AA) ..... × 2  
 Stand ..... × 1

## OTHERS - Specification - (continued)

### ■ Diagram of external dimension (Unit: mm)

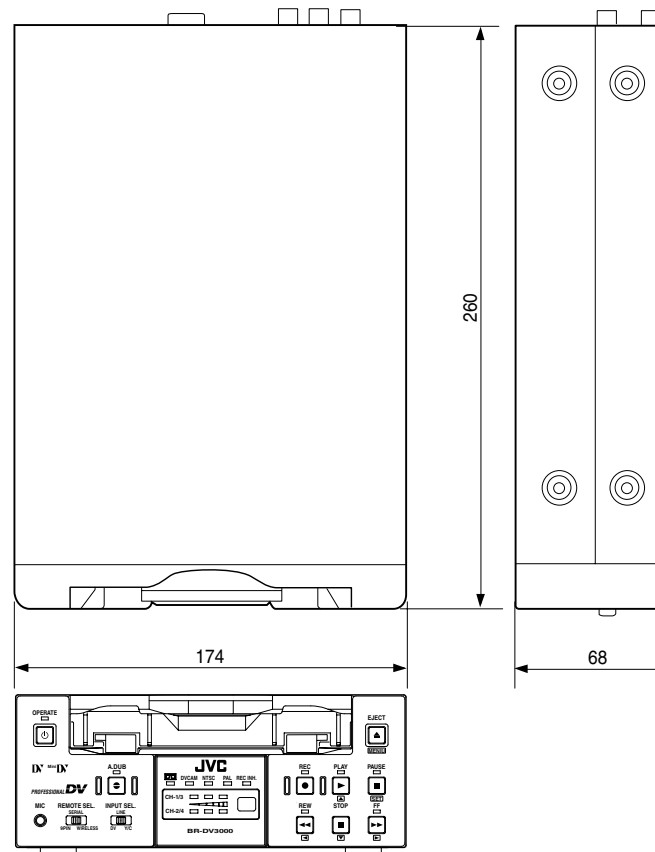

## PRECAUTION

This unit is equipped with a function to automatically detect the signal system of the cassette being played back or the signal being received at the DV input connector. However, this function may not operate correctly in some instances.

To ensure the correct system selection, it is recommended that you match the rear panel's NTSC/PAL switch to the signal system of the input signal or playback tape.

## ご注意

本機は再生するカセットやDV入力の信号方式を自動判別する機能がありますが、まれに誤動作することがあります。

より確実にお使いいただくためには、本機背面の“NTSC/PAL”スイッチ、入力信号、再生テープの信号方式を合わせることをおすすめします。

LLT0036  
(BR-DV3000)

## PRECAUTION

After pressing the OPERATE button and turning on the power, if the LED blinks in green, please unplug the power cord from the power outlet and then wait for some time before plugging it in again.

## ご注意

OPERATE ボタンを押して電源を立ち上げた後、OPERATE LED が緑色で点滅している場合は、一旦電源コードをコンセントから外し、しばらく放置してから電源を入れ直してください。

LLT0035  
(BR-DV3000)



## Free Manuals Download Website

<http://myh66.com>

<http://usermanuals.us>

<http://www.somanuals.com>

<http://www.4manuals.cc>

<http://www.manual-lib.com>

<http://www.404manual.com>

<http://www.luxmanual.com>

<http://aubethermostatmanual.com>

Golf course search by state

<http://golfingnear.com>

Email search by domain

<http://emailbydomain.com>

Auto manuals search

<http://auto.somanuals.com>

TV manuals search

<http://tv.somanuals.com>