

JVC®

DV VIDEO CASSETTE RECORDER
DV VIDEOKASSETTENREKORDER
ENREGISTREUR A CASSETTE DIGITAL VIDEO
DV VIDEOREGISTRATORE
UNIDAD GRABADORA DE VÍDEO DV

BR-DV6000E

DV Mini DV

INSTRUCTION MANUAL
BEDIENUNGSANLEITUNG
MODE D'EMPLOI
ISTRUZIONI PER L'USO
MANUAL DE INSTRUCCIONES

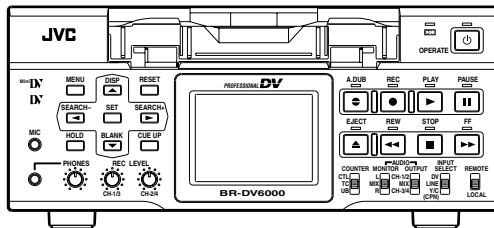

Thank you for purchasing this JVC product.
Before operating this unit, please read the
instructions carefully to ensure the best
possible performance.

English

Deutsch

Français

Español

Italiano

Supplement

This equipment is in conformity with the provisions and protection requirements of the corresponding European Directives. This equipment is designed for professional video appliances and can be used in the following environments:

- Residential (including both of the location type class 1 and 2 found in IEC 1000-2-5)
- Commercial and light industrial (including, for example, theatres)
- Urban outdoors (based on the definition of location type class 6 in IEC 1000-2-5)

This apparatus is designed for rack mounting or is used close to other apparatus.

In order to keep the best performance and furthermore for electromagnetic compatibility we recommend to use cables not exceeding the following lengths:

Port	Cable	Length
LINE IN	Coaxial Cable	10 meters
LINE OUT	Coaxial Cable	10 meters
VIDEO MONITOR OUT	Coaxial Cable	10 meters
COMPONENT Y IN	Coaxial Cable	10 meters
R-Y IN	Coaxial Cable	10 meters
B-Y IN	Coaxial Cable	10 meters
COMPONENT Y OUT	Coaxial Cable	10 meters
R-Y OUT	Coaxial Cable	10 meters
B-Y OUT	Coaxial Cable	10 meters
Y/C IN	Exclusive Cable	10 meters
Y/C OUT	Exclusive Cable	10 meters
SYNC IN	Coaxial Cable	10 meters
TIMECODE IN	Coaxial Cable	10 meters
TIMECODE OUT	Coaxial Cable	10 meters
AUDIO IN	Exclusive Cable	10 meters
AUDIO OUT	Exclusive Cable	10 meters
AUDIO MONITOR OUT	Exclusive Cable	10 meters
SERIAL REMOTE	Cable with RM-G30	2 meters
REMOTE1(RS-422)	Exclusive Cable	5 meters
REMOTE2(JVC BUS)	Exclusive Cable	10 meters
DV IN/OUT	Exclusive Cable	4 meters
MIC	Cable with Microphone	5 meters
PHONES	Cable with Headphones	5 meters
XLR AUDIO	Exclusive Cable	10 meters
DC 12V	Exclusive Cable	1.9 meters

The inrush current of this apparatus is 11.5 amperes.

Caution:

- Where there are strong electromagnetic waves or magnetism, for example near a radio or TV transmitter, transformer, motor, etc., the picture and sound may be disturbed. In such a case, please keep the apparatus away from the sources of the disturbance.
- When the RM-G800 remote controller is used, the counter, etc. may malfunction due to interference generated by the peripheral equipment. In this case, consult your nearest JVC dealer.

SAFETY PRECAUTIONS

Warning Notice

FOR YOUR SAFETY (Australia)

1. Insert this plug only into effectively earthed three-pin power outlet.
2. If any doubt exists regarding the earthing, consult a qualified electrician.
3. Extension cord, if used, must be three-core correctly wired.

IMPORTANT (In the United Kingdom)

Mains Supply (AC 230 V ~)

WARNING – THIS APPARATUS MUST BE EARTHED

The wires in this mains lead are coloured in accordance with the following code;

GREEN-and-YELLOW : EARTH
BLUE : NEUTRAL
BROWN : LIVE

As the colours of the wires in the mains lead of this apparatus may not correspond with the coloured markings identifying the terminals in your plug, proceed as follows.

The wire which is coloured GREEN-AND-YELLOW must be connected to the terminal in the plug which is marked with the letter E or by the safety earth symbol \perp or coloured GREEN or GREEN-AND-YELLOW. The wire which is coloured BLUE must be connected to the terminal which is marked with the letter N or which is coloured BLACK. The wire which is coloured BROWN must be connected to the terminal which is marked with the letter L or coloured RED.

POWER SYSTEM

Connection to the mains supply

This unit operates on voltage of 220 V to 240 V AC, 50 Hz/60 Hz.

WARNING:

TO REDUCE THE RISK OF FIRE OR ELECTRIC SHOCK, DO NOT EXPOSE THIS APPLIANCE TO RAIN OR MOISTURE.

CAUTION

To prevent electric shock, do not open the cabinet. No user serviceable parts inside. Refer servicing to qualified service personnel.

Note:

The rating plate and the safety caution are on the rear of the unit.

The OPERATE button does not completely shut off mains power from the unit, but switches operating current on and off.

WARNING

It should be noted that it may be unlawful to re-record pre-recorded tapes, records, or discs without the consent of the owner of copyright in the sound or video recording, broadcast, or cable programme and in any literary, dramatic, musical or artistic work embodied therein.

Caution for AC Mains Lead

FOR YOUR SAFETY PLEASE READ THE FOLLOWING TEXT CAREFULLY.

This product is equipped with 2 types of AC cable. One is for continental Europe, etc. and the other one is only for U.K.

Appropriate mains cable must be used in each local area, since the other type of mains cable is not suitable.

FOR CONTINENTAL EUROPE, ETC.

Not to be used in the U.K.

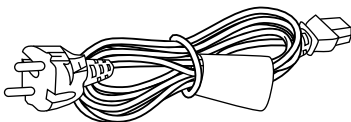

FOR U.K. ONLY

If the plug supplied is not suitable for your socket outlet, it should be cut off and appropriate one fitted.

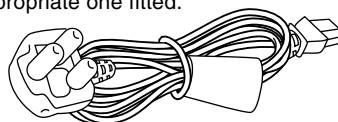

**Thank you for purchasing our
DV Video Cassette Recorder
BR-DV6000.**



As this is a DV-format video cassette recorder, video cassettes with the **DV** or **Mini DV** logo can be used with it.

DVCAM cassettes can be recorded in the DV format.

- In order to prevent crumpling due to tape slack, do not perform important recording within the first and last 2 – 3 minute-run of the tape.
- Recorded video (sound) is meant for personal entertainment only and must not be used for other purposes without the prior consent of the copyright owner.
- JVC shall not guarantee the quality of recording and playback should BR-DV6000 fail to function normally due to defects, either of the unit itself or the video cassette tapes.

MAIN FEATURES

- **DV format**
High picture and sound quality by digital technology.
- **Compatible mechanisms for standard/mini DV cassette tapes**
It records on and plays back DV cassette tapes of the standard and mini size. (SP mode only)
Recording in the DV format can be performed on DVCAM cassette tapes.
- **Tapes recorded in DVCAM format can be played back on the BR-DV6000, detection is automatic.**
- **Equipped with composite, component and Y/C input & output terminals.**
- **Equipped with DV IN/OUT terminals. (IEEE1394)**
It can exchange digital signals with IEEE1394-compatible devices.
- **Both NTSC and PAL signals supported**
Playing back NTSC tapes or recording NTSC signals from the DV input is possible on the BR-DV6000E.
Please select NTSC on PB/DV IN menu.
For analog signal input, only PAL is supported.
- **RS-422A and JVC bus interface supported**
RS-422A-compatible edit controller RM-G820 and JVC bus-compatible edit controller RM-G800 can be used for editing.
- **Optionally, the RS-232C interface can be used.**
- **Recording and playback of time codes**
- **Time code I/O terminal**
Slave lock is allowed if BR-DV6000 is connected to an external time code generator.
- **SYNC IN terminal**
External synchronization signals can be input.
- **Audio-dubbing function (after-recording)**
If the sampling frequency is 32kHz, audio dubbing can be performed into CH3 and CH4 (except during DV input).
- **Backup recording function**
With the combined use of other DV machines, long-time continuous recording is possible.
- **Using the SERIAL REMOTE OUT terminal or DV terminal, dubbing with other recorders is possible only with playback operation by BR-DV6000. (Replication function)**
- **Equipped with a 2.5-inch color LCD**
Images, status display and menu display can be viewed.
- **Multi-cue up**
Up to 5 points of the tape position can be registered and cued up.
- **Index/blank search function**
It can search for positions where index signals are recorded and unrecorded parts.
- **Repeat play function**
There are 3 types of repeat function.
(INDEX/ VIDEO END/ TAPE END)
- **Recording/playback with an external timer**
- **With the use of the network board SA-DV6000 (sold separately), image and audio streaming data can be recorded on a CF card, and with a LAN card, streaming data can be transmitted to a PC.**
- **With the XLR IN board SA-X61U or XLR OUT board SA-X62U (sold separately), audio input/output via the XLR terminal is possible.**

Table of Contents

INTRODUCTION

Remarks of usage	6
Regular maintenance	7
Cleaning tape	8
Cassette tape	8
Condensation	9

NAMES AND FUNCTIONS OF PARTS

Front panel	10
Rear panel	16

ON-SCREEN DISPLAY

On-screen display	20
Status display	21
Status/Event display	23
Alarm display	24
LCD display	26

CONNECTION

Connecting video signals	28
Connecting audio signals	30
Connecting to editing system	32
Connecting with serial remote terminals	34
Connecting the AC adapter	35

PREPARATION

Turning on/off the power	36
Operation method (main unit/remote controller) and operation lock mode	37
Loading/Ejecting cassette	38
Setting the LCD display	39
Setting/Displaying date and time	40

RECORDING

Setting	42
Recording procedure	43
Audio dubbing	44
Backup recording function	45
Recording with serial remote terminals	46
External timer recording	47

PLAYBACK

Setting	48
Basic playback procedure	49
Special playback functions	50
Search function	52
Repeat playback	53
Multi cue-up	54
External timer playback	56
Dubbing with another machine using the SERIAL REMOTE OUT/DV terminals	57

TIME CODE

Displaying the time code	58
Presetting the time code	59
Recording the time code	60
Playing back the time code	63

EDIT

Editing with an RS-422A/JVC bus edit remote controller	64
Using a non-linear editing system	68

MENU SCREENS

Structure of the Menu screens	69
Setting the menus	70
Description of the Menu screens	72

RS-232C INTERFACE

Command tables	84
RS-232C specifications	85
RS-232C commands	86

OTHERS

Warning display	97
Troubleshooting	99
Checking the hour meter	100
Optional devices	101
Installing SA-K46U RS-232C interface board	102
Specifications	103

INTRODUCTION

Remarks of usage

■ Place of storage and use

Avoid storing or using this VCR in the following places:

- Excessively hot or cold places beyond the allowable temperature for operation (5°C – 40°C).
- Humid or dry places beyond the allowable humidity range for operation (30% – 80% RH).
- Dusty or sandy places.
- Places exposed to oil, smoke or steam, such as the kitchen vicinity.
- Intensely vibrating or unstable places.
- Places prone to condensation.
- Places that generate strong magnetic fields, e.g., near a transformer or motor.
- Places near devices that generate electric waves, e.g., a transceiver or mobile phone.
- Places that generate X-ray radiation or corrosive gases.

■ Handling the unit

- Do not place heavy objects on the unit, like a monitor or TV.
- Do not insert foreign objects into the cassette slot.
- Mind your finger when loading a cassette tape.
Be careful not to get your fingers clamped when loading the cassette to prevent injury.
- Place this unit out of reach of young children to prevent injury as fingers may get clamped while a cassette tape is being loaded.
- Do not block the ventilation openings.
- Avoid strong impact to the unit. Do not drop the unit.
- Remove the cassette tape from the cassette slot when transporting the unit.
- Remove the AC adapter to save energy when the unit is not in use.

■ Maintaining the unit (Turn off the power before performing maintenance work.)

Wipe the unit with a soft cloth.

Do not wipe it with thinner or benzene as it may melt or tarnish the unit surface.

For stubborn stains, use water-diluted neutral detergent and then wipe it dry.

■ Use the supplied AC adapter to connect the unit to a power source.

■ Use the supplied power cord.

Using a different type or damaged cord may cause fire or electric shock.

■ Do not use the supplied power cord for other models.

■ LCD screen

The LCD screen is designed and manufactured with high-precision technology.

Minute black dots may appear or bright (red, blue and white) dots are permanently lit. This phenomenon is not a product defect and the dots are not recorded.

Regular maintenance

This unit uses consumables or components that will wear off. If a worn-out or deteriorated component continues to be used, it may cause the unit to break down. To prevent this, perform routine maintenance using the head-cleaning tape. With the head-cleaning tape alone, however, the entire tape-winding mechanism cannot be completely cleaned.

Perform regular maintenance of the components as shown below.

Regular maintenance

The tasks of maintenance involved are similar to that of replacing the engine oil or tire of a car.

Depending on the number of usage hours, inspect or replace the components as follows:

Number of hours	500H	1000H	1500H	2000H	4000H
Drum assembly (including head)	○	○	○	●	●
Head cleaner	☆	●	☆	●	●
Tape guide, roller	○	☆	☆	●	●
Reel disk, tension bands	—	☆	—	●	●

- : Inspection
- : Cleaning, inspection and adjustment
- ☆ : Cleaning and inspection; Replacement if necessary
- : Replacement

Work and frequency of maintenance depend on the environment and usage. The above information serves only as a guide.

Usage Time

: You can check the drum usage time with the hour meter display. For details, refer to page 100, "Checking the hour meter."

Maintenance consultation

: For details on the maintenance plan and fee, consult with your JVC-authorized service agent.

Head cleaning

- Recording or playing back with a dirty head will result in block noise or disrupted sound. Perform regular head cleaning to maintain superior image and sound quality.
- If the head is dusty, "HEAD CLEANING REQUIRED!" will be displayed on the monitor when this unit plays a tape.



Block Noise

HEAD CLEANING REQUIRED!

- For information on how to use the head cleaning tape and the relevant remarks, refer to page 8, "Cleaning tape".

INTRODUCTION

Cleaning tape

Use a JVC cleaning tape.
Follow the instructions below for using the cleaning tape.

1. Run the tape for 10 seconds in the PLAY mode. (Thereafter, it stops automatically and enters the STOP mode.)
 - After loading the cleaning tape, press the PLAY button.
2. For a single cleaning session, it can be repeated up to 4 times.
3. Refer to the following table as a guide for cleaning.

Notes

- Under low humidity conditions, (10% RH to 30% RH), perform head cleaning at intervals of half of the periods stated in the table.
- If an M-DV80 tape is used immediately after cleaning, the message, "HEAD CLEANING REQUIRED!" may not disappear. It does only after the tape has run for some time.
- Use the cleaning tape at room temperature (10°C to 35°C).
- Instructions for using the cleaning tape stated on a sheet inside its storage case may be different in part from those stated here. Follow the instructions in this manual.

Operating environment	Low temperature 5°C to 10°C	Room temperature 10°C to 35°C	High temperature 35°C to 40°C
Frequency of cleaning	1 to 2 times every 5 hours	1 to 2 times every 20 to 30 hours	1 to 2 times every 5 hours

Cassette tape

BR-DV6000 can record onto and playback standard DV and mini DV cassette tapes (for SP mode only).

Use the following JVC cassettes with the **DV** or the **Mini DV** logo.

- | | |
|--------------------------------|----------------------------|
| • Standard DV cassettes | • Mini DV cassettes |
| LA-DV276 | M-DV63PRO |
| LA-DV186 | M-DV60 |
| LA-DV124 | M-DV30 |

Memo

- DVCAM cassette can be recorded in the DV format.
- Tapes recorded in the DVCAM format can be played (SP Mode).
- M-DV80 cassettes (Mini DV 80min tape) cannot be used with this unit.

Erasure prevention

DV cassettes have a safety slide at the back to prevent accidental erasure.

- To prevent accidental erasure of important records, push the slide to the "SAVE" position.
- To record, push the slide to the "REC" position.

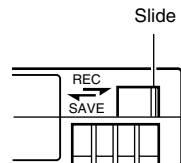

Remarks on the use of tape

- Do not load the videotape in the wrong direction.
- Store the tape only after it has been fully rewound, so as to avoid damaging the tape.
- Store the cassette in places low in humidity, well-ventilated and fungus-proof.
- When a cassette tape is used repeatedly, noise may increase due to e.g., dropout, etc. hence affecting its performance. Do not use dirty or damaged tapes as they will shorten the life span of the rotation head.

■ For recording and storing videotapes in the best condition

Observe the following instructions for the best recording and storage of videotapes.

- Take care of the conditions of handling videotapes.

It is recommended that you record and store videotapes in the environment below.

	Recording	Storage	
		Short period (Up to 10 years)	Long period (Over 10 years)
Temperature	17°C to 25°C	15°C to 23°C	15°C to 19°C
Humidity	30% to 70%	40% to 55%	25% to 35%
Hourly temperature change	Less than 10°C	—	—
Hourly humidity change	Less than 10%	—	—

- Do not leave the videotapes neglected for a long period.

If videotapes are left wound for a long period of time, it may result in distortion of the tape. Also it may cause tape-to-tape adhesion (known as blocking). It is recommended that videotapes be unspooled and rewound once a year for refreshing.

- When tapes are not in use, store them in cases and on end.

Storage cases protect videotapes from humidity, dust and ultraviolet. Keep tapes in cases and do not store them lying flat. When housed in a horizontal position, pressure from other tapes can cause distortions and deformations of the tape edges.

Condensation

- When this unit is moved from a cold to a warm place abruptly, the vapor in the warm air will come into contact with the head drum or the tape guides, which are not warmed enough. When chilled, the vapor turns into droplets of water. This state is known as condensation. When condensation occurs, the videotape adheres to the head drum or the tape guides and will be damaged.

- Condensation occurs on this unit in the following circumstances:

- * It is moved abruptly from a cold place to a warm place.
- * It is used in a place immediately after the heater has been turned on, or when cold breeze from an air-conditioner blows onto it.
- * It is used at a place of high humidity.

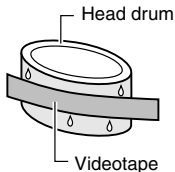

When a cassette tape is loaded, do not transport e.g., from a cold outdoor place to a warm room thus subjecting the unit to drastic temperature changes. After moving the unit, do not use it until the inner mechanism stabilizes.

- When condensation occurs, the monitor displays the following warning:

CONDENSATION ON DRUM

Leave the unit with the power ON and wait until the WARNING message disappears.

- Prevention of condensation

When transporting BR-DV6000 from a cold to a warmer place abruptly, first remove the cassette tape. Then place BR-DV6000 in a plastic bag and seal it before transporting.

Take out BR-DV6000 from the sealed plastic bag only after it has the same temperature as the surroundings.

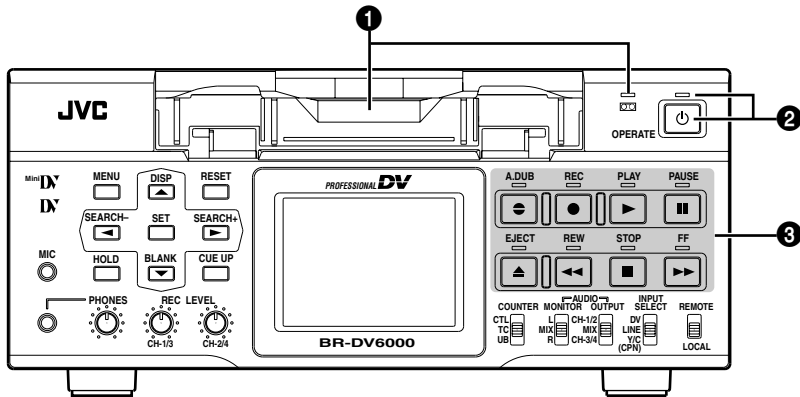

1 Cassette loading slot/LED

- For loading a cassette into or unloading it from the slot.
Insert a standard DV cassette or a mini DV cassette. (Page 38)
- When BR-DV6000 is in the OPERATE OFF state and a cassette is loaded, it changes to the OPERATE ON state.
- With a cassette loaded, the LED lights up in green.
When a cassette is being loaded or ejected, the LED flashes.

2 [OPERATE] button/LED

- Press this button to turn on the power and BR-DV6000 becomes ready for operation. (Operate ON)
Press this button again when BR-DV6000 is already on to turn off the power. (Operate OFF)
- OPERATE LED lights up as follows.
Operate ON : the green LED lights up
Operate OFF : the red LED lights up
VCR error : the red LED blinks

Memo

- If DC IN MODE in the SYSTEM MENU screen is set to "OPE ON" or the Timer Switch is set to "REC" or "PLAY" and power is supplied to the DC IN terminal located on the rear panel, BR-DV6000 goes into the OPERATE ON state even if this button is not pressed.
- Even after the power is turned off with this button, BR-DV6000 is live with a small amount of electricity.
Therefore, if BR-DV6000 is not to be used for a long period of time, please remove the AC adapter to save energy.

3 Operation buttons

■ [A. DUB] Audio dubbing button/LED

- Press this button for audio dubbing (after-recording).
For audio dubbing, set AUDIO MODE in the AUDIO MENU screen to "32K".
The sound produced by the MIC terminal or the AUDIO IN terminal is recorded on channels CH3 and CH4.
- During audio dubbing, the red A. DUB LED lights up.
- If the INPUT SELECT switch is set to DV, audio dubbing cannot be performed. (Page 44 "Audio Dubbing")

■ [REC] button/LED

- Hold down this button and press the PLAY button to start recording. During recording, the red LED lights up.
- Hold down this button and press the PAUSE button to pause recording.
- If this button is pressed during recording, an index signal is recorded on the tape (when INDEX WRITE in the SYSTEM MENU screen is set to ON).
- When this button is pressed in the STOP mode, the time code generator value can be checked while the button is being held down. If TC DUPLICATE Menu is set to AUTO, the time code, date and time of the DV input can be checked.
- If this button is pressed during playback, the input signal can be checked while the button is held down. (EE check)
EE check is not available for DV signal input.

■ [PLAY] button/LED

- Press this button to start playing back a tape. During playback, the green LED lights up.
- When recording is paused, press this button to resume recording.
- When audio dubbing is paused, press this button to resume audio dubbing.

■ [PAUSE] button/LED

- During recording, press this button to pause it.
- In the PLAYBACK or STOP mode, press this button to enter the STILL mode. In the RECORDING PAUSE or STILL mode, the green LED lights up.
- When BR-DV6000 is in the STILL mode, hold down the A.DUB button and press this button to enter into the audio-dubbing pause mode.
- When BR-DV6000 is in the STILL mode, press this button for frame advance playback.

Memo

Still images or images in frame advance can be selected with STIL/FADV of the SYSTEM (1/2) MENU screen.

■ [FF] button/LED

- When BR-DV6000 enters the STOP mode, press this button to fast-forward the tape.
- When BR-DV6000 is in the PLAYBACK or STILL mode, press this button for fast-forward playback. The fast forward playback speed can be changed by pressing the SEARCH +/▶ button **18** or the SEARCH -/◀ button (when “◀,▶” KEY FUNC in the SYSTEM (1/2) Menu screen is set to VAR). (☞ Page 50 “Search Mode”)
- Hold down the PLAY button and press this button to perform playback in the forward direction at 1.07 times the normal speed. At this state, if the PLAY button is released first, the playback continues at 1.07 times the normal speed.

If this button is released first, it plays back at the normal speed.

- During fast-forwarding or fast-forward playback, the LED lights up in green.

■ [STOP] button

- Press this button to stop operation.
- When BR-DV6000 is in the STANDBY OFF mode, press this button to enter the STANDBY ON mode.

Memo

There are two stop modes.

- STANDBY OFF: For protecting the tape and the drum, the drum does not rotate.
- STANDBY ON: The drum rotates so that it starts up faster after BR-DV6000 moves into another mode.

■ [REW] button/LED

- When BR-DV6000 enters the STOP mode, press this button to rewind the tape.
- When BR-DV6000 is in the PLAYBACK or STILL mode, press this button for reverse playback. The rewind playback speed can be changed by pressing the SEARCH +/▶ button **18** or the SEARCH -/◀ button (when “◀,▶” KEY FUNC in the SYSTEM (1/2) Menu screen is set to VAR). (☞ Page 50 “Search Mode”)

- Hold down the PLAY button and press this button to perform playback in the reverse direction at 0.9 times the normal speed. At this state, if the PLAY button is released first, the playback continues at 0.9 times the normal speed.

If this button is released first, it plays back at the normal speed.

- During rewinding or rewind playback, the LED lights up in green.

■ [EJECT] button

- Press this button to eject the cassette.

Memo

- It takes about 6 seconds for the cassette to be ejected.
- The cassette can be ejected even when BR-DV6000 is in the OPERATE OFF mode. After the eject action is completed, BR-DV6000 returns to the OPERATE OFF mode.

NAMES AND FUNCTIONS OF PARTS

- Front panel - (continued)

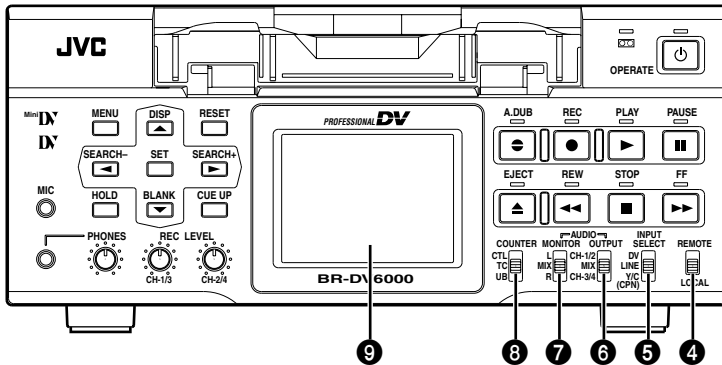

4 [REMOTE/LOCAL] switch

This switch is used to select how BR-DV6000 is to be operated.

LOCAL : Use this setting if BR-DV6000 is to be controlled with the key operation of the unit.

REMOTE : Use this setting if BR-DV6000 is to be controlled using the edit controller connected to the REMOTE 1 (9-PIN) terminal or REMOTE 2 (12-PIN) terminal.

When it is set to REMOTE, settings can be performed at the REMOTE (1/2) MENU screen to enable/disable operation via the 9-PIN or 12-PIN REMOTE terminal.

The 9-PIN REMOTE 1 terminal can be selected using REMOTE SEL 9 PIN while the 12-PIN REMOTE 2 terminal can be selected with REMOTE SEL JVC.

Memo

- To control BR-DV6000 with the SERIAL REMOTE terminal or DV terminal, this switch setting can be set up with REMOTE SEL SERIAL or REMOTE SEL DV in the REMOTE (1/2) MENU screen. (Page 75)
- If it is set to REMOTE, the buttons that can be operated from the unit are selectable from LOCAL FUNCTION in the REMOTE (1/2) MENU screen.

5 [INPUT SELECT] switch

This switch is used to select input signals.

DV : For DV signals of the DV IN/OUT terminal (IEEE1394)

LINE : For inputting the composite images of the LINE IN terminal and analog audio signals.

Y/C (CPN) : For inputting the Y/C separate video signal of the Y/C IN terminal and the component video signal of the COMPONENT IN terminal. The selection of the Y/C separate signal or the component video signal can be done with VIDEO INPUT SEL in the VIDEO MENU screen. For audio, analog sound is input.

Note

Switching is invalid during recording.

6 [AUDIO OUTPUT] switch

Use this switch to select the audio channel from the headphone terminal and the AUDIO OUT terminal located on the rear panel.

This switch is valid in the following conditions.

- During playback of tapes recorded in the 32k audio mode
- In the EE mode for DV input in the 32k audio mode
- During audio dubbing

CH-1/2 : For outputting the sound of the channels CH1 and CH2.

MIX : For outputting the mixed sound of CH1 and CH3 from the CH-1/3 AUDIO OUT terminal and the mixed sound of CH2 and CH4 from the CH-2/4 AUDIO OUT terminal.

CH-3/4 : For outputting the sound of CH3 and CH4.

Memo

- For the MIX setting, noise is sometimes generated. If it occurs, set it to CH-1/2 or CH-3/4.
- In the 48 K audio mode, it is fixed at channels CH1 and CH2 regardless of the setting of the switch.

7 [AUDIO MONITOR] switch

Use this switch to select the audio channel for output signals from the headphone terminal and the AUDIO MONITOR terminal located on the rear panel.

The output signal of the AUDIO MONITOR OUT terminal is monaural.

L : For outputting the sound of CH1.

MIX : For outputting the mixed sound of CH1 and CH2.

R : For outputting the sound of CH2.

Memo

In the following conditions, if this switch and the 6 AUDIO OUTPUT switch are used in combination, the AUDIO MONITOR OUT outputs the sounds listed as in the following table.

- During playback of tapes recorded in the 32 K audio mode
- In the EE mode for DV input in the 32 K audio mode
- During audio dubbing

AUDIO switch		MONITOR OUT output channel
MONITOR	OUTPUT	
L	CH-1/2	CH1
	MIX	CH1/3 mix
	CH-3/4	CH3
MIX	CH-1/2	CH1/2 mix
	MIX	CH1/2/3/4 mix
	CH-3/4	CH3/4 mix
R	CH-1/2	CH2
	MIX	CH2/4 mix
	CH-3/4	CH4

8 [COUNTER] switch

The switch changes the contents of the counter display of the 9 LCD and the monitor.

CTL : It displays the counter in hour, minute, second and frame based on CTL (control signal).

TC : It displays the time code data.

UB : It displays the user's bit (UB).

9 LCD

■ In the playback, still or search mode, it displays the playback image.



In the recording, recording pause, stop, fast-forwarding or rewinding mode, it displays the input image.

■ The following information is also displayed.

- Various types of information (status display), e.g., operation mode, date/time, counter
- Menu screen
- Warning display

(For details,  Page 20)

Memo

- Use the 19 DISP button to enable/disable the LCD display and the display style.
- LCD-related settings, e.g., brightness adjustment of the LCD, are performed in the DISPLAY MENU screen.
( Page 39 "Setting the LCD display")
( Page 82 "DISPLAY MENU screen")
- If the same image pattern is kept displayed on the LCD display for a prolonged period of time, "ghosting", the permanent etching of a pattern on a display screen, may occur. To prevent this, turn off the LCD display when it is not in use.

NAMES AND FUNCTIONS OF PARTS

- Front panel - (continued)

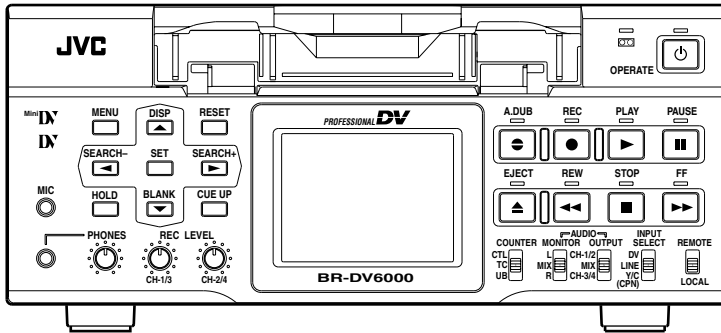

10 [REC LEVEL] Volume for audio recording level for CH1/3 and CH2/4

Use the switch to adjust the audio recording level for CH1 and CH2.

During audio dubbing, the audio recording level for CH3 and CH4 can be adjusted with this switch.

Memo

- During DV input, the volume control is not effective.
- During MIC input, only the volume for CH1/3 REC LEVEL is valid.

11 [PHONES] terminal

This is the mini jack terminal for connecting to the headphone. (Stereo ϕ 3.5)

- When BR-DV6000 plays back tapes recorded in the 32 kHz mode, the audio channel for outputting from this terminal is selected with the 8 AUDIO OUTPUT switch.

12 [PHONES] Headphone volume

Use this switch to adjust the output level of the PHONES terminal.

Both channels are adjusted at the same time.

13 [MIC] terminal

This is the mini jack terminal for monaural microphone input.

To input sound from a microphone, set the INPUT SELECT switch to LINE or Y/C (CPN).

If a microphone is connected, sound for the AUDIO IN terminal located on the rear panel cannot be input.

The sound of the microphone is recorded to CH1/CH2 in the recording mode and CH3/CH4 in the audio-dubbing mode.

14 [HOLD] button

If this button is pressed in the LCD enlarged display mode, the time code preset screen will be displayed on the LCD. When the time code preset screen is displayed, press this button to return to the normal display.

(☞ Page 59 "Presetting time code")

15 [MENU] button

If this button is pressed when BR-DV6000 is in the STOP/STILL mode or when no cassette is loaded, the menu is displayed on the LCD or the monitor connected to the VIDEO MONITOR OUT terminal.

When the menu is displayed, press this button to return to the normal display.

(☞ Page 70 "Setting the menu")

16 [RESET] button

- To reset the CTL counter display to "00", press this button.

- If this button is pressed when the time code preset screen is displayed, all the digits of the time code or the user's bit are reset to "00".

- When the Multi Cue-up screen is displayed, press this button to clear the registered cue-up points.

17 [CUE UP] button

When the 8 COUNTER switch is set to TC, press this button to display the Multi Cue-up screen on the monitor or LCD.

When the Multi-Cue-up screen is displayed, press this button to start searching the selected tape position.

(☞ Page 54 "Multi Cue-up")

18 Special functions/Setting buttons

The following buttons have different functions depending on whether the normal screen or the setting screen is displayed.

Setting screens:

Menu, Date/Time setting, Time code preset and Multi Cue-up

■ [DISP/▲] button

- During normal display, this button is used to enable/disable the LCD or select display style. When this button is pressed, the LCD display changes in the following manner.
Enlarged character display → Image/enlarged character display → Image/character display → Image display → No display → Enlarged character display...
- When the setting screen is displayed, this button is used to select the items or setting values.

■ [BLANK/▼] button

- When BR-DV6000 is in the stop mode, press this button to start blank search. It searches the unrecorded part of the tape and goes into the still mode.
(☞ Page 52 "Blank search")
- When the setting screen is displayed, this button is used to select the items or setting values.

■ [SEARCH+/▶] button

- During normal display, the function of this button can be selected using "◀,▶" KEY FUNC in the SYSTEM (1/2) Menu screen.
If it is set to VAR, the searching speed increases if this button is pressed during a search operation.
(☞ Page 50 "Search mode")
If it is set to INDEX, press this button to start forward index search. This function is not effective during recording or recording pause.
(☞ Page 52 "Index search")
- When the setting screen is displayed, this button is used to select items or setting digits.

■ [SEARCH-/◀] button

- During normal display, the function of this button can be selected using "◀,▶" KEY FUNC in the SYSTEM (1/2) Menu screen.
If it is set to VAR, the searching speed decreases if this button is pressed during a search operation.
(☞ Page 50 "Search mode")
If it is set to INDEX, press this button to start reverse index search. This function is not effective during recording or recording pause.
(☞ Page 52 "Index search")
- When the setting screen is displayed, this button is used to return to the previous menu or select setting digits.

■ [SET] button

- When the Menu screen, Date/Time setting screen or the Multi Cue-up screen is displayed, press this button to confirm the setting value.
- When the time code preset screen is displayed, press this button to preset the selected time codes or user's bit to the time code generator.

NAMES AND FUNCTIONS OF PARTS

- Rear panel -

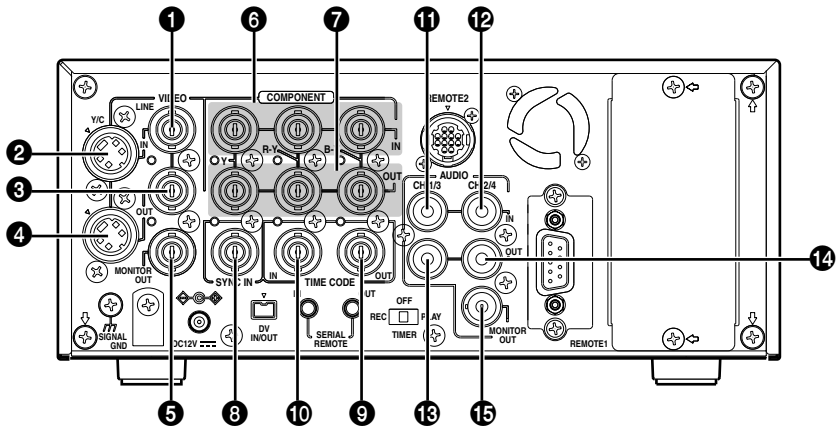

1 [VIDEO LINE IN] terminal (BNC)

This is the input terminal for composite video signals.

- To input video via this terminal, set the INPUT SELECT switch located on the front panel to "LINE".

2 [VIDEO Y/C IN] terminal (4-PIN)

This is the input terminal for Y/C separate video signals.

- To input video via this terminal, the following settings are required.

Set VIDEO INPUT SEL in the VIDEO Menu screen to "Y/C".

Set the INPUT SELECT switch located on the front panel to "Y/C (CPN)".

- When wide-screen ID signals are input, the wide-screen ID signal is recorded.

3 [VIDEO LINE OUT] terminal (BNC)

This is the output terminal for composite video signals.

4 [VIDEO Y/C OUT] terminal (4-PIN)

This is the output terminal for Y/C separate video signals.

- When tapes that have recorded wide-screen signals are played back, the wide-screen ID signal is output.

5 [VIDEO MONITOR OUT] terminal (BNC)

This terminal is for connecting to a monitor-TV.

- It outputs composite video signals.
- It displays the Menu setting screen, Date/Time setting screen and warning information.
- If DISPLAY in the DISPLAY Menu screen is set to "ON" or "AUTO", information will be displayed on-screen, e.g., the operation mode, date/time and counter. (Page 20)

6 [COMPONENT IN] terminal (BNC × 3)

This is the input terminal for component video signals (Y/R-Y/B-Y).

- To input video of this terminal, the following settings are required.

Set VIDEO INPUT SEL in the VIDEO Menu screen to COMPONENT.

Set the INPUT SELECT switch located on the front panel to "Y/C (CPN)".

7 [COMPONENT OUT] terminal (BNC × 3)

This is the output terminal for component video signals (Y/R-Y/B-Y).

Memo

Whether or not to enable SET UP for analog signals (composite, Y/C separate and component signals) can be selected with SET UP in the VIDEO Menu screen (for NTSC only).

8 [SYNC IN] synchronization input terminal (BNC)

This is the terminal for inputting reference synchronization signals from an external source. For external synchronization signals, input composite video signals of 1V (p-p) or lower (e.g., black burst signal).

(☞ Page 29 “Synchronization signal”)

9 [TIME CODE IN] terminal (BNC)

This is the EBU-compliant time code input terminal.

It is for connecting to an external time code generator.

For external time code signals, use those that synchronize with the video signals.

- To input external time codes, set TCG SOURCE of the TC/UB/CLOCK Menu to “EXTERNAL”.

10 [TIME CODE OUT] terminal (BNC)

This is the EBU-compliant time code output terminal.

It outputs time codes recorded on the tape during playback and data generated by the time code generator during recording.

With the COUNTER switch set to CTL, time code is not output.

11 [CH1/3 AUDIO IN] terminal (RCA)

Use this terminal to input analog audio signals.

To enable audio input via this terminal, set the INPUT SELECT switch located on the front panel to “LINE” or “Y/C (CPN)”.

Usually, analog signals are recorded on CH1.

For audio dubbing, they are recorded on CH3.

12 [CH2/4 AUDIO IN] terminal (RCA)

Use this terminal to input analog audio signals.

To enable audio input via this terminal, set the INPUT SELECT switch located on the front panel to “LINE” or “Y/C (CPN)”.

Usually, analog signals are recorded on CH2.

For audio dubbing, they are recorded on CH4.

Memo

If the AUDIO IN terminal and the MIC terminal located on the front panel are used simultaneously, the MIC terminal will precede.

13 [CH1/3 AUDIO OUT] terminal (RCA)

Use this terminal to output analog audio signals.

In the 48k audio mode, it outputs the sound of CH1.

When audio dubbing is paused, it outputs the sound of CH3.

In the 32k audio mode, the sound is selected with the AUDIO OUTPUT switch located on the front panel.

(Refer to the table below.)

14 [CH2/4 AUDIO OUT] terminal (RCA)

Use this terminal to output analog audio signals.

In the 48k audio mode, it outputs the sound of CH2.

When audio dubbing is paused, it outputs the sound of CH4.

In the 32k audio mode, the sound is selected with the AUDIO OUTPUT switch on the front panel.

(Refer to the table below.)

Memo

In the following modes, the channel that receives output signals from the AUDIO OUT terminal can be selected with the AUDIO OUTPUT switch.

- During playback of tapes recorded in the 32k audio mode
- During audio dubbing
- In the EE mode for DV input in the 32k audio mode

AUDIO OUTPUT switch	AUDIO OUT terminal	
	CH1/3	CH2/4
CH1/2	CH1	CH2
MIX	CH1, 3 mix	CH2, 4 mix
CH3/4	CH3	CH4

15 [AUDIO MONITOR] terminal (RCA)

This terminal is for connecting to a monitor TV and monitors the sound from its speakers.

Monaural sounds are output.

- The audio channel to be monitored can be selected with the AUDIO MONITOR switch located on the front panel.

For audio channels that receive output signals from this terminal in the 32k audio mode, refer to the table in page 13.

NAMES AND FUNCTIONS OF PARTS

- Rear panel - (continued)

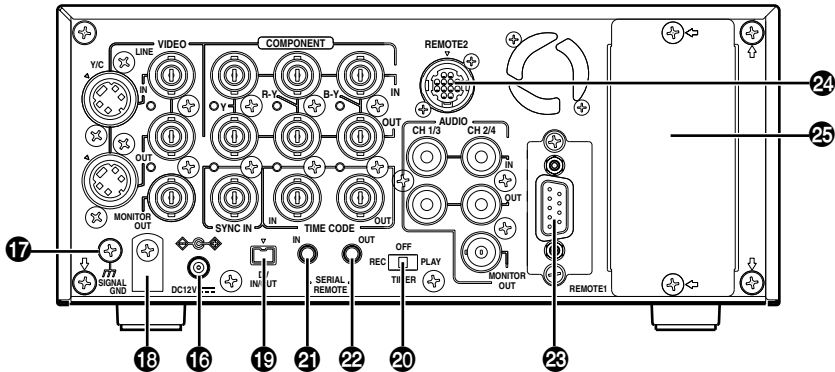

16 DC power input terminal (2-PIN)

This terminal is for inputting DC 12 V. Connect the DC power cord of the supplied AC adapter.

Memo

- When power is supplied to this terminal, the OPERATE indicator located on the front panel lights up. (The indicator turns red when BR-DV6000 is in the OPERATE OFF state)
- Whether to set BR-DV6000 to enter the OPERATE ON mode or OPERATE OFF mode when power is supplied to the terminal can be selected with DC IN MODE in the SYSTEM (2/2) Menu screen.
- If the 20 TIMER switch on the rear panel is set to "REC" or "PLAY", recording or playback will be automatically started when power is supplied to the terminal. (Timer recording/playback)

17 [SIGNAL GND] terminal

This is the grounding terminal for signals.

18 DC power cord clamp

Use this clamp to fasten the DC power cord.

19 [DV IN/OUT] terminal

This is the input/output terminal for IEEE1394-compliant digital signals. It is for connecting to video equipment with a DV terminal.

- To enable signal input via this terminal, set the INPUT SELECT switch located on the front panel to "DV".
- Signals that come from this terminal are output regardless of the setting of the INPUT SELECT switch.
- If REPLICATION of the SYSTEM (2/2) Menu is set to DV, the REC command is output from this terminal when BR-DV6000 begins playback. (REPLICATION mode)
- Set PB/DV IN in the SYSTEM(2/2) Menu screen according to the signal format to be input to this terminal. (NTSC or PAL)

20 [TIMER] recording/playback switch

This switch is for setting BR-DV6000 to start timer recording or timer playback when power is supplied to the 16 DC power input terminal according to an external timer.

OFF : No timer recording or timer playback.

REC : When power is supplied, BR-DV6000 starts recording automatically. (Timer recording)

PLAY : When power is supplied, BR-DV6000 starts playback automatically. (Timer playback)

Memo

- If the TIMER switch is set to "REC" or "PLAY", BR-DV6000 automatically enters the OPERATE ON mode upon DC power on even when DC IN MODE in the SYSTEM (2/2) Menu screen is set to "OPE OFF".

21 [SERIAL REMOTE IN] terminal (mini jack)

This terminal is for connecting to the serial remote controller RM-G30 (sold separately).

To operate BR-DV6000 with this terminal, perform the following settings.

- Set REMOTE SEL SER in the REMOTE (1/2) Menu screen to "ON" or "LOC+REM".

ON : When the 4 REMOTE / LOCAL switch on the front panel is set to "REMOTE", this terminal becomes effective.

LOC+REM: This terminal is effective regardless of the setting of the 4 REMOTE / LOCAL switch on the front panel.

Memo

- To use this terminal as the foot switch input, set FOOT SW in the REMOTE (2/2) Menu screen. (Page 77)

22 [SERIAL REMOTE OUT] terminal (mini jack)

- This terminal is for direct through-output of serial commands of the serial remote input terminal. (Only with OPERATE ON)
- If REPLICATION of the SYSTEM (2/2) Menu screen is set to SERIAL, this terminal outputs REC commands when BR-DV6000 begins playback. (REPLICATION mode) Use this function to connect BR-DV6000 to a dubbing device for dubbing its playback video or playback sound.

23 [REMOTE1] RS-422A terminal (D-SUB 9-PIN)

This terminal is for connecting to an RS-422A serial interface-compatible editing remote controller (e.g. RM-G820).

With this terminal, BR-DV6000 can be used as a player or recorder of an editing system.

To operate BR-DV6000 with RS-422A, perform the following settings.

- Set REMOTE SEL 9-PIN in the REMOTE (1/2) Menu screen to "ON".
- Set the 4 REMOTE / LOCAL switch on the front panel to "REMOTE".

Memo

- Use screws, of the metric, not inch, system, for fastening the connectors.
- This part can be replaced by the RS-232C serial interface board SA-K46U (sold separately).
Consult your JVC authorized service agent for such replacements.

24 [REMOTE2] JVC Bus terminal (12-PIN)

This terminal is for connecting to the JVC bus interface-compatible editing remote controller (RM-G800).

With this terminal, BR-DV6000 can be used as a player or recorder of an editing system.

To operate BR-DV6000 with this terminal, perform the following settings.

- Set REMOTE SEL JVC in the REMOTE (1/2) Menu screen to "ON".
- Set the 4 REMOTE / LOCAL switch on the front panel to "REMOTE".

25 Slot cover for an optional board

This cover can be removed to install any of the following optional boards.

- SA-DV6000 network board
- SA-X61U AUDIO XLR IN board (2ch)
- SA-X62U AUDIO XLR OUT board (2ch)

Memo

- With the SA-X61U AUDIO XLR IN board installed, whether sound signals are input to the XLR IN terminal or the AUDIO IN terminal can be selected with AUDIO INPUT SEL in the AUDIO MENU. If the MIC terminal is in use, the MIC terminal precedes.
- With the SA-X62U AUDIO XLR OUT board installed, the audio channel to which signals are output can be selected with the AUDIO OUTPUT switch.

ON-SCREEN DISPLAY

- On-screen display -

Besides E-E images and playback images, the monitor connected to the VIDEO MONITOR OUT terminal provides the following on-screen information. Press the DISPLAY button to display the same information on the LCD screen of BR-DV6000.

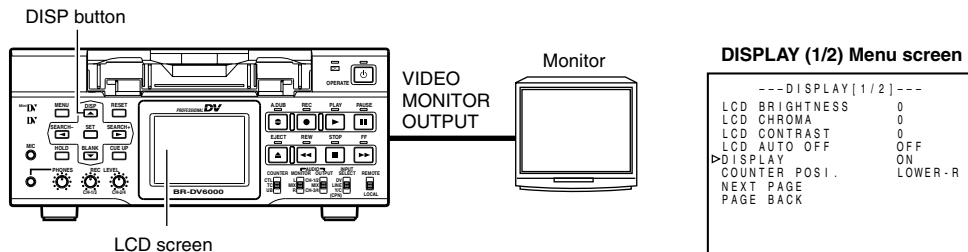

On-screen display	Description	Operation
Status display	Displays the setting status of the VCR operation mode, date/time, counter.	Settings can be performed with DISPLAY in the DISPLAY (1/2) Menu screen.
Event display	Displays the operating status of blank search, index recording/search.	ON : Always display. According to each event or error, the event and alarm displays are shown for about 3 seconds.
Alarm display	Displays error/alarm messages for incorrect operation or improper condition of BR-DV6000.	AUTO : It displays for about 4 seconds during mode changes. OFF : No on-screen display. The alarm display is shown according to errors, which occurred.
		Display on the LCD The on-screen display changes whenever the DISPLAY button is pressed. (☞ Page 26)
Warning display	When an error occurred with the VCR, it displays warnings with the relevant error codes. (☞ Page 98)	It is displayed automatically when an error with the VCR occurred.
Menu display	Displays the menu setting screen. (☞ Page 69)	When BR-DV6000 enters the STOP/ STILL mode or no cassette tape is loaded, the menu is displayed when the MENU button is pressed.
Multi Cue-up screen	Displays the Multi Cue-up screen for registering or selecting cue-up (searching) point. (☞ Page 54)	When BR-DV6000 enters the STOP, STILL or PLAY mode, press the Cue-up button to display the Multi Cue-up screen.

■ **Status display:** It displays the current settings and operating status.

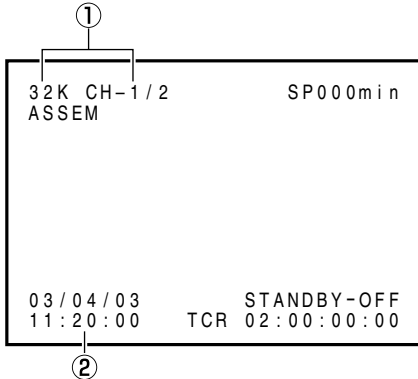

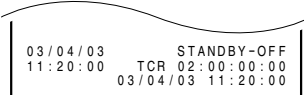

Memo

- With the DATE REC function in use, the last line is fixed to the date/time display. The information displayed on the last line moves to the line above. (DATE REC function: Page 81)

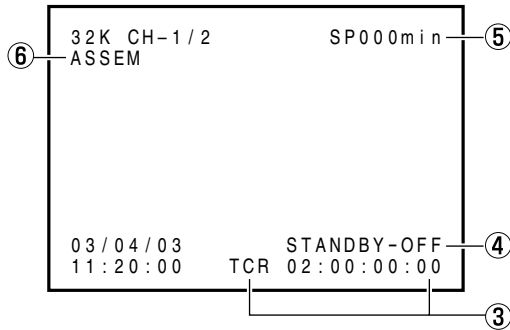

No.	Item	Description
①	<p>Sampling frequency/audio output CH</p> <p>Memo</p> <p>If the counter display position is set to the upper left, this item will be displayed on the lower right.</p>	<ul style="list-style-type: none"> • Sampling frequency During recording, the setting value of AUDIO MODE in the AUDIO Menu screen is displayed (32k or 48k). During playback, the sampling frequency of the sound recorded on the tape is displayed (32k, 48k, 44.1k). During DV signal input, the sampling frequency of the sound input is displayed. • A.LOCK Lights up when the video and audio sampling clocks (at 48kHz) are synchronized in the PLAYBACK mode. Always lights up in the RECORDING mode and EE mode. • Audio output channel During playback, the audio channel output from the AUDIO OUT terminal is displayed (CH1/2, CH3/4, MIX). (only in 32k mode) • With AUDIO INFO. in the DISPLAY Menu screen, whether to display this item can be selected.
②	<p>Date/time</p> <p>Memo</p> <p>If the display position of the counter is set to the lower left, this item will be displayed on the lower right.</p>	<ul style="list-style-type: none"> • It displays the date (DD/MM/YY) and time (HR:MM:SS). • When the unit is in the RECORDING or STOP mode, it displays the data of the built-in clock. • During playback, fast-forwarding or rewinding, the data recorded on the tape is displayed. • During DV signal recording, the data from the DV terminal is displayed. If the REC button is pressed in the STOP mode, the input data from the DV terminal will be displayed. • The style for displaying the date and time can be selected with DATE STYLE and TIME STYLE in the DISPLAY Menu screen. • Whether to display date/time and the type of display can be selected with TIME/DATE in the DISPLAY Menu screen. • When the data/time is not set or when a tape is played with no date/time data recorded, “- -” will be displayed.



No.	Item	Description
③	Counter display	<p>Displays the CTR counter, time code or user's bit. The displayed contents can be selected using the COUNTER switch.</p> <ul style="list-style-type: none"> • CTL counter: It will be displayed if the COUNTER switch is set to CTL. The counter shows a 7-digit number (hour, minute, second and frame) with + or - and "CTL" at the beginning, e.g., CTL-9:30:20:10 • Time code : It will be displayed if the COUNTER switch is set to TC. The time code shows an 8-digit number (hour, minute, second and frame) At playback, the time codes recorded on the tape are displayed. The prefix indicates the time code mode. TCG : Time code generator data TCR : Time code reader data DTCG : Time code data received from the DV IN / OUT terminal ETCG : External time code generator data <p>Depending on the framing mode, the symbols for the seconds and frames are different (only for NTSC).</p> <p style="text-align: center;">00 : 00 : 00 : 00</p> <p style="margin-left: 100px;">  Dot (.) for the drop frame mode Colon (:) for the non-drop frame mode </p> <ul style="list-style-type: none"> • User's bit : it will be displayed if the COUNTER switch is set to UB. The user's bit is an 8-digit number (each digit is a number or character from 0 - F). The prefix indicates the user's bit mode. UBG : User's bit generator data UBR : User's bit reader data DUBG : User's bit reader data received from the DV IN / OUT terminal EUBG : External user's bit generator data <div style="border: 1px solid black; padding: 5px; margin-top: 10px;"> <p>Memo</p> <ul style="list-style-type: none"> • The position of the counter display can be changed with COUNTER POSI in the DISPLAY Menu screen. • The counter display can be turned on/off with TIME CODE in the DISPLAY Menu screen. </div>

No.	Item	Description
④	VCR operation mode	Displays the VCR operation mode, including: PLAY, EJECT, FF, REW, STANDBY-ON, STANDBY-OFF, STILL, REC, REC PAUSE, A. DUB, A. DUB PAUSE, ASSEM EDIT, INSERT EDIT, SHTL (shuttle search), JOG, BLANK SRH (blank search), NO CASSETTE (cassette tape not loaded), OPERATE OFF. For SHTL and JOG, the speed is also displayed. • The display can be turned on/off with VTR MODE in the DISPLAY Menu screen.
⑤	Remaining tape Memo If the counter display position is set to the upper right, this item will be displayed on the lower right.	Displays the remaining time of tape (minutes). Not displayed when the remaining time is being confirmed. • The display can be turned on/off with TAPE REMAIN in the DISPLAY Menu screen. • The SP display disappears when a DVCAM cassette tape is being played back. • This remaining tape time display is only for reference.
⑥	Edit mode display Memo • With the counter display shown on the top left, this display appears on the bottom right. • In the 48 k audio mode, insert editing is not possible in the following cases. INS A1, INS A2, INS VA1, INS VA2	Displays the edit mode selected, e.g., by using the edit mode controller. • ASSEM : Assemble editing • INS V : Video insert editing • INS A : Audio insert editing (Audio: both CH 1 and CH 2) • INS VA : Video, audio insert editing (Audio: both CH 1 and CH 2) • INS VA : Video/Audio insert editing • INS TC : Time code insert editing (Time code only) Insert editing in the 32 k audio mode • INS A12 : CH1, CH2 audio • INS A34 : CH3, CH4 audio • INS VA12: Video & CH1, CH2 audio • INS VA34: Video & CH3, CH4 audio • INS A : CH1 to CH4 audio • INS VA : Video & CH1 to CH4 audio The display can be turned on/off with EDIT INFO in the DISPLAY Menu screen.

■ **Event display** : When certain functions are in use, it is displayed at the following positions (with the DISPLAY mode ON or AUTO).

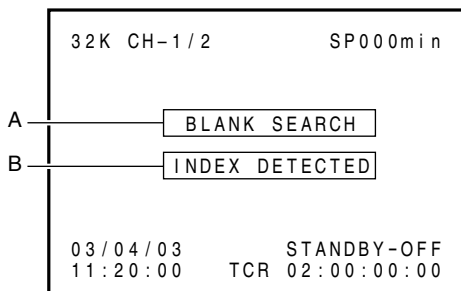

● **“A” display: displayed during operation**

Display	Description
BLANK SEARCH	Blank search in progress.
INDEX +1	Index search in progress. The number indicates the index search position.
INDEX MARK	When an index has been specified on the tape during recording.

● **“B” display: displayed for about 3 seconds**

Display	Description
INDEX DETECTED	An index has been detected during index repeat operation.
VIDEO END DETECTED	The video end has been detected during end repeat operation.

- Alarm display:** An alarm message is displayed at the following positions when there has been an operation error or when BR-DV6000 is not in good condition, e.g., dirty head.

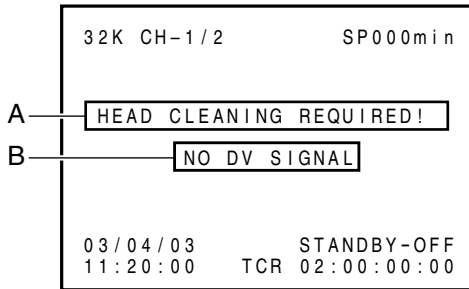

- “A” display :** The state of BR-DV6000 is displayed. It continues to be displayed until the error state is corrected. This display is not affected by the setting of the display mode.

Display	Description
LOW VOLTAGE	The voltage of the DC power source is low. If the operation continues, it enters the Operate OFF mode.
HEAD CLEANING REQUIRED!	The video head is dirty. Clean it with the head-cleaning tape exclusively for BR-DV6000. (Page 8) If the head is clogged, it is detected in the PLAYBACK mode and this message is displayed.
OVERHEATING!	The temperature inside BR-DV6000 has exceeded the stated value. Disconnect the power and place it at a cool place. If this message is displayed again, BR-DV6000 could be defective. Consult your JVC-authorized service agent.

- “B” display :** Messages for incorrect operation are displayed for about 3 seconds. They are displayed when the DISPLAY mode is ON or AUTO.

Display	Description
INVALID TAPE!	Data tape for PCs or DVC PRO tape is used. The cassette tape will be automatically ejected.
LP TAPE!	The user attempted to play back a tape recorded in the LP mode. BR-DV6000 cannot record or play in the LP mode.
NO DV SIGNAL	The user attempted to record without DV signal input.
COPY INHIBIT	The user attempted to record copy-guarded signals.
REC INHIBIT	The user attempted to record on a tape that is not ready for recording (the rear switch is set to SAVE).
REC INHIBIT (NTSC/PAL)	The user attempted to record analog signals when PB/DV IN in the SYSTEM (2/2) Menu is set to NTSC.

Display	Description
A. DUB INHIBIT (REC TAB)	The user attempted to perform audio dubbing on a tape that is not ready for recording (the rear switch is set to SAVE).
A. DUB INHIBIT (48 K)	This message is displayed when audio dubbing is attempted under the following conditions. <ul style="list-style-type: none"> • AUDIO MODE of the AUDIO Menu screen is set to 48 K. • The tape is recorded with a sampling frequency of 48kHz
A. DUB INHIBIT (LP)	The user attempted to perform audio dubbing on a tape recorded in the LP mode.
A. DUB INHIBIT (BLANK)	The user attempted to perform audio dubbing of a blank tape.
A. DUB INHIBIT (DV)	The user attempted to perform audio dubbing during DV signal input (with the INPUT SELECT switch set to "DV").
A. DUB INHIBIT (NTSC/PAL)	The user attempted audio dubbing when PB/DV IN in the SYSTEM (2/2) Menu screen is set to NTSC.
A. DUB INHIBIT (DVCAM)	The user attempted to perform audio dubbing on a DVCAM format tape.
EDIT INHIBIT (REC TAB)	The user attempted to edit a tape that cannot be recorded (with the rear switch set to "SAVE").
EDIT INHIBIT (LP)	The user attempted to edit a tape recorded in the LP mode.
EDIT INHIBIT (BLANK)	The user attempted to insert-edit an unrecorded part of a tape.
EDIT INHIBIT (NTSC/PAL)	The user attempted editing when PB/DV IN in the SYSTEM (2/2) Menu screen is set to NTSC.
EDIT INHIBIT (DVCAM)	The user attempted to edit a tape recorded in the DVCAM format.
EDIT INHIBIT (AUDIO)	The user attempted editing in an audio combination that cannot be edited.
EDIT INHIBIT (DV TC INS)	The user attempted time-code insert-editing during DV signal input.
DV EE INHIBIT	This message is displayed when the REC button is pressed during playback with the INPUT SELECT switch set to DV. (EE check is not allowed during DV input.)
OPERATION LOCK	This message is displayed when an operation button is pressed with OPERATION LOCK enabled. To enable OPERATION LOCK, set OPERATION LOCK in the SYSTEM (2/2) Menu screen to ON.

There are two display modes for the status display on the LCD of the unit.

- Same character display mode as the monitor output
- LCD display mode (enlarged display)

DISPLAY button

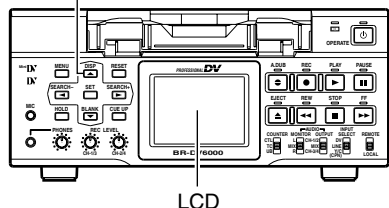

The LCD display mode changes in the following sequence whenever the DISPLAY button is pressed (with DISPLAY of the DISPLAY Menu screen set to ON or AUTO).

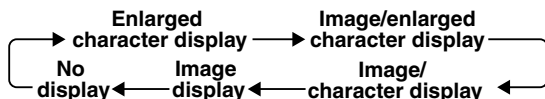

Memo

- With LCD AUTO OFF in the DISPLAY Menu screen, the LCD display can be set to disappear if it continues to be on for a certain time.
When the display goes off automatically, press any button to return to the original display mode.
- The LCD display area is smaller compared with the one for the actual images.

■ LCD display mode (enlarged display)

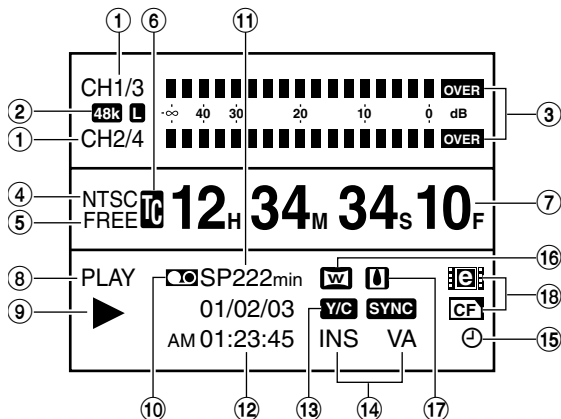

1 Audio output channel display

It displays the setting status of the AUDIO OUTPUT switch on the front panel.

Top (CH 1 /3 AUDIO OUT): CH 1, CH 3, CH 1 /3
Bottom (CH 2 /4 AUDIO OUT): CH 2, CH 4, CH 2 /4

2 Audio sampling frequency display

- During recording, it displays the setting status of AUDIO MODE of the AUDIO Menu screen.(48k or 32k)
- During playback, the audio mode of the tape is displayed (48k, 32k, or 44.1k)
- L: Displayed during AUDIO LOCK.

3 Audio level meter display

It displays the input sound level during recording or in the STOP mode, and the playback sound level during playback.

The reference recording level of BR-DV6000 is -20dB.

- For playing a tape recorded with a home-use DV machine with a reference level of -12 dB, set AUDIO OUT LEVEL to -12 dB.

4 Drop/Non-drop display (for NTSC only) /NTSC mode

Displays the framing mode of the time code.

NDF : Non-drop frame (NTSC only)

DF : Drop frame (NTSC only)

NTSC : Displays when PB/DV IN in the SYSTEM (2/2)
Menu screen is set to NTSC.

5 Time code mode display

Displays the time code mode set in the TC/UB/CLOCK Menu screen.

REGN : Regeneration mode

RRUN : REC RUN preset mode

FREE : FREE RUN preset mode

EXT : This is displayed when time codes are input to the TIME CODE IN terminal (with TCG SOURCE set to EXTERNAL).

It blinks when no time code is input or when the phase of an external time code is not locked with the phase of the video signal.

DUPL : This is displayed when TC DUPLICATE is set to AUTO.
(Enter the time code of the DV terminal.)

6 Counter mode

The counter mode selected with the COUNTER switch on the front panel is displayed.

 : CTL counter  : Time code

 : User's bit

7 Counter display

- The CTL counter is displayed as a 7-digit number with + or - .
The time code/user's bit is displayed as an 8-digit number.
- With NTSC, the character/symbol at the end varies depending on the time code framing mode.
F : Non-drop frame.
. (dot) : Drop frame.
With PAL, this is fixed to F.

8 VCR mode display

Displays the operation mode of the VCR.

The reservation of mode is displayed in blinking light.

NOCAS (no cassette tape), EJECT, STBON (standby-on), STBOF (standby-off), PLAY, STILL, FF, REW, SHTL, ADUBP (audio dubbing pause), REC, RECP (recording pause), INSERT, ASSEM, OPOFF (operate off)

9 VCR mode graphic display

 : Eject

 : Stop

 : Play

 : Still

 : FF/Forward search

 : REW/Reverse search:

 : Record

 : Recording pause

 : Audio dubbing

 : Audio dubbing pause

10 Tape symbol display

 : This symbol is displayed when a cassette tape is loaded.

It blinks during loading or ejecting of a cassette tape.

If the rear switch of the cassette tape is set to SAVE, it is displayed in yellow.

11 Remaining tape time display

Displays the remaining time (minutes). Blinks if the remaining time is less than 4 minutes.

Not displayed when the remaining time is being confirmed. SP will not be displayed when a DVCAM cassette tape is being played back.

12 Time/Date display

The data of the built-in clock will be displayed during recording or in the STOP mode. Displays the data of the tape during playback.

If the date/time is not set up, "-- --" is displayed.

13 Input video signal display

Displays the input video signal selected with the INPUT SELECT switch on the front panel.

Blinks if the selected signal is not input (LINE, Y/C, CPNT, or DV).

(**LINE**, **Y/C**, **CPNT**, **DV**)

In the case of a copy-prohibiting signal, it will be displayed in yellow.

SYNC : It is displayed when signals are input via the SYNC IN terminal with EXTERNAL SYNC selected.

14 Editing mode display

The editing mode selected with the editing remote controller is displayed.

(ASSEM, INSV, INSA, INSVA, INS TC, INS VA12, INS VA34, INS A12, INS A34)

15 Timer display

 : It is displayed when the TIMER switch on the rear panel is set to REC or PLAY.

REC: RED PLAY: GREEN

16 Wide screen ID signal display

 : It will be displayed when a wide screen ID signal exists in the input signal of the Y/C or DV terminal.
The data on the tape is displayed during playback.

17 Condensation display

 : It is displayed when condensation occurs.

18 Option display

It is displayed when an option board is connected.

 : SA-X61U connection

 : SA-X62U connection

 : SA-DV6000 connection

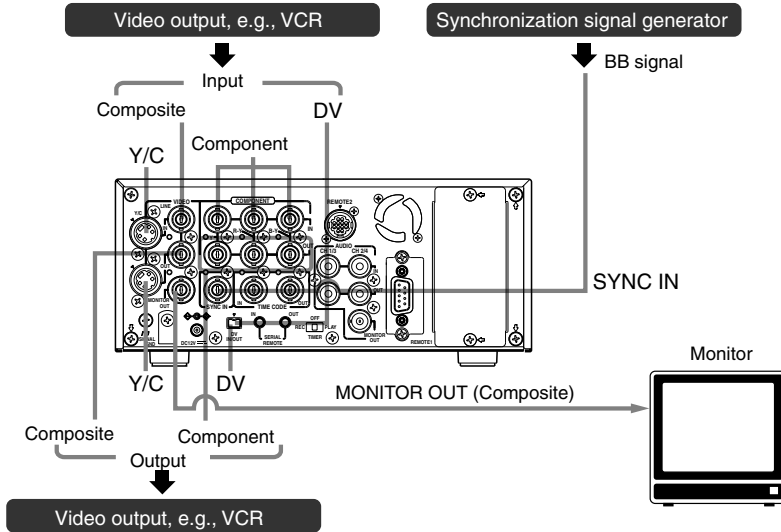

■ Output signal

When BR-DV6000 enters the STOP, REC or EDIT mode, the input signal (E-E image) is output. In the PLAYBACK mode (including the playback of the pre-roll part during editing), playback images are output.

However, in the edit mode with analog input, signals cannot be output to the DV OUT terminal properly.

● Analog signal

- LINE OUT terminal (BNC): composite signal.
- Y/C OUT terminal (4-PIN): YC separate signal.

When a wide screen ID signal exists in the video signal, the ID signal is output.

- COMPONENT OUT terminal (BNC×3): Component (Y/B-Y/R-Y) signals are output.

● Digital signal

- DV IN/OUT terminal: it outputs IEEE1394-compliant digital video signals.

When a wide screen ID signal exists in the video signal, the ID signal is output.

● Connection with a monitor TV

A monitor TV can be connected to the MONITOR OUT terminal. Besides the composite video signals, it also displays the on-screen display for status or menu screen.

Memo

Set PB/DV IN in the SYSTEM (2/2) Menu screen according to the signal format of the tape to be played. (NTSC or PAL)

■ Input signal

The input video signal is selected with the INPUT SELECT switch on the front panel. Set VIDEO INPUT SEL in the VIDEO Menu screen to select YC input or component input.

● Analog signal

- LINE IN terminal (BNC): composite signal
- Y/C IN terminal (4-PIN): YC separate signal
When a wide screen ID signal is being input, the ID signal is recorded.
- COMPONENT IN terminal (BNC×3):
The component (Y/B-Y/R-Y) signal.

● Digital signal

- DV IN/OUT terminal : IEEE1394-compliant digital video signals are input.

When a wide screen ID signal is being input, the ID signal is recorded.

Set PB/DV IN in the SYSTEM (2/2) Menu screen according to the signal format to be input to the DV terminal. (NTSC or PAL).

Memo

Whether or not to enable SET UP for analog I/O signals of signals can be selected with SET UP in the VIDEO Menu screen (for NTSC only).

Caution on video signals

- If search images or video signals with a high level of jitter are input, images or sound may be distorted temporarily. Thus, input stable signals, e.g., those having gone through a TBC.
- A digital VCR requires that video signals for recording be delivered from a stable source. Video signals from an analog VCR must be run through a TBS or TBC.
- When a component output is executed for composite-input video, discoloration may occur on the left side of the screen. It is not a defect.

■ Synchronization signal

In order to enhance the level of edit precision, input synchronization signals to all the devices of the editing system during editing.

For BR-DV6000, input external synchronization signals into the SYNC IN terminal. For external synchronization signals, use video signals of 1V (p-p) or lower (e.g., black burst signals).

To edit DV signals, synchronization signal input is required.

Types of synchronization signal:

BR-DV6000 is operated based on one of the following 3 types of synchronization signal.

- Synchronization signals produced by the synchronization signal generator inside the VCR (INT)
- Video signals from the video signal input terminal (VIDEO)
- Synchronization signals from the SYNC IN terminal (EXT)

Selection of synchronization signals:

Synchronization signals should be selected depending on whether external synchronization input (SYNC IN) or video input (VIDEO IN) exists or on the SYNC SELECT Menu settings. Synchronization signals are selected as shown in the following table.

SYNC IN		No	Yes	No	Yes
VIDEO IN		No	No	Yes	Yes
EXTERNAL*	Playback	INT	EXT	INT	EXT
	Record	INT	INT	VIDEO	VIDEO
AUTO*	Playback	INT	EXT	VIDEO	EXT
	Record	INT	INT	VIDEO	VIDEO

* The above can be selected with SYNC SELECT in the SYSTEM Menu screen.

Memo

- During DV signal recording, the status of synchronization signals will be as shown below regardless of the SYNC SELECT menu settings.

SYNC IN terminal signal	Synchronization signals
Input	EXT
No input	DV

- Regardless of the setting of SYNC SELECT, when a tape recorded in NTSC is played back, synchronization signals are as shown below.

SYNC IN terminal	Synchronization signals
NTSC signal input	EXT
PAL signal input or No signal input	INT

Caution on synchronization signals

- For external synchronization signals, output-signal phase adjustments cannot be performed. In addition, the sub carrier cannot be locked.
- Plugging and unplugging of external synchronization signals or video input signals during playback causes distortion of images and sound for about 5 seconds.

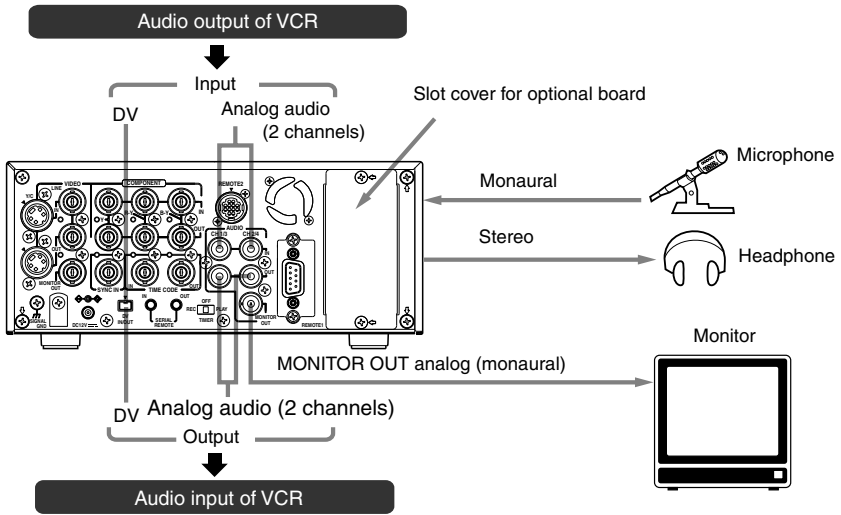

■ Output signal

When BR-DV6000 is in the STOP, REC or EDIT mode, signals (EE sound), which have been input, are output.

During the PLAYBACK mode (including the playback of the pre-roll part during editing), the playback sound is output.

However, in the edit mode with analog input, signals cannot be output to the DV OUT terminal properly.

● Analog signal

CH 1/3, CH 2/4 AUDIO terminal (RCA × 2).

There are analog audio terminals for 2 channels.

For the DV format, tracks are available for 4 channels (in the 32kHz audio mode).

- In the 32kHz mode, from which one of the 4 channels sound is output can be selected with the AUDIO OUTPUT switch on the front panel. (Refer to the table on the right.)

● Headphone terminal

Sound can be checked in stereo using a headphone. The volume can be adjusted with the PHONES switch on the front panel.

- The channel to be output from this terminal in the 32kHz audio mode can be selected with the AUDIO OUTPUT switch. (Refer to the table on the right.)

AUDIO OUTPUT switches and output channels

In the following cases, the channels that receive output from the AUDIO OUTPUT terminal vary according to the setting of the AUDIO OUTPUT switch. The table below shows the channels.

- During playback of tapes recorded in the 32kHz audio mode.
- During audio dubbing.
- In the EE mode of DV input in the 32kHz audio mode.

AUDIO OUTPUT switch	AUDIO OUT terminal	
	CH1/3 (L)	CH2/4 (R)
CH1/2	CH1	CH2
MIX	CH1/3	CH2/4
CH3/4	CH3	CH4

- In the 48kHz audio mode or during normal recording, output goes to CH1 and CH2 regardless of the setting of the switch.

- **Connecting to a monitor TV**

A monitor TV can be connected to the AUDIO MONITOR OUT terminal.

The sound output from the AUDIO MONITOR OUT terminal is monaural.

- The volume is adjusted through the monitor TV.
- The output channel can be selected with the AUDIO MONITOR switch on the front panel (Refer to the following table).

AUDIO MONITOR switches and output channels of AUDIO OUTPUT/PHONES

In the following cases, the output channels from the AUDIO MONITOR OUTPUT/PHONES terminal vary according to the setting of the AUDIO MONITOR switch and the AUDIO OUTPUT switch. The table below shows the channels.

- During playback of tapes recorded in the 32kHz audio mode.
- During audio dubbing.
- In the EE mode of DV input in the 32 kHz audio mode.

AUDIO switch		MONITOR OUT/ PHONES terminal
MONITOR	OUTPUT	
L	CH1/2	CH1
	MIX	CH1/3
	CH3/4	CH3
MIX	CH1/2	CH1/2
	MIX	CH1/2/3/4
	CH3/4	CH3/4
R	CH1/2	CH2
	MIX	CH2/4
	CH3/4	CH4

- In the 48kHz audio mode or during normal recording, it outputs to CH1/2 channel (the OUTPUT switch listed in the above table shows the setting of CH1/2).
- When MIX is selected, the PHONES terminal outputs stereo sound.

- **Digital output**

IEEE1394-compliant digital signals are output from the DV IN/OUT terminal.

- **Input signal**

- **Analog signal**

CH 1/3 AUDIO IN terminal. (RCA × 2)

There are analog input terminals for 2 channels. Recording cannot be performed to 4 channels at the same time. Sound from each terminal is usually recorded to CH1 and CH2.

To record to CH 3 and CH 4, set AUDIO MODE of the AUDIO Menu screen to 32 k and record it in the audio-dubbing mode. (☞ Page 44)

- **Microphone input terminal**

This terminal is for connecting to a monaural microphone. The same sound is recorded on the 2 channels.

Memo

- To record sound on the AUDIO IN terminal and MIC terminal, set the INPUT SELECT switch on the front panel to "LINE" or "Y/C (CPN)".
- If the AUDIO IN terminal and MIC terminal are used at the same time, the MIC terminal precedes.

- **Digital input**

IEEE1394-compliant digital signals are input into the DV IN/OUT terminal.

- To enable audio input into this terminal, set the INPUT SELECT switch to DV.
- The AUDIO MODE (48 K or 32 K) will be one of input signals.
- During digital signal input, the recording level cannot be adjusted.

Memo

- An input/output board (sold separately) of the XLR connector can be installed in the optional slot.
SA-X61U AUDIO XLR IN board
SA-X62U AUDIO XLR OUT board
These boards cannot be installed at the same time.
- For BR-DV600 player, when the mode is changed from STILL to PLAY, sound will be muted for a while shortly after the audio output. Thereafter, it will resume as per normal. (This does not occur with BR-DV600A.)

CONNECTION

- Connecting to editing system -

BR-DV6000 is equipped with 2 remote terminals, for the JVC bus and RS-422A for editing purposes.

■ When a JVC bus-compatible editing remote controller is used:

For the editing remote controller, use RM-G800.

Example: BR-DV6000 as player and recorder for cut editing of digital signals.

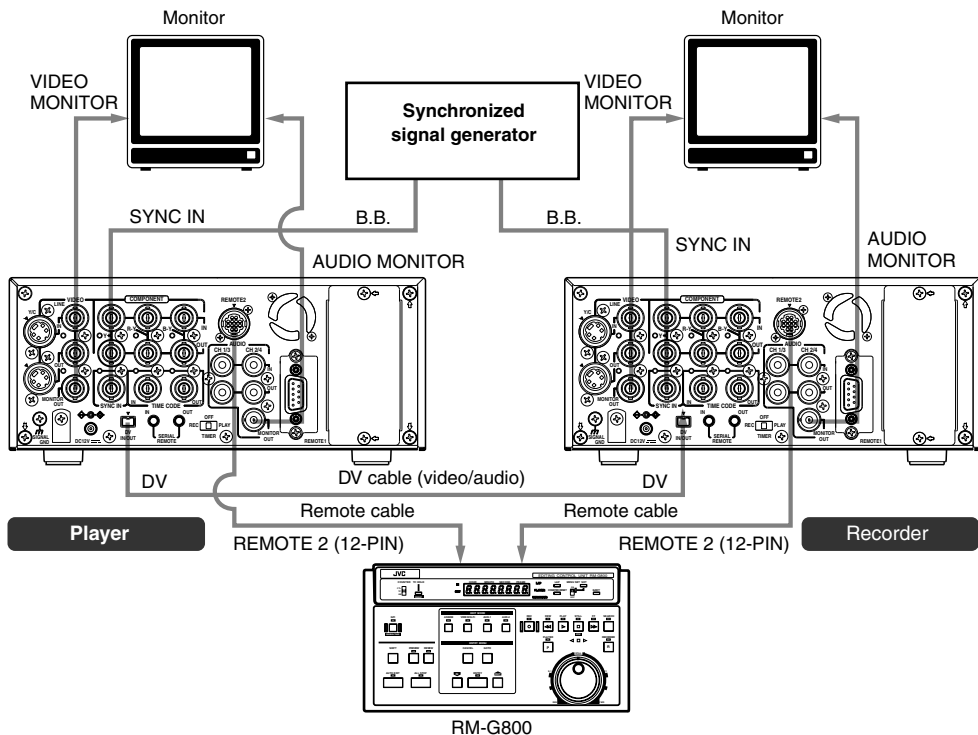

Note

Before connecting the cables for remote terminals, ensure that the power to the VCR is turned off.

■ Remote extension cable

To extend the cables for the remote terminals, use the extension cable VC-G8030U (3m) (sold separately).

■ DV cable

Use VC-VDV204 (2 m, 4P-4P) or VC-VDV206 (2 m, 4P-6P) (sold separately).

■ Related VCRs

● VHS/S-VHS VCR

No input/output of DV signals is possible.
BR-S800 + (SA-N50)
BR-S500 (player) + (SA-N50)

● DV VCR

BR-DV600/A

Note

- If RM-G800 is to be used, check whether the (x) mark is printed on the label at the bottom of the unit.
If there is no (x) mark, modification is required. Consult your JVC service agent.
- For the use of RM-G800, there are certain regulations regarding Electro-Magnetic Compatibility (EMC). Consult your JVC service agent.

■ **When an RS-422A-compatible remote controller is used:**

For the editing remote controller, use RM-G820.

Example: use BR-DV6000 as player and recorder for cut editing of analog signals.

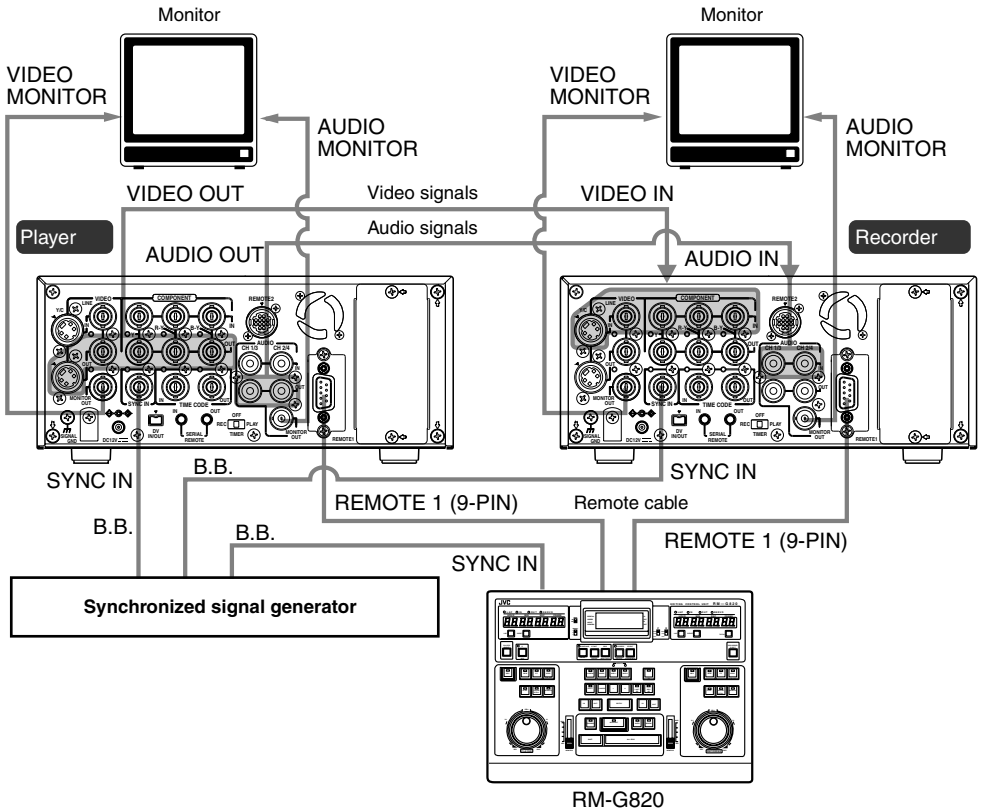

■ **To fasten the connector of the remote cable to the REMOTE 1 terminal, use a screw of the metric, not inch, system.**

■ **In order to enhance the level of editing precision, input synchronization signals (black burst signals) to all devices.** (Page 29)

When BR-DV3000 is to be used as the player, input as synchronization signals the composite signals or the Y signals of the YC signals of BR-DV3000 to the SYNC IN terminal of BR-DV6000.

■ **Related VCRs**

● **VHS/S-VHS VCR**

BR-S800 (equipped with SA-K26, SA-R50, SA-N50)

BR-S822 (equipped with SA-T22)

* No input/output of DV signals is possible.

● **D-9 (digital S) VCR**

BR-D80, BR-D85, BR-D750
(Only analog signals)

● **DV VCR**

BR-DV3000 (player only)

BR-DV600/A (player only)

For information on settings and other points on the operation of BR-DV6000 with an editing system, refer to pages 64 – 68.

CONNECTION - Connection with serial remote terminals -

The following describes examples of serial remote terminal connection.

To use the serial remote terminals, set **REMOTE SEL SER** of the **REMOTE (1/2)** Menu screen to "ON" or "LOC+REM." (☞ Page 75)

■ Operate BR-DV6000 with the wired remote controller RM-G30 (sold separately)

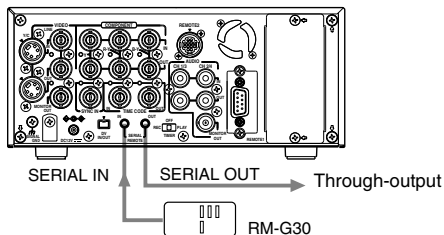

Connect the wired remote controller RM-G30 to the SERIAL REMOTE IN terminal.

The commands of the SERIAL REMOTE IN terminal is through-output from the SERIAL REMOTE OUT terminal. (Only with OPERATE ON)

Multiple VCRs can be operated with RM-G30 by series connection of the SERIAL REMOTE IN/OUT terminals.

■ Start/stop recording with an external switch, e.g., a foot switch.

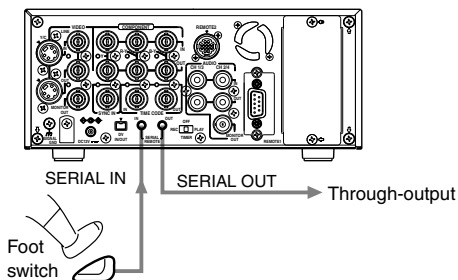

Connect an external switch, e.g., a foot switch, to the SERIAL REMOTE IN terminal.

The format of the input signals can be selected with FOOT SW in the REMOTE (2/2) Menu screen. (☞ Page 46)

■ Dubbing of playback images or sound with other machines using the SERIAL REMOTE OUT terminal.

When BR-DV6000 is in the playback mode, the REC command can be output from the SERIAL REMOTE OUT terminal (REPLICATION function). With this function, a tape loaded in BR-DV6000 can be dubbed on another unit. For details, refer to ☞ Page 57.

BR-DV6000 can be used as a master or dubbing unit.

● Dubbing with 1 VCR.

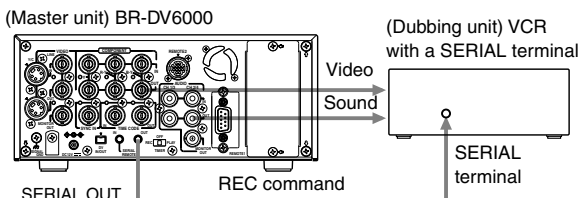

Memo

If REPLICATION of the SYSTEM (2/2) Menu screen is set to DV, the REC command is output from the DV terminal.

● Dubbing with multiple VCRs (Up to 50 VCRs can be controlled comprehensively.)

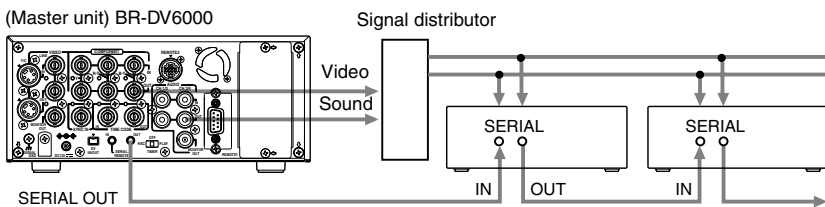

* Dubbing unit: VCR with SERIAL IN and OUT terminals
DV: BR-DV6000

CONNECTION

- Connecting the AC adapter -

Connect the supplied AC adaptor to BR-DV6000.

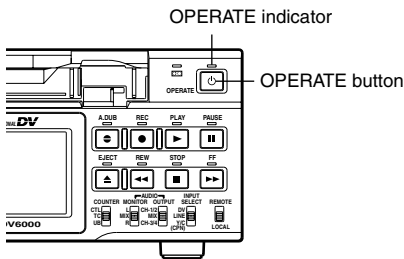
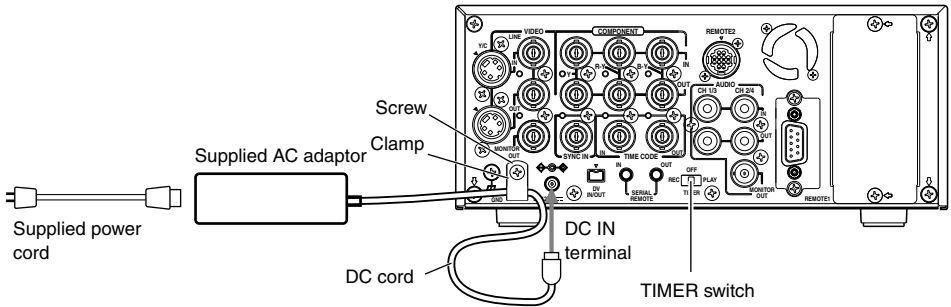

■ **Before connecting the AC adaptor, ensure that the TIMER switch is set to "OFF". (Refer to "Notes" below.)**

1. Connect the DC cord of the AC adaptor to the DC IN terminal of BR-DV6000.

2. To prevent accidental disconnection of the DC cord, fasten the DC cord with a clamp.

- ① Remove the screw and the clamp shown in the above figure.
- ② Insert the DC cord into the clamp and fasten the clamp unto the unit.

3. Connect the supplied power cord to the AC IN terminal of the AC adaptor.

4. Connect the power cord to the power outlet.

- BR-DV6000 is turned on and the OPERATE indicator lights up in red. (OPERATE OFF mode)
- If DC IN MODE of the SYSTEM (2/2) Menu screen is set to "OPE ON", the OPERATE indicator will light up in green. (OPERATE ON mode)

Memo

- Even in the OPERATE OFF mode, a small amount of electricity will still flow into the unit.
- When the unit is in the OPERATE OFF mode, no operation can be performed except that of the OPERATE buttons and cassette loading/ejecting.

Notes

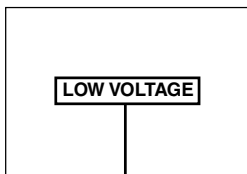

- Supply power to BR-DV6000 using the supplied AC adaptor. Do not use other power sources.
- Do not unplug the DC cord and/or the power cord during recording or playback.
- If the supply voltage is low, an alarm display of "LOW VOLTAGE" is shown.
- If the TIMER switch is set to REC or PLAY, recording or playback begins when power is supplied to the DC IN terminal. When the AC adaptor is connected, ensure in particular that the TIMER switch is not set to REC. Set the TIMER switch to REC or PLAY only when an external timer function is used.

Turning on the power

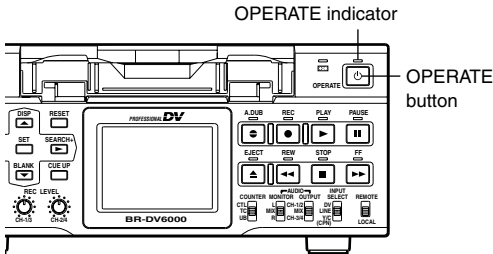

- Press the OPERATE button when BR-DV6000 is in the OPERATE OFF mode (with the OPERATE indicator lit up in red)

- The power is turned on and the OPERATE indicator lights up in green. BR-DV6000 is ready for operation. (OPERATE ON mode)

Note

After the OPERATE button is pressed and BR-DV6000 is turned on, if the green indicator blinks or the monitor or the LCD displays "UNPLUG MAIN POWER, PLUG BACK IN AFTER A WHILE", unplug the power cord from the power outlet, leave it for a while before turning on the power again.

Memo

- In the OPERATE OFF mode, if a cassette tape is inserted, the power is turned on and BR-DV6000 goes into the OPERATE ON mode.
- Whether BR-DV6000 goes into the OPERATE ON or OFF mode when the power is supplied to the DC IN terminal can be selected with DC IN MODE in the SYSTEM (2/2) Menu screen.
- If TIMER REC or TIMER PLAY is selected, BR-DV6000 starts up in the OPERATE ON mode regardless of the DC IN MODE Menu settings. If a cassette tape is loaded, BR-DV6000 starts recording or playback.

Turning off the power

- Turn off BR-DV6000

1. Press the OPERATE button.

- BR-DV6000 enters the OPERATE OFF mode and the OPERATE indicator lights up in red.

2. If BR-DV6000 is not to be used for a long period of time, unplug the AC adapter.

- To unplug the AC adapter, remove the power cord from the power outlet first.

PREPARATION

- Operation method (main unit/remote controller) and operation lock mode -

Selecting the operating method (main unit/remote controller)

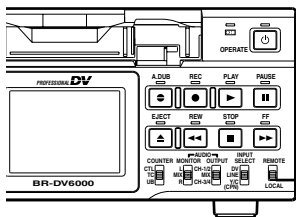

Whether to operate BR-DV6000 with its buttons or the remote controller can be selected with the REMOTE/LOCAL switch.

■ Setting the REMOTE/LOCAL switch

- To operate with the buttons of BR-DV6000, set it to “LOCAL”.
- To operate BR-DV6000 with RS-422A or JVC-bus editing remote controller that is connected to the REMOTE 1 (9-PIN) or REMOTE 2 (12-PIN) terminal, set it to “REMOTE”.

REMOTE (1/2) Menu screen

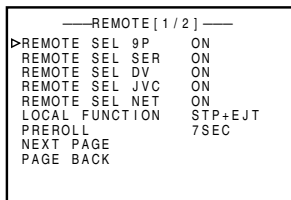

Memo

With the REMOTE/LOCAL switch set to REMOTE, the JVC bus or RS-422A can be enabled using REMOTE SEL JVC or REMOTE SEL 9P in the REMOTE (1/2) Menu screen.

- The setting position of the REMOTE switch for operating BR-DV6000 with the SERIAL REMOTE terminal can be selected using REMOTE SEL SER in the REMOTE (1/2) Menu screen.
 - The setting position of the REMOTE switch for operating BR-DV6000 with the DV terminal can be selected at REMOTE SEL DV in the REMOTE (1/2) Menu screen.
- [Page 75 “REMOTE (1/2) Menu screen”]

Memo

If the REMOTE/LOCAL switch is set to REMOTE, the buttons that can be operated by the main unit can be selected with LOCAL FUNCTION.

OPERATION LOCK mode

BR-DV6000 comes with an operation lock function to prevent unauthorized or incorrect operation. In the OPERATION LOCK mode, the operation buttons and slide switches of BR-DV6000 are disabled. However, the OPERATE ON and MENU operations are effective. The AUDIO MONITOR switch, TIMER switch, PHONES volume and REC LEVEL volume are always effective.

SYSTEM (2/2) Menu screen

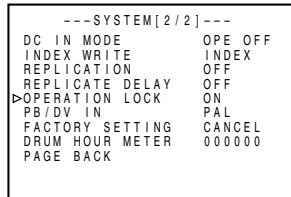

■ Turning on the OPERATION LOCK mode

Set OPERATION LOCK in the SYSTEM (2/2) Menu screen to ON.

- If the operation button of BR-DV6000 is pressed while BR-DV6000 is in the OPERATION LOCK mode, “OPERATION LOCK” is displayed on the monitor or the LCD for about 3 seconds.

■ Turning off the OPERATION LOCK mode

Set OPERATION LOCK in the SYSTEM (2/2) Menu screen to OFF.

Use standard DV cassette tapes or mini DV cassette tapes.

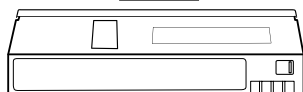
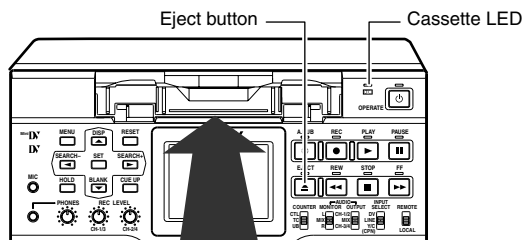

Standard DV tape

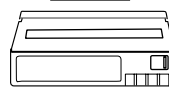
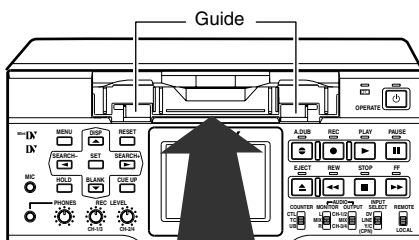

Mini DV tape

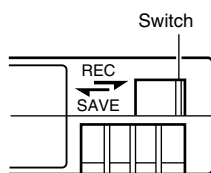

Loading the cassette tape

1. Check the cassette tape.

- Setting the rear switch.
Push it to "REC" for recording
To prevent its contents from being erased accidentally, push it to "SAVE".
- Ensure that the tape is not loosened.

2. Ensure that no cassette tape is loaded.

With no cassette tape loaded, the cassette LED is off.
When no cassette tape is loaded, the status display for the VCR operation mode shows "NO CASSETTE" on the monitor or the LCD.

3. Load the cassette tape.

- Insert a standard DV cassette tape into the tape-loading slot.
 - For a mini DV cassette tape, load it in between the left and right guides.
Set the tape window face up and push the cassette tape in slowly until it is drawn in automatically.
- When the cassette tape is loaded, the status display indicates "STANDBY-ON".
- * If the STANDBY-ON mode is left as is, it goes into the STANDBY-OFF mode.
In the STANDBY-OFF mode, press the STOP button to return to the STANDBY-ON mode.

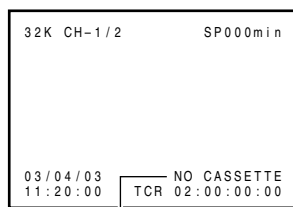

VCR mode status display

Memo

- The cassette tape can be loaded/ejected even when BR-DV6000 is in the OPERATE OFF mode.
- The loading/ejecting action of the cassette tape takes about 6 seconds.

Ejecting the cassette tape

1. Press the EJECT button of BR-DV6000.

→ While the cassette tape is being ejected, the status display flashes "EJECT".

2. Remove the cassette tape.

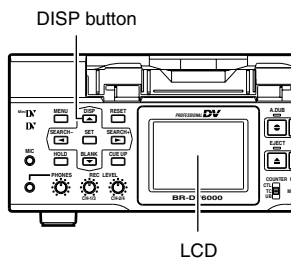

■ Selecting the LCD status display

The contents of the status display for the LCD are selected with the DISP button located on the front panel. When the DISP button is pressed, the status display changes in the following sequence.

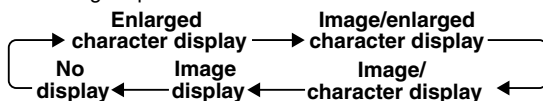

(☞ Page 20 “On-screen display”)

(☞ Page 26 “LCD display”)

■ The LCD settings are performed in the DISPLAY (1/2) Menu display.

● Adjusting the LCD display

- Brightness : With LCD BRIGHTNESS
- Color depth : With LCD CHROMA.
- Contrast : With LCD CONTRAST.

Each of the above can be set up in 11 levels.

● Setting the display time of the LCD display

If the LCD display is not to be used for a long time, LCD AUTO OFF can be selected to set the time for the LCD to go off automatically.

- OFF : Does not turn off automatically.
- 30MIN : Turns off automatically after 30 minutes.
- 1HOUR : Turns off automatically after 1 hour.
- 2HOUR : Turns off automatically after 2 hours.

DISPLAY (2/2) Menu screen

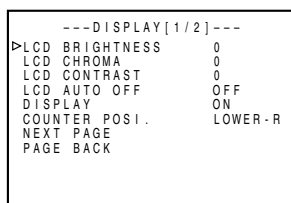

Memo

- During recording or playback, the LCD display stays on regardless of the LCD AUTO OFF setting.
- After the LCD display was turned off automatically, press any button to restore the original display.

This function sets up the date and time of the built-in clock. With the built-in chargeable battery, the date and time data that have been set are maintained even after the main power is turned off. The set date and time data are displayed on the monitor or the LCD display according to the settings in the Menu screen. Set DATE REC in the TC/UB/CLOCK (2/2) screen to ON if the date/time display is to be recorded on the tape as video signals. With DV signal input, date/time data are not recorded. (Page 42 "Setting date/time recording")

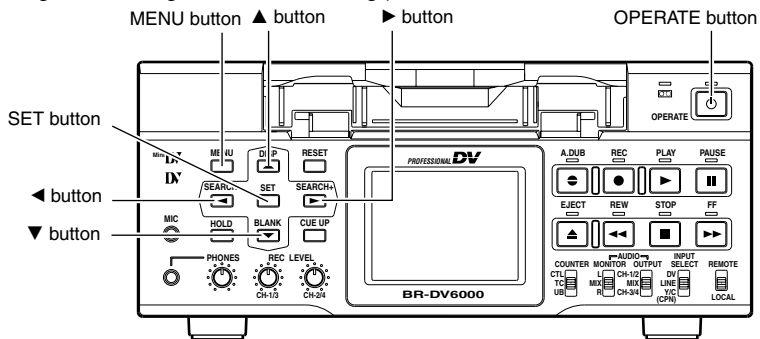

Setting date and time

The date and time are set up at the CLOCK ADJUST Menu screen.

The CLOCK ADJUST Menu screen is found under the TC/UB/CLOCK (2/2) Menu.

Setting can be performed while checking the information shown on the monitor connected to the VIDEO MONITOR OUT terminal.

TC/UB/CLOCK (2/2) Menu screen

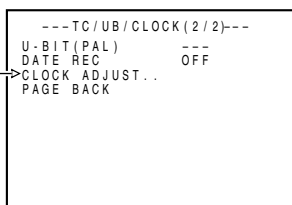

Cursor

CLOCK ADJUST Menu screen

Date (DD/MM/YY)

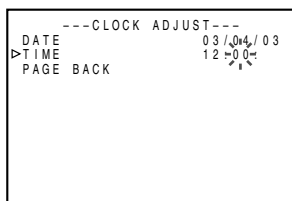
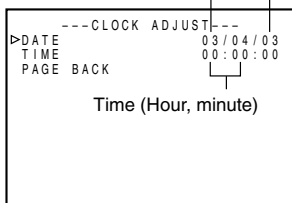

■ Press the OPERATE button to turn on the power and set it to the STOP mode.

1. Press the MENU button to display the TOP MENU screen.

2. Displaying the CLOCK ADJUST Menu.

- ① Press the ▲ or ▼ button to bring the cursor to the desired TC/UB/CLOCK item. Press SET or the ► button.
- ② Press the ▲ or ▼ button to bring the cursor to the NEXT PAGE item in the TC/UB/CLOCK (1/2) Menu screen. Press SET or the ► button.
- ③ Press the ▲ or ▼ button to bring the cursor to the CLOCK ADJUST item in the TC/UB/CLOCK (2/2) Menu screen. Press SET or the ► button.

3. Setting the date and time in the CLOCK ADJUST Menu screen.

- ① Press the ▲ or ▼ button to bring the cursor to the date or time item. Press SET or the ► button.
- ② Press the ► or ◀ button to select the digit for setting. The selected digit starts blinking.
- ③ Press the ▲ or ▼ to set the value.
- ④ Repeat step ① - ③. After completing the required setting, press the SET button.

Memo

The seconds for the time cannot be set up. After the minute is set up, press the SET button in synchronization with the time signal.

```
---CLOCK ADJUST---
DATE      03/04/03
TIME     12:00
>PAGE BACK
```

4. Returning to the TOP MENU from TC/UB/CLOCK after completing all settings

- Press the ◀ button.
Or
Press the ▲ or ▼ button to bring the cursor to PAGE BACK and press the SET button.

5. Returning to the usual menu

- Press the MENU button
Or
Bring the cursor to EXIT of the TOP MENU and press the SET button.

Selecting date/time display

The date and time data can be displayed on the monitor or LCD on-screen display (status display). Setup can be performed at the DISPLAY (2/2) Menu screen to turn on/off the date/time display and select the display style. (For setting procedure:  Page 70)

DISPLAY (2/2) Menu screen

```
---DISPLAY [2/2]---
TIME CODE      ON
VTR MODE      ON
TAPE REMAIN    ON
>TIME/DATE     DATE+TM
AUDIO INFO.   ON
EDIT INFO.    ON
DATE STYLE.   DD/MM/YY
TIME STYLE.   24HOUR
PAGE BACK
```

■ DISPLAY (2/2) Menu screen

- **TIME DATE : For enabling/disabling the display of date and time on the status display**

OFF : Does not display date/time.

TIME : Displays time only.

DATE : Displays date only.

DATE+ TM : Displays both the time and date.

- **DATE STYLE: For selecting the date display style**

YY/MM/DD : Year / month / day

MM/DD/YY : Month / day / year

DD/MM/YY : day / month / year

- **TIME STYLE: For selecting the time display style**

24H : 24-hour time mode

12H : 12-hour time mode

These setting items are also reflected in the date/time record (DATE REC function).

On-screen status display

Set DISPLAY to ON or AUTO in the DISPLAY (1/2) Menu screen.

On-screen status display

```
32K CH-1/2          SP000min
03/04/03           STANDBY-OFF
12:00:00           TCR 02:00:00:00
```

Date/time display

Memo

- In the RECORDING or STOP mode : Displays the time of the built-in clock.
- In the Playback mode : The date and time recorded on the tape are displayed.
- In the DV recording mode : The date and time from the DV terminal are displayed.

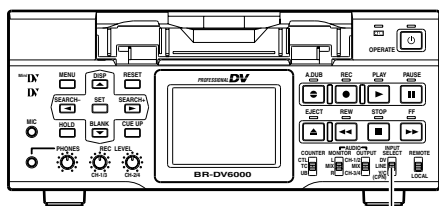

INPUT SELECT switch

■ Selecting input signal

Select the signal with the INPUT SELECT switch located on the front panel.

DV : For inputting DV signals (video and audio)

LINE : For inputting composite video and analog sound signals

Y/C (CPN) : For inputting Y/C separate signals or component signals for video. The type of signal to input can be selected with VIDEO INPUT SEL of the VIDEO Menu.

For sound, analog signals are input.

Memo

- For analog audio signals, if the AUDIO IN terminal and MIC terminal are used at the same time, the MIC terminal precedes.
- Audio signals are recorded on CH1 and CH2.
- Analog signals cannot be recorded when PB/DV IN is set to NTSC. In such a case, recording is not possible.
- For DV signal input, the AUDIO MODE setting cannot be performed. It will be the same mode as that of the input signal (48 K or 32 K).

■ Settings the VIDEO Menu (☞ Page 79)

● SET UP (only for NTSC)

Set here according to the existence of the setup of analog video signals (composite, YC separate and component). If it exists, set here to ON. If it does not, OFF.

● BLACK BURST

Set BLACK BURST to ON to record the black burst signals (black screen) of the built-in signal generator.

(When analog input is selected)

■ Settings of the AUDIO menu (☞ Page 78)

● AUDIO MODE

This is for selecting the audio sampling frequency for recording.

32 K: Recording in the 32 kHz mode. Select 32 K when performing audio dubbing on CH3 and CH4.

48 K: Recording in the 48 kHz mode. Audio dubbing is not available.

● AUDIO INPUT SEL (Displayed only when an optional board is installed)

This setting is required with XLR IN board SA-X61U (sold separately) installed. Set this item to XLR for selecting the audio input terminal of the XLR IN board.

■ Setting the SYSTEM Menu (☞ Page 73)

● LONG PAUSE TIME

This is for setting the time for BR-DV6000 to enter the tape protection mode if there is a long recording pause.

● INDEX WRITE: SYSTEM (2/2) Menu

This is for selecting whether to record index signals automatically when recording starts.

● PB/DV IN: SYSTEM (2/2) Menu

For recording PAL signals, set this item to PAL. For recording NTSC signals from the DV terminal, set this item to NTSC.

■ Setting the time code recording for DV signal input

Select data from the built-in time code generator or from the DV terminal with TC DUPLICATE in the TC/UB/CLOCK (1/2) Menu screen. (☞ Page 80)

■ Setting date/time recording

Perform setting for the following items.

- Set DATE REC in the TC/UB/CLOCK (2/2) Menu screen to ON.
- Set DISPLAY in the DISPLAY (1/2) Menu screen to ON.
- Set TIME/DATE in the DISPLAY (2/2) Menu screen to any setting item except OFF.

The same data as on the date/time on-screen display are recorded on a tape.

Memo

With DV signal input, data of the built-in clock are not recorded.

If video signals are input from the DV terminal, the date/time data from this terminal are recorded regardless of the menu settings.

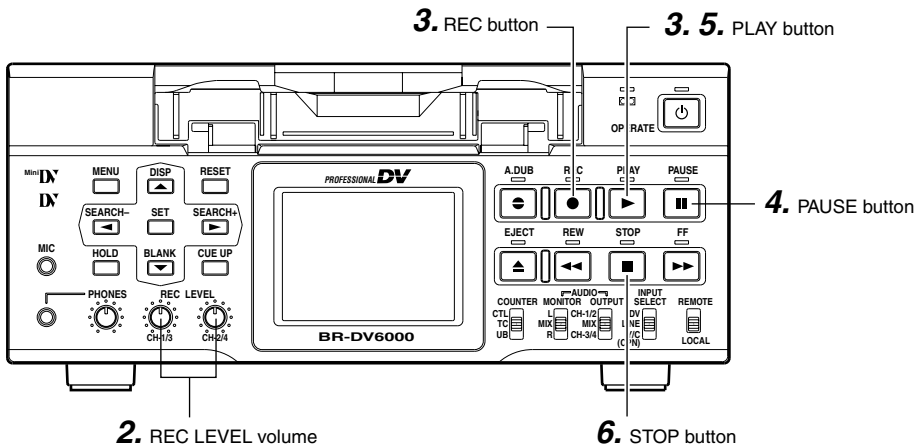

Memo

- The tape protection function enables BR-DV6000 automatically to go into the STOP mode when there is a long recording pause. The time to go into the STOP mode can be set with LONG PAUSE TIME in the SYSTEM (1/2) Menu screen.
- When a home-use DV VCR is used to play tapes recorded with BR-DV6000, the sound level may be reduced.

1. Load the cassette tape.

- Before loading the cassette tape, please ensure that the rear slide of the cassette tape is pushed to REC.
→ The unit is turned on.

2. Adjust the audio recording level.

- Adjust the REC LEVEL volume. Adjust it such a way that, with the maximum volume, the audio level meter does not display OVER.
* During DV input, the REC LEVEL volume cannot be adjusted.

3. Start recording.

- Press the PLAY button while holding down the REC button.

4. Pause recording.

- Press the PAUSE button.

5. Resume recording.

- Press the PLAY button.

6. Stop recording.

- Press the STOP button.

Recording index signals

If INDEX WRITE is set to ON in the SYSTEM (2/2) Menu screen, an index signal is recorded at the recording starting position of the tape. In the PLAYBACK mode, the position where the index signal is recorded can be searched. (Index search)

Memo

If recording is performed right after the RECORDING PAUSE mode is exited, index signals are not recorded.

■ Press the REC button to record index signals during recording

- * It is not possible to record only index signals after the recording. Allow at least an interval of 1 minute between recordings of index.
- * Index signals cannot be recorded with the REC button of the remote controller. Use the record button of BR-DV6000.

For tapes recorded in the 32 kHz audio mode, audio dubbing can be performed on CH3 and CH4 after the recording. (After-recording)

Notes

- For tapes recorded in the 48 kHz audio mode, audio dubbing cannot be performed.
- Audio dubbing cannot be performed for DV input signals.

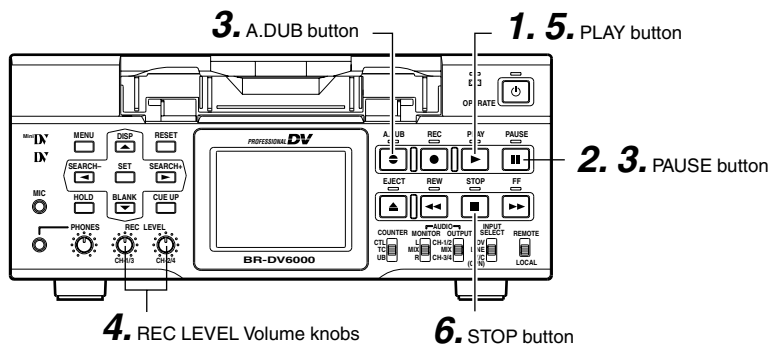

Connection

Audio dubbing sounds are input from the AUDIO IN terminal on the rear panel or the MIC terminal on the front panel. MIC terminal prevails over the AUDIO IN terminal.

Setting

- Set AUDIO MODE in the AUDIO Menu screen to “32 K.”
- Do not set the INPUT SELECT switch on the front panel to “DV.”

Operation

- 1. Press the PLAY button to play the tape.**
- 2. At the position where you wish to perform audio dubbing, press the PAUSE button.**
→ The unit enters the STILL mode.
- 3. Press the PAUSE button while holding down the A.DUB button.**
→ The unit enters the AUDIO DUBBING PAUSE mode.
- 4. Adjust the audio recording level.**
Recording level of the sound to be audio-dubbed can be adjusted with the REC LEVEL Volume knobs.
- 5. Press the PLAY button.**
→ Audio dubbing begins. Audio signals are recorded on CH3 and CH4.
 - To stop audio dubbing temporarily, press the PAUSE button.
- 6. To end audio dubbing, press the STOP button.**

Memo

- During audio dubbing, if the tape comes to a part recorded in a mode in which audio dubbing cannot be performed (such as LP mode or 48 kHz audio mode), the VCR will enter the STOP mode. When this happens, loud noise from the DV output may come out. Hence, before audio-dubbing, check the recording mode of the tape.
- In the case that a microphone is connected to the MIC terminal, MIC sound from this terminal will be recorded. In the absence of MIC input, signals from the CH1/3, CH2/4 AUDIO IN terminal on the rear panel will be recorded.
- When audio dubbing cannot be performed, an alarm message will be displayed on the monitor. (Page 25)
- Audio dubbing pause cannot be carried out directly in the STOP mode. Do so in the STILL mode.
During audio dubbing pause, sound from CH3/CH4 can be monitored, but sound output from the DV terminal is not possible.
- If audio dubbing is repeated on a short section of the tape, momentary noise may be produced when the section is played.
- During audio dubbing, noise may be produced on the playback video or EE sound, but the recording is not affected.
- The playback sound of CH1/2 cannot be recorded on CH3/4 (sound-on-sound).
- If unrecorded parts are found during backspace operation of audio dubbing, audio dubbing cannot be performed.
- When audio dubbing is performed on tapes recorded on other devices, it may not record correctly. Record with BR-DV6000 before performing audio dubbing.

RECORDING

- Backup recording function -

In combination with DV equipment, BR-DV6000 can perform continuous, long-hour recording. BR-DV6000 can be set as the backup unit connected to a DV camcorder (GY-DV300/DV500/DV550/DV5000, etc.). When the recording tape of the source unit nears its end, BR-DV6000 can start recording, enabling long-hour recording.

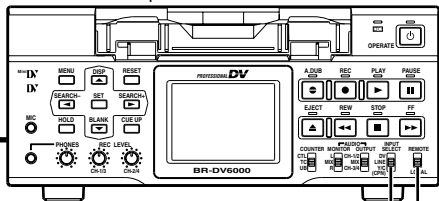
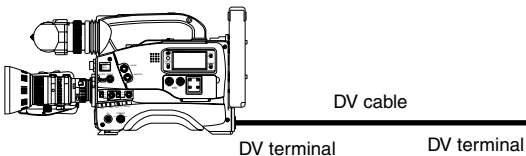

INPUT SELECT switch
REMOTE/LOCAL switch

Connection

Connect the DV terminal of the source unit to the DV terminal of BR-DV6000 with a DV cable.

Setting up BR-DV6000

- Set the **INPUT SELECT** switch on the front panel to "DV".
- Set the **REMOTE/LOCAL** switch on the front panel to "REMOTE".
- Set **BACKUP REC TIME** in the **SYSTEM (1/2) Menu screen**.

Use the following settings according to the tape length of the source unit.

* For DV or mini DV cassette tape:

25MIN	: 30-minute tape
55MIN	: 60-minute tape
75MIN	: 80-minute tape
115MIN	: 120-minute tape
175MIN	: 180-minute tape
265MIN	: 270-minute tape
OFF	: No backup recording

Memo

With **REPLICATION** in the **SYSTEM (2/2) menu screen** set to "DV", **BACKUP REC TIME** is fixed to "OFF". For using the backup recording function, set **REPLICATION** to "OFF" or "SERIAL".

- Set the **REMOTE SEL DV** in the **REMOTE (1/2) Menu screen** to **ON** or **LOC+REM**.
- Set **TC DUPLICATE** in the **TC/UB/CLOCK (1/2) Menu screen** to **OFF**.
 - It records the data of the built-in time code generator.
 - When **TC DUPLICATE** is set to **AUTO**, the time code of the DV camcorder will stop advancing. If the DV cable is disconnected, the time code of the backup recording will stop advancing.
- For using **GY-DV5000** as the source unit
Set **DV REC TRIGGER** in the **OTHERS (1/2) Menu screen** of **GY-DV5000** to **OFF**.

Operation

1. **Recording begins on the source unit.**
 - * Ensure that recording starts from the beginning of the recording tape.
2. **BR-DV6000 begins recording when the tape of the source unit nears its end (about 5 minutes before the end of the tape).**
 - BR-DV6000 begins recording when the recording time of the source unit reaches the time set by **BACKUP REC TIME**.

Memo

- In backup recording, BR-DV6000 records video/sound from the source unit. While this unit is performing backup recording, continue shooting from the source unit.
- The audio mode is the one selected in the source unit. (32 K/48 K)
- Set **BACKUP REC TIME** to "OFF" if the unit is not performing backup recording.

RECORDING

- Recording with serial remote terminals -

Recording can be turned ON/OFF with a serial remote controller or foot switch connected to the SERIAL REMOTE IN terminal located at the rear panel of BR-DV6000.

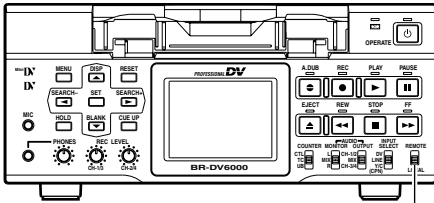

REMOTE/LOCAL switch

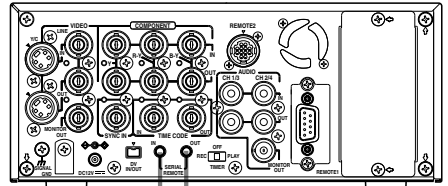

SERIAL IN SERIAL OUT

REMOTE (1/2) Menu screen

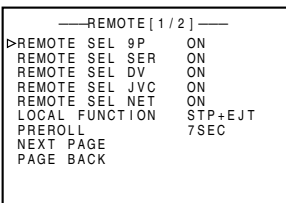

Memo

- Besides recording, the serial remote controller can perform other functions.
- If the REMOTE SEL SER is set to ON, unit buttons that can be operated can be selected from LOCAL FUNCTION in the REMOTE (1/2) Menu screen.

REMOTE (2/2) Menu screen

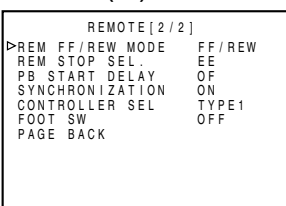

Connection

- Serial remote controller: RM-G30
- Foot switch

The serial remote controller (RM-G30, sold separately) can be connected to the SERIAL REMOTE IN terminal located on the rear panel of BR-DV6000.

The input signals of the SERIAL REMOTE IN terminal can be through-output from the SERIAL REMOTE OUT terminal. (Only with OPERATE ON)

Setting

To use the SERIAL IN terminal, set REMOTE SEL SER in the REMOTE (1/2) Menu screen to ON or LOC+REM. Then, set the REMOTE/LOCAL switch on the front panel accordingly.

• REMOTE SEL SER

ON : When the REMOTE/LOCAL switch is set to REMOTE, operations can be performed via the SERIAL REMOTE IN terminal.

LOC+REM: With the REMOTE/LOCAL switch is set either way, operations can be performed via the SERIAL REMOTE IN terminal. With this setting, the buttons and switches of the unit can be used too.

Set FOOT SW in the REMOTE (2/2) Menu screen according to how the serial remote terminal is used.

OFF : Set to OFF when the serial remote controller is used. The footswitch cannot be used.

L EDGE : Recording and recording pause is switched at the LOW edge of the footswitch signal.

H EDGE : Recording and recording pause is switched at the HIGH edge of the footswitch signal.

L LEVEL : Recording is performed at the LOW edge and paused at the HIGH edge of the footswitch signal.

Operation

Before using the foot switch, set BR-DV6000 to the RECORDING or RECORDING PAUSE mode using the relevant buttons of the unit. (Only with L EDGE and H EDGE)

Memo

- The foot switch can only be used to switch between RECORDING ON and OFF.
- The foot switch can be operated regardless of the setting of the REMOTE/LOCAL switch.

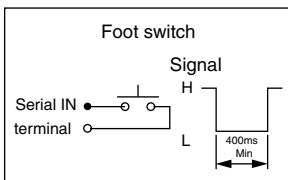

RECORDING

- External timer recording -

BR-DV6000 can start recording automatically when the power is supplied. Using a commercially available timer, recording can start at a pre-determined time.

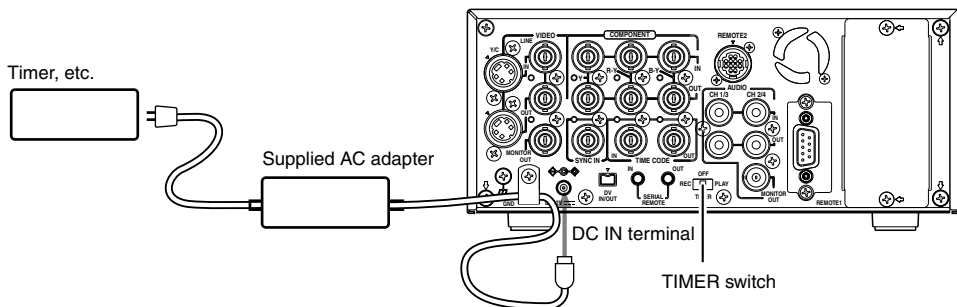

Memo

Use an external timer exclusively to control the start of VCR operation. If the power is cut off by an external timer and the VCR operation is stopped while the tape is running, BR-DV6000 or the tape may be damaged.

■ Connect the supplied AC adapter.

To set the power supply to be activated by a timer, plug the power cord of the AC adapter to the power output terminal of the timer.

1. Set the REMOTE/LOCAL switch on the front panel to "LOCAL".
2. Select the video or sound to be recorded with the INPUT SELECT switch on the front panel.
With VIDEO INPUT SEL in the VIDEO Menu screen, either the YC separate signal or the component signal can be selected.
3. Adjust the recording level of sound.
* During DV input, the sound recording level cannot be adjusted.
4. Load a cassette tape for recording.
5. Set the TIMER switch on the rear panel to "REC".

OFF
REC PLAY
TIMER

If the DISP button on the front panel is pressed to change the LCD display to the enlarged mode, the timer symbol ⌚ lights up in red.

6. Set the time, etc., of the external timer.

When the power is supplied to the unit, recording starts automatically.

7. To stop recording, press the STOP button.

8. To stop the external timer recording mode, set the TIMER switch to "OFF".

The timer symbol ⌚ of the LCD disappears.

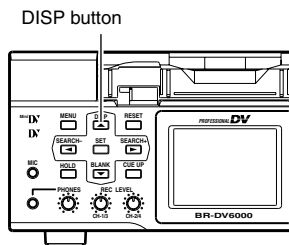

LCD display

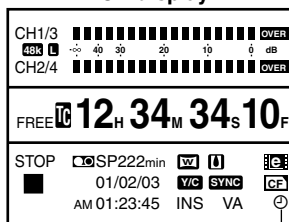

Timer symbol

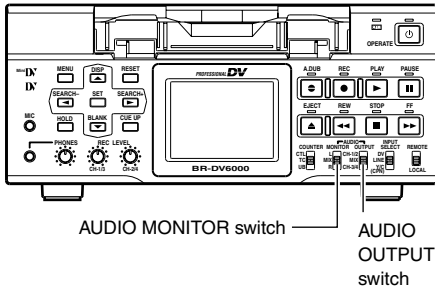

■ Setting the switches on the front panel

● AUDIO OUTPUT switch

To play back tapes recorded in the 32kHz mode, use this switch to select the audio channel for output signals from the AUDIO OUT terminal, AUDIO MONITOR OUT terminal or the PHONES terminal (CH 1/2, CH 3/4, MIX). In the 48kHz mode, the sound of CH1 and CH2 is output regardless of the setting of this switch.

● AUDIO MONITOR switch

Use this switch to select the audio channel for output signals from the AUDIO MONITOR OUT (monaural) or PHONES terminal (L, MIX, R) (☞ Page 13)

SYSTEM (1/2) Menu screen

```

---SYSTEM [ 1 / 2 ] ---
> SYNC SELECT      AUTO
STL / F. ADV MODE  2ND
BACKUP REC TIME   OFF
LONG PAUSE TIME   5MIN
LONG PAUSE MODE   F. ADV
< > KEY FUNC.     INDEX
REPEAT MODE       OFF
NEXT PAGE
PAGE BACK
    
```

VIDEO Menu screen

```

---VIDEO---
VIDEO INPUT SEL   Y/C
> SET UP (NTSC)   OFF
BLACK BURST       OFF
PAGE BACK
    
```

AUDIO Menu screen

```

---AUDIO---
AUDIO MODE        48K
> A. OUT SEARCH   ON
AUDIO INPUT SEL   RCA
AUDIO OUT LEV     -20dB
V. FADE           ON
PAGE BACK
    
```

■ SYSTEM Menu screen (☞ Page 72)

● SYNC SELECT

This is for setting whether to use the internal signal or the input video signal as the synchronization signal during playback if there is no input of synchronization signals to the SYNC IN terminal.

AUTO : Input video signal

EXTERNAL : Internal signal

● STL/F.ADV MODE

This mode is for selecting still images or images of frame-advance playback. (Field image, 1st field image, 2nd field image and frame image)

Memo

Output images from the DV terminal are fixed to the 1st field images.

● LONG PAUSE TIME

For setting the time (minute) when BR-DV6000 enters the tape protection mode if BR-DV6000 is in the STILL mode for a long time. (5, 3, 2, 1 minute or 30 seconds)

● LONG PAUSE MODE

For selecting the state of BR-DV6000 when it enters the tape protection mode after it stayed in the STILL mode for a prolonged period of time. (F.ADV or STBY-OFF)

● REPEAT MODE

This mode is for turning ON/OFF the REPEAT PLAYBACK function and selecting the type of REPEAT PLAYBACK. If REPEAT PLAYBACK is not performed, set it to OFF. (OFF, INDEX, V. END, TAPE END)

● PB/DV IN: SYSTEM (2/2) Menu

Set this item according to the signal format of the tape to be played.

Set here to PAL for a tape recorded in PAL.

■ VIDEO Menu (☞ Page 79)

● SET UP (for NTSC only)

For selecting whether to enable SET UP for analog video output signals (composite, Y/C separate or component).

■ AUDIO Menu (☞ Page 78)

● A. OUT AT SEARCH

For selecting whether sound is output during variable speed playback.

● AUDIO OUT LEVEL

For selecting the reference level of the audio output level. (-20dB, -12dB)

Set it to -12dB to playback tapes recorded at -12dB on a home-use DV machine.

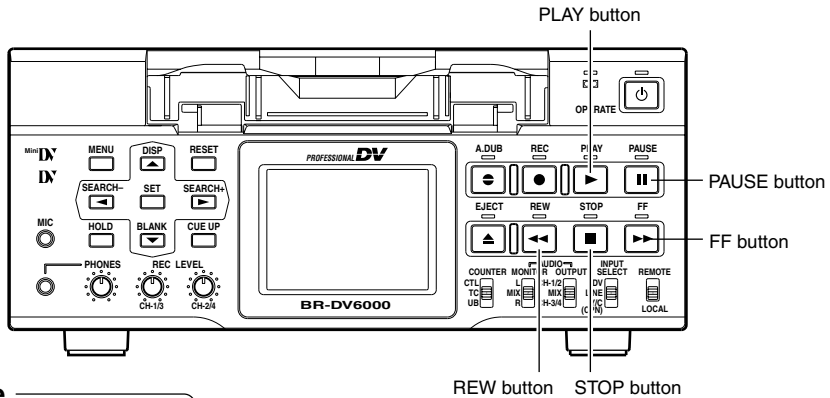

Note

Tapes recorded in the LP mode cannot be played. The monitor displays an alarm message: "LP TAPE!"

Memo

- Images cannot be produced properly if the signal format selected for PB/DV IN in the SYSTEM (2/2) Menu screen is different from the one of the tape to be played.
- When output of still image continues for a prolonged period, BR-DV6000 enters the tape protection mode. The time can be selected from LONG PAUSE TIME in the SYSTEM Menu screen.
- Tapes recorded in DVCAM format can be played back on the BR-DV6000, detection is automatic.

Playback of tapes recorded in the NTSC format

BR-DV6000 can be used with PAL or NTSC standards. Please select the desired format in the menu.

- Set PB/DV IN in the SYSTEM (2/2) Menu screen to NTSC for playing a tape recorded in NTSC.
- Signal systems cannot be converted.

1. Load a recorded cassette tape.

→ The power for BR-DV6000 is turned on.

2. Start playback.

Press the PLAY button.

→ Playback starts. If the tape is recorded in the DVCAM format, the status display of the recording/playback speed mode (SP/LP) disappears from the monitor or LCD.

3. Pause the tape.

Press the PAUSE button.

→ A still image is output.

Memo

The still image selected with STL/FADV MODE in the SYSTEM (1/2) Menu screen is output. (1st field image/ 2nd field image/ Frame image)

4. Resume playback.

Press the PLAY button.

5. Stop playback.

Press the STOP button.

Fast forward/rewind

■ When BR-DV6000 is in the STOP mode, press the FF button to fast-forward the tape.

■ When BR-DV6000 is in the STOP mode, press the REW button to rewind the tape.

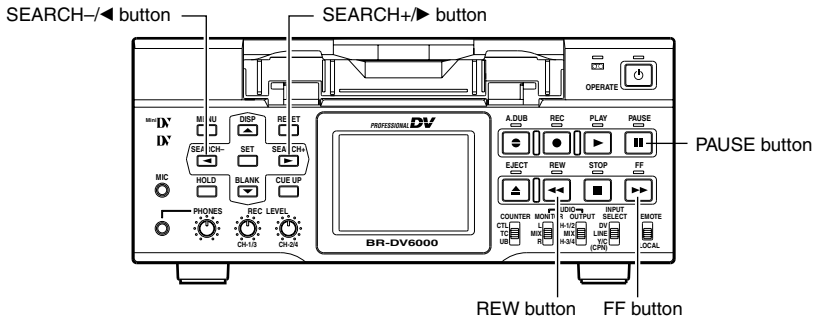

Frame-advance playback

SYSTEM (1/2) Menu screen

```

---SYSTEM[1/2]---
SYNC SELECT      AUTO
>STL/F. ADV MODE 2ND
BACKUP REC TIME OFF
LONG PAUSE TIME 5MIN
LONG PAUSE MODE  F. ADV
"◀▶" KEY FUNC.  VAR
REPEAT MODE      OFF
NEXT PAGE
PAGE BACK
    
```

Setting

■ STL/F. ADV MODE in the SYSTEM (1/2) Menu screen

The unit of frame advance and still images can be selected.

FIELD : Field-by-field advance

1st FIELD : Frame-by-frame advance and stops at the 1st field.

2nd FIELD : Frame-by-frame advance and stops at the 2nd field.

FRAME : Frame-by-frame advance.

Operation

1. Set BR-DV6000 to the STILL mode.
2. Press the PAUSE button to perform frame advance.

Search mode

Memo

- Whether to enable/disable audio out in the SEARCH mode can be selected with A. OUT AT SEARCH in the AUDIO Menu screen.
- Playback at ± 0.1 X speed is step-slow playback (continuous frame-advance playback / frame-reverse playback).
- During slow-playback or frame-advance, noise is generated to the output images from the DV terminal. For recording slow-playback images, use analog output signals of BR-DV6000.

Setting

- Set "◀▶" KEY FUNC in the SYSTEM (1/2) Menu screen to VAR.

Operation

1. Set BR-DV6000 to the PLAYBACK or the STILL mode.
 2. Press the FF button to start fast-forward playback.
Press the REW button to start reverse playback.
- Press the SEARCH+ button to increase the search speed. Every time you press this button, the speed increases more.
 - Press the SEARCH- button to decrease the search speed. Every time you press this button, the speed decreases more.

Search speed

SEARCH+ button → (Fast) (Slow) ← SEARCH- button
 $\times -20... \times -10... \times -5... \times -2... \times -1... \times -0.5... \times -0.33... \times -0.2... \times 0.1... \text{STILL} \times 0.1... \times 0.2... \times 0.33... \times 0.5... \times 1(\text{PLAY})... \times 2... \times 5... \times 10... \times 20$

‡ The maximum speed in the DVCAM mode is 15X.

Increasing the playback speed by 7% or decreasing the speed by 10%

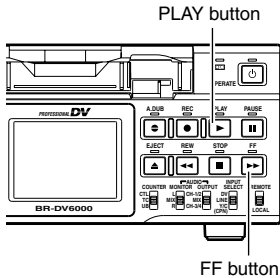

Increasing the playback speed by 7%

1. Set BR-DV6000 to the PLAYBACK, STILL or STOP mode.
2. Press the FF button while holding down the PLAY button. While the buttons are held down, the playback speed is increased by 7%.
3. When the buttons are released, the operation changes as follows.
 - If the PLAY button is released first, playback continues at the increased speed of +7%. (Latch mode)
To return to the normal playback speed, press the PLAY button.
 - If the FF button is released first, it returns to the normal playback speed.

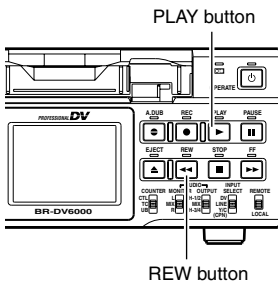

Decreasing the playback speed by 10%

1. Set BR-DV6000 to the PLAYBACK, STILL or STOP mode.
2. Press the REW button while holding down the PLAY button. While the buttons are held down, the playback speed is decreased by 10%.
3. When the buttons are released, the operation changes as follows.
 - If the PLAY button is released first, the playback continues at the decreased speed of -10%. (Latch mode)
To return to the normal playback speed, press the PLAY button.
 - If the REW button is released first, it returns to the normal playback speed.

Index search

This function searches to the position where the index signal is recorded.

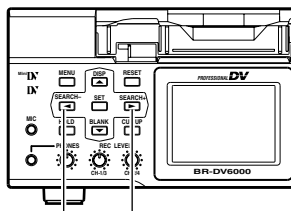

SEARCH- button SEARCH+ button

Monitor screen

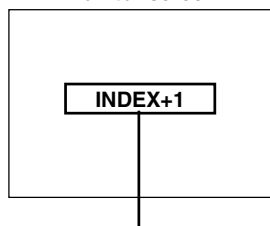

Index search progressing:
displayed on the screen

(The number denotes the corresponding index position.)

Setting

Set “◀, ▶” KEY FUNC in the SYSTEM (1/2) Menu screen to INDEX.

Operation

■ To search an index point in the forward direction from the current tape position:

- Press the SEARCH + button.
The index position to be searched can be specified by the number of times this button is pressed. (Max: 99)

■ To search an index point in the reverse direction from the current tape position:

- Press the SEARCH – button.
The index position to be searched can be specified by the number of times this button is pressed. (Max: 99)

■ When the SEARCH + or SEARCH – button is pressed, the unit fast-forwards or rewinds to the specified index position and start playing.

Memo

- If the interval between index signals is less than one minute, the function may not work well.
- The specifications for index signal recording varies with the device used.

Blank search

This function searches unrecorded parts of the tape.

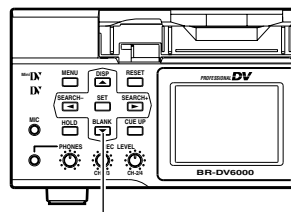

BLANK button

Monitor screen



■ In the STOP mode, press the BLANK button.

- • If the current position is at a recorded part of the tape, BR-DV6000 fast-forwards until an unrecorded part is reached and stops there.
- If the current position is an unrecorded part of the tape, BR-DV6000 will first advance the tape in the forward direction for confirmation and thereafter rewind and go into the STILL mode at the last recorded position.
- During a blank search, “BLANK SEARCH” is displayed on the monitor.

Three types of repeat playback are available for BR-DV6000.

The repeat playback function can be set with REPEAT MODE in the SYSTEM (1/2) Menu screen.

SYSTEM (1/2) menu screen

```
—SYSTEM[1/2]—
SYNG SELECT      AUTO
STL/F.ADV MODE  2ND
BACKUP REC TIME OFF
LONG PAUSE TIME 5MIN
LONG PAUSE MODE F.ADV
◀,▶ KEY FUNC.   INDEX
▶REPEAT MODE     OFF
NEXT PAGE
PAGE BACK
```

INDEX repeat playback

- If no index signal is detected during playback, the tape will run until the end. If no index signal is detected during rewind, the tape will rewind until the beginning.
- If the interval between index signals is less than one minute, the function may not work well.

Memo

If the head is dirty, repeat playback may not work well.

Setting

■ REPEAT MODE in the SYSTEM (1/2) Menu screen

- OFF** : No repeat playback.
- INDEX** : Repeat playback between positions where index signals are recorded.
- V. END** : Repeat playback from the beginning of the tape to the position where recording of video signals ends.
- TAPE END** : Repeat playback from the beginning to the end of the tape.

Operation

1. Press the REW button to rewind the tape to the beginning.
2. Press the PLAY button to start playback.
 - When it reaches the position set at REPEAT MODE, the tape starts rewinding and plays back again.

- To abort the repeat playback function, press the STOP button.

Repeat operation

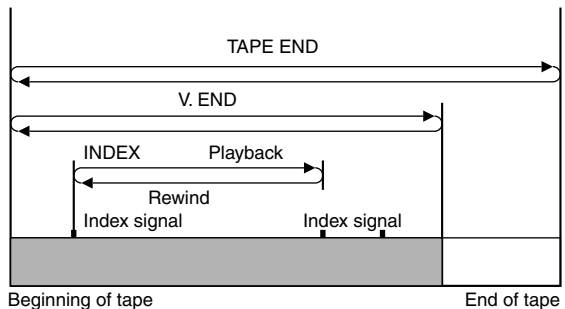

Using the time codes recorded on the tape, up to 5 points on the tape can be registered as cue-up points at the Multi Cue-up screen. The registered tape positions (cue-up points) can be searched.

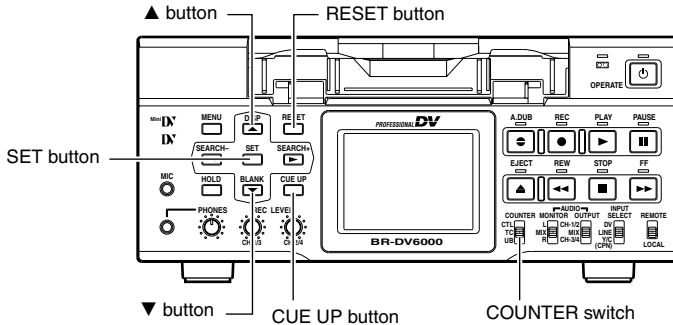

Registering cue-up points

1. Set the **COUNTER** switch to TC.
2. Load a tape with time codes recorded.
3. Press the **CUE UP** button.
→ The CUE UP screen appears on the monitor or the LCD.
4. Perform playback or search. At the position to be registered, set it to the **STILL** or **STOP** mode.
5. Press the **▲** or **▼** button to bring the cursor to the cue-up point. Press the **SET** button.
→ Register the time code data of the current position as a cue-up point.
 - If no tape is loaded, "00" is registered.
 - Cue-up points can be registered while the tape is being played back.
6. To register more cue-up points, repeat steps 4 and 5. Up to 5 cue-up points can be registered.

Memo

For details on time code setting and recording:
(Page 59)

Cursor

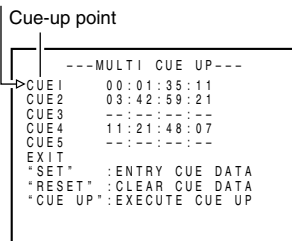

Multi Cue-up screen

Clearing registered cue-up points

Press the **▲** or **▼** button to bring the cursor to the cue-up point to be cleared. Press the **RESET** button.
→ After a cue-up point is cleared, "--" is displayed.

SET
button

▲ button

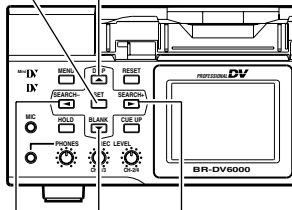

◀ button ▼ button ▶ button

Memo

If the COUNTER switch is set to CTL or UB while the Multi Cue-up screen is being displayed, the display returns to the normal screen.

Changing cue-up points

- ① Press the ▲ or ▼ button to bring the cursor to the cue-up point to be changed. Press the ▶ button.
→ The hour digits of the registered time code display blink.
Press the ▶ button to select the digit to be changed.
- ② Press the ▲ or ▼ button again to change the time code.
Press the ▲ button to increase the time code data by 1 frame.
Press the ▼ button to decrease the time code data by 1 frame.
- ③ Press the SET button to register the changed time code.
If no time code is to be registered, do not press the SET button.
Instead, press the ◀ button to make the blinking time code display disappear.

Exiting the Multi Cue-up screen

Press the ▲ or ▼ button to bring the cursor to EXIT. Press the SET button.

→ The display of the monitor or the LCD returns to the normal screen.

Searching cue-up points

▲ button

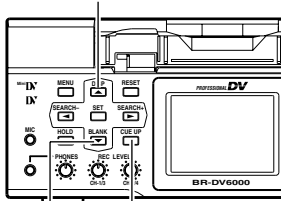

▼ button CUE UP button

1. Set the COUNTER switch to TC.
2. Press the CUE UP button when the normal screen is displayed.
→ The Multi Cue-up screen appears on the monitor or the LCD.
3. Press the ▲ or ▼ button to bring the cursor to the cue-up point to be searched.
4. Press the CUE UP button.
→ The cue-up operation for the selected point is performed.

Cue-up point

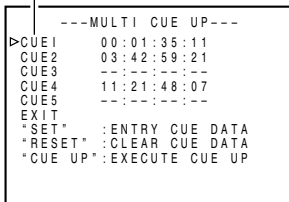

Multi Cue-up screen

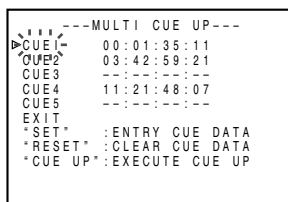

During cue-up operation

While searching is being performed, the cue-up point to be searched flashes on the monitor or the LCD.

Memo

- For cue-up operation, use tapes with continuous time codes recorded.
- If the COUNTER switch is set to CTL or UB while the Multi Cue-up screen is being displayed, the COUNTER mode does not change.

PLAYBACK

- External timer playback -

The unit can start playing automatically when the power is supplied. Using a commercially available timer, playback can start at a pre-determined time.

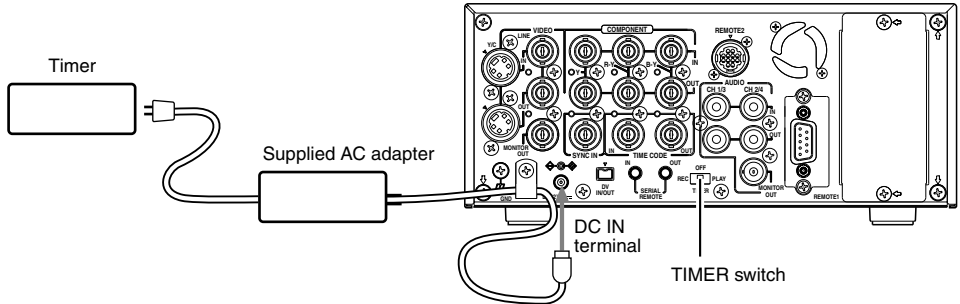

Memo

Use an external timer exclusively to control the VCR operation. If the power is cut off by an external timer and the VCR operation stopped while the tape is running, BR-DV6000 or the tape may be damaged.

■ Connect the supplied AC adapter.

To set the power supply power to be activated by a timer, plug the power cord of the AC adapter to the power output terminal of the timer.

1. Load the tape for playback.
2. With REPEAT MODE in the SYSTEM (1/2) Menu screen, whether to enable/disable repeat playback, and the type of repeat playback, can be selected.
3. Set the TIMER switch on the rear panel to "PLAY".

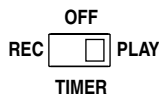

If the DISP button on the front panel is pressed to change the LCD display to the enlarged mode, the timer symbol lights up in green.

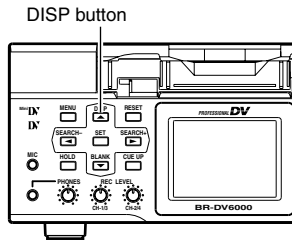

LCD Display

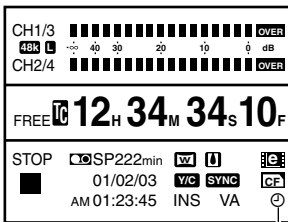

Timer symbol

4. Set up the time, etc., of the external timer.

When the power is supplied to the unit, playback starts automatically. If the repeat playback mode is selected, repeat playback is executed.

5. To stop playback, press the STOP button.

6. To stop the external timer playback mode, set the TIMER switch to "OFF".

The timer symbol of the LCD disappears.

PLAYBACK

- Dubbing with another machine using the SERIAL REMOTE OUT/DV terminals -

When the REPLICATION function is turned ON and BR-DV6000 is set to the PLAYBACK mode, the REC command will output from the SERIAL REMOTE OUT terminal or the DV terminal. With this function, the video and sound being played back on BR-DV6000 can be dubbed by another machine by simply pressing the PLAY button.

■ For recording analog video and audio signal, use the SERIAL REMOTE OUT terminal.

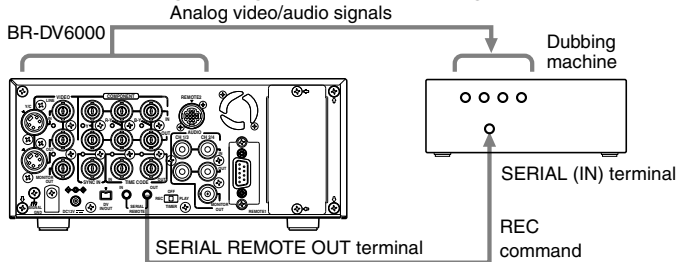

Memo
For information on connection with the SERIAL REMOTE OUT terminal:
(Page 34)

■ For recording digital video and audio signals, use the DV terminal.

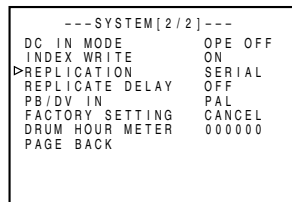
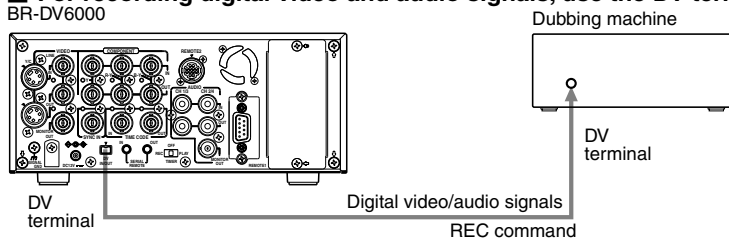

SYSTEM (2/2) Menu screen

Setting

■ BR-DV6000

- For using the DV terminal, set **BACKUP REC TIME** in the **SYSTEM (1/2) menu screen** to "OFF".
- Set the items in the **SYSTEM (2/2) Menu screen**.
 - Set **REPLICATION** to **SERIAL** or **DV** depending on the terminal.
 - To delay the output timing for the REC command in the **PLAYBACK** mode, set **REPLICATE DELAY** (**OFF**, 1 - 5 seconds).
If the DV terminal is to be used, set **REPLICATE DELAY** to a larger value.

■ Dubbing machine

- When the **SERIAL** terminal is to be used, select the mode that can receive commands of the **SERIAL (IN) terminal**.
- When the **DV** terminal is to be used, select the **DV input mode**.

Operation

1. Load a tape for playback into BR-DV6000 and a tape for recording into the dubbing machine.
2. Press the **PLAY** button to set BR-DV6000 into the **PLAYBACK** mode.
 - The unit outputs the REC command from the **SERIAL REMOTE OUT** terminal or the **DV** terminal and the dubbing machine starts recording.
3. To stop recording, press the **STOP** button of the dubbing machine.
4. To exit from the **REPLICATION** mode, set **REPLICATION** to **OFF**.

Memo

With the DV terminal in use, this function and the backup recording function cannot be operated at the same time.

BR-DV6000 can record and play back EBU-compliant time code and user's bit. Whether to record the user's bit can be selected with U-BIT in the TC/UB/CLOCK (2/2) Menu screen. With the time code function, accurate positions of the tape contents can be specified to enhance editing precision and operation efficiency. During recording or playback, the time code and user's bit are displayed on the monitor or the LCD.

TCG : Time code generator data
 TCR : Time code reader data
 DTCG : Input time code data from the DV IN/OUT terminal
 ETCG : Input time code data from the TIME CODE IN terminal
 UBG : User's bit generator data
 UBR : User's bit reader data
 DUBG : User's bit input data from the DV IN/OUT terminal
 EUBG : User's bit input data from the TIME CODE IN terminal

Status display (Monitor/ LCD)

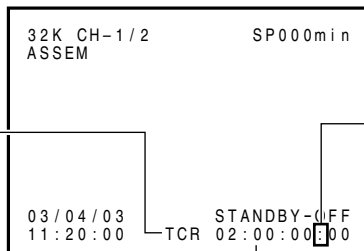

Framing mode
 (for NTSC only)
 : (colon) : Non-drop frame
 . (dot) : Drop frame

Time code/User's bit display

During recording : Data of time code generator
During playback : Data recorded on the tape
During DV input : Data selected with TC DUPLICATE in the TC/UB/CLOCK Menu screen

DISPLAY (1/2) Menu screen

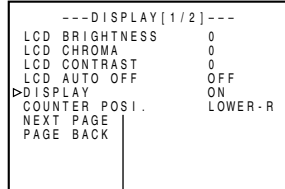

The display position can be selected.

DISPLAY (2/2) Menu screen

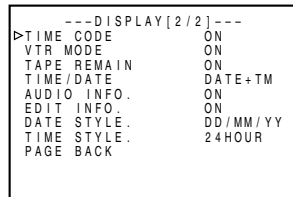

■ To display the time code/ user's bit, perform the following settings.

- Set DISPLAY in the DISPLAY (1/2) Menu screen to ON or AUTO.
 → The status is displayed on the monitor or the LCD.
- Set TIME CODE in the DISPLAY (2/2) Menu screen to ON.
 → The time code, user's bit or CTL counter is displayed at the counter display section of the status display.
- Select the counter display mode with the COUNTER switch on the front panel.

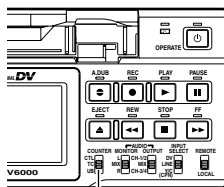

COUNTER switch

- To display the time code, select TC.
- To display the user's bit, select UB.

Checking the data of time code generator

When it is in the STOP mode, press the REC button and the data of the time code generator will be displayed while the button is held down.

TIME CODE

- Presetting the time code -

Variable values can be set for the time code and the user's bit for efficient material management and editing.

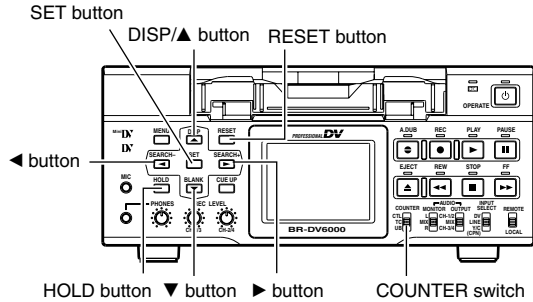

TC/UB/CLOCK(1/2) Menu screen

```

---TC/UB/CLOCK(1/2)---
>TCG SOURCE      INTERNAL
TCG SELECT       PRESET
TCG MODE         REC-RUN
NDF/DF(NTSC)    ---
DF BIT(PAL)      ON
TC DUPLICATE     OFF
TC OFFSET        OFF
NEXT PAGE
PAGE BACK
    
```

Setting ...TC/UB/CLOCK(1/2) Menu screen

- Set TCG SOURCE to "INTERNAL".
- Set TCG SELECT to "PRESET".
- TCG MODE:

REC-RUN : The time code runs only during recording.

FREE-RUN : The time code runs from the point when the preset is completed.

* In the case of the user's bit, setting is not required.

LCD display

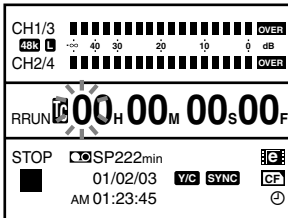

Operation ... Perform setting while checking the LCD display.

This section describes the setting of the time code. The setting of the user's bit is the same. Values that can be used to configure the user's bit are hexadecimal numeral from 0 – F.

1. Set the counter switch to TC.
(For user's bit, set the switch to UB.)
2. Press the DISP button to change the LCD to its enlarged display mode.
3. In the STOP mode, press the HOLD button.
→ The hour digit of the counter starts blinking.
4. Press the ▲ or ▼ button to change the value.
5. Press the ► or ◀ button to move blinking to the next digit.
6. Press the ▲ or ▼ button to change the value of the blinking digit.
7. Repeat steps 5 and 6 to perform the necessary settings.
8. Press the SET button to confirm the setting value and blinking of the counter stops.

Memo

- To stop the setting, press the HOLD button to return to the normal screen.
- To preset all digits to 0, press the RESET button when any of the digits is blinking.
- When the hour digit is blinking, the frame digit starts blinking when the ◀ button is pressed.
- If a user's bit is input with its all digits set as "F", BR-DV6000 converts FFFFFFFF to FFFFFFFE before recording.

Time codes can be recorded with the following ways. Whether to record user's bit can be selected with U-BIT in the TC/UB/CLOCK (2/2) Menu screen.

- Record it from preset data.
- Record it following the one last recorded on the tape.
- Record the time code, which is input to the DV IN/OUT terminal.
- Record the time code from an external time code generator.

Recording from preset data

Record preset time code data to the internal time code generator in the TIME CODE Preset screen.

TC/UB/CLOCK(1/2) Menu screen

```

--TC/UB/CLOCK(1/2)--
▷TCG SOURCE      INTERNAL
TCG SELECT      PRESET
TCG MODE        REC·RUN
NDF/DF(NTSC)   --
DF BIT(PAL)    ON
TC DUPLICATE    OFF
TC OFFSET      OFF
NEXT PAGE
PAGE BACK
    
```

Setting

- Set the TC/UB/CLOCK(1/2) Menu as follows.

TCG SOURCE : INTERNAL
 TCG SELECT : PRESET
 TCG MODE : REC RUN or FREE RUN

Operation

1. Check the preset time code.

- ① Set the COUNTER switch to TC or UB.
- ② In the STOP mode, hold down the REC button.
 - The preset time code or the user's bit is displayed on the monitor or the LCD. The counter mode is displayed as TCG or UBG.
- ③ When the REC button is released, it returns to the original display.

2. Record.

- Press the PLAY button while holding down the REC button.
- The time code and user's bit are recorded.
 - To stop recording, press the STOP button.

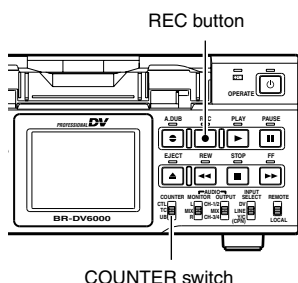

Preset time code

- Stopping the power supply to the DV IN terminal of BR-DV6000 cancels the preset value of the time code generator.
- With FREE RUN, if the mode is changed from OPERATE ON to OPERATE OFF and back to OPERATE ON before BR-DV6000 is restarted, the advance of the time generator may deviate. Do not change the mode to OPERATE OFF to keep the time generator data agreed with those of other machines.

Recording time code following the one last recorded on the tape

BR-DV6000 is equipped with a time code reader. When it enters the RECORD mode from the RECORDING PAUSE mode, it reads the time code data already recorded on the tape and continues recording time code from that value. (Regeneration)

TC/UB/CLOCK(1/2) Menu screen

```
---TC/UB/CLOCK(1/2)---
>TCG SOURCE      INTERNAL
TCG SELECT       REGEN
TCG MODE         REC-RUN
NDF/DF(NTSC)    ---
DF BIT(PAL)     ON
TC DUPLICATE     OFF
TC OFFSET       OFF
NEXT PAGE
PAGE BACK
```

Setting

- Set the TC/UB/CLOCK(1/2) Menu as follows.

TCG SOURCE : INTERNAL
TCG SELECT : REGEN
TCG MODE : No setting required. It will be in the same running mode as the tape.

Operation

1. Insert a tape with time codes recorded.
2. Set BR-DV6000 to the RECORDING PAUSE mode at the position where time codes are to be recorded again.
3. Press the PLAY button to go to the RECORDING mode.
 - Time codes will be recorded on the tape, starting from where it stopped at last recording.The counter mode display shows either TCR or UBR.

Recording time code, input to the DV IN/OUT terminal

TC/UB/CLOCK(1/2) Menu screen

```
---TC/UB/CLOCK(1/2)---
TCG SOURCE      INTERNAL
TCG SELECT       PRESET
TCG MODE         REC-RUN
NDF/DF(NTSC)    ---
DF BIT(PAL)     ON
>TC DUPLICATE    AUTO
TC OFFSET       OFF
NEXT PAGE
PAGE BACK
```

Setting

- Set the INPUT SELECT switch on the front panel to DV.
- Set TC DUPLICATE in the TC/UB/CLOCK(1/2) Menu screen to AUTO.

Operation

1. Check the time code of the DV input terminal.

Press the REC button when BR-DV6000 is in the STOP mode to display the time code on the monitor or the LCD. It will be displayed while the button is held down.

The counter mode display shows DTCCG or DUBG.
2. Select the RECORDING mode.
 - Record time codes from the DV input terminal.

Memo

Time codes input to the TIME CODE IN terminal are ignored.
Do not connect any device to the TIME CODE OUT terminal.

Memo

- For date/time also, data from the DV IN terminal are recorded.
- When this terminal is connected to a D9 VCR, data/time data are not recorded.

Record time codes from an external time code generator

Synchronize the internal time code generator with the EBU-compliant LTC time code, which is input from the TC IN terminal. After synchronization (slave lock), the internal time code generator continues to run even if external time code signals are not input.

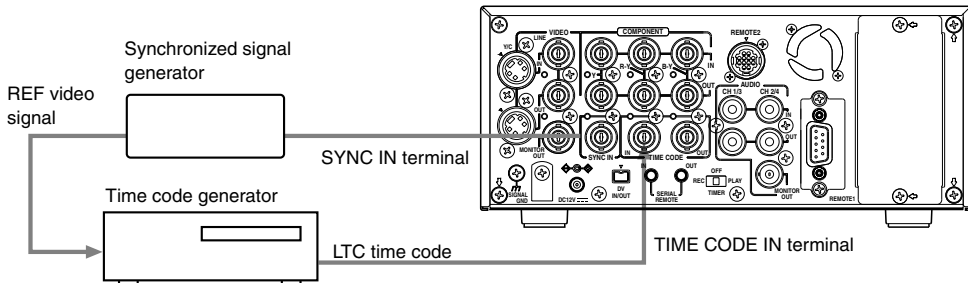

Connection

- Input reference video signals to the external time code generator and the SYNC IN terminal of BR-DV6000.
- Connect the TIME CODE IN terminal of BR-DV6000 with the LTC time code output terminal of the external time code generator.

TC/UB/CLOCK(1/2) Menu screen

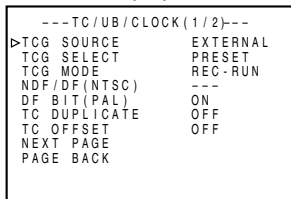

Setting

■ Front switches

- Set the INPUT SELECT switch to any setting except DV.
- Set the COUNTER switch to "TC".
- Press the DISP button and set the LCD to the enlarged display mode.

■ TC/UB/CLOCK(1/2) Menu screen

Set TCG SOURCE to "EXTERNAL".

Memo

- If the phase of the external time code generator and the phase of the video are not synchronized, the "EXT" display blinks.
- If a user's bit is input to the TIME CODE IN terminal with its all digits set as "F", BR-DV6000 converts FFFFFFFF to FFFFFFFE before recording.

Operation

1. Perform setting for the external time code generator.

2. Set BR-DV6000 to the RECORDING mode.

→ The EXT display of the LCD lights up and the time code and user's bit of the external time code generator are recorded on the tape.

During recording, if the internal time code generator is slave-locked once, the time code continues to run even if the input time code stops.

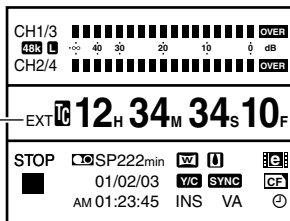

EXT display

TIME CODE

- Playing back the time code -

BR-DV6000 is also equipped with a time code reader. During playback, the time code or user's bit data recorded on the tape is displayed on the monitor or the LCD.

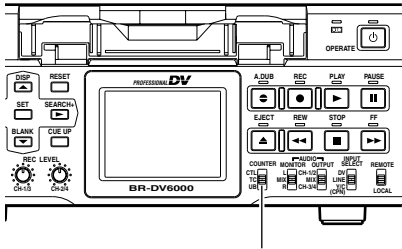

COUNTER switch

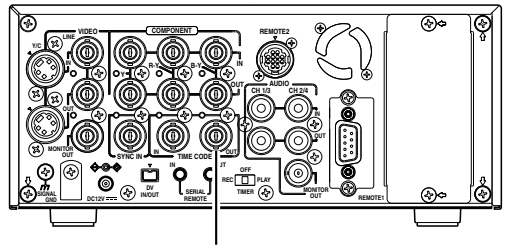

TIME CODE OUT terminal

Monitor / LCD (Status display)

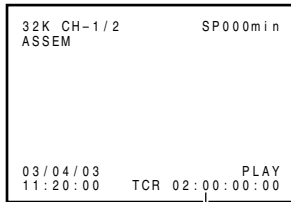

Time code or user's bit

1. Select the time code data to display.

Set the COUNTER switch to "TC" or "UB".

2. Press the PLAY button to go to the PLAYBACK mode.

→ It displays the time code and the user's bit on the monitor or the LCD. The counter display mode becomes TCR or UBR.

- The LTC time code is output from the TIME CODE OUT terminal on the rear panel.

⊕ The VITC time code is not output.

If the COUNTER switch is set to CTL, the time code is not output.

Caution on time code playback

- During playback, if a portion of tape without recorded time code runs through, the time code stops running. Playback continues.
- If tapes without recorded user's bit, e.g. those recorded with a home-use DV VCR, are played back on BR-DV6000, "—" is displayed.

EDIT - Editing with an RS-422A/JVC bus edit remote controller -

BR-DV6000 is designed to be capable to make tape-to-tape editing by RM-G800 JVC bus remote controller or RM-G820 as well as other equivalent RS-422A remote controller. Of course, it can be applied to feeder player.

- +/- 0 frame editing accuracy with time code, capstan bump (for both recorder and player) and external sync by RS-422A editing controller.
- Ready for A/B roll editing.
- Digital editing via DV interface.

■ Chart for editing mode when BR-DV6000 is used as editing recorder

1) Editing over recorded tape with 48 kHz audio in analog interface

Edit mode		Analog editing
Mode select	OSD	48 kHz mode
ASSEM	ASSEM	Yes
VIDEO	INS V	Yes
VIDEO AUD-1 AUD-2	INS VA	Yes
AUD-1 AUD-2	INS A	Yes
VIDEO AUD-1	INS VA1	No *
VIDEO AUD-2	INS VA2	No *
AUD-1	INS A1	No *
AUD-2	INS A2	No *
TC	INS TC	Yes

* : In this mode, even when you start auto edit, editing will automatically stop and warning message will appear. But, preview edit will be performed without any warning message.

2) Editing over recorded tape with 32 kHz audio in analog interface

Edit mode		Analog editing
Mode select	OSD	32 kHz mode
ASSEM	ASSEM	Yes* ²
VIDEO	INS V	Yes
VIDEO AUD-1 AUD-2	INS VA	Yes* ²
AUD-1 AUD-2	INS A	Yes* ²
VIDEO AUD-1	INS VA12	Yes
VIDEO AUD-2	INS VA34	Yes
AUD-1	INS A12	Yes
AUD-2	INS A34	Yes
TC	INS TC	Yes

*² : In case of CH1/CH2/CH3/CH4 simultaneous insert or assemble edit mode of 32 kHz audio, input signal to audio input connector CH1/CH3 is recorded onto CH1 and CH3 tracks simultaneously and input signal to audio input connector CH2/CH4 is recorded onto CH2 and CH4 tracks simultaneously.

3) Editing over recorded tape with 48 kHz or 44.1 kHz audio in DV interface

Edit mode		DV editing
Mode select	OSD	48 kHz/44.1 kHz mode
ASSEM	ASSEM	Yes
VIDEO	INS V	Yes
VIDEO AUD-1 AUD-2	INS VA	Yes
AUD-1 AUD-2	INS A	Yes
VIDEO AUD-1	INS VA1	No*
VIDEO AUD-2	INS VA2	No*
AUD-1	INS A1	No*
AUD-2	INS A2	No*
TC	INS TC	No

* : In this mode, even when you start auto edit, editing will automatically stop and warning message will appear. But, preview edit will be performed without any warning message.

4) Editing over recorded tape with 32 kHz audio in DV interface

Edit mode		DV editing
Mode select	OSD	32 kHz mode
ASSEM	ASSEM	Yes
VIDEO	INS V	Yes
VIDEO AUD-1 AUD-2	INS VA	Yes
AUD-1 AUD-2	INS A	Yes
VIDEO AUD-1	INS VA12	No*
VIDEO AUD-2	INS VA34	No*
AUD-1	INS A12	No*
AUD-2	INS A34	No*
TC	INS TC	No

* : In this mode, even when you start auto edit, editing will automatically stop and warning message will appear. But, preview edit will be performed without any warning message.

Note for audio insert editing (48 kHz/32 kHz mode)

- If the audio mode setting by menu on BR-DV6000 (audio mode of input signal in DV interface) is different from that of audio mode of the recorded tape, insert editing is impossible. (If editing is performed, it will automatically stop.)
- If the audio mode is changed during performing audio insert editing,
 - In case of DV interface editing, editing will be continued in accordance with the changed audio mode.
 - In case of analog interface editing, if the audio mode of the recorded tape is changed from 32 kHz mode to other mode, editing will automatically stop during CH1/2 or CH3/4 audio insert editing.
 - In case of analog interface editing, editing will be continued in accordance with the audio mode setting by menu on BR-DV6000 during CH1/2/3/4 simultaneous audio insert editing or assemble editing even if the audio mode of the recorded tape is changed.

■ Following editing mode is not available

- Variable motion editing
- Slow motion editing
- Audio or Video split editing
- Frame by frame editing (if editing of duration of less than 10 frames, it will automatically perform 10 frames editing)
- CTL editing (Editing may be possible in CTL mode, but since counter data cannot be coincided with tape position, editing accuracy will become worse.)

Editing procedure with BR-DV6000

Connection

For details on connection, refer to pages 32 and 33.

Setting

■ Set the REMOTE/LOCAL switch on the front panel to REMOTE.

■ SYSTEM (1/2) Menu screen

SYNC SELECT : If there is no input of synchronization signals to the SYNC IN terminal, set this item of the recorder to AUTO. During playback, it synchronizes with the input video signal.

■ REMOTE (1/2) Menu screen

• Set REMOTE SEL 9-PIN to ON (for RS-422A).

Memo : To use the REMOTE 2 (12-PIN) terminal simultaneously, set REMOTE SEL JVC to "OFF".

• Set REMOTE SEL JVC to ON (for JVC-BUS).

Memo : To use the REMOTE 1 (9-PIN) terminal simultaneously, set REMOTE SEL 9-PIN to "OFF".

• PREROLL:

Use this item to set the preroll time (second). It is recommended that at least 7 seconds be set.

Memo : The setting by the editing remote controller precedes if applicable.

■ REMOTE (2/2) Menu screen

• REM STOP SEL (only for RS-422A)

Select the mode for BR-DV6000 to be in when it receives standby-on signals.

EE : EE mode (STOP mode)

PB : Playback mode (STILL mode)

• PB START DELAY

Set the editing timing. If the start points of edit are not concurrent, adjust the playback startup timing.

0F : No correction

1F-15F: Delays the timing for the duration of the set frames. If BR-DV6000 is connected to an editing remote controller with no bump function, use this setting to adjust the edit precision.

Memo : No bump function is available for RM-G800.

• SYNCHRONIZATION (only for RS-422A)

Whether to use the bump function to enhance edit precision can be selected.

OFF : Bump off

ON : Bump on. It may slow down the edit operation.

• CONTROLLER SEL (only for RS-422A)

Set this item according to the type of controller to be connected. (☞ Refer to Page 77)

Set it to TYPE 1 when RM-G820 is used.

■ TC OFFSET in the TC/UB/CLOCK (1/2) Menu screen (only for RS-422A)

To edit DV signals, set the timing for the time code to be output to the editing controller from BR-DV6000.

Usually, this item is set to OFF.

■ To edit with DV connection

• Set the player input selection to other than DV.

• If the bump function is to be used, operate the function from the player. In the case of an editing remote controller for which the function is operated from the recorder, set the preroll time to at least 10 seconds.

• For both player and recorder, set REM STOP SEL to PB.

■ Setting the TIME CODE mode (used as editing recorder)

It is necessary to set time code parameters (when it is used as a recorder) and time code recording mode in accordance with system.

• INTERNAL-REGEN (Regeneration mode)

Time code will be continued to the time code information of the prerecorded tape.

This is the factory's default setting. This mode is especially intended for the following situations:

- When using the JVC bus remote controller.
- When not interfacing with external sync.

• INTERNAL-PRESET-FREERUN (Free run mode)

Please choose this mode when you want to preset time code from the RS-422A remote controller. Please note that time code will be discontinued when an external sync signal is not input to both the editing recorder, player and the editing controller.

• INTERNAL-PRESET-RECRUN (REC RUN mode)

Select this mode if the RM-G800 TC insert function is to be used.

■ Setting of RM-G820

PREROLL	: It is recommended that at least 7 seconds be set.
EDIT TIMING	: -5 frames
BUMP	: ON
BUMP SELECT	: PLAYER
Counter	: LTC

Making prerecorded base tape (used as editing recorder)

Both in the case of analog interface editing: To make a prerecorded tape with the appropriate audio mode to your liking.

And in the case of DV interface editing : To make a prerecorded tape with the audio mode corresponding with the source tape.

It is necessary to record continuous time code information on a prerecorded tape.

Please refer to "Presetting the time code" section. (Page 59)

— Note

When the BR-DV6000 is used as an editing recorder we recommend using tapes that were recorded in this machine.

Confirmation by preview editing

Before performing editing, it is possible to check the edit-in and -out points in preview editing.

It does not work with the JVC bus interface editing controller.

If the editing controller has a learn function, it is recommended that this function is used.

To activate the capstan bump function, it is necessary to set sufficient pre-roll time. It is recommended that a minimum of 7 seconds is set.

— Note

- During preview or editing the E-to-E picture and audio will appear a few frames different from the actual record point. However, the final images will be recorded with correct timing on the tape.
- When the JVC bus interface editing controller is used, the monitor output picture of the recorder always shows the player. It is not possible to check PB/EE switching at edit points.

Perform editing

After setting edit points, starts editing by using perform button on the editing controller.

— Note

- Occasionally, E-to-E pictures may be disturbed during editing but the recordings will be unaffected.
- Try to avoid repeat editing on the same section of tape as, to do so may, after many edits eventually cause induced noise at the edit points.

Tape contents of BR-DV6000 are captured by a non-linear editing system and the non-linear edited contents are recorded on BR-DV6000.

Connection

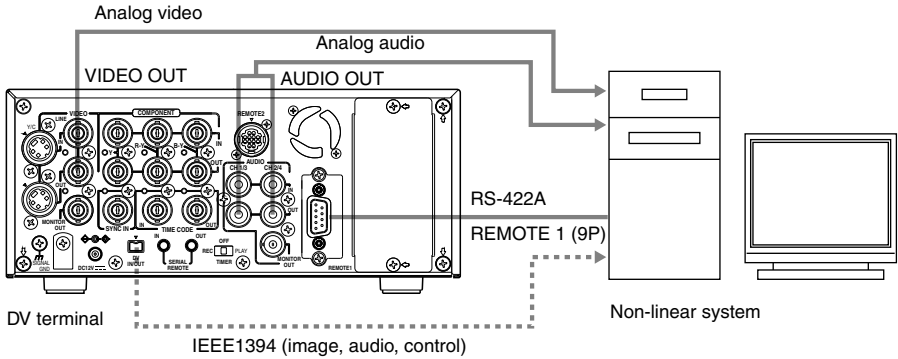

Control with RS-422A (Analog signals)

Control with the DV terminal (Digital signals)

Setting

- **Set the REMOTE/LOCAL switch on the front panel to REMOTE.**
- **REMOTE (1/2) Menu screen**
 - Set REMOTE SEL 9-PIN to "ON".
- **REMOTE (2/2) Menu screen**
- **REMOTE FF/REW MODE:**

Use this item to select the operation to be performed if the FF or REW command is received during playback. (FF/REW or Search)
If the search operation is not performed properly, set it to "SEARCH".
- **CONTROLLER TYPE (in the REMOTE 2/2 Menu screen):**

Set this item to "TYPE1".

Setting

- **REMOTE (1/2) Menu screen**
 - **Set REMOTE SEL DV to ON or LOC+REM.**

Set this item to ON if it is to become enabled only when the REMOTE/LOCAL switch on the front panel is set to REMOTE.
Set this item to LOC+REM if it is to become enabled regardless of the position of the REMOTE/LOCAL switch.

Memo

If the time code of BR-DV6000 is not displayed correctly when the non-linear side moves one frame forward or backward, set the STILL mode to "FRAME."

MENU SCREENS

- Structure of the Menu screens -

The Menu screens are displayed on the monitor or the LCD. They are structured with multiple layers.

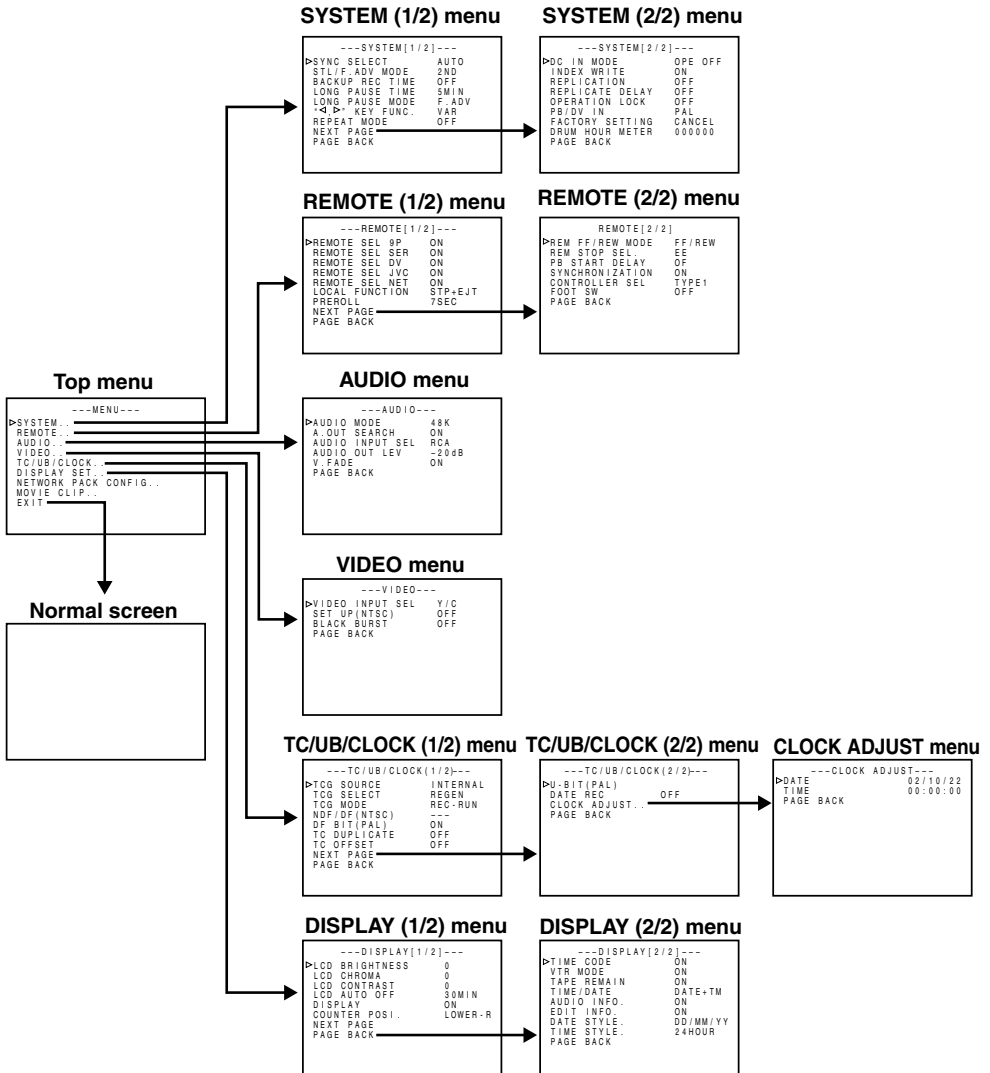

MENU SCREENS

- Setting the menus -

The functions of BR-DV6000 are configured in the Menu screens. The configured settings are saved in the memory of BR-DV6000 and retained even after power off.

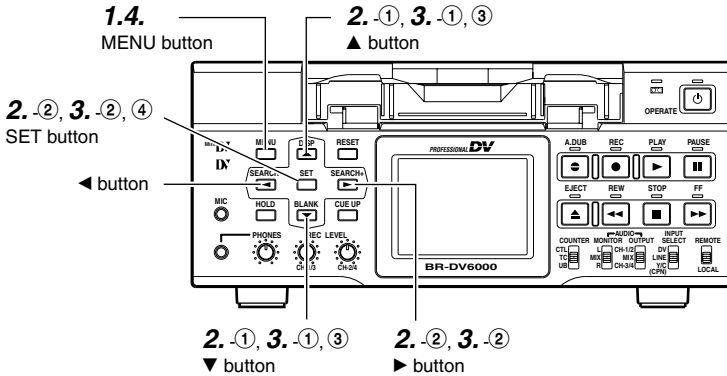

TOP MENU screen

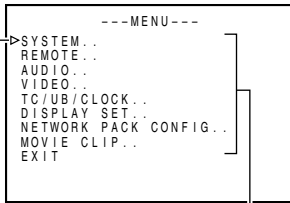

Cursor

Menu items

Perform the menu settings while viewing the display on the monitor connected to the VIDEO MONITOR OUT terminal or the LCD.

■ Set BR-DV6000 to the STOP or STILL mode.

1. Displaying the TOP MENU screen.

Press the MENU button.

2. Displaying the Menu screen items for setting.

- ① Press the ▲ or ▼ button to bring the cursor to the Menu screen item for setting.
- ② Press SET or the ► button.

Select EXIT of the TOP MENU screen to return to the normal screen.

3. Setting the Menu item for setting.

- ① Press the ▲ or ▼ button to bring the cursor to the Menu screen item for setting.
- ② Press SET or the ► button.
 - The selected setting value blinks and becomes available for changing.
- ③ Press the ▲ or ▼ button to change the value.
- ④ Press the SET button to confirm the change.
 - Blinking stops and the new value is confirmed.
- ⑤ Repeat steps ① - ④ and continue setting as necessary.

Cursor Item Setting value

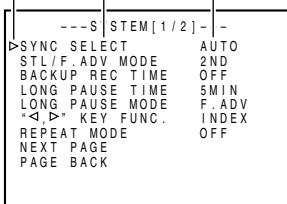

SYSTEM (1/2) Menu screen

```
---SYSTEM[1/2]---  
SYNC SELECT      AUTO  
STL/F.ADV MODE  2ND  
BACKUP REC TIME  OFF  
LONG PAUSE TIME  5MIN  
LONG PAUSE MODE  F.ADV  
*◀▶* KEY FUNC.   INDEX  
REPEAT MODE      OFF  
▶NEXT PAGE  
PAGE BACK
```

```
---SYSTEM[2/2]---  
DC IN MODE       OPE OFF  
INDEX WRITE      ON  
REPLICATION      OFF  
REPLICATE DELAY  OFF  
PB/DV IN        PAL  
FACTORY SETTING  CANCEL  
DRUM HOUR METER  000000  
▶PAGE BACK
```

SYSTEM (2/2) Menu screen

■ To display the Menu screen at the next level, bring the cursor to NEXT PAGE and press the SET or ► button.

■ To return to the previous Menu screen, do one of the following actions.

- Press the ▲ button.
Or
Select PAGE BACK and press the SET or ► button.

4. To return to the normal screen, do one of the following actions.

- Press the MENU button.
Or
Select EXIT in the TOP MENU screen and press the SET or ► button.

MENU SCREENS

- Description of the Menu screens -

In the following description of the Menus, ● indicates factory settings.

TOP MENU screen

Item	Setting	Description
SYSTEM	—	Displays the menus related to the operating system of BR-DV6000. It also displays factory setting and the drum hour meter.
REMOTE	—	Displays the menus related to the remote controller.
AUDIO	—	Displays the menus related to the audio.
VIDEO	—	Displays the menus related to the video.
TC/UB/CLOCK	—	Displays the menu for setting time codes. Also displays the date/time setting screen.
DISPLAY SET	—	Displays the menus related to the monitor connected to the VIDEO MONITOR OUT terminal and the LCD.
NETWORK PACK CONFIG	—	Displayed if the network board SA-DV6000 (sold separately) is installed. For details, refer to the user's guide for SA-DV6000.
MOVIE CLIP	—	
EXIT	—	Return to the normal screen.

SYSTEM Menu screens

The SYSTEM Menu consists of the following two screens (1/2 and 2/2).

■ SYSTEM (1/2) menu

Item	Setting	Description
SYNC SELECT	● AUTO EXTERNAL	Use this item to select the synchronization signal if there is no input of synchronization signal to the SYNC IN terminal during playback. AUTO : Input video signal EXTERNAL : Internal synchronization signal (For details :  Page 29)
STL/F.ADV MODE	FIELD 1ST ● 2ND FRAME	Use this setting to select the still image for the STILL mode or frame-advance playback. FIELD : Displays the field image. During frame-advance playback, it displays the 1st and 2nd field images alternately. 1ST : Displays the 1st field image. 2ND : Displays the 2nd field image. FRAME : Displays the frame image. — Memo — Images from the DV terminal will be the 1st field images regardless of the settings.

SYSTEM Menu screens (continued)

Item	Setting	Description
BACKUP REC TIME	<ul style="list-style-type: none"> ● OFF 25MIN 55MIN 75MIN 115MIN 175MIN 265MIN 	<p>For setting backup recording time with DV input signals according to the tape length of the source unit:</p> <p>OFF : No backup recording</p> <p>25MIN : For a 30-minute source unit recording tape</p> <p>55MIN : For a 60-minute source unit recording tape</p> <p>75MIN : For a 80-minute source unit recording tape</p> <p>115MIN : For a 120-minute source unit recording tape</p> <p>175MIN : For a 180-minute source unit recording tape</p> <p>265MIN : For a 270-minute source unit recording tape</p> <p>(Page 45 "Backup recording function")</p> <hr/> <p>Memo</p> <ul style="list-style-type: none"> ● This item is fixed to OFF when REPLICATION in the SYSTEM (2/2) Menu screen is set to DV. If this is set to other than OFF, REPLICATION cannot be set to DV. ● Set this item to "OFF" if DV REC TRIGGER of GY-DV5000 is set to ON.
LONG PAUSE TIME	<ul style="list-style-type: none"> 30SEC 1MIN 2MIN 3MIN ● 5MIN 	<p>Select the time when BR-DV6000 enters the TAPE PROTECTION mode if the unit has stayed at still, stop or recording pause for a prolonged period of time. The TAPE PROTECTION mode in at STILL can be selected from LONG PAUSE MODE:</p> <p>30SEC : 30 seconds</p> <p>1MIN : 1 minute 3MIN : 3 minutes</p> <p>2MIN : 2 minutes 5MIN : 5 minutes</p> <hr/> <p>Memo</p> <p>To prevent the video head from clogged or the tape from being damaged, set as short a time as possible.</p>
LONG PAUSE MODE	<ul style="list-style-type: none"> ● F.ADV STBY-OFF 	<p>For selecting the action when BR-DV6000 stays at still for a long time.</p> <p>In the case of RECORDING PAUSE or STOP, it enters the standby-off status:</p> <p>F.ADV : Frame-advances BR-DV6000 five times in the forward direction. On the 6th attempt, this mode stops it.</p> <p>STBY-OFF : Stops BR-DV6000.</p>
◀,▶ KEY FUNC.	<ul style="list-style-type: none"> INDEX ● VAR 	<p>For selecting the function for the SEARCH+▶ button and SEARCH-◀ button.</p> <p>INDEX : Performs index search. (Page 52)</p> <p>VAR : Changes the search speed during a search. (Page 50)</p>
REPEAT MODE	<ul style="list-style-type: none"> ● OFF INDEX V. END TAPE END 	<p>For enabling/disabling repeat playback and selecting the type of repeat playback.</p> <p>OFF : No repeat playback</p> <p>INDEX : Repeat playback between the positions where index signals are recorded.</p> <p>V. END : Repeat playback from the beginning of the tape to the position where video signal recording ends.</p> <p>TAPE END : Repeat playback from the beginning to the end of the tape.</p>
NEXT PAGE		For displaying the SYSTEM (2/2) Menu screen.
PAGE BACK		For returning to the TOP MENU screen.

MENU SCREENS - Description of the Menu screens - (continued)

■ SYSTEM (2/2) Menu

Item	Setting	Description
DC IN MODE	● OPE OFF OPE ON	For selecting the action to perform when the power is supplied to the DC IN terminal. OPE OFF : Sets BR-DV6000 to the OPERATE OFF mode. OPE ON : Sets BR-DV6000 to the OPERATE ON mode. - Memo When the TIMER switch is set to REC or PLAY, the OPERATE ON mode becomes effective regardless of the setting of this item.
INDEX WRITE	OFF ● ON	For enabling/disabling index signal recording. OFF : No index signal ON : Select here to record index signals. It records an index signal automatically at the position where recording starts.
REPLICATION	● OFF SERIAL DV	For enabling /disabling output of REC commands from the SERIAL REMOTE OUT terminal or the DV terminal when BR-DV6000 is set to the PLAYBACK mode. OFF : No output SERIAL : Outputs from the SERIAL REMOTE OUT terminal. Use this setting when the SERIAL REMOTE OUT terminal is used for dubbing by another machine. DV : Outputs from the DV terminal. Use this setting when the DV terminal is used for dubbing by another machine. - Memo This item cannot be set to DV when BACKUP REC TIME in the SYSTEM (1/2) Menu screen is set to other than OFF. With this item set to DV, BACKUP REC TIME is fixed to OFF.
REPLICATE DELAY	● OFF 1SEC 2SEC 3SEC 4SEC 5SEC	For setting the output timing of the REC command from the SERIAL REMOTE OUT terminal or the DV terminal when BR-DV6000 is set to the PLAYBACK mode. OFF : Outputs when the unit is set to the PLAYBACK mode. 1SEC - 5SEC : Delays output timing by the set time (seconds).
OPERATION LOCK	● OFF ON	For enabling/disabling operation lock. OFF : Turns off operation lock and the operation buttons of BR-DV6000 can be used. ON : Turns on operation lock. The operation buttons and slide switches of BR-DV6000 are disabled except the OPERATE ON button and MENU operation. (Page 37)
PB/DV IN	● PAL NTSC	Set this menu according to the DV input signal and the signal format of the tape to be played. PAL : Select here when the signal format is PAL. NTSC : Select here when NTSC signals are input to the DV terminal or when a tape with NTSC signals recorded is played. - Memo • With this menu set to NTSC, analog signals cannot be recorded. • If the setting is changed, images cannot be produced properly for a while after the change. • Signal formats cannot be converted. • If this item is set to NTSC, BR-DV6000 cannot be used as the player or recorder of an editing system.
FACTORY SETTING	● CANCEL EXECUTE	For enabling /disabling the factory setting for the Menu screens. CANCEL : Disable the factory setting EXECUTE : Enable the factory setting
DRUM HOUR METER		For displaying the time of drum usage. * The cursor cannot be brought to this item.
PAGE BACK		For returning to the SYSTEM (1/2) Menu screen.

REMOTE Menu screens

The REMOTE Menu consists of the following two screens (1/2 and 2/2).

■ REMOTE (1/2) Menu screen

Item	Setting	Description
REMOTE SEL 9P	OFF <input checked="" type="radio"/> ON	For enabling/disabling the REMOTE1 (9-PIN) terminal when the REMOTE/LOCAL switch on the front panel is set to REMOTE. OFF : Control through RS-422A disabled ON : Control through RS-422A enabled
<p>Memo</p> <p>When the RS-232C board SA-K46U (sold separately) is installed, the name of this item changes to REMOTE SEL 232. Use this setting to enable/disable the control via RS-232C when the REMOTE/LOCAL switch on the front panel is set to REMOTE.</p>		
REMOTE SEL SER	OFF <input checked="" type="radio"/> ON LOC+REM	For enabling/disabling control via the SERIAL REMOTE IN terminal. OFF : Control disabled regardless of the settings of the REMOTE/LOCAL switch ON : Control enabled only when the REMOTE/LOCAL switch is set to REMOTE. LOC+REM : Control enabled regardless of the settings of the REMOTE/LOCAL switch.
REMOTE SEL DV	OFF <input checked="" type="radio"/> ON LOC+REM	For enabling/disabling control via the DV terminal. OFF : Control disabled regardless of the settings of the REMOTE/LOCAL switch. ON : Control enabled only when the REMOTE/LOCAL switch is set to REMOTE. LOC+REM : Control enabled regardless of the settings of the REMOTE/LOCAL switch.
REMOTE SEL JVC	OFF <input checked="" type="radio"/> ON	For enabling/disabling the REMOTE 2 (12-PIN) terminal when the REMOTE/LOCAL switch on the front panel is set to REMOTE. OFF : Control through the JVC bus disabled ON : Control through the JVC bus enabled
REMOTE SEL NET	OFF <input checked="" type="radio"/> ON LOC+REM	For enabling/disabling control via the network board SA-DV6000 (sold separately). OFF : Control disabled regardless of the settings of the REMOTE/LOCAL switch. ON : Control enabled only when the REMOTE/LOCAL switch is set to REMOTE. LOC+REM : Control enabled regardless of the settings of the REMOTE/LOCAL switch.

MENU SCREENS - Description of the Menu screens - (continued)

REMOTE Menu screens (continued)

■ REMOTE (1/2) Menu screen (continued)

Item	Setting	Description
LOCAL FUNCTION	NO KEY EJECT ● STP + EJT ALL KEYS	For selecting the buttons of BR-DV6000 to be enabled in remote-controlling it with the REMOTE (1/2) terminals or the SERIAL REMOTE terminal: NO KEY : No button enabled. EJECT : Only the EJECT button enabled. STP + EJT : Only the STOP button and the EJECT button are enabled. ALL KEYS : All operation buttons are enabled. - Memo _____ If OPERATION LOCK in the SYSTEM (2/2) Menu screen is set to ON, the buttons on BR-DV6000 will be disabled regardless of the setting here.
PREROLL	3SEC 5SEC ● 7SEC 10SEC	For setting the preroll time of BR-DV6000 in remote-controlling it with the REMOTE 1 terminal. Setting done with the editing remote controller prevails over other settings: 3SEC : 3 seconds 5SEC : 5 seconds 7SEC : 7 seconds 10SEC : 10 seconds - Memo _____ To enhance editing precision, please set it to at least 7 seconds.
NEXT PAGE		For displaying the REMOTE (2/2) Menu screen.
PAGE BACK		For returning to the TOP MENU screen.

■ REMOTE (2/2) Menu screen

Item	Setting	Description
REM FF/REW MODE	● FF/REW SEARCH	For setting the action to be performed when the 9-PIN REMOTE terminal, 12-PIN REMOTE terminal, RS-232C terminal or DV terminal received an FF/REW command: FF/REW : Sets BR-DV6000 to perform FF/REW when an FF/REW command is received. Normal setting. SEARCH : Sets BR-DV6000 to perform searching when an FF/REW command is received. Use this setting if the search (cue up) function does not work properly.
REM STOP SEL	● EE PB	For setting the action to be performed when the 9 PIN REMOTE terminal, 12-PIN REMOTE terminal, RS-232C terminal or DV terminal received a STANDBY ON command: EE : Sets BR-DV6000 to the EE mode. (It goes into the STOP mode.) PB : Sets BR-DV6000 to the PLAY mode. (It goes into the STILL mode.)

■ REMOTE (2/2) Menu screen (continued)

Items	Setting	Description
PB START DELAY	<ul style="list-style-type: none"> ● 0F 15F 	<p>For adjusting the edit timing. With the remote controller in use, if the start points of edit are not concurrent, adjust the playback startup timing:</p> <p>0F : No correction. 1F to 15F : Delays the timing by the number of frames set by the user. When BR-DV6000 is connected to an editing remote controller with no bump function, use this setting to adjust the editing precision.</p>
SYNCHRONIZATION	<ul style="list-style-type: none"> OFF ● ON 	<p>For enabling/disabling the bump function when BR-DV6000 is connected to an editing remote controller:</p> <p>OFF : No synchronization. ON : Performs synchronization. The editing precision is enhanced. Please set the pre-roll time to at least 7 seconds.</p>
CONTROLLER SEL	<ul style="list-style-type: none"> ● TYPE1 TYPE2 TYPE3 TYPE4 TYPE5 TYPE6 TYPE7 	<p>For setting the type of controller to be connected when remote control is enabled with the RS-422A interface:</p> <p>TYPE1 : RM-G820 TYPE2 : RM-G860 (set the preroll time to at least 10 seconds) TYPE3 : AG-A850 TYPE4 : RM-450,PVE-500 TYPE5 - TYPE7 : (Not in use)</p>
FOOT SW	<ul style="list-style-type: none"> ● OFF L EDGE H EDGE L LEVEL 	<p>For setting when an external switch (e.g., a footswitch) is connected to the SERIAL REMOTE terminal. Before operating an external switch (footswitch) with L EDGE or H EDGE, turn BR-DV6000 to the RECORDING PAUSE or RECORDING mode:</p> <p>OFF : For when the external switch is not used. L EDGE : Recording and recording pause is switched at the LOW edge of the external switch signal. H EDGE : Recording and recording pause is switched at the HIGH edge of the external switch signal. L LEVEL : Record at the LOW edge and pause recording at the HIGH edge of the external switch signal.</p>
PAGE BACK		Return to the REMOTE (1/2) Menu screen.

MENU SCREENS - Description of the Menu screens - (continued)

AUDIO Menu screen

Item	Setting	Description
AUDIO MODE	<input checked="" type="radio"/> 48 K <input type="radio"/> 32 K	For selecting the audio sampling frequency for recording. 48 K : Records at 48 kHz. It records in the 2-channel stereo mode. No audio dubbing allowed. 32 K : Records at 32 kHz. It records in the 4-channel mode. To perform audio dubbing on CH3 and CH4 later, use this setting. <hr/> — Memo — Setting of this item is not required for DV signal input.
A.OUT AT SEARCH	<input type="radio"/> OFF <input checked="" type="radio"/> ON	For enabling/disabling audio output from this AUDIO OUT terminal during searches. OFF : Output off. ON : Output on.
AUDIO INPUT SEL	<input type="radio"/> XLR <input checked="" type="radio"/> RCA	Use this setting when the XLRIN board SA-X61U (sold separately) is installed. For selecting the audio input terminal. XLR : Audio input terminal of SA-X61U RCA : AUDIO INPUT terminal of the unit
AUDIO OUT LEV	<input type="radio"/> -12 dB <input checked="" type="radio"/> -20 dB	For selecting the level for playback audio output. -12 dB : Select here to reduce the analog sound output level. It will be reduced by 8 dB. -20 dB : Usually, this setting is used.
V.FADE	<input type="radio"/> OFF <input checked="" type="radio"/> ON	For enabling/disabling the V.Fade function, which reduces sound noise in playback that is produced at jointed parts of recording. OFF : V.FADE function disabled. ON : V.FADE function enabled.
PAGE BACK		For returning to the TOP MENU screen.

VIDEO Menu screen

Item	Setting	Description
VIDEO INPUT SEL	● Y/C COMPONENT	For selecting the input video signals when the INPUT SELECT switch on the front panel is set to Y/C (CPN). Y/C : YC separate signals COMPONENT : Component video signals
SET UP (NTSC)	● OFF ON	For enabling/disabling the application of setups to analog video signals (composite, Y/C and component). (During recording and playback) OFF : Does not apply setups. ON : Applies setups. - Memo _____ The application of setups on playback or recorded video signals must match the setting of SET UP. Otherwise, if dubbing is repeatedly performed, the hue and brightness of the video may not appear normal.
BLACK BURST	● OFF ON	For enabling/disabling output of black burst signals of the built-in signal generator. (When analog input is selected) OFF : Output off ON : Output on. In the RECORDING mode, black burst signals will be recorded.
PAGE BACK		For returning to the TOP MENU screen.

MENU SCREENS - Description of the Menu screens - (continued)

TC/UB/CLOCK Menu screens

The TC/UB/CLOCK Menu consists of the following two screens. (1/2 and 2/2)

■ TC/UB/CLOCK (1/2) Menu screen

Item	Setting	Description
TCG SOURCE	<ul style="list-style-type: none"> ● INTERNAL EXTERNAL 	For selecting the source of the time code generator. INTERNAL : BR-DV6000 built-in time code generator EXTERNAL : Time code generator connected to the TIME CODE IN terminal
TCG SELECT	<ul style="list-style-type: none"> PRESET ● REGEN 	For selecting the time code generator mode. PRESET : PRESET mode REGEN : REGENERATION mode
TCG MODE	<ul style="list-style-type: none"> ● REC-RUN FREE-RUN 	For selecting the running mode of the time code generator. * Select here in the PRESET mode. REC-RUN : RECORD RUN mode FREE-RUN : FREE RUN mode
NDF/DF (NTSC)	<ul style="list-style-type: none"> NON DROP ● DROP 	For selecting the framing mode of the time code generator. (NTSC only) * Select here in the PRESET mode. NON DROP : NON-DROP mode DROP : DROP-FRAME mode
DF BIT (PAL)	<ul style="list-style-type: none"> ● OFF ON 	For selecting whether to record drop-frame bits. (Only for E model) OFF : No recording ON : Recording
TC DUPLICATE	<ul style="list-style-type: none"> ● OFF AUTO NON DROP 	For selecting the type of time code to be recorded with DV signal input. OFF : Records time code of the built-in time code generator of BR-DV6000 AUTO : Records the time code input to the DV IN terminal. The framing mode of the time code will be set automatically to the framing of the time code input. NON DROP : Records the time code input to the DV IN terminal. The framing mode of the time code is fixed to non-drop framing. (NTSC only) Use this setting for dubbing tapes recorded with BR-DV600, GY-DV500 or GY-DV550 in the NON-DROP FRAME mode. (NTSC only)
TC OFFSET	<ul style="list-style-type: none"> ● OFF +1F +2F -2F -1F 	For setting up the timing when time code data from the 9-PIN REMOTE terminal of BR-DV6000 to the editing remote controller are output. OFF : Normal setting. +1F : Sets the timing to 1 frame faster. +2F : Sets the timing to 2 frames faster. -2F : Sets the timing to 2 frames slower. -1F : Sets the timing to 1 frame slower.
NEXT BACK		For displaying the TC/UB/CLOCK (2/2) Menu screen.
PAGE BACK		For returning to the TOP MENU screen.

■ TC/UB/CLOCK (2/2) Menu screen

Item	Setting	Description
U-BIT (PAL)	OFF <input checked="" type="radio"/> ON	For selecting whether to record user's bit. (Only for E model) OFF : No recording ON : Recording
DATE REC	<input checked="" type="radio"/> OFF ON	For selecting whether to record date/time data on the tape. OFF : No recording ON : Recording date/time on-screen display description. For this to be enabled, the following settings are required. • Set DISPLAY in the DISPLAY (1/2) Menu screen to ON. • Set TIME/DATE in the DISPLAY (2/2) Menu screen to other than OFF. <div style="border: 1px solid black; border-radius: 10px; padding: 5px; margin-top: 10px;"> <p>Memo</p> <p>With DV signal input, date/time data are not recorded.</p> </div>
CLOCK ADJUST		For displaying the date/time setting screen For setting, refer to page 40 "Setting date/time".
PAGE BACK		For returning to the TC/UB/CLOCK(1/2) Menu screen .

MENU SCREENS - Description of the Menu screens - (continued)

DISPLAY Menu screens

The DISPLAY menu consists of 2 screens (1/2 and 2/2)

■ DISPLAY (1/2) Menu screen

Item	Setting	Description
LCD BRIGHTNESS	MAX +4 +3	For adjusting the brightness of the LCD. A bigger value increases brightness.
LCD CHROMA	+2 +1	For adjusting the concentration level of the color of the LCD. A bigger value increases color concentration.
LCD CONTRAST	● 0 -1 -2 -3 -4 MIN	For adjusting the LCD contrast. A bigger value increases contrast.
LCD AUTO OFF	OFF ● 30MIN 1HOUR 2HOUR	For selecting whether to turn off the LCD display automatically when it is not to be used for a long time. OFF : No auto OFF 30MIN : Auto OFF after 30 minutes 1HOUR : Auto OFF after 1 hour 2HOUR : Auto OFF after 2 hours <hr/> — Memo During recording or playback, the LCD display stays on regardless of this setting.
DISPLAY	OFF ● ON AUTO	For turning on/off on-screen status display on the monitor connected to the VIDEO MONITOR OUT terminal or the LCD. OFF : No on-screen status display. Only video is displayed. ON : Always shows on-screen status display. AUTO : Shows on-screen status display for about 4 seconds during mode changes.
COUNTER POSI.	● LOWER-R LOWER-L UPPER-R UPPER-L CENTER	For selecting the counter display position (CTL counter, time code and user's bit) of the monitor or the LCD. LOWER-R : Lower right LOWER-L : Lower left UPPER-R : Upper right UPPER-L : Upper left CENTER : Center
NEXT PAGE		For displaying the DISPLAY (2/2) Menu screen.
PAGE BACK		For returning to the TOP MENU screen.

■ DISPLAY (2/2) Menu screen

Item	Setting	Description
TIME CODE	OFF ● ON	For enabling/disabling the time code display on the monitor or the LCD. OFF : No display ON : Display
VTR MODE	OFF ● ON	For enabling/disabling the VCR mode on the monitor or the LCD. OFF : No display ON : Display
TAPE REMAIN	OFF ● ON	For enabling/disabling the display of the remaining time of the tape on the monitor or the LCD. OFF : No display ON : Display
TIME/DATE	OFF TIME DATE ● DATE+TM	For enabling/disabling the time/date display on the monitor or the LCD and selecting the display format. OFF : No display TIME : Time display only DATE : Date display only DATE+TM : Date/Time display
AUDIO INFO.	OFF ● ON	For enabling/disabling the display of audio channel or sampling frequency on the monitor or the LCD. OFF : No display ON : Display
EDIT INFO.	OFF ● ON	For selecting whether to display the edit mode on the monitor or the LCD. OFF : No display ON : Display
DATE STYLE	YY/MM/DD MM/DD/YY ● DD/MM/YY	For selecting the date display format. YY/MM/DD : Year/Month/Day MM/DD/YY : Month/Day/Year DD/MM/YY : Day/Month/Year
TIME STYLE	● 24HOUR 12HOUR	For selecting the display style of time. 24HOUR : 24-hour mode 12HOUR : 12-hour mode
PAGE BACK		For returning to the DISPLAY (1/2) screen.

RS-232C INTERFACE

- Command tables -

This section provides information on programming VCR operations via the RS-232C interface.

■ BASIC TABLE

Low High	0	1	2	3	4	5	6	7	8	9	A	B	C	D	E	F
0		Complete	Error	Cassette Out		Not Target					ACK	NAK				
1																
2																
3											Play	Fwd Shtl x2	Fwd Shtl x0.2	Fwd Still	Fwd Shtl x10	Stop
4	Enter	Clear Error	CueUp with Data				In Shift +	In Shift -	Out Shift +	Out Shift -	Rev Shtl x1	Rev Shtl x2	Rev Shtl x0.2	Rev Still	RevShtl x10	Still
5	In Entry	Out Entry	In Flag Reset	Out Flag Reset	In Flag Recall	Out Flag Recall	Clear		Go-to In	Go-to Out	Memory	Memory Search				
6									Status Sense							
7																
8															Date Preset	Clock Preset
9																
A	Standby On	Standby Off	Preroll	Eject								Ff	Rew	Fwd Field Step	Rev Field Step	
B			CueUp with Data			Fwd Shtl	Rev Shtl								Date Data Sense	Clock Data Sense
C	Auto Edit	Preview	Review		Full-EE On	EE Off			Select EE On	Select EE Off	Rec	Rec Pause	Adb	Adb Pause	Edit On	Edit Off
D							Preroll Tm Sense	Status Sense	Tc Data Sense	CTL Data Sense	In Data Sense	Out Data Sense	UB Data Sense	JVC Status Sense		
E	TC Preset	UB Preset	CTL Data Reset	In Data Preset	Out Data Preset	Edit Preset	Preroll Tm Preset	Timer Mode Select						Memory Sw Preset		
F							JVC Tbl 1 Select	Basic Tbl Select			Rec/Dub Request	Vtr Ind				

■ JVC TABLE 1

Low High	0	1	2	3	4	5	6	7	8	9	A	B	C	D	E	F
0		Complete	Error	Cassette Out		Not Target					ACK	NAK				
1																
2																
3											Play					Stop
4	Enter	Clear Error					In Shift +	In Shift -	Out Shift +	Out Shift -						Still
5	In Entry	Out Entry	In Flag Reset	Out Flag Reset	In Flag Recall	Out Flag Recall	Clear		Go-to In	Go-to Out	Memory	Memory Search				
6									Status Sense							
7			Rom Version									Operate On	Operate Off			
8															Date Preset	Clock Preset
9																
A	Standby On	Standby Off	Preroll	Eject								Ff	Rew	Fwd Field Step	Rev Field Step	
B	Viss Fwd	Viss Rev	Play After CueUp			Fwd Shtl	Rev Shtl								Date Data Sense	Clock Data Sense
C					Full-EE On	EE Off					Rec	Rec Pause	Adb	Adb Pause		
D		Device Type Request		Memory Sw Sense	Tape Rem Sense			Status Sense	Tc Data Sense	CTL Data Sense				JVC Status Sense		
E			CTL Data Reset	In Data Preset	Out Data Preset			Timer Mode Select						Memory Sw Preset		
F							JVC Tbl 1 Select	Basic Tbl Select			Rec/Dub Request	Vtr Ind				

RS-232C INTERFACE

- RS-232C specifications -

● 9PIN D-Sub

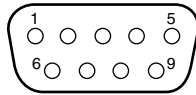

Pin No.	Signal	Operation	Direction of signal
2	RxD	Receive data	VCR←PC
3	TxD	Transmit data	VCR→PC
4	DTR	Data terminal ready	VCR→PC
5	GND	Signal grounding	
6	DSR	Data set ready	VCR←PC

Memo : "PC" means a controller such as a personal computer.

- Mode : Non-synchronous
- Character length : 8 bits
- Parity check : None
- Start bit : 1
- Stop bit : 1
- Data rate : 9600bps
- Bit configuration

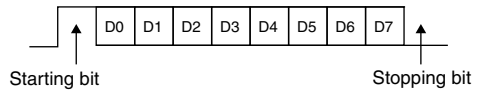

ASCII code table

Use this table to represent the values or alphabets in ASCII with the RS-232C interface.

	0	1	2	3	4	5	6	7	8	9	A	B	C	D	E	F
0		SP	0		P		p									
1			1	A	Q	a	q									
2			2	B	R	b	r									
3			3	C	S	c	s									
4			4	D	T	d	t									
5			5	E	U	e	u									
6			6	F	V	f	v									
7			7	G	W	g	w									
8			8	H	X	h	x									
9			9	I	Y	i	y									
A				J	Z	j	z									
B					K		k									
C					L		l									
D					M		m									
E					N		n									
F					O		o									

An optional RS-232C interface board SA-K46U can be installed to BR-DV6000 and connected to a personal computer. Data transmitted and received via the RS-232C interface enables the PC to control the VCR and gather status and operating information.

■ Preparation

To control the VCR by the RS-232C interface, the following settings are required.

- Set REMOTE SEL 232 in the REMOTE (1/2) Menu screen to ON.
- Set the REMOTE/LOCAL switch on the front panel to REMOTE.

● Command tables

BR-DV6000 is controlled according to the following two command tables (BASIC, JVC-1).

Command	Description
F6	JVC-1 TABLE ON : Hereafter, JVC TABLE-1 is followed.
F7	BASIC TABLE ON : Hereafter, BASIC TABLE is followed. JVC TABLE-1 is turned OFF.

● VCR operation commands

These commands are used to operate the VCR. When a command is received correctly, the VCR returns ACK (0Ah) and enters the mode corresponding to the command.

(Example) Playback

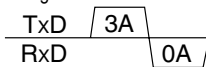

Blank "Table" boxes below denote that these commands exist for both command tables.

B : BASIC TABLE,
J1 : JVC TABLE-1

Table	Command	Description
	3A	PLAY : Play
B	3B	FWD x 2 : 2x play
B	3C	FWD x 0.2 : 0.2x play
B	3D	F-STILL : Pause
B	3E	FWD x 9/10 : 9(10) x play (PAL)
	3F	STOP : Stop
	46	IN SHIFT + : Shifts the IN point to the + direction.
	47	IN SHIFT - : Shifts the IN point to the - direction.
	48	OUT SHIFT + : Shifts the OUT point to the + direction.
	49	OUT SHIFT - : Shifts the OUT point to the - direction.
B	4A	REV x 1 : Reverse play
B	4B	REV x 2 : 2x reverse play
B	4C	REV x 0.2 : 0.2x reverse play
B	4D	R-STILL : Pause
B	4E	REV x 9/10 : 9(10) x reverse play
	4F	STILL : Pause
	50	IN ENTRY : Registers the current time as the IN point.
	51	OUT ENTRY : Registers the current time as the OUT point.
	52	IN FLAG RESET : Cancels the registered IN point.
	53	OUT FLAG RESET : Cancels the registered OUT point.
	54	IN FLAG RECALL : Validates the cancelled IN point.
	55	OUT FLAG RECALL: Validates the cancelled OUT point.
	58	GO TO IN : Cues up the point specified with IN ENTRY (50) and IN DATA PRESET (E3). When the tape is cued, COMPLETE (01) is returned. When the specified point cannot be found, NOT TARGET (05) is returned.

Table	Command	Description
	59	GO TO OUT : Cues up the point specified with OUT ENTRY (51) and OUT DATA PRESET (E4). When the tape is cued, COMPLETE (01) is returned. When the specified point cannot be found, NOT TARGET (05) is returned.
	5A	MEMORY : Registers the current counter value as the cue-up point of MEMORY SEARCH (5B).
	5B	MEMORY SEARCH : Cues up the point specified with MEMORY (5A). When the tape is cued, COMPLETE (01) is returned. When the specified point cannot be found, NOT TARGET (05) is returned.
J1	7B	OPERATE ON : Operating mode ON
J1	7C	OPERATE OFF : Operating mode OFF
	A0	STANDBY ON : Standby ON
	A1	STANDBY OFF : Standby OFF
	A2	PREROLL : Preroll
	A3	EJECT : Ejects the cassette tape. When the tape has been ejected, CASSETTE OUT (03H) is returned.
	AB	FF : Fast-forwards the tape.
	AC	REW : Rewinds the tape.
	AD	F-FIELD STEP : Advances one frame. This command should be transmitted in the Play-Pause mode. Field-advances when STL/FADV MODE is set to FIELD. Otherwise, this command frame-advances.
	AE	R-FIELD STEP : Reverses one frame. This command should be transmitted in the Play-Pause mode. Field-advances when STL/FADV MODE is set to FIELD. Otherwise, frame-advances.

Table	Command	Description
J1	B0	<p>VISS FORWARD :</p> <p>Index search in the forward direction. For the index search position, enter a 3-digit number (001-099) following the command.</p> <p>When a 3-digit number has been entered, index search starts.</p> <p>If ENTER (40H) is transmitted before all three digits are entered, the remaining digit(s) are considered as "0" (30H), and index search starts.</p>
J1	B1	<p>VISS REV :</p> <p>Index search in the reverse direction. For the index search position, enter a 3-digit number (001-099) following the command.</p> <p>When a 3-digit number has been entered, index search starts.</p> <p>If ENTER (40H) is transmitted before all three digits are entered, the remaining digit(s) are considered as "0" (30H), and index search starts.</p>
B	B2	<p>CUE UP WITH DATA :</p> <p>Use this command to cue up a specified point on the tape. When the tape is cued, COMPLETION is returned and the Pause mode becomes effective.</p> <p>To specify a cue point, transmit the time data (hour: minute: second: frame, a total of 8 bytes with 2 bytes for each) following this command. By transmitting ENTER (40H) with the time data, transmission of lower data becomes unnecessary. In such a case, "0" is transmitted. If the specified point cannot be found, NOT TARGET (05H) is returned.</p>
J1	B2	<p>CUE UP AND PLAY WITH DATA:</p> <p>Use this command to cue up a specified point on the tape. When the tape is cued, COMPLETION is returned and the Play mode becomes effective.</p> <p>To specify a cue point, transmit the time data (hour: minute: second: frame, a total of 8 bytes with 2 bytes for each) following this command. By transmitting ENTER (40H) with the time data, transmission of lower data becomes unnecessary. In such a case, "0" is transmitted. If the specified point cannot be found, NOT TARGET (05H) is returned.</p>

Table	Command	Description																										
J1	B5	<p>F-SHUTTLE :</p> <p>Shuttle play. The search speed is specified by sending the speed code data after this command (see the table below).</p> <p style="text-align: center;">Speed code table (Supported speed only)</p> <table border="1" style="margin-left: auto; margin-right: auto;"> <thead> <tr> <th>Speed code</th> <th>Search speed</th> </tr> </thead> <tbody> <tr> <td>30h</td> <td>STILL</td> </tr> <tr> <td>31h</td> <td>0.1</td> </tr> <tr> <td>32h</td> <td>0.2</td> </tr> <tr> <td>33h</td> <td>0.33</td> </tr> <tr> <td>34h</td> <td>0.5</td> </tr> <tr> <td>35h</td> <td>1</td> </tr> <tr> <td>36h</td> <td>2</td> </tr> <tr> <td>37h</td> <td>5</td> </tr> <tr> <td>38h</td> <td>10</td> </tr> <tr> <td>39h</td> <td>20</td> </tr> <tr> <td>3Bh</td> <td>X0.90</td> </tr> <tr> <td>3Ch</td> <td>X1.07</td> </tr> </tbody> </table> <p>3Bh and 3Ch are effective only for B5.</p>	Speed code	Search speed	30h	STILL	31h	0.1	32h	0.2	33h	0.33	34h	0.5	35h	1	36h	2	37h	5	38h	10	39h	20	3Bh	X0.90	3Ch	X1.07
Speed code	Search speed																											
30h	STILL																											
31h	0.1																											
32h	0.2																											
33h	0.33																											
34h	0.5																											
35h	1																											
36h	2																											
37h	5																											
38h	10																											
39h	20																											
3Bh	X0.90																											
3Ch	X1.07																											
	B6	<p>R-SHUTTLE :</p> <p>Shuttle reverse play. The search speed is specified by sending the speed code data after this command (see the table above).</p>																										
B	CO	<p>AUTO EDIT KEY :</p> <p>Audio editing with the VCR.</p> <ul style="list-style-type: none"> It is required that the editing channel is selected in [E5: Edit Preset]. This audio editing command must be used with [FA: Rec Request]. Preroll time can be set with [E6: Preroll Time Preset]. Without this setting, the VCR menu switch settings are followed. Upon the completion of auto editing, the VCR returns [01: Complete]. 																										
B	C1	<p>PREVIEW KEY :</p> <p>Preview with the VCR</p> <ul style="list-style-type: none"> It is required that the editing channel is selected in [E5: Edit Preset]. This preview command must be used with [FA: Rec Request]. Preroll time can be set with [E6: Preroll Time Preset]. Without this setting, the VCR menu switch settings are followed. Upon the completion of preview, the VCR returns [01: Complete]. 																										

Table	Command	Description
B	C2	REVIEW KEY : Review with the VCR • It is required that [C0: Auto Edit] is complete. • Preroll time can be set with [E6: Preroll Time Preset]. Without this setting, the VCR menu switch settings are followed. • Upon the completion of review, the VCR returns [01: Complete].
	C4	Full EE mode ON
	C5	Full EE mode OFF
B	C8	SELECT EE ON : Input signal check for the editing channel selected in [E5: Edit Preset].
B	C9	SELECT EE OFF : EE check release.
	CA	REC : Recording. This command is transmitted after transmitting REC/DUB REQUEST.
	CB	REC PAUSE : Record pause. This command is transmitted after transmitting REC/DUB REQUEST.
	CC	A.DUB : Audio dubbing. This command is transmitted during A.DUB PAUSE after transmitting REC/DUB REQUEST.
	CD	A.DUB PAUSE : Audio dubbing pause. This command is transmitted during audio dubbing after transmitting REC/DUB REQUEST.
	E2	COUNTER RESET : Counter reset E2 40.
	FA	REC/DUB REQUEST : Recording request. (Use this command with a recording command).

• Return commands from the VCR

When the VCR received commands properly, it returns the following commands.

Command	Description
01	COMPLETION : The VCR outputs this command when the operation specified with Cue Up with Data, Preroll, Auto Edit, etc. is complete.
03	CASSETTE OUT : The VCR outputs this command when RS-232C ejected the tape.
05	NOT TARGET : The VCR outputs this command when the operation specified with Cue Up with Data/Preroll failed to be completed.
0A	ACK : This command is returned when a defined command is received.

• Error commands

These are commands that are returned when transmitted data cannot be received by the VCR properly. Commands that release errors are also available.

Command	Description
02	ERROR : This command is returned when the VCR receives an invalid command after the second byte of a multi-byte command. In this case, even if other commands are sent continuously, no command can be accepted. However, status sense codes can be received. To release errors, use the following commands.
41	ERROR CLEAR : Clears the last transmitted byte. Also use this command to release errors.
56	CLEAR : Cancels whole commands. Also use this command to release errors.
0B	NAK : Returned when the VCR receives an undefined command for the first byte or a command specifying a function not available for the VCR. Releasing the error with the CLEAR command is not necessary. Send the correct command.

‡ **Example of CLEAR ERROR**

Specify the cue-up point at 1:10:10:25.
 The specified data after the CUE UP WITH DATA command is invalid. Correct it with the CLEAR ERROR command.

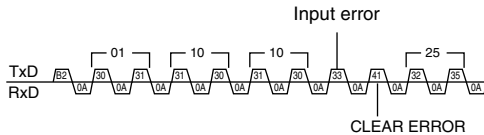

● **Information gathering (sense) commands**

These commands are used to check the VCR operation status.

When a command corresponding to requested information is received by the VCR, data is returned in 1-byte packets. The number of bytes returned differs depending on the command.

Table	Command	Description
J1	72	ROM VERSION : For checking the RS-232C interface-related ROM version. 3-byte data is returned.
	BE	DATA SENSE : For checking the VCR's date data. The data is returned in order of month, date and year. During playback, the time data on the tape is returned.
	BF	TIME SENSE : For checking the VCR's time data. The data is returned in order of hour, minute and second. During playback, the time data on the tape is returned.
J1	D1	DEVICE TYPE : For checking the device type. D: 44h, V:56h, 6:36h, K:4Bh
J1	D4	TAPE REMAIN SENSE : For checking the tape remaining time. 3-byte data is returned showing the hour (one's place) and minutes (ten's place and one's place).
B	D6	PREROLL SENSE : For checking the preroll time. 2-byte data is returned showing the seconds (ten's place and one's place).
	D7	STATUS SENSE : For checking the status. Refer to STATUS SENSE. (63* Page 90)

Table	Command	Description
	D8	CURRENT TC SENSE : For checking the time code data. The data is returned in the order of hour, minute, second and frame. Effective when the counter mode is set to TC.
	D9	CURRENT CTL SENSE : For checking the CTL data. The uppermost digit shows positive or negative. Effective when the counter mode is set to CTL.
B	DA	IN DATA SENSE : For checking the edit-in position. The data is returned in the order of hour, minute, second and frame.
B	DB	OUT DATA SENSE : For checking the edit-out position. The data is returned in the order of hour, minute, second and frame.
B	DC	CURRENT TC UB SENSE : For checking the user's bit data. Data A from F is represented with ASCII code 41h to 46h. Effective when the counter mode is set to UB.
	DD	JVC STATUS SENSE : For checking the status. Refer to JVC STATUS SENSE. (63* Page 91)
	FB	VTR IND : For checking VCR connection.

RS-232C INTERFACE - RS-232C commands - (continued)

■ D7: STATUS SENSE

This section describes 5-byte data that are returned when the STATUS SENSE (D7H) command is sent.

● First byte

Bit No.	Status: If the bit is 1
7	Always 1
6	Always 0
5	SHORT FF/REW : In short FF or short REW
4	REC INHIBIT : Recording prohibited
3	CASSETTE OUT : No cassette tape loaded
2	SERVO LOCK : Servo locked
1	Undefined : Always 0
0	ERROR : Error occurring

● Second byte

Bit No.	Status: If the bit is 1
7	VIDEO EE : Video output in the EE mode
6	AUD EE : Audio 1 output in the EE mode
5	VIDEO MUTE : Video signals muted
4	AUD MUTE : Audio signals muted
3	WARNING : Problem with the VCR
2	DEW : Condensation in the VCR
1	TAPE BEGIN : Short FF at the tape beginning.
0	TAPE END : Short REW at the tape end

● Third byte

Bit No.	Status: If the bit is 1
7	TIMER PLAY : TIMER switch set to PLAY
6	TIMER REC : TIMER switch set to REC
5	Unused : Always 0
4	REPEAT : REPEAT PLAYBACK mode ON
3	Unused : Always 0
2	REPEAT MODE : Repeat playback in operation
1	SEARCH MODE : VCR being cueing-up/prerolling
0	Unused : Always 0

● Fourth byte

Bit No.	Status: If the bit is 1
7	PLAY MODE : VCR playing
6	FF MODE : VCR fast-forwarding
5	REW MODE : VCR rewinding
4	STOP MODE : VCR stopped
3	STAND BY MODE : VCR on standby
2	EJECT : Cassette tape being ejected
1	REC MODE : VCR recording
0	ADB MODE : VCR audio dubbing

● Fifth byte

Bit No.	Status: If the bit is 1
7	PAUSE MODE : VCR paused
6	Unused : Always 0
5	SHUTTLE FWD : VCR forward shuttle-searching
4	SHUTTLE REV : VCR reverse shuttle-searching
3	SPEED CODE3 : Refer to the following table.
2	SPEED CODE2 : Refer to the following table.
1	SPEED CODE1 : Refer to the following table.
0	SPEED CODE0 : Refer to the following table.

Search speed table (Supported speed only)

Search speed	Speed code (Bit No.)			
	3	2	1	0
STILL	0	0	0	0
0.1	0	0	0	1
0.2	0	0	1	0
0.3	0	0	1	1
0.5	0	1	0	0
1	0	1	0	1
2	0	1	1	0
5	0	1	1	1
9 (10)	1	0	0	0
20	1	0	0	1

() : PAL

■ DD: JVC STATUS SENSE

This section describes 4-byte data that are returned when the STATUS SENSE command is sent.

● First byte

Bit No.	Status: If the bit is 1
7	Always 1
6	Always 0
5	Unused : Always 0
4	DMF : Playing back LP-mode tape
3	Unused : Always 0
2	JVC TABLE2 : JVC TABLE 2 enabled
1	JVC TABLE1 : JVC TABLE 1 enabled.
0	LOCAL : REMOTE switch set to LOCAL

● Second byte

Bit No.	Status: If the bit is 1
7	TC GENERATOR : Time code generator in the TCG mode.
6	USER BIT : Counter mode set to the UB mode.
5	TIME CODE : Counter mode set to the TC mode.
4	CONTROL PULSE : Counter mode set to the CTL mode.
3	CTL completion : Always 0
2	DROP FRAME : Current time code in the DROP FRAME mode
1	LTC : Always 1
0	Unused : Always 0

● Third byte

Bit No.	Status: If the bit is 1
7	TC REC RUN : TCG set to the Rec Run mode
6	TC REGEN : TCG set to the REGENERATION mode
5	TC EXTERNAL : TCG set to the EXT mode
4	TC INSERT LED : Time code insert edit mode
3	AUD1 INSERT LED : Audio-1/2 insert edit mode
2	AUD2 INSERT LED : Audio-3/4 insert edit mode
1	VIDEO INSERT LED: Video insert edit mode
0	ASSEM : Assemble mode

● Fourth byte

Bit No.	Status: If the bit is 1
7	TBC PWB IN : Always 1
6	TC PWB IN : Always 1
5	DA3 INSERT LED : Always 0
4	DA4 INSERT LED : Always 0
3	AUTO MODE : Auto editing/Previewing/Reviewing
2	Unused : Always 0
1	Unused : Always 0
0	Unused : Always 0

■ Setup (preset) commands

These commands are for setting various types of VCR data. The commands corresponding to the settings can be transmitted.

Table	Command	Description																												
B	E0	TC DATA PRESET : For presetting the time code data. To set, transmit the time data following this command. Specify the time in order of hour, minute, second and frame, using two digits for each. When ENTER (40h) is transmitted before all digits have been transmitted, the time code data are specified by entering digits from the uppermost digit.																												
B	E1	TC UB DATA PRESET : For presetting the user's bit.																												
	E3	IN DATA PRESET : For presetting the edit-in point. Set by transmitting time data following this command. Specify the time in order of hour, minute, second and frame, using two digits for each. If ENTER (40h) is transmitted before all digits have been transmitted, this command is executed with unspecified parts set as "0." If this is a negative value in the CTL mode, set 38h to the digit of 10H.																												
	E4	OUT DATA PRESET : For presetting the edit-out point. For details, refer to IN DATA PRESET (E3h) above.																												
B	E5	EDIT PRESET : For selecting the edit mode. Each bit is defined as shown in the table below. <table border="1" data-bbox="756 1018 1036 1193"> <tbody> <tr> <td></td> <td>7</td> <td>6</td> <td>5</td> <td>4</td> </tr> <tr> <td rowspan="2">First byte</td> <td>0</td> <td>0</td> <td>1</td> <td>1</td> </tr> <tr> <td>3</td> <td>2</td> <td>1</td> <td>0</td> </tr> <tr> <td rowspan="2">Second byte</td> <td>0</td> <td>INS</td> <td>ASM</td> <td>Video</td> </tr> <tr> <td>0</td> <td>0</td> <td>1</td> <td>1</td> </tr> <tr> <td></td> <td>0</td> <td>TC</td> <td>Aud-1</td> <td>Aud-2</td> </tr> </tbody> </table>		7	6	5	4	First byte	0	0	1	1	3	2	1	0	Second byte	0	INS	ASM	Video	0	0	1	1		0	TC	Aud-1	Aud-2
	7	6	5	4																										
First byte	0	0	1	1																										
	3	2	1	0																										
Second byte	0	INS	ASM	Video																										
	0	0	1	1																										
	0	TC	Aud-1	Aud-2																										
B	E6	• ENTER (40h) is invalid. PREROLL TIME PRESET : For setting the preroll time. Specify this by transmitting 2-byte data following this command. First byte for ten's place and second byte for one's place.																												

Table	Command	Description										
	E7	TIMER MODE SELECT : For selecting the counter mode. Following this command, send 1-byte data corresponding to the counter mode. <table border="1" style="margin-left: 20px;"> <thead> <tr> <th>High</th> <th>Low</th> <th>Counter mode</th> </tr> </thead> <tbody> <tr> <td rowspan="3">3 (Fixed)</td> <td>1</td> <td>TC</td> </tr> <tr> <td>2</td> <td>CTL</td> </tr> <tr> <td>5</td> <td>UB</td> </tr> </tbody> </table>	High	Low	Counter mode	3 (Fixed)	1	TC	2	CTL	5	UB
High	Low	Counter mode										
3 (Fixed)	1	TC										
	2	CTL										
	5	UB										
	8E	DATA SELECT : For setting the date. Following this command, send 6-byte numeric data. Specify month, date and year (in this sequence) with two digits for each.										
	8F	TIME SELECT : For setting the time. Following this command, send 6-byte numeric data. Specify hour, minute and second (in this sequence) with two digits for each.										

■ Menu switch setup command

● ED: MEMORY SW PRESET (B/J1)

This command is for changing the VCR's menu switches. Following this command, transmit the data (3 bytes) corresponding to the menu switch to be changed.

Example: Set SYNC SELECT to EXTERNAL.

In the diagram below, the data corresponding to the setting of EXTERNAL show that DATA 0, D2 No. 1 bit and D2 No. 0 bit are, respectively, 01, 0 and 1. Set the command by transmitting data in a way that the corresponding bit values match them.

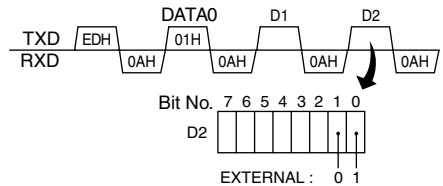

● D3: MEMORY SW SENSE (J1)

This command is for checking the VCR's menu switch setting. Following this command, transmit the data (DATA0) corresponding to the menu switch to be checked.

You can confirm the setting with the bit count of the returned data (D1, D2).

Example: Check the SYNC SELECT setting.

As in the diagram below, the setting can be checked by confirming the values for the menu switch. In this example, check the values for DATA0 (namely 01), D2 No. 1 and No. 0 of the returned data.

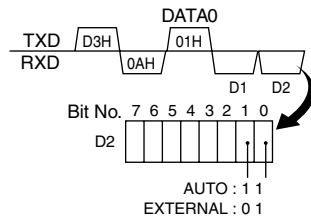

■ SYSTEM Menus

Menu	DATA 0	D1/D2	Set value	Corresponding bit values (D1/D2)								
				7	6	5	4	3	2	1	0	
SYNC SELECT	01	D2	AUTO EXTERNAL								1 0	1 1
“◀, ▶”KEY FUNC.	95	D1	INDEX VAR	0 1								
STL/F.ADV MODE	93	D1	FIELD FRAME									0 1
	95	D2	1ST 2ND				0 1	1 0				
BACK UP REC TIME	95	D1	OFF						0	0	0	0
			25MIN						0	0	1	1
			55MIN						0	1	0	0
			75MIN						0	1	1	1
			115MIN						1	0	0	0
			175MIN						1	0	1	1
			265MIN						1	1	0	0
LONG PAUSE TIME	10	D1	30SEC					0	1	0		
			1MIN					0	1	1		
			2MIN					1	0	0		
			3MIN					1	0	1		
			5MIN					1	1	1		
LONG PAUSE MODE	10	D1	STBY-OFF F.ADV			0 1	0 0					
REPEAT MODE	01	D2	OFF				0	0	0			
			TAPE END				0	0	1			
			INDEX				0	1	0			
			V. END				1	0	0			
DC IN MODE	95	D1	OPE OFF				0	0				
			OPE ON				0	1				
INDEX WRITE	88	D2	OFF				0					
			ON				1					
REPLICATION	95	D1	OFF		0	0						
			SERIAL		0	1						
			DV		1	0						
REPLICATE DELAY	95	D2	OFF						0	0	0	0
			1SEC						0	0	1	1
			2SEC						0	1	0	0
			3SEC						0	1	1	1
			4SEC						1	0	0	0
			5SEC						1	0	1	1
OPERATION LOCK	01	D1	OFF						0			
			ON						1			
PB/DV IN	08	D2	NTSC									0
			PAL									1

RS-232C INTERFACE - RS-232C commands - (continued)

■ REMOTE Menus

* With RS-232C, REMOTE SEL 9P and REMOTE SEL 232 cannot be set.

Menu	DATA 0	D1/D2	Set value	Corresponding bit values (D1/D2)									
				7	6	5	4	3	2	1	0		
REMOTE SEL 9-PIN*	93	D2	OFF ON		0 1								
REMOTE SEL 232*	93	D2	OFF ON			0 1							
REMOTE SEL SER	93	D2	OFF ON							0 1			
	96	D1	LOC+REM OFF ON LOC+REM							1 0 0 1			
REMOTE SEL DV	93	D2	OFF ON				0 1						
	96	D1	LOC+REM OFF ON LOC+REM				1 0 0 1						
REMOTE SEL JVC	93	D2	OFF ON	0 1									
REMOTE SEL NET	93	D2	OFF ON					0 1					
	96	D1	LOC+REM OFF ON LOC+REM					1 0 0 1					
LOCAL FUNCTION	20	D1	EJECT STP+EJT ALL KEY NO KEY					0 0 1 1	0 1 0 1				
PREROLL	20	D2	3 SEC 5 SEC 7 SEC 10 SEC					0 0 0 1	0 1 1 0	1 0 1 1	1 0 1 0		
REMOTE FF/REW MODE	93	D1	FF/REW SEARCH	0 1									
REM STOP SEL	93	D1	EE PB			0 1							
PB START DELAY	96	D2	OF 1F to 15F					0 0 1	0 0 1	0 0 1	0 0 1	0 1 1	0 1 1
SYNCHRONIZATION	40	D1	OFF ON			0 1							
CONTROLLER SEL	90	D2	TYPE1 TYPE2 TYPE3 TYPE4						0 0 0 0	0 0 1 1	0 0 1 1	0 1 0 1	
FOOT SW	88	D2	OFF L EDGE H EDGE L LEVEL		0 0 1 1	0 1 0 1							

■ AUDIO Menus

Menu	DATA 0	D1/D2	Set value	Corresponding bit values (D1/D2)								
				7	6	5	4	3	2	1	0	
AUDIO MODE	03	D2	32k 48k								0 0	0 1
A.OUT AT SEARCH	05	D1	OFF ON				0 1					
AUDIO INPUT SEL	30	D2	XLR RCA								0 1	
AUDIO OUT LEV	30	D1	-20dB -12dB	0 1								
V.FADE	05	D1	OFF ON			0 1						

■ VIDEO Menus

VIDEO INPUT SEL	02	D2	Y/C COMPONENT			0 1						
SET UP(NTSC)	02	D2	OFF ON		0 1							
BLACK BURST	0D	D2	OFF ON		0 1							

■ TC/UB/CLOCK Menus

TCG SOURCE	81	D2	INTERNAL EXTERNAL							0 1		
TCG SELECT	81	D2	PRESET REGEN					0 1				
TCG MODE	81	D2	FREE RUN REC RUN				0 1					
NDF/DF(NTSC)	81	D2	DROP NON DROP			0 1						
DF BIT(PAL)	78	D2	OFF ON									0 1
TC DUPLICATE	78	D1	OFF AUTO NON DROP	0 0 1	0 1 0							
TC OFFSET	78	D2	OFF +1F +2F -2F -1F				0 0 0 0 1	0 0 1 1 0	0 0 1 1 0			
U-BIT (PAL)	78	D2	OFF ON									0 1
DATE REC	78	D2	OFF ON			0 1						

RS-232C INTERFACE

- RS-232C commands - (continued)

■ DISPLAY Menus

Menu	DATA 0	D1/D2	Set value	Corresponding bit values (D1/D2)							
				7	6	5	4	3	2	1	0
LCD BRIGHTNESS	F1	D1	MAX(5) to 0 to MIN(-5)					0	0	0	0
								0	1	0	1
								1	0	1	0
LCD CHROMA	F1	D1	MAX(5) to 0 to MIN(-5)	0	0	0	0				
				0	1	0	1				
				1	0	1	0				
LCD CONTRAST	F1	D2	MAX(5) to 0 to MIN(-5)					0	0	0	0
								0	1	0	1
								1	0	1	0
LCD AUTO OFF	F1	D2	OFF 30MIN 1HOUR 2HOUR		0 0 1 1	0 1 0 1					
DISPLAY	01	D1	OFF ON					0 1			
	72	D1	OFF ON AUTO							0 0 1	0 1 0
COUNTER POSI.	82	D1	LOWER R LOWER L UPPER R UPPER L CENTER	0 0 1 1 -	0 0 0 0 -	0 0 1 1 -	0 0 1 1 -	0 1 0 1 -	0 0 0 0 -	0 0 0 0 -	0 0 0 0 -
TIME CODE	72	D1	OFF ON						0 1		
VTR MODE	72	D1	OFF ON					0 1			
TAPE REMAIN	82	D2	OFF ON				0 1				
TIME/DATE	83	D2	OFF TIME DATE DATE+TM						0 0 0 0	0 0 1 1	0 1 0 1
AUDIO INFO.	72	D1	OFF ON				0 1				
EDIT INFO.	72	D1	OFF ON			0 1					
DATE STYLE	83	D2	YY/MM/DD MM/DD/YY DD/MM/YY				0 0 1	0 1 0			
TIME STYLE	83	D2	12H 24H		0 1						

When an error occurs, BR-DV6000 automatically self-diagnoses the cause and displays an error-coded warning message on the monitor.

If BR-DV6000 is not in good order, or if an operation error has occurred, an alarm display will be shown on the monitor or the LCD.

Warning display

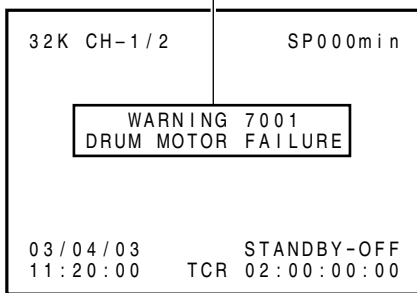

Alarm display

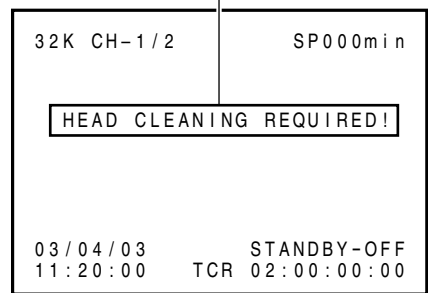

■ Alarm display (Displayed regardless of the DISPLAY mode)

Display	Status	Action
LOW VOLTAGE	The DC power voltage is low. BR-DV6000 will eventually go into the OPERATE OFF mode if operation is continued.	Check the power voltage.
HEAD CLEANING REQUIRED!	The video head is dirty. (This message is displayed when the DISPLAY mode is ON or AUTO.) If the head is clogged, it will be detected and the alarm message will be displayed in the PLAYBACK mode. The display disappears when the cassette is ejected or the head gets cleared of clog. The message will also disappear when the head cleaning tape is loaded.	Clean it with a JVC head-cleaning tape. (☞ Page 8) If the message persists despite cleaning, it could be due to bad recording condition, defective tape or head lifespan.
OVER HEATING!	The internal temperature of BR-DV6000 has exceeded the stated value.	Disconnect the power and place BR-DV6000 in a cool place. If this message is displayed again, the unit may have been damaged. In such a case, consult your JVC authorized dealer.
UNPLUG MAIN POWER, PLUG BACK IN AFTER A WHILE	This is a system error that occurs when the power is turned on. The OPERATE indicator on BR-DV6000 blinks in green. The unit will not accept any operation commands.	Unplug the power cord from the power outlet and wait for some time before plugging it back in.

- For alarm displays resulting from operation errors, Refer to page 24.

OTHERS

- Warning display - (continued)

■ Warning display (Displayed regardless of the DISPLAY mode)

When a warning display appears, BR-DV6000 stops operation and ceases to accept any operation command. When TAPE DEFFECTIVE (5605 - 5609) is displayed, the unit similarly stops all operations except EJECT operation.

Display	Status	Action
WARNING 0201 CONDENSATION ON DRUM	Condensation.	Leave the power on and wait for the display to disappear.
WARNING 3200 LOADING FAILURE	Unable to load tape.	This error can be resolved by turning off and then on the power. However, doing so may damage the tape in some cases. Consult your JVC authorized dealer.
WARNING 3300 UNLOADING FAILURE	Unable to eject tape.	
WARNING 4100 CASSETTE EJECT FAILURE	Eject error.	
DEFFECTIVE TAPE! 5605 - 5609	Broken tape.	Press the EJECT button to remove and replace the tape.
WARNING 5702 TAPE END DET. ERROR!	Tape-end sensor error.	This error can be resolved by turning off and then off the power. However, doing so may damage the tape in some cases. Consult your JVC authorized dealer.
WARNING 5802 TAPE BEGIN DET. ERROR!	Tape-beginning sensor error.	
WARNING 7001 DRUM MOTOR FAILURE	Drum rotation error.	
WARNING 7101 CAP MOTOR FAILURE	Capstan rotation error.	
WARNING 7202 - 7203 SUPPLY REEL FAILURE	Supply reel rotation error.	
WARNING 7302 - 7303 TAKE UP REEL FAILURE	Take up reel rotation error.	
WARNING 7305 TAKE UP REEL FAILURE	Tape winding error during unloading.	
WARNING 7401 REEL MOTOR FAILURE	Reel motor rotation error.	

Memo

This unit uses a microcomputer. It may not function correctly if there is external noise. If this happens, please turn off the power and then on again.

Symptom	Action
No power	Is the AC adapter correctly connected?
Unable to record.	Is the slide of the cassette tape turned to "REC"? Set it to "REC" if it is at the "SAVE" position.
The operation buttons of BR-DV6000 do not work.	Is OPERATION LOCK of the SYSTEM (2/2) menu set to ON? Set it to OFF if the operation buttons are to be used. For REMOTE, select the buttons that can be operated with the LOCAL FUNCTION Menu.
Editing cannot be controlled even after the REMOTE/LOCAL switch is set to REMOTE.	To control with RS-422A, set REMOTE SEL 9-PIN in the REMOTE (1/2) Menu screen to "ON". To control with the JVC bus, set REMOTE SEL JVC to "ON".
Noise is produced on the playback video. Playback sound interrupted.	<ul style="list-style-type: none"> • The tape is damaged. Replace the tape. • The head is dirty. Clean it with the specified head-cleaning tape. (Page 8)
Time codes are not correctly recorded during DV signal input.	Is TC DUPLICATE in the TC/UB/CLOCK (1/2) Menu screen correctly set up?
Unable to turn on the power with the OPERATE button.	Isn't the REMOTE/LOCAL switch set to REMOTE when LOCAL FUNCTION in the REMOTE Menu screen is not set to ALL KEYS?
Serial remote control does not function.	Isn't REMOTE SEL SER in the REMOTE (1/2) Menu screen set to OFF? For serial remote control, set it to ON or LOC+REM.
Unable to operate BR-DV6000 with the DV terminal.	Isn't REMOTE SEL DV in the REMOTE (1/2) Menu screen set to OFF? To operate with the DV terminal, set it to ON or LOC+REM.
When the power is turned on, the unit goes into the REC or PLAYBACK mode.	The TIMER switch on the rear panel is set to REC or PLAY. Check the setting of the TIMER switch before turning on the power.

This unit displays the drum usage time as the hour meter in DRUM HOUR METER in the SYSTEM (2/2) Menu screen. Use it as a guide for regular maintenance. (Page 7)

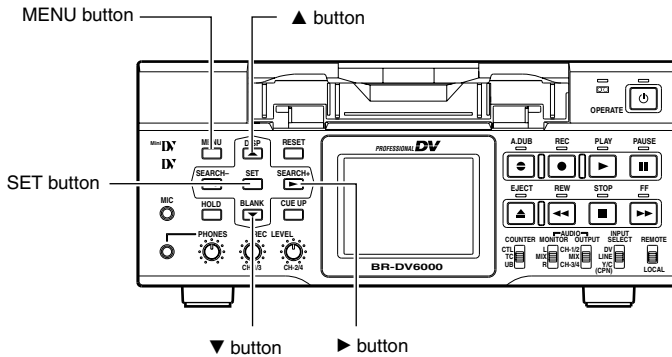

TOP MENU screen

```

---MENU---
>SYSTEM..
REMOTE..
AUDIO..
VIDEO..
TC/UB/CLOCK..
DISPLAY SET..
NETWORK PACK CONFIG..
MOVIE CLIP..
EXIT
    
```

SYSTEM (1/2) Menu screen

```

---SYSTEM[1/2]---
SYNC SELECT      AUTO
STL/F.ADV MODE  2ND
BACKUP REC TIME  OFF
LONG PAUSE TIME  5MIN
LONG PAUSE MODE  F.ADV
"◀▶" KEY FUNC.  INDEX
REPEAT MODE      OFF
>NEXT PAGE
PAGE BACK
    
```

SYSTEM (2/2) Menu screen

```

---SYSTEM[2/2]---
>DC IN MODE      ON OFF
INDEX WRITE      ON
REPLICATION      OFF
REPLICATE DELAY  OFF
OPERATION LOCK   OFF
PB/DV IN        PAL
FACTORY SETTING  CANCEL
DRUM HOUR METER  000200
PAGE BACK
    
```

Drum usage time

Operation

■ Set BR-DV6000 to the STOP mode:

1. Press the MENU button to display the TOP MENU screen.
2. Press the ▲ or ▼ button to bring the cursor to SYSTEM. Press SET or the ▶ button. → The SYSTEM (1/2) Menu screen is displayed.
3. Press the ▲ or ▼ button to bring the cursor to NEXT PAGE. Press SET or the ▶ button. → The SYSTEM (2/2) Menu screen is displayed.
 - The drum usage time is displayed on DRUM HOUR METER in the SYSTEM (2/2) Menu screen.
4. Press the MENU button to return to the normal screen.

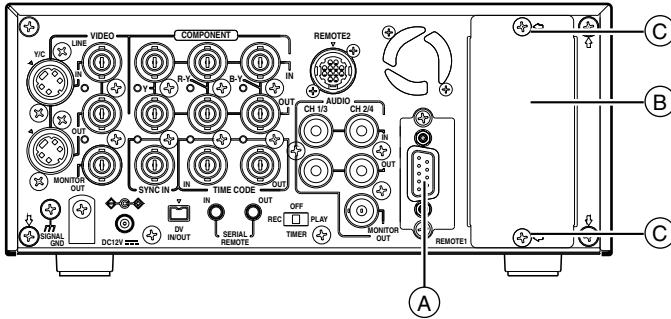

Memo

Install an optional board, SA-DV6000, SA-X61U, or SA-X62U to ⑥ as shown in the diagram above.

■ **RS-232C interface board: SA-K46U**

This is an interface board for controlling BR-DV6000 with the RS-232C interface. Connect it to BR-DV6000 with the RS-232C cable. Use a reverse-type cable.

- Replace it with the RS-422A REMOTE (9-PIN) terminal of ④. (☞ Page 102)
- To control BR-DV6000 with RS-232C, set REMOTE SEL 232 in the REMOTE (1/2). Menu screen to "ON".
- Details of the command: (☞ Page 84)

■ **Network board: SA-DV6000**

This network board can be used to record streaming data of video and sound of BR-DV6000 on to CF card, and to transmit streaming data to the PC via a LAN card.

- Connect it to ⑥.
- To control BR-DV6000 with SA-DV6000, set REMOTE SEL NET in the REMOTE (1/2). Menu screen to ON or LOC+REM.
- With the SA-DV6000 installed, the network-related menus will be added.

For details, refer to the user's guide of SA-DV6000.

■ **XLR IN board: SA-X61U**

This is an audio input board with two XLR terminals.

- Connect it to ⑥.
- To enable audio input from the terminals, set AUDIO INPUT SEL in the AUDIO Menu screen to XLR. (☞ Page 78)

■ **XLR OUT board: SA-X62U**

This is an audio output board with two XLR terminals.

- Connect it to ⑥.

Installing SA-X61U or SA-X62U

1. Remove the slot cover by removing the two ③ screws, which are securing the cover.
2. Insert SA-X61U or SA-X62U into BR-DV6000.
3. Fix SA-X61U or SA-X62U to BR-DV6000 with the two ③ screws, removed in 1.

Note

Contact your JVC authorized service agent before installing the above optional boards.

The RS-422A REMOTE 1 terminal of BR-DV6000 can be replaced with SA-K46U RS-232C interface board. Use the plate for the RS-422A REMOTE 1 terminal for installing SA-K46U RS-232C interface board.

The replacement procedure is described below. However, to prevent electrical shock or injury, the work should be performed only by a qualified personnel or a JVC authorized service agent.

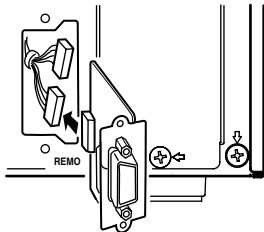
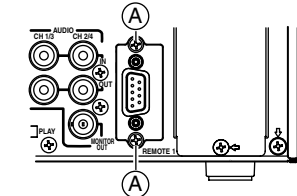

RS-422A REMOTE

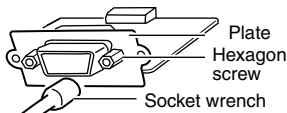

SA-K46U

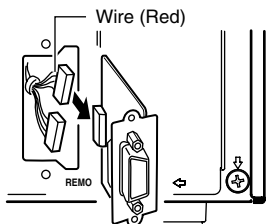
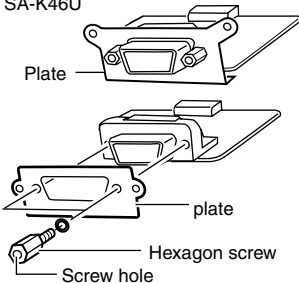

Caution

To prevent electrical shock, remove the AC adaptor before installing SA-K46U.

1. Remove the RS-422A REMOTE 1 terminal.

- ① Remove the two screws (A) and pull out the RS-422A REMOTE 1 terminal.
 - ② Remove the connector cable connected to the connector of the RS-422A REMOTE board.
- *Remove the cable carefully not to damage it.

2. Remove the plate of RS-422A REMOTE 1 terminal.

- For removing the plate, remove the two hexagonal screws first with a tool such as a socket wrench.

3. Remove the SA-K46U plate in the same procedure above.

4. Fix the plate of RS-422A REMOTE 1 terminal, removed in 2 above, to SA-K46U.

Hexagonal screws

The screw holes for the hexagonal screws of RS-422A are of the metric system while those of RS-232C are of the inch system.

5. Install the SA-K46U.

- ① Connect the connector cable with red wires to the connector of the SA-K46U board.

Memo

BR-DV6000 connector cable colors
 RS-232C: Red RS-422A: Yellow

- ② Fix SA-K46U to BR-DV6000 with the two screws (A), removed in 1 - ①.

■ General

Recording system : DV system (SP mode only)
Signal system : NTSC/PAL (NTSC for playback and DV input only)
Cassette tape : Standard/ mini DV cassette tape
Tape width : 6.35mm
Tape speed : 18.812mm/s (NTSC)
 18.831mm/s (PAL)

Recording/ playback time

: 276 minutes (LA-DV276)
 60 minutes (M-DV60)

Fast forward/ rewind time

: About 3 minutes (LA-DV276)
 About 1 minute (M-DV60)

Power : DC12 V \equiv (By the supplied AC adapter)

Power consumption : 24 W

External dimension : 212 mm (W) \times 88mm (H)
 \times 327mm (D) (Excluding protruding parts)

Weight : About 4.5 kg

Allowable operating temperature
 : 5°C to 40°C

Allowable storage temperature
 : -20°C to 60°C

Allowable operating RH

: 30%RH to 80%RH

■ Video

Recording format : 8 bit, 13.5 MHz,
 4:1:1 (NTSC)
 4:2:0 (PAL)

Video input

Line (composite) : 1.0 V (p-p), 75 Ω unbalanced

Y/C **Y** : 1.0 V (p-p), 75 Ω unbalanced

C : 0.3 V (p-p), 75 Ω unbalanced

Component **Y** : 1.0 V (p-p), 75 Ω unbalanced
 (100%, Color Bar)

R-Y : 0.7 V (p-p), 75 Ω unbalanced
 (100%, Color Bar, without Setup)

B-Y : 0.7 V (p-p), 75 Ω unbalanced
 (100%, Color Bar, without Setup)

Video output

Line (composite) : 1.0 V (p-p), 75 Ω unbalanced

Y/C **Y** : 1.0 V (p-p), 75 Ω unbalanced

C : 0.286 V (p-p) (NTSC) /

0.3 V (p-p) (PAL)

75 Ω unbalance

Component **Y** : 1.0 V (p-p), 75 Ω unbalanced
 (100%, Color Bar)

R-Y : 0.7 V (p-p), 75 Ω unbalanced
 (100%, Color Bar, without Setup)

B-Y : 0.7 V (p-p), 75 Ω unbalanced
 (100%, Color Bar, without Setup)

Monitor (composite) : 1.0 V (p-p), 75 Ω unbalanced
 (On-screen display)

Horizontal resolution : At least 500 lines

S/N : At least 50 dB

■ Audio

Recording format : 16 bit, 48kHz, 2-channels
 PCM audio/12 bit, 32kHz,
 4-channel PCM audio

Number of track : 2 (16 bit, 4 8kHz) /
 4 (12 bit, 32kHz)

Audio input : -8 dBs, 10 k Ω unbalanced

Mike input : -60 dBs, 3 k Ω unbalanced

Audio output : -8 dBs, 1 k Ω unbalanced

Headphone : - to -20 dBs,
 33 k Ω unbalanced (stereo)

Monitor : -8 dBs, 1 k Ω unbalanced
 (monaural)

Frequency characteristics

: 20 Hz to 20 kHz (48kHz)

20 Hz to 16 kHz (32kHz)

XLR terminal (Option)

Input : + 4 dBs, high impedance, balanced

Output : + 4 dBs, low impedance, balanced

■ DV interface

Input/output : IEEE1394

■ Time code

LTC input : 0 \pm 6 dBs, high impedance

LTC output : 0 \pm 6 dBs, low impedance

■ AC adapter

Input : AC 220 V to 240 V \sim ,
 50 Hz/60 Hz \times 1.5 A

Output : DC 12 V \equiv 5 A

■ Accessories

AC adapter \times 1

Power cord \times 2

■ External dimensions (Unit: mm)

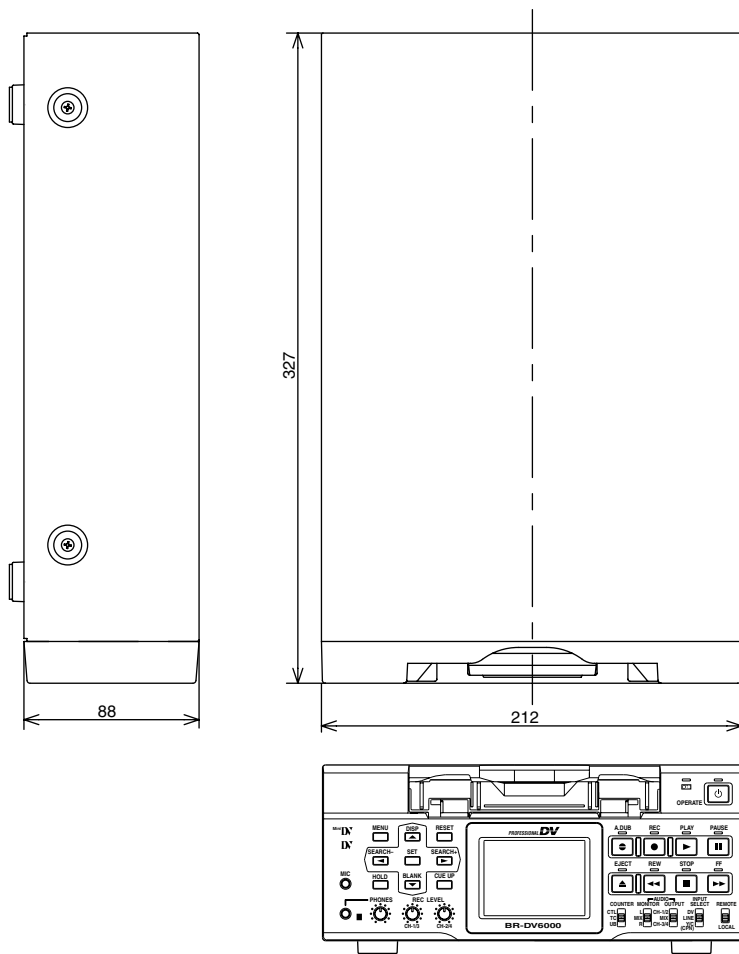

For improvement, the specifications and external appearance may be changed without prior notice.



JVC® is a registered trademark owned by VICTOR COMPANY OF JAPAN, LTD.

JVC® is a registered trademark in Japan, the U.S.A., the U.K. and many other countries.

© 2003 VICTOR COMPANY OF JAPAN, LIMITED



LLT0034-002B-H

Free Manuals Download Website

<http://myh66.com>

<http://usermanuals.us>

<http://www.somanuals.com>

<http://www.4manuals.cc>

<http://www.manual-lib.com>

<http://www.404manual.com>

<http://www.luxmanual.com>

<http://aubethermostatmanual.com>

Golf course search by state

<http://golfingnear.com>

Email search by domain

<http://emailbydomain.com>

Auto manuals search

<http://auto.somanuals.com>

TV manuals search

<http://tv.somanuals.com>