

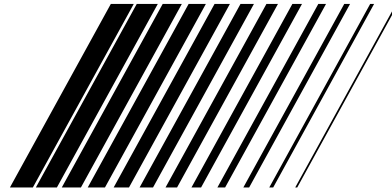

# JVC



## VIDEO CASSETTE RECORDER

# HR-A230EK HR-A231EK HR-A230ES

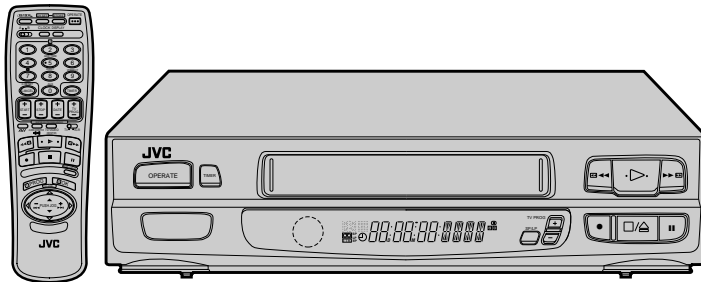

The recorder illustrations appearing in this instruction manual are of the HR-A230EK.

**VIDEO** *Plus+*



## INSTRUCTIONS

### CONTENTS

<b>SAFETY FIRST</b>	<b>2</b>
Safety Precautions .....	2
Some Do's And Don't's .....	3
<b>INSTALLING YOUR NEW RECORDER</b>	<b>4</b>
Basic Connections .....	4
Tune The TV To Your Video Recorder .....	5
Connection To A Satellite Receiver .....	6
<b>INITIAL SETTINGS</b>	<b>7</b>
Tuner Set .....	7
Clock Set .....	8
<b>PLAYBACK</b>	<b>10</b>
Basic Playback .....	10
Playback Features .....	11
<b>RECORDING</b>	<b>15</b>
Basic Recording .....	15
Recording Features .....	16
<b>TIMER RECORDING</b>	<b>17</b>
Information On Video Plus+ .....	17
Guide Channel Set .....	17
Video Plus+ Timer Recording .....	19
Regular Timer Programming .....	21
Check And Cancel Programmes .....	23
PDC Recording .....	23
<b>EDITING</b>	<b>24</b>
Edit To Or From Another Video Recorder .....	24
Edit From A Camcorder .....	25
<b>USING THE CONFIRMATION DISPLAY</b>	<b>26</b>
Storing Channels Manually .....	26
Delete A Channel .....	27
Change Station Preset Position .....	27
Set Stations .....	28
Fine-Tuning Channels Already Stored .....	29
<b>TV STATION AND ID LIST</b>	<b>30</b>
<b>TV STATION CHANNEL NUMBER GUIDE (U.K. ONLY)</b>	<b>31</b>
<b>TROUBLESHOOTING</b>	<b>32</b>
<b>QUESTIONS AND ANSWERS</b>	<b>34</b>
<b>INDEX</b>	<b>35</b>
<b>SPECIFICATIONS</b>	<b>Back Cover</b>

PU30425-1807-1



# Safety Precautions

The rating plate and the safety caution are on the rear of the unit.

**WARNING: DANGEROUS VOLTAGE INSIDE**

**WARNING: TO PREVENT FIRE OR SHOCK HAZARD, DO NOT EXPOSE THIS UNIT TO RAIN OR MOISTURE.**

## IMPORTANT

**Connection to the mains supply in the United Kingdom. DO NOT cut off the mains plug from this equipment.** If the plug fitted is not suitable for the power points in your home or the cable is too short to reach a power point, then obtain a proper safety approved extension lead/adaptor or consult your dealer.

**BE SURE to replace the fuse only with an identical approved type, as originally fitted, and to replace the fuse cover.**

If nonetheless the mains plug is cut off remove the fuse and dispose of the plug immediately, to avoid a possible shock hazard by inadvertent connection to the mains supply. If this product is not supplied fitted with a mains plug then follow the instructions given below:

**DO NOT** make any connection to the Larger Terminal coded E or Green.

The wires in the mains lead are coloured in accordance with the following code:

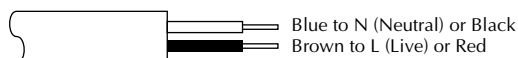

If these colours do not correspond with the terminal identifications of your plug, connect as follows:  
Blue wire to terminal coded N (Neutral) or coloured Black.  
Brown wire to terminal coded L (Live) or coloured Red.

**If in doubt — consult a competent electrician.**

## CAUTION

- When you are not using the recorder for a long period of time, it is recommended that you disconnect the power cord from the mains outlet.
- Dangerous voltage inside. Refer internal servicing to qualified service personnel. To prevent electric shock or fire hazard, remove the power cord from the mains outlet prior to connecting or disconnecting any signal lead or aerial.



- Only cassettes marked "VHS" can be used with this videorecorder.
- HQ VHS is compatible with existing VHS equipment.
- Video Plus+ and PlusCode are trademarks of Gemstar Development Corporation. The Video Plus+ system is manufactured under licence from Gemstar Development Corporation.

## IMPORTANT

- Please read the various precautions on p. 2 – 3 of this instruction manual before installing or operating the recorder.
- It should be noted that it may be unlawful to re-record pre-recorded tapes, records, or discs without the consent of the owner of copyright in the sound or video recording, broadcast or cable programme and in any literary, dramatic, musical, or artistic work embodied therein.

The OPERATE button does not completely shut off mains power from the unit, but switches operating current on and off.

Video tapes recorded with this video recorder in the LP (Long Play) mode cannot be played back on a single-speed video recorder.

**Failure to heed the following precautions may result in damage to the recorder, remote control or video cassette.**

- 1. DO NOT place the recorder . . .**
  - ... in an environment prone to extreme temperatures or humidity.
  - ... in direct sunlight.
  - ... in a dusty environment.
  - ... in an environment where strong magnetic fields are generated.
  - ... on a surface that is unstable or subject to vibration.
- 2. DO NOT block the recorder's ventilation openings.**
- 3. DO NOT place heavy objects on the recorder or remote control.**
- 4. DO NOT place anything which might spill on top of the recorder or remote control.**
- 5. AVOID violent shocks to the recorder during transport.**

## MOISTURE CONDENSATION

Moisture in the air will condense on the recorder when you move it from a cold place to a warm place, or under extremely humid conditions—just as water droplets form in the surface of a glass filled with cold liquid. Moisture condensation on the head drum will cause damage to the tape. In conditions where condensation may occur, keep the recorder turned on for a few hours to let the moisture dry.

## ABOUT HEAD CLEANING

Accumulation of dirt and other particles on the video heads may cause the playback picture to become blurred or interrupted. Be sure to contact your nearest JVC dealer if such troubles occur.



## 4-STEP QUICK SET UP

1



PAGE 4

2



PAGE 5

3



PAGE 7

4



PAGE 8

## Some Do's And Don'ts On The Safe Use Of Equipment

This equipment has been designed and manufactured to meet international safety standards but, like any electrical equipment, care must be taken if you are to obtain the best results and safety is to be assured.

- DO** read the operating instructions before you attempt to use the equipment.
- DO** ensure that all electrical connections (including the mains plug, extension leads and interconnections between pieces of equipment) are properly made and in accordance with the manufacturer's instructions. Switch off and withdraw the mains plug when making or changing connections.
- DO** consult your dealer if you are ever in doubt about the installation, operation or safety of your equipment.
- DO** be careful with glass panels or doors on equipment.
- DON'T** continue to operate the equipment if you are in any doubt about it working normally, or if it is damaged in any way — switch off, withdraw the mains plug and consult your dealer.
- DON'T** remove any fixed cover as this may expose dangerous voltages.
- DON'T** leave equipment switched on when it is unattended unless it is specifically stated that it is designed for unattended operation or has a standby mode. Switch off using the switch on the equipment and make sure that your family knows how to do this. Special arrangements may need to be made for infirm or handicapped people.
- DON'T** use equipment such as personal stereos or radios so that you are distracted from the requirements of road safety. It is illegal to watch television whilst driving.
- DON'T** listen to headphones at high volume, as such use can permanently damage your hearing.
- DON'T** obstruct the ventilation of the equipment, for example with curtains or soft furnishings. Overheating will cause damage and shorten the life of the equipment.
- DON'T** use makeshift stands and NEVER fix legs with wood screws — to ensure complete safety always fit the manufacturer's approved stand or legs with the fixings provided according to the instructions.
- DON'T** allow electrical equipment to be exposed to rain or moisture.

### ABOVE ALL...

- NEVER let anyone especially children push anything into holes, slots or any other opening in the case — this could result in a fatal electrical shock;
- NEVER guess or take chances with electrical equipment of any kind — it is better to be safe than sorry!



# 4

## INSTALLING YOUR NEW RECORDER

# Basic Connections

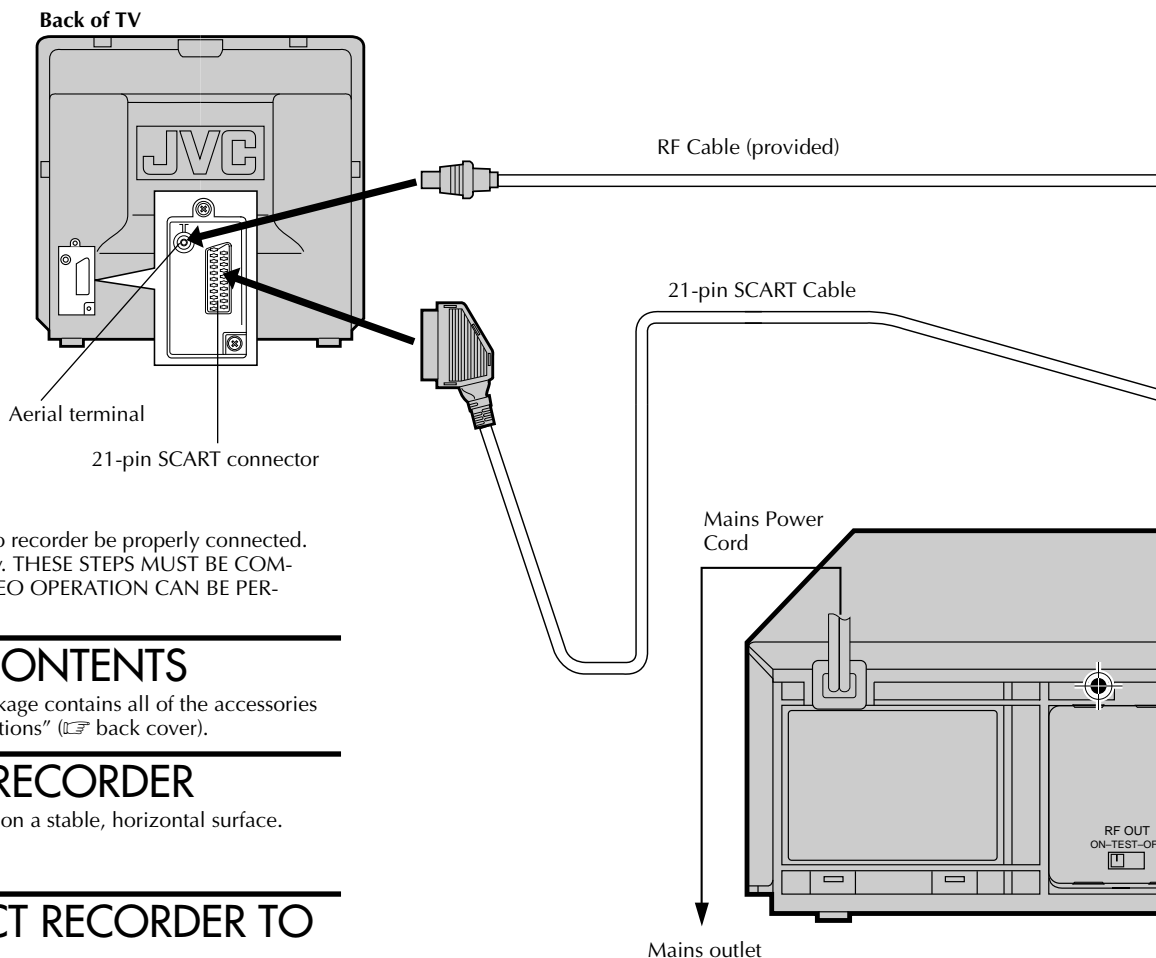

It's essential that your video recorder be properly connected. Follow these steps carefully. THESE STEPS MUST BE COMPLETED BEFORE ANY VIDEO OPERATION CAN BE PERFORMED.

### 1

#### CHECK CONTENTS

Make sure the package contains all of the accessories listed in "Specifications" (☞ back cover).

### 2

#### SITUATE RECORDER

Place the recorder on a stable, horizontal surface.

### 3

#### CONNECT RECORDER TO TV

The connection method you use depends on the type of TV you have.

##### RF CONNECTION

- To Connect To A TV With NO AV Input Terminals . . .
  - a- Disconnect the TV aerial cable from the TV.
  - b- Connect the TV aerial cable to the ANT. IN jack on the rear panel of the recorder.
  - c- Connect the provided RF cable between the RF OUT jack on the rear panel of the recorder and the TV's aerial terminal.

Before operating the recorder, make sure the TV's preset is set to the VIDEO preset.

##### AV CONNECTION

- To Connect To A TV With AV Input Terminals . . .
  - a- Connect the aerial, recorder and TV as per "RF CONNECTION".
  - b- Connect an optional SCART cable between the AV1 IN/OUT socket on the rear panel of the recorder and the TV's 21-pin SCART connector.
  - c- Set the RF OUT switch to OFF.

Before operating the recorder, make sure the TV is set to the VIDEO (or AV) mode.

### 4

#### CONNECT RECORDER TO MAINS

Plug the end of the mains power cord into a mains outlet.

# Tune The TV To Your Video Recorder

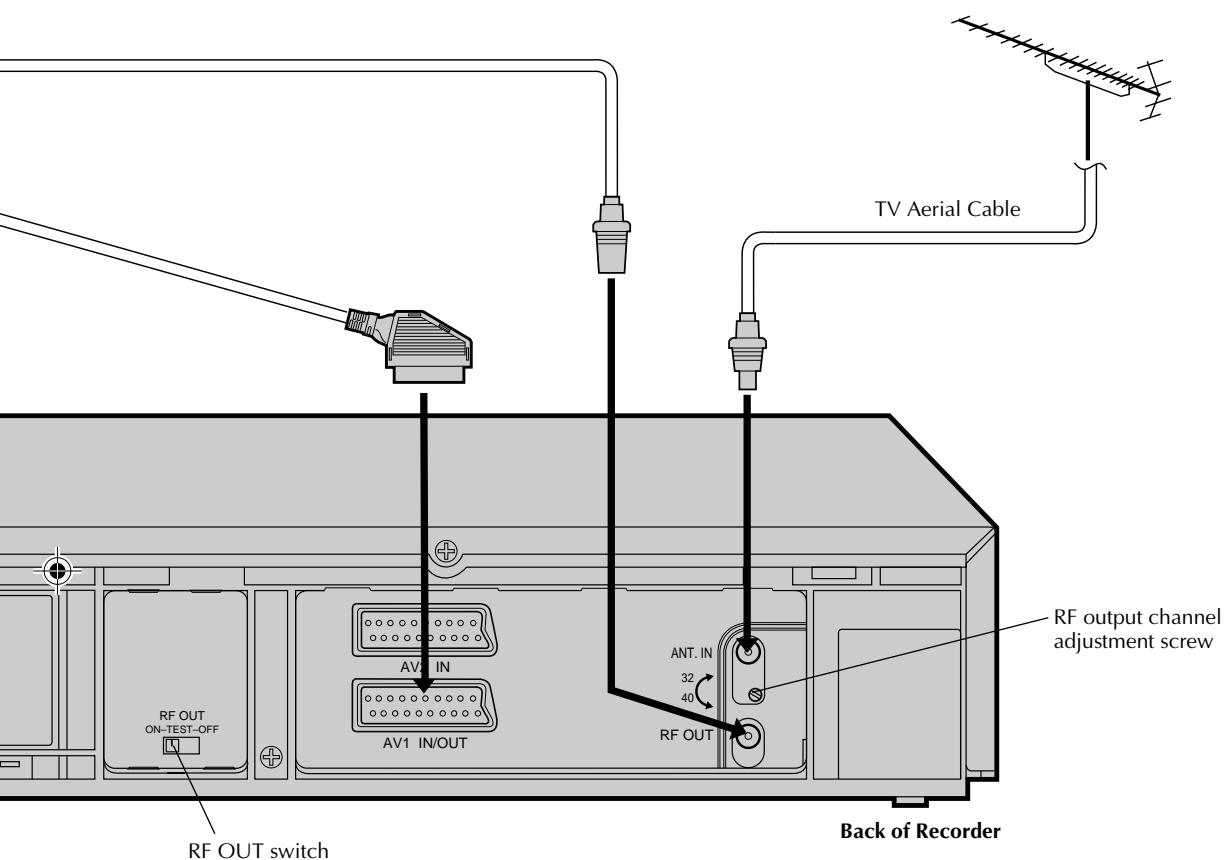

The video recorder sends picture and sound signals via the RF connecting cable to your TV on UHF channel 36.

1

## TURN ON THE RECORDER

Press **OPERATE**.

2

## SELECT OUTPUT MODE

Set the **RF OUT** switch on the back of the recorder to **TEST**.

3

## SET TV PRESET

Set your TV to the video preset (UHF channel 36). Two white bars appear on screen vertically.

- Tune the TV until the bars are as clear as they can be.
- Your TV should be set to the preset designated for use with a video recorder, or to a spare preset if there is not a specified video preset on your TV.

4

## RESET OUTPUT MODE

Return the **RF OUT** switch to **ON**.

### NOTE:

*If some interference noise is continually seen on the screen, consult your JVC dealer.*



# 6

## INSTALLING YOUR NEW RECORDER (cont'd)

# Connection To A Satellite Receiver

The AV2 IN socket on the rear panel of your recorder allows simple connection to a satellite receiver.

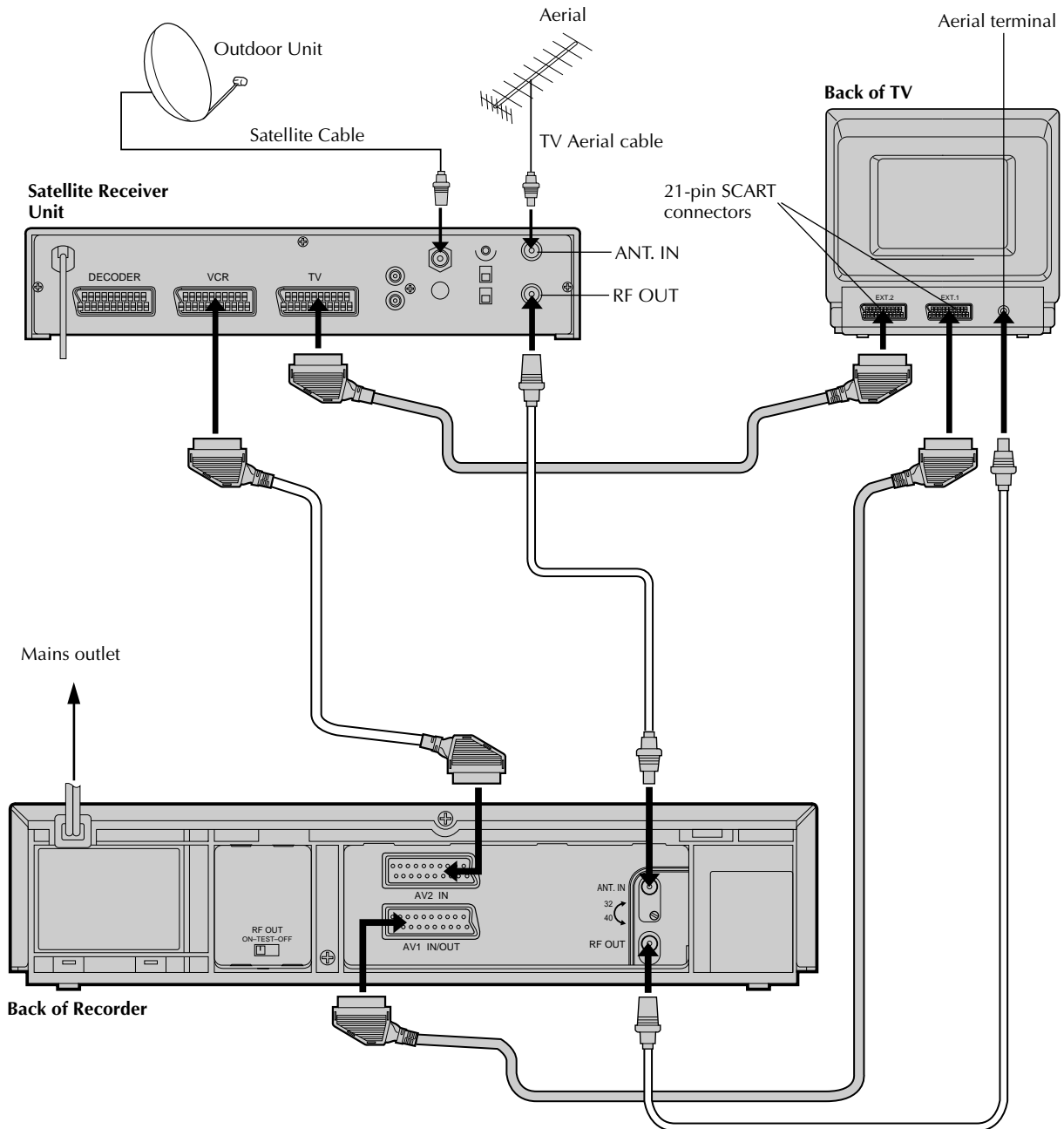

### NOTES:

- When connecting your recorder to a TV equipped with 21-pin SCART connectors, follow the illustration above using the cables shown in gray.
- For details, check your satellite receiver's instruction manual.



# Tuner Set

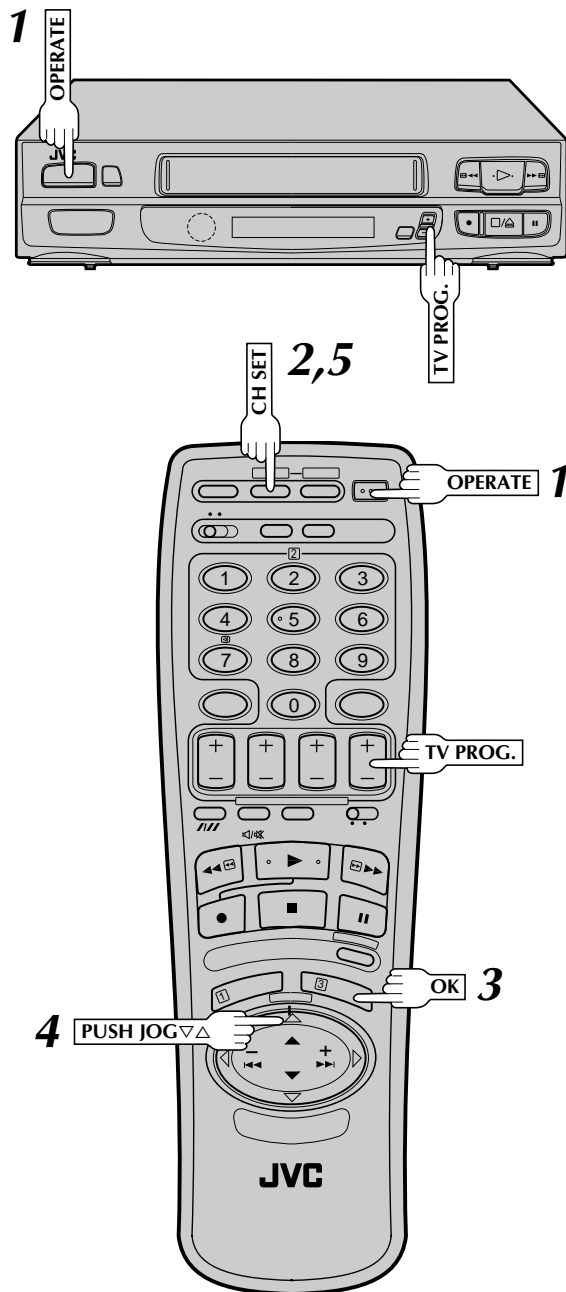

Your recorder needs to memorise all necessary stations in preset positions in order to record TV programmes. ATS+ (Auto Tuning System) automatically assigns all receivable stations in your area to call them up with the **TV PROG.** buttons without going through any vacant channels.

The following procedure describes how to select automatic channel setting.

## TURN ON THE RECORDER

Press **OPERATE**.

## ACCESS CH. SET DISPLAY

Press and hold **CH SET** for more than 2 seconds. "AUTO" appears on the front display panel.

## START AUTO CHANNEL SET

Press **OK** and "AUTO" blinks on the front display panel.

## ACCESS CONFIRMATION DISPLAY

The preset position, channel and station name (ID - pg. 30) of the stations located by your recorder appear in a Confirmation display.

(Ex.)

Preset Position      Channel      Station Name



Confirm all the stored stations by using **PUSH JOG**.

## RETURN TO NORMAL DISPLAY

Press **CH SET**.

- Using the Confirmation display, you can skip or add preset positions, enter station names and perform other operations. Refer to page 26 for the procedures.
- Depending on the reception conditions, the stations may not be stored in order, and the station names may not be stored correctly.

## NOTES:

- Fine tuning is performed automatically when you select "AUTO CH SET". If you want to perform it manually, refer to page 29.
- To set the tuner manually, refer to "Storing Channels Manually" (pg. 26).

# Clock Set

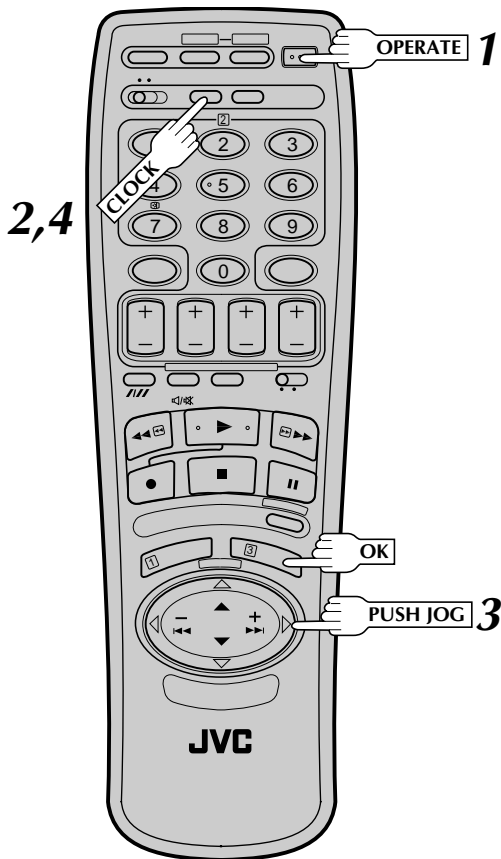
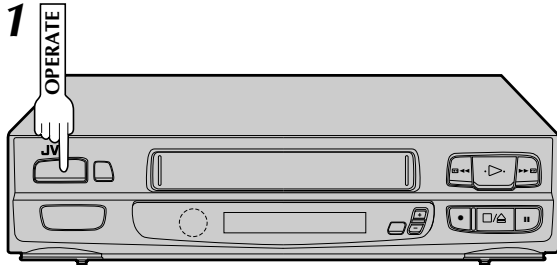

If you performed Auto Channel Set (pg. 7), the recorder's built-in clock is also set automatically. The Auto and Manual clock setting procedures are necessary when . . .

- a power outage of more than 3 minutes occurs.
- the tuner has been set manually.
- the user desires to set the clock slightly ahead of the actual time.
- the clock was not set even after Auto Tuner Set was performed.

Whether you perform Auto or Manual clock setting, you can use the convenient Just Clock function.

## Just Clock

The Just Clock function provides accurate time keeping through automatic adjustments at regular intervals, by reading data from a PDC signal.

The Just Clock option appears in the Just Clock display, and can be set "ON" or "OFF" (the default setting is "ON"). Press **OK** until the Just Clock setting begins blinking, then press **PUSH JOG** to change the setting.

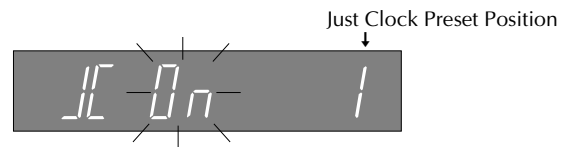

**IMPORTANT:** If you turn off Just Clock off, the accuracy of your recorder's built-in clock may be reduced, which could adversely effect timer recording.

Both Auto and Manual clock setting procedures begin from step 3.

## Preparation

### TURN THE RECORDER ON

**1** Press **OPERATE**.

### ACCESS CLOCK SET DISPLAY

**2** Press **CLOCK** on the remote control. The Clock Set display appears.



## Auto Clock Set

### SET CLOCK AUTOMATICALLY

**3** At the Clock Set display, press **PUSH JOG**. The Clock Set display blinks and clock setting begins.

- If the Just Clock preset position isn't set to the preset position on which Auto Clock data is received, "Err"(or) appears, and then the display from step 2 reappears. To set the Just Clock preset position, press **OK** until the Just Clock preset position begins blinking, then cycle through the numbers by pressing **PUSH JOG** until the number representing the preset position in which the station transmitting clock setting data (BBC1, BBC2, etc.) is stored appears.

CONTINUED ON NEXT PAGE.



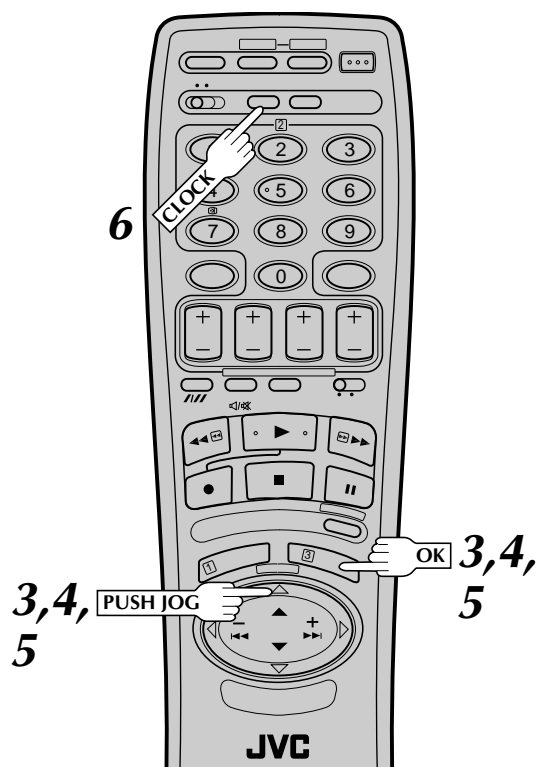
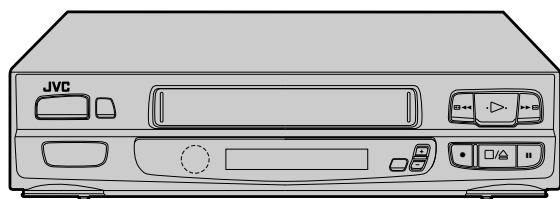

## NOTES:

- *Just Clock* (when set to "ON") enables adjustment of the recorder's built-in clock every hour on the hour, except for 11 o'clock in the evening and midnight.
- *Just Clock* is not effective when . . .
  - the recorder's power is on (unless the recorder is tuned to the same preset selected in the *Just Clock* display).
  - the recorder is in the *Timer* mode.
  - a difference of more than 3 minutes exists between the built-in clock's time and the actual time.
- If *Just Clock* is set to "ON", the recorder's clock is automatically adjusted at the start/end of *Summer Time*.
- *Auto clock* setting and *Just Clock* may not function properly depending on the reception condition.
- During *Manual* clock setting, if the day and month data are invalid (such as 31st April), the month digits are cleared automatically and the day digits begin blinking. Input the correct data.
- If, in step 3 of the *Manual* clock setting procedure, the year digits are automatically cleared and the day digits begin blinking, it is possible that you have input 29th February for a non-leap year. Input the correct data.

## RETURN TO NORMAL DISPLAY

- 4** Once clock setting is completed, press **CLOCK** to return to the normal display.

## Manual Clock Set

### SET DATE AND TIME

- 3** Press **PUSH JOG**  $\Delta \nabla$  to set the hour, then press **OK**. The "minutes" display begins blinking. Repeat the procedure to set the minutes, day, month and year.



After inputting the year, press **OK** and the *Just Clock* display appears.

### SET JUST CLOCK

- 4** The default setting is "OFF". Set as desired by pressing **PUSH JOG**  $\Delta \nabla$ , then press **OK**.

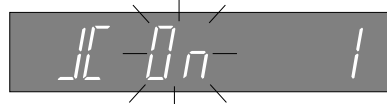

- If you set to "OFF", you can disregard the next step as you won't be able to receive regular clock adjustments.

### SET CLOCK DATA SOURCE PRESET POSITION

- 5** The recorder is preset to receive clock setting and adjustment data from preset position 1. Press **PUSH JOG**  $\Delta \nabla$  to set the preset position to the number representing the station transmitting clock setting data, then press **OK**.

### START CLOCK OPERATION

- 6** Press **CLOCK**.

# Basic Playback

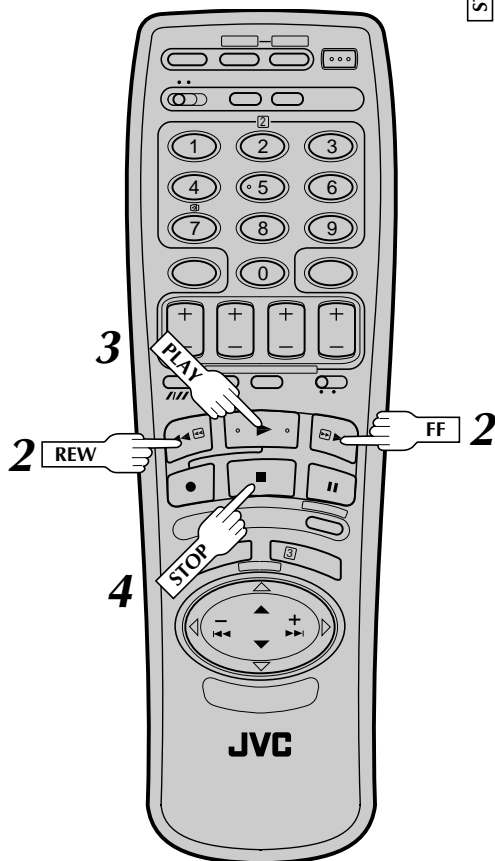
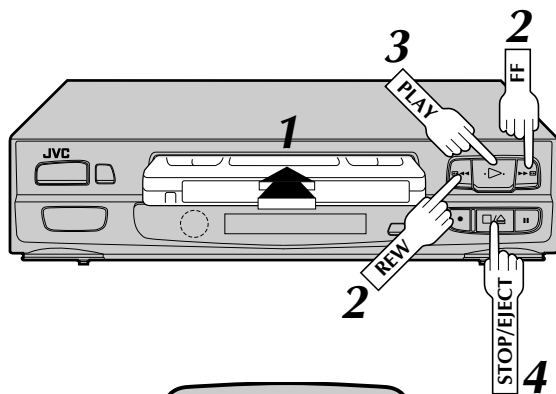

The easiest, most basic operation possible with your video recorder is tape playback. Already-recorded signals on a video tape are read by your video recorder and displayed on your TV just like a TV programme.

## 1 LOAD A CASSETTE

Make sure the window side is up, the rear label side is facing you and the arrow on the front of the cassette is point toward the recorder. Don't apply too much pressure when inserting.

- The recorder power comes on automatically and the counter is reset to 0:00:00.
- If the record safety tab has been removed, playback begins automatically.

## 2 FIND PROGRAMME START POINT

If the tape is advanced past the start point, press **REW**. To go forward, press **FF**.

## 3 START PLAYBACK

Press **PLAY**.

## 4 STOP PLAYBACK

Press **STOP** on the remote or **STOP/EJECT** on the recorder's front panel. Then press **STOP/EJECT** to remove the cassette.

### Usable cassettes

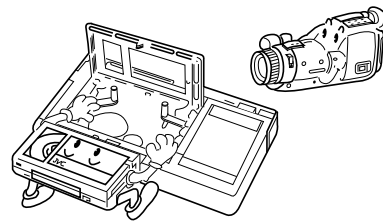

- Compact VHS camcorder recordings can be played on this video recorder. Simply place the recorded cassette into a VHS Cassette Adapter and it can be used just like any full-sized VHS cassette.
- This video recorder can record on regular VHS and Super VHS cassettes. However, it will record and play back regular VHS signals only. It is not possible to play back a recorded Super VHS tape.



# Playback Features

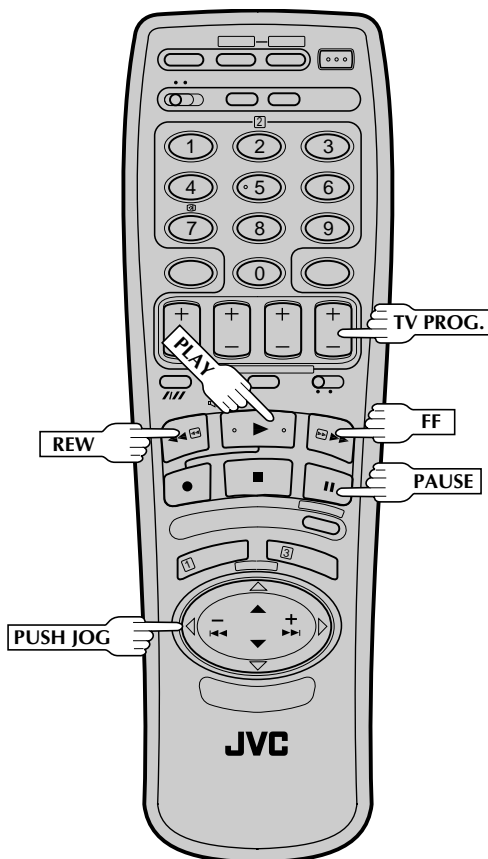
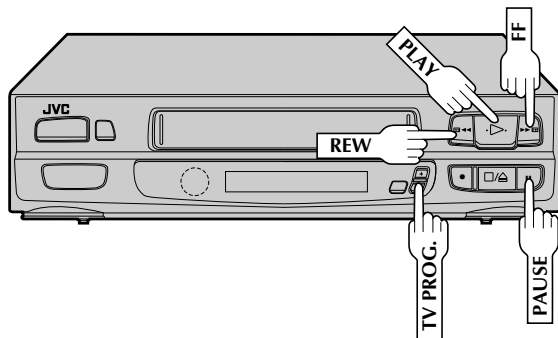

Take advantage of special functions possible with the recorder's controls or the remote control.

## Still Picture/Frame-By-Frame Playback

**1 PAUSE DURING PLAYBACK**  
Press **PAUSE**. If there is vertical jitter, use the **TV PROG.** buttons to correct the picture.

**2 ACTIVATE FRAME-BY-FRAME PLAYBACK**  
Press **PAUSE** again.  
**OR**  
Press **PUSH JOG** < or >.

To resume normal playback, press **PLAY**.

## Slow Motion

**1 ACTIVATE SLOW-MOTION PLAYBACK**  
During still picture, press and hold **PAUSE** for 2 seconds, then release. Press and release again to return to still picture.  
**OR**  
During still picture, press and hold **PUSH JOG** < or >. Release to return to still picture.

To resume normal playback, press **PLAY**.

## Variable-Speed Search

**1 ACTIVATE VARIABLE-SPEED SEARCH**  
During playback, press **PUSH JOG** < or >.

- The more times you press, the faster the playback picture moves.
- To decrease speed, press the button for the opposite direction.

To resume normal playback, press **PLAY**.

## High-Speed Search

**1 ACTIVATE HIGH-SPEED SEARCH**  
During playback or still, press **FF** for forward high-speed search, or **REW** for reverse high-speed search.

- For short searches during playback or still, press and hold **FF** or **REW** for over 2 seconds. When released, normal playback resumes.

To resume normal playback, press **PLAY**.

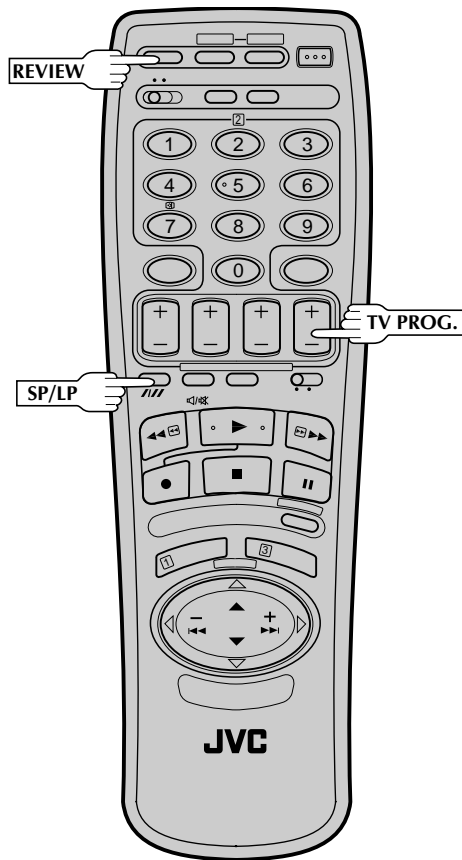
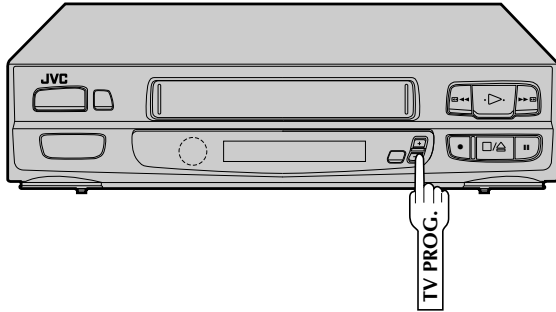

## Manual Tracking

Your video recorder is equipped with automatic tracking control. During playback, you can override this and adjust the tracking manually by pressing the **TV PROG.** buttons.

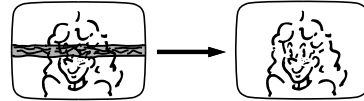

### 1 OVERRIDE AUTOMATIC TRACKING

Press **SP/LP** (//) on the remote to engage manual tracking.

### 2 ADJUST TRACKING MANUALLY

Press **TV PROG.** + or - to adjust tracking.

### 3 RETURN TO AUTOMATIC TRACKING

Press **SP/LP** (//) on the remote to re-engage automatic tracking.

#### NOTE:

When a new tape is inserted, the recorder enters the automatic tracking mode automatically.

## Instant ReView

Simply by pressing a single button, the recorder power comes on, rewinds, and begins playback of the last timer-recorded programme. If you have several programmes recorded, you can easily access any of them.

#### NOTE:

Before starting, make sure that the recorder is off and that the Timer mode is disengaged.

### 1 ACTIVATE INSTANT REVIEW

Press **REVIEW**. The recorder power comes on and the recorder searches for the index code indicating the start of the last timer-recorded programme. Once it's found, playback begins automatically. The front display panel tells you how many programmes have been recorded. If you have, for example, 3 programmes, "REV 3" appears and blinks. To watch the first of the 3 programmes, press **REVIEW** three times. The recorder searches and begins playback automatically. You can access a programme as far as 9 index codes away from the current tape position.

#### NOTE:

- Instant ReView is not possible while the recorder is in the Timer mode.

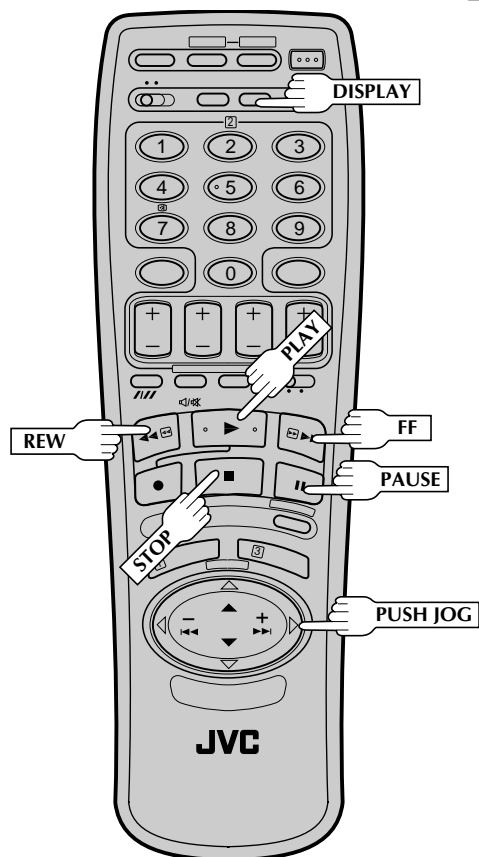
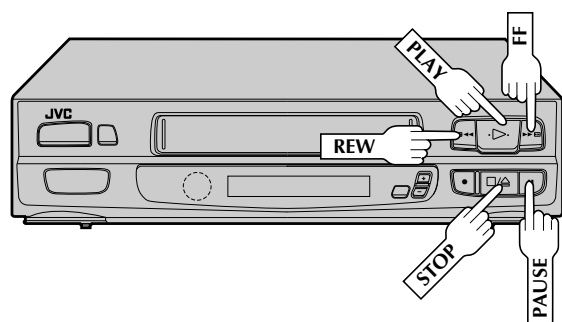

## Index Search

Your recorder automatically marks index codes at the beginning of each recording. This function gives you quick access to any one of 9 index codes in either direction.

### NOTE:

Before starting, make sure the recorder is in the Stop mode.

## 1 ACTIVATE INDEX SEARCH

Press **PUSH JOG** ◀ or ▶ (◀◀ or ▶▶). “-1” or “+1” is displayed on the display panel and search begins in the corresponding direction.

- To access index codes 2 through 9, press **PUSH JOG** ◀ or ▶ repeatedly until the correct index number is displayed.

Ex.: To locate the beginning of B from the current position, press **PUSH JOG** ◀ twice.

To locate the beginning of D from the current position, press **PUSH JOG** ▶ once.

Current position

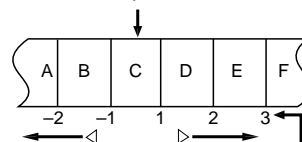

Index number

- When the specified index code is located, playback begins automatically.

## Repeat Playback

Your video recorder can automatically play back the whole tape 20 times repeatedly.



## 1 START PLAYBACK

Press **PLAY**.

## 2 ACTIVATE REPEAT PLAYBACK

Press **PLAY** and hold for over 5 seconds, then release.

- The Play indicator (▶) on the display panel blinks slowly.
- The tape plays 20 times automatically, and then stops.

## 3 STOP PLAYBACK

Press **STOP** at any time to stop playback.

### NOTE:

Pressing **PLAY**, **REW**, **FF** or **PAUSE** also stops Repeat Playback.

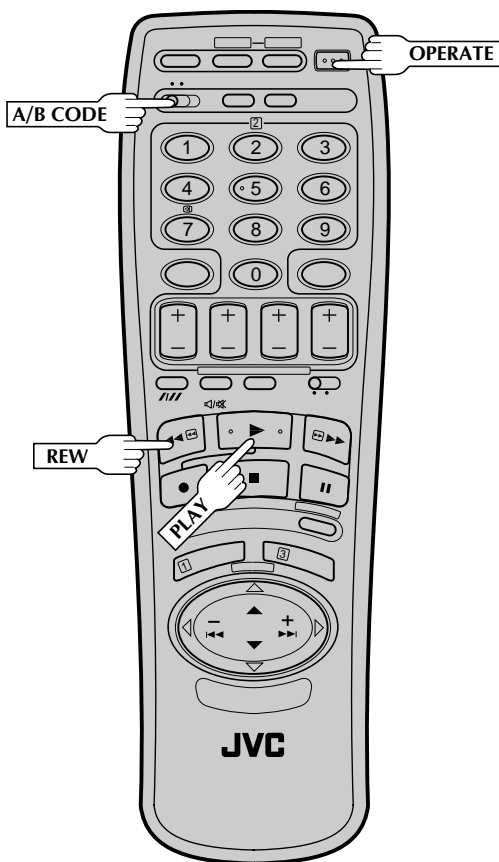
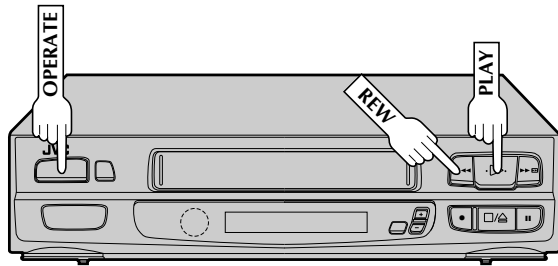

## Next Function Memory

You can set your recorder's power to go off automatically after the tape is fully rewound. Before starting, make sure the recorder is in the Stop mode.  
For Automatic Power Off After Tape Rewind . . .  
. . . press **REW**, then press **OPERATE** within 2 seconds.

## NTSC Playback

Your video recorder is equipped with NTSC circuitry that can play back NTSC tapes.

1

### LOAD A CASSETTE

Insert a cassette recorded in NTSC.

2

### START PLAYBACK

Press **PLAY**. "NT" appears on the display panel.

- Some TVs shrink the picture vertically and place black bars at the top and bottom of the screen. This is not a malfunction on the part of either the video recorder or the TV.
- The picture may roll up and down. This can be corrected using the V-HOLD control found on some TVs. (This cannot be corrected if the TV does not have a V-HOLD control.)
- The counter and elapsed tape time readings will be incorrect.
- During search, still, or frame-by-frame playback, the picture will be distorted, and there may be a loss of colour.
- Depending on the type of TV, the top and bottom portions of superimposed displays may be cut off during NTSC playback.

## Remote A/B Code Switching

The remote control is capable of controlling two JVC video recorders independently; one set to respond to the remote control's A code control signals and another set to respond to B code control signals. The remote control is preset to send A code signals because your video recorder is initially set to respond to A code signals. You can easily modify your video recorder to respond to B code signals.

1

### REMOVE POWER SUPPLY

Unplug the mains power cord from the mains outlet.

2

### SET A/B CODE SWITCH

Set to B.

3

### RE-SUPPLY POWER

Plug the mains power cord back into the mains outlet.

4

### TURN THE RECORDER ON

Press **OPERATE** on the remote control. The recorder will now only respond to B code signals.

## NOTE:

*Some TV sets may malfunction in response to the B mode. If this happens, switch back to the A mode.*



# Basic Recording

TV signals being received by the recorder's built-in tuner can be recorded onto a video tape. You can "capture" a TV programme using your video recorder.

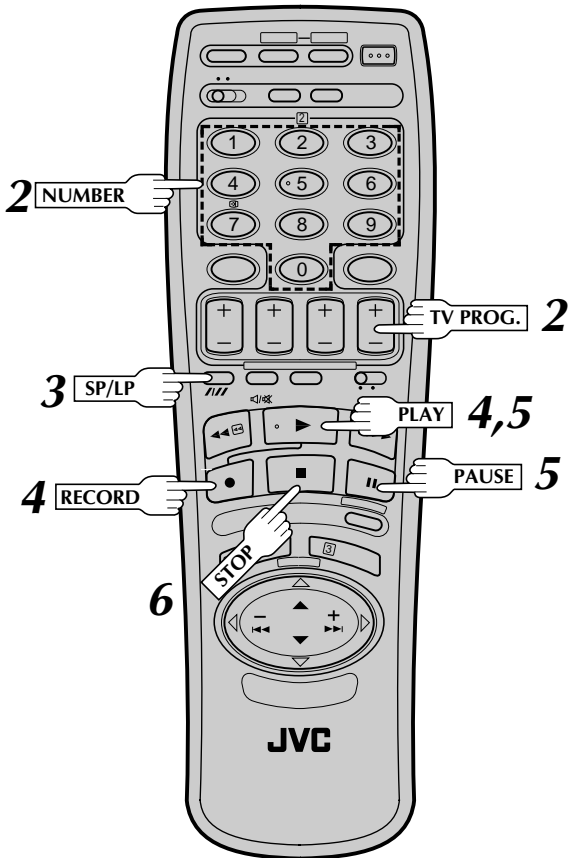
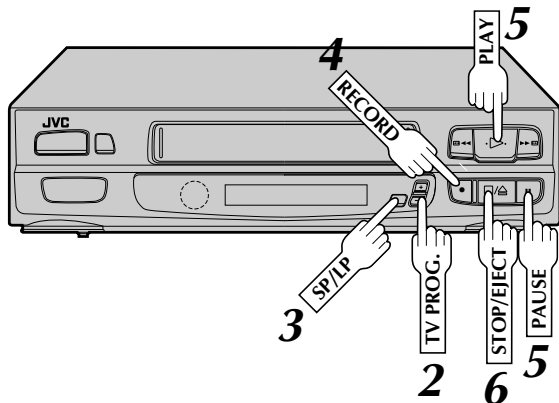

## 1 LOAD A CASSETTE

Insert a cassette with the record safety tab intact.

- The counter is reset to 0:00:00 and the recorder power comes on automatically.

## 2 CHOOSE A PROGRAMME

Press **TV PROG.** +/- or the **NUMBER** keys to select the preset you wish to record. The name of the station appears in the recorder's display panel for 5 seconds, followed by the preset position number. (Only stations that appear in the Confirmation display will be displayed.)

## 3 SET TAPE SPEED

Press **SP/LP**. Check the SP/LP indicator on the recorder display panel to confirm the selected tape speed.

## 4 START RECORDING

Press and hold **RECORD** and **PLAY** on the remote control, or press **RECORD** on the recorder.

## 5 PAUSE/RESUME RECORDING

Press **PAUSE**. Press **PLAY** to resume recording.

## 6 STOP RECORDING

Press **STOP** on the remote control or **STOP/EJECT** on the recorder. Then press **STOP/EJECT** to remove the cassette.

### Accidental erasure prevention

- To prevent accidental recording on a recorded cassette, remove its safety tab. To record on it later, cover the hole with adhesive tape.

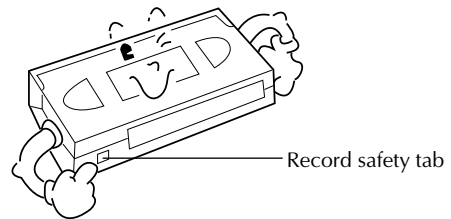

# Recording Features

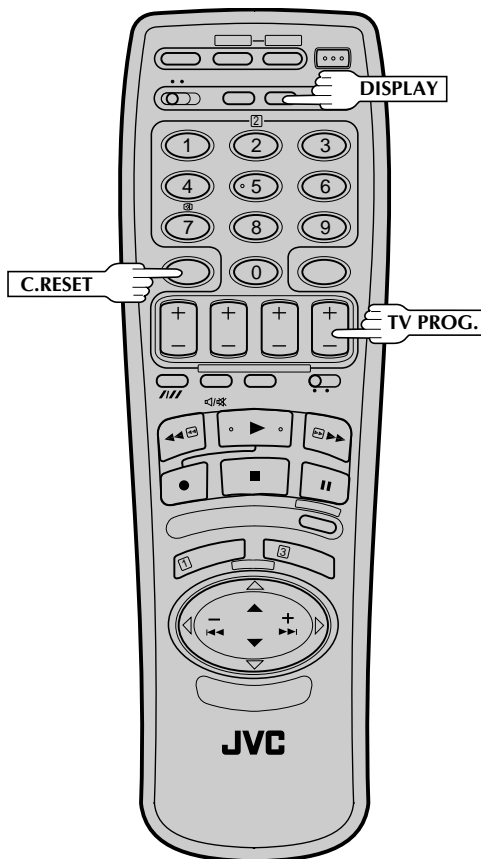
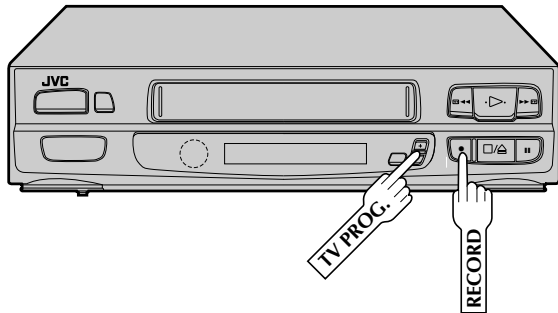

## Record One Programme While Watching Another

### 1 SELECT PRESET TO WATCH

Once recording is in progress, all you need to do is to set the preset controls on the TV for the station you wish to view.

- The programme selected with the TV's preset controls appears on the TV screen while the one selected with the **TV PROG.** button is recorded on the tape.

## Elapsed Recording Time Indication

You can check the exact time of a recording.

### 1 SET COUNTER DISPLAY

Press **DISPLAY** so that a counter reading appears on the display panel.

- If you press **DISPLAY** again, clock display appears.

### 2 RESET COUNTER

Press **C. RESET** before starting recording or playback.

- The counter is reset to "0:00:00" and shows the exact elapsed time as the tape runs.

## Instant Timer Recording (ITR)

This easy method lets you record for from 30 minutes to 6 hours (selectable in 30-min. increments), and shuts the recorder off after recording is finished.

### 1 START RECORDING

Press **RECORD** on the recorder.

### 2 ENGAGE ITR MODE

Press **RECORD** again. ITR blinks and 0:30 appears on the front display panel.

### 3 SET RECORDING DURATION

If you want to record for more than 30 minutes, press **RECORD** to extend the time. Each press extends recording time by 30 minutes.

## NOTE:

You can only perform ITR using the **RECORD** button on the recorder's front panel.



# Information On Video Plus+

With Video Plus+, timer programming is greatly simplified because each TV programme has a corresponding code number which your recorder is able to recognize.

**NOTE:**

"Guide Channel" refers to the assigned TV station numbers, according to broadcast area, for Video Plus+ timer recording.

**IMPORTANT**

Perform the following procedure after the channel setting steps on pages 7 and 26 – 29, and after the Clock Set procedure on page 8.

After setting the Guide Channel, the station names and preset positions may be incorrect if you stored or skipped channels. In this case, re-perform Guide Channel setting.

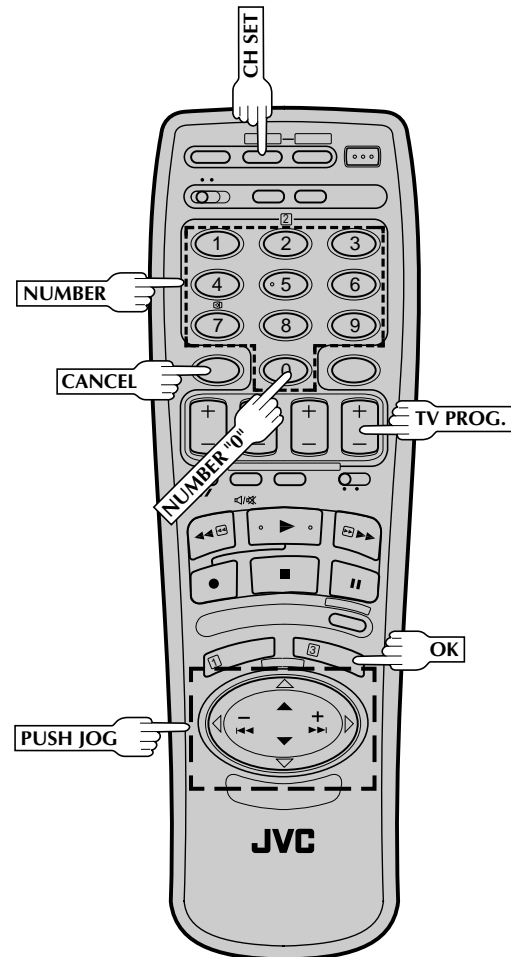
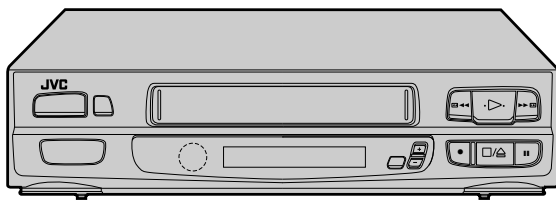

## Guide Channel Set

### 1 MAKE LIST OF STORED PRESET POSITIONS AND STATION NAMES

(Ex.)

Preset position	Station name
1	BBC 1
2	BBC 2
3	ITV
4	CH 4

### 2 ACCESS CH. SET DISPLAY

Press and hold **CH SET** for over 2 seconds. "AUTO" appears on the front display panel.

### 3 ACCESS GUIDE CHANNEL SET DISPLAY

Press **PUSH JOG** to select "GUID", then press **OK**. The Guide Channel Set display appears.

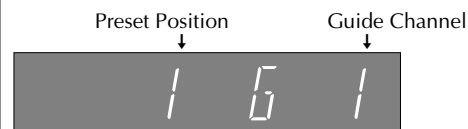

CONTINUED ON NEXT PAGE.

4

**ENTER PLUSCODE NUMBER**

Press **OK**, and "-" appears. Then, using the **NUMBER** keys, input the PlusCode (found in most TV listings) of a program scheduled to be broadcast on each station on the list from step 1, starting at the top. If you enter the wrong number, press **CANCEL** and input the correct number.



5

**ENTER PRESET POSITION NUMBER**

Press **OK** and Preset Position number begins blinking.

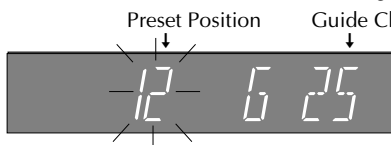

*If the blinking Preset Position number agrees with the Preset position . . .*

. . . press **OK**.

*If the numbers do not agree . . .*

. . . input the Preset position using **PUSH JOG** or the **NUMBER** keys, then press **OK**.

- If you input the PlusCode number of a program that has already aired, "Err"(or) appears on the front display for a few seconds. Input the correct PlusCode number.
- Repeat steps 4 and 5 as necessary.

6

**RETURN TO NORMAL DISPLAY**

Press **CH SET** and selection is complete.

If you already know the Guide Channel number for a station . . .

- 1- After step 3, press **PUSH JOG**.
  - The Guide Channel number begins blinking.
- 2- Enter the Guide Channel number using the **NUMBER** keys or **PUSH JOG**, then press **PUSH JOG**.
  - The Preset Position number begins blinking.
- 3- Enter the preset position using the **NUMBER** keys or **PUSH JOG**, then press **OK**.
  - Repeat 1 and 3 as necessary.
- 4- Press **CH SET**.

**NOTES:**

- If you own a satellite receiver, connect it to the AV2 IN connector on the back of the recorder. Then, in step 5 above, set the input mode to "AU2" by pressing **NUMBER** key "0" or **TV PROG.** +/-.
- If you're receiving broadcasts via a cable box through preset "5" (example) on your recorder, select the preset position 5 in step 5.
- After selecting the programme you wish to record from your cable system or satellite receiver, set the system's timer — if your cable or satellite receiver does not have a timer, leave it switched on.

THE SATELLITE RECEIVER IS SHOWN CONNECTED TO THE "AV2 IN" (SCART) CONNECTOR AND THE CABLE SYSTEM CONNECTED VIA THE AERIAL SOCKET AND TUNED TO, FOR EXAMPLE, PRESET POSITION 5 ON YOUR TV.

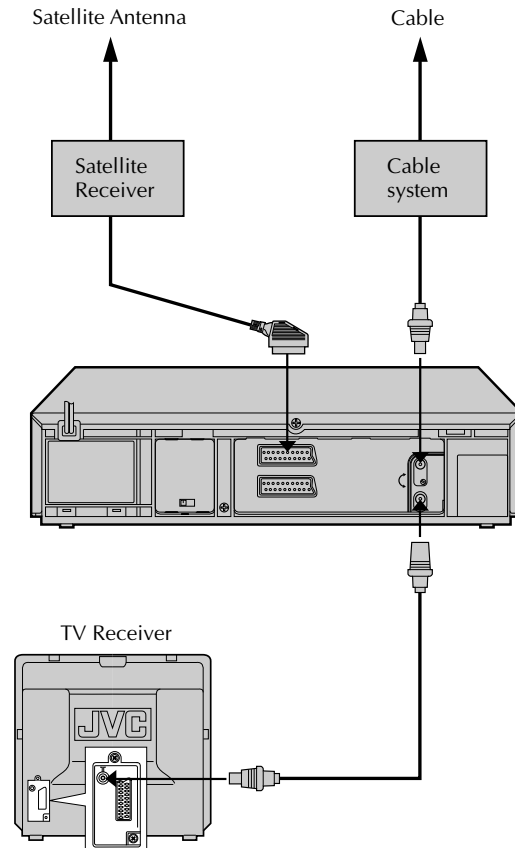

# Video Plus+ Timer Recording

Before performing Video Plus+ Timer Recording, be sure to read "Information on Video Plus+" on page 17.

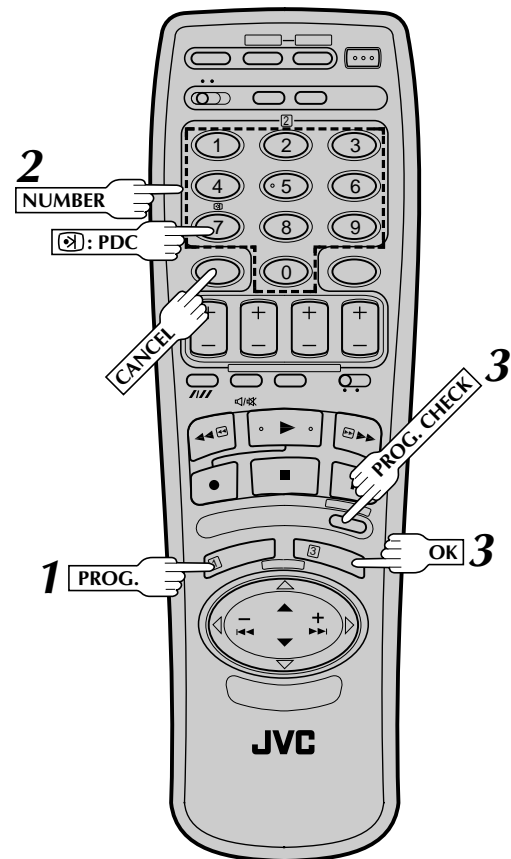
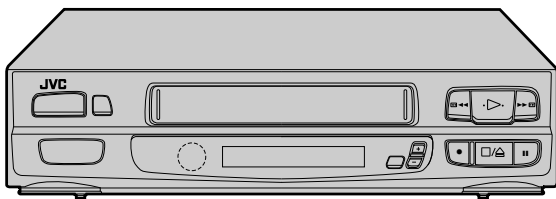

Before performing the following steps, insert a cassette with the safety tab in place. The recorder power will come on automatically.

## ACCESS TIMER PROGRAMMING DISPLAY

1

Press **PROG.**



## ENTER PLUSCODE NUMBER

2

Press the **NUMBER** keys to enter the PlusCode number of a programme you wish to record.



- If you make a mistake, press **CANCEL** and then input the correct number.

## ACCESS PROGRAMME DISPLAY

3

Press **OK**, and the Programme display appears.



Press **PROG. CHECK** to confirm the date and the Preset position.

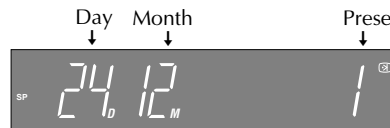

- If the number you entered is invalid, "Err"(or) appears. Press **CANCEL** and input a valid PlusCode number.
- If you're not receiving PDC (Programme Delivery Control), press **NUMBER** key "7" to set to "OFF" so that the indicator disappears. (pg. 23).

CONTINUED ON NEXT PAGE.

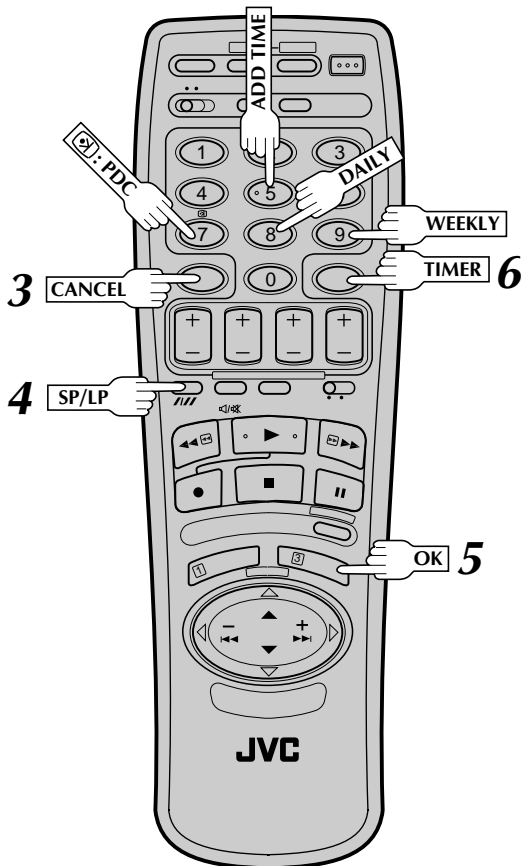
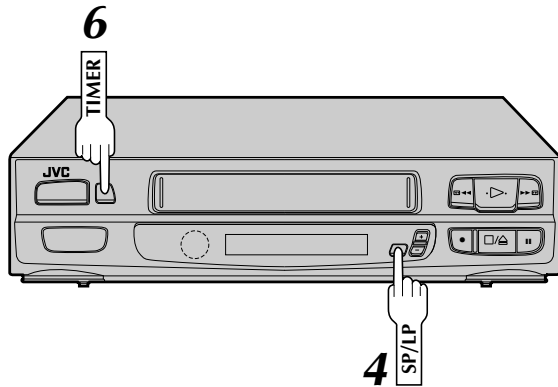

## 4 SET TAPE SPEED

Press **SP/LP** (//) to set the tape speed.

## 5 RETURN TO NORMAL DISPLAY

Press **OK**.

- Repeat steps 1 – 5 for each additional programme.

## 6 ENGAGE RECORDER'S TIMER MODE

Press **TIMER**.

### NOTE:

For safety, your recorder disables all other functions while in the Timer mode. If you want to use the recorder but its Timer mode is engaged, press **TIMER** and all other functions are operable. To re-engage the timer, press **TIMER**.

To Delay The Stop Time . . .

. . . press **ADD TIME** (NUMBER key "5") after pressing **OK** in step 3. Each time you press, the Stop time is delayed by 5 minutes (meaning that 5 minutes of recording time is added). You can easily compensate for anticipated programme schedule delays this way.

To Timer-Record Weekly Or Daily Serials . . .

. . . after pressing **OK** in step 3, press **WEEKLY** (NUMBER key "9") for weekly serials or **DAILY** (NUMBER key "8") for daily serials (Monday – Friday). "W" or "D" appears on the front display panel.

You can programme this recorder to timer-record as many as 8 programmes. If you try to programme the recorder to record a ninth, "FULL" appears on the front display panel. To record the extra programme, you must first cancel any unnecessary programmes (☞ pg. 23).

### Satellite Receiver Users

To timer-record a satellite broadcast using Video Plus+, perform steps 1 – 6 and, before the selected programme begins, select the appropriate channel on the satellite receiver. Then set the receiver's timer. If your satellite receiver doesn't have a timer, leave the unit's power switched on.

# Regular Timer Programming

Remember, the clock must be set before you can programme the timer (☞ pg. 8).

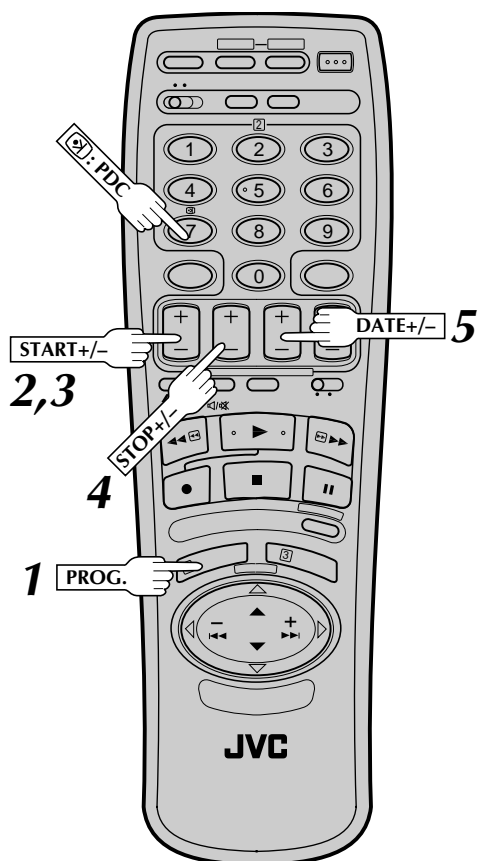
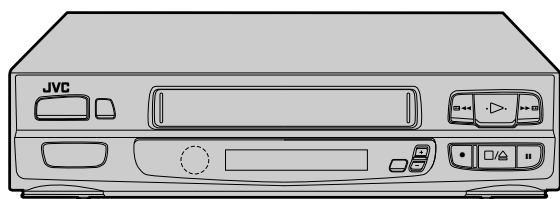

Before performing the following steps, insert a cassette with the safety tab in place. The recorder power will come on automatically.

## 1 ACCESS TIMER PROGRAMMING DISPLAY

Press **PROG.**

## 2 ACCESS PROGRAMME DISPLAY

Press **START +/-**.



- If you're not receiving PDC (Programme Delivery Control), press **NUMBER** key "7" to set to "OFF" so that the indicator disappears (☞ pg. 23).

## 3 ENTER PROGRAMME START TIME

Press **START +/-** to enter the time you want recording to start.



- Press and hold **START +/-** to move in 30-minute increments, or press and release repeatedly to move 1 minute at a time.

## 4 ENTER PROGRAMME STOP TIME

Press **STOP +/-** to enter the time you want recording to stop.

## 5 ENTER PROGRAMME DATE

Press **DATE +/-**. (The current date appears on the front display panel. The date you enter appears in its place.)

CONTINUED ON NEXT PAGE.

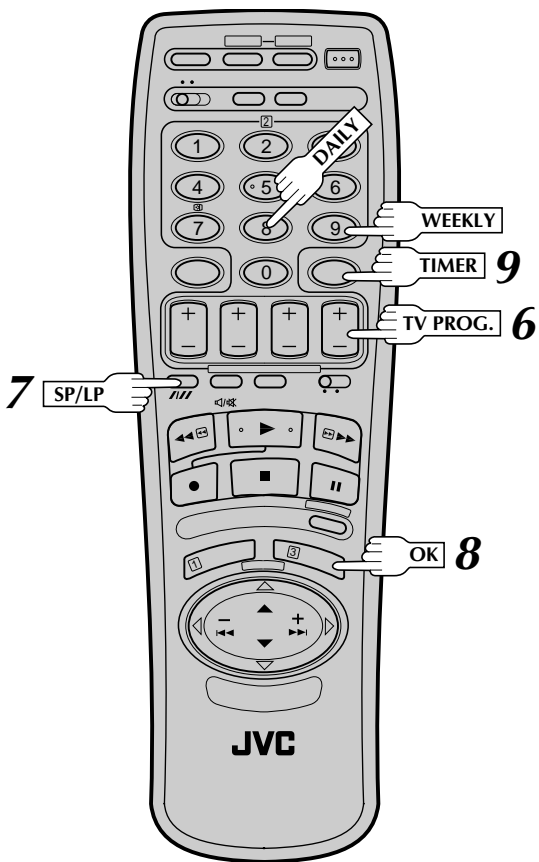
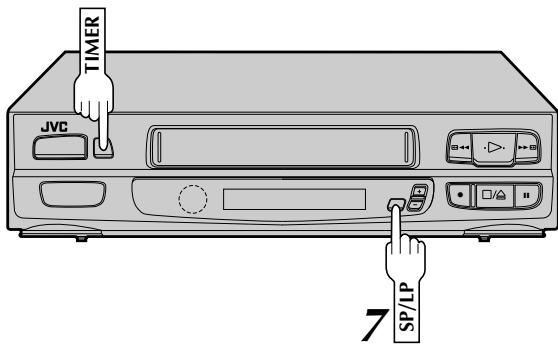

### 6 ENTER PRESET POSITION

Press **TV PROG. +/-**.

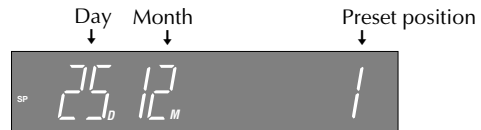

### 7 SET TAPE SPEED

Press **SP/LP (//)** to set the tape speed.

### 8 RETURN TO NORMAL DISPLAY

After confirming all information is correct, press **OK** and the normal display appears.

- Repeat steps 1–8 for each additional programme.

### 9 ENGAGE RECORDER'S TIMER MODE

Press **TIMER**.

To Timer-Record Weekly Or Daily Serials . . .

. . . anytime during steps 2 through 8, press **WEEKLY** (NUMBER key "9") for weekly serials or **DAILY** (NUMBER key "8") for daily serials (Monday – Friday). "W" or "D" appears on the front display panel.

### NOTES:

- For safety, your recorder disables all other functions while in the Timer mode. If you want to use the recorder but its Timer mode is engaged, press **TIMER** and all other functions are operable. To re-engage the timer, press **TIMER**.
- You can programme this recorder to timer-record as many as 8 programmes. If you try to programme the recorder to record a ninth, "FULL" appears on the front display panel. To record the extra programme, you must first cancel any unnecessary programmes (pg. 23).
- To timer-record a satellite broadcast through a satellite receiver connected to the AV2 IN connector on the back of the recorder, in step 6 above, select "AU2" for the preset position by pressing **TV PROG. +/-**. Before the selected programme begins, select the appropriate channel on the satellite receiver, then set the receiver's timer. If your satellite receiver doesn't have a timer, leave the unit's power switched on.

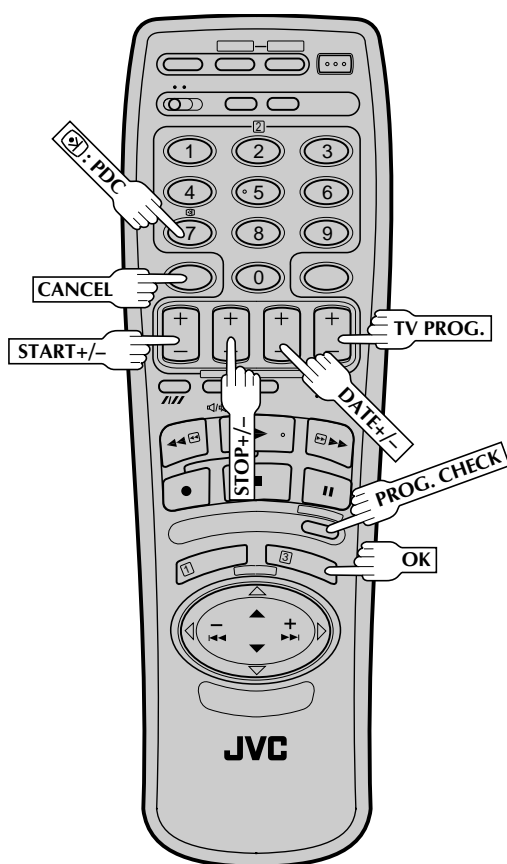
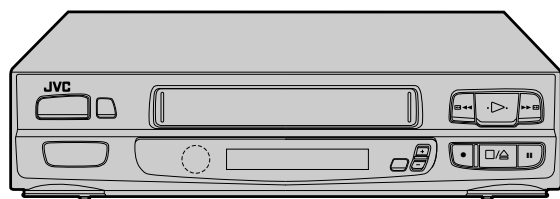

## Check And Cancel Programmes

### ACCESS PROGRAMME DISPLAY

**1** Press **PROG CHECK**. The recording start and stop times appear on the front display panel. Then press **OK** and the date and the preset position appear. Each time you press **PROG CHECK** the next program's information appears.

*If All Information Is Correct . . .*

. . . programming is completed.

*If You Wish To Revise Data . . .*

. . . with the recorder's power turned on, go to step 2.

*If You Wish To Cancel A Program . . .*

. . . with the recorder's power turned on, press **CANCEL**. All information you input is deleted.

### REVISE PROGRAMME INFORMATION

**2** Input the appropriate data using the **START +/-**, **STOP +/-**, **DATE +/-** and **TV PROG.** +/- buttons on the remote control.

## PDC Recording

Now available from some TV stations, PDC (Programme Delivery Control) is a service designed to assure safe, accurate timer recording. With this system, special code signals are transmitted together with the audio/video signals. These code signals control your video recorder and have precedence over advertised times you preset in the timer. This means that your recorder will start and stop recording when the preset TV programmes actually start and end — even if the broadcast time of a preset TV programme is changed.

*To Use PDC Service . . .*

The default setting for PDC is "ON". To cancel PDC, press **PDC** (NUMBER key "7") so that the PDC indicator (PDC) on the display panel disappears during Video Plus+ or regular timer programming.

### NOTES:

- When you manually enter programmes (regular timer programming), set the start time (PDC time) exactly as advertised in the TV listing. A different time than advertised will result in no recording.
- PDC Recording is also possible when a satellite tuner or a cable box is connected to AV2 IN on your recorder.

# Edit To Or From Another Video Recorder

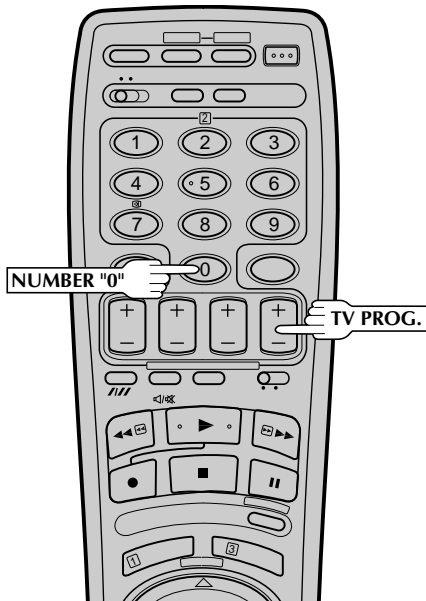

You can use your video recorder as the source player or the recording deck.

## 1 MAKE CONNECTIONS

Connect the player's AUDIO/VIDEO OUT connector to the recorder's AUDIO/VIDEO IN connector.

*When Using Your Video Recorder As The Source Player . . .*

. . . connect its AV1 IN/OUT connector to the recording deck.

*When Using Your Video Recorder As The Recording Deck . . .*

. . . you can use the AV1 IN/OUT or AV2 IN connectors.

## 2 SET RECORDING DECK'S INPUT MODE

Set to AUX. With this video recorder, press **NUMBER** key "0" and/or **TV PROG.** to select depending on the connector being used — "AU 1" for the AV1 IN/OUT connector, or "AU 2" for the AV2 IN connector.

## 3 START SOURCE PLAYER

Engage its Play mode.

## 4 START RECORDING DECK

Engage its Record mode.

### NOTE:

*All necessary cables can be obtained from your dealer.*

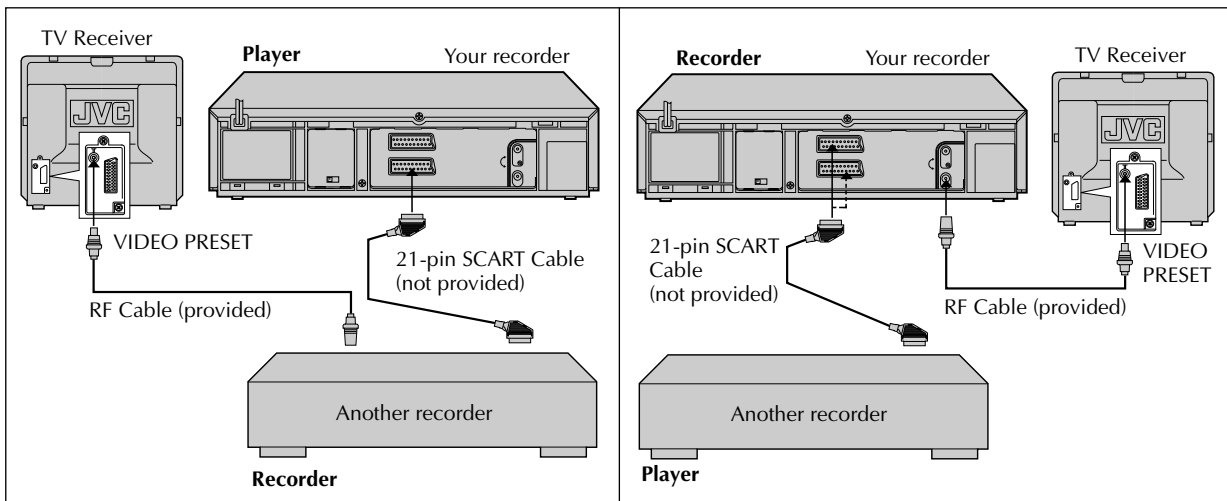



# Edit From A Camcorder

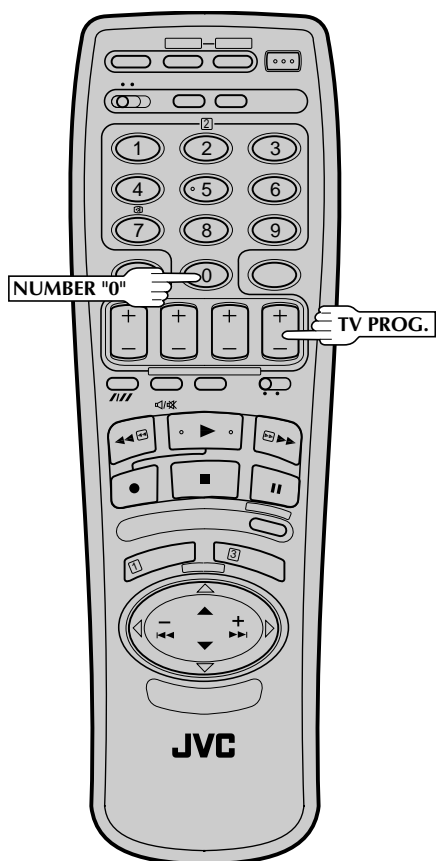

You can use a camcorder as the source player and your video recorder as the recorder.

## 1 MAKE CONNECTIONS

Connect the camcorder's AUDIO/VIDEO OUT connectors to the recorder's AUDIO/VIDEO input connectors.

## 2 SET RECORDER'S INPUT MODE

- If you're using the AV1 IN/OUT connector . . . . . select "AU1" by pressing **NUMBER** key "0" and/or **TV PROG.**
- If you're using the AV2 IN connector . . . . . select "AU2" by pressing **NUMBER** key "0" or **TV PROG.**

## 3 START CAMCORDER

Engage its Play mode.

## 4 START RECORDER

Engage its Record mode.

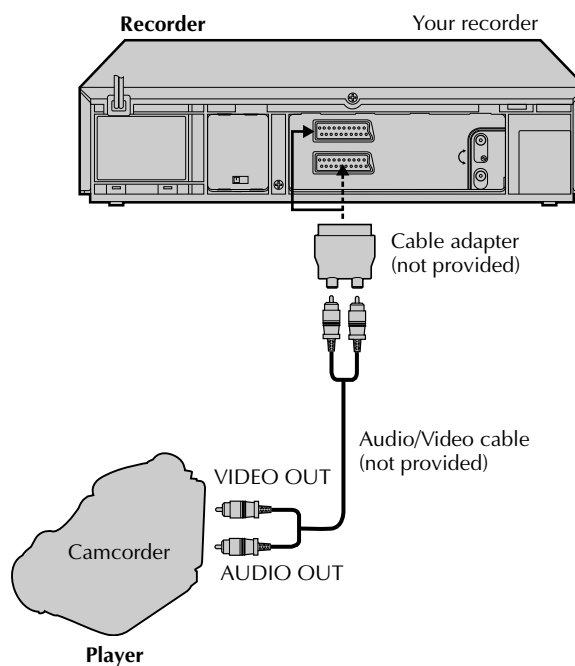

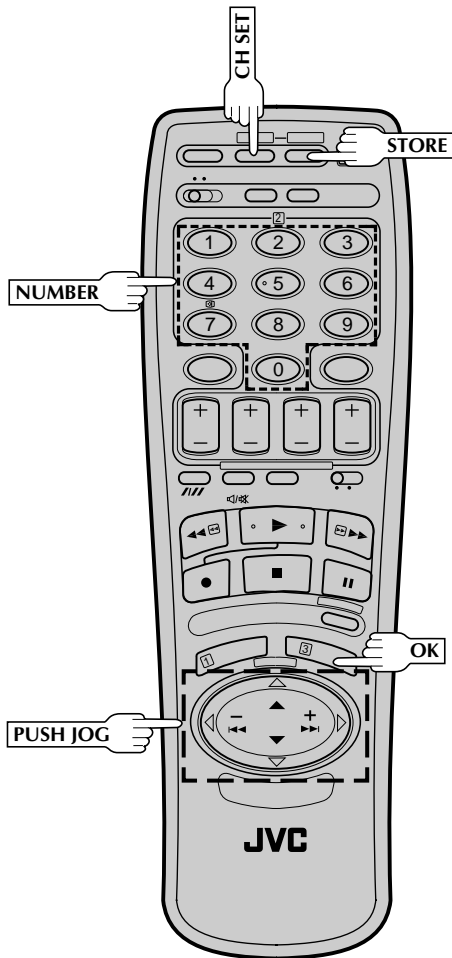
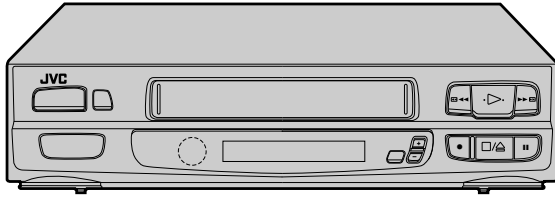

## Storing Channels Manually

Store channels that were not stored during Auto Channel Set.

1

### ACCESS CH. SET DISPLAY

Press and hold **CH SET** for more than 2 seconds. "AUTO" appears on the front display panel.

2

### ACCESS CONFIRMATION DISPLAY

Press **PUSH JOG**  $\Delta \nabla$  to select "MANU"(AL), then press **OK**. The Confirmation display appears.

3

### SELECT POSITION

Press **PUSH JOG**  $\Delta \nabla$  is until an open position in which you want to store a channel is displayed, then press **OK**. The Manual Ch. Set display appears.

Preset Position      Channel

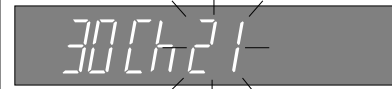

4

### INPUT CHANNEL

The channel number "21" appears blinking. Press the **NUMBER** keys to input the channel number you want to store.

- For fine tuning adjustment, press **PUSH JOG**  $\triangleleft \triangleright$  until the channel number blinks, then press **PUSH JOG**  $\Delta \nabla$ . While tuning, "-", "—" or "—" appears.

5

### ENTER NEW CHANNEL INFORMATION

Press **OK** or **STORE**, and the Confirmation display appears.

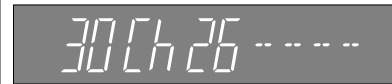

- Repeat steps 3 through 5 as necessary.

6

### RETURN TO NORMAL DISPLAY

Press **CH SET**.

- To input the station name, see page 28.
- To change positions, see "Change Station Preset Position" (pg. 27).

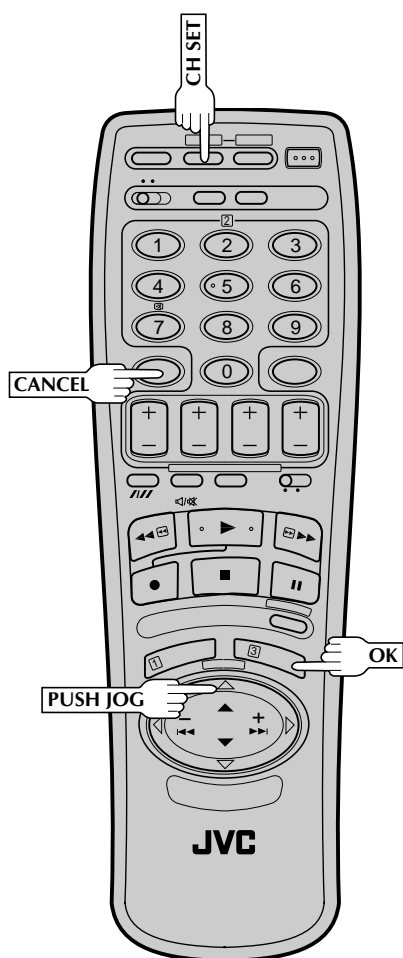
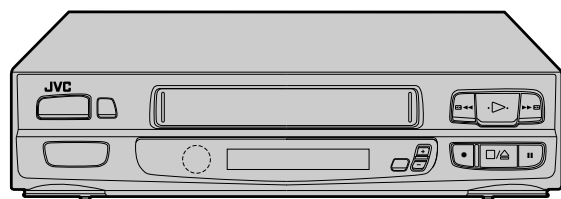

Perform steps 1 and 2 on page 26 to access the Confirmation display before continuing.

## Delete A Channel

- 1 SELECT STATION**  
Press **PUSH JOG**  $\Delta \nabla$  until the station you want to delete is displayed.
- 2 DELETE STATION**  
Press **CANCEL**.
  - The stations following the cancelled station all move up one position.
  - Repeat steps 1 and 2 as necessary.
- 3 RETURN TO NORMAL DISPLAY**  
Press **CH SET**.

## Change Station Preset Position

- 1 SELECT ITEM**  
Press **PUSH JOG**  $\Delta \nabla$  until the item you want to move is displayed. Then press **OK** and the station name (or "--") and its channel number begin blinking.  

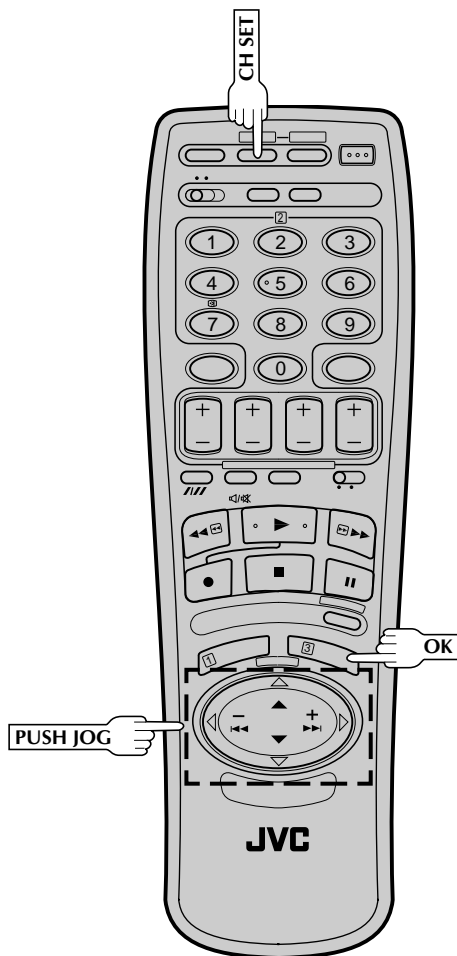
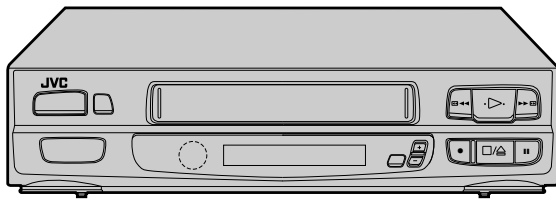
- 2 SELECT NEW POSITION**  
Press **PUSH JOG**  $\Delta \nabla$  to move the station to the new preset position, then press **OK**.  
**Example:** If you moved the station in position 3 to position 7, the stations originally in positions 4–7 each move up one position.  
  - Repeat steps 1 and 2 as necessary.
- 3 RETURN TO NORMAL DISPLAY**  
Press **CH SET**.



Perform steps 1 and 2 on page 26 to access the Confirmation display before continuing.

## Set Stations (A)

1

### SELECT ITEM

Press **PUSH JOG**  $\Delta$ / $\nabla$  until the item you want is displayed. Then press **OK** twice and the station's name (or "--") begins blinking.



2

### SELECT NEW STATION

Press **PUSH JOG**  $\Delta$ / $\nabla$  until the new station's name you want to store begins blinking.

Registered station names (pg. 30) appear as you press **PUSH JOG**  $\Delta$ / $\nabla$ .

3

### SWITCH STATIONS

Press **OK**.

- Repeat steps 1 through 3 as necessary.

4

### RETURN TO NORMAL DISPLAY

Press **CH SET**.

## Set Stations (B)

### NOTE:

First perform step 1 of the above procedure.

2

### SELECT STATION NAME CHARACTER

Press **PUSH JOG**  $\triangleright$  and the first letter of the station name (or "--") begins blinking.

3

### ENTER NEW CHARACTER

Press **PUSH JOG**  $\Delta$ / $\nabla$  to cycle through the characters (A-Z, 0-9, -, \*, +, — (space)) and stop when the desired one is indicated, then press **PUSH JOG**  $\triangleright$  to enter. Enter the remaining characters the same way (maximum of 4).

After entering all characters, press **OK**.

- Repeat steps 1 through 3 as necessary.
- If you make a mistake, press **PUSH JOG**  $\triangleleft$ / $\triangleright$  until the incorrect character begins blinking. Then enter the correct character by pressing **PUSH JOG**  $\Delta$ / $\nabla$ .

4

### RETURN TO NORMAL DISPLAY

Press **CH SET**.

Perform steps 1 and 2 on page 26 to access the Confirmation display before continuing.

## Fine-Tuning Channels Already Stored

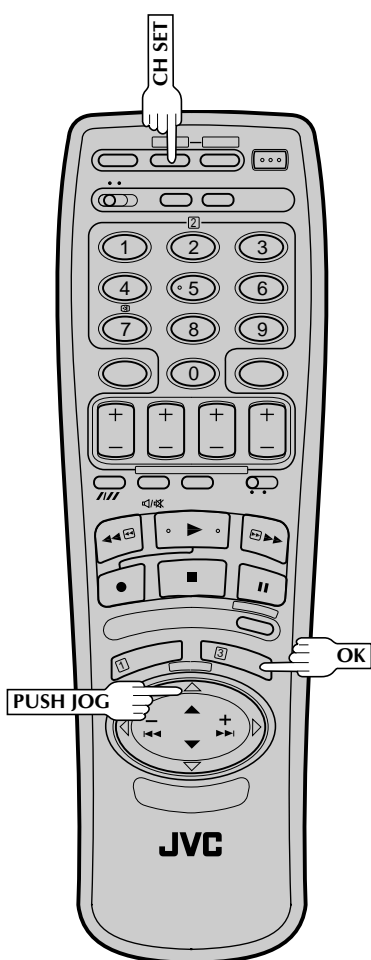
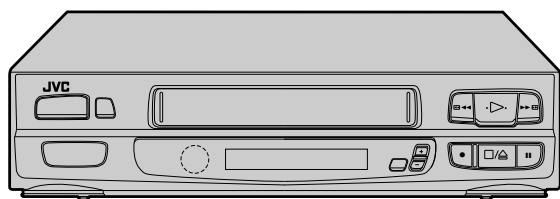

### 1 SELECT CHANNEL TO FINE-TUNE

Press **PUSH JOG**  $\Delta$ / $\nabla$  until the channel you want to tune is displayed.

### 2 ACCESS MANUAL CH. SET DISPLAY

Press **OK** three times. The Manual Ch. Set display appears.



### 3 PERFORM TUNING

Press **PUSH JOG**  $\Delta$ / $\nabla$  until the picture is its clearest. Then press **OK**.

- The Confirmation display appears.
- Repeat steps 1 through 3 as necessary.

### 4 RETURN TO NORMAL DISPLAY

Press **CH SET**.



STATION NAME	ID*
Anglia TV	ANGL
ARD	ARD
ARTE	ARTE
BBC1	BBC1
BBC2	BBC2
Berlin 1	BLN1
Berlin 2	BLN2
Border TV	BORD
Bayern1	BR1
Bayern3	BR3
BRT1	BRT1
BRT2	BRT2
Children Ch	CHLD
Canal +	CH+
CNN	CNN
Channel TV	CHNL
Central TV	CNTR
Channel 4	CH 4
Channel 5	CH 5
DRS	DRS
DR TV	DRTV
DSF	DSF
Euronews	EURN
Euronews	EURO
Eurosports	EURS
France1	FR1
France2	FR2
France3	FR3
Granada TV	GRNA
Grampian TV	GRMP
Hessen1	HR1
Hessen3	HR3
HRT	HRT
HTV	HTV
ITV Network	ITV
Kabelkanal	KABL
London	LNDN
MDR	MDR
MTV	MTV
Nord3	N3
NDR1	NDR1
NDR3	NDR3
NED1	NED1
NED2	NED2
NED3	NED3
Network 2	NET2
NRK	NRK
N-TV	N-TV
Offener Kanal	OKAN
ORF1	ORF1
ORF2	ORF2
ORF3	ORF3
OWL 3	OWL3
Premiere	PRM1
PR07	PR07
RAI1	RAI1
RAI2	RAI2
RAI3	RAI3
RB1	RB1
RB3	RB3
Rikisutvarpid-S	RKPS
RTBF 1	RTB1
RTBF 2	RTB2

STATION NAME	ID*
RTE 1	RTE1
RTL	RTL
RTL 2	RTL2
RTP	RTP
SAT	
SAT 1	SAT1
Scottish TV	SCOT
SC4	SC4
SDR	SDR
SDR1	SDR1
SFB1	SFB1
SFB3	SFB3
SKY	
Sky One	SKY1
Sky Net	SKYN
Sport	SPRT
SR 1	SR1
Super RTL	SRTL
STV Test	STVT
STV 1	STV1
STV 2	STV2
Suedwest3	SW3
SWF 1	SWF1
Schweiz4	SWZ4
TYNE TEES	TEES
Text	TEXT
TF1	TF1
TNT int	TNT
TRT int	TRT
TSI	TSI
TSR	TSR
TSW	TSW
TVE	TVE
TV Polonia	TVPA
TVP 1	TVP1
TVP 2	TVP2
TVS	TVS
TV2	TV2
TV5	TV5
Tele Zurich	TZUR
Ulster TV	ULST
Veronica	VERN
VIVA	VIVA
VIVA2	VIV2
VOX	VOX
VTM	VTM
VT4	VT4
West1	WDR1
West3	WDR3
YLE 1	YLE1
YLE 2	YLE2
Yorkshire TV	YORK
ZDF	ZDF
Zurich 1	ZUR1
3SAT	3SAT

\* The ID designator appears on your recorder's front display panel.



# TV STATION CHANNEL NUMBER GUIDE (U.K. ONLY)

Only the main stations are listed. There are in addition many relay stations, and full lists are available from BBC and ITC.

	BBC1	BBC2	ITV	CH4
<b>London &amp; South-East</b>				
Bluebell Hill .....	40	46	43	65
Crystal Palace .....	26	33	23	30
Dover .....	50	56	66	53
Heathfield .....	49	52	64	67
Oxford .....	57	63	60	53

<b>South-West</b>				
Beacon Hill .....	57	63	60	53
Caradon Hill .....	22	28	25	32
Huntshaw Cross .....	55	62	59	65
Redruth .....	51	44	41	47
Stockland Hill .....	33	26	23	29
Channel Islands				
Fremont Point .....	51	44	41	47

<b>South</b>				
Hannington .....	39	45	42	66
Midhurst .....	61	55	58	68
Rowridge .....	31	24	27	21

<b>West</b>				
Mendip .....	58	64	61	54

<b>East</b>				
Sandy Heath .....	31	27	24	21
Sudbury .....	51	44	41	47
Tacolneston .....	62	55	59	65

<b>Midlands</b>				
Ridge Hill .....	22	28	25	32
Sutton Coldfield .....	46	40	43	50
The Wrekin .....	26	33	23	29
Waltham .....	58	64	61	54

<b>North</b>				
Belmont .....	22	28	25	32
Emley Moor .....	44	51	47	41

<b>North-West</b>				
Caldbeck .....	30	34	28	32
Winter Hill .....	55	62	59	65

<b>North-East</b>				
Bilsdale West Moor .....	33	26	29	23
Chatton .....	39	45	49	42
Pontop Pike .....	58	64	61	54

<b>Scotland</b>				
Angus .....	57	63	60	53
Black Hill .....	40	46	43	50
Sandale .....	22	—	—	—
Caldbeck .....	—	34	28	32
Creigkelly .....	31	27	24	21
Darvel .....	33	26	23	29
Durris .....	22	28	25	32
Eitshal .....	33	26	23	29
Keelylang Hill .....	40	46	43	50
Knock More .....	33	26	23	29
Rosemarkie .....	39	45	49	42
Rumster Forest .....	31	27	24	21
Selkirk .....	55	62	59	65

<b>Wales</b>				
Blaenplwyf .....	31	27	24	21
Carmel .....	57	63	60	53
Llanddona .....	57	63	60	53
Moel-y-Parc .....	52	45	49	42
Presely .....	46	40	43	50
Wenvoe .....	44	51	41	47

<b>Northern Ireland</b>				
Brougher Mountain .....	22	28	25	32
Divis .....	31	27	24	21
Limavady .....	55	62	59	65

Before requesting service for a problem, use this chart and see if you can repair the trouble yourself. Small problems are often easily corrected, and this can save you the trouble of sending your video recorder off for repair.

<b>POWER</b>		
<b>SYMPTOM</b>	<b>POSSIBLE CAUSE</b>	<b>CORRECTIVE ACTION</b>
1. No power is applied to the recorder.	<ul style="list-style-type: none"> <li>The mains power cord is disconnected.</li> </ul>	Connect the mains power cord.
2. The clock is functioning properly, but the recorder cannot be powered.	<ul style="list-style-type: none"> <li>"⊖" is displayed on the display panel.</li> </ul>	Press the <b>TIMER</b> button to turn the "⊖" indicator off.
<b>TAPE TRANSPORT</b>		
<b>SYMPTOM</b>	<b>POSSIBLE CAUSE</b>	<b>CORRECTIVE ACTION</b>
1. The tape does not run during recording.	<ul style="list-style-type: none"> <li>"□□" is displayed on the display panel.</li> </ul>	Press <b>PLAY</b> to turn the "□□" indicator off.
2. The tape will not rewind or fast-forward.	<ul style="list-style-type: none"> <li>The tape is already fully rewound or fast-forwarded.</li> </ul>	Check the cassette.
<b>PLAYBACK</b>		
<b>SYMPTOM</b>	<b>POSSIBLE CAUSE</b>	<b>CORRECTIVE ACTION</b>
1. The playback picture does not appear while the tape is running.	<ul style="list-style-type: none"> <li>If you're using the RF OUT connection . . . . . the TV receiver's preset selector is set to the wrong video preset. . . . . the RF switch has been mistakenly set to OFF.</li> <li>If you're using the AV connection, the TV receiver is not set to the AV mode.</li> </ul>	<p>If you are using the RF OUT connection . . . . . set the TV receiver to the RF converter preset (UHF 36). (☞ pg. 5)</p> <p>. . . turn the RF switch back to ON. (☞ pg. 5)</p> <p>If you are using the AV connection, set the TV to its AV mode.</p>
2. Noise appears during visual search.	<ul style="list-style-type: none"> <li>This is normal.</li> </ul>	
3. Noise appears during normal playback.	<ul style="list-style-type: none"> <li>The automatic tracking mode is engaged.</li> </ul>	Try manual tracking. (☞ pg. 12)
4. Noise appears during slow-motion playback.	<ul style="list-style-type: none"> <li>The automatic tracking mode is engaged.</li> </ul>	Try manual tracking. (☞ pg. 12)
5. Noise appears during still playback.		Press <b>PAUSE</b> a few times to remove the noise bars from the screen.
6. The playback picture is blurred or interrupted while TV broadcasts are clear.	<ul style="list-style-type: none"> <li>The video heads may be dirty.</li> </ul>	Consult your JVC dealer.
<b>RECORDING</b>		
<b>SYMPTOM</b>	<b>POSSIBLE CAUSE</b>	<b>CORRECTIVE ACTION</b>
1. Recording cannot be started.	<ul style="list-style-type: none"> <li>There is no cassette loaded, or the cassette loaded has had its Record Safety tab removed.</li> </ul>	Insert a cassette, or using adhesive tape, reseal the slot where the tab was removed.
2. TV broadcasts cannot be recorded.	<ul style="list-style-type: none"> <li>"AU" has been selected as the input mode.</li> </ul>	Set to the desired preset.
3. Tape-to-tape editing is not possible.	<ul style="list-style-type: none"> <li>The source (another video recorder, camcorder) has not been properly connected.</li> <li>All necessary power switches have not been turned on.</li> <li>The input mode is not correct.</li> </ul>	<p>Confirm that the source is properly connected.</p> <p>Confirm that all units' power switches are turned on.</p> <p>Set the input mode to "AU".</p>
4. Camcorder recording is not possible.	<ul style="list-style-type: none"> <li>The camcorder has not been properly connected.</li> <li>The input mode is not correct.</li> </ul>	<p>Confirm that the camcorder is properly connected.</p> <p>Set the input mode to "AU".</p>



## TIMER RECORDING

SYMPTOM	POSSIBLE CAUSE	CORRECTIVE ACTION
1. Timer recording won't work.	<ul style="list-style-type: none"> <li>• The clock and/or the timer have been set incorrectly.</li> <li>• The timer is not engaged.</li> </ul>	Re-perform the clock and/or timer settings. Press <b>TIMER</b> and confirm that "⊖" is displayed on the display panel.
2. "⊖" and "⊞" on the display panel won't stop blinking.	<ul style="list-style-type: none"> <li>• The timer is engaged but there's no cassette loaded.</li> </ul>	Load a cassette with the Record Safety tab intact, or cover the hole using adhesive tape.
3. The cassette is automatically ejected, and "⊖" and "⊞" on the display panel won't stop blinking.	<ul style="list-style-type: none"> <li>• The loaded cassette has had its Record Safety tab removed.</li> </ul>	Remove the cassette and cover the hole with adhesive tape, or insert a cassette with the Record Safety tab intact.
4. "⊖" blinks for 10 seconds and the Timer mode is disengaged.	<ul style="list-style-type: none"> <li>• <b>TIMER</b> has been pressed when there are no programs in memory, or the timer record information has been programmed incorrectly.</li> </ul>	Check the programmed data and re-program as necessary, then press <b>TIMER</b> again.
5. The cassette is automatically ejected, the power shuts off and "⊖" and "⊞" won't stop blinking.	<ul style="list-style-type: none"> <li>• The end of the tape was reached during timer recording.</li> </ul>	The programme may not have been recorded in its entirety. Next time make sure you have enough time on the tape to record the entire programme.
6. Video Plus+ does not timer-record properly.	<ul style="list-style-type: none"> <li>• The recorder's preset positions have been set incorrectly.</li> </ul>	Refer to "Guide Channel Set" and re-perform the procedure (Ⓞ pg. 17).

## OTHER PROBLEMS

SYMPTOM	POSSIBLE CAUSE	CORRECTIVE ACTION
1. Whistling or howling is heard from the TV during camcorder recording.	<ul style="list-style-type: none"> <li>• The camcorder's microphone is too close to the TV.</li> <li>• The TV's volume is too high.</li> </ul>	Position the camcorder so its microphone is away from the TV. Turn the TV's volume down.
2. When scanning presets, some of them are skipped over.	<ul style="list-style-type: none"> <li>• Those presets have been designated to be skipped.</li> </ul>	If you need the skipped presets, restore them (Ⓞ pg. 26).
3. The preset cannot be changed.	<ul style="list-style-type: none"> <li>• Recording is in progress.</li> </ul>	Press <b>PAUSE</b> to pause the recording, change presets, then press <b>PLAY</b> to resume recording.
4. The remote control won't operate a JVC TV.	<ul style="list-style-type: none"> <li>• The <b>TV/VCR</b> switch is in the wrong position.</li> </ul>	Set the switch to TV.
5. Channel settings that were made manually seem to have changed or disappeared.	<ul style="list-style-type: none"> <li>• After the manual settings were made, Auto Channel Set was performed.</li> </ul>	Perform manual setting again.



**PLAYBACK**

- Q. What happens if the end of the tape is reached during playback or search?**  
A. The tape is automatically rewound to the beginning.  
.....
- Q. Can the video recorder indefinitely remain in the still mode?**  
A. No. It stops automatically after 5 minutes to protect the heads.  
.....
- Q. During search, slow, still and frame-by-frame playback, I can't hear any audio. What's the problem?**  
A. This is normal.  
.....
- Q. When returning from multi-speed search to normal playback, the picture is disturbed. Should I be concerned about this?**  
A. No, it is normal.  
.....
- Q. Noise bars appear during multi-speed search. What's the problem?**  
A. This is normal.  
.....
- Q. Other than preventing further recording, what effect does removing the Record Safety tab have?**  
A. It disables marking of index codes.  
.....
- Q. Sometimes, during Index Search, the video recorder can't find the programme I want to see. Why not?**  
A. There may be index codes too close together.  
.....

**RECORDING**

- Q. When I pause and then resume a recording, the end of the recording before the pause is overlapped by the beginning of the continuation of recording. Why does this happen?**  
A. This is normal. It reduces distortion at the pause and resume points.  
.....
- Q. Can the video recorder indefinitely remain in the Record-Pause mode?**  
A. No. The video recorder shuts off automatically after 5 minutes to protect the heads.  
.....
- Q. What happens if the tape runs out during recording?**  
A. The video recorder automatically rewinds it to the beginning.  
.....

**TIMER RECORDING**

- Q. "REC" and "⊖" remain lit on the display panel. Is there a problem?**  
A. No. This is a normal condition for a timer recording in progress.  
.....
- Q. Can I program the timer while I'm watching a tape or a TV broadcast?**  
A. Yes.  
.....

**ATTENTION:**

This recorder contains microcomputers. External electronic noise or interference could cause malfunctioning. In such cases, switch the recorder off and unplug the mains power cord. Then plug it in again and turn the recorder on. Take out the cassette. After checking the cassette, operate the unit as usual.

## List Of Terms

This guide serves as a quick way to locate frequently used terms. The first page on which the term appears is listed. Most terms appear more than once in the instruction manual.

### A

A/B Code Switch .....	pg. 14
A-Code Signals .....	pg. 14
Aerial .....	pg. 4
Auto Channel Set .....	pg. 7
Auto Clock Set .....	pg. 8
AUX .....	pg. 18
AV .....	pg. 4
AV Connection .....	pg. 4

### B

B-Code Signals .....	pg. 14
----------------------	--------

### C

Cancel .....	pg. 18
Cassette Adapter .....	pg. 10
Clock .....	pg. 8
Clock Set .....	pg. 8
Contents .....	pg. 1
Counter Reset .....	pg. 16

### D

Daily .....	pg. 20
Delete A Channel .....	pg. 27
Display Panel .....	pg. 37

### E

Editing .....	pg. 24
---------------	--------

### F

Fine Tuning .....	pg. 29
Frame-By-Frame Playback .....	pg. 11
Front View .....	pg. 36

### G

Guide Channel .....	pg. 17
---------------------	--------

### H

Head Cleaning .....	pg. 2
High-Speed Search .....	pg. 11

### I

Index Code .....	pg. 13
Index Search .....	pg. 13
Instant ReView .....	pg. 12
Instant Timer Recording (ITR) .....	pg. 16

### J

Just Clock .....	pg. 8
------------------	-------

### L

Load A Cassette .....	pg. 10
-----------------------	--------

### M

Manual Channel Set .....	pg. 26
Manual Clock Set .....	pg. 9
Manual Tracking .....	pg. 12
Moisture Condensation .....	pg. 2

### N

Next-Function Memory .....	pg. 14
NTSC Playback .....	pg. 14

### P

Programme Delivery Control (PDC) .....	pg. 23
Playback .....	pg. 10
PlusCode™ .....	pg. 18
Preset Position .....	pg. 7

### R

Rear View .....	pg. 37
Record Safety Tab .....	pg. 15
Recording .....	pg. 15
Repeat Playback .....	pg. 13
RF Connection .....	pg. 4

### S

Scart Connector .....	pg. 4
Slow Motion .....	pg. 11
Specifications .....	back cover
Still Picture .....	pg. 11

### T

Tape Speed .....	pg. 15
Timer Programming .....	pg. 21
Timer Recording .....	pg. 17
Tracking .....	pg. 12
Tuner .....	pg. 7

### V

Variable-Speed Search .....	pg. 11
Video Plus+ .....	pg. 17

### W

Weekly .....	pg. 20
--------------	--------

## FRONT VIEW

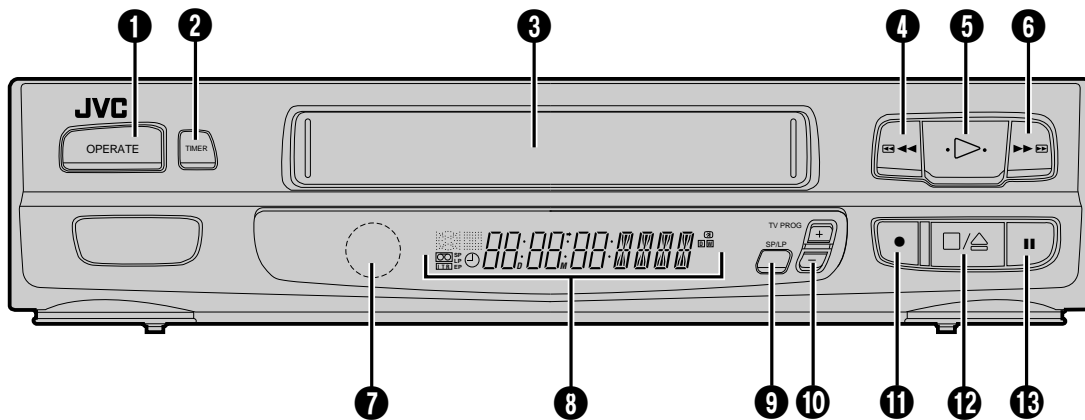

- ❶ **OPERATE Button** turns recorder on/off (loading a cassette also turns power on). ☞ pg. 5
- ❷ **TIMER Button** engages timer standby mode. ☞ pg. 20
- ❸ **Cassette Loading Slot** is where cassette is inserted; door closes, "cassette loaded" indicator lights up on front display panel.
- ❹ **Rewind [REW] Button** rewinds tape; initiates high-speed reverse search. ☞ pg. 10
- ❺ **PLAY Button** plays back tape; cancels Pause, Still, Slow, Search modes. ☞ pg. 10
- ❻ **Fast Forward [FF] Button** fast-forwards tape; initiates high-speed forward search. ☞ pg. 10
- ❼ **Infrared Beam Receiving Window** is where remote control should be aimed when in use.
- ❽ **Display Panel** provides clear view of various displays and indicators. ☞ pg. 37
- ❾ **SP/LP Button** selects tape speed. ☞ pg. 15
- ❿ **TV PROG. +/- Buttons** select preset. ☞ pg. 15
- ⓫ **RECORD Button** starts regular recording (press once) ☞ pg. 15, Instant Timer Recording (press twice); sets duration of ITR. ☞ pg. 16
- ⓬ **STOP/EJECT Button** stops tape; ejects tape during Stop mode. ☞ pg. 10
- ⓭ **PAUSE Button** stops tape temporarily during recording. ☞ pg. 15; stops tape temporarily during playback; plays back frame by frame with each additional press. ☞ pg. 11

## REAR VIEW

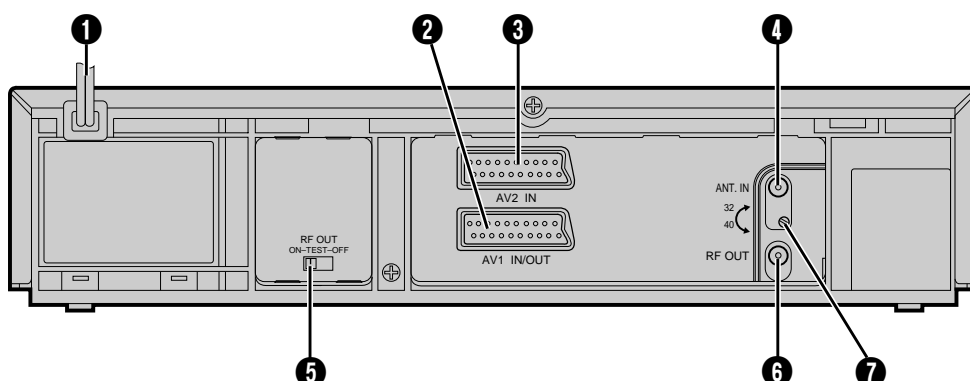

- ❶ **Mains Power Cord** supplies power to recorder. ☞ pg. 4
- ❷ **AV1 IN/OUT SCART Connector** enables AV connection to TV or second recorder; input recordable when "AU 1" selected. ☞ pg. 4
- ❸ **AV2 IN Connector** enables connection of satellite receiver or second recorder; input recordable when "AU 2" selected. ☞ pg. 6
- ❹ **ANT. IN Connector** enables connection of aerial. ☞ pg. 4
- ❺ **RF OUT Switch** enables operation via RF connection or AV connection; activates test pattern when tuning TV receiver for video preset. ☞ pg. 5
- ❻ **RF OUT Connector** enables connection to aerial terminal of TV receiver. ☞ pg. 4
- ❼ **RF Output Channel Adjustment Screw** enables adjustment of output channel if UHF channel 36 is used in your area. ☞ pg. 5

## DISPLAY PANEL

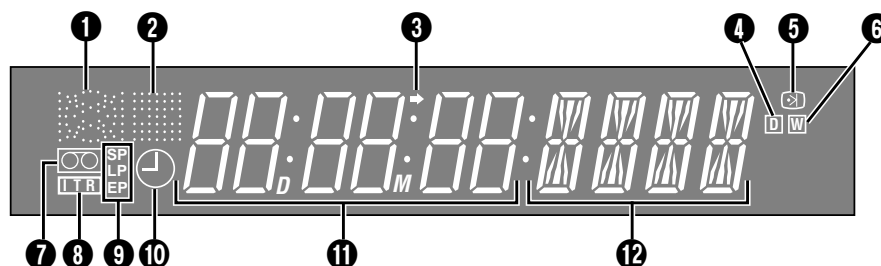

### ❶ and ❷ Symbolic Mode Indicators

PLAY:	▶	REVERSE PLAY:	◀
FF:	⏩	STILL: FORWARD SLOW:	▶ █
REW:	◀	STILL: REVERSE SLOW:	◀ █
FF VARIABLE SHUTTLE SEARCH:	▶ ⏩	RECORD:	○
REW VARIABLE SHUTTLE SEARCH:	◀ ⏪	RECORD PAUSE:	○ █

- ❸ **Start Time/Stop Time Indicator** separates Start Time and Stop Time of timer recording on Display Panel. ☞ pg. 19
- ❹ **"DAILY" Program Mark** lights when recorder has been programmed to record daily serial. ☞ pg. 20
- ❺ **PDC Indicator** lights when PDC has been engaged for timer recording. ☞ pg. 23
- ❻ **"WEEKLY" Program Mark** lights when recorder has been programmed to record weekly serial. ☞ pg. 20

- ❼ **"Cassette Loaded" Mark** lights once a cassette is inserted; remains lit until cassette ejected or power turned off.
- ❽ **Instant Timer Recording Indicator** lights when ITR initiated; remains lit until ITR finishes. ☞ pg. 16
- ❾ **Tape Speed Indicators** display mode of recording or playback; light when recorder turns on. ☞ pg. 15
- ❿ **"Timer" Indicator** lights when TIMER has been pressed to engage Timer mode. ☞ pg. 20
- ⓫ **Counter** shows time elapsed since playback or recording began.  
**Clock Display** shows current time. ☞ pg. 8  
\* Counter and Clock Display appear alternately when **DISPLAY** is pressed.
- ⓬ **Channel Display** shows station name being received and its preset position.  
**Mode** shows external input mode selected.

## REMOTE CONTROL

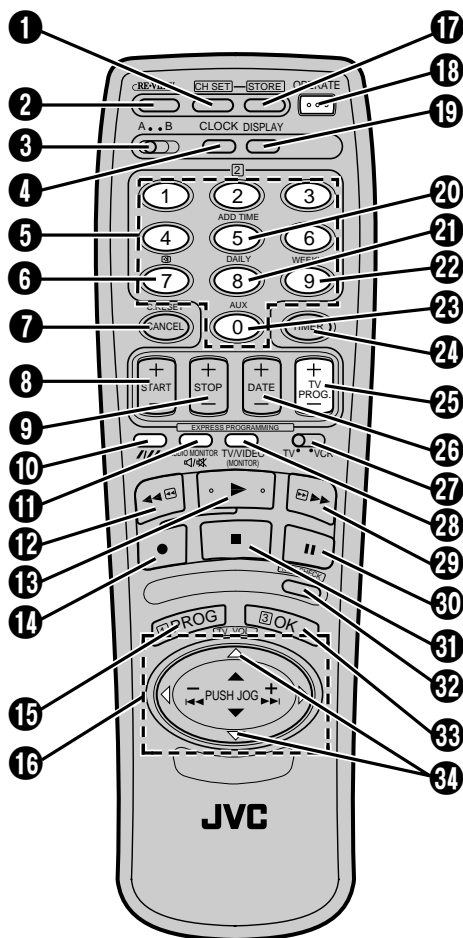

Buttons shown in white (□) can also be used to operate JVC TVs (☞ pg. 39).

- ❶ **CH SET Button** accesses Ch. Set display; closes Confirmation display. ☞ pg. 7
- ❷ **REVIEW Button** — "reviews" timer-recorded programme. ☞ pg. 12
- ❸ **A/B CODE Switch** enables setting of recorder to respond to A- or B-code command signals. ☞ pg. 14
- ❹ **CLOCK Button** accesses Clock Set display. ☞ pg. 8
- ❺ **NUMBER Keys** are used in channel selection ☞ pg. 15, timer programming ☞ pg. 19, external source recording. ☞ pg. 24
- ❻ **[PDC] Button** enables/disables PDC recording. ☞ pg. 23
- ❼ **CANCEL Button** erases previously entered data. ☞ pg. 18  
**C.RESET Button** resets counter to 0:00:00. ☞ pg. 16
- ❽ **START +/- Button** accesses Program display; inputs of programme Start Time. ☞ pg. 21
- ❾ **STOP +/- Button** inputs programme Stop Time. ☞ pg. 21
- ❿ **SP/LP Button** selects tape speed. ☞ pg. 15  
**Digit Entry Button** is used in controlling connected TV. ☞ pg. 39
- ⓫ **TV Mute Button** mutes sound of connected TV. ☞ pg. 39
- ⓬ **Rewind [REW] Button** — same as button on recorder. ☞ pg. 10
- ⓭ **PLAY Button** — same as button on recorder. ☞ pg. 10
- ⓮ **RECORD Button** — same as button on recorder. ☞ pg. 15
- ⓯ **PROG Button** accesses Timer Programming display. ☞ pg. 19
- ⓰ **PUSH JOG  $\Delta \nabla \triangleleft \triangleright$  Button** is used for display selection. ☞ pg. 7  
**PUSH JOG  $\triangleleft \triangleright$  Button** sets preset of TV ☞ pg. 39; initiates functions such as Index Search ☞ pg. 13, variable-speed search, frame by frame playback. ☞ pg. 11
- ⓱ **STORE Button** is used when storing channels manually. ☞ pg. 26

- 18 **OPERATE Button** — same as button on recorder. [☞](#) pg. 5
- 19 **DISPLAY Button** switches display between clock time and counter readings. [☞](#) pg. 16
- 20 **ADD TIME Button** adds time to end of recording (5 minutes each time button is pressed.) [☞](#) pg. 20
- 21 **DAILY Button** enables timer recording of daily serials. [☞](#) pg. 20
- 22 **WEEKLY Button** enables timer recording of weekly serials. [☞](#) pg. 20
- 23 **AUX Button** sets recorder's input mode. [☞](#) pg. 24
- 24 **TIMER Button** — same as button on recorder. [☞](#) pg. 20
- 25 **TV PROG. +/- Button** selects preset. [☞](#) pg. 15
- 26 **DATE +/- Button** inputs date of programme for timer recording. [☞](#) pg. 21
- 27 **TV/VCR Switch** enables remote control of VCR or connected TV. [☞](#) "Operating JVC TVs" in the right column.
- 28 **TV/VIDEO Button** switches control between TV and VCR. [☞](#) "Operating JVC TVs" in the right column.
- 29 **Fast Forward [FF] Button** — same as button on recorder. [☞](#) pg. 10
- 30 **PAUSE Button** — same as button on recorder. [☞](#) pg. 11
- 31 **STOP Button** — same as button on recorder. [☞](#) pg. 10
- 32 **PROG CHECK Button** accesses Program displays (next program's information display appears each time button is pressed). [☞](#) pg. 23
- 33 **OK Button** enters display selections. [☞](#) pg. 7
- 34 **TV VOL  $\Delta$ / $\nabla$  Button** controls volume of connected TV. [☞](#) "Operating JVC TVs" in the right column.

#### Installing Batteries

- 1 Open the battery compartment cover.
- 2 Insert 2 "R6"-size batteries (provided) in the correct directions.
- 3 Replace the cover.

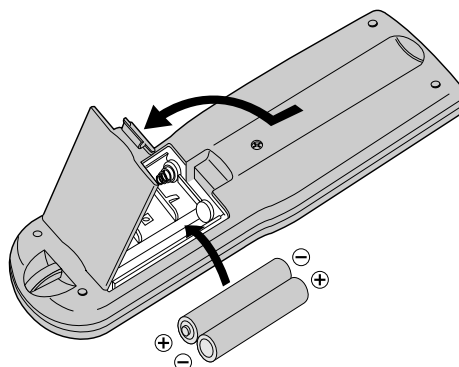

#### How To Use

The remote control can operate most of your video recorder's functions, as well as basic functions of JVC TV sets. See below.

- Point the remote control toward the sensor window.
- The maximum operating distance of the remote control is about 8 m.

#### NOTE:

*If for some reason the remote control doesn't work properly, remove its batteries, wait a short time and then try again.*

#### Operating JVC TVs

To operate your TV, set the **TV/VCR** switch to "TV". The **OPERATE** button, **TV/VIDEO** button, **TV PROG. +/-** buttons, **TV VOL  $\Delta$ / $\nabla$**  buttons and the **MUTE** button on the remote control can all be used to operate the TV. Use the **NUMBER** keys, and the **DIGIT ENTRY (///)** button or the **PUSH JOG  $\triangleleft$ / $\triangleright$**  button to select the TV's preset.

The **DIGIT ENTRY (///)** button corresponds to the 1-digit/2-digit entry switching button (often labelled **-/-**) on your TV's remote control. The **PUSH JOG  $\triangleleft$**  button corresponds to the **10+** button, and the **PUSH JOG  $\triangleright$**  button corresponds to the **20+** button of your TV's remote control.

#### NOTE:

*The way these buttons are used is determined by your TV. Use these buttons as instructed for your TV's remote control.*

## SPECIFICATIONS

### GENERAL

Power requirement	: AC 220 – 240 V~, 50/60 Hz
Power consumption	: 20 W
Temperature	
Operating	: 5°C to 40°C
Storage	: -20°C to 60°C
Operating position	: Horizontal only
Dimensions (WxHxD)	: 400 x 94 x 340 mm [A230EK, A230ES] 400 x 94 x 338 mm [A231EK]
Weight	: 4.3 kg
Format	: VHS PAL standard
Maximum recording time	
(SP)	: 240 min. with E-240 video cassette
(LP)	: 480 min. with E-240 video cassette

### VIDEO/AUDIO

Signal system	: PAL-type colour signal and CCIR monochrome signal, 625 lines/50 fields
Recording system	: Rotary two-head helical scan system
Signal-to-noise ratio	: 45 dB
Horizontal resolution	: 250 lines
Frequency range	: 70 Hz to 10,000 Hz
Input/Output	: 21-pin scart connector x 2 (IN/OUT x 1, IN x 1)

### TUNER/TIMER

TV channel storage capacity	: 99 positions (+AUX position "AU")
Tuning system	: Frequency synthesized tuner
Channel coverage	: [A230EK, A231EK] UHF channels 21 – 69 (470 – 862 MHz) : [A230ES] VHF 44.5 – 111/111 – 300/302 – 470 MHz UHF 470 – 862 MHz
Aerial output	: UHF channel 36 (Adjustable 32 – 40)
Memory backup time	: Approx. 3 min.

### ACCESSORIES

Provided accessories	: RF cable, Infrared remote control unit, "R6" battery x 2
----------------------	--

*Specifications shown are for SP mode unless otherwise specified.  
E. & O.E. Design and specifications subject to change without notice.*

**JVC**  
VICTOR COMPANY OF JAPAN, LIMITED



## Free Manuals Download Website

<http://myh66.com>

<http://usermanuals.us>

<http://www.somanuals.com>

<http://www.4manuals.cc>

<http://www.manual-lib.com>

<http://www.404manual.com>

<http://www.luxmanual.com>

<http://aubethermostatmanual.com>

Golf course search by state

<http://golfingnear.com>

Email search by domain

<http://emailbydomain.com>

Auto manuals search

<http://auto.somanuals.com>

TV manuals search

<http://tv.somanuals.com>