

# JVC

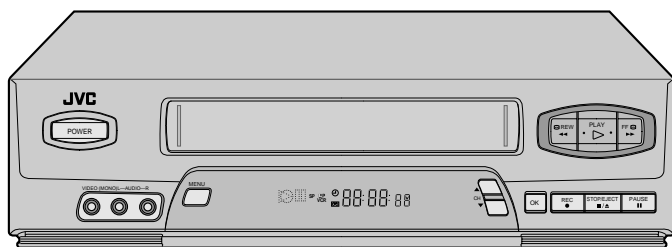

## VIDEO CASSETTE RECORDER

# HR-A51U

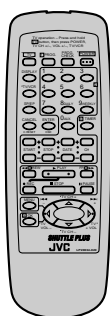

**VHS**  
*Hi-Fi*  
**SQPB**

## INSTRUCTIONS

**For Customer Use:**

Enter below the Model No. and Serial No. which are located on the rear of cabinet. Retain this information for future reference.



Model No. \_\_\_\_\_

Serial No. \_\_\_\_\_

**Dear Customer,**

Thank you for purchasing the JVC VHS video cassette recorder. Before use, please read the safety information and precautions contained in the following pages to ensure safe use of your new VCR.

# CAUTIONS

	<b>CAUTION</b> RISK OF ELECTRIC SHOCK DO NOT OPEN	
<b>CAUTION:</b> TO REDUCE THE RISK OF ELECTRIC SHOCK. DO NOT REMOVE COVER (OR BACK). NO USER-SERVICEABLE PARTS INSIDE. REFER SERVICING TO QUALIFIED SERVICE PERSONNEL.		



The lightning flash with arrowhead symbol, within an equilateral triangle, is intended to alert the user to the presence of uninsulated "dangerous voltage" within the product's enclosure that may be of sufficient magnitude to constitute a risk of electric shock to persons.



The exclamation point within an equilateral triangle is intended to alert the user to the presence of important operating and maintenance (servicing) instructions in the literature accompanying the appliance.

**WARNING:**  
**TO PREVENT FIRE OR SHOCK HAZARD, DO NOT EXPOSE THIS UNIT TO RAIN OR MOISTURE.**

**CAUTION:**

This video cassette recorder should be used with AC 120V~, 60Hz only.  
To prevent electric shocks and fire hazards, DO NOT use any other power source.

**CAUTION:**

TO PREVENT ELECTRIC SHOCK, MATCH WIDE BLADE OF PLUG TO WIDE SLOT, FULLY INSERT.

**ATTENTION:**

POUR ÉVITER LES CHOCS ÉLECTRIQUES, INTRODUIRE LA LAME LA PLUS LARGE DE LA FICHE DANS LA BORNE CORRESPONDANTE DE LA PRISE ET POUSSER JUSQU'AU FOND.

**Note to CATV system installer:**

This reminder is provided to call the CATV system installer's attention to Article 820-40 of the NEC that provides guidelines for proper grounding and, in particular, specifies that the cable ground shall be connected to the grounding system of the building, as close to the point of cable entry as practical.

**CAUTION:**

Changes or modifications not approved by JVC could void user's authority to operate the equipment.

**Failure to heed the following precautions may result in damage to the VCR, remote control or video cassette.**

**1. DO NOT place the VCR . . .**

- ... in an environment prone to extreme temperatures or humidity.
- ... in direct sunlight.
- ... in a dusty environment.
- ... in an environment where strong magnetic fields are generated.
- ... on a surface that is unstable or subject to vibration.

**2. DO NOT block the VCR's ventilation openings.****3. DO NOT place heavy objects on the VCR or remote control.****4. DO NOT place anything which might spill on top of the VCR or remote control.****5. AVOID violent shocks to the VCR during transport.****\*\*MOISTURE CONDENSATION**

Moisture in the air will condense on the VCR when you move it from a cold place to a warm place, or under extremely humid conditions—just as water droplets form on the surface of a glass filled with cold liquid. Moisture condensation on the head drum will cause damage to the tape. In conditions where condensation may occur, keep the VCR's power turned on for a few hours to let the moisture dry before inserting a tape.

**\*\*ABOUT HEAD CLEANING**

Accumulation of dirt and other particles on the video heads may cause the playback picture to become blurred or interrupted. Be sure to contact your nearest JVC dealer if such troubles occur.



- Cassettes marked "VHS" (or "S-VHS") can be used with this video cassette recorder. However, S-VHS recording is not possible with this model.
- This model is equipped with SQPB (S-VHS QUASI PLAY-BACK) that makes it possible to play back S-VHS recordings with regular VHS resolution.
- HQ VHS is compatible with existing VHS equipment.
- As an ENERGY STAR® Partner, JVC has determined that this product or product model meets the ENERGY STAR® guidelines for energy efficiency.

# IMPORTANT PRODUCT SAFETY INSTRUCTIONS

Electrical energy can perform many useful functions. But improper use can result in potential electrical shock or fire hazards. This product has been engineered and manufactured to assure your personal safety. In order not to defeat the built-in safeguards, observe the following basic rules for its installation, use and servicing.

## ATTENTION:

Follow and obey all warnings and instructions marked on your product and its operating instructions. For your safety, please read all the safety and operating instructions before you operate this product and keep this booklet for future reference.

## INSTALLATION

### 1. Grounding or Polarization

(A) Your product may be equipped with a polarized alternating-current line plug (a plug having one blade wider than the other). This plug will fit into the power outlet only one way. This is a safety feature.

If you are unable to insert the plug fully into the outlet, try reversing the plug. If the plug should still fail to fit, contact your electrician to replace your obsolete outlet. Do not defeat the safety purpose of the polarized plug.

(B) Your product may be equipped with a 3-wire grounding-type plug, a plug having a third (grounding) pin. This plug will only fit into a grounding-type power outlet. This is a safety feature.

If you are unable to insert the plug into the outlet, contact your electrician to replace your obsolete outlet. Do not defeat the safety purpose of the grounding-type plug.

### 2. Power Sources

Operate your product only from the type of power source indicated on the marking label. If you are not sure of the type of power supply to your home, consult your product dealer or local power company. If your product is intended to operate from battery power, or other sources, refer to the operating instructions.

### 3. Overloading

Do not overload wall outlets, extension cords, or integral convenience receptacles as this can result in a risk of fire or electric shock.

### 4. Power Cord Protection

Power supply cords should be routed so that they are not likely to be walked on or pinched by items placed upon or against them, paying particular attention to cords at plugs, convenience receptacles, and the point where they exit from the product.

### 5. Ventilation

Slots and openings in the cabinet are provided for ventilation. To ensure reliable operation of the product and to protect it from overheating, these openings must not be blocked or covered.

- Do not block the openings by placing the product on a bed, sofa, rug or other similar surface.
- Do not place the product in a built-in installation such as a bookcase or rack unless proper ventilation is provided or the manufacturer's instructions have been adhered to.

### 6. Wall or Ceiling Mounting

The product should be mounted to a wall or ceiling only as recommended by the manufacturer.

## ANTENNA INSTALLATION INSTRUCTIONS

### 1. Outdoor Antenna Grounding

If an outside antenna or cable system is connected to the product, be sure the antenna or cable system is grounded so as to provide some protection against voltage surges and built-up static charges. Article 810 of the National Electrical Code, ANSI/NFPA 70, provides information with regard to proper grounding of the mast and supporting structure, grounding of the lead-in wire to an antenna discharge unit, size of grounding connectors, location of antenna discharge unit, connection to grounding electrodes, and requirements for the grounding electrode.

### 2. Lightning

For added protection for this product during a lightning storm, or when it is left unattended and unused for long periods of time, unplug it from the wall outlet and disconnect the antenna or cable system. This will prevent damage to the product due to lightning and power-line surges.

### 3. Power Lines

An outside antenna system should not be located in the vicinity of overhead power lines or other electric light or power circuits, or where it can fall into such power lines or circuits. When installing an outside antenna system, extreme care should be taken to keep from touching such power lines or circuits as contact with them might be fatal.

#### EXAMPLE OF ANTENNA GROUNDING AS PER NATIONAL ELECTRICAL CODE, ANSI/NFPA 70

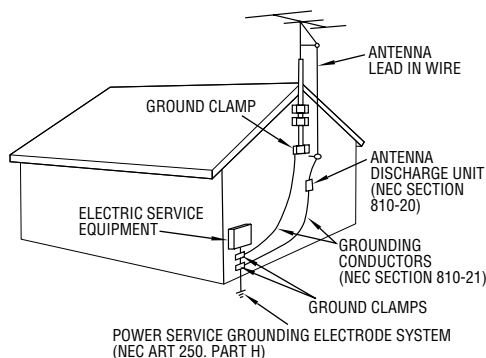

NEC – NATIONAL ELECTRICAL CODE

## USE

### 1. Accessories

To avoid personal injury:

- Do not place this product on an unstable cart, stand, tripod, bracket, or table. It may fall, causing serious injury to a child or adult, and serious damage to the product.
- Use only with a cart, stand, tripod, bracket, or table recommended by the manufacturer or sold with the product.
- Use a mounting accessory recommended by the manufacturer and follow the manufacturer's instructions for any mounting of the product.
- Do not try to roll a cart with small casters across thresholds or deep-pile carpets.

### 2. Product and Cart Combination

A product and cart combination should be moved with care. Quick stops, excessive force, and uneven surfaces may cause the product and cart combination to overturn.

PORTABLE CART WARNING  
(Symbol provided by RETAC)



### 3. Water and Moisture

Do not use this product near water—for example, near a bath tub, wash bowl, kitchen sink or laundry tub, in a wet basement, or near a swimming pool and the like.

### 4. Object and Liquid Entry

Never push objects of any kind into this product through openings as they may touch dangerous voltage points or short-out parts that could result in a fire or electric shock. Never spill liquid of any kind on the product.

### 5. Attachments

Do not use attachments not recommended by the manufacturer of this product as they may cause hazards.

### 6. Cleaning

Unplug this product from the wall outlet before cleaning. Do not use liquid cleaners or aerosol cleaners. Use a damp cloth for cleaning.

### 7. Heat

The product should be situated away from heat sources such as radiators, heat registers, stoves, or other products (including amplifiers) that produce heat.

## SERVICING

### 1. Servicing

If your product is not operating correctly or exhibits a marked change in performance and you are unable to restore normal operation by following the detailed procedure in its operating instructions, do not attempt to service it yourself as opening or removing covers may expose you to dangerous voltage or other hazards. Refer all servicing to qualified service personnel.

### 2. Damage Requiring Service

Unplug this product from the wall outlet and refer servicing to qualified service personnel under the following conditions:

- a. When the power supply cord or plug is damaged.
- b. If liquid has been spilled, or objects have fallen into the product.
- c. If the product has been exposed to rain or water.
- d. If the product does not operate normally by following the operating instructions. Adjust only those controls that are covered by the operating instructions as an improper adjustment of other controls may result in damage and will often require extensive work by a qualified technician to restore the product to its normal operation.
- e. If the product has been dropped or damaged in any way.
- f. When the product exhibits a distinct change in performance—this indicates a need for service.

### 3. Replacement Parts

When replacement parts are required, be sure the service technician has used replacement parts specified by the manufacturer or have the same characteristics as the original part. Unauthorized substitutions may result in fire, electric shock or other hazards.

### 4. Safety Check

Upon completion of any service or repairs to this product, ask the service technician to perform safety checks to determine that the product is in safe operating condition.

## HOW TO USE THIS INSTRUCTION MANUAL

- All major sections and subsections are listed in the Table Of Contents on page 5. Use this when searching for information on a specific procedure or feature.
- The Index on pages 39–42 lists frequently-used terms, and the number of the page on which they are used or explained in the manual. This section also illustrates the controls and connections on the front and rear panel, the front display panel and the remote control.
- The  mark signals a reference to another page for instructions or related information.
- Operation buttons necessary for the various procedures are clearly indicated through the use of illustrations at the beginning of each major section.

## BEFORE YOU INSTALL YOUR NEW VCR . . .

. . . please read the sections/literature listed below.

- "Cautions" on page 2
- "Important Product Safety Instructions" on the previous pages

**I** **NSTALLING YOUR NEW VCR** **6**

**Basic Connections** ..... **6**

**I** **NITIAL SETTINGS** **8**

**Plug & Play** ..... **8**

**Language** ..... **10**

**Clock** ..... **11**

Preparation ..... 11

Semi-Auto ..... 12

Manual ..... 13

**Tuner** ..... **14**

Set Receivable Channels ..... 14

Add Or Delete A Channel ..... 15

**S** **IMPLE PLAYBACK AND RECORDING** **16**

**Simple Playback** ..... **16**

**Simple Recording** ..... **17**

**P** **LAYBACK AND RECORDING FEATURES** **18**

**Playback Features** ..... **18**

Still Picture/Frame-By-Frame Playback ..... 18

Slow Motion/Reverse Slow Motion ..... 18

Variable-Speed Search/Reverse Motion Playback ..... 18

High-Speed Search ..... 19

Index Search ..... 19

Manual Tracking ..... 19

Auto Picture ..... 20

Picture Control ..... 21

Video Stabilizer ..... 22

Repeat Playback ..... 23

Counter Reset ..... 23

Tape Position Indicator ..... 23

Next-Function Memory ..... 23

Superimpose ..... 24

Select The Soundtrack ..... 25

**Recording Features** ..... **26**

Record One Program While

Watching Another ..... 26

Display Elapsed Recording Time ..... 26

Stereo And SAP (Second Audio Program) ..... 27

To Record SAP Programs ..... 27

**T** **IMER RECORDING** **28**

**Express Timer Programming** ..... **28**

Check, Cancel And Revise Programs ..... 30

Auto SP→EP Timer ..... 31

Auto Timer ..... 31

**Instant Timer Recording (ITR)** ..... **32**

**E** **DITING** **33**

**Edit To Another VCR** ..... **33**

**Edit From A Camcorder Or Another VCR** ..... **34**

**T** **ROUBLESHOOTING** **36**

**Power** ..... **36**

**Tape Transport** ..... **36**

**Playback** ..... **36**

**Recording** ..... **36**

**Timer Recording** ..... **37**

**Other Problems** ..... **37**

**Q** **UESTIONS AND ANSWERS** **38**

**Playback** ..... **38**

**Recording** ..... **38**

**Timer Recording** ..... **38**

**I** **NDEX** **39**

**List Of Terms** ..... **39**

**Front View** ..... **40**

**Rear View** ..... **41**

**Front Display Panel** ..... **41**

**Remote Control** ..... **42**

**S** **PECIFICATIONS** **43**

**F** **OR SERVICING (Only in U.S.A.)** **44**

**W** **ARRANTY (Only in U.S.A.)** **45**

# Basic Connections

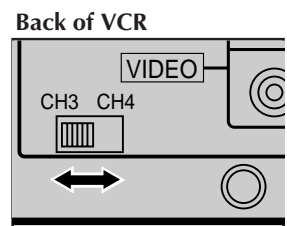
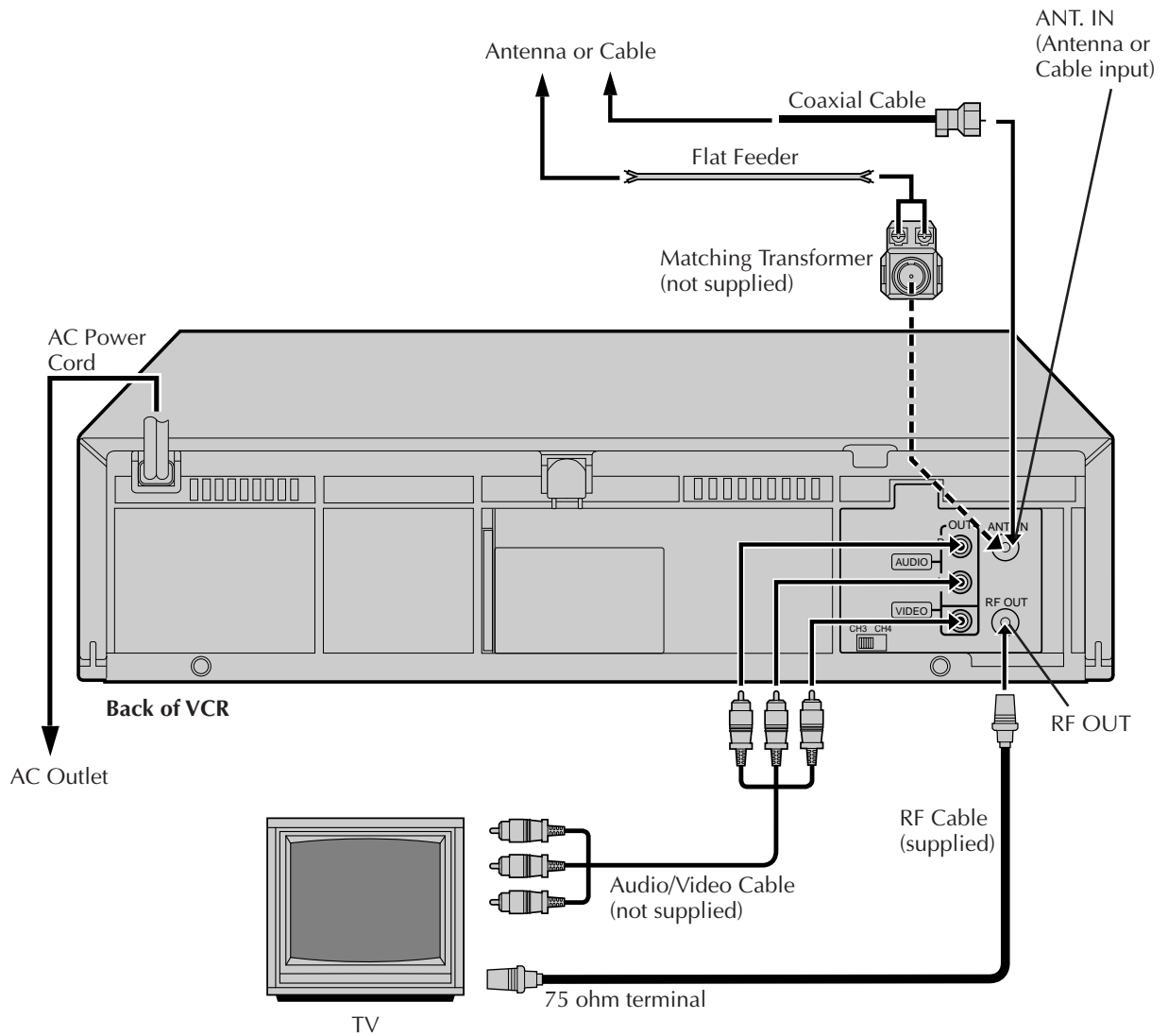

## CHECK CONTENTS

- 1** Make sure the package contains all of the accessories listed in "SPECIFICATIONS" (☞ pg. 43).

## SITUATE VCR

- 2** Place the VCR on a stable, horizontal surface.

## CONNECT VCR TO TV

- 3** The connection method you use depends on the type of TV you have.

### RF Connection

- *To Connect To A TV With NO AV Input Terminals . . .*
  - a- Disconnect the TV antenna from the TV.
  - b- Connect the TV antenna cable to the ANT. IN jack on the rear of the VCR.
  - c- Connect the supplied RF cable between the RF OUT jack on the rear of the VCR and the TV's antenna terminal. Set TV on CH3 or CH4 corresponding to the CH3 – CH4 switch setting on the back of the VCR.

### AV Connection

- *To Connect To A TV With AV Input Terminals . . .*
  - a- Connect the antenna, VCR and TV as shown in the illustration.
  - b- Connect an Audio/Video Cable between the AUDIO OUT and VIDEO OUT jacks on the rear of the VCR and the AV IN jacks on the TV. Set your TV in video input mode or A/V input mode. Refer to the TV Instruction Manual.

## CONNECT VCR TO POWER SOURCE

- 4** Connect the power plug to an AC outlet.

- The clock and tuner channels will automatically be set when the antenna is connected and when the AC is first connected to the VCR (☞ pg. 8). (If "Auto" or "CH" is displayed on the front display panel before the VCR is powered on, the clock and tuner channels are being set automatically. Wait for the time to be displayed on the front display panel before powering on the VCR.)

## FINAL PREPARATION FOR USE

- 5** Power on the VCR and select the VCR channel (3 or 4) by setting the switch on the rear of the VCR as shown in the illustration. You can now perform simple playback (☞ pg. 16) or simple recording (☞ pg. 17).

## NOTES:

- *The VCR channel is the channel on the TV which will display the audio and video signals from the VCR. The VCR's CH3-CH4 switch, on the back of the VCR, sets the VCR channel to CH3 or CH4.*
- *The CH3-CH4 switch is preset to the CH3 position. Set to CH4 if CH3 is used for broadcasting in your area and set the channel on the TV to correspond to the VCR's CH3-CH4 switch setting.*
- *If RF connection to TV is used, when switching from VCR to TV mode and from TV to VCR it may be necessary to issue a CH UP and then CH DOWN on TV to obtain a good quality picture.*
- *Even if you are using AV cables to connect your VCR to your TV, you must also connect it using the RF cable. This will ensure that you can record one show while watching another (☞ pg. 26).*
- *For full identification of the VCR's rear panel, refer to the Index (REAR VIEW ☞ pg. 41).*

# Plug & Play

## Auto Clock Set/Auto Tuner Set

### ATTENTION

If you use a cable box, Plug & Play will not function; set the clock and tuner channels manually. (☞ pg.11 – 15)

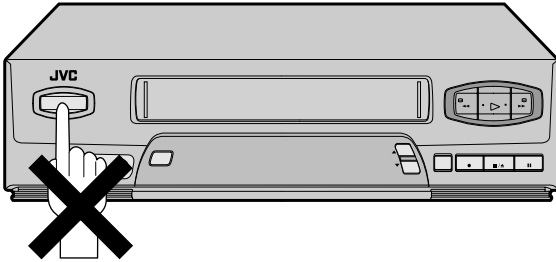

### IMPORTANT

- Don't press any buttons on the VCR or remote while Plug & Play is in progress.
- If you perform Plug & Play successfully, there's no need to perform the Clock (☞ pg. 11) and Tuner (☞ pg. 14) procedures. If, however, you want to add or delete channels, refer to "Add Or Delete A Channel" on page 15.

The Plug & Play function sets the clock and tuner channels automatically when power is first connected to the VCR. The antenna cable must be connected for the Plug & Play function.

The time and date can be set automatically from clock setting data that is transmitted by one of the regular TV broadcast channels. We call this TV channel the "Host Channel" and it is a PBS channel in your area.

## 1 PLUG & PLAY SETUP

**1** Connect the antenna cable to the VCR (☞ pg. 6). Then connect the VCR's power plug to an AC outlet. Do not power on the VCR. The clock and tuner channels will be set automatically.

### NOTES:

- Auto clock set is performed first. The auto clock set function scans all the channels received by your VCR to find the Host Channel and then sets the clock. "Auto" blinks on the front display panel during Auto clock set.
- Auto channel set is performed next. The auto channel set function scans all the channels that are receivable by your VCR. It then automatically assigns each receivable channels to the **CH▲▼ (+/-)** buttons. It skips non-receivable channels. During auto channel set the channel numbers are displayed as they are scanned and set.
- When Plug & Play has been completed successfully the correct time is displayed.
- If an incorrect time or "--:--" appears on the display panel, see "What To Do If Plug & Play Has Failed" on next page.

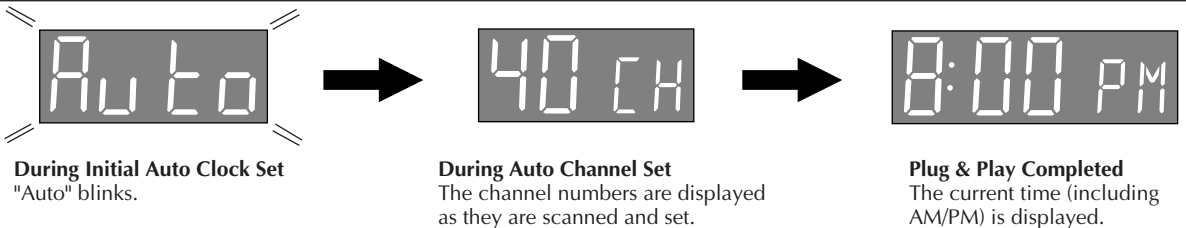

\* If an incorrect time or "--:--" appears on the display panel, see "What To Do If Plug & Play Has Failed" on next page.



**INFORMATION**

- If "AUTO CLOCK" is set to "ON" at the Clock Set screen on page 12, the clock will be adjusted automatically by the host channel every hour on the hour (except for 11:00 PM, midnight, 1:00 AM and 2:00 AM) by the incoming PBS channel clock setting data. (This automatic clock adjustment can only be performed when the VCR's power is turned off. The clock will be adjusted on the hour based on the time displayed on the VCR, not on the actual real time.) The default setting of "AUTO CLOCK" is "ON".
- If the memory backup fails, because of a power outage or because the AC was removed from the VCR, Plug & Play will be performed when power is restored to the VCR.

**What To Do If Plug & Play Has Failed**

- If an incorrect time is displayed on the front display panel, you may be receiving the clock setting data of a PBS channel from an adjacent time zone, or an incorrect PBS channel from a cable TV system. In this case, perform the Semi-Auto (pg. 12) or Manual Clock Set (pg. 13) procedure. Auto channel set has already taken place and it need not be set again.
- If "--:--" appears on the display, your antenna cable may not be connected to the VCR or there may not be a Host PBS signal available in your area. Ensure that the antenna cable is connected correctly. Then power on and power off the VCR; the Plug & Play function will be automatically reactivated and "Auto" will be displayed on the VCR's front panel. If Plug & Play is not performed but the antenna cable is connected correctly, perform the Manual Clock Set procedure (pg. 13). Auto channel set has not yet taken place, so please also perform the "Set Receivable Channels" procedure (pg. 14).

# Language

Turn on the TV and select the VCR channel 3 or 4 (or AV mode).

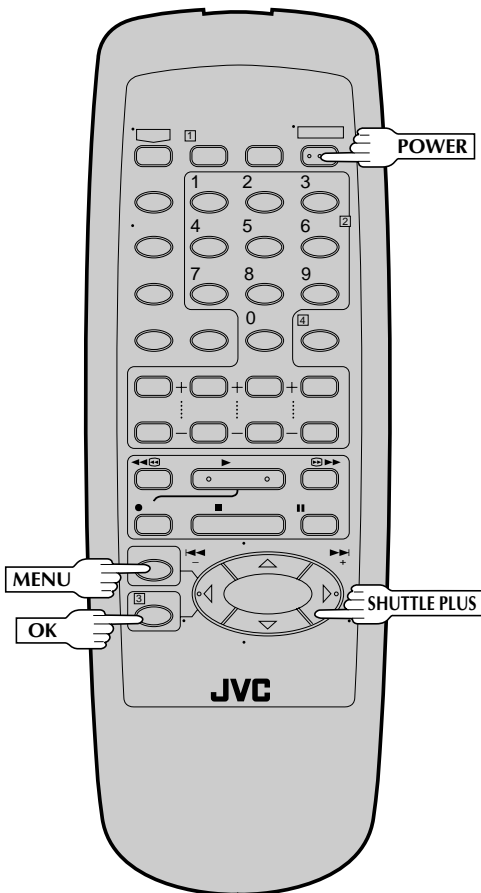
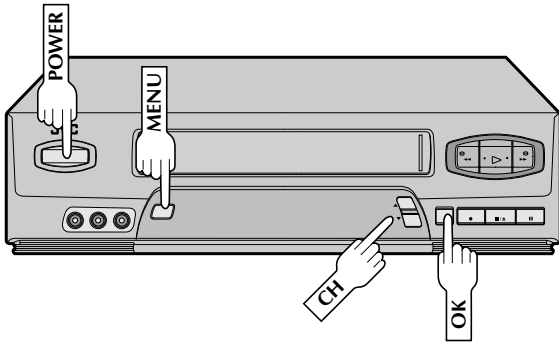

This VCR offers you the choice to view on-screen messages in English, Spanish or French (not including messages superimposed on the TV picture). Select the desired language using this procedure. The default setting is "ENGLISH".

## 1 TURN ON THE VCR

Press **POWER**.

## 2 ACCESS MAIN MENU SCREEN

Press **MENU**.

## 3 ACCESS INITIAL SET SCREEN

At the Main Menu screen, move the highlight bar (arrow) to "INITIAL SET" by pressing **CH▲▼** or **SHUTTLE PLUS▲▼**, then press **OK** or **SHUTTLE PLUS▶**.

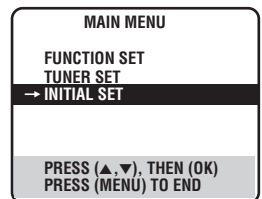

## 4 SELECT LANGUAGE

Move the highlight bar (arrow) to "LANGUAGE" by pressing **CH▲▼** or **SHUTTLE PLUS▲▼**, then press **OK** or **SHUTTLE PLUS▶** to select the desired language.

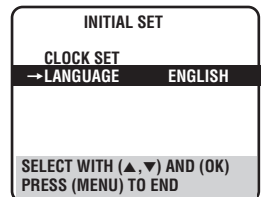

## 5 RETURN TO NORMAL SCREEN

Press **MENU**.

# Clock

Turn on the TV and select the VCR channel 3 or 4 (or AV mode).

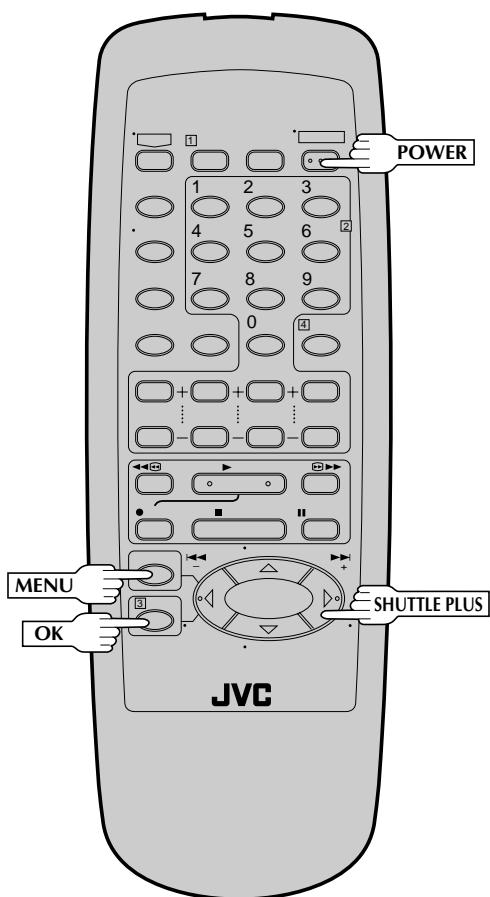
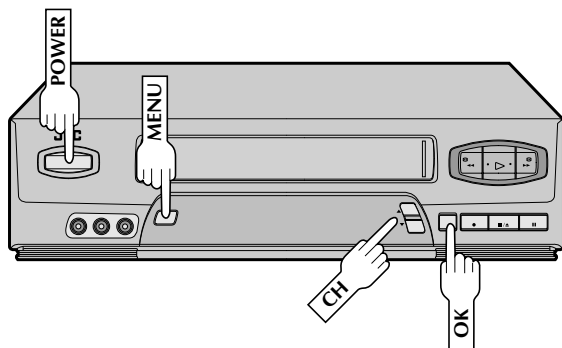

Perform clock setting only if the clock has not been set correctly by the Plug & Play function. Access the Clock Set screen to perform the Semi-Auto or Manual clock setting procedure. Each procedure starts from step 5.

If you use a cable box, set the clock manually. (pg. 13)

## Preparation

### 1 TURN ON THE VCR

Press **POWER**.

### 2 ACCESS MAIN MENU SCREEN

Press **MENU**.

### 3 ACCESS INITIAL SET SCREEN

At the Main Menu screen, move the highlight bar (arrow) to "INITIAL SET" by pressing **CH▲▼** or **SHUTTLE PLUS△▽**, then press **OK** or **SHUTTLE PLUS▷**.

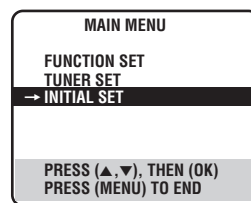

### 4 ACCESS CLOCK SET SCREEN

Move the highlight bar (arrow) at the Initial Set screen to "CLOCK SET" by pressing **CH▲▼** or **SHUTTLE PLUS△▽**, then press **OK** or **SHUTTLE PLUS▷**.

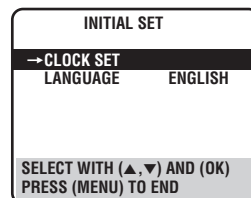

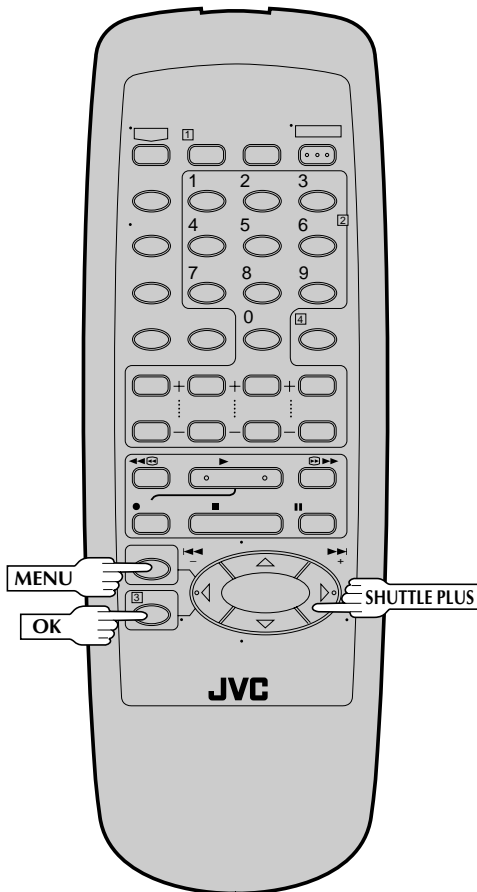
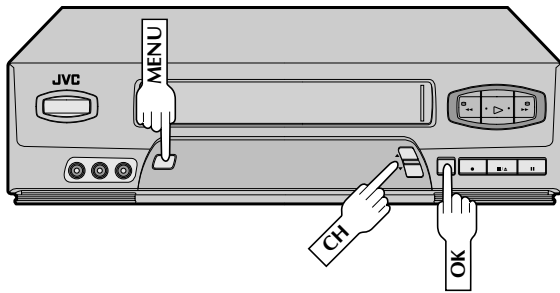

## Semi-Auto

You can change the Host Channel/D.S.T./Time Zone setting manually.

5

### SET AUTO CLOCK TO ON

At the Clock Set screen, press **OK** or **SHUTTLE PLUS**  $\triangleright$  to move the highlight bar to "AUTO CLOCK" and press **CH**  $\blacktriangle\blacktriangledown$  or **SHUTTLE PLUS**  $\triangle\triangledown$  to set to "ON".

- a- To select the Host Channel — go to step 6
- b- To select the D.S.T. mode — go to step 7
- c- To select the Time Zone — go to step 8

CLOCK SET			
TIME	DATE	YEAR	
1:00PM	12/24	99	THU
<b>AUTO CLOCK : ON</b>			
HOST CH	AUTO	(CATV)	
D.S.T.	: AUTO		
TIME ZONE	: AUTO		
PRESS ( $\blacktriangle\blacktriangledown$ ), THEN (OK)			
PRESS (MENU) TO END			

### NOTE:

The time that has been set previously will be erased when "AUTO CLOCK", "HOST CH", "D.S.T." or "TIME ZONE" setting is changed.

6

### SELECT HOST CHANNEL

You can either select "AUTO" or enter a PBS channel number. Move the highlight bar to "HOST CH" by pressing **OK** or **SHUTTLE PLUS**  $\triangleright$ , then press **CH**  $\blacktriangle\blacktriangledown$  or **SHUTTLE PLUS**  $\triangle\triangledown$  to set to "AUTO" or the desired PBS channel number.

### NOTE:

There are some PBS channels that do not transmit clock setting data.

7

### SELECT D.S.T. MODE

You have three choices:

- a- Select "AUTO" and the adjustment to your VCR's clock will be made according to the incoming signal from the host channel.
- b- Select "ON" and the adjustment will be made based on the clock itself.
- c- Select "OFF" if Daylight Saving Time does not apply to you.

Move the highlight bar to "D.S.T." by pressing **OK** or **SHUTTLE PLUS**  $\triangleright$ , then press **CH**  $\blacktriangle\blacktriangledown$  or **SHUTTLE PLUS**  $\triangle\triangledown$  to select the desired mode.

#### \*\*AUTO DAYLIGHT SAVING TIME

This function enables automatic adjustment of the VCR's clock at the start and end of Daylight Saving Time.

With Auto DST activated, . . .

. . . on the first Sunday of April at 2:00 AM, the clock is adjusted to 3:00 AM.

. . . on the last Sunday of October at 2:00 AM, the clock is adjusted to 1:00 AM.

## 8 SELECT TIME ZONE

**8** You can select the time zone automatically or manually. Move the highlight bar to "TIME ZONE" by pressing **OK** or **SHUTTLE PLUS**  $\triangleright$ , then press **CH**  $\blacktriangle$   $\blacktriangledown$  or **SHUTTLE PLUS**  $\triangle$   $\nabla$  to select "AUTO" or the desired time zone.

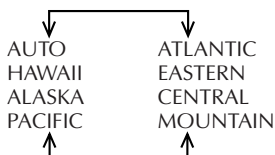

### NOTE:

If an incorrect time is displayed by the Plug & Play function, you may be receiving the clock setting data of a PBS channel from an adjacent time zone or from an incorrect PBS channel from a cable TV system. If you selected "AUTO" for the host channel in step 6, be sure to select the correct time zone manually.

## 9 RETURN TO NORMAL SCREEN

Press **MENU**.

### IMPORTANT

Turn the VCR off after performing the Semi-Auto Clock Set procedure. "Auto" will appear on the front display panel when the clock is being set. The current time will appear automatically when the clock is set.

## Manual

## 5 SET TIME

Press **CH**  $\blacktriangle$   $\blacktriangledown$  or **SHUTTLE PLUS**  $\triangle$   $\nabla$  until the desired time appears, then press **OK** or **SHUTTLE PLUS**  $\triangleright$ .

- Press and hold **CH**  $\blacktriangle$   $\blacktriangledown$  or **SHUTTLE PLUS**  $\triangle$   $\nabla$  to change the time by 30 minutes.
- When the time is entered manually, "AUTO CLOCK" will be automatically set to "OFF", and "HOST CH" and "TIME ZONE" will disappear.

CLOCK SET			
TIME	DATE	YEAR	
--:--	--AM	1/ 1	99
AUTO CLOCK : ON			
HOST CH	: AUTO	(CATV)	
D.S.T.	: AUTO		
TIME ZONE	: AUTO		
PRESS ( $\blacktriangle$ , $\blacktriangledown$ ), THEN (OK)			
PRESS (MENU) TO END			

## 6 SET DATE

Press **CH**  $\blacktriangle$   $\blacktriangledown$  or **SHUTTLE PLUS**  $\triangle$   $\nabla$  until the desired date appears, then press **OK** or **SHUTTLE PLUS**  $\triangleright$ .

- Press and hold **CH**  $\blacktriangle$   $\blacktriangledown$  or **SHUTTLE PLUS**  $\triangle$   $\nabla$  to change the date by 15 days.

## 7 SET YEAR

Press **CH**  $\blacktriangle$   $\blacktriangledown$  or **SHUTTLE PLUS**  $\triangle$   $\nabla$  until the desired year appears, then press **OK** or **SHUTTLE PLUS**  $\triangleright$  twice.

## 8 SELECT D.S.T. MODE

Press **CH**  $\blacktriangle$   $\blacktriangledown$  or **SHUTTLE PLUS**  $\triangle$   $\nabla$  to select the desired mode.

- Set to "ON" so that the adjustment to your VCR's clock will be made on the clock itself.
- Set to "OFF" if Daylight Saving Time does not apply to you.

## 9 START CLOCK

Press **MENU** and normal screen appears.

## To Make Corrections

Press **OK** or **SHUTTLE PLUS**  $\triangleright$  until the item you want to change blinks, then press **CH**  $\blacktriangle$   $\blacktriangledown$  or **SHUTTLE PLUS**  $\triangle$   $\nabla$ .

# Tuner

Turn on the TV and select the VCR channel 3 or 4 (or AV mode).

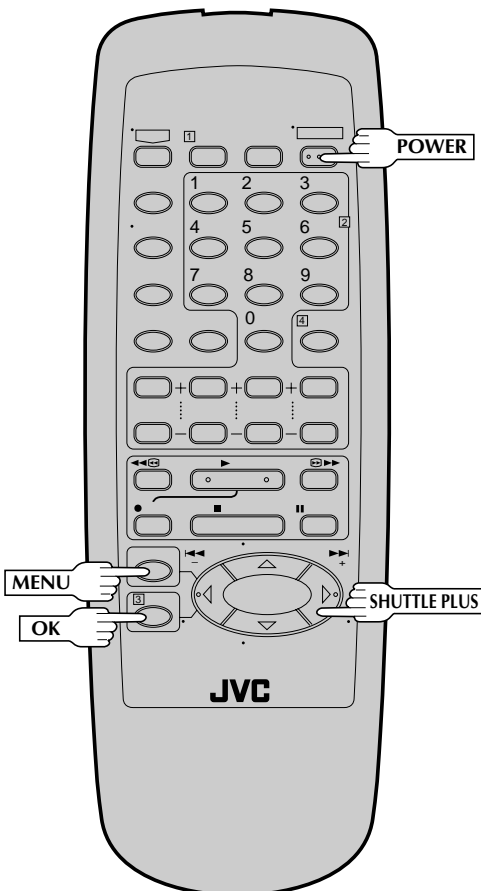
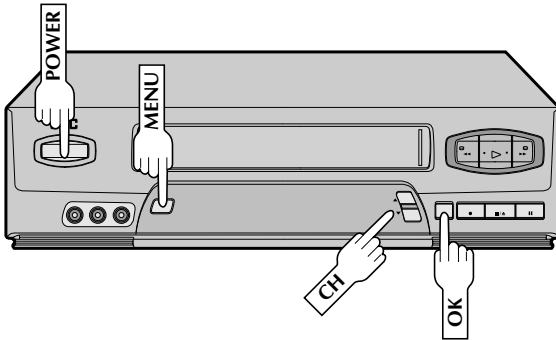

## Set Receivable Channels

### 1 TURN ON THE VCR

Press **POWER**.

### 2 ACCESS MAIN MENU SCREEN

Press **MENU**.

### 3 ACCESS TUNER SET SCREEN

Move the highlight bar (arrow) to "TUNER SET" by pressing **CH▲▼** or **SHUTTLE PLUS▲▽**, then press **OK** or **SHUTTLE PLUS▷**.

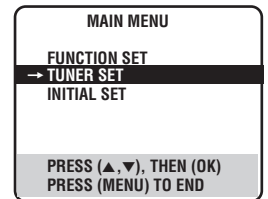

### 4 PERFORM AUTO CHANNEL SET

Move the highlight bar (arrow) to "AUTO CHANNEL SET" by pressing **CH▲▼** or **SHUTTLE PLUS▲▽**, then press **OK** or **SHUTTLE PLUS▷**.

- Receivable channels in your area are automatically assigned to the **CH▲▼** (+/-) buttons, and non-receivable channels are skipped.

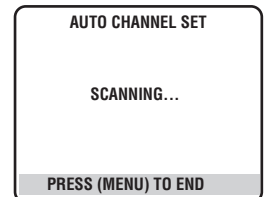
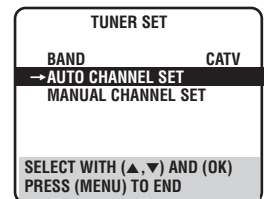

### NOTES:

- At the end of Auto Channel Set, "SCAN COMPLETED" appears on screen.
- If the scan was unsuccessful, "SCAN COMPLETED -NO SIGNAL-" appears on screen. Check the connections and start again.

### 5 RETURN TO NORMAL SCREEN

Press **MENU**.

### INFORMATION

The VCR detects the band (TV or CATV) and selects the correct band automatically during Auto Channel Set. The selected band will be displayed on the right side of "BAND" on the Tuner Set screen.

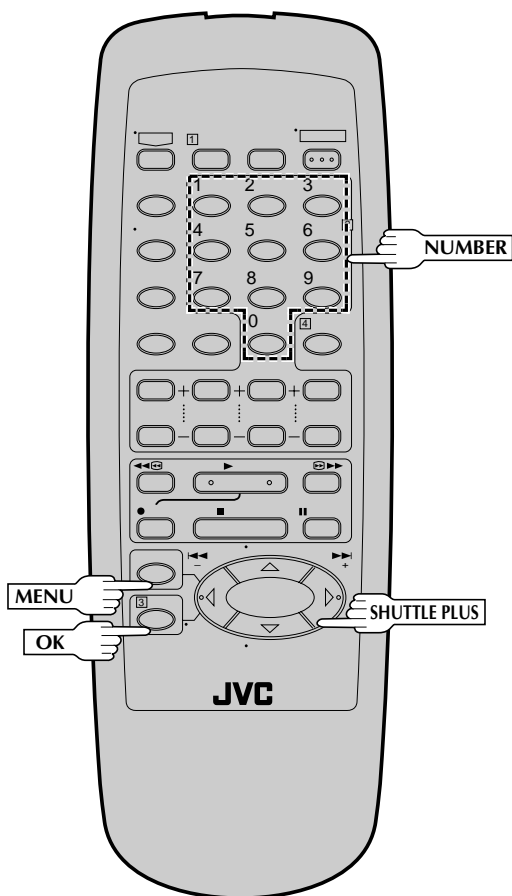
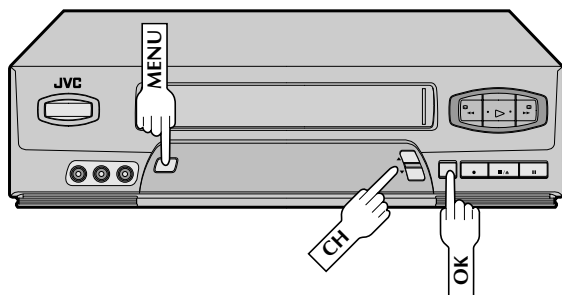

## Add Or Delete A Channel

1

### ACCESS MAIN MENU SCREEN

Press **MENU**.

2

### ACCESS TUNER SET SCREEN

Move the highlight bar (arrow) to "TUNER SET" by pressing **CH▲▼** or **SHUTTLE PLUS▲▼**, then press **OK** or **SHUTTLE PLUS▷**.

3

### ACCESS MANUAL CHANNEL SET SCREEN

Move the highlight bar (arrow) to "MANUAL CHANNEL SET" by pressing **CH▲▼** or **SHUTTLE PLUS▲▼**, then press **OK** or **SHUTTLE PLUS▷**.

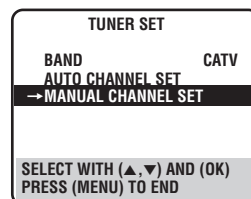

4

### ADD OR SKIP DESIRED CHANNEL

Input the channel number using the **NUMBER** keys or by pressing **CH▲▼** or **SHUTTLE PLUS▲▼**, then press **OK** or **SHUTTLE PLUS▷** to set to "SKIP". Repeat for each channel you want to skip. Input the channel number using the **NUMBER** keys, then press **OK** or **SHUTTLE PLUS▷** to set to "ADD" the channel.

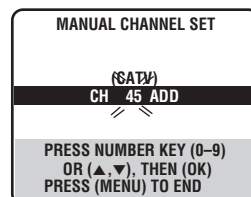

5

### RETURN TO NORMAL SCREEN

Press **MENU**.

# Simple Playback

Turn on the TV and select the VCR channel 3 or 4 (or AV mode).

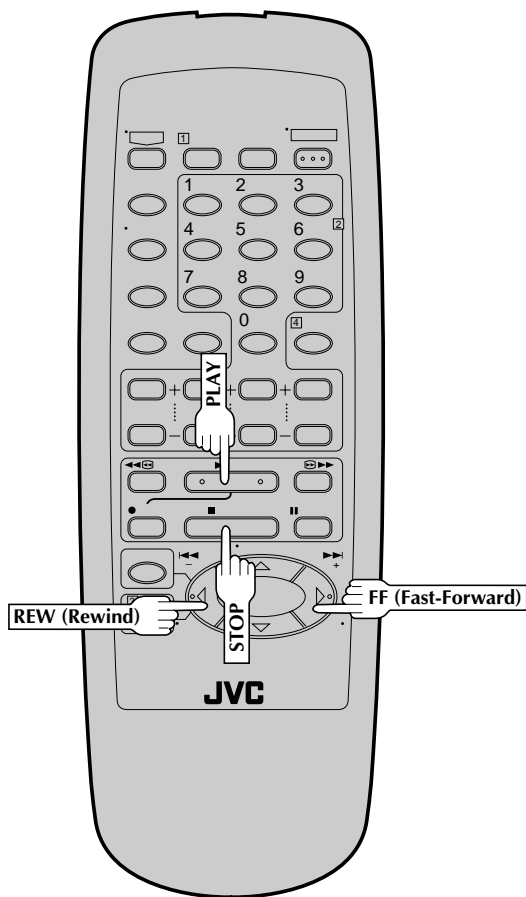
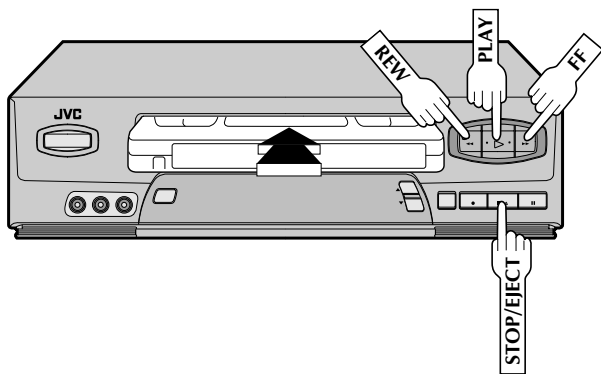

## 1 LOAD A CASSETTE

Make sure the window side is up, the rear label side is facing you and the arrow on the front of the cassette is pointing towards the VCR. Don't apply too much pressure when inserting.

- The VCR's power comes on automatically.
- The counter is automatically reset to "0:00:00".
- If the cassette's record safety tab has been removed, playback begins automatically.

## 2 FIND PROGRAM START POINT

If the tape is advanced past the start point, press **REW**. To go forward, press **FF**.

## 3 START PLAYBACK

Press **PLAY**. "AUTO PICTURE" appears on the screen (when AUTO PICTURE is set to "ON"  pg. 20).

## 4 STOP PLAYBACK

Press **STOP** or **STOP/EJECT**. Then press **STOP/EJECT** to remove the cassette.

## INFORMATION

This video recorder is equipped with SQPB (S-VHS QUASI PLAYBACK) that lets you watch tapes recorded in the S-VHS format with regular VHS resolution.

- SQPB does not deliver Super VHS resolution.
- S-VHS recording is not possible with this video recorder.

### Usable cassettes

Full-Size VHS  
T-30 (ST-30\*\*)  
T-60 (ST-60\*\*)  
T-90  
T-120 (ST-120\*\*)  
T-160 (ST-160\*\*)  
ST-210\*\*

Compact VHS\*  
TC-20 (ST-C20\*\*)  
TC-30 (ST-C30\*\*)  
TC-40 (ST-C40\*\*)

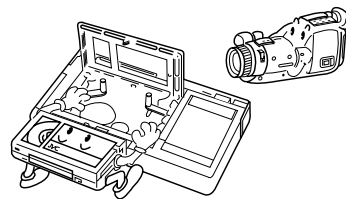

\* Compact VHS camcorder recordings can be played on this video recorder. Simply place the recorded cassette into a VHS Cassette Adapter and it can be used just like any full-sized VHS cassette.

\*\* This video recorder can record on regular VHS and Super VHS cassettes. However, it will record regular VHS signals only.



# Simple Recording

Turn on the TV and select the VCR channel 3 or 4 (or AV mode).

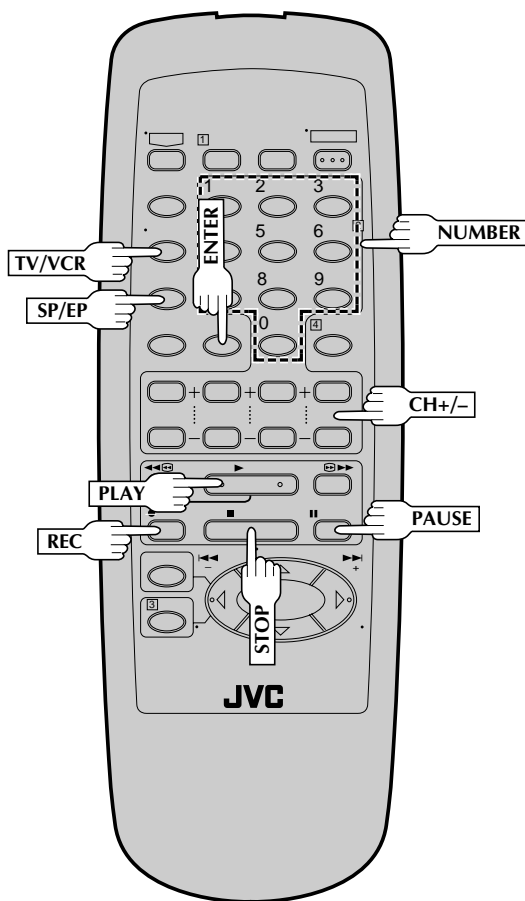
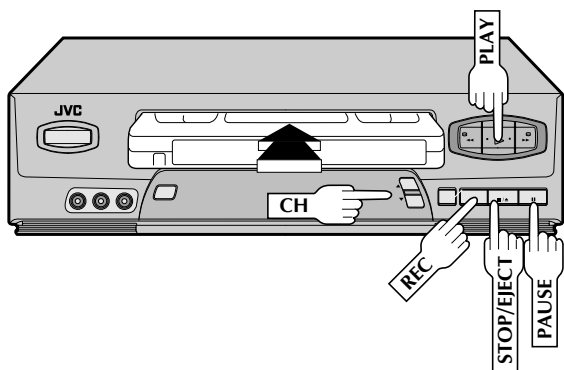

## 1 LOAD A CASSETTE

Make sure the record safety tab is intact. If not, cover the hole with adhesive tape before inserting the cassette.

## 2 SELECT RECORDING CHANNEL

Press **CH▲▼** (+/-). Or press the appropriate **NUMBER** keys, then press **ENTER**. (The channel changes after a few seconds whether you press **ENTER** or not.)

- If you use the RF connection, by pressing the **TV/VCR** button, select VCR mode to view the program to be recorded.

## 3 SET TAPE SPEED

Press **SP/EP** to set the recording speed.

## 4 START RECORDING

Press and hold **REC** and press **PLAY** on the remote control, or press **REC** on the VCR's front panel.

## 5 PAUSE/RESUME RECORDING

Press **PAUSE**. Press **PLAY** to resume recording.

- During record pause, you can change the recording channel by using the **CH▲▼** (+/-) buttons or **NUMBER** keys.

## 6 STOP RECORDING

Press **STOP** or **STOP/EJECT**. Then press **STOP/EJECT** to remove the cassette.

### Accidental erasure prevention

- To prevent accidental recording on a recorded cassette, remove its record safety tab. To record on it later, cover the hole with adhesive tape.

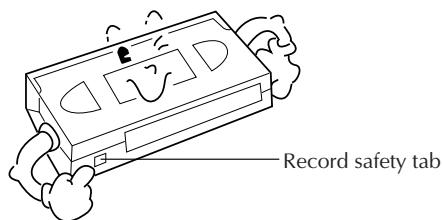

# Playback Features

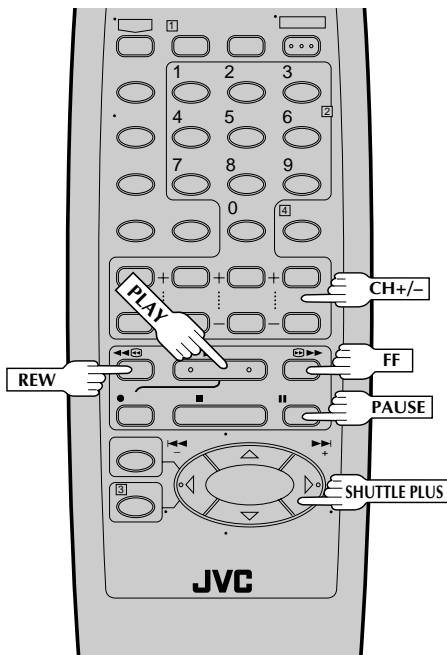
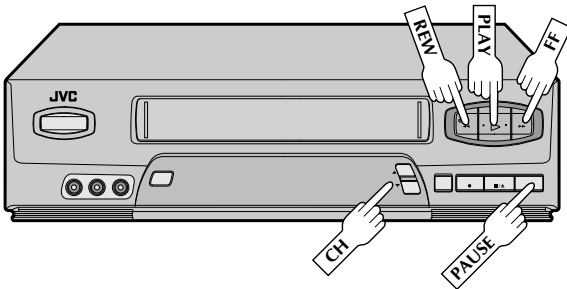

**NOTE:** Refer to the following for the operations described on this page.

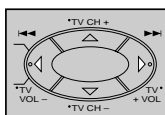

Reverse			Forward		
Reverse search 3 steps	Reverse play	Reverse slow motion 2 steps	Slow motion 2 steps	Play	Forward search 4 steps

## Still Picture/Frame-By-Frame Playback

### 1 PAUSE DURING PLAYBACK

Press **PAUSE**. If there is vertical jitter, use the **CH ▲ (+)** or **▼ (-)** button to correct the picture.

### 2 ACTIVATE FRAME-BY-FRAME PLAYBACK

Press **PAUSE** repeatedly to advance one frame at a time.

**OR**  
Press **SHUTTLE PLUS ►►** repeatedly for forward frame-by-frame playback or **SHUTTLE PLUS ◄◄** repeatedly for reverse frame-by-frame playback.

To resume normal playback, press **PLAY**.

## Slow Motion/Reverse Slow Motion

### 1 ACTIVATE SLOW-MOTION PLAYBACK

For hands-free slow-motion, press and release **SHUTTLE PLUS ◄◄** during playback to decrease speed in the forward direction. Continue to press and release **SHUTTLE PLUS ◄◄** to select the reverse slow motion, reverse play and reverse search modes.

**OR**

During still picture, press and hold **SHUTTLE PLUS ►►** for forward slow motion, or press and hold **SHUTTLE PLUS ◄◄** for reverse slow motion. Release to return to still picture.

**OR**

For forward slow motion during still picture, press and hold **PAUSE** for more than 2 seconds. Press **PAUSE** again to return to still picture.

To resume normal playback, press **PLAY**.

## Variable-Speed Search/Reverse Motion Playback

### 1 ACTIVATE VARIABLE-SPEED SEARCH

During playback, repeatedly press and release **SHUTTLE PLUS ◄◄** or **►►** to select the search speed.

- To increase the speed in the forward direction, press and release **►►** repeatedly to select the various forward search modes.
- To decrease the speed in the forward direction, press and release **◄◄**.
- To play in reverse slow motion, and in reverse play mode, continue to press **◄◄** repeatedly after selecting all the forward slow motion modes.

To resume normal playback, press **PLAY**.

## High-Speed Search

1

### ACTIVATE HIGH-SPEED SEARCH

During playback or still, press **FF** for forward high-speed search, or **REW** for reverse high-speed search. To resume normal playback, press **PLAY**.

#### NOTE:

*For short searches, during playback or still, press and hold **FF** or **REW**. When released, normal playback resumes.*

## Index Search

Index codes are placed on the tape at the start of each recording. You can find and automatically play back from the start of any recording using the Index Search function.

1

### START SEARCH

While the tape is stopped, press **SHUTTLE PLUS** ◀◀ or ▶▶ (◀or▶).

2

### ACCESS DISTANT CODE

To access a recording 2–9 index codes away, press **SHUTTLE PLUS** ◀◀ or ▶▶ (◀or▶) repeatedly until the correct number is displayed on screen (only if "SUPERIMPOSE" is set to "ON" (ⓘ pg. 24). Playback begins automatically when the desired recording is located.

- If necessary press **REW** or **FF** when play starts to search visually to find the very beginning of the desired program.

#### NOTE:

*An index code is not placed on the tape when recording is paused and then resumed.*

## Manual Tracking

Once playback begins, the VCR's automatic tracking function is engaged. If tracking noise appears in the picture, you can override this and make the adjustment manually.

1

### ENGAGE MANUAL TRACKING MODE

During playback, press the **CH▲** and **▼** buttons on the VCR's front panel simultaneously to cancel the automatic tracking mode and enable manual tracking adjust.

2

### ADJUST MANUAL TRACKING

Press **CH▲** (+) or **▼** (–) on the VCR's front panel or remote. Press briefly for fine adjust, or press and hold for coarse adjust. Watch the screen and continue adjusting until optimum picture and sound quality are achieved.

3

### RE-ENGAGE AUTOMATIC TRACKING

Press the **CH▲** and **▼** buttons on the VCR's front panel simultaneously.

- When automatic tracking is re-engaged, Auto Picture is automatically activated.

#### NOTES:

- *To obtain a noiseless still picture it may be necessary to adjust tracking in slow playback and then engage Pause.*
- *Manual tracking is possible during hands-free slow-motion. During hands-free slow-motion playback, simply press **CH▲** (+) or **▼** (–) on the VCR's front panel or remote to adjust tracking.*

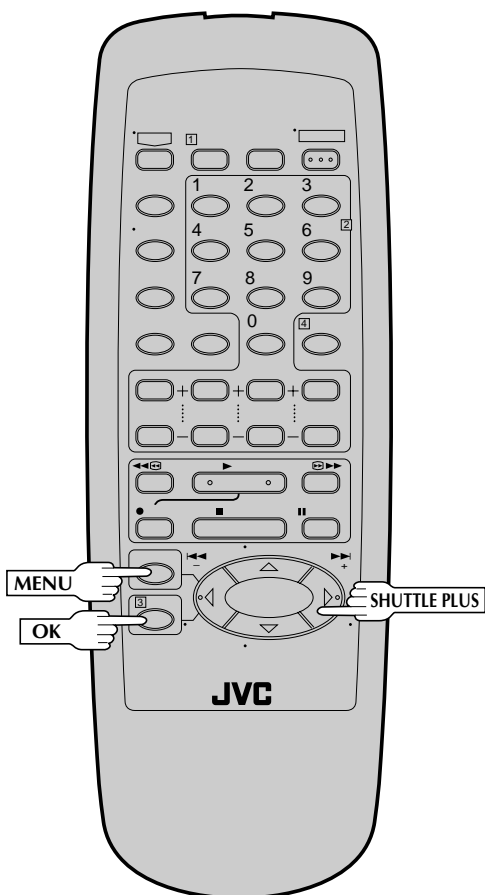
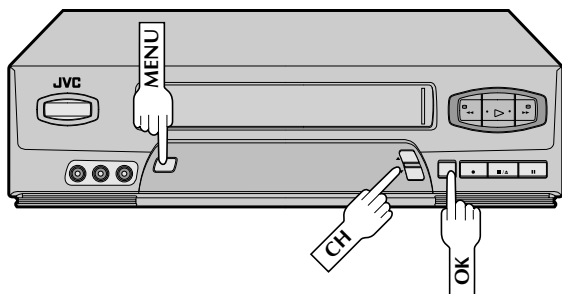

## Auto Picture

Auto Picture checks the condition of the tape during playback, and compensates for poor reproduction to provide the best quality playback pictures. \*The default setting is "ON".

### 1 ACCESS MAIN MENU SCREEN

Press MENU.

### 2 ACCESS FUNCTION SET SCREEN

Press CH▲▼ or SHUTTLE PLUS ▲▼ to move the highlight bar (arrow) to "FUNCTION SET", then press OK or SHUTTLE PLUS ▷.

MAIN MENU	
→	FUNCTION SET
	TUNER SET
	INITIAL SET
PRESS (▲, ▼), THEN (OK)	
PRESS (MENU) TO END	

### 3 SELECT AUTO PICTURE MODE

Press CH▲▼ or SHUTTLE PLUS ▲▼ to move the highlight bar (arrow) to "AUTO PICTURE", then press OK or SHUTTLE PLUS ▷ to set to "ON" or "OFF".

FUNCTION	
→	AUTO PICTURE ON
	PICTURE CONTROL AUTO
	AUTO TIMER OFF
	SUPERIMPOSE ON
	AUTO SP→EP TIMER OFF
	NEXT PAGE
SELECT WITH (▲, ▼) AND (OK)	
PRESS (MENU) TO END	

#### NOTE:

When playing back tapes recorded on this VCR set the Auto Picture to "ON".

When using rental tapes, or tapes recorded on other VCRs, select "ON" or "OFF" as desired to give the best picture.

### 4 RETURN TO NORMAL SCREEN

Press MENU.

#### NOTES:

- The Auto Picture screen only appears at the beginning of automatic tracking. Even though the screen doesn't appear after that, the Auto Picture function is operative.
- To display the Auto Picture screen "SUPERIMPOSE" must be set to "ON" or the Auto Picture screen will not appear (☞ pg. 24).

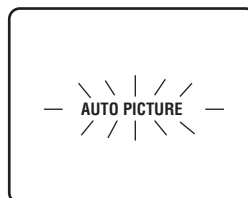

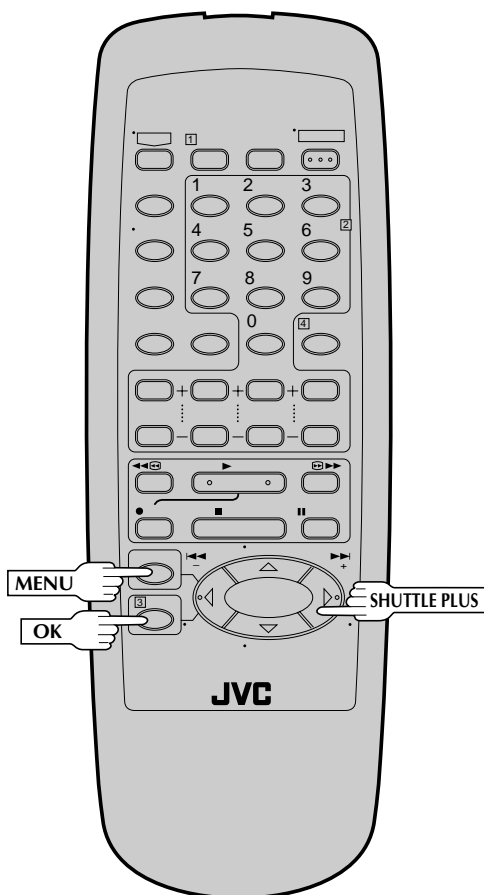
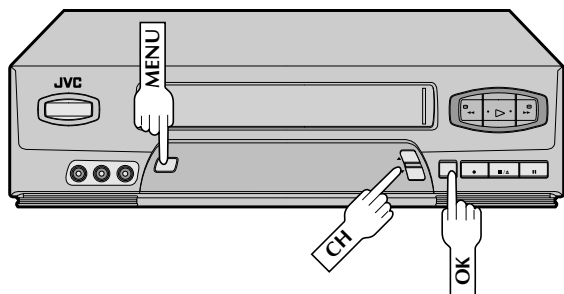

## Picture Control

This feature helps you to adjust the playback picture quality according to your preference. \*The default setting is "AUTO."

### 1 ACCESS MAIN MENU SCREEN

Press **MENU**.

### 2 ACCESS FUNCTION SET SCREEN

Move the highlight bar (arrow) to "FUNCTION SET" by pressing **CH ▲▼** or **SHUTTLE PLUS ▲▼**, then press **OK** or **SHUTTLE PLUS ▷**.

### 3 SELECT PICTURE CONTROL SET MODE

Move the highlight bar (arrow) to "PICTURE CONTROL" by pressing **CH ▲▼** or **SHUTTLE PLUS ▲▼**, then press **OK** or **SHUTTLE PLUS ▷** to select the desired mode.

FUNCTION	
AUTO PICTURE	ON
→ PICTURE CONTROL	AUTO
AUTO TIMER	OFF
SUPERIMPOSE	ON
AUTO SP→EP TIMER	OFF
NEXT PAGE	
SELECT WITH (▲, ▼) AND (OK)	
PRESS (MENU) TO END	

**AUTO\***: Normally select "AUTO".

It automatically adjusts the picture quality.

\* When "AUTO PICTURE" is set to "OFF" (pg. 20), you can only select "NORM" instead of "AUTO".

**EDIT**: Select when you dub tapes.

**SOFT**: Select when you want to soften the picture.

**SHARP**: Select when you want to sharpen the picture.

### NOTE:

- When you select "EDIT", "SHARP" or "SOFT", the selected mode will not change until you select again.
- When you select "EDIT" to dub tapes, be sure to select "AUTO" (or "NORM" when "AUTO PICTURE" is set to "OFF") after you finish dubbing the tapes.

### 4 RETURN TO NORMAL SCREEN

Press **MENU**.

### NOTE:

Select "EDIT" when you are dubbing tapes. Refer to page 33.

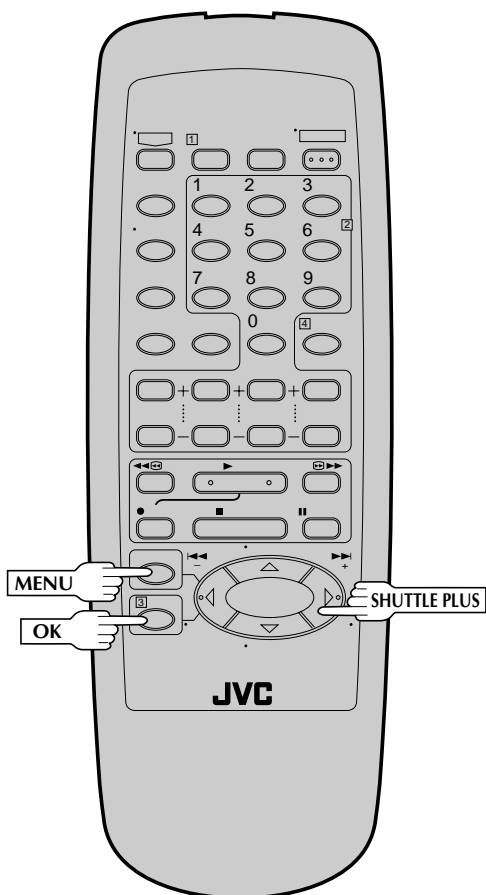
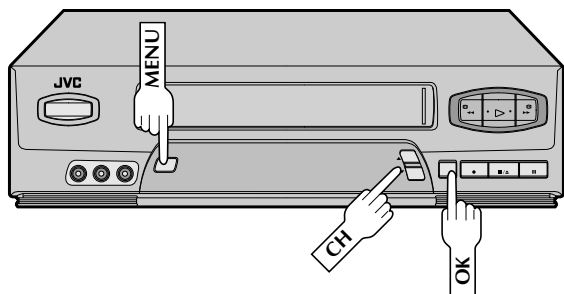

## Video Stabilizer

By activating the Video Stabilizer you can correct vertical vibrations in the picture when playing back unstable recordings that were made on another VCR. When this function is set to "ON", vertical vibration will be automatically corrected. \*The default setting is "OFF".

### 1 ACCESS MAIN MENU SCREEN

Press MENU.

### 2 ACCESS FUNCTION SET SCREEN

Move the highlight bar (arrow) to "FUNCTION SET" by pressing CH▲▼ or SHUTTLE PLUS△▽, then press OK or SHUTTLE PLUS▷.

MAIN MENU	
→ FUNCTION SET	
TUNER SET	
INITIAL SET	
PRESS (▲, ▼), THEN (OK)	
PRESS (MENU) TO END	

### 3 ACTIVATE VIDEO STABILIZER

Move the highlight bar (arrow) to "VIDEO STABILIZER" by pressing CH▲▼ or SHUTTLE PLUS△▽, then press OK or SHUTTLE PLUS▷ to set to "ON".

FUNCTION	
→ AUTO PICTURE	ON
PICTURE CONTROL	AUTO
AUTO TIMER	OFF
SUPERIMPOSE	ON
AUTO SP→EP TIMER	OFF
NEXT PAGE	
SELECT WITH (▲, ▼) AND (OK)	
PRESS (MENU) TO END	



PREVIOUS PAGE	
→ VIDEO STABILIZER	ON
2ND AUDIO RECORD	OFF
AUDIO MONITOR	HI-FI
SELECT WITH (▲, ▼) AND (OK)	
PRESS (MENU) TO END	

### 4 RETURN TO NORMAL SCREEN

Press MENU.

## NOTES:

- When you finish viewing the tape, be sure to set it back to "OFF".
- Regardless of the setting, this function has no effect during recording and during special-effects playback.
- The Superimpose mode indications may jitter vertically when "VIDEO STABILIZER" is set to "ON".
- To watch recordings with close-caption, it is necessary to set the Video Stabilizer function to "OFF".

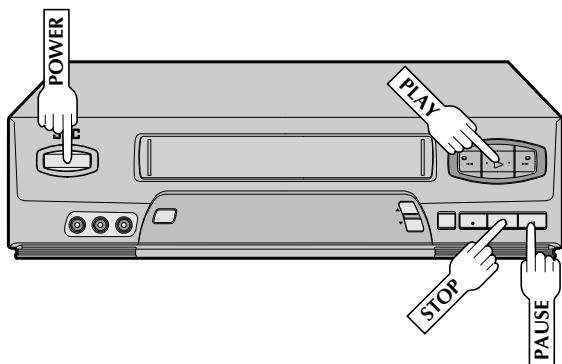

## Repeat Playback

1

### START REPEAT

Press and hold **PLAY** (until "▶" blinks on the front display panel) during playback, then release.



- The entire tape is played back 50 times.

2

### STOP REPEAT

To stop, press **STOP** at any time.

#### NOTE:

Pressing **PLAY**, **REW**, **FF**, **PAUSE** or **SHUTTLE PLUS** ◀◀ or ▶▶ also stops Repeat Playback.

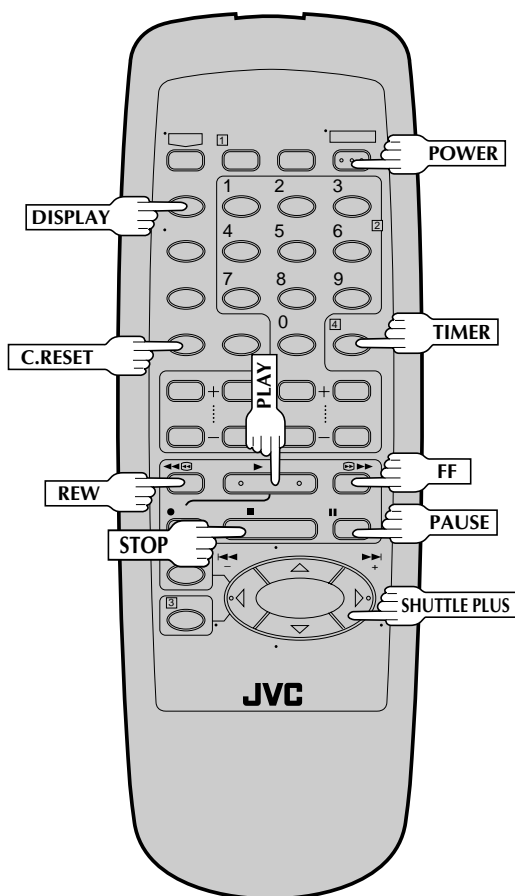

## Counter Reset

1

### RESET COUNTER TO ZERO

Press **C.RESET**.

#### NOTE:

By pressing the **DISPLAY** button, you can change the display to show the counter reading, channel number or clock time. (Channel number is not displayed during playback.)

## Tape Position Indicator

The Tape position indicator appears on screen when, from the stop mode, you press **FF** or **REW**, or perform an Index Search. The position of "■" in relation to "B" (Beginning) or "E" (End) shows you where you are on the tape.

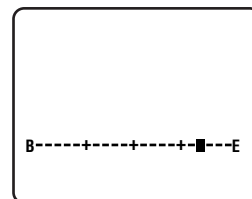

#### NOTES:

- "SUPERIMPOSE" must be set to "ON", or the indicator will not appear (☞ pg. 24).
- It may take a few seconds for the Tape Position Indicator to be displayed.

## Next-Function Memory

The Next Function Memory "tells" the VCR what to do after rewinding. Before continuing, ensure that the VCR is in stop mode.

- a- For Automatic Start Of Playback After Tape Rewind . . .  
 . . . press **REW**, then press **PLAY** within 2 seconds.
- b- For Automatic Power Off After Tape Rewind . . .  
 . . . press **REW**, then press **POWER** within 2 seconds.
- c- For Automatic Timer Standby After Tape Rewind . . .  
 . . . press **REW**, then press **TIMER** within 2 seconds.

#### NOTE:

It is not possible to select the Automatic Timer functions if the cassette's record safety tab is removed.

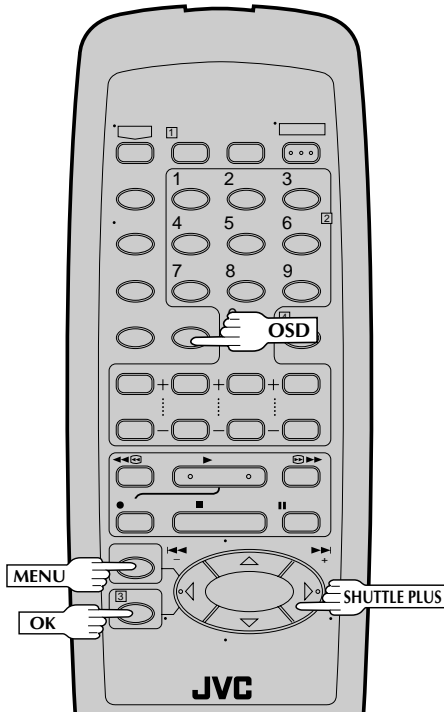
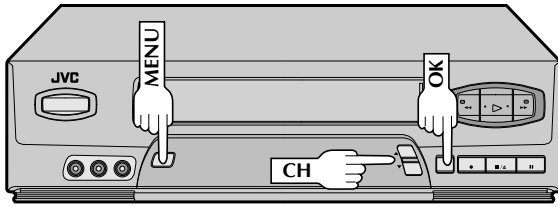

## Superimpose

This function, switchable between ON and OFF, determines whether or not operational indicators will appear on screen.

### 1 ACCESS MAIN MENU SCREEN

Press MENU.

### 2 ACCESS FUNCTION SET SCREEN

Move the highlight bar (arrow) to "FUNCTION SET" by pressing CH▲▼ or SHUTTLE PLUS▲▽, then press OK or SHUTTLE PLUS ▷.

### 3 SELECT SUPERIMPOSE SET MODE

Move the highlight bar (arrow) to "SUPERIMPOSE" by pressing CH▲▼ or SHUTTLE PLUS▲▽, then press OK or SHUTTLE PLUS ▷ to select the desired mode:

FUNCTION	
AUTO PICTURE	ON
PICTURE CONTROL	AUTO OFF
AUTO TIMER	OFF
→ SUPERIMPOSE	ON
AUTO SP→EP TIMER	OFF
NEXT PAGE	
SELECT WITH (▲, ▼) AND (OK)	
PRESS (MENU) TO END	

- a- Select "ON" if you want the superimposed operational indications on the TV screen.
- b- Select "OFF" if you do not want the superimposed operational indications on the screen.

### 4 RETURN TO NORMAL SCREEN

Press MENU.

## NOTES:

- If you engage the Record Pause mode, RECORD/PAUSE is displayed regardless of the Superimpose mode setting.
- If you select a channel on which no signal is received, the channel number is displayed regardless of the Superimpose mode setting.

### To recall an indication

- 1 Press OSD.
  - All indications corresponding to the current status are displayed for 5 seconds. After that, the counter information and RECORD/PAUSE if in the Record Pause mode, are left displayed on the screen.
- 2 Press OSD again to clear the display.
  - The RECORD/PAUSE indication is left displayed on the screen.

### The superimposed indication on the TV screen tells you what the VCR is doing.

**Tuned-in channel or AUX(iliary) mode**  
When the channel is changed, the new channel is displayed on the screen for 5 seconds.

**Clock time**

**Stereo program indication**

**Second Audio Program indication**

**Tape position indicator**

**Audio mode indications**

**Counter reading**

**Operation mode**

When the operation mode is changed, the new mode is displayed — RECORD (5 sec.), PLAY (5 sec.), FF/REW (5 sec. when engaged from Stop mode), RECORD PAUSE (for as long as Pause is engaged), and ITR \*.\* (5 sec.).

**Tape speed indication**

**"Cassette Loaded" mark**

When a cassette is loaded, the mark is displayed for 5 seconds. It blinks when the VCR's EJECT button is pushed.

**INDEX indication**

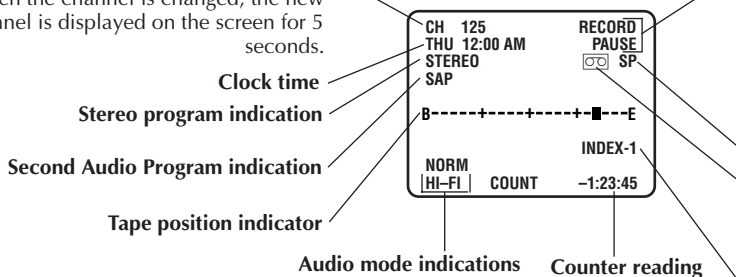



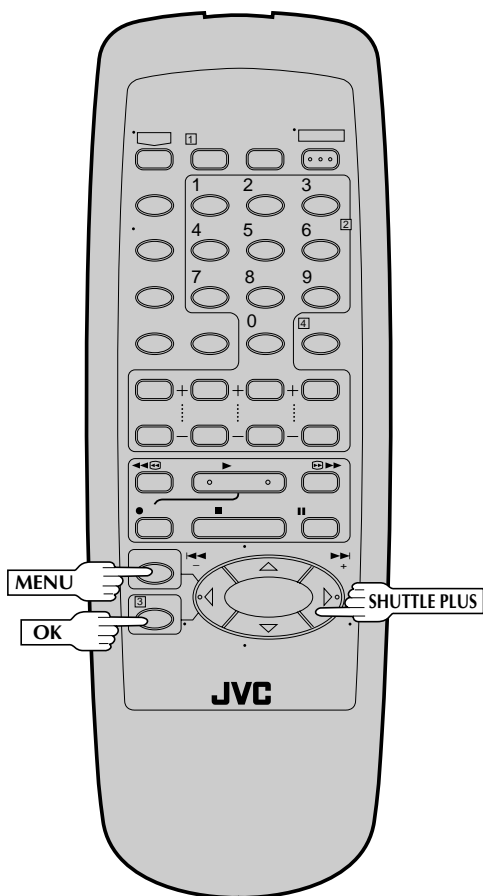
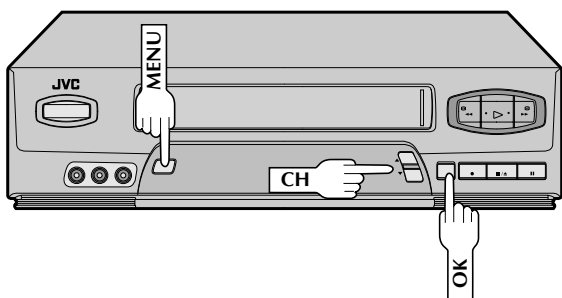

## Select The Soundtrack

Your VCR can record two soundtracks simultaneously (Normal and Hi-Fi) and play back the selected one, or both together. Or, when viewing a pre-recorded tape that contains two separate Hi-Fi audio programs, you can choose to listen to either one by selecting either "Hi-Fi L" or "Hi-Fi R" in step 3.

### 1 ACCESS MAIN MENU SCREEN

Press **MENU**.

### 2 ACCESS FUNCTION SET SCREEN

Move the highlight bar (arrow) to "FUNCTION SET" by pressing **CH▲▼** or **SHUTTLE PLUS▲▼**, then press **OK** or **SHUTTLE PLUS▷**.

### 3 SELECT AUDIO MONITOR SET MODE

Move the highlight bar (arrow) to "AUDIO MONITOR" by pressing **CH▲▼** or **SHUTTLE PLUS▲▼**, then press **OK** or **SHUTTLE PLUS▷** to select the desired mode:

- a- Hi-Fi
- b- Hi-Fi L
- c- Hi-Fi R
- d- Normal
- e- Mix

FUNCTION	
→AUTO PICTURE	ON
PICTURE CONTROL	AUTO
AUTO TIMER	OFF
SUPERIMPOSE	ON
AUTO SP→EP TIMER	OFF
NEXT PAGE	
SELECT WITH (▲, ▼) AND (OK)	
PRESS (MENU) TO END	



PREVIOUS PAGE	
VIDEO STABILIZER	ON
2ND AUDIO RECORD	OFF
→AUDIO MONITOR	HI-FI
SELECT WITH (▲, ▼) AND (OK)	
PRESS (MENU) TO END	

### 4 RETURN TO NORMAL SCREEN

Press **MENU**.

## NOTES:

- If the tape being played back has no Hi-Fi soundtrack, the Normal soundtrack will be heard no matter what choice you make in step 3.
- If RF connection is used for TV, even if Hi-Fi audio monitor is selected the sound will be mono and will be reproduced in both loudspeakers.

# Recording Features

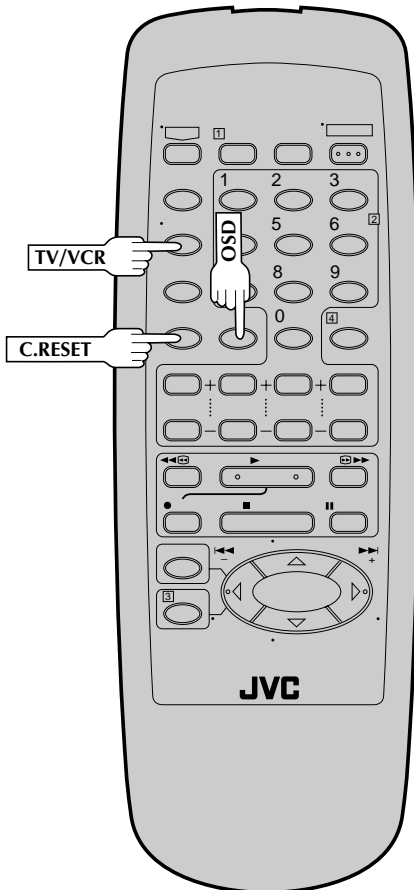

## Record One Program While Watching Another

### 1 ENGAGE TV MODE

During recording...

- Press **TV/VCR**. The VCR's VCR indicator goes out. (If you are using the RF connection (☞ pg. 6) to view the output from your VCR, the TV broadcast being recorded disappears.)
- If you are using the AV connection (☞ pg. 6) to view the output from your VCR, change the TV's input mode from AV to TV.

### 2 SELECT CHANNEL FOR VIEWING

Use the TV's channel selector to set the channel you want to watch.

## Display Elapsed Recording Time

### 1 RESET COUNTER TO ZERO

Before recording starts, press **C.RESET**. The counter resets to zero and displays the exact elapsed time as the tape runs.

### 2 DISPLAY ELAPSED TIME ON SCREEN

During recording, press **OSD** at any time to see the elapsed time.

All indications corresponding to the current status of the VCR are displayed for 5 seconds. The counter display remains on the screen indicating the elapsed time. Press **OSD** again to remove the display.

- Make sure "SUPERIMPOSE" is set to "ON" (☞ pg. 24).
- The indications are not recorded.

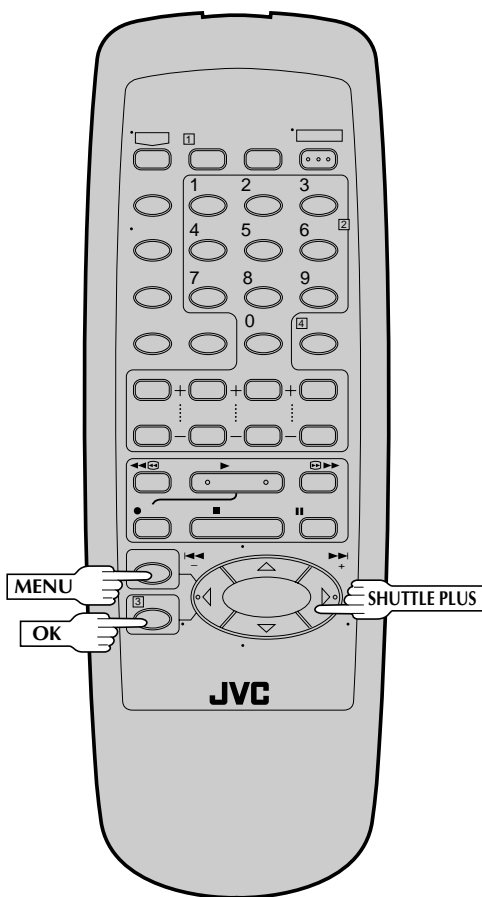
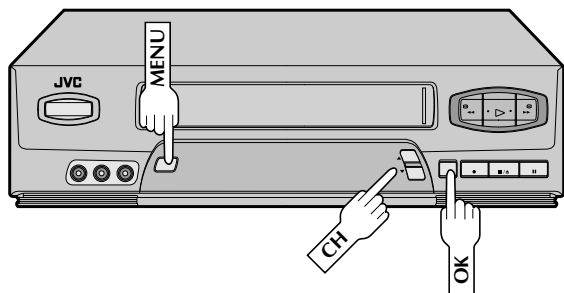

## Stereo And SAP (Second Audio Program)

Your VCR's built-in MTS decoder enables reception of Multi-channel TV Sound broadcasts.

When the channel is changed...

- The "STEREO" indication appears on the screen for about 5 seconds if the program is a stereo broadcast.
- The "SAP" indication appears on the screen for about 5 seconds if the program is an SAP broadcast.
- Both indications appear when a stereo program is accompanied by SAP audio.

### To Record Stereo Programs . . .

. . . simply follow the basic recording procedure.

### To Listen To Stereo Soundtrack During Recording . . .

. . . set "AUDIO MONITOR" to "HI-FI" at the Function screen (see pg. 25).

## To Record SAP Programs . . .

### 1 ACCESS MAIN MENU SCREEN

Press MENU.

### 2 ACCESS FUNCTION SET SCREEN

Move the highlight bar (arrow) to "FUNCTION SET" by pressing CH▲▼ or SHUTTLE PLUS▲▽, then press OK or SHUTTLE PLUS▷.

### 3 SELECT 2ND AUDIO RECORD SET MODE

Move the highlight bar (arrow) to "2ND AUDIO RECORD" by pressing CH▲▼ or SHUTTLE PLUS▲▽, then press OK or SHUTTLE PLUS▷ to set to "ON".

FUNCTION	
→AUTO PICTURE	ON
PICTURE CONTROL	AUTO
AUTO TIMER	OFF
SUPERIMPOSE	ON
AUTO SP→EP TIMER	OFF
NEXT PAGE	
SELECT WITH (▲,▽) AND (OK)	
PRESS (MENU) TO END	



PREVIOUS PAGE	
VIDEO STABILIZER	ON
→2ND AUDIO RECORD	ON
AUDIO MONITOR	HI-FI
SELECT WITH (▲,▽) AND (OK)	
PRESS (MENU) TO END	

### 4 RETURN TO NORMAL SCREEN

Press MENU.

## NOTES:

- If a SAP program is received and "2ND AUDIO RECORD" is set to "ON", the SAP audio is recorded on both the Normal and Hi-Fi tracks. The main audio program is not recorded.
- If a non-SAP program is received, the main audio is recorded on both the Hi-Fi and Normal audio tracks.

# Express Timer Programming

Turn on the TV and select the VCR channel 3 or 4 (or AV mode).

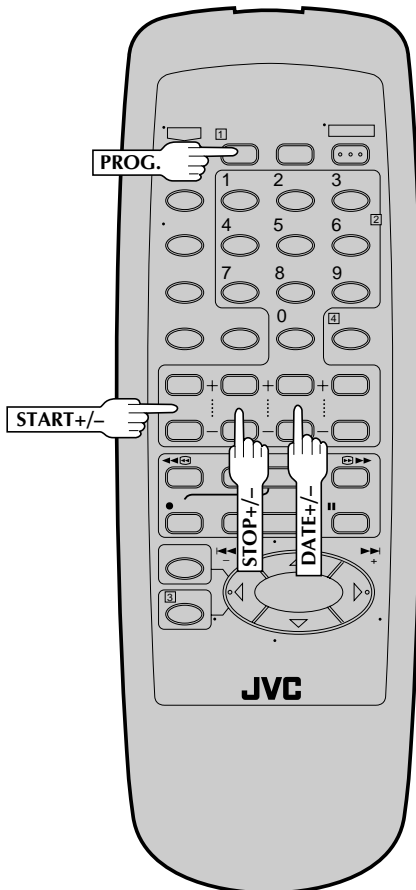
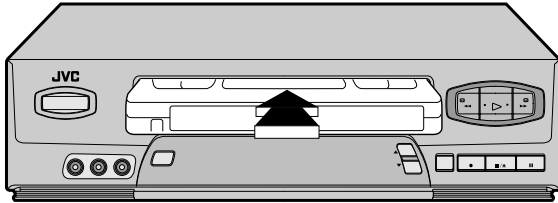

You can directly program the VCR's timer to record up to 8 shows, as far as a year in advance. Remember, the clock must be set before you can program the timer (pg. 8 or 11).

1

## LOAD A CASSETTE

Make sure the record safety tab is intact. If not, cover the hole with adhesive tape, then load it into the VCR.

- The VCR comes on, and the counter is reset, automatically.

2

## ACCESS VCR PLUS+ SCREEN

Press **PROG.**

3

## ACCESS PROGRAM SCREEN

Press **START +/-**. (If you're just starting out, "PROGRAM 1" appears.)

PROGRAM 1	
START	STOP
--:--AM → --:--AM	
DATE	CH
--/--	---
PRESS (+/-, SP/EP, 8=DAILY, 9=WEEKLY), THEN (OK)	
PRESS (PROG.) TO END	

4

## SET PROGRAM START TIME

Press **START +/-** to enter the time you want recording to start.

- Press and hold **START +/-** to move in 30-minute increments, or press and release repeatedly to move 1 minute at a time.

PROGRAM 1	
START	STOP
8:00 AM → --:--AM	
DATE	CH
--/--	---
PRESS (+/-, SP/EP, 8=DAILY, 9=WEEKLY), THEN (OK)	
PRESS (PROG.) TO END	

5

## SET PROGRAM STOP TIME

Press **STOP +/-** to enter the time you want recording to stop.

- Press and hold **STOP +/-** to move in 30-minute increments, or press and release repeatedly to move 1 minute at a time.

6

## SET PROGRAM DATE

Press **DATE +/-**. (The current date is displayed on screen. The date you enter appears in its place.)

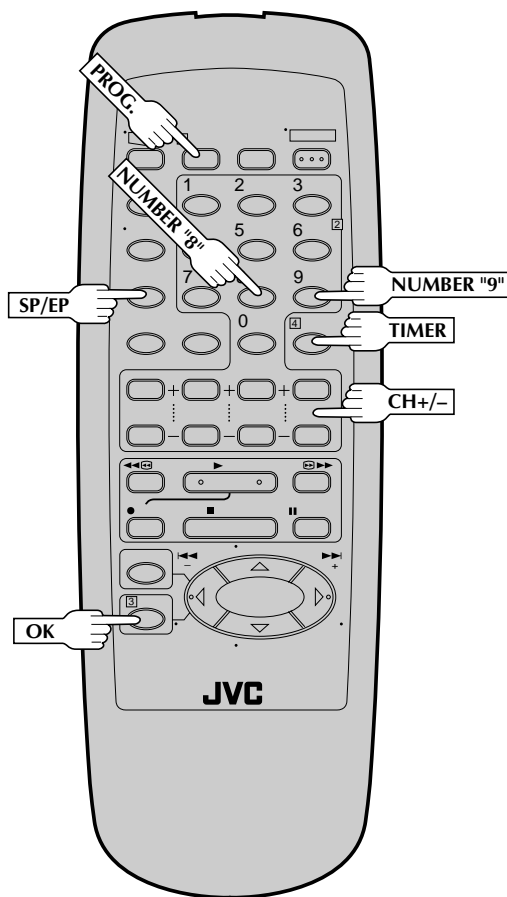

## 7 SET CHANNEL NUMBER

Press **CH +/-**.

- Holding down **CH +/-** rapidly scans through the channels.
- If you are using a cable box, enter the cable box channel, not the channel to be recorded. The channel to be recorded must be selected on the cable box. (The cable box channel is the VCR's channel that displays the channels received by the cable box.)
- To timer-record cable or DBS channels through an external tuner connected to the VCR's external input connectors, press the **NUMBER** key "0" so that "F-1" appears instead of a channel number.

## 8 SET TAPE SPEED

Press **SP/EP** to set the tape speed.

## 9 RETURN TO NORMAL SCREEN

Press **PROG.** or **OK**. "PROGRAM COMPLETED" appears on the screen for about 5 seconds, then normal screen appears.

## 10 ENGAGE TIMER MODE

Press **TIMER**. The VCR turns off automatically and "⊕" is displayed on the display panel.

*To Timer-Record Weekly Or Daily Serials . . .*  
 . . . anytime during steps 3 through 9, press **WEEKLY** (**NUMBER** key "9") for weekly serials or **DAILY** (**NUMBER** key "8") for daily serials (Monday–Friday). Either "WEEKLY" or "DAILY" appears on the screen. Pressing the button again makes the corresponding indication disappear.

### ATTENTION

If there is a conflict in the timer schedule and one program overlaps with another, only the parts shown below in gray will be recorded.

**Pattern 1:** The program with the lower program number will be recorded.

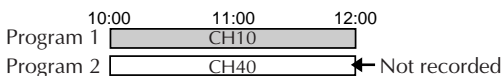

**Pattern 2:** The program that is broadcast earlier will be recorded.

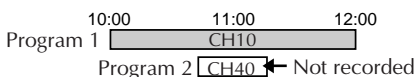

**Pattern 3:** The program that is broadcast earlier will be recorded, followed by the remaining portion of the other program.

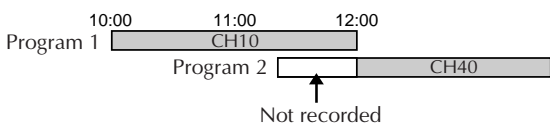

### NOTES:

- To disengage the timer before recording starts, press **TIMER** again. Pressing once more re-engages it.
- In case of a power failure after programming, the VCR's memory backup keeps your selections for approximately 3 minutes.
- Programs that start after midnight must have the next day's date.
- After timer recording is completed, the VCR's power goes off automatically.
- You can program the timer while a regular recording is in progress; the on-screen menu will not be recorded.
- If the end of tape is reached during timer recording, the cassette is automatically ejected.
- When timer-recording cable or satellite channels through an external tuner, be sure to keep the cable box or satellite receiver's power ON.

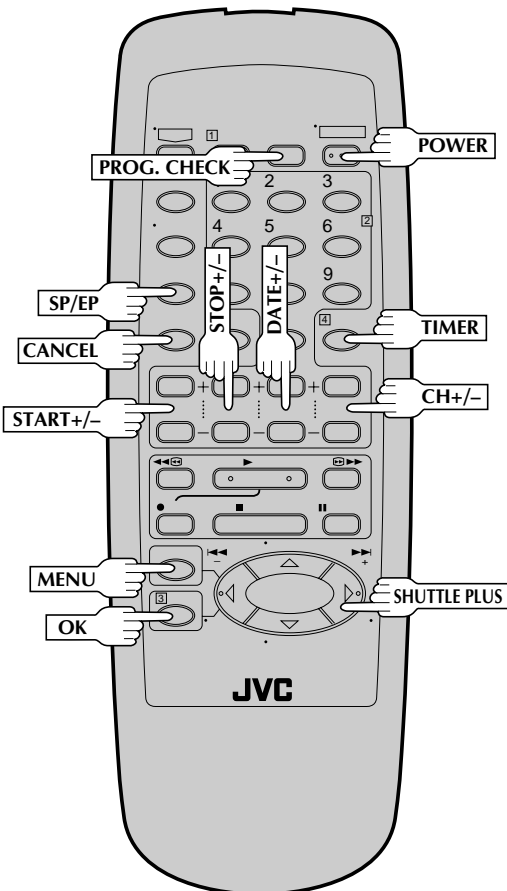
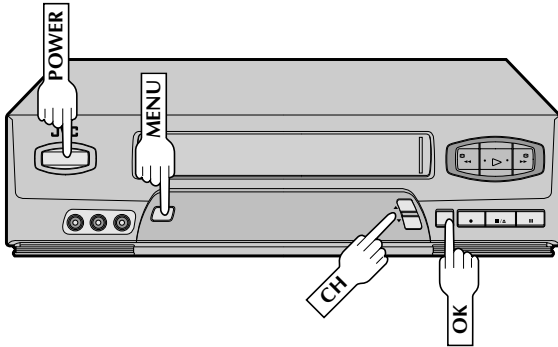

## Check, Cancel And Revise Programs

### 1 DISENGAGE TIMER

Press **TIMER**, then press **POWER**.

### 2 ACCESS PROGRAM CHECK SCREEN

Press **PROG. CHECK**.

PR	START	STOP	CH	DATE
1	8:00P	10:00	12	12/24
2	10:00A	10:45	40	12/25
3	11:30P	1:00	125	12/25
4				
5				
6				
7				
8				

PRESS (CHECK) TO NEXT

### 3 ACCESS PROGRAM SCREEN

Press **PROG. CHECK** again to check more information. Each time you press **PROG. CHECK**, the next program's information appears.

## To Cancel Or Revise A Program...

### 4 CANCEL OR REVISE A PROGRAM

To cancel a program, press **CANCEL**.  
To revise a program, press the appropriate button: **START+/-**, **STOP+/-**, **DATE+/-**, **CH+/-**, **SP/EP**.

### 5 RETURN TO NORMAL SCREEN

Press **PROG. CHECK** as many times as necessary. If there are still programs remaining, go to step 6.

### 6 RE-ENGAGE TIMER

Press **TIMER**.

## Auto SP→EP Timer

If, when recording in SP mode, there is not enough tape to record the entire program, the VCR automatically switches to EP mode to allow complete recording. This feature is especially handy when recording a program of more than 2 hours in length.

### For Example . . .

Recording a program of 140 minutes in length onto a 120-minute tape

Approximately 110 minutes      Approximately 30 minutes

SP mode	EP mode
---------	---------

Total 140 minutes

Make sure you set "AUTO SP→EP TIMER" to "ON" at the Function screen before the timer recording starts.

### 1 ACCESS MAIN MENU SCREEN

Press **MENU**.

### 2 ACCESS FUNCTION SET SCREEN

Move the highlight bar (arrow) to "FUNCTION SET" by pressing **CH ▲▼** or **SHUTTLE PLUS ▲▽**, then press **OK** or **SHUTTLE PLUS ▷**.

### 3 SELECT AUTO SP→EP TIMER SET MODE

Move the highlight bar (arrow) to "AUTO SP→EP TIMER" by pressing **CH ▲▼** or **SHUTTLE PLUS ▲▽**, then press **OK** or **SHUTTLE PLUS ▷** to set to "ON".

FUNCTION	
AUTO PICTURE CONTROL	ON
PICTURE CONTROL	AUTO
AUTO TIMER	OFF
SUPERIMPOSE	ON
→ AUTO SP→EP TIMER	ON
NEXT PAGE	
SELECT WITH (▲, ▼) AND (OK)	
PRESS (MENU) TO END	

### 4 RETURN TO NORMAL SCREEN

Press **MENU**.

## NOTES:

- If you have programmed the VCR to timer-record 2 or more programs, the second program and those thereafter may not fit on the tape if you set the Auto SP→EP Timer mode to "ON". In this case, make sure the mode is not engaged, then set the tape speed manually during timer programming.
- In order to ensure that the recording fits on the tape, this feature may leave a slight non-recorded section at the end of the tape.
- There may be some noise at the point on the tape where the VCR switches from SP to EP mode.
- The Auto SP→EP Timer feature is not available during ITR (Instant Timer Recording), and the feature will work with the following tapes: T(ST)-30, T(ST)-60, T(ST)-90, and T(ST)-120.

## Auto Timer

When the Auto Timer is set to "ON" the timer is automatically engaged when the VCR's power is turned off. It is automatically disengaged when the VCR is powered back on.

### 1 ACCESS MAIN MENU SCREEN

Press **MENU**.

### 2 ACCESS FUNCTION SET SCREEN

Move the highlight bar (arrow) to "FUNCTION SET" by pressing **CH ▲▼** or **SHUTTLE PLUS ▲▽**, then press **OK** or **SHUTTLE PLUS ▷**.

### 3 SELECT AUTO TIMER SET MODE

Move the highlight bar (arrow) to "AUTO TIMER" by pressing **CH ▲▼** or **SHUTTLE PLUS ▲▽**, then press **OK** or **SHUTTLE PLUS ▷** to set to "ON" or "OFF".

FUNCTION	
AUTO PICTURE CONTROL	ON
PICTURE CONTROL	AUTO
→ AUTO TIMER	OFF
SUPERIMPOSE	ON
AUTO SP→EP TIMER	ON
NEXT PAGE	
SELECT WITH (▲, ▼) AND (OK)	
PRESS (MENU) TO END	

### 4 RETURN TO NORMAL SCREEN

Press **MENU**.

## NOTE:

For safety, when AUTO TIMER is set to "OFF", all other VCR functions are disabled while the Timer mode is engaged. To disengage the timer, press **TIMER**.

# Instant Timer Recording (ITR)

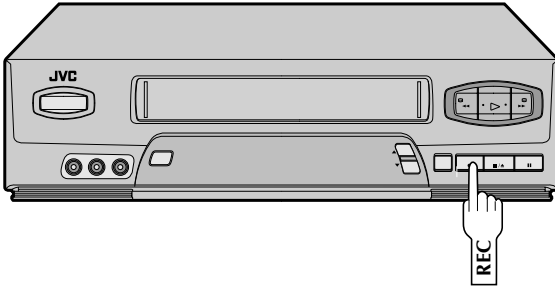

This easy method lets you record from 30 minutes to 6 hours (selectable in 30-min. increments) and shuts the VCR off after recording is finished.

## 1 START RECORDING

Press **REC** on the front panel.

## 2 ENGAGE ITR MODE

Press **REC** again. "  " blinks and 0:30 appears on the front display panel.

## 3 SET RECORDING DURATION

If you want to record for more than 30 minutes, press **REC** to extend the time. Each press extends recording time by 30 minutes.

### NOTES:

- You can only perform ITR using the **REC** button on the VCR's front panel.
- After you set the ITR time, the previous display reappears.
- To check the remaining time, press **REC** once during recording and the remaining time will be displayed for about 5 seconds. Be careful not to press **REC** again within these 5 seconds, or you will round the recording time up to the next 30 minute increment.



# Edit To Another VCR

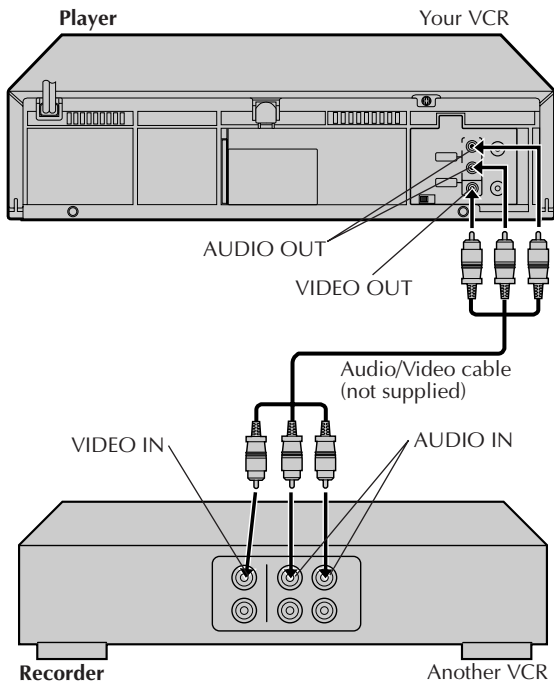

You can use your VCR as the player and another VCR as the recorder.

## 1 MAKE CONNECTIONS

Connect an AV cable between your VCR's VIDEO OUT and AUDIO OUT connectors and another VCR's VIDEO IN and AUDIO IN connectors.

- When connecting to a monaural VCR, connect your VCR's AUDIO OUT L connector to the AUDIO IN connector on the monaural VCR.

## 2 LOAD CASSETTES

Insert the playback cassette into your VCR and the cassette to be recorded on into the other VCR.

## 3 SET RECORDER'S INPUT MODE

Set the other VCR's auxiliary (AV) input mode.

## 4 SELECT "EDIT" FOR PICTURE CONTROL SET MODE

Follow the "Picture Control" section on page 21, then select "EDIT."

### NOTE:

When you select "EDIT" to dub tapes, be sure to select AUTO or (NORM when AUTO PICTURE is set to OFF) after you finish dubbing the tapes.

## 5 START PLAYER

Set to its play mode.

### NOTE:

If the player is equipped with a superimpose/OSD disable feature then set "SUPERIMPOSE" to OFF before pressing **PLAY** (→ pg. 24).

## 6 START RECORDER

Set to its record mode.

# Edit From A Camcorder Or Another VCR

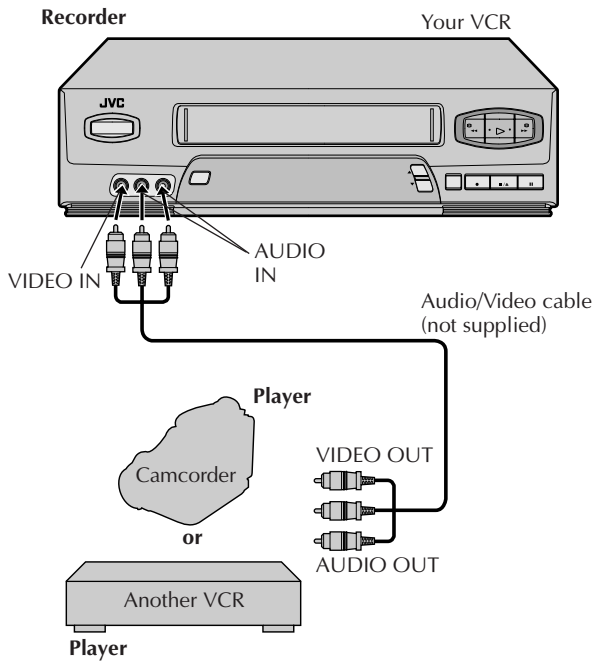

You can use a camcorder or another VCR as the player and your VCR as the recorder.

## 1

### MAKE CONNECTIONS

Connect an AV cable between the camcorder's or the playback VCR's VIDEO OUT and AUDIO OUT connectors and your VCR's VIDEO IN and AUDIO IN connectors.

- When using a monaural camcorder or a monaural VCR, connect its AUDIO OUT connector to the AUDIO IN L connector on your VCR.

## 2

### LOAD A CASSETTE

Insert the cassette to be recorded on into your VCR and the playback cassette into the camcorder or the playback VCR.

## 3

### SELECT "EDIT" FOR PICTURE CONTROL SET MODE

Follow the "Picture Control" section on page 21, then select "EDIT."

#### NOTE:

When you select "EDIT" to dub tapes, be sure to select AUTO or (NORM when AUTO PICTURE is set to OFF) after you finish dubbing the tapes.

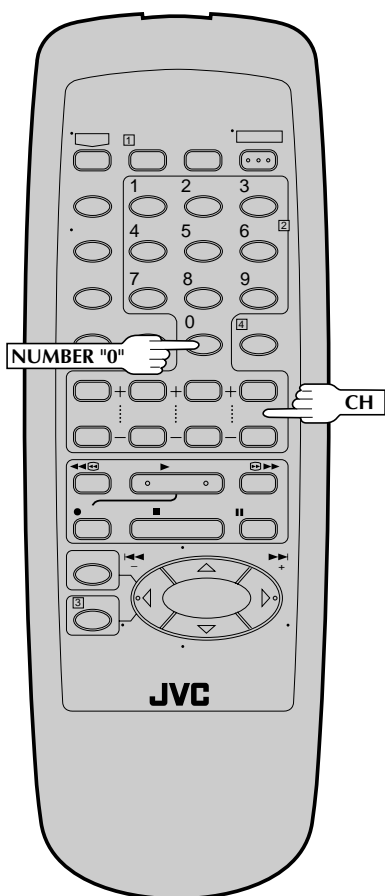
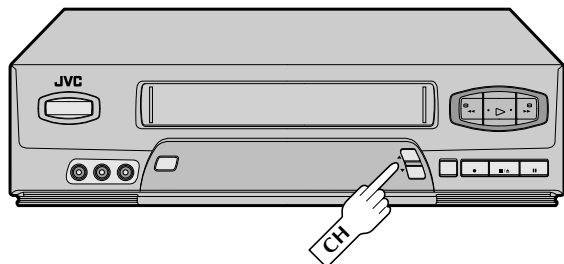

## 4 SET RECORDER'S INPUT MODE

Set to "AUX". Press the **NUMBER** key "0" and/or **CH** to select "F-1".

## 5 START PLAYER

Set the camcorder to its play mode.

### NOTE:

*If the camcorder is equipped with a superimpose/OSD disable feature then set its superimpose or display feature to OFF before pressing play.*









## 6 START RECORDER

Set your VCR to its record mode.



Before requesting service for a problem, use this chart and see if you can repair the trouble yourself. Small problems are often easily corrected, and this can save you the trouble of sending your VCR off for repair.

<b>POWER</b>		
<b>SYMPTOM</b>	<b>POSSIBLE CAUSE</b>	<b>CORRECTIVE ACTION</b>
1. The power won't come on.	<ul style="list-style-type: none"> <li>The power cord is disconnected.</li> </ul>	Connect the power cord.
2. The clock works, but the VCR's power won't come on.	<ul style="list-style-type: none"> <li>The TIMER mode is engaged with Auto Timer set to "OFF" (☞ pg. 31).</li> </ul>	Press <b>TIMER</b> to disengage.
3. The remote control won't function.	<ul style="list-style-type: none"> <li>The batteries are discharged.</li> </ul>	Replace the dead batteries with new ones.
<b>TAPE TRANSPORT</b>		
<b>SYMPTOM</b>	<b>POSSIBLE CAUSE</b>	<b>CORRECTIVE ACTION</b>
1. The cassette gets stuck partway during loading, and is ejected.	<ul style="list-style-type: none"> <li>The cassette was inserted incorrectly.</li> </ul>	Make sure the cassette's window is facing up, the rear label side is facing you and the arrow on the front of the cassette is pointing towards the VCR. Then insert the cassette.
<b>PLAYBACK</b>		
<b>SYMPTOM</b>	<b>POSSIBLE CAUSE</b>	<b>CORRECTIVE ACTION</b>
1. The tape is running but the picture won't appear.	<ul style="list-style-type: none"> <li>If you're using the RF OUT connection (☞ pg. 6), the channel selector on the TV is set incorrectly.</li> <li>If you're using the AV connection (☞ pg. 6), the TV receiver is set to the wrong mode.</li> </ul>	Set the channel selector to channel 3 or 4.  Set the TV receiver to its AV mode.
2. Noise appears during visual search.	<ul style="list-style-type: none"> <li>This is normal.</li> </ul>	
3. Breaks are noticeable in Hi-Fi soundtrack.	<ul style="list-style-type: none"> <li>Automatic tracking is engaged.</li> </ul>	Disengage Auto Tracking and adjust the tracking manually (☞ pg. 19).
4. The playback picture is blurred or interrupted, even though TV broadcasts are clear.	<ul style="list-style-type: none"> <li>The video heads may be dirty.</li> </ul>	The heads must be cleaned. Consult your JVC dealer.
5. The Hi-Fi soundtrack cannot be heard.	<ul style="list-style-type: none"> <li>The AUDIO MONITOR option was set incorrectly.</li> </ul>	Set AUDIO MONITOR to "HI-FI" (☞ pg. 25).
<b>RECORDING</b>		
<b>SYMPTOM</b>	<b>POSSIBLE CAUSE</b>	<b>CORRECTIVE ACTION</b>
1. Recording won't start.	<ul style="list-style-type: none"> <li>There's no cassette loaded.</li> <li>The loaded cassette has had its record safety tab removed.</li> </ul>	Insert a cassette. Remove the cassette and cover the hole with adhesive tape, or load a cassette on which the record safety tab is intact.
2. TV broadcasts won't record properly.	<ul style="list-style-type: none"> <li>The VCR has been set to its AUX mode by mistake.</li> </ul>	Set the VCR to the appropriate channel.
3. Tape-to-tape editing won't work.	<ul style="list-style-type: none"> <li>The VCRs or the camcorder and the VCR have been incorrectly connected.</li> <li>The power to one or more of the units has not been turned on.</li> <li>The recorder's input mode has been set incorrectly.</li> </ul>	Refer to the directions and the illustration under "Edit To Another VCR" (☞ pg. 33) or "Edit From A Camcorder Or Another VCR" (☞ pg. 34) and properly connect the units. Make sure the power to all units is on.  Select the recorder's appropriate input mode.

## TIMER RECORDING

SYMPTOM	POSSIBLE CAUSE	CORRECTIVE ACTION
1. Timer recording won't work.	<ul style="list-style-type: none"> <li>• The clock and/or the timer have been set incorrectly.</li> <li>• The timer is not engaged.</li> <li>• The VCR has not been set up properly.</li> </ul>	<p>Set the clock and/or timer correctly.</p> <p>Press <b>TIMER</b> and check to make sure that  appears on the front display panel.</p> <p>Re-perform the set-up procedures.</p>
2. Timer programming won't work.	<ul style="list-style-type: none"> <li>• Timer recording is in progress.</li> </ul>	<p>Timer programming can't be performed when timer recording is in progress. Wait until it finishes.</p>
3.  and  on the front display panel won't stop blinking.	<ul style="list-style-type: none"> <li>• The timer is engaged but there's no cassette loaded.</li> </ul>	<p>Load a cassette with the record safety tab intact, or with the hole covered with adhesive tape.</p>
4. The cassette is automatically ejected, and  and  on the front display panel won't stop blinking.	<ul style="list-style-type: none"> <li>• The loaded cassette has had its record safety tab removed.</li> </ul>	<p>Remove the cassette and cover its hole with adhesive tape, or replace it with a cassette on which the safety tab is intact.</p>
5.  blinks for 10 seconds and the timer mode is disengaged.	<ul style="list-style-type: none"> <li>• <b>TIMER</b> has been pressed when there are no programs in memory, or the timer record program information has not been programmed correctly.</li> </ul>	<p>Check the programmed data and re-program as necessary, then press <b>TIMER</b> again.</p>
6. The cassette is automatically ejected, the power shuts off and  and  won't stop blinking.	<ul style="list-style-type: none"> <li>• The end of tape was reached during timer recording.</li> </ul>	<p>The program may not have been recorded in its entirety. Next time make sure you have enough time on the tape to record the entire program.</p>
7. "PROGRAM FULL" is displayed on the screen.	<ul style="list-style-type: none"> <li>• All 8 programs of the VCR's timer memory are used.</li> </ul>	<p>Wait until a space in memory clears, or cancel unnecessary program information ( pg. 30).</p>

## OTHER PROBLEMS

SYMPTOM	POSSIBLE CAUSE	CORRECTIVE ACTION
1. When scanning channels, some of them are skipped over.	<ul style="list-style-type: none"> <li>• Those channels have been preset to be skipped.</li> </ul>	<p>If you need the skipped channels, restore them ( pg. 15).</p>
2. The channel can't be changed.	<ul style="list-style-type: none"> <li>• Recording is in progress.</li> </ul>	<p>Press <b>PAUSE</b> to pause the recording, change channels, then press <b>PLAY</b> to resume recording.</p>
3. Even though Auto or Semi-Auto clock setting has been selected, the clock is incorrect.	<ul style="list-style-type: none"> <li>• The clock setting data received from the Host Channel is incorrect.</li> </ul>	<p>Select a different Host Channel during the Semi-Auto setting procedure ( pg. 12), or perform the Manual setting procedure ( pg. 13).</p>

### ATTENTION:

This VCR contains microcomputers. External electronic noise or interference can cause microcomputer to malfunction. If the VCR does not operate correctly switch its power off and unplug the power cord from the AC supply. Wait for a while and then plug the power back in. Eject and check the condition of the cassette. If everything appears normal resume operating the VCR as usual.

**PLAYBACK**

**Q. What happens if the end of the tape is reached during playback or search?**

A. The tape is automatically rewound to the beginning.

**Q. Can the VCR indefinitely remain in the still mode?**

A. No. It stops automatically after 5 minutes to protect the heads.

**Q. During search, slow, still and frame-by-frame playback, I can't hear any audio. What's the problem?**

A. This is normal.

**Q. During search, still and frame-by-frame playback, the picture is intermittent. What's the cause?**

A. Picture loss occurs when these types of playback are attempted with a tape recorded in LP mode. Pressing **PLAY** to return to normal playback will restore the picture.

**Q. When returning from multi-speed search to normal playback, the picture is disturbed. Should I be concerned about this?**

A. No, it is normal.

**Q. Noise bars appear during multi-speed search. What's the problem?**

A. This is normal.

**Q. When playing back programs that have been timer-recorded with consecutive times (such one program from 8:00 to 9:00 and another one from 9:00 to 10:00), the picture and sound become momentarily distorted at the point where the first program ends and the second program begins. Is this a malfunction?**

A. No. This is normal.

**Q. Other than preventing further recording, what effect does removing the safety tab have?**

A. It disables marking of index codes.

**Q. Sometimes, during Index Search, the VCR can't find the program I want to see. Why not?**

A. There may be index codes too close together.

**Q. During playback, on-screen operational indicators sometimes jitter. Why does this happen?**

A. If the condition of the tape being played back is not good, jittering of the video (including on-screen indicators) may occur.

**RECORDING**

**Q. When I pause and then resume a recording, the end of the recording before the pause is overlapped by the new recording. Why does this happen?**

A. This is normal. It reduces distortion at the pause and resume points.

**Q. Can the VCR indefinitely remain in the Record-Pause mode?**

A. No. The VCR automatically goes to its Stop mode after 5 minutes to protect the heads. When paused during Instant Timer Recording (ITR), the VCR shuts off automatically after 5 minutes.

**Q. What happens if the tape runs out during recording?**

A. The VCR automatically rewinds it to the beginning.

**TIMER RECORDING**

**Q. REC and ⊖ remain lit on the front display panel. Is there a problem?**

A. No. This is a normal condition for a timer recording in progress.

**Q. Can I program the timer while I'm watching a tape or a TV broadcast?**

A. Yes, but while you are setting the timer you won't see the tape's or broadcast program's picture as it is replaced by the on-screen menu. The audio from the tape or broadcast program will be present during the setting of the timer.

## List Of Terms

This guide serves as a quick way to locate frequently used terms and on-screen display names.

### A

Add Channel .....	15
Audio Monitor .....	25
Auto Channel Setting .....	14
Auto Daylight Saving Time .....	12
Auto Picture .....	20
Auto SP→EP Timer .....	31
Auto Timer .....	31
Automatic Tracking .....	19
Aux Input .....	33
AV Connection .....	6

### B

Band .....	14
------------	----

### C

Cancel Program .....	30
Cassette Adapter .....	16
Check Program .....	30
Connection to TV .....	6
Contents .....	5
Counter Reset .....	23

### D

Delete Channel .....	15
----------------------	----

### E

Editing .....	33
Express Timer Programming .....	28
Express Timer Recording .....	28

### F

Frame-by-Frame Playback .....	18
-------------------------------	----

### H

Host Channel Selection .....	12
------------------------------	----

### I

Index Search .....	19
Insert Cassette .....	16
ITR (Instant Timer Recording) .....	32

### L

Language Selection .....	10
--------------------------	----

### M

Main Menu .....	10
Manual Channel Setting .....	15
Manual Clock Setting .....	13
Manual Tracking .....	19

### N

Next-Function Memory .....	23
----------------------------	----

### O

On-Screen Display .....	24
-------------------------	----

### P

PBS Channel .....	8
Picture Control .....	21
Playback .....	16
Plug & Play .....	8

### R

Record Safety Tab .....	17
Recording .....	17
Repeat Playback .....	23
Reverse Motion Playback .....	18
Reverse Slow Motion Playback .....	18
RF Connection .....	6

### S

SAP (Second Audio Program) .....	27
Second Audio .....	27
Semi-Auto Clock Setting .....	12
Slow Motion Playback .....	18
Specifications .....	43
SQPB (S-VHS Quasi Play Back) .....	16
Still Picture Playback .....	18
Superimpose .....	24

### T

Tape Position Indicator .....	23
Tape Speed Setting .....	17
Time Zone Selection .....	13
Tuner Setting .....	14

### V

Variable-Speed Search .....	18
Video Stabilizer .....	22

## FRONT VIEW

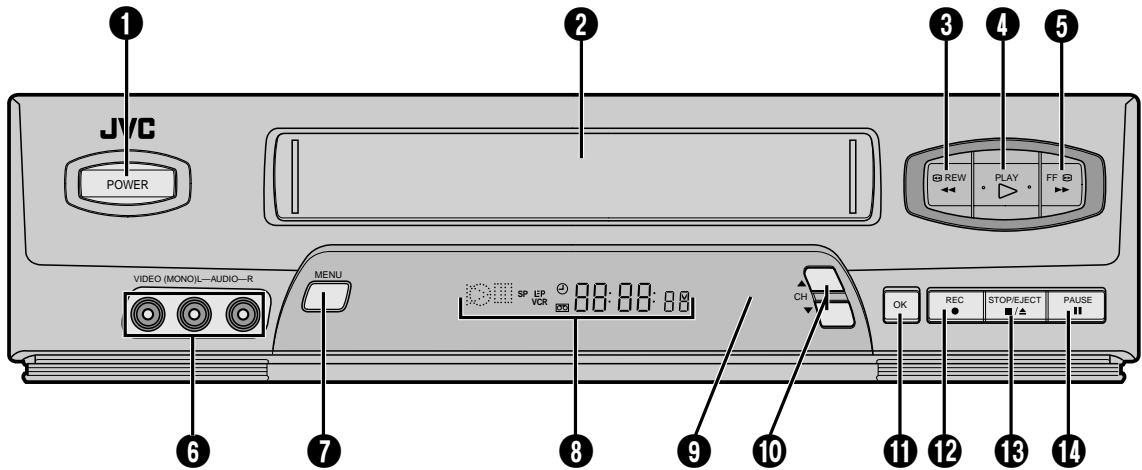

- ❶ Power On/Off Button (☞ pg. 10)
- ❷ Cassette Loading Slot
- ❸ Rewind [REW] Button (☞ pg. 16)
- ❹ PLAY Button (☞ pg. 16)
- ❺ Fast Forward [FF] Button (☞ pg. 16)
- ❻ VIDEO/AUDIO Input Connectors (☞ pg. 34)
- ❼ MENU Button (☞ pg. 10)
- ❽ Front Display Panel (☞ pg. 41)
- ❾ Remote Control Sensor
- ❿ Channel [CH] ▲▼ Button (☞ pg. 17)
- ⓫ OK Button (☞ pg. 10)
- ⓬ Record [REC] Button (☞ pg. 17)
- ⓭ STOP/EJECT Button (☞ pg. 16)
- ⓮ PAUSE Button (☞ pg. 18)



## REAR VIEW

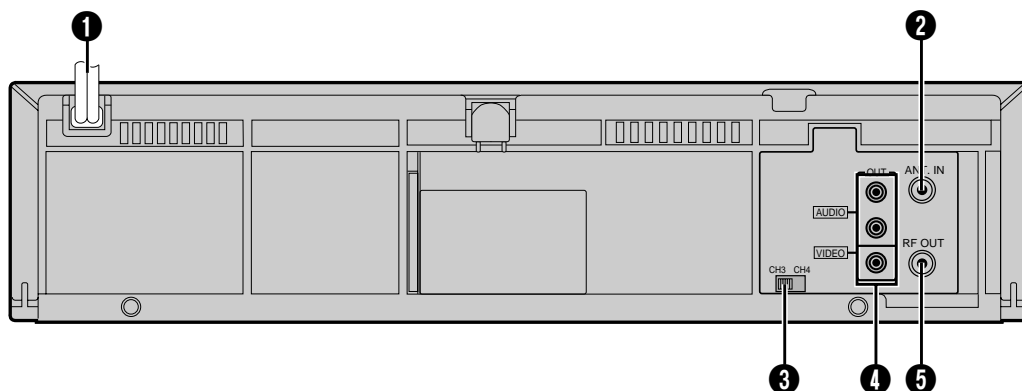

- ❶ Power Cord (☞ pg. 6)
- ❷ ANT. IN Connector (☞ pg. 6)
- ❸ Channel 3/4 Switch (☞ pg. 6)
- ❹ VIDEO/AUDIO Output Connectors (☞ pg. 33)
- ❺ RF OUT Connector (☞ pg. 6)

## FRONT DISPLAY PANEL

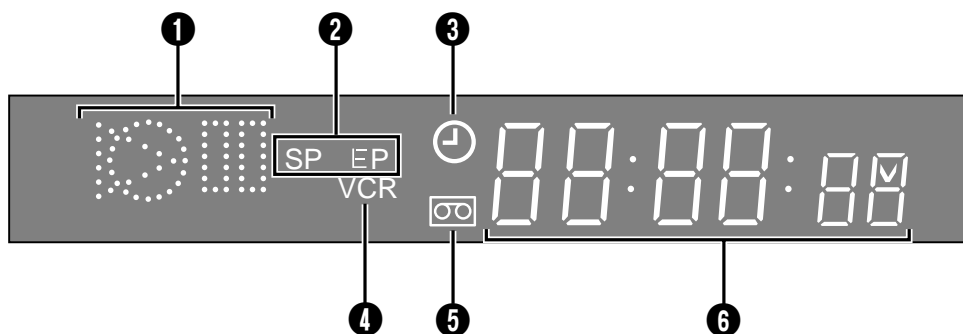

- ❶ Symbolic Mode Indicators

PLAY: FF/REW VARIABLE SEARCH:		STILL: SLOW:	
		RECORD:	
		RECORD PAUSE:	

- ❷ Tape Speed Indicators (☞ pg. 17)
- ❸ Timer Mode Indicator (☞ pg. 29)
- ❹ VCR Mode Indicator (☞ pg. 26)
- ❺ "Cassette Loaded" Mark
- ❻ Channel Display ["F-1" for AUX mode]  
Counter Display (☞ pg. 8)  
Clock Display (☞ pg. 8)

## REMOTE CONTROL

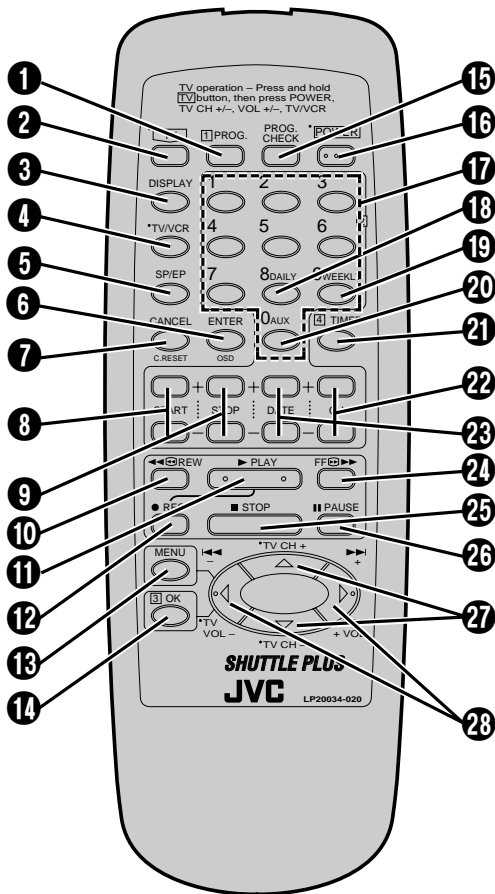

- 1 PROG. Button (☞ pg. 28)
- 2 TV Button (See below)
- 3 DISPLAY Button (☞ pg. 23)
- 4 TV/VCR Button (☞ pg. 26)
- 5 Recording Speed [SP/EP] Button (☞ pg. 17)
- 6 ENTER Button (☞ pg. 17)  
On-Screen Display [OSD] Button (☞ pg. 24)
- 7 CANCEL Button (☞ pg. 30)  
Counter [C.] RESET Button (☞ pg. 23)
- 8 START +/- Button (☞ pg. 28)
- 9 STOP +/- Button (☞ pg. 28)
- 10 Rewind [REW] Button (☞ pg. 16)
- 11 PLAY Button (☞ pg. 16)
- 12 Record [REC] Button (☞ pg. 17)
- 13 MENU Button (☞ pg. 10)
- 14 OK Button (☞ pg. 10)
- 15 PROG. CHECK Button (☞ pg. 30)
- 16 POWER On/Off Button (☞ pg. 10)
- 17 NUMBER Buttons (☞ pg. 17)
- 18 DAILY Timer Recording Button (☞ pg. 29)
- 19 WEEKLY Timer Recording Button (☞ pg. 29)
- 20 "AUX" Mode Select Button (☞ pg. 35)
- 21 TIMER Button (☞ pg. 29)
- 22 Channel [CH] +/- Button (☞ pg. 17, 28)
- 23 DATE +/- Button (☞ pg. 28)
- 24 Fast-Forward [FF] Button (☞ pg. 16)
- 25 STOP Button (☞ pg. 16)
- 26 PAUSE Button (☞ pg. 18)
- 27 SHUTTLE PLUS  $\Delta \nabla$  Button (☞ pg. 10)  
TV Channel [CH] +/- Button (See below)
- 28 SHUTTLE PLUS  $\ll \gg$  ( $\triangleleft \triangleright$ ) Button (☞ pg. 18, 19)  
TV Volume [VOL] +/- Button (See below)

Buttons with a small dot on the left side of the name can also be used to operate your TV while holding down the TV button. ☞ "Operating JVC TVs" below.

This remote control transmits A code signals only; it is not applicable to B code signals.

### How To Use

The remote control can operate most of your VCR's functions, as well as basic functions of JVC TV sets. (See below.)

- Point the remote control toward the sensor window.
- The maximum operating distance of the remote control is about 8 m.

### Operating JVC TVs

To operate your TV, while holding down TV, press the corresponding button: POWER, TV/VCR, TV CH+/-, TV VOL +/- can be used without holding down TV.

### NOTES:

- When inserting the batteries, be sure to insert in the correct directions as indicated under the battery cover.
- Depending on the type of JVC TV, there may be cases where some or all functions cannot be operated using the remote control.
- If the remote control doesn't work properly, remove its batteries. Replace with fully charged batteries and then try again.

## GENERAL

Power requirement	: AC 120 V $\sim$ , 60 Hz
Power consumption	
Power on	: 19 W
Power off	: 2.5 W
Temperature	
Operating	: 5°C to 40°C (41°F to 104°F)
Storage	: -20°C to 60°C (-4°F to 140°F)
Operating position	: Horizontal only
Dimensions (W x H x D)	: 360 x 94 x 273 mm (14-3/16" x 3-3/4" x 10-3/4")
Weight	: 3.0 kg (6.6 lbs)
Format	: VHS NTSC standard
Maximum recording time	
SP	: 210 min. with ST-210 video cassette
EP	: 630 min. with ST-210 video cassette

## VIDEO/AUDIO

Signal system	: NTSC-type color signal and EIA monochrome signal, 525 lines/60 fields
Recording/ Playback system	: DA-4 (Double Azimuth) head helical scan system
Signal-to-noise ratio	: 45 dB
Horizontal resolution	: 240 lines
Frequency range	
Normal audio	: 70 Hz to 10,000 Hz
Hi-Fi audio	: 20 Hz to 20,000 Hz
Input/Output	: RCA connectors (IN x 1, OUT x 1)

## TUNER

Tuning system	: Frequency-synthesized tuner
Channel coverage	
VHF	: Channels 2-13
UHF	: Channels 14-69
CATV	: 113 Channels
RF output	: Channel 3 or 4 (switchable; preset to Channel 3 when shipped) 75 ohms, unbalanced

## TIMER

Clock reference	: Quartz
Program capacity	: 1-year programmable timer/ 8 programs
Memory backup time	: Approx. 3 min.

## ACCESSORIES

Provided accessories	: RF cable (F-type), Infrared remote control unit, "AA" battery x 2
----------------------	---

*Specifications shown are for SP mode unless otherwise specified. E. & O.E. Design and specifications subject to change without notice.*

**HOW TO LOCATE YOUR JVC SERVICE CENTER****TOLL FREE: 1-800-252-5722****<http://www.jvcservice.com>****Dear customer:**

*In order to receive the most satisfaction from your purchase, read the instruction booklet before operating the unit. In the event that repair is necessary, or for the address nearest your location, please refer to the factory service center list below or within the Continental United States, call 1-800-252-5722 for your authorized servicer. Remember to retain your Bill of Sale for Warranty Service.*

— JVC

**JVC SERVICE & ENGINEERING  
COMPANY OF AMERICA  
DIVISION OF US JVC CORP.**

FACTORY SERVICE CENTER LOCATIONS

107 Little Falls Road  
Fairfield, NJ 07004-2105  
(973) 808-9279

1500 Lakes Parkway  
Lawrenceville, GA 30243-5857  
(770) 339-2522

705 Enterprise Street  
Aurora, IL 60504-8135  
(630) 851-7855

5665 Corporate Avenue  
Cypress, CA 90630-4727  
(714) 229-8011

10700 Hammerly Boulevard, Suite 110  
Houston, TX 77043-2310  
(713) 935-9331

2969 Mapunapuna Place, Suite 101  
Honolulu, HI 96819-2000  
(808) 833-5828

230 Eliot Street  
Ashland, MA 01721-2377  
(508) 881-5923

8192 W State Road 84  
Davie, FL 33324-4611  
(954) 472-1960

890 Dubuque Avenue  
South San Francisco, CA 94080-1804  
(650) 871-2666

*Sophisticated electronic products may require occasional service. Just as quality is a keyword in the engineering and production of the wide array of JVC products, service is the key to maintaining the high level performance for which JVC is world famous. The JVC service and engineering organization stands behind our products.*

NATIONAL HEADQUARTERS  
JVC SERVICE & ENGINEERING COMPANY OF AMERICA  
DIVISION OF US JVC CORP.  
107 Little Falls Road  
Fairfield, NJ 07004-2105

**If you ship the product...**

*Pack your JVC unit in the original carton or one of equivalent size and strength. Enclose, with the unit, a letter stating the problem or symptom that exists and also a copy of the receipt or bill of sale you received when you purchased your JVC unit. Print your home return address on the outside and the inside of the carton. Send to the appropriate JVC Factory Service Center as listed above.*

**Don't service it yourself.****CAUTION**

*To prevent electrical shock, do not open the cabinet. No user serviceable parts inside.  
Refer servicing to qualified service personnel.*

**ACCESSORIES**

*To purchase accessories for your JVC product, you may contact your local JVC Dealer.  
Or from the 48 Continental United States call toll free:  
1-800-882-2345.*

**LIMITED WARRANTY**

**CONSUMER VIDEO 1-90**

JVC COMPANY OF AMERICA warrants this product and all parts thereof, except as set forth below ONLY TO THE ORIGINAL PURCHASER AT RETAIL to be FREE FROM DEFECTIVE MATERIALS AND WORKMANSHIP from the date of original retail purchase for the period as shown below. ("The Warranty Period")

PARTS	<b>1</b> YR	LABOR	<b>90</b> DAYS
-------	-------------	-------	----------------

THIS LIMITED WARRANTY IS VALID ONLY IN THE FIFTY (50) UNITED STATES, THE DISTRICT OF COLUMBIA AND IN COMMONWEALTH OF PUERTO RICO.

**WHAT WE WILL DO:**

If this product is found to be defective, JVC will repair or replace defective parts at no charge to the original owner. Such repair and replacement services shall be rendered by JVC during normal business hours at JVC authorized service centers. Parts used for replacement are warranted only for the remainder of the Warranty Period. All products and parts thereof may be brought to a JVC authorized service center on a carry-in basis except for Television sets having a screen size 25 inches and above which are covered on an in-home basis.

**WHAT YOU MUST DO FOR WARRANTY SERVICE:**

Return your product to a JVC authorized service center with a copy of your bill of sale. For your nearest JVC authorized service center, please call toll free: (800) 252-5722.

If service is not available locally, box the product carefully, preferably in the original carton, and ship, insured, with a copy of your bill of sale plus a letter of explanation of the problem to the nearest JVC Factory Service Center, the name and location of which will be given to you by the toll-free number.

If you have any questions concerning your JVC Product, please contact our Customer Relations Department.

**WHAT IS NOT COVERED:**

This limited warranty provided by JVC does not cover:

1. Products which have been subject to abuse, accident, alteration, modification, tampering, negligence, misuse, faulty installation, lack of reasonable care, or if repaired or serviced by anyone other than a service facility authorized by JVC to render such service, or if affixed to any attachment not provided with the products, or if the model or serial number has been altered, tampered with, defaced or removed;
2. Initial installation and installation and removal for repair;
3. Operational adjustments covered in the Owner's Manual, normal maintenance, video and audio head cleaning;
4. Damage that occurs in shipment, due to act of God, and cosmetic damage;
5. Signal reception problems and failures due to line power surge;
6. Video Pick-up Tubes/CCD Image Sensor, Cartridge, Stylus (Needle) are covered for 90 days from the date of purchase;
7. Accessories;
8. Batteries (except that Rechargeable Batteries are covered for 90 days from the date of purchase); from the date of purchase);

There are no other express warranties except as listed above.

THE DURATION OF ANY IMPLIED WARRANTIES INCLUDING THE IMPLIED WARRANTY OF MERCHANTABILITY, IS LIMITED TO THE DURATION OF THE EXPRESS WARRANTY HEREIN.

JVC SHALL NOT BE LIABLE FOR THE LOSS OF USE OF THE PRODUCT, INCONVENIENCE, LOSS OR ANY OTHER DAMAGES, WHETHER DIRECT, INCIDENTAL OR CONSEQUENTIAL (INCLUDING, WITHOUT LIMITATION, DAMAGE TO TAPES, RECORDS OR DISCS) RESULTING FROM THE USE OF THIS PRODUCT, OR ARISING OUT OF ANY BREACH OF THIS WARRANTY. ALL EXPRESS AND IMPLIED WARRANTIES, INCLUDING THE WARRANTIES OF MERCHANTABILITY AND FITNESS FOR PARTICULAR PURPOSE, ARE LIMITED TO THE WARRANTY PERIOD SET FORTH ABOVE.

Some states do not allow the exclusion of incidental or consequential damages or limitations on how long an implied warranty lasts, so these limitations or exclusions may not apply to you. This warranty gives you specific legal rights and you may also have other rights which vary from state to state.

JVC COMPANY OF AMERICA  
DIVISION OF US JVC CORP.

1700 Valley Road  
Wayne, New Jersey 07470

REFURBISHED PRODUCTS CARRY A SEPARATE WARRANTY, THIS WARRANTY DOES NOT APPLY. FOR DETAILS OF REFURBISHED PRODUCT WARRANTY, PLEASE REFER TO THE REFURBISHED PRODUCT WARRANTY INFORMATION PACKAGED WITH EACH REFURBISHED PRODUCT.

**For customer use:**

Enter below the Model No. and Serial No. which is located either on the rear, bottom or side of the cabinet. Retain this information for future reference.

Model No.: \_\_\_\_\_

Serial No.: \_\_\_\_\_

Purchase date: \_\_\_\_\_

Name of dealer: \_\_\_\_\_









## Free Manuals Download Website

<http://myh66.com>

<http://usermanuals.us>

<http://www.somanuals.com>

<http://www.4manuals.cc>

<http://www.manual-lib.com>

<http://www.404manual.com>

<http://www.luxmanual.com>

<http://aubethermostatmanual.com>

Golf course search by state

<http://golfingnear.com>

Email search by domain

<http://emailbydomain.com>

Auto manuals search

<http://auto.somanuals.com>

TV manuals search

<http://tv.somanuals.com>