

JVC



ENGLISH

**SEE
AUTO SET UP
ON REAR SIDE**



VIDEO CASSETTE RECORDER

HR-DD858E/EH HR-J758E/EH

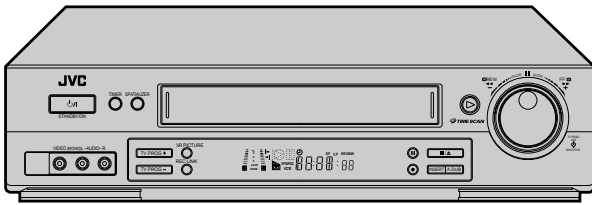

The recorder illustrations appearing in this instruction manual are of the HR-DD858E/EH.

TIME SCAN

SHOWVIEW Hi-Fi VHS
PAL



INSTRUCTIONS

CONTENTS

SAFETY FIRST	2
Safety Precautions	2
INSTALLING YOUR NEW RECORDER	3
Basic Connections	3
INITIAL SETTINGS	4
Auto Set Up	4
Language	7
On-Screen Displays	8
Power Save Mode [J758E, DD858E only]	9
INFORMATION ON COLOUR SYSTEM	10
Colour System Set	10
PLAYBACK	11
Basic Playback	11
Playback Features	12
TimeScan [DD858E/EH only]	18
RECORDING	20
Basic Recording	20
Recording Features	21
B.E.S.T. Picture System	24
TIMER RECORDING	26
SHOWVIEW Timer Programming	26
Express Timer Programming	28
Automatic Satellite Programme Recording	32
SPECIAL FEATURES	33
Remote Control Functions	33
EDITING	36
Edit To Or From Another Video Recorder	36
Edit From A Camcorder	38
Audio Dubbing [DD858E/EH only] ..	39
Insert Editing [DD858E/EH only]	40
SYSTEM CONNECTIONS	42
Connection To A Satellite Tuner	42
Connecting/Using A Decoder	43
Connecting/Using A Stereo System	44
SUBSIDIARY SETTINGS	45
Video Channel Set	45
Tuner Set	46
SHOWVIEW Setup	53
Clock Set	54
TROUBLESHOOTING	56
QUESTIONS AND ANSWERS	58
INDEX	59
SPECIFICATIONS	62

EN

LPT0048-001C

Safety Precautions

The rating plate and the safety caution are on the rear of the unit.

WARNING: DANGEROUS VOLTAGE INSIDE

WARNING: TO PREVENT FIRE OR SHOCK HAZARD, DO NOT EXPOSE THIS UNIT TO RAIN OR MOISTURE.

CAUTION

- When you are not using the recorder for a long period of time, it is recommended that you disconnect the power cord from the mains outlet.
- Dangerous voltage inside. Refer internal servicing to qualified service personnel. To prevent electric shock or fire hazard, remove the power cord from the mains outlet prior to connecting or disconnecting any signal lead or aerial.

WARNING

There are two different types of SECAM colour systems: SECAM-L, used in FRANCE (also called SECAM-West), and SECAM-B, used in Eastern European countries (also called SECAM-East).

1. This recorder can also receive SECAM-B colour television signals for recording and playback.
2. Recordings made of SECAM-B television signals produce monochrome pictures if played back on a video recorder of SECAM-L standard, or do not produce normal colour pictures if played back on a PAL video recorder with SECAM-B system incorporated (even if the TV set is SECAM-compatible).
3. SECAM-L prerecorded cassettes or recordings made with a SECAM-L video recorder produce monochrome pictures when played back with this recorder.
4. This recorder cannot be used for the SECAM-L standard. Use a SECAM-L recorder to record SECAM-L signals.

For Italy:

"It is declared that this product, brand JVC, conforms to the Ministry Decree n. 548 of 28 Aug.'95 published in the Official Gazette of the Italian Republic n. 301 of 28 Dec.'95"

The STANDBY/ON ψ /I button does not completely shut off mains power from the unit, but switches operating current on and off. " ψ " shows electrical power standby and "I" shows ON.

IMPORTANT

- Please read the various precautions on this page before installing or operating the recorder.
- It should be noted that it may be unlawful to re-record pre-recorded tapes, records, or discs without the consent of the owner of copyright in the sound or video recording, broadcast or cable programme and in any literary, dramatic, musical, or artistic work embodied therein.

Video tapes recorded with this video recorder in the LP (Long Play) mode cannot be played back on a single-speed video recorder.

Failure to heed the following precautions may result in damage to the recorder, remote control or video cassette.

1. **DO NOT** place the recorder . . .

- ... in an environment prone to extreme temperatures or humidity.
- ... in direct sunlight.
- ... in a dusty environment.
- ... in an environment where strong magnetic fields are generated.
- ... on a surface that is unstable or subject to vibration.

2. **DO NOT** block the recorder's ventilation openings.

3. **DO NOT** place heavy objects on the recorder or remote control.

4. **DO NOT** place anything which might spill on top of the recorder or remote control.

5. **AVOID** violent shocks to the recorder during transport.

MOISTURE CONDENSATION

Moisture in the air will condense on the recorder when you move it from a cold place to a warm place, or under extremely humid conditions—just as water droplets form in the surface of a glass filled with cold liquid. Moisture condensation on the head drum will cause damage to the tape. In conditions where condensation may occur, keep the recorder turned on for a few hours to let the moisture dry.

ABOUT HEAD CLEANING

Accumulation of dirt and other particles on the video heads may cause the playback picture to become blurred or interrupted. Be sure to contact your nearest JVC dealer if such troubles occur.



- Cassettes marked "VHS" (or "S-VHS") can be used with this video cassette recorder, however, only VHS signals can be played back and recorded.
- HQ VHS is compatible with existing VHS equipment.
- SHOWVIEW is a trademark of Gemstar Development Corporation. The SHOWVIEW system is manufactured under licence from Gemstar Development Corporation.
- Certain audio features of this product manufactured under a license from Desper Products, Inc. Spatializer® is a trademark owned by Desper Products, Inc.

Basic Connections

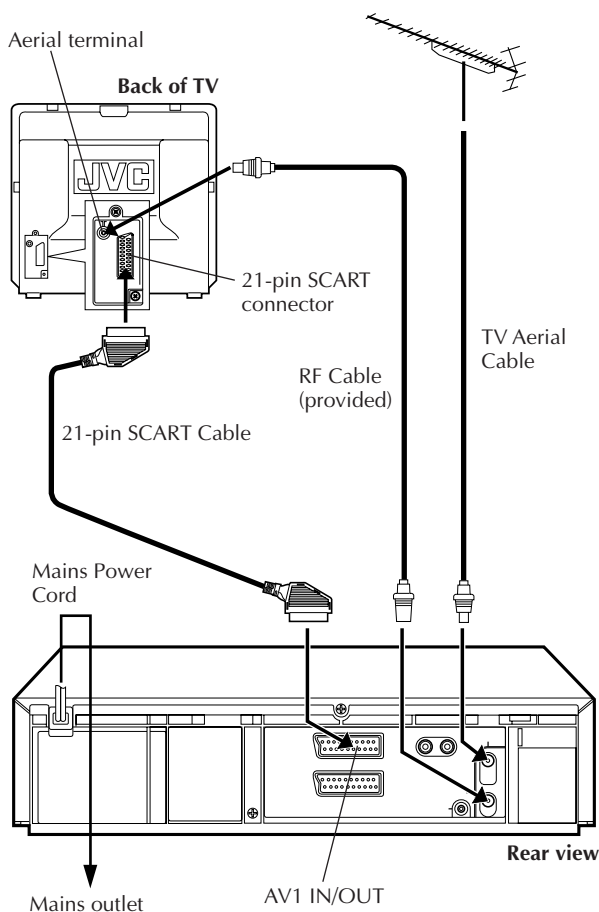

Make AV connection if your TV has a 21-pin AV input connector (SCART) in order to reduce the possibility of interference. And if you are using a stereo TV, you will need this cable in order to enjoy stereo playback of videotapes.

It's essential that your video recorder be properly connected. Follow these steps carefully. THESE STEPS MUST BE COMPLETED BEFORE ANY VIDEO OPERATION CAN BE PERFORMED.

1

CHECK CONTENTS

Make sure the package contains all of the accessories listed in "Specifications" (☞ pg. 62).

2

SITUATE RECORDER

Place the recorder on a stable, horizontal surface.

3

CONNECT RECORDER TO TV

The connection method you use depends on the type of TV you have.

RF CONNECTION

- *To Connect To A TV With NO AV Input Terminals . . .*
 - a- Disconnect the TV aerial cable from the TV.
 - b- Connect the TV aerial cable to the ANT. IN jack on the rear panel of the recorder.
 - c- Connect the provided RF cable between the RF OUT jack on the rear panel of the recorder and the TV's aerial terminal.

AV CONNECTION

- *To Connect To A TV With AV Input Terminals . . .*
 - a- Connect the aerial, recorder and TV as per "RF CONNECTION".
 - b- Connect an optional SCART cable between the AV1 IN/OUT socket on the rear panel of the recorder and the TV's 21-pin SCART connector.

4

CONNECT RECORDER TO MAINS

Plug the end of the mains power cord into a mains outlet.

After you plug the mains power cord into a mains outlet, the Country Set display appears on the TV screen and/or on the recorder's front display panel when the $\odot/1$ button on the recorder/remote control is pressed for the first time to power on the recorder; go to page 4 to perform Auto Set Up.

Auto Set Up

Auto Channel Set/Auto Clock Set/Auto Guide Program Number Set/Auto Video Channel Set

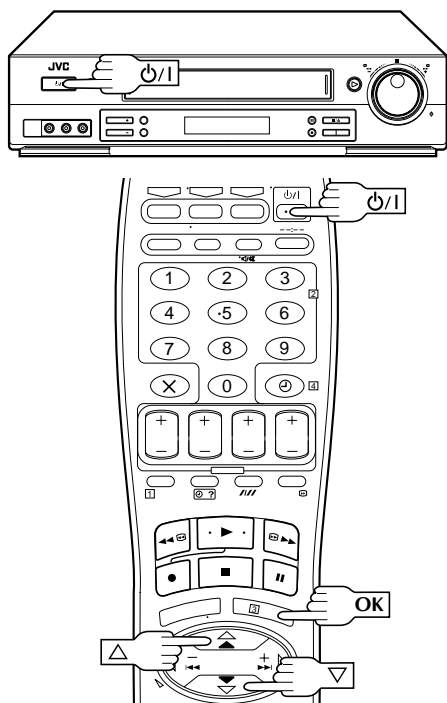

International Telephone Country Code

SUISSE	: 41	SUOMI	: 358
ITALIA	: 39	PORTUGAL	: 351
ESPAÑA	: 34	DEUTSCHLAND	: 49
BELGIUM	: 32	NORGE	: 47
NEDERLAND	: 31	SVERIGE	: 46
GREECE	: 30	DANMARK	: 45
OTHERS	: --	ÖSTERREICH	: 43

ATTENTION

Once you have performed Auto Set Up, even if the recorder's memory backup has expired, all the stored stations and their Guide Program numbers remain in the recorder's memory and the recorder will not perform Auto Set Up again. You only need to set the clock. (☞ pg. 54)

If you have moved to a different area, perform each setting as required.

- Video Channel setting (for RF connection users) ☞ pg. 45
- Tuner setting ☞ pg. 46
- Clock setting ☞ pg. 54

If a new station starts broadcasting in your area, perform tuner setting (☞ pg. 46) and, if necessary, video channel setting (☞ pg. 45).

When the **⏻/I** button on the recorder/remote control is pressed for the first time to power on the recorder after you plug the mains power cord into a mains outlet, the Country Set display will appear on the TV screen and the recorder's front display panel. By simply selecting your country*, the Auto Set Up function sets the tuner channels, clock, Guide Program numbers and video channel** automatically.

* If you live in Belgium (BELGIUM) or Switzerland (SUISSE), you also need to select your area.

** Useful if you have connected the video recorder to your TV via RF connection (☞ pg. 3). Video Channel (RF output channel) is the channel on which your TV receives picture and sound signals from the video recorder through the RF cable.

You can refer to the front display panel and/or the on-screen display to perform this procedure.

Before starting, make sure of the following:

- The TV aerial cable should be connected to the recorder.
- The recorder's mains power cord should be connected to a mains outlet. ☞ pg. 3
- If you want to use the on-screen display, the TV should be set to its AV mode (with AV connection ☞ pg. 3) or UHF channel 36 (with RF connection ☞ pg. 3).

1 TURN ON THE RECORDER

Press **⏻/I** on the recorder or remote control. The Country Set display appears on the front display panel and/or on the screen.



NOTE:

If you have connected your TV to the recorder with RF connection and the on-screen display appearing on UHF channel 36 looks distorted, perform this procedure referring to the front display panel.

PREVIOUS PAGE
SUISSE
ITALIA
ESPAÑA
BELGIUM
NEDERLAND
GREECE
OTHERS
[▲▼] → [OK]
[MENU] : EXIT

2 SELECT COUNTRY

If you are referring to the front display panel

Press **Δ∇** to select your international telephone country code of your country referring to the chart in the left column.

- If you have selected a country code other than 32 (BELGIUM) or 41 (SUISSE), go to step 4.
- If you have selected 32 (BELGIUM) or 41 (SUISSE), go to step 3.

(Ex.) DEUTSCHLAND is selected

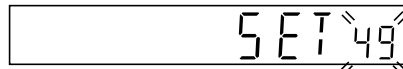

If you are referring to the on-screen display

Press **Δ∇** to move the highlight bar (pointer) to your country's name.

PREVIOUS PAGE	SUOMI
SUISSE	PORTUGAL
ITALIA	DEUTSCHLAND
ESPAÑA	NORGE
BELGIUM	SVERIGE
NEDERLAND	DANMARK
GREECE	ÖSTERREICH
OTHERS	NEXT PAGE
[▲▼] → [OK]	[▲▼] → [OK]
[MENU] : EXIT	[MENU] : EXIT

- If you have selected a country other than BELGIUM or SUISSE, go to step 4.
- If you have selected BELGIUM or SUISSE, go to step 3.

3

SELECT LANGUAGE

Press **OK**. The Language Set display appears on the front display panel and/or on the screen.

If you are referring to the front display panel

Press $\Delta \nabla$ to select your language code.

Language Code

ENGLISH	:01	NEDERLANDS	:06
DEUTSCH	:02	SVENSKA	:07
FRANCAIS	:03	NORSK	:08
ITALIANO	:04	SUOMI	:09
CASTELLANO	:05	DANSK	:10

(Ex.) DEUTSCH is selected for SUISSE

International telephone country code Language code



If you are referring to the on-screen display

Press $\Delta \nabla$ to move the highlight bar (pointer) to the language of your choice.



(Ex.) DEUTSCH is selected

4

PERFORM AUTO SET UP

Press **OK**.

"Auto" appears on the display panel and blinks; do NOT press any button on the recorder or remote control until the display panel shows either the display as illustrated in step 5 or "-:--".

- If "-:--" appears on the display panel, refer to page 6.
- If you are using the on-screen display, the AUTO SET screen will appear. As Auto Set Up progresses, the "■" mark on the screen moves from left to right.

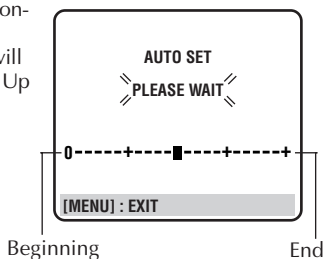

5

CONFIRM/SET VIDEO CHANNEL

If you have connected the video recorder to your TV via an RF cable only (RF connection)

The channel that is shown on the display panel is your Video Channel.

To view picture signals from the video recorder, set your TV to the Video Channel. — Refer to the instructions supplied with your TV set for how to do this.

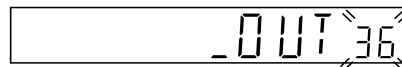

If you have connected the video recorder to your TV via both an RF cable and a 21-pin SCART cable (AV connection)

You do not need the video channel so you have to set the video channel to off.

Press **TV PROG** — until the display panel shows "-_OUT—" to set the Video Channel to off.

To view picture signals from the video recorder, set your TV to its AV mode. — Refer to the instructions supplied with your TV set for how to do this.

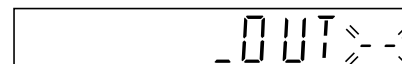

6

FINISH AUTO SET UP

Press **OK** and refer to page 6 to check the results.

NOTES:

- Auto channel set function takes place first; it assigns automatically all receivable stations in your area.
- Auto clock set function sets the clock automatically by reading the clock setting data from a station transmitting a PDC signal while auto channel set is being performed.
- During auto channel set, the recorder recognizes each station name of the detected stations and stores them in the recorder's memory, then automatically sets SHOWVIEW assigned Guide Program number for those stations according to the broadcast area.
- In the area where no TV station transmits a PDC signal, the recorder can perform neither auto clock set nor auto Guide Program number set.
- For RF connection users: The video recorder detects the channels which are not occupied by local stations and selects one channel automatically for your Video Channel that is located in the middle of more than 5 vacant channels.
- If there is a power cut, or if you press $\odot/1$ or **MENU** while Auto Set Up is in progress, Auto Set Up will be interrupted; be sure to turn off the recorder power once and try again from step 1.

Auto Set Up results appear on the front display panel

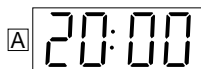

When both auto channel set and auto clock set have been completed successfully the correct current time will be displayed after the **OK** button is pressed in step 6 on page 5.



When auto channel set has been completed successfully but auto clock set has not, "1" (channel position) will be displayed after the **OK** button is pressed in step 6 on page 5.

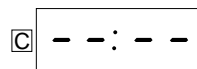

When neither auto channel set nor auto clock set has been completed successfully, "- :-" will be displayed.

You can check if the Guide Program numbers have been set correctly when you perform **SHOWVIEW** Timer Programming (☞ pg. 26); if the correct channel position number is displayed in step 3, this confirms that the Guide Program number for the **SHOWVIEW** number you enter in step 2 has been set correctly.

A If both auto channel set and auto clock set have been performed successfully:

- 1 Turn on the TV and select its **VIDEO** channel or **AV** mode, then make sure that all necessary stations have been stored in the recorder's memory by using the **TV PROG** button(s).
 - If station names (ID — ☞ pg. 51) have also been stored in the recorder's memory, the station name will be displayed at the top left corner of the screen for about 5 seconds when the recorder is tuned to a different station.
 - If you want to set the tuner manually such as to add or skip channels, to change channel positions, or to set or change station names, see pages 48 – 52.

B If auto channel set has succeeded but auto clock set has not:

- 1 Turn on the TV and select its **VIDEO** channel or **AV** mode, then make sure that all necessary stations have been stored in the recorder's memory by using the **TV PROG** button(s).
 - If station names (ID — ☞ pg. 51) have also been stored in the recorder's memory, the station name will be displayed at the top left corner of the screen for about 5 seconds when the recorder is tuned to a different station.
 - If you want to set the tuner manually such as to add or skip channels, to change channel positions, or to set or change station names, see pages 48 – 52.
- 2 Perform "Clock Set" on page 54.

C If both auto channel set and auto clock set have failed:

- 1 Make sure the TV aerial cable is connected properly to the recorder and turn off the recorder power once, then turn the recorder power back on again.
 - The Country Set display appears on the front display panel and/or on the screen; perform steps 2 – 6 on pages 4 – 5 again.

IMPORTANT

- In certain reception conditions, station names may not be stored correctly, and auto Guide Program Number Set may not work properly. If the Guide Program numbers are not set properly, when you timer-record a TV programme using **SHOWVIEW**, the recorder will record a TV programme of a different station. When programming the timer using **SHOWVIEW**, be sure to check whether the channel position on which your recorder receives the broadcasting station you wish to record is selected (☞ pg. 26, "SHOWVIEW Timer Programming").
- Your video recorder memorizes all detected stations even if reception of some of them is poor. In these cases picture quality may be poor. To delete those stations with an unacceptable picture ☞ "Delete A Channel" on page 49.
- **For RF connection users:** In certain reception conditions, the Video Channel may not be set correctly and interference may appear in the TV picture while the recorder's power is on. Set your Video Channel manually. ☞ pg. 45, "Video Channel Set".

INFORMATION

Language for the on-screen display

Auto Set Up also selects the language automatically for the on-screen display depending on the Country setting you have made in step 2 on page 4 (unless you have selected **BELGIUM** or **SUISSE**), as shown below.

SUOMI	→ SUOMI	SVERIGE	→ SVENSKA	ESPAÑA	→ CASTELLANO
PORTUGAL	→ ENGLISH	DANMARK	→ DANSK	NEDERLAND	→ NEDERLANDS
DEUTSCHLAND	→ DEUTSCH	ÖSTERREICH	→ DEUTSCH	GREECE	→ ENGLISH
NORGE	→ NORSK	ITALIA	→ ITALIANO	OTHERS	→ ENGLISH

If you want to change the language setting manually, ☞ "Language" on page 7.

Just Clock

Your recorder is equipped with the **Just Clock** function which provides accurate time keeping through automatic adjustments at regular intervals, by reading data from a PDC signal. If you want to take advantage of this function, simply set it to "ON".

☞ "Just Clock" on page 54.

Language

Turn on the TV and select the VIDEO channel (or AV mode).

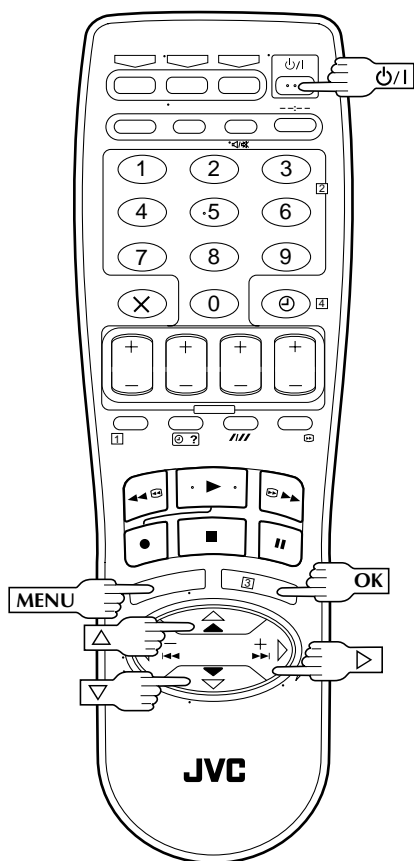

This recorder offers you the choice to view on-screen messages in 10 different languages. Though Auto Set Up selects the language automatically (see pg. 6), you can change the language setting manually using this procedure as required.

1 TURN ON THE RECORDER

Press **⏻/I**.

2 ACCESS MAIN MENU

Press **MENU**.

3 ACCESS COUNTRY SET SCREEN

Press **△▽** to move the highlight bar (pointer) to "AUTO CH SET", then press **OK** or **▷**.

- "REC LEVEL CTL" appears only with the HR-DD858E and HR-DD858EH.

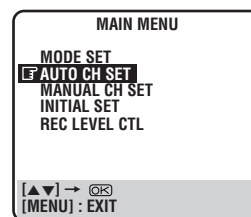

4 SELECT COUNTRY

Press **△▽** to move the highlight bar (pointer) to your country's name, then press **OK** or **▷**.

5 SELECT LANGUAGE

Press **△▽** to move the highlight bar (pointer) to the language of your choice.

- You do not have to press **OK**; pressing **OK** starts Auto Channel Set.



6 RETURN TO NORMAL SCREEN

Press **MENU**.

On-Screen Displays

Turn on the TV and select the VIDEO channel (or AV mode).

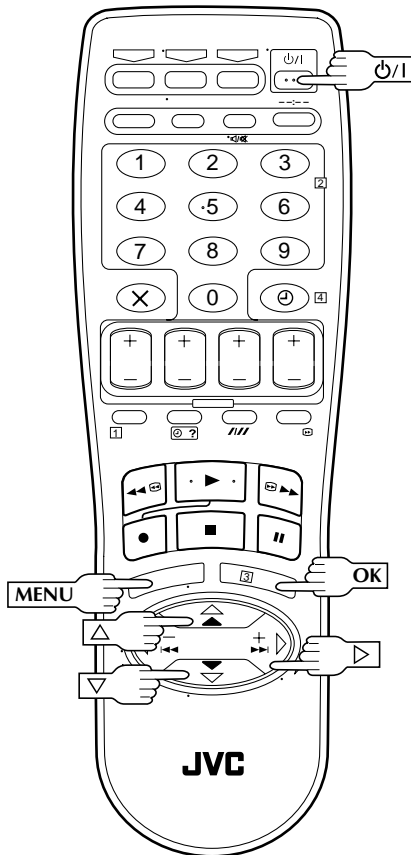

You can choose whether or not to have various operational indicators appear on screen, by setting this function ON or OFF. Messages appear in the selected language (see pg. 6 or 7).

1 TURN ON THE RECORDER

Press **⏻/I**.

2 ACCESS MAIN MENU SCREEN

Press **MENU**.

3 ACCESS MODE SET SCREEN

Move the highlight bar (pointer) to "MODE SET" by pressing **△▽**, then press **OK** or **▷**.

4 ENABLE/DISABLE ON-SCREEN DISPLAY

The default setting is "ON", so if you want on-screen displays, leave the setting as it is and go to step 5. If you don't want the displays to appear, press **△▽** to move the highlight bar (pointer) to "O.S.D." and press **OK** or **▷** to set "O.S.D." to "OFF".

MODE SET	
AUTO TIMER	OFF
O.S.D.	ON
B.E.S.T.	ON
AUTO SP→LP TIMER	OFF

5 RETURN TO NORMAL SCREEN

Press **MENU**.

NOTES:

- When you use this recorder as the player for editing, be sure to set "O.S.D." to "OFF" before starting.
- During playback, the operation mode indicators may be disturbed depending on the type of tape being used.

The superimposed indication on the TV screen tells you what the recorder is doing.

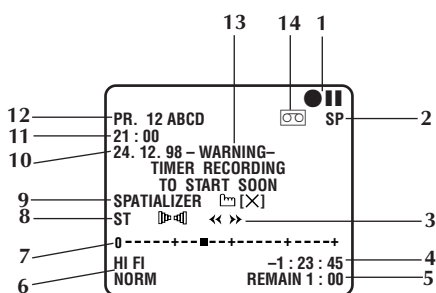

- 1- Operation mode indicators
- 2- Tape speed SP/LP/EP (EP is for NTSC playback only)
- 3- Tape direction
- 4- Counter display
- 5- Tape remaining time indicator (see pg. 21)
- 6- Audio mode display (see pg. 16)
- 7- Tape position indicator (see pg. 11)
- 8- Type of Broadcast (see pg. 22)
- 9- Spatializer® indicator (see pg. 16)
- 10- Current day/month/year
- 11- Clock display
- 12- Channel position number and station name/Aux. indicator (L-1, L-2 or F-1)
- 13- Timer warning display (see pg. 27, 29)
- 14- Cassette loaded mark

Power Save Mode

(HR-J758E and HR-DD858E only)

Turn on the TV and select the VIDEO channel (or AV mode).

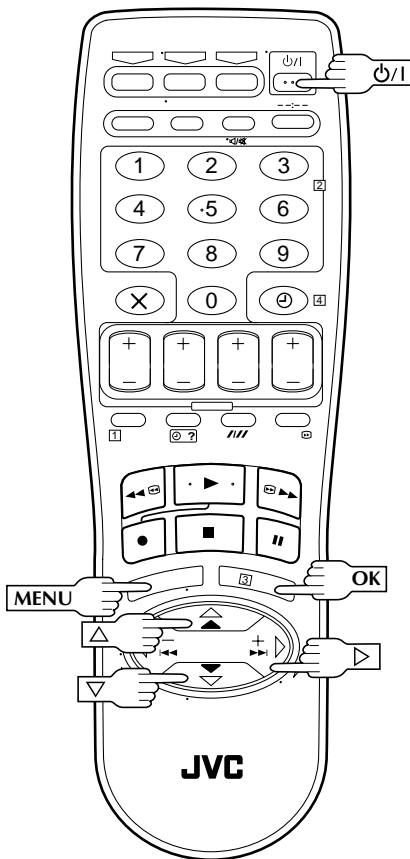

You can reduce the power consumption while the recorder is turned off.

1 TURN ON THE RECORDER

Press /I.

2 ACCESS MAIN MENU SCREEN

Press **MENU**.

3 ACCESS MODE SET SCREEN

Press Δ / ∇ to move the highlight bar (pointer) to "MODE SET", then press **OK** or \triangleright .

- "REC LEVEL CTL" appears only with the HR-DD858E.

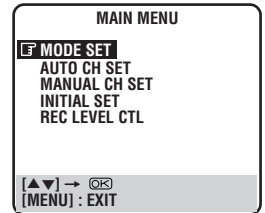

4 SELECT POWER SAVE MODE

Press Δ / ∇ to move the highlight bar (pointer) to "POWER SAVE", then press **OK** or \triangleright to set to "ON".

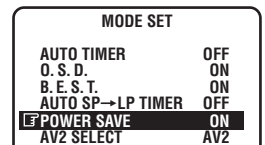

5 RETURN TO NORMAL SCREEN

Press **MENU**.

NOTES:

- During Power Save, the display panel will be turned off.
- The Just Clock function ([pg. 54](#)) does not work while the Power Save mode is engaged.
- While the recorder is in the Power Save mode, the picture may be distorted momentarily when you turn on/off the recorder.
- Power Save does not work when ...
 - ... the recorder is in the Timer mode.
 - ... the recorder's power is turned off after timer-recording (or Instant Timer Recording).
 - ... the Auto Satellite Prog Recording mode is engaged ([pg. 32](#)).
 - ... "AV2 SELECT" is set to "DECODER" ([pg. 37](#)).

Colour System Set

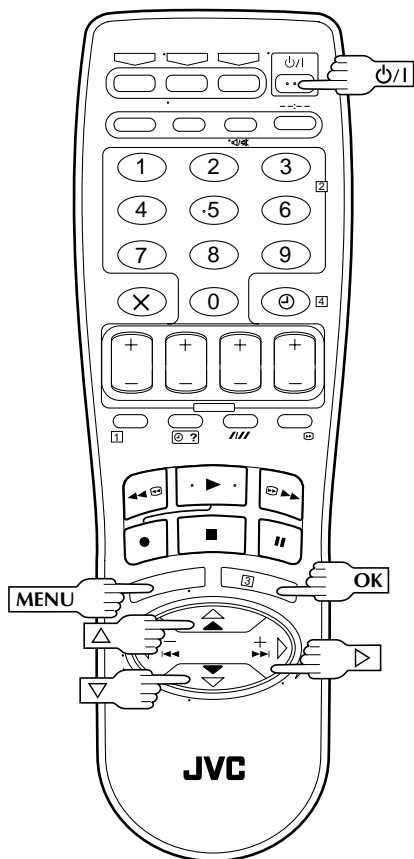

You can play back PAL, NTSC and MESECAM tapes, or record PAL and SECAM* signals on this recorder. Follow the procedure below to select the appropriate colour system.

* SECAM signals will be recorded as MESECAM on this recorder; MESECAM is the designation for tapes with SECAM signals that have been recorded on a MESECAM-compatible PAL video cassette recorder.

TURN ON THE RECORDER

Press **⏻/I**.

ACCESS MAIN MENU SCREEN

Press **MENU**.

ACCESS MODE SET SCREEN

Press **△▽** to move the highlight bar (pointer) to "MODE SET", then press **OK** or **▷**.

- "REC LEVEL CTL" appears only with the HR-DD858E and HR-DD858EH.

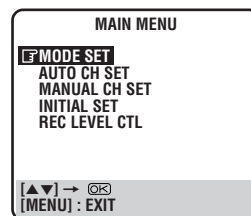

SELECT COLOUR SYSTEM MODE

Press **△▽** to move the highlight bar (pointer) to "COLOUR SYSTEM", then press **OK** or **▷** to select the appropriate colour system.

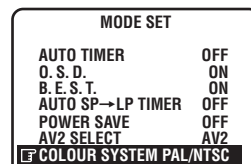

- a- PAL/NTSC: To record PAL signals, or play back a PAL or NTSC tape.
- b- MESECAM: To record SECAM signals, or play back a MESECAM tape.

- "POWER SAVE" appears only with the HR-J758E and HR-DD858E.

RETURN TO NORMAL SCREEN

Press **MENU**.

NOTES:

About NTSC Playback

- Some TVs shrink the picture vertically and place black bars at the top and bottom of the screen. This is not a malfunction on the part of either the video recorder or the TV.
- The picture may roll up and down. This can be corrected using the V-HOLD control found on some TVs. (This cannot be corrected if the TV does not have a V-HOLD control.)
- The counter and tape remaining time readings will be incorrect.
- During search, still, or frame-by-frame playback, the picture will be distorted, and there may be a loss of colour.
- Depending on the type of TV, the top and bottom portions of superimposed displays may be cut off during NTSC playback.

Basic Playback

Turn on the TV and select the VIDEO channel (or AV mode).

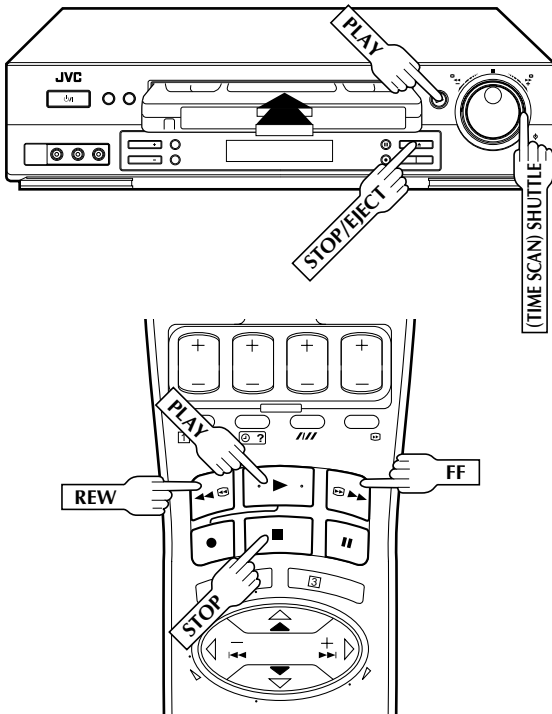

Tape Position Indicator

The tape position indicator appears on screen when, from the Stop mode, you press **FF**, **REW** or perform an Index Search. The position of "■" in relation to "0" (beginning) or "+" (end) shows you where you are on the tape.

"O.S.D." (pg. 8) must be set to "ON", or the indicator will not appear.

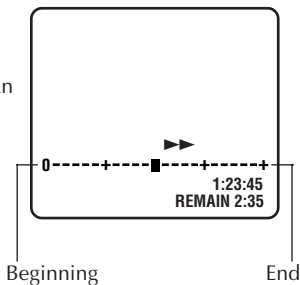

NOTE:

Depending on the type of tape used, there may be times when the indication is not correct.

The easiest, most basic operation possible with your video recorder is tape playback. Already-recorded signals on a video tape are read by your video recorder and displayed on your TV just like a TV programme.

1

LOAD A CASSETTE

Make sure the window side is up, the rear label side is facing you and the arrow on the front of the cassette is point toward the recorder. Don't apply too much pressure when inserting.

- The recorder power comes on automatically and the counter is reset to 0:00:00.
- If the record safety tab has been removed, playback begins automatically.

2

FIND PROGRAMME START POINT

If the tape is advanced past the start point, press **REW** or turn the **(TIME SCAN) SHUTTLE** ring to the left. To go forward, press **FF** or turn the **(TIME SCAN) SHUTTLE** ring to the right.

- The HR-J758E/EH have a standard SHUTTLE ring and the HR-DD858E/EH have a TIME SCAN SHUTTLE ring.

3

START PLAYBACK

Press **PLAY**. "BEST" appears blinking in the recorder's display panel during automatic tracking. (pg. 24)

4

STOP PLAYBACK

Press **STOP** on the remote or **STOP/EJECT** on the recorder's front panel. Then press **STOP/EJECT** to remove the cassette.

Usable cassettes

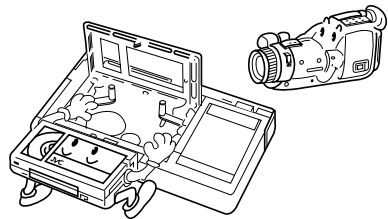

- Compact VHS camcorder recordings can be played on this video recorder. Simply place the recorded cassette into a VHS Cassette Adapter and it can be used just like any full-sized VHS cassette.
- This video recorder can record on regular VHS and Super VHS cassettes. However, it will record and play back regular VHS signals only. It is not possible to play back a recorded Super VHS tape.

Playback Features

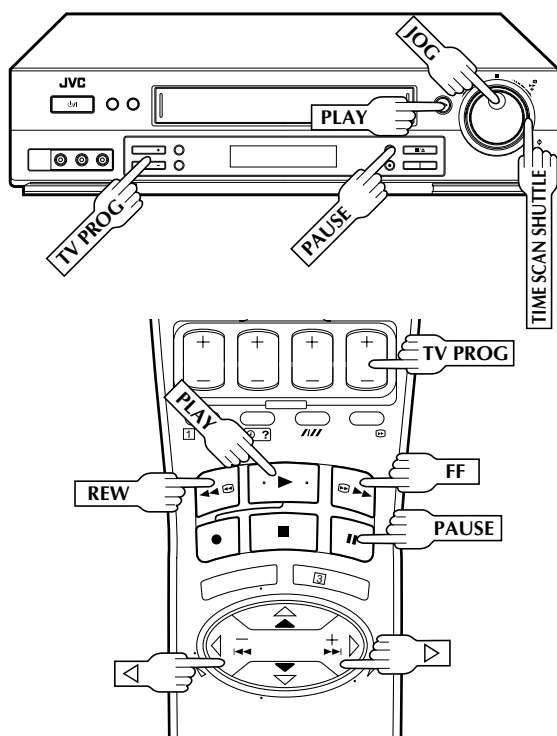

High-Speed (Turbo) Search (For HR-DD858E/EH)

1 ACTIVATE HIGH-SPEED SEARCH

During playback or still picture, press **FF** for forward high-speed search, or **REW** for reverse high-speed search.

To resume normal playback, press **PLAY**.

NOTE:

For short searches, press and hold **FF** or **REW** for over 2 seconds during playback or still picture. When released, normal playback resumes.

ATTENTION

- Picture may not appear during high-speed search with an LP-recorded tape.
- In the high-speed search, still, or frame by frame playback mode, the picture may be distorted, and there may be a loss of colour.

Still Picture/Frame-By-Frame Playback (For HR-DD858E/EH)

1 PAUSE DURING PLAYBACK

Press **PAUSE**. If there is vertical jitter, use the **TV PROG** buttons to correct the picture.

- During still picture, the sound from the previous 3 seconds (approx.) will be played back repeatedly (provided there was at least 6 seconds of normal playback prior to engaging the still picture mode).
- "TIME SCAN AUDIO" must be set to "ON", or the sound will not be heard. (pg. 19)

2 ACTIVATE FRAME-BY-FRAME PLAYBACK

Turn the **JOG** dial to the right for forward frame-by-frame playback, or to the left for reverse frame-by-frame playback.

OR

Press **PAUSE**.

OR

Press ◀ or ▶.

To resume normal playback, press **PLAY**.

Slow Motion (For HR-DD858E/EH)

1 ACTIVATE SLOW-MOTION PLAYBACK

Turn the **TIME SCAN SHUTTLE** ring to the left or press ◀ during playback to decrease speed in the forward direction. To play in reverse slow-motion (and in reverse play mode), continue to turn the **TIME SCAN SHUTTLE** ring to the left or press ◀ after selecting all the forward direction slow-motion modes.

OR

During still picture, turn the **TIME SCAN SHUTTLE** ring to the right for forward slow motion, or to the left for reverse slow motion.

OR

During still picture, press and hold **PAUSE** for 2 seconds, then release. Press and release again to return to still picture.

OR

During still picture, press and hold ◀ or ▶. Release to return to still picture.

To resume normal playback, press **PLAY**.

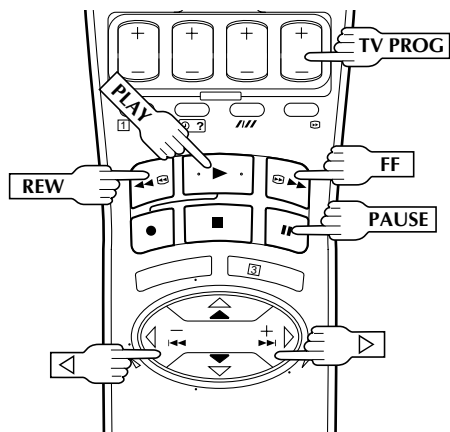
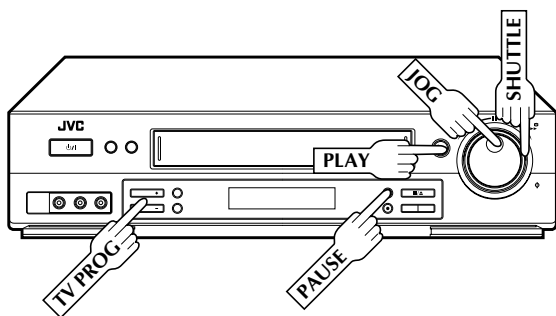
**NOTE:**

Refer to the **SHUTTLE** ring illustration to the right as you read the following procedures.

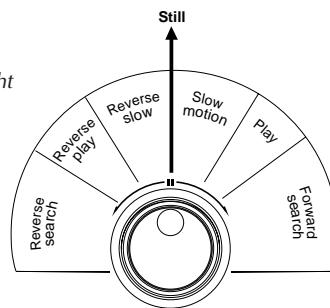

Still Picture/Frame-By-Frame Playback (For HR-J758E/EH)

1 PAUSE DURING PLAYBACK

Press **PAUSE**. If there is vertical jitter, use the **TV PROG** buttons to correct the picture.

2 ACTIVATE FRAME-BY-FRAME PLAYBACK

Turn the **JOG** dial to the right for forward frame-by-frame playback, or to the left for reverse frame-by-frame playback.

OR

Press **PAUSE**.

OR

Press ◀ or ▶.

To resume normal playback, press **PLAY**.

Slow Motion (For HR-J758E/EH)

1 ACTIVATE SLOW-MOTION PLAYBACK

During playback or still, turn the **SHUTTLE** ring to the right for forward slow motion, or to the left for reverse slow motion (refer to the illustration above).

OR

During still picture, press and hold **PAUSE** for 2 seconds, then release. Press and release again to return to still picture.

OR

During still picture, press and hold ◀ or ▶. Release to return to still picture.

To resume normal playback, press **PLAY**.

High-Speed (Turbo) Search (For HR-J758E/EH)

1 ACTIVATE HIGH-SPEED SEARCH

During playback or still, turn the **SHUTTLE** ring all the way to the right for forward high-speed search, or to the left for reverse high-speed search. Releasing **SHUTTLE** resumes still picture playback.

OR

- For forward high-speed search, turn the **SHUTTLE** ring all the way to the right and release it within 1 second.
- For reverse high-speed search, turn the **SHUTTLE** ring all the way to the left and release it within 1 second.

OR

During playback or still, press **FF** for forward high-speed search, or **REW** for reverse high-speed search.

To resume normal playback, press **PLAY**.

NOTE:

For short searches, press and hold **FF** or **REW** for over 2 seconds during playback or still picture. When released, normal playback resumes.

ATTENTION

In the search, still, slow-motion or frame-by-frame playback mode,

- the picture will be distorted.
- the noise bars will appear.
- there will be a loss of colour with an LP-recorded tape.

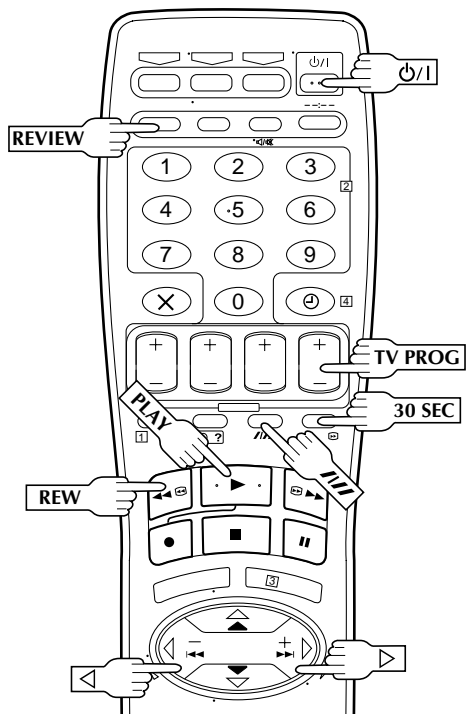
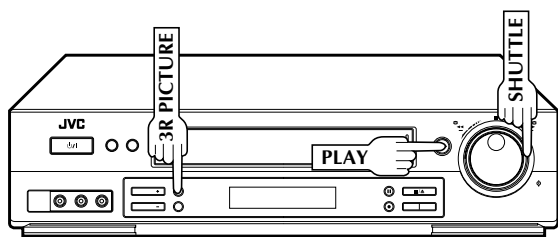

3R Picture

3R (= Resolution and Response Recovery technology) maximises sense of resolution and sharpens image edges to make playback picture look better focused.

1

ACTIVATE 3R PICTURE

Press **3R PICTURE**. The button will light.

- To turn off 3R Picture, press **3R PICTURE** again so that the light goes off.
- Normally it is recommendable to keep 3R Picture ON (with the button lit).
- Depending on the type of tape used, picture quality may be better with 3R Picture set to off.
- If you use this recorder as the player for editing, be sure to turn off 3R Picture before starting.
- The setting will remain effective even though you turn on/off the recorder.

Variable-Speed Search (For HR-J758E/EH)

If you own the HR-DD858E/EH, see page 18.

1

ACTIVATE VARIABLE-SPEED SEARCH

During playback or still, turn the **SHUTTLE** ring to the right for forward variable-speed search, or to the left for reverse variable-speed search (refer to the illustration on page 13).

OR

During playback, press ◀ or ▶.

- The more times you press, the faster the playback picture moves.
- To decrease speed, press the button for the opposite direction.

To resume normal playback, press **PLAY**.

NOTE:

In the search, still, or frame by frame playback mode, the picture will be distorted, and there will be a loss of colour.

Manual Tracking

Your video recorder is equipped with automatic tracking control. During playback, you can override this and adjust the tracking manually by pressing the **TV PROG** buttons.

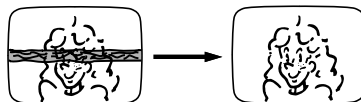

1

OVERRIDE AUTOMATIC TRACKING

Press **///** on the remote to engage manual tracking.

2

ADJUST TRACKING MANUALLY

Press **TV PROG +** or **-** to adjust tracking.

3

RETURN TO AUTOMATIC TRACKING

Press **///** on the remote to re-engage automatic tracking.

NOTE:

When a new tape is inserted, the recorder enters the automatic tracking mode automatically.

Index Search

Your recorder automatically marks index codes at the beginning of each recording. This function gives you quick access to any one of 9 index codes in either direction.

NOTE:

Before starting, make sure the recorder is in the Stop mode.



1 ACTIVATE INDEX SEARCH

Press ◀ or ▶ (◀◀◀ or ▶▶▶). "◀◀◀ 1" or "▶▶▶ 1" is displayed on screen and search begins in the corresponding direction.

- To access index codes 2 through 9, press ◀ or ▶ repeatedly until the correct index number is displayed.
Ex.: To locate the beginning of B from the current position, press ◀ twice.
To locate the beginning of D from the current position, press ▶ once.

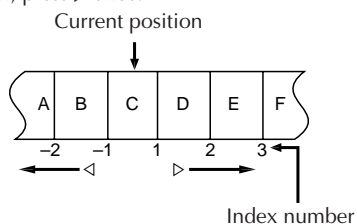

- When the specified index code is located, playback begins automatically.

Instant ReView

Simply by pressing a single button, the recorder power comes on, rewinds, and begins playback of the last timer-recorded programme. If you have several programmes recorded, you can easily access any of them.

NOTE:

Before starting, make sure that the recorder is off and that the Timer mode is disengaged.

1 ACTIVATE INSTANT REVIEW

Press **REVIEW**. The recorder power comes on and the recorder searches for the index code indicating the start of the last timer-recorded programme. Once it's found, playback begins automatically.

- The front display panel tells you how many programmes have been timer-recorded. If you have, for example, 3 programmes, "REVIEW" and "3" appear and blink. To watch the first of the 3 programmes, press **REVIEW** three times. The recorder searches and begins playback automatically. You can access a programme as far as 9 index codes away from the current tape position.

NOTES:

- Instant ReView is not possible while the recorder is in the Timer mode.
- The number of recorded programmes will not be displayed on the front display panel after Auto Satellite Prog recording (☞ pg. 32).

Skip Search

1 SKIP OVER UNWANTED SECTIONS

Press **30 SEC 1** to 4 times during playback. Each press initiates a 30-second period of fast-motion playback. Normal playback resumes automatically.

NOTES:

- To return to normal playback during a Skip Search, press **PLAY**.
- For HR-DD858E/EH Owners:
 - It will be 9x normal playback speed with TimeScan (☞ pg. 18) during a Skip Search.
 - Skip Search does not work properly during NTSC playback.

Next Function Memory

You can set your recorder's power to go off automatically after the tape is fully rewound. Before starting, make sure the recorder is in the Stop mode.

For Automatic Power Off After Tape Rewind . . .
. . . press **REW**, then press **⏻/I** within 2 seconds.

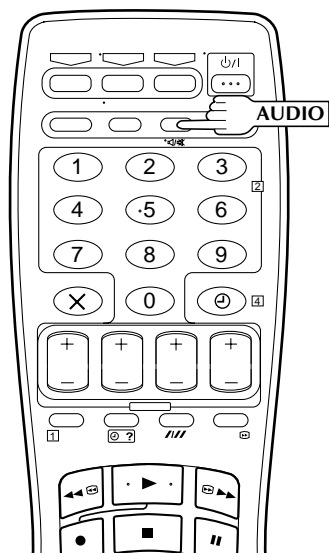
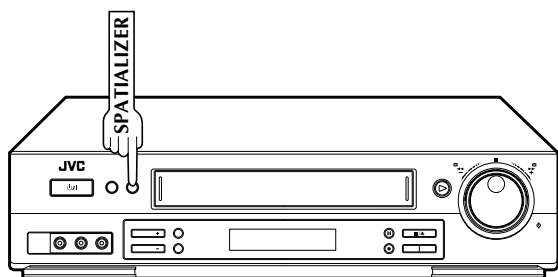



Spatializer®

This feature expands sound field when you play back any stereo source or view a stereo programme while recording it.
*Spatializer® has no effect on recording quality.

1 ACTIVATE SPATIALIZER®

Press **SPATIALIZER**; the current setting will be displayed on the screen for about 5 seconds. Pressing **SPATIALIZER** while the screen shows the display changes the setting.

- To view a stereo programme such as movies or music, select "SPATIALIZER  to create more spacious sound.
- To view a monaural programme, select "SPATIALIZER → ST" which simulates a stereo effect.
- Select "SPATIALIZER OFF" to turn off Spatializer® if the sound becomes unnatural with either "SPATIALIZER  or "SPATIALIZER → ST" selected.
- If your TV is equipped with 3D-PHONIC and if you use both Spatializer® and 3D-PHONIC at the same time, the sound may become unnatural; set either function to "OFF".
- The setting will remain effective even though you turn on/off the recorder.

NOTES:









- Spatializer® is effective only with a stereo TV.
- You can change the Spatializer® setting even though "O.S.D." is set to "OFF".
- The setting cannot be changed during search, still, frame-by-frame playback or slow motion mode.
- When this recorder is used as the player for editing, the recorded audio will correspond to the Spatializer® setting.

Soundtrack Selection



Your video recorder is capable of recording three soundtracks (HI-FI L, HI-FI R and NORM) and will play back the one you select.

During Playback

Pressing **AUDIO** on the remote control changes the soundtrack being played back as follows:

TRACK		USE
Recorder's Front Panel	On-Screen Display	
 + 	HI FI L  R	For Hi-Fi stereo tapes
	HI FI L 	For main audio of Bilingual tapes
	HI FI  R	For sub audio of Bilingual tapes
NORM	NORM	For audio-dubbed tapes
 +  + NORM	HI FI NORM	For audio-dubbed tapes

NOTES:

-  +  should normally be selected. In this mode, Hi-Fi stereo tapes are played back in stereo, and the normal audio track is played back automatically for tapes with only normal audio.
- For instructions on recording stereo and bilingual programmes, refer to page 22.
- "O.S.D." must be set to "ON" or the on-screen displays will not appear ( pg. 8).

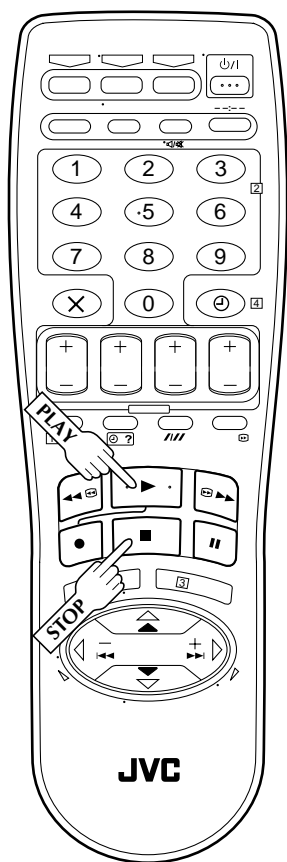
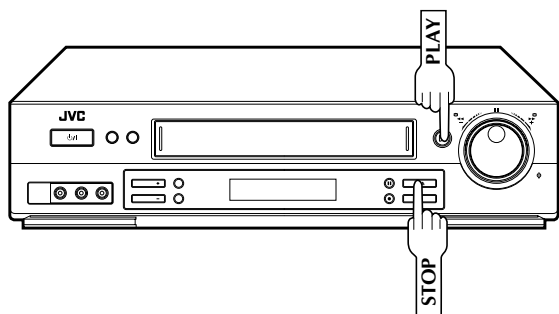

Repeat Playback

Your video recorder can automatically play back the whole tape 50 times repeatedly.

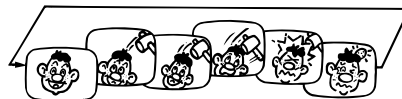

1 START PLAYBACK

Press **PLAY**.

2 ACTIVATE REPEAT PLAYBACK

Press **PLAY** and hold for over 5 seconds, then release.

- The Play indicator (▶) on the display panel blinks slowly.
- The tape plays 50 times automatically, and then stops.

3 STOP PLAYBACK

Press **STOP** at any time to stop playback.

NOTE:

Pressing **PLAY**, **REW**, **FF** or **PAUSE** also stops Repeat Playback.

TimeScan

(HR-DD858E/EH only)

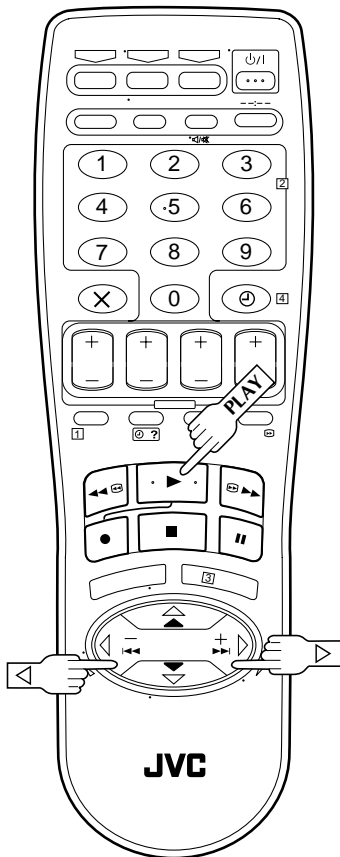
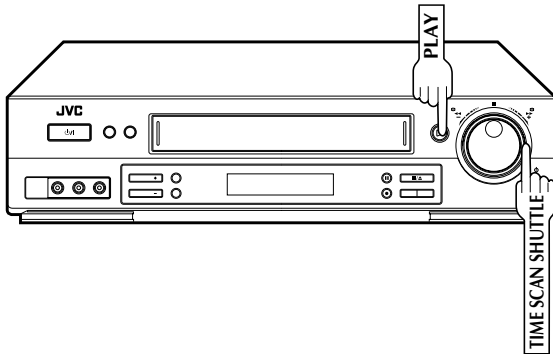

Your recorder is equipped with the TimeScan function. TimeScan allows noise free pictures to be displayed on your TV screen in the forward and reverse search modes. Audio will be played back at normal speed during the TimeScan modes (☞ pg. 19). TimeScan allows you to view a programme in search mode while listening to the audio.

NOTES:

- "TIME SCAN AUDIO" must be set to "ON", or the sound will not be heard in TimeScan mode. (☞ pg. 19)
- The audio will not synchronize with the video in TimeScan modes.
- In Pause mode 3 seconds (approx.) of audio will be played back repeatedly. (☞ pg. 12)
- In TimeScan search modes some of the audio information will not be played so that the audio can keep up with the video.
- Slow motion is not possible with TimeScan.

Audio signal during TimeScan

Playback tape



Sound of ①, ③ and ⑤ is heard.

Sound of ② and ④ is not heard.

Output audio signal is normal (monaural) sound.

Variable-Speed Search

(HR-DD858E/EH only)

ACTIVATE VARIABLE-SPEED SEARCH

1

During playback or still, turn the recorder's **TIME SCAN SHUTTLE** ring. It remains at that position even after you release it. Each time it passes a click position, the playback speed changes. (Refer to the chart on pg 19 for playback speeds).

OR

During playback, press ◀ or ▶.

- The more times you press, the faster the playback picture moves.
- To decrease speed, press the button for the opposite direction. (Refer to the chart on pg 19 for playback speeds).

To resume normal playback, press **PLAY**.

If the picture jitters vertically during variable-speed search:

- 1 Press **PAUSE**.
- 2 Press **TV PROG +** or **-** so that the vibration stops.

TimeScan

Names of special-effects playback	Reverse				Forward			
	Search	Play	Slow-Motion	*Still	Slow-Motion	Play	Search	
Speed SP	-9x -7x -5x -3x	-1x	-1/6x -1/18x	0	1/18x 1/6x	1x	2x 3x 5x 7x 9x	
Speed LP	-7x -3x	-1x	-1/6x -1/18x	0	1/18x 1/6x	1x	2x 5x 9x	
Audio output	Audio is output.		Audio is not output.		Audio is not output.		Audio is output.	

* Still mode cannot be engaged using the remote control's <| or >| button. Still mode can be engaged by pressing the **PAUSE** button.

- The speed is shown during TimeScan in the upper right corner of the TV screen for approx. 5 seconds. (The display may be distorted.)
- To resume normal playback, press **PLAY**.
- When using the recorder's **TIME SCAN SHUTTLE** ring, the playback speed may not change in the correct step if it is turned too fast.
- Picture and audio may become distorted when the recording speed changes. When this happens, resume normal playback once, and then try using TimeScan again.
- The picture may be noisy or there may be a loss of colour when you change the playback speed. (More noise will appear with LP recordings.)
- Noise may appear or the upper part of the picture may be distorted during still, frame-by-frame playback, 2x search of LP recordings, or depending on the tape being used.
- Picture may appear distorted in comparison to normal playback.
- In TimeScan mode there will be a time lag between the video and the audio and noise may appear in the audio signal.
- TimeScan sound quality will differ in comparison to normal playback.
- When material such as music videos where there is non-stop sound (very few breaks in the soundtrack) are viewed at 2x normal speed, the audio playback may be faster than normal.
- When the playback direction is reversed, it takes approximately 6 seconds until sound is heard.
- Picture will be monochrome with an LP-recorded MESECAM tape during TimeScan.
- When playing back an NTSC tape, the speeds differ from those listed above and are not shown on the TV screen. Also, depending on the type of tape being used, the picture may be distorted and there may be a loss of colour even when in the TimeScan mode.

If you don't want to hear TimeScan audio, set "TIME SCAN AUDIO" to "OFF" (See below).

TimeScan Audio

The audio output can be set ON/OFF during TimeScan. Select ON/OFF as required.

* The default setting is "ON".

- 1 Press **MENU** to access the Main Menu screen.
- 2 Move the highlight bar (pointer) to "MODE SET" by pressing Δ / ∇ , then press **OK** or \triangleright .
- 3 Move the highlight bar (pointer) to "TIME SCAN AUDIO" by pressing Δ / ∇ , then press **OK** or \triangleright to select "ON" or "OFF".
- 4 Press **MENU** to return to the normal screen.

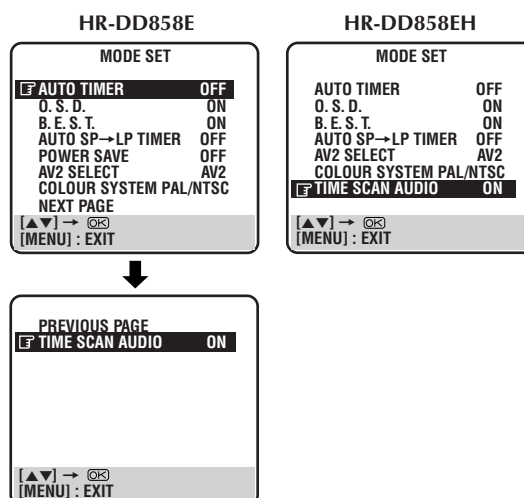

Basic Recording

Turn on the TV and select the VIDEO channel (or AV mode).

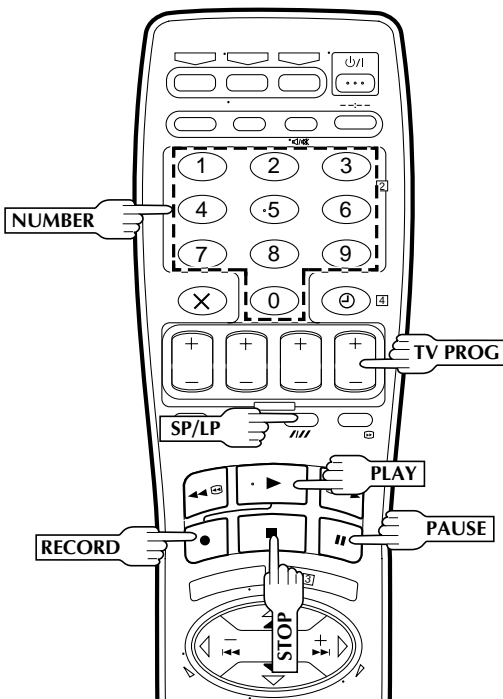
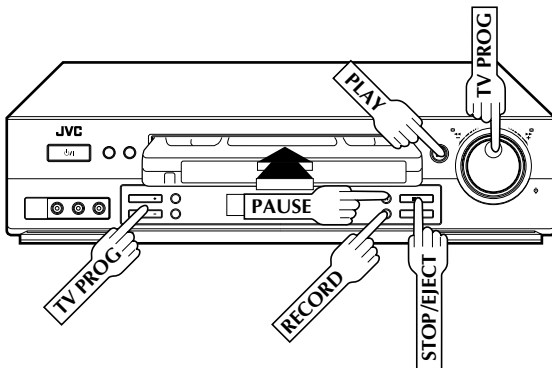

Recording Resume Function

If there is a power outage during recording (or Instant Timer Recording or timer recording), the recording will resume automatically when power is restored to the recorder unless the recorder's memory backup has expired.

TV signals being received by the recorder's built-in tuner can be recorded onto a video tape. You can "capture" a TV programme using your video recorder.

1 LOAD A CASSETTE

Insert a cassette with the record safety tab intact.

- The counter is reset to 0:00:00 and the recorder power comes on automatically.

2 CHOOSE A PROGRAMME

Press **TV PROG +/-** or the **NUMBER** keys to select the channel you wish to record.

- The **TV PROG** dial can also be used to select a channel.

3 SET TAPE SPEED

Press **SP/LP (//)**. Check the SP/LP indicator on the recorder display panel to confirm the selected tape speed.

- The HR-J758E/EH owners can use the **SP/LP** button on the recorder's front panel as well.

4 START RECORDING

Press and hold **RECORD** and press **PLAY** on the remote control, or press **RECORD** on the recorder.

B.E.S.T. takes place at the beginning of both the first SP and the first LP recording after inserting the cassette (see pg. 24).

5 PAUSE/RESUME RECORDING

Press **PAUSE**. Press **PLAY** to resume recording.

6 STOP RECORDING

Press **STOP** on the remote control or **STOP/EJECT** on the recorder. Then press **STOP/EJECT** to remove the cassette.

Accidental erasure prevention

- To prevent accidental recording on a recorded cassette, remove its safety tab. To record on it later, cover the hole with adhesive tape.

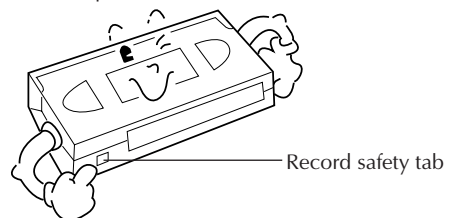

Recording Features

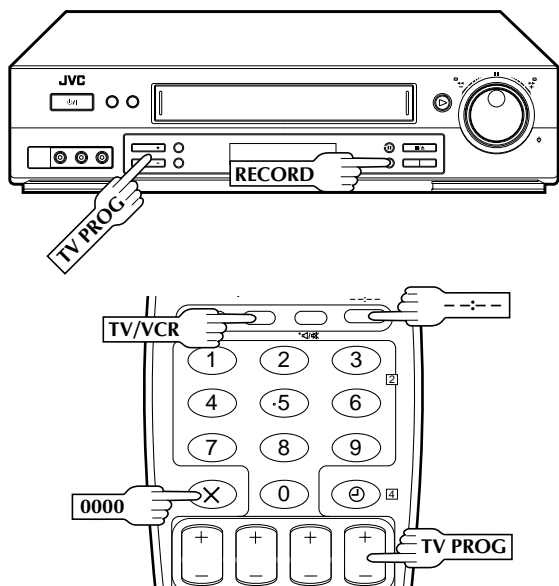

Instant Timer Recording (ITR)

This easy method lets you record for from 30 minutes to 6 hours (selectable in 30-min. increments), and shuts the recorder off after recording is finished.

- 1** **START RECORDING**
Press **RECORD** on the recorder.
- 2** **ENGAGE ITR MODE**
Press **RECORD** again. "0" blinks and 0:30 appears on the front display panel.
- 3** **SET RECORDING DURATION**
If you want to record for more than 30 minutes, press **RECORD** to extend the time. Each press extends recording time by 30 minutes.

NOTE:

You can only perform ITR using the **RECORD** button on the recorder's front panel.

Record One Programme While Watching Another

If your recorder is connected to the TV via AV connection, press **TV/VCR**. The recorder's VCR indicator and the TV broadcast being recorded disappear.

1 SELECT CHANNEL TO WATCH

Once recording is in progress, all you need to do is to set the channel controls on the TV for the station you wish to view.

- The programme selected with the TV's channel controls appears on the TV screen while the one selected with the recorder's **TV PROG** buttons is recorded on the tape.
- If a decoder is connected to the recorder (see pg. 43), you can select a scrambled channel as well with the TV channel controls.

Elapsed Recording Time Indication

You can check the exact time of a recording.

1 SET COUNTER DISPLAY

Press **--:--** until a counter reading appears on the display panel.

- The HR-J758E/EH owners can use the **DISPLAY** button on the recorder's front panel as well.

2 RESET COUNTER

Press **0000** before starting recording or playback.

- The counter is reset to "0:00:00" and shows the exact elapsed time as the tape runs.

Tape Remaining Time

1 DISPLAY REMAINING TIME

Press **--:--** until the time remaining on the tape appears.

- The display panel shows the tape remaining time with "▶" displayed.
- By pressing the **--:--** button, you can change the display to show the counter reading, channel position*, clock time or tape remaining time.
* channel position is not displayed during playback.
- The HR-J758E/EH owners can use the **DISPLAY** button on the recorder's front panel as well.

NOTE:

Depending on the type of tape used, there may be times when the tape remaining time reading may not appear right away, or is not correct. "--:--" may sometimes appear, or the display may blink on occasion.

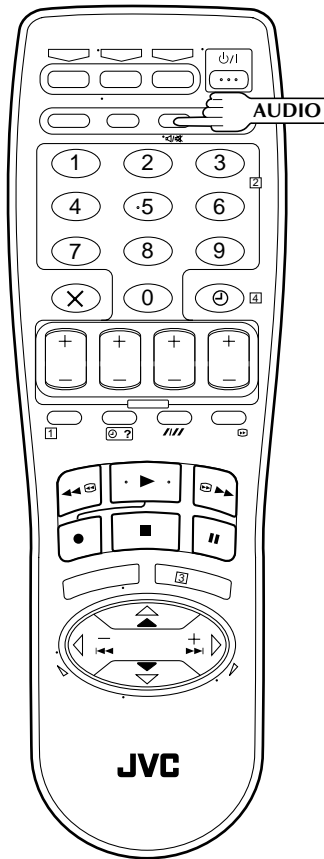

Receiving Stereo And Bilingual Programmes

Your recorder is equipped with a Sound-Multiplex decoder (A2) and, if you own the HR-J758EH or HR-DD858EH, a Digital stereo sound decoder (NICAM) as well, making reception of stereo and bilingual broadcasts possible.

When the channel is changed, the type of broadcast being received will be displayed on the TV screen for a few seconds.

Type of Broadcast Being Received	On-screen Display
A2 Stereo	ST
A2 Bilingual	BIL
Regular Monaural	(none)
*NICAM Stereo	ST NICAM
*NICAM Bilingual	BIL NICAM
*NICAM Monaural	NICAM

*Available with HR-J758EH or HR-DD858EH only.

- To listen to a stereo programme, press **AUDIO** until "ST" and "HIFI L R" appear on the front display panel or "HIFI L R" appears on the screen.
- To listen to a bilingual programme, press **AUDIO** until "BIL" or "HIFI L R" appears on the front display panel, or "HIFI L R" or "HIFI R" appears on the screen (as required).
- To listen to the Standard (regular monaural) audio while receiving a NICAM broadcast, press **AUDIO** until "NORM" appears on the front display panel or on the screen. (HR-J758EH or HR-DD858EH only)

NOTE:

"O.S.D." must be set to "ON" or the on-screen displays will not appear (☞ pg. 8).

To Record Stereo And Bilingual Programmes (A2)

- Stereo programmes are automatically recorded in stereo on the Hi-Fi audio track (with the normal audio track recording mixed L and R channel sound).
- Bilingual programmes are automatically recorded in bilingual on the Hi-Fi audio track. The main soundtrack will be recorded on the normal audio track.

To Record NICAM Stereo And Bilingual Programmes (HR-J758EH or HR-DD858EH only)

The NICAM audio programme will be recorded on the Hi-Fi audio track, and the Standard audio programme on the normal audio track.

NOTES:

- If the quality of stereo sound being received is poor, the broadcast will be received in monaural with better quality.
- Before playing back a programme recorded in stereo, or a bilingual programme, refer to "Soundtrack Selection" (☞ pg. 16).

Hi-Fi Audio Recording Level Control (HR-DD858E/EH only)

Your recorder allows manual adjustment of the Hi-Fi audio recording level. Normally the preset audio recording level is satisfactory, but if the sound you are going to record is too loud or too low, adjust the audio recording level while referring to the recorder's audio level meters.

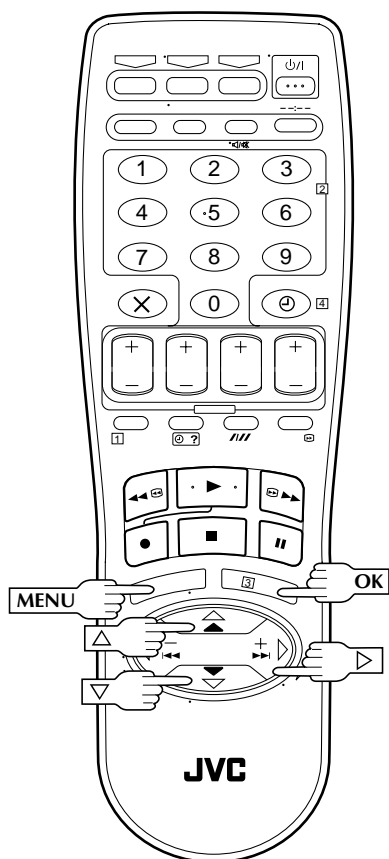

1 ACCESS MAIN MENU SCREEN

Press **MENU**.

2 ACCESS HI-FI REC LEVEL CONTROL SCREEN

Press Δ / ∇ to move the highlight bar (pointer) to "REC LEVEL CTL", then press **OK** or \triangleright .

3 SELECT MODE

Move the highlight bar (pointer) to "MANUAL" by pressing Δ / ∇ , then press **OK** or \triangleright .

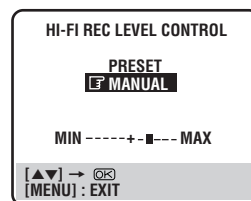

4 ADJUST AUDIO RECORDING LEVEL

Press Δ or ∇ .

- Press Δ or ∇ briefly 5 times to move the on-screen's audio levels by one division on the scale. To move the audio levels faster, keep Δ or ∇ pressed.
- Adjust the recording level while watching the recorder's audio level meters. Set the level so that maximum volume causes the meters to vary between 0dB to 4dB.

5 RETURN TO NORMAL SCREEN

Press **MENU**.

NOTE:

Noise will increase if the recording level is too low, while distortion will increase if the level is too high.

B.E.S.T. Picture System

Turn on the TV and select the VIDEO channel (or AV mode).

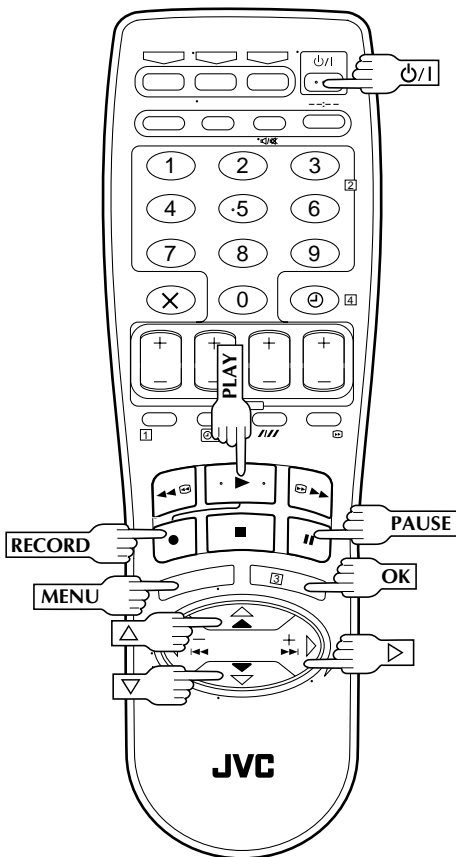
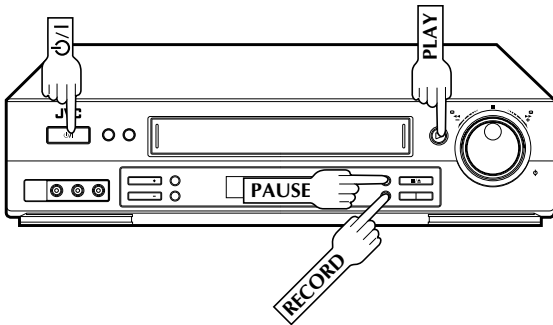

The B.E.S.T. (Biconditional Equalised Signal Tracking) system checks the condition of the tape in use during recording and playback, and compensates to provide the highest-possible recording and playback pictures. The default setting for both recording and playback is "ON".

Preparation

1 TURN ON THE RECORDER

Press $\phi/1$.

2 ACCESS MAIN MENU SCREEN

Press MENU.

3 ACCESS MODE SET SCREEN

Press $\Delta\nabla$ to move the highlight bar (pointer) to "MODE SET", then press **OK** or \triangleright .

- "REC LEVEL CTL" appears only with the HR-DD858E and HR-DD858EH.

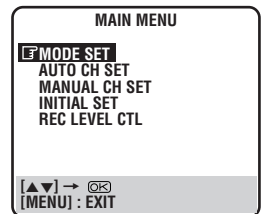

4 SELECT B.E.S.T. MODE

Press $\Delta\nabla$ to move the highlight bar (pointer) to "B.E.S.T.", then press **OK** or \triangleright to set to "ON" or "OFF".

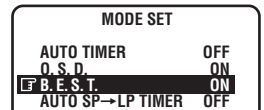

5 RETURN TO NORMAL SCREEN

Press MENU.

Recording

START RECORDING

1 Press and hold **RECORD** and press **PLAY** on the remote, or press **RECORD** on the recorder.

DURING B.E.S.T.

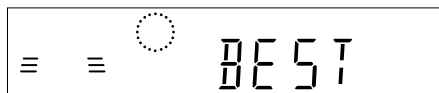

B.E.S.T. COMPLETE

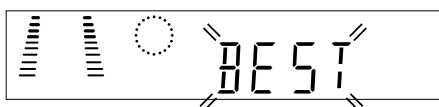

- The recorder spends approximately 7 seconds assessing the condition of the tape, then begins recording.

NOTES:

- The B.E.S.T. system works for both SP and LP modes only after a tape has been inserted and the Record mode is first initiated. It does not work during recording.
- The B.E.S.T. system does not work while Auto Satellite Prog recording is in progress (☞ pg. 32).
- In the case of timer recording, the B.E.S.T. system works before recording is initiated.
- Once the cassette is ejected, the B.E.S.T. data is cancelled. The next time the cassette is used for recording, B.E.S.T. is re-performed.
- Pressing the recorder's **RECORD** button while "BEST" is displayed does not start Instant Timer Recording (☞ pg. 21).

ATTENTION

*Since the B.E.S.T. system works before recording actually starts, there is a delay of approximately 7 seconds after **RECORD** and **PLAY** on the remote are pressed, or **RECORD** on the recorder is pressed. To make sure you record the desired scene or programme in its entirety, first perform the following steps:*

- 1) Press and hold **PAUSE** and press **RECORD** to engage the **RECORD PAUSE** mode.
 - The recorder then automatically checks the condition of the tape and, after approximately 7 seconds, re-enters **RECORD PAUSE**.
- 2) Press **PLAY** to start recording.
 - If you want to bypass the B.E.S.T. system and begin recording immediately, set "B.E.S.T." to "OFF" in step 4 on page 24.

Playback

The recorder assesses the quality of the tape once you initiate playback.

START PLAYBACK

1 Press **PLAY**.

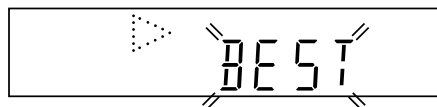

- The recorder adjusts the playback picture quality based on the quality of the tape in use.
- B.E.S.T. is active during Auto Tracking. "BEST" appears blinking on the recorder's display panel.

NOTES:

- When watching a tape recorded with "B.E.S.T." set to "ON", it is recommended that you leave B.E.S.T. on during playback as well.
- When watching a rental tape or one recorded on another video recorder, or when using this recorder as the player for editing, set B.E.S.T. to your preference by performing steps 1 through 5 on page 24.
- "BEST" only appears at the beginning of automatic tracking. Even though it doesn't appear after that, the B.E.S.T. function is operative.

SHOWVIEW Timer Programming

Before performing SHOWVIEW Timer Programming:

- Make sure that the recorder's built-in clock is set properly.
- Insert a cassette with the safety tab in place. The recorder will come on automatically.
- Turn on the TV and select the VIDEO channel (or AV mode).

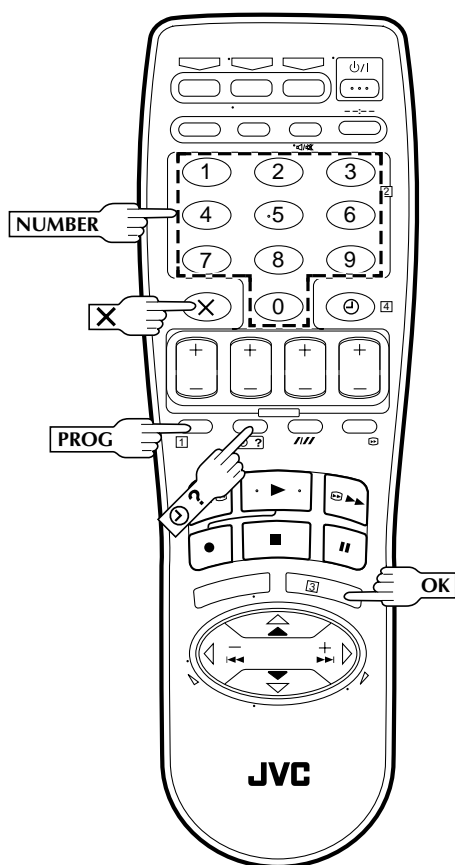

1

ACCESS SHOWVIEW SCREEN

Press **PROG**.

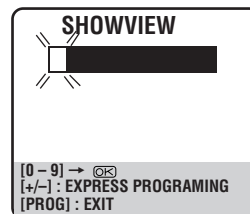

The front display panel looks like this:

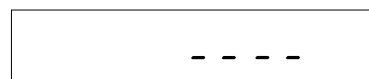

2

ENTER SHOWVIEW NUMBER

Press the **NUMBER** keys to enter the **SHOWVIEW** number of a programme you wish to record.

- If you make a mistake, press **X** and input the correct number.

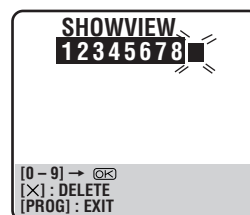

The **SHOWVIEW** number you enter appears on the front display panel:

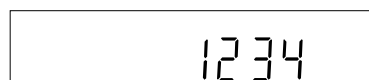

The display panel can show only a 4-digit number.

3

ACCESS SHOWVIEW PROGRAM SCREEN

Press **OK**, and the **SHOWVIEW** Program screen appears (if you're just starting out, "P1" appears).

The display panel shows the programme start time. Pressing **?** changes the display to the programme stop time, then the date and channel position.

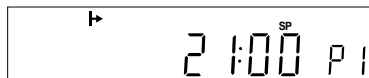
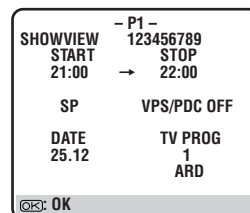

IMPORTANT

Make sure the channel position number you wish to record is displayed; if not, see "SHOWVIEW Setup" on page 53 and set the Guide Program number for that **SHOWVIEW** number correctly.

- If the number you entered is invalid, "ERROR" appears on the screen and "Err" appears on the display panel. Press **X** and input a valid **SHOWVIEW** number.
- If the "GUIDE PROG SET" screen appears, see "ATTENTION – Regarding Guide Program Number Set" on page 27.

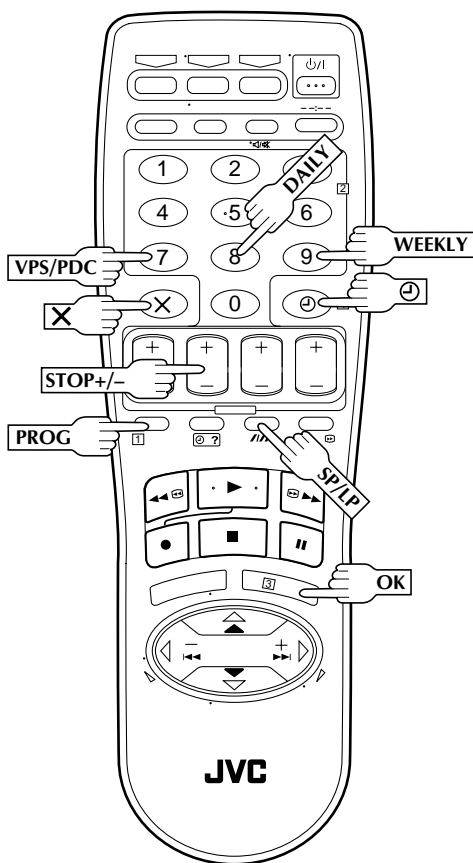

Satellite Tuner Users

To timer-record a satellite broadcast using SHOWVIEW:

- 1 Set "AV2 SELECT" to "AV2" (☞ pg. 37).
- 2 Perform steps 1 – 7.
- 3 Set the satellite tuner to the appropriate channel before the selected programme begins.
- 4 Leave the satellite tuner's power on.

ATTENTION

Regarding Guide Program Number Set

"GUIDE PROG SET" appears after performing step 3 if the Guide Program number for the SHOWVIEW number you entered has not been set.

- Press the **NUMBER** keys or Δ / ∇ to input the channel position number on which your recorder receives that station, then press **OK** or \triangleright . The SHOWVIEW program screen appears.

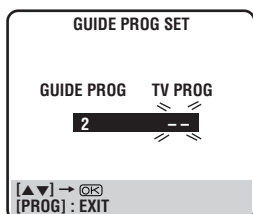

(Ex.) To timer-record a ZDF programme with SHOWVIEW.

* If your recorder receives ZDF on the channel position 2, press **OK** or \triangleright after entering "2".

4 SET TAPE SPEED

Press **SP/LP** (**||||**) to set the tape speed.

5 SET VPS/PDC MODE

Press **VPS/PDC** to select "ON" or "OFF".

If "VPS/PDC ON" is displayed on the screen or "VPS/PDC" is lit on the display panel, VPS/PDC is set to ON. If "VPS/PDC OFF" is displayed on the screen or "VPS/PDC" is not lit on the display panel, VPS/PDC is set to OFF. ☞ "VPS/PDC Recording" on page 29.

6 RETURN TO NORMAL SCREEN

Press **PROG** or **OK**. "PROGRAM COMPLETED" appears on the screen for about 5 seconds, then normal screen appears.

- Repeat steps 1 – 6 for each additional programme.

7 ENGAGE RECORDER'S TIMER MODE

Press \ominus (**TIMER**). The recorder turns off automatically and \ominus appears on the display panel.

- To disengage the timer, press \ominus (**TIMER**) again.

NOTES:

- To Change The Stop Time . . .
 . . . press **STOP +/-** after pressing **OK** in step 3. You can compensate for anticipated programme schedule delays this way.
- To Timer-Record Weekly Or Daily Serials . . .
 . . . after pressing **OK** in step 3, press **WEEKLY** (**NUMBER** key "9") for weekly serials or **DAILY** (**NUMBER** key "8") for daily serials (Monday – Friday). Either "WEEKLY" or "DAILY" appears on the screen. Pressing the button again makes the corresponding indication disappear.
- You can programme this recorder to timer-record as many as 8 programmes. If you try to programme the recorder to record a ninth, "PROGRAM FULL" appears on screen and "FULL" appears on the front display panel. To record the extra programme, you must first cancel any unnecessary programmes (☞ pg. 30).
- It is not possible to timer-record a TV programme with a SHOWVIEW number which starts with "0".

Timer Warning

If you have programmed your recorder to timer-record a programme or a series of programmes, a warning appears on screen to tell you that the recording is to start in 5 minutes.

– WARNING –
 TIMER RECORDING
 TO START SOON
 [X]

NOTES:

- The warning only appears if you're not in the Timer mode at that time.
- If this recorder is being used as the player for tape dubbing, the warning screen is recorded on the tape in the other video recorder.

The warning blinks for the entire 5 minutes leading up to the start of timer recording. To clear the display, press **X**.

Express Timer Programming

Before performing Express Timer Programming:

- Make sure that the recorder's built-in clock is set properly.
- Insert a cassette with the safety tab in place. The recorder will come on automatically.
- Turn on the TV and select the VIDEO channel (or AV mode).

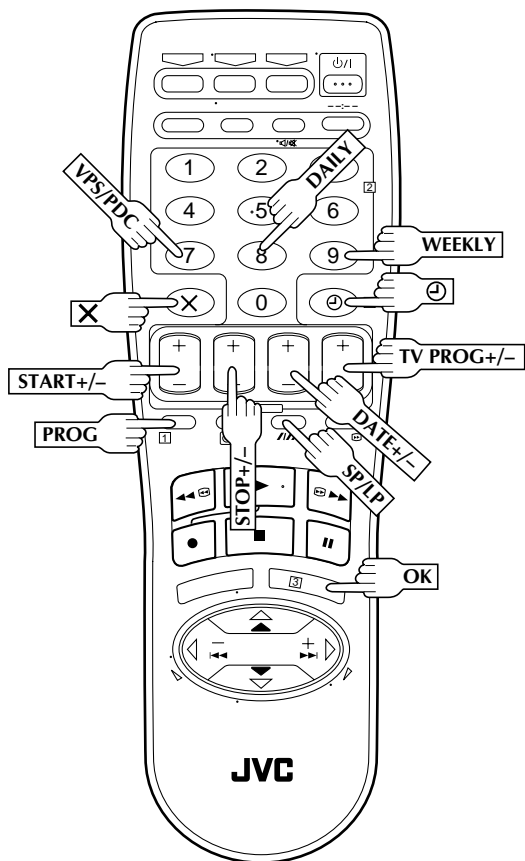

If you don't know the SHOWVIEW number for the programme you wish to record, use the following procedure to set your recorder to timer-record the programme.

1 ACCESS SHOWVIEW SCREEN

Press **PROG**.

2 ACCESS PROGRAMME SCREEN

Press **START +/-**. (If you're just starting out, "P1" appears.)

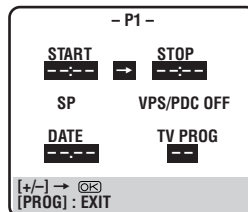

The front display panel looks like this:

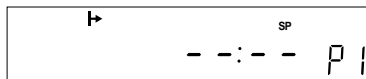

3 ENTER PROGRAMME START TIME

Press **START +/-** to enter the time you want recording to start.

- Press and hold **START +/-** to move in 30-minute increments, or press and release repeatedly to move 1 minute at a time.

The front display panel looks like this:

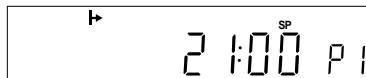

4 ENTER PROGRAMME STOP TIME

Press **STOP +/-** to enter the time you want recording to stop.

- Press and hold **STOP +/-** to move in 30-minute increments, or press and release repeatedly to move 1 minute at a time.

5 ENTER PROGRAMME DATE

Press **DATE +/-**. (The current date appears on screen. The date you enter appears in its place.)

6

ENTER CHANNEL POSITION

Press TV PROG +/-.

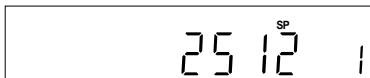
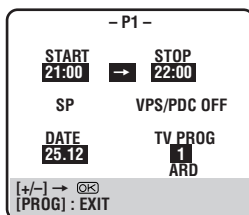

7

SET TAPE SPEED

Press SP/LP (||||) to set the tape speed.

8

SET VPS/PDC MODE

Press VPS/PDC to select "ON" or "OFF".

If "VPS/PDC ON" is displayed on the screen or "VPS/PDC" is lit on the display panel, VPS/PDC is set to ON. If "VPS/PDC OFF" is displayed on the screen or "VPS/PDC" is not lit on the display panel, VPS/PDC is set to OFF.

☞ "VPS/PDC Recording" in the right column.

9

RETURN TO NORMAL SCREEN

After confirming all information is correct, press **PROG** or **OK**. "PROGRAM COMPLETED" appears on the screen for about 5 seconds, then normal screen appears.

- Repeat steps 1 – 9 for each additional programme.

10

ENGAGE RECORDER'S TIMER MODE

Press **⊖** (TIMER). The recorder turns off automatically and **⊖** appears on the display panel.

- To disengage the timer, press **⊖** (TIMER) again.

To Timer-Record Weekly Or Daily Serials . . .

. . . anytime during steps 2 through 9, press **WEEKLY** (NUMBER key "9") for weekly serials or **DAILY** (NUMBER key "8") for daily serials (Monday – Friday). Either "WEEKLY" or "DAILY" appears on the screen. Pressing the button again makes the corresponding indication disappear.

NOTE:

You can programme this recorder to timer-record as many as 8 programmes. If you try to programme the recorder to record a ninth, "PROGRAM FULL" appears on screen and "FULL" appears on the front display panel. To record the extra programme, you must first cancel any unnecessary programmes (☞ pg. 30).

Satellite Tuner Users

To timer-record a satellite broadcast using Express Timer Programming:

- 1 Set "AV2 SELECT" to "AV2" (☞ pg. 37).
- 2 Perform steps 1 – 10. Enter "L-2" for the channel position in step 6.
- 3 Set the satellite tuner to the appropriate channel before the selected programme begins.
- 4 Leave the satellite tuner's power on.

VPS/PDC Recording

Now available from some TV stations, PDC (Programme Delivery Control) and VPS (Video Programme System) are service designed to assure safe, accurate timer recording. With this system, special code signals are transmitted together with the audio/video signals. These code signals control your video recorder and have precedence over the advertised times you may have preset into the timer. This means that your recorder will start and stop recording when the preset TV programmes actually start and end — even if the broadcast time of a preset TV programme is changed.

NOTES:

- When you use Express Timer Programming, set the start time (VPS or PDC time) exactly as advertised in the TV listing. A different time than advertised will result in no recording.
- VPS/PDC recording is also possible when a satellite tuner or a cable system is connected to AV2 IN/DECODER on your recorder.
- VPS/PDC recording is also possible via the AV1 IN/OUT connector.

How to check if the station being received transmits a VPS/PDC signal

- 1 Press --:-- until the channel position appears on the display panel.
- 2 Hold down **START+** for about 5 seconds.
 - "VPS/PDC" appears blinking on the display panel. If a VPS/PDC signal is detected from the station, "VPS/PDC" will stop blinking. If no VPS/PDC signal is detected from the station, "VPS/PDC" will blink at a slower rate.
- 3 Press --:-- or **START+** again to return to normal display.

Timer Warning

If you have programmed your recorder to timer-record a programme or a series of programmes, a warning appears on screen to tell you that the recording is to start in 5 minutes.

- WARNING -
TIMER RECORDING
TO START SOON
[X]

NOTES:

- The warning only appears if you're not in the Timer mode at that time.
- If this recorder is being used as the player for tape dubbing, the warning screen is recorded on the tape in the other video recorder.

The warning blinks for the entire 5 minutes leading up to the start of timer recording. To clear the display, press X.

Check, Cancel And Replace Programmes

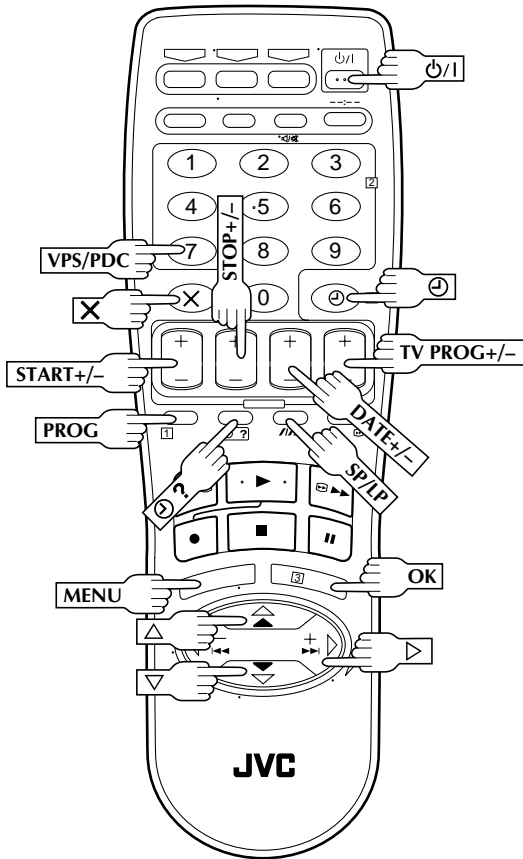

1 DISENGAGE TIMER MODE

Press \odot , then press $\odot/|$.

2 ACCESS PROGRAM CHECK SCREEN/DISPLAY

Press $\odot ?$.

PR	START	STOP	CH	DATE
1	8:00	10:00	3	24.12
2	10:00	10:45	2	25.12
3	11:30	13:00	1	25.12
4				
5				
6				
7				
8				

[$\odot ?$]: NEXT

P 1 P 8

3 ACCESS PROGRAM SCREEN/DISPLAY

Press $\odot ?$ again to check more information. Each time you press $\odot ?$, the next programme's information appears.

- P1 -	
START 8:00	STOP 10:00
SP	VPS/PDC OFF
DATE 24.12	TV PROG 3
	WDR

[$\odot ?$]: NEXT

8:00 P 1

- The display panel shows the programme start time. Pressing **OK** changes the display to the programme stop time, then the date and the channel position.

To cancel or replace a programme...

4 CANCEL OR REPLACE A PROGRAMME

Press **X** to cancel a programme. To replace a programme, press the appropriate button: **START+/-**, **STOP+/-**, **DATE+/-**, **TV PROG+/-**, **VPS/PDC**, **SP/LP** (///).

5 RETURN TO NORMAL SCREEN/DISPLAY

Press $\odot ?$ as many times as necessary. If there are still some programmes remaining, go on to step 6.

6 RETURN TO TIMER MODE

Press \odot .

NOTE:

You can also check the programmes on the display panel even if the recorder's power is off (unless the recorder is in the Power Save mode \square pg. 9) or the recorder is in the Timer mode; however, it is not possible to cancel or replace the programmes.

Auto SP→LP Timer

If, when timer-recording in SP mode, there is not enough tape to record the entire programme, the recorder automatically switches to LP mode to allow complete recording.

For Example . . .

Recording a programme of 210 minutes in length onto a 180-minute tape

Approximately 150 minutes Approximately 60 minutes

SP mode	LP mode
---------	---------

Total 210 minutes

Make sure you set "AUTO SP→LP TIMER" to "ON" at the Mode Set screen before the timer-recording starts.

1 ACCESS MAIN MENU SCREEN

Press **MENU**.

2 ACCESS MODE SET SCREEN

Press $\Delta\nabla$ to move the highlight bar (pointer) to "MODE SET", then press **OK** or \triangleright .

3 SELECT MODE

Press $\Delta\nabla$ to move the highlight bar (pointer) to "AUTO SP→LP TIMER", then press **OK** or \triangleright to select "ON".

MODE SET	
AUTO TIMER	OFF
O. S. D.	ON
B. E. S. T.	ON
AUTO SP→LP TIMER	ON

4 RETURN TO NORMAL SCREEN

Press **MENU**.

NOTES:

- If you have programmed the recorder to timer-record 2 or more programmes, the second programme and those thereafter may not fit on the tape if you set "AUTO SP→LP TIMER" to "ON". In this case, make sure the mode is not engaged, then set the tape speed manually during timer programming.
- In order to ensure that the recording fits on the tape, this feature may leave a slight non-recorded section at the end of the tape.
- There may be some noise and sound disturbance at the point on the tape where the recorder switches from SP to LP mode.
- The Auto SP→LP Timer feature is not available during ITR (Instant Timer Recording), and the feature will not work properly with any tapes longer than E-180 or with some tapes of shorter lengths.
- If you perform timer recording with both VPS/PDC and the Auto SP→LP Timer activated, and the programme goes beyond its originally scheduled length, there may be times when the programme cannot be recorded in its entirety.

Auto Timer

When the Auto Timer is set to ON the timer is automatically engaged when the recorder power is turned off and automatically disengaged when the recorder is powered back on.

1 ACCESS MAIN MENU SCREEN

Press **MENU**.

2 ACCESS MODE SET SCREEN

Press $\Delta\nabla$ to move the highlight bar (pointer) to "MODE SET", then press **OK** or \triangleright .

- "REC LEVEL CTL" appears only with the HR-DD858E and HR-DD858EH.

MAIN MENU	
MODE SET	
AUTO CH SET	
MANUAL CH SET	
INITIAL SET	
REC LEVEL CTL	
[$\Delta\nabla$] → [OK]	
[MENU] : EXIT	

3 SELECT MODE

Press **OK** or \triangleright to select either "ON" or "OFF".

MODE SET	
AUTO TIMER	OFF
O. S. D.	ON
B. E. S. T.	ON
AUTO SP→LP TIMER	OFF

4 RETURN TO NORMAL SCREEN

Press **MENU**.

NOTE:

For safety, when Auto timer is set to "OFF", all other recorder functions are disabled while the Timer mode is engaged. To disengage the timer, press \ominus (TIMER).

Automatic Satellite Programme Recording

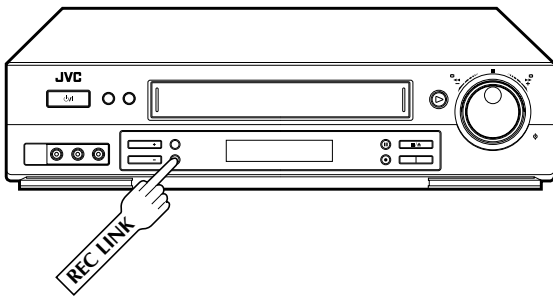

ATTENTION

- Be sure not to turn on the satellite tuner before the programme is executed; otherwise, the recorder will start recording when the satellite tuner's power is turned on.
- If you have connected another appliance other than a satellite tuner to the AV2 IN/DECODER connector, be sure not to engage the Auto Satellite Prog Rec mode; otherwise, the recorder will start recording when the connected appliance's power is turned on.
- Auto Satellite Prog recording and timer-recording cannot be done at the same time.

This facility allows you record automatically a satellite programme which is timer-programmed on your external satellite tuner. Connect a satellite tuner to the recorder's AV2 IN/DECODER connector and programme the timer on the satellite tuner; the recorder starts recording when the signals input from the satellite tuner to the AV2 IN/DECODER connector, and when there is no input signals the recorder stops recording and the power shuts off.

Before performing the following steps:

- Make sure the satellite tuner is connected to the recorder's AV2 IN/DECODER connector. (☞ pg. 42)
- Programme the timer on the satellite tuner.
- Insert a cassette with the safety tab in place.

1 SELECT AV2 SELECT MODE

Set "AV2 SELECT" to "AV2" (☞ pg. 37).

2 SET TAPE SPEED

Press **SP/LP** (//) to set the tape speed.

3 ENGAGE AUTO SATELLITE PROG REC MODE

Press and hold **REC LINK** for about 2 seconds. The button lights up and the recorder turns off automatically.

- To disengage the Auto Satellite Prog Rec mode, press **REC LINK**. The button's light goes off.
- If the recorder's power is off, it is not possible to engage the Auto Satellite Prog Rec mode.

NOTES:

- Auto Satellite Prog recording is not possible with the AV1 IN/OUT connector.
- For timer programming of the satellite tuner, refer to the instruction manual of the satellite tuner.
- Auto Satellite Prog recording is not possible if your satellite tuner does not have a timer.
- The button's light blinks while Auto Satellite Prog recording is in progress.
- Pressing the recorder's **⏻** button while Auto Satellite Prog recording is in progress turns off the recorder's power and disengage the Auto Satellite Prog Rec mode.
- If there are more than one satellite programme you wish to record with Auto Satellite Prog Recording, it is not possible to set the different tape speed per each; the tape speed selected in step 2 will be applicable to all the programmes for Auto Satellite Prog recording.
- The B.E.S.T. system (☞ pg. 24) does not work while Auto Satellite Prog recording is in progress.
- Just Clock (☞ pg. 54) does not work when the Auto Satellite Prog Rec mode is engaged.
- Depending on the type of satellite tuner, the recorder may not record a slight portion of the beginning of the programme or may record slightly longer than the actual length of the programme.
- If you engage the Auto Satellite Prog Recording mode when the satellite tuner's power is on, the recorder will not start Auto Satellite Prog recording even though the button's light blinks. When the satellite tuner shuts off once and is turned back on again, the recorder starts recording.
- When the Auto Satellite Prog Rec mode is engaged or the recorder's power is turned off after Auto Satellite Prog recording is finished, the recorder will not enter the Timer mode even though "AUTO TIMER" is set to "ON".
- After Auto Satellite Programme recording, the number of recorded programmes will not be displayed on the front display panel for the Instant ReView function (☞ pg. 15).
- You can also record a programme from your cable system in the same way if the system has a timer.

Remote Control Functions

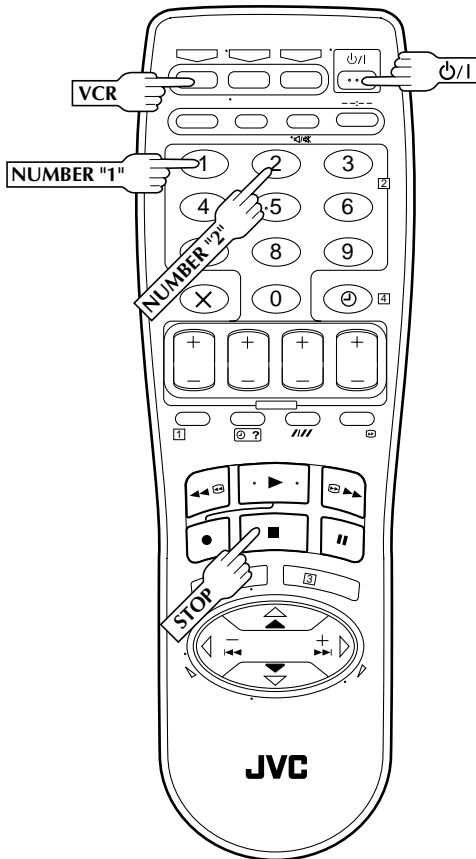

Remote A/B Code Switching

The remote control is capable of controlling two JVC video recorders independently; one set to respond to the remote control's A code control signals and another set to respond to B code control signals. The remote control is preset to send A code signals because your video recorder is initially set to respond to A code signals. You can easily modify your video recorder to respond to B code signals.

1 REMOVE POWER SUPPLY

Unplug the mains power cord from the mains outlet.

2 SET REMOTE CONTROL CODE

While holding down **VCR** on the remote control, press the **NUMBER** key "2" and then press **STOP**.

3 RE-SUPPLY POWER

Plug the mains power cord back into the mains outlet.

4 TURN THE RECORDER ON

Press ψ/I on the remote control. The recorder will now only respond to B code signals.

NOTE:

To set the recorder back to respond to A code signals, repeat the same procedure as shown above except pressing **NUMBER** key "1" instead of "2" in step 2.

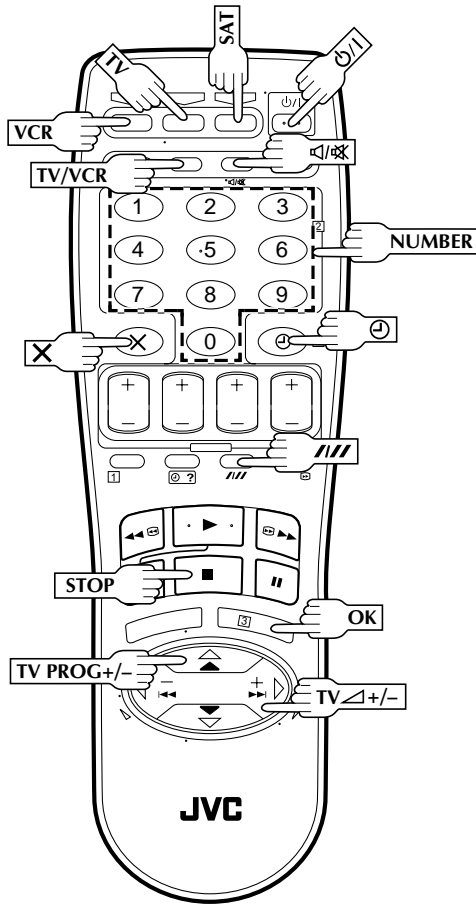

TV Multi-brand Remote Control

Your remote control can operate the basic functions of your TV set. In addition to JVC TVs, other manufacturer's TVs can also be controlled.

Before you start . . .

- Turn on the TV using its remote control.

1 SET TV BRAND CODE

Refer to the chart below. While holding down **TV** on the recorder's remote control, enter your TV's brand code using the **NUMBER** keys, then press **STOP**. Check if the TV's power goes off as it should. If it does, try other operations (☞ step 2)

- Once you have set the remote control to operate the TV, you don't have to repeat this step until you replace your remote control's batteries.
- JVC or SAMSUNG has more than one code. If the TV does not function with one code, try entering another.

2 OPERATE TV

First, press **TV** to set the remote control to TV mode, then press the corresponding button: **☺/⊖**, **TV PROG +/-**, **TV/VCR**, **TV Δ +/-** (Volume), **⊘/⊗** (Muting), **NUMBER** keys.

- For some brands of TV, you must press **OK** after having pressed the **NUMBER** keys.

IMPORTANT

Although the provided remote control unit is compatible with JVC televisions, as well as many other models, it may not work with your TV, or in some instances, may have limited function capability.

ATTENTION

The remote control can operate not only the video recorder but also some of your TV and satellite tuner's functions.

- To operate your video recorder, first press the **VCR** button to set the remote control to the Video mode.
- To operate your TV, first press the **TV** button to set the remote control to the TV mode.
- To operate your satellite tuner, first press the **SAT** button to set the remote control to the Satellite tuner mode.

Control Your TV Using Additional Buttons

Use the **NUMBER** keys, and the **///** button, **X** button or **⊕** button to select the TV's channel.

- With televisions under Code 01, 02, 03, 04, 05, 06, 07, 09, 10, 13, 14, 22, 23 or 25, the **///** button corresponds to the 1-digit/2-digit entry switching button (often labelled -/-) of your TV's remote control.
- With televisions under Code 01, 11 or 12, the **X** button corresponds to the 10 + button, and the **⊕** button corresponds to the 20 + button of your TV's remote control.

NOTE:

The way these buttons are used is determined by your TV. Use these buttons as instructed for your TV's remote control.

TV BRAND NAME	CODE
JVC	01, 02, 03, 04
BRANDT	05
NORDMENDE	05
SABA	05
TELEAVIA	05
TELEFUNKEN	05
THOMSON	05
FERGUSON	06
PHILIPS	07
SAMSUNG	07, 19, 23, 24, 25
BLAUPUNKT	08
GRUNDIG	08
SONY	09
PANASONIC	10
GRAETZ	11
ITT	11
LUXOR	11
SALORA	11
SELECO	11
MIVAR	12
HITACHI	13
TOSHIBA	14
MITSUBISHI	15
FINLUX	16
NOKIA	17
SHARP	18
FUNAI	20
GOLDSTAR	21
NEC	22

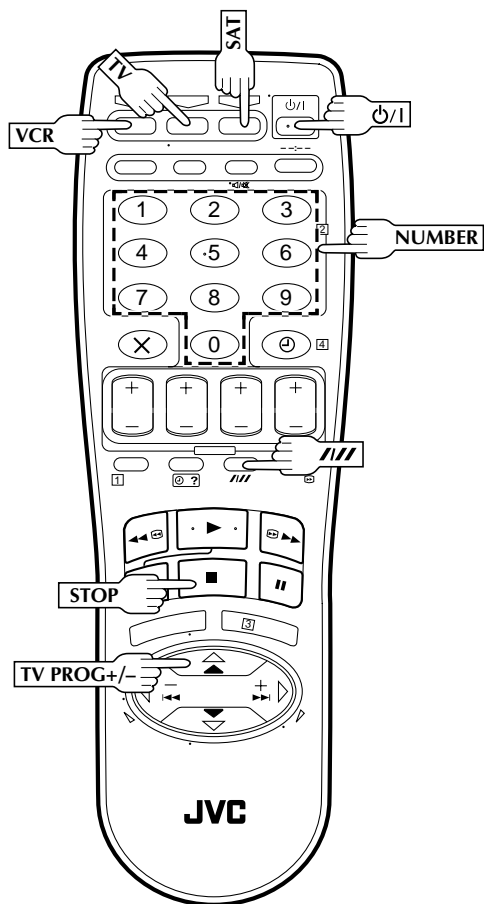

ATTENTION

The remote control can operate not only the video recorder but also some of your TV and satellite tuner's functions.

- To operate your video recorder, first press the **VCR** button to set the remote control to the Video mode.
- To operate your TV, first press the **TV** button to set the remote control to the TV mode.
- To operate your satellite tuner, first press the **SAT** button to set the remote control to the Satellite tuner mode.

Satellite Tuner Multi-Brand Remote Control

Your remote control can operate the basic functions of your satellite tuner set. In addition to JVC satellite tuners, other manufacturer's satellite tuners can also be controlled.

Before you start . . .

- Turn on the satellite tuner using its remote control.

SET SATELLITE RECEIVER BRAND CODE

1

Refer to the chart below. While holding down **SAT** on the recorder's remote control, enter your satellite tuner's brand code using the **NUMBER** keys, then press **STOP**. Check if the satellite tuner's power goes off as it should. If it does, try other operations (☞ step 2)

- Once you have set the remote control to operate the satellite tuner, you don't have to repeat this step until you replace your remote control's batteries.
- Some satellite tuner brands have more than one code. If the satellite tuner does not function with one code, try entering another.

OPERATE SATELLITE TUNER

2

First, press **SAT** to set the remote control to satellite tuner mode, then press the corresponding button: **⏻/⏻**, **TV**, **PROG +/-**, **NUMBER** keys.

- For **VIDEOWAY** or some brands of satellite tuner, you must press **///** after having pressed the **NUMBER** keys.
- The **NUMBER** buttons may not function with some satellite tuners.

IMPORTANT

Although the provided remote control unit is compatible with JVC satellite tuners, as well as many other models, it may not work with your satellite tuner, or in some instances, may have limited function capability.

SATELLITE TUNER BRAND	CODE
JVC	13, 14
AMSTRAD	01, 02, 03, 04
GRUNDIG	05, 06
HIRSCHMANN	05
SIEMENS	05
WISI	05
KATHREIN	05, 11, 12
PACE	06, 08
PHILIPS	07
FINLUX	09
ITT	09
NOKIA	09
SALORA	09
RFT	10
SKYMASTER	10
MASPRO	11
BT	13
PANASONIC	15
JERROLD	16
VIDEOWAY	17

Edit To Or From Another Video Recorder

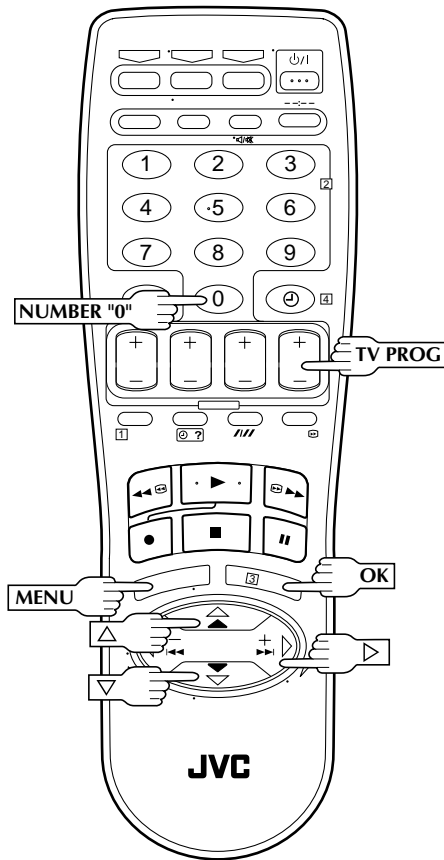

You can use your video recorder as the source player or the recording deck.

1

MAKE CONNECTIONS

Connect the player's 21-pin SCART (AV) connector to the recorder's 21-pin SCART (AV) connector as illustrated on page 37.

When Using Your Video Recorder As The Source Player . . .

. . . connect its AV1 IN/OUT connector to the recording deck.

When Using Your Video Recorder As The Recording Deck . . .

. . . connect its AV2 IN/DECODER or AV1 IN/OUT connector to the source player.

2

SET RECORDING DECK'S INPUT MODE

Set to AUX. With this video recorder, press **NUMBER** key "0" and/or **TV PROG** to select depending on the connector being used — "L-1" for the AV1 IN/OUT connector, or "L-2" for the AV2 IN/DECODER connector.

- When using the AV2 IN/DECODER connector, make sure "AV2 SELECT" is set to "AV2" (☞ pg. 37).

3

START SOURCE PLAYER

Engage its Play mode.

4

START RECORDING DECK

Engage its Record mode.

NOTES:

- All necessary cables can be obtained from your dealer.
- When you use this recorder as the player for editing, be sure to set "O.S.D." to "OFF" before starting (☞ pg. 8).
- If you use this recorder as the player for editing, be sure to turn off 3R Picture before starting. (☞ pg. 14)

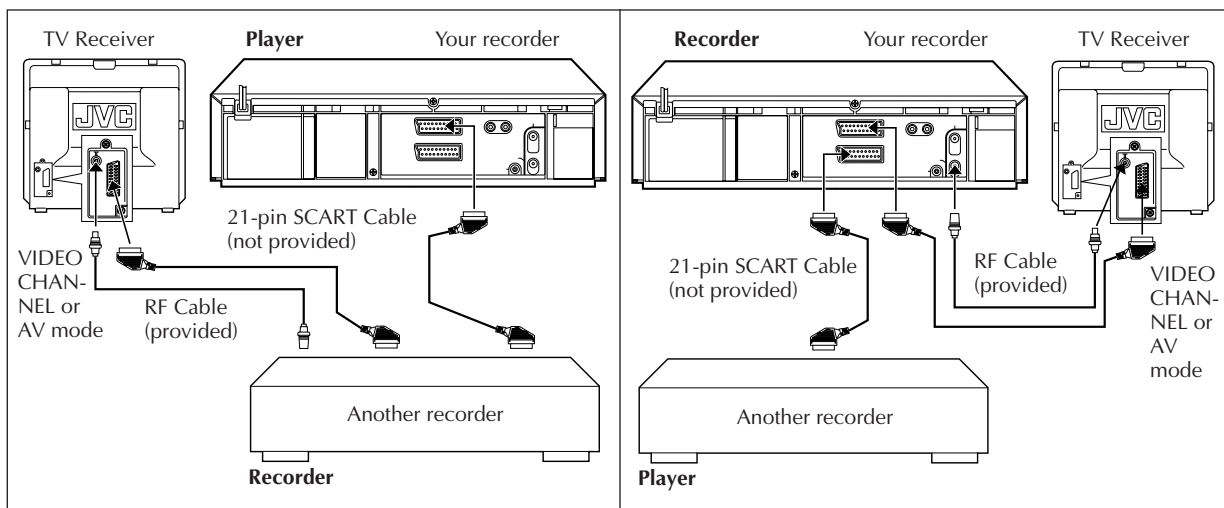

AV2 SELECT Setting

- 1 Press **MENU** to access the Main Menu screen.
- 2 Press Δ / ∇ to move the highlight bar (pointer) to "MODE SET", then press **OK** or \triangleright .
- 3 Press Δ / ∇ to move the highlight bar (pointer) to "AV2 SELECT".
- 4 Press **OK** or \triangleright to select "AV2" or "DECODER".
 - a-AV2 : To use this recorder as the recording deck with the player connected to the AV2 IN/DECODER connector.
 - OR**
 - To record a satellite programme through a satellite tuner connected to the AV2 IN/DECODER connector.
 - b-DECODER : To use a decoder connected to the AV2 IN/DECODER connector.
- 5 Press **MENU** to return to normal screen.

MODE SET	
AUTO TIMER	OFF
O. S. D.	ON
B. E. S. T.	ON
AUTO SP→LP TIMER	ON
POWER SAVE	OFF
AV2 SELECT	AV2

- If you have a decoder, be sure to set "AV2 SELECT" back to "DECODER" after editing.
- If you're not using a decoder, leave "AV2 SELECT" set to "AV2".
- The default setting is "AV2"; if the recorder's memory backup has expired due to a power cut or because the AC was removed from the recorder, "AV2" will be automatically selected when the power is restored to the recorder. If you are using a decoder, be sure to set "AV2 SELECT" back to "DECODER".

NOTE:

On the Mode Set screen ...

"POWER SAVE" appears only with the HR-J758E and HR-DD858E.

Edit From A Camcorder

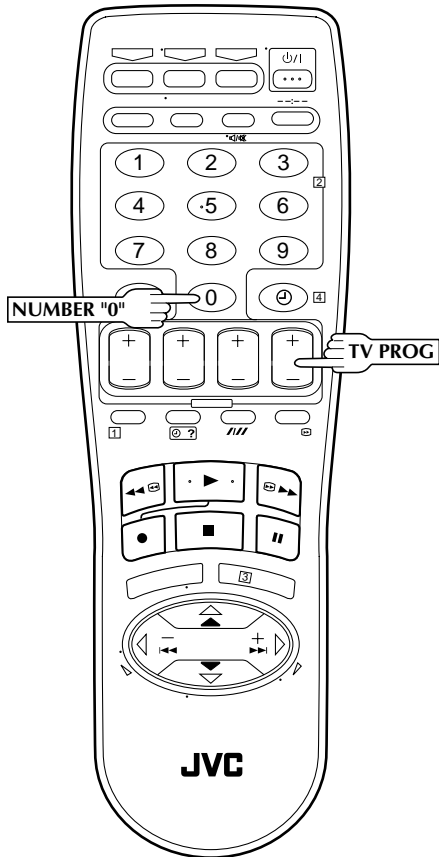

You can use a camcorder as the source player and your video recorder as the recorder.

1 MAKE CONNECTIONS

Connect the camcorder's AUDIO/VIDEO OUT connectors to the recorder's front panel AUDIO/VIDEO input connectors.

- When using a monaural camcorder, connect its AUDIO OUT connector to the AUDIO L input connector on your recorder.
- When a Master Edit Control-equipped JVC camcorder is used, the camcorder is capable of controlling the recorder. Refer to the camcorder's instruction manual for operating procedure.

2 SET RECORDER'S INPUT MODE

Press **NUMBER** key "0" and/or **TV PROG** so that "F-1" appears in place of a channel position number.

3 START CAMCORDER

Engage its Play mode.

4 START RECORDER

Engage its Record mode.

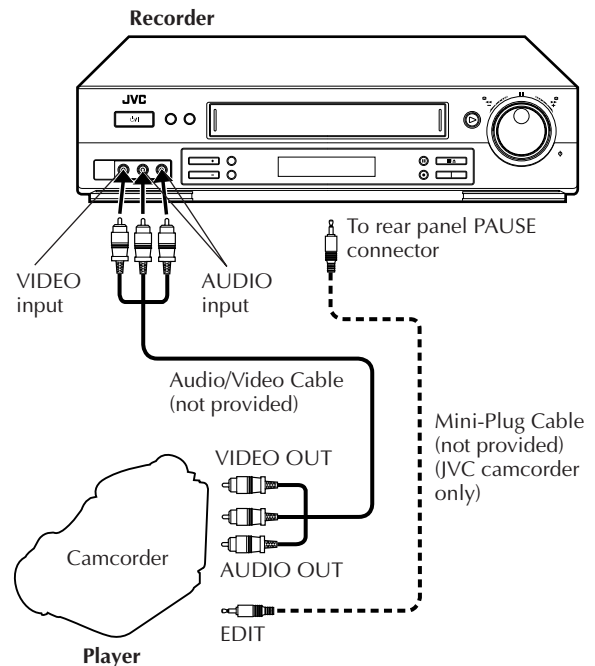

Audio Dubbing (HR-DD858E/EH only)

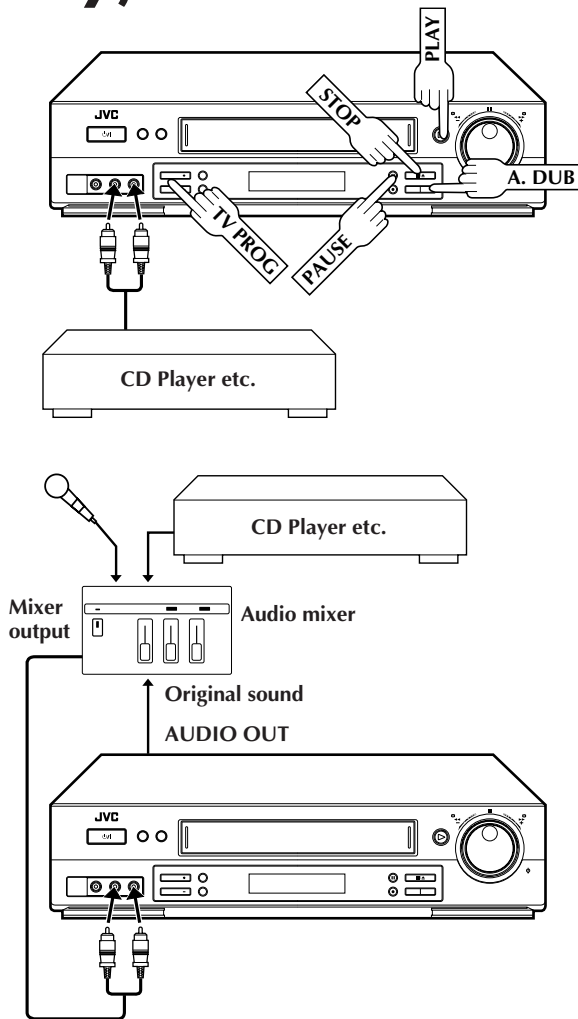

NOTES:

- When monitoring the sound during Audio Dubbing, the normal soundtrack is automatically selected. If you wish to hear the mixed sound (Hi-Fi + Normal soundtracks), press **AUDIO** on the remote control to select $\square + \square$ (L+R)+NORM" (☞ pg. 16).
- Audio dubbing stops automatically when the counter reaches "0:00:00", and the recorder enters the Play mode. Check the counter reading before dubbing.
- Audio dubbing is also possible using the rear panel AV1 IN/OUT or AV2 IN/DECODER connector. When using these connectors, make sure to select the correct input mode in step 2.
- Audio dubbing cannot be performed on a cassette that has had its record safety tab removed.
- When playing back an audio-dubbed tape, press **AUDIO** on the remote control to select the soundtrack you wish to hear (☞ pg. 16).

Audio dubbing replaces the normal audio sound of a previously recorded tape with a new soundtrack.

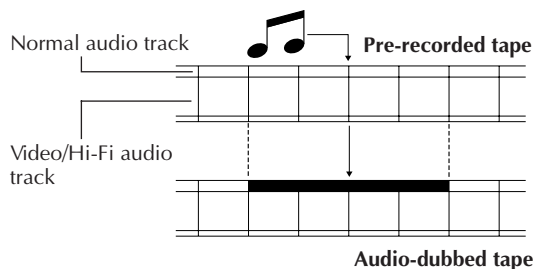

1 MAKE CONNECTIONS

Connect an audio component to the AUDIO L + R connectors on the recorder's front panel.

- When connecting monaural equipment, use only the recorder's AUDIO L connector.

2 SET INPUT MODE

Press **NUMBER** key "0" and/or **TV PROG** so that "F-1" appears in place of a channel number.

3 LOCATE START POINT

Press **PLAY** to start playback of the tape in your recorder, and press **PAUSE** when you find the point where you want to start dubbing.

4 ENGAGE AUDIO DUBBING

Press **A. DUB**.

- Your recorder enters the Audio Dubbing Pause mode. ("0" blinks, "▶" and "⏸" light up on the front display panel.)
- To perform audio dubbing with audio mixing, press **AUDIO** on the remote control to select $\square + \square$ (L+R)" at this point.
* Audio dubbing with audio mixing is not possible if you're using a monaural audio component, or if you don't have an audio mixer.

5 START DUBBING

Engage the audio component's Play mode, then press **PLAY** to start the tape in your recorder. Audio dubbing begins at this point.

- "0" blinks and "▶" is displayed on the front display panel.
- To stop dubbing temporarily, press **PAUSE**. Press **PLAY** to resume dubbing.

6 END AUDIO DUBBING

Press **STOP** to stop the tape in your recorder, and engage the audio component's Stop mode.

Insert Editing (HR-DD858E/EH only)

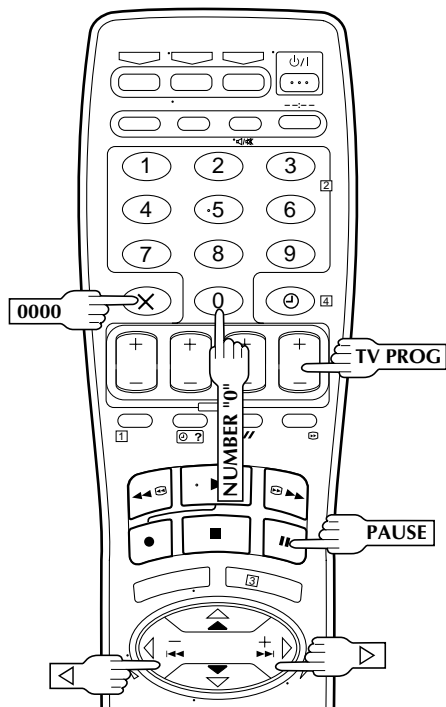
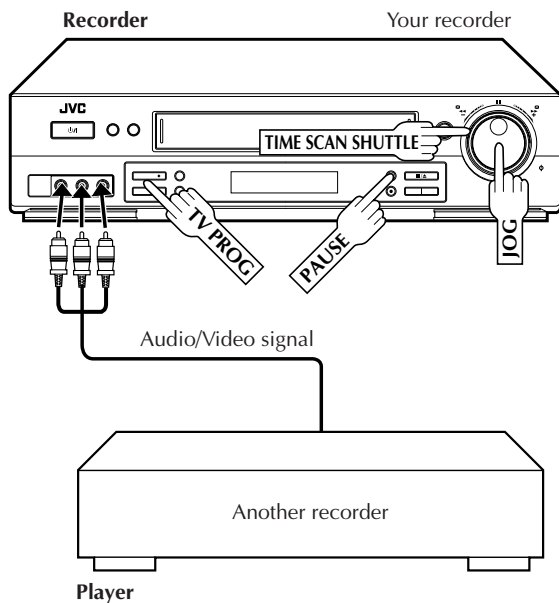

Insert editing replaces part of the recorded scene with new material. Both the picture and Hi-Fi audio soundtrack are replaced with new ones, while the normal audio soundtrack remains unchanged. If you wish to change the normal audio track as well, use the audio dubbing function simultaneously. Use your video recorder as the recorder.

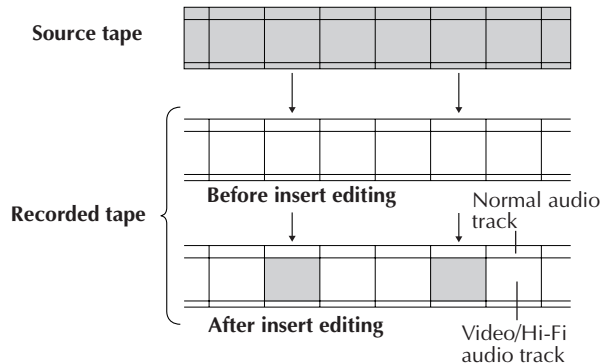

MAKE CONNECTIONS

1 Connect the player's VIDEO OUT and AUDIO OUT connectors to your recorder's VIDEO and AUDIO connectors on the front panel.

SET INPUT MODE

2 Press **NUMBER** key "0" and/or **TV PROG** so that "F-1" appears in place of a channel number.

LOCATE END POINT

3 Load the recording cassette into your recorder, and play it back to determine the edit-out point (the end of the segment to be replaced) using the **JOG/TIME SCAN SHUTTLE** controls or **<|>** and **PAUSE**.

RESET THE COUNTER

4 Press **0000** to change the counter display to "0:00:00".

LOCATE START POINT

5 Determine the edit-in point (the beginning of the segment to be replaced) using the **JOG/TIME SCAN SHUTTLE** controls or **<|>** and **PAUSE**.

- Be sure to engage the Still mode at the edit-in point.

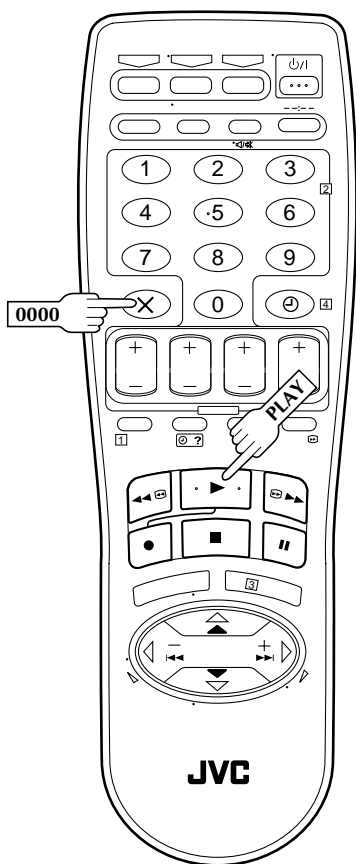
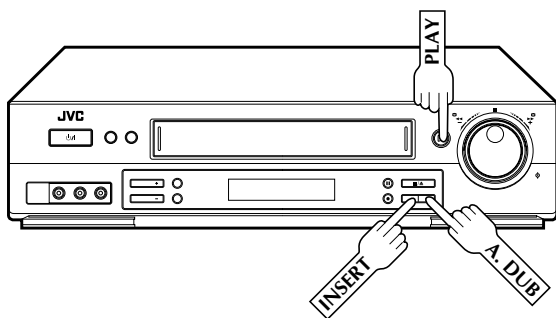

6

ENGAGE INSERT EDITING

Press **INSERT**.

- Your recorder enters the Insert-Pause mode. ("0", "▶" and "■" light up on the front display panel.)
- The TV screen changes from the still picture to the input source you are going to record.

7

START EDITING

Load the source cassette and play back the segment that is to be inserted. When you reach the start of the section of the source tape that you wish to insert, press **PLAY** to start the tape in your recorder; Insert Editing begins at this point.

- "0" and "▶" are displayed on the front display panel.

8

END INSERT EDITING

At counter "0:00:00", Insert Editing will stop automatically while the tape continues running in the Play mode. If you wish to stop Insert Editing before the specified edit-out point, press **0000**.

FOR AV INSERT EDITING

If you want to replace the picture, Hi-Fi audio soundtrack and normal audio soundtrack all at the same time...

... In step 6 above, after you press **INSERT**, press **A. DUB** also. ("0" and "▶" blink and "■" lights up on the front display panel.)

NOTES:

- Suitable leads can be obtained from your dealer.
- Insert editing is not possible with cassettes whose safety tab has been removed.
- When insert editing is performed on a tape that has been recorded on another video recorder, the inserted portion may appear distorted.
- In insert editing, the recording speed (SP/LP) is determined by the previous recording to be replaced. If the previous recording's speed changes within a single edit, the inserted picture will be distorted at the switching point.
- A small portion of the recording which precedes an insert edit may become erased.
- Insert Editing is also possible using the rear panel AV1 IN/OUT or AV2 IN/DECODER connector. When using these connectors, make sure to select the correct input mode in step 2.

Connection To A Satellite Tuner

The AV2 IN/DECODER connector on the rear panel of your recorder allows simple connection to a satellite tuner.

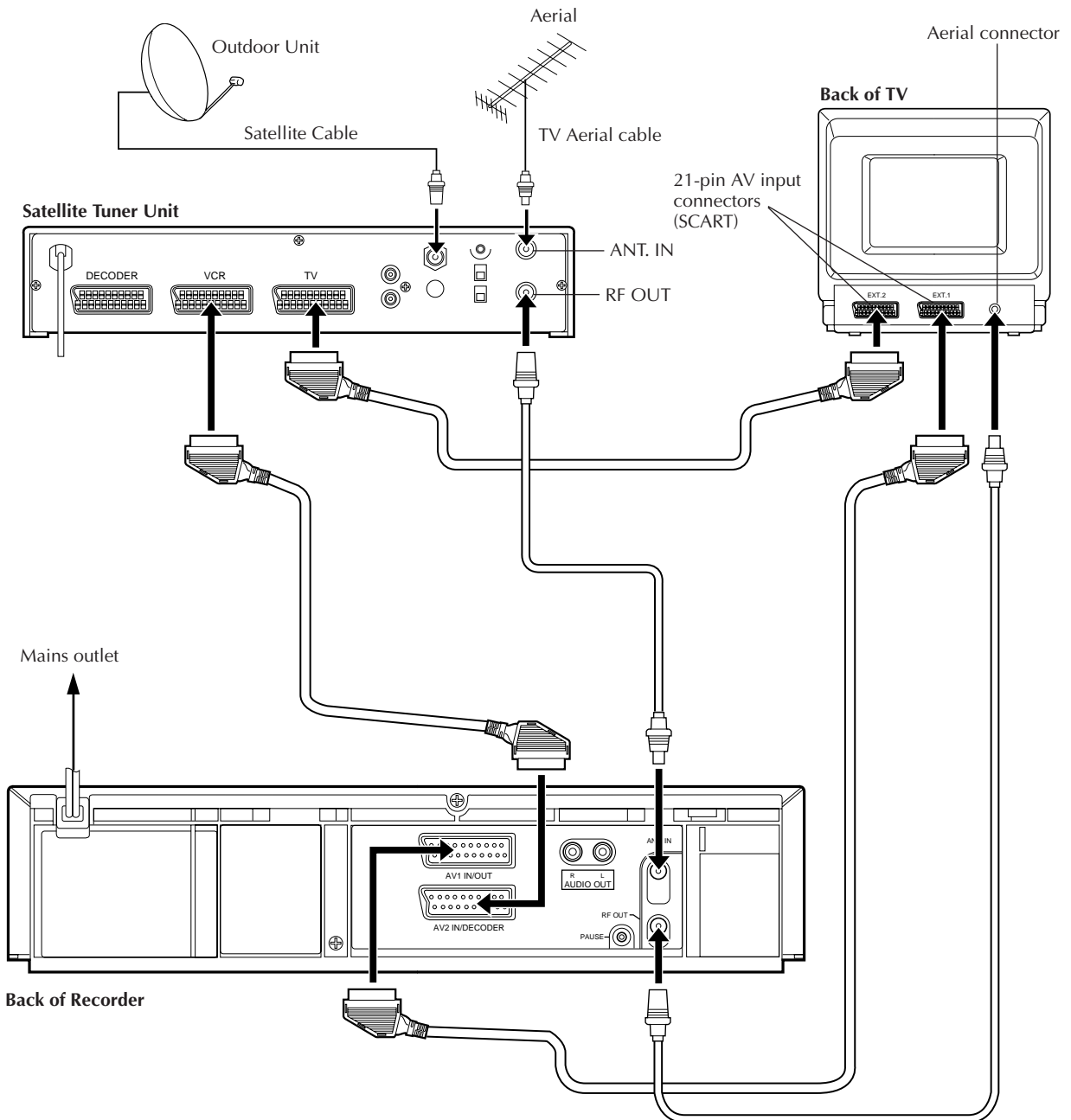

NOTE:

For details, check your satellite tuner's instruction manual.

Connecting/ Using A Decoder

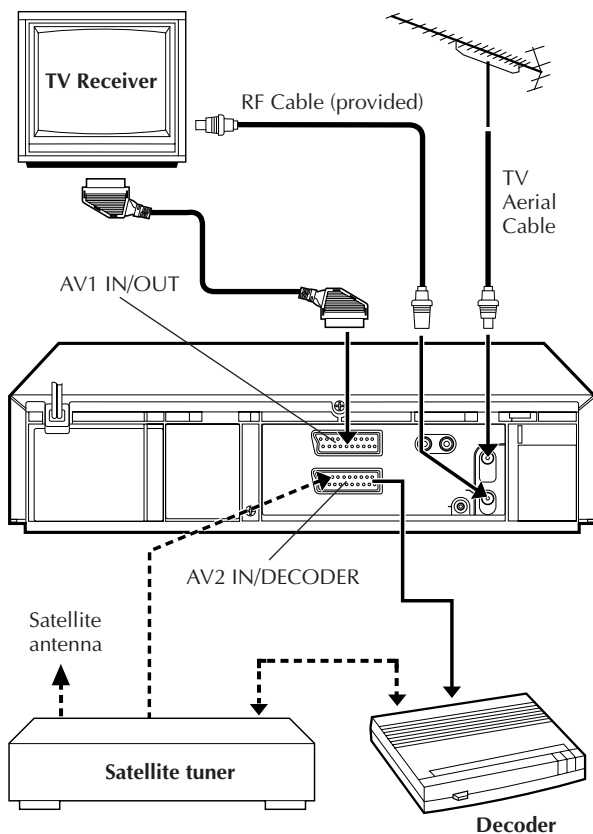

The AV2 IN/DECODER connector can be used as an input terminal for an external decoder (descrambler). Simply connect a decoder and you can enjoy the variety of programming that is available through scrambled channels.

1 SELECT INPUT MODE

Set "AV2 SELECT" to "DECODER". (☞ pg. 37)

2 CONNECT DECODER

Connect your recorder's AV2 IN/DECODER connector to the decoder's Euroconnector using a 21-pin SCART cable.

3 SET TUNER

Perform the procedure as described in "When Receiving A Scrambled Broadcast" on page 49.

NOTE:

When Connecting A Satellite Tuner . . .

- . . . if you don't have a decoder connect the satellite tuner directly to the video recorder's AV2 IN/DECODER connector.
- . . . if you have a decoder, first connect the decoder to the decoder input of the satellite tuner, then connect the satellite tuner's output to the recorder's AV2 IN/DECODER connector. Refer to the instruction book for the satellite tuner and decoder.
- . . . set "AV2 SELECT" to "AV2". (☞ pg. 37)
- . . . to view a programme via the satellite tuner, select L-2 mode by pressing **NUMBER** keys and/or **TV PROG** so that "L-2" appears on the display panel.

Connecting/ Using A Stereo System

These instructions enable you to connect your video recorder to your Hi-Fi stereo system (if you have one) and listen to the soundtrack through the stereo.

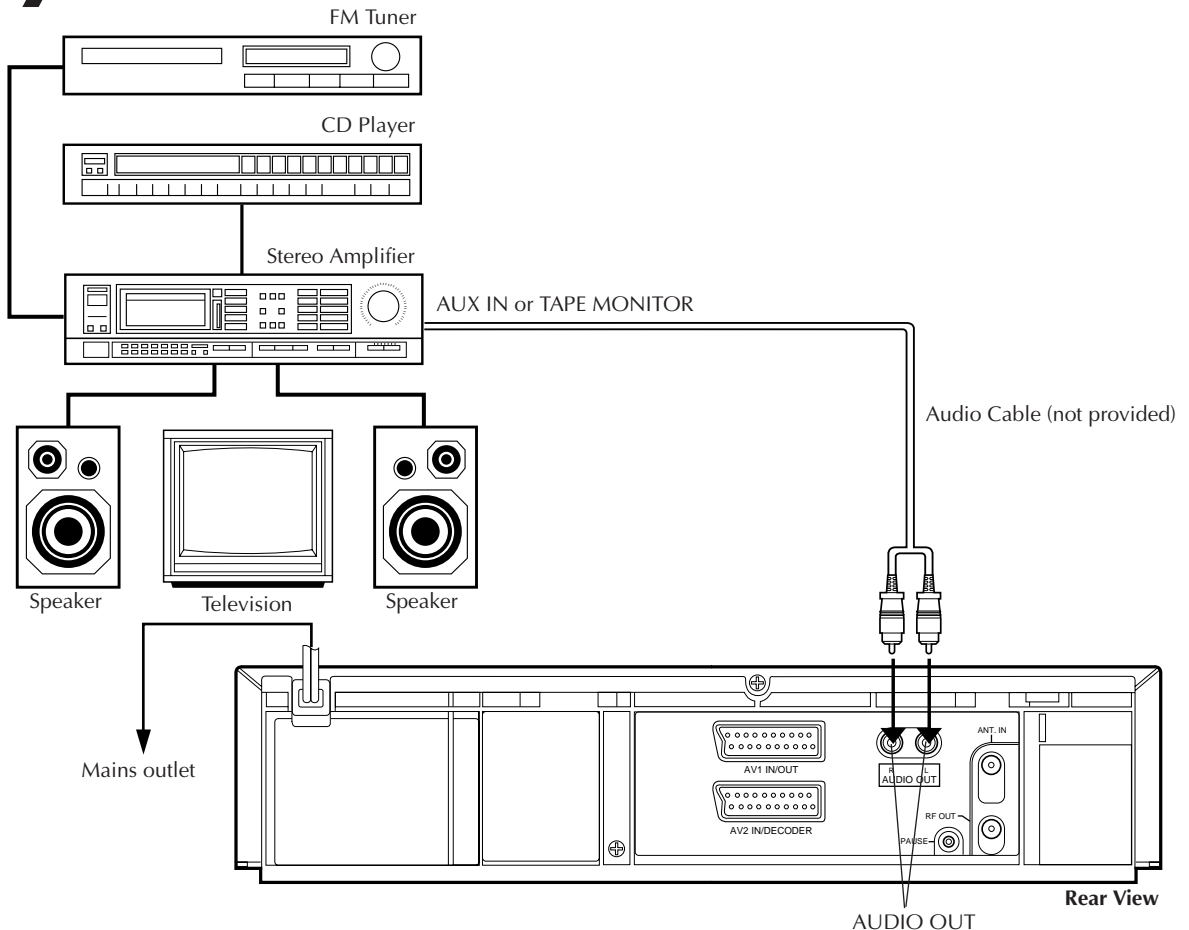

1 MAKE CONNECTIONS

Connect the AUDIO OUT L and R connectors on your video recorder to the AUX IN or TAPE MONITOR terminals on your stereo system's receiver or amplifier.

NOTES:

- When connecting your recorder's audio output connectors to a stereo amplifier, make sure you connect L and R correctly.
- If stereo or bilingual TV broadcasts are receivable in your area, this recorder can record them independently of the TV set and play them back through the connected stereo system.
- When listening to sound through the connected stereo system, turn the TV's volume down completely.

CAUTIONS:

- This recorder has a dynamic range of more than 80 dB with regards to its Hi-Fi audio capability. It is recommended that you check the maximum level if you are going to listen to the Hi-Fi audio signals through a stereo amplifier. A sudden surge in the input level to the speakers may damage them.
- Some speakers and televisions are specially shielded to prevent television interference. If both are of the non-shielded type, do not place the speakers adjacent to the TV set as this can adversely affect the video playback picture.

Video Channel Set

Video Channel (RF Output Channel) is the channel on which your TV receives picture and sound signals from the video recorder through the RF cable.

IMPORTANT

Perform the following steps only if —

- Video Channel Set has not been done correctly by the Auto Set Up function (☞ pg. 4).
- interference appears in the TV picture after you have moved to a different area or a new station has started broadcasting in your area.
- you change the connection between your recorder and TV from RF connection to AV connection, or vice versa.

If you have connected the video recorder to your TV via both the RF cable and a 21-pin SCART cable (AV connection), since you do not need the video channel you have to set the video channel to off.

If you have connected the video recorder to your TV via the RF cable only (RF connection), you have to set the correct video channel.

Before performing the following steps, make sure the recorder's power is off and there is no cassette inserted in the recorder.

ACCESS VIDEO CHANNEL SET MODE

1 Hold down **STOP** (■/▲) on the recorder until the display panel shows the following.

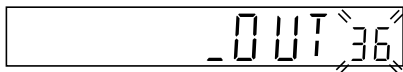

SET VIDEO CHANNEL

With AV Connection

Press **TV PROG** – until the display panel shows "_OUT--".



- Now the video channel is set to off.

With RF Connection

Press **TV PROG** + or – to set the video recorder to a vacant channel between 22 and 69 which is not occupied by any local station in your area.

(Ex.) If channel 50 is available in your area

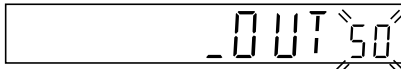

Then set your TV to UHF channel 50.

- If the two vertical white bars appear clearly on the screen as shown to the right, go to step 3.
- If the two vertical white bars do not appear clearly, re-set the video recorder to another vacant channel and try again.

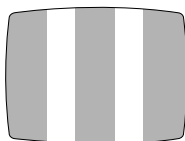

NOTES:

- If you set the video recorder to a channel which is occupied by a local station or has neighbouring channels that are occupied by local stations, the picture reception quality will be affected and some interference noise will appear on the TV screen. Be sure to select a vacant channel which has no broadcast on neighbouring channels.
- If you cannot obtain the two vertical white bars clearly with any channel between 22 and 69, consult your JVC dealer.

EXIT VIDEO CHANNEL SET MODE

3 Press **OK** on the remote control.

With AV Connection:

To view picture signals from the video recorder, set your TV to its AV mode.

With RF Connection:

The channel on which the screen in step 2 appears clearly is your video channel.

To view picture signals from the video recorder, set your TV to the Video Channel.

Tuner Set

Turn on the TV and select the VIDEO channel (or AV mode).

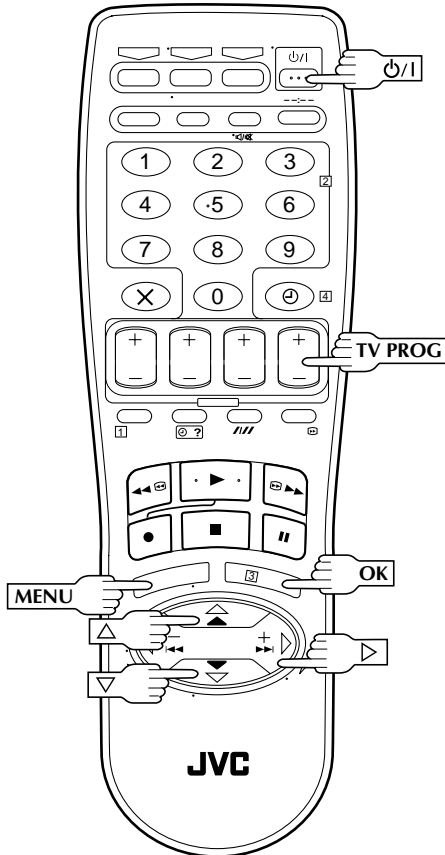

IMPORTANT

Perform the following steps only if —

- Auto Channel Set has not been set correctly by Auto Set Up function (see pg. 4).
- you have moved to a different area or if a new station starts broadcasting in your area.

Your recorder needs to memorize all necessary stations in channel positions in order to record TV programmes. Auto Channel Set automatically assigns all receivable stations in your area to call them up by using the **TV PROG** buttons without going through any vacant channel.

Auto Channel Set

TURN ON THE RECORDER

Press **ON/OFF**.

ACCESS MAIN MENU SCREEN

Press **MENU**.

ACCESS COUNTRY SET SCREEN

Press Δ / ∇ to move the highlight bar (pointer) to "AUTO CH SET", then press **OK** or \triangleright .

- "REC LEVEL CTL" appears only with the HR-DD858E and HR-DD858EH.

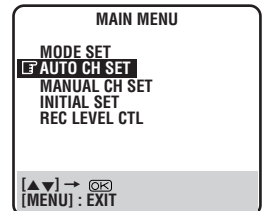

SELECT COUNTRY

Press Δ / ∇ to move the highlight bar (pointer) to your country's name, then press **OK** or \triangleright .

SELECT LANGUAGE

Press Δ / ∇ to move the highlight bar (pointer) to the language of your choice.

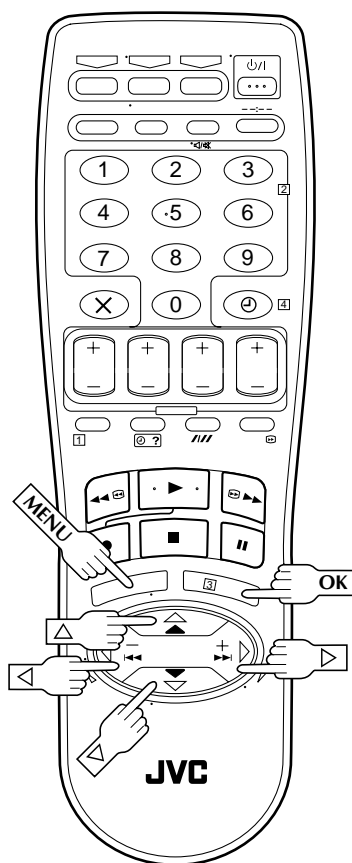

IMPORTANT

- In certain reception conditions, station names may not be stored correctly, and auto Guide Program Number Set may not work properly. If the Guide Program numbers are not set properly, when you timer-record a TV programme using SHOWVIEW, the recorder will record a TV programme of a different station. When programming the timer using SHOWVIEW, be sure to check whether the channel position on which your recorder receives the broadcasting station you wish to record is selected (see pg. 26, "SHOWVIEW Timer Programming").
- Your video recorder memorizes all detected stations even if reception of some of them is poor. In these cases picture quality may be poor. To delete those stations with an unacceptable picture see "Delete A Channel" on page 49.

NOTES:

- Fine tuning is performed automatically during Auto Channel Set. If you want to perform it manually, refer to page 52.
- If you perform Auto Channel Set when the aerial cable is not connected properly, "SCAN COMPLETED -NO SIGNAL-" appears on the screen in step 7. When this happens, make sure of the aerial connection and press **OK**; Auto Channel Set will take place again.

PERFORM AUTO CHANNEL SET

Press **OK** or **▷**.

- The Auto Set screen appears, and remains on screen while the recorder searches for receivable stations. As Auto Channel Set progresses, the "■" mark on the screen moves from

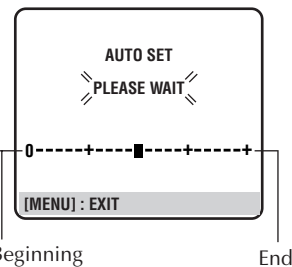

Wait until the screen as shown in step 7 appears.

VIEW CONFIRMATION SCREEN

After "SCAN COMPLETED" is displayed on the screen for about 5 seconds, the Confirmation screen

PR	CH	ID	PR	CH	ID
01	25	ARD	08	C26	E-SP
02	C08	SKYT	09	55	WEST
03	10	ZDF	10	C24	SAT1
04	C65	RAI1	11	C23	OSF
05	C31	BBC1	12		----
06	C32	BBC2	13		----
07	C33	3SAT	14		----

looking like the one to the right appears. The stations your recorder located appear on a Confirmation screen — channel positions (PR), channels (CH) and station names (ID — see pg. 51). The blueback screen and the programme currently being broadcast by the blinking station appear alternately for 8 seconds each. To view the next page, use the $\Delta \nabla \triangleleft \triangleright$ button on the remote control.

C: Cable

- The stations located in the selected country appear at the top of the list.
- The Guide Program numbers will also be set automatically during Auto Channel Set.

RETURN TO NORMAL SCREEN

Press **MENU**.

- Using the Confirmation screen, you can skip or add channel positions, enter station names and perform other operations. Refer to pages 48 – 52 for the procedures.
- Depending on reception conditions, the stations may not be stored in order, and the station names may not be stored correctly.
- For information on scrambled broadcasts, refer to page 49.

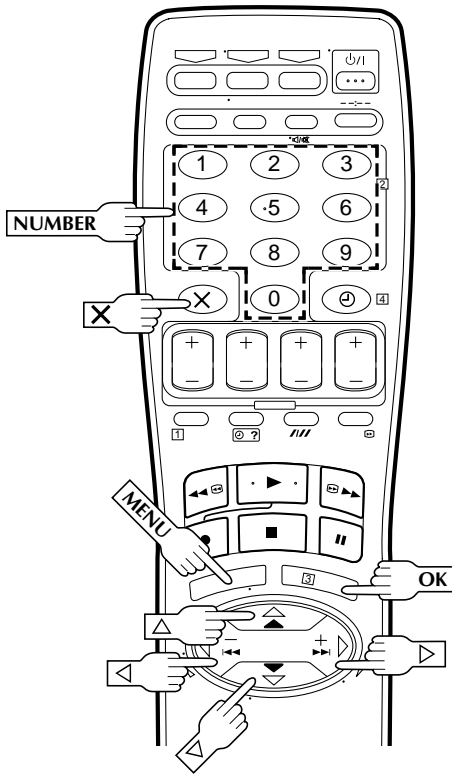

Storing Channels Manually

Store channels that were not stored during Auto Set Up (pg. 4) or Auto Channel Set (pg. 46).

- 1** **ACCESS MAIN MENU**
 Press **MENU**.

- 2** **ACCESS CONFIRMATION SCREEN**
 Press $\Delta \nabla$ to move the highlight bar (pointer) to "MANUAL CH SET", then press **OK** or \triangleright . The Confirmation screen appears.

- 3** **SELECT POSITION**
 Press $\Delta \nabla \triangleleft \triangleright$ until an open position in which you want to store a channel begins blinking, then press **OK**. The Manual Channel Set screen appears.

(Ex.) To store in position 12.

PR	CH	ID	PR	CH	ID
01	25	ARD	08	C26	E-SP
02	CDB	SKY1	09	55	WEST
03	10	ZDF	10	C24	SAT1
04	C65	RAI1	11	C23	OSF
05	C31	BBC1	12	----	----
06	C32	BBC2	13	----	----
07	C33	3SAT	14	----	----

$\left[\Delta \nabla \triangleleft \triangleright \right]$
 \rightarrow $\left[\text{OK} \right]$: EDIT
 \rightarrow $\left[X \right]$: DELETE
 $\left[\text{MENU} \right]$: EXIT

The blueback screen and the programme currently being broadcast by the selected channel appear alternately for 8 seconds each.

- 4** **SELECT BAND**
 Press $\Delta \nabla$ to change the band between CH (regular) and CC (cable), then press \triangleright .

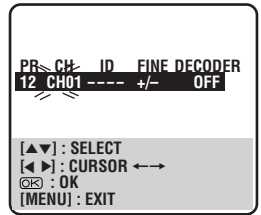

The blueback screen and the programme currently being broadcast by the selected channel appear alternately for 8 seconds each.

- 5** **INPUT CHANNEL**
 Press the **NUMBER** keys to input the channel number you want to store.
 - Input "0" before any single number entries.
 - To input the registered station name (ID - pg. 51), press \triangleright until "----" (ID setting) begins blinking, then press $\Delta \nabla$.
 - For fine tuning adjustment, press \triangleright until "+/-" begins blinking, then press $\Delta \nabla$. While tuning, "+" or "-" appears.
 - When storing a channel that sends scrambled broadcasts, press \triangleright until "OFF" (Decoder setting) blinks, then press $\Delta \nabla$ to set "DECODER" to "ON" ("OFF" is the default setting).
 - When "AV2 SELECT" is set to "AV2", the "DECODER" setting cannot be changed (pg. 37).

- 6** **ENTER NEW CHANNEL INFORMATION**
 Press **OK** and the Confirmation screen appears.
 - Repeat steps 3 through 6 as necessary.

- 7** **CLOSE CONFIRMATION SCREEN**
 Press **MENU**.
 - To change positions, see "Change Station Channel Position" (pg. 49).
 - If you wish to set station names other than the ones registered in your recorder, "Set Stations (B)" on page 50.

ATTENTION
 After you have stored channels manually, be sure to perform Guide Program Number Set (pg. 53) in order to get proper results from SHOWVIEW timer recording.

Delete A Channel

Perform steps 1 and 2 of "Storing Channels Manually" on page 48 to access the Confirmation screen before continuing.

- 1** **SELECT ITEM**
Press $\Delta \nabla \triangleleft \triangleright$ until the item you want to delete begins blinking.
- 2** **DELETE CHANNEL**
Press \times .
 - The item directly beneath the cancelled one moves up one line.
 - Repeat steps 1 and 2 as necessary.
- 3** **CLOSE CONFIRMATION SCREEN**
Press **MENU**.

Change Station Channel Position

Perform steps 1 and 2 of "Storing Channels Manually" on page 48 to access the Confirmation screen before continuing.

- 1** **SELECT ITEM**
Press $\Delta \nabla \triangleleft \triangleright$ until the item you want to move begins blinking. Then press **OK** and the station name (ID) and its channel (CH) number begin blinking.
- 2** **SELECT NEW POSITION**
Press $\Delta \nabla \triangleleft \triangleright$ to move the station to the new channel position, then press **OK**.
Example: If you moved the station in position 4 to position 2, the stations originally in positions 2 and 3 each move down one space.

PR	CH	ID	PR	CH	ID	PR	CH	ID	PR	CH	ID
01	25	ARD	08	C26	E-SP	01	25	ARD	08	C26	E-SP
02	C08	SKY1	09	55	WEST	02	C65	RAI1	09	55	WEST
03	10	ZDF	10	C24	SAT1	03	C08	SKY1	10	C24	SAT1
04	C65	RAI1	11	C23	OSF	04	10	ZDF	11	C23	OSF
05	C31	BBC1	12	C25	ESPN	05	C31	BBC1	12	C25	ESPN
06	C32	BBC2	13	----	----	06	C32	BBC2	13	----	----
07	C33	3SAT	14	----	----	07	C33	3SAT	14	----	----
- Repeat steps 1 and 2 as necessary.
- 3** **CLOSE CONFIRMATION SCREEN**
Press **MENU**.

When Receiving A Scrambled Broadcast

- 1** **SELECT DECODER MODE**
Set "AV2 SELECT" to "DECODER" (pg. 37).
- 2** **ACCESS CONFIRMATION SCREEN**
Perform steps 1 and 2 of "Storing Channel Manually" on page 48.
- 3** **SELECT POSITION**
Press $\Delta \nabla \triangleleft \triangleright$ to select the channel position broadcasting scrambled programmes, then press **OK** twice.
- 4** **CHANGE DECODER SETTING**
Press \triangleright until "OFF" (decoder setting) begins blinking, and set it to "ON" by pressing $\Delta \nabla$.
- 5** **RETURN TO CONFIRMATION SCREEN**
Press **OK**.
 - Repeat steps 3 through 5 as necessary.
- 6** **CLOSE CONFIRMATION SCREEN**
Press **MENU**.

ATTENTION

After you have deleted channels or changed channel positions, be sure to perform Guide Program Number Set (pg. 53) in order to get proper results from SHOWVIEW timer recording.

Set Stations (A)

Set station names that are registered in your recorder.

Perform steps 1 and 2 of "Storing Channels Manually" on page 48 to access the Confirmation screen before continuing.

1

SELECT ITEM

Press $\Delta \nabla \triangleleft \triangleright$ until the item you want begins blinking.

2

ACCESS MANUAL CHANNEL SET SCREEN

Press **OK** twice.

3

SELECT NEW STATION

Press \triangleright until the station name (ID) begins blinking, then press $\Delta \nabla$ until the new station's name (ID) you want to store begins blinking.

Registered station names (pg. 51) appear as you press $\Delta \nabla$.

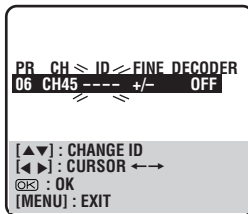

4

SWITCH STATIONS

Press **OK**.

- The Confirmation screen appears.
- Repeat steps 1 through 4 as necessary.

5

CLOSE CONFIRMATION SCREEN

Press **MENU**.

Set Stations (B)

Set station names other than the ones registered in your recorder.

Perform steps 1 and 2 of "Storing Channels Manually" on page 48 to access the Confirmation screen and then perform step 1 and 2 of "Set Stations (A)" on the left before continuing.

1

SELECT STATION NAME CHARACTER

Press \triangleright until the first letter of the station name begins blinking.

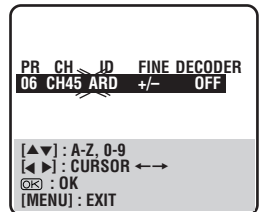

2

ENTER NEW CHARACTER

Press $\Delta \nabla$ to cycle through the characters (A–Z, 0–9, –, *, +, _ (space)) and stop when the desired character is indicated, then press \triangleright to enter. Enter the remaining characters the same way (maximum of 4).

After entering all characters, press **OK**.

- The Confirmation screen appears.
- If you make a mistake, press \triangleleft until the incorrect character begins blinking. Then enter the correct character by pressing $\Delta \nabla$.

3

CLOSE CONFIRMATION SCREEN

Press **MENU**.

TV Station And ID List

ID*	STATION NAME
1000	TV1000
3SAT	3SAT
ADLT	ADULT
ANT3	ANTENA3
ARD	ARD
ARTE	ARTE
BBC	BBC GROUP
BBC1	BBC1
BBC2	BBC2
BR3	BAYERN3
C+	CANAL PLUS
C1	PORTUGUSES
CAN5	CANALE5
CH4	CHANNEL4
CH5	CHANNEL5
CHLD	CHILD
CINE	CINEMA
CLUB	TELECLUB
CMT	CMT
CNN	CNN
CSUR	ANDALUCIA
DISC	DISCOVERY
DR	DR TV
DRS	DRS
DSF	DSF
ETB1	ETB1
ETB2	ETB2
EURO	EURONEWS
EUSP	EUROSPORTS
FEMM	FEMMAN
FILM	FILM
FNET	FILMNET
FR2	France2
FR3	France3
GALA	GALAVISION
HR3	HESSEN3
INFO	INFO-KANAL
ITA1	ITALIA1
ITA7	ITALIA7
ITV	ITV
JSTV	JSTV
KA2	KA2
KAB1	KABEL1
KAN2	KANAL2
LOCA	LOCAL
M6	M6
MBC	MBR
MCM	MCM
MDR	MDR
MOVE	MOVIE
MTV	MTV
MTV3	MTV3
N3	NORD3
N-TV	N-TV
NBC	NBC SUPER
NDR3	NDR3
NED1	NED1
NED2	NED2
NED3	NED3
NEWS	
NICK	NICKELODEON
NRK	NRK
NRK2	NRK2
ODE	ODEON
ORF1	ORF1

ID*	STATION NAME
ORF2	ORF2
ORF3	ORF3
OWL3	OWL3
PREM	PREMIERE
PRO7	PRO7
RAI1	RAI1
RAI2	RAI2
RAI3	RAI3
RET4	RETE4
21	TELE21
RTBF	RTBF1 or 2
RTL	RTL
RTL2	RTL2
RTL4	RTL4
RTL5	RTL5
RTP	RTP
S4	SCHWEIZ4
SAT1	SAT1
SBS	SBS
SHOW	SHOW
SIC	SOCIEDADE
SKY	SKY CHANNEL
SKYN	SKY NEWS
SPRT	SPORT
SRTL	SUPER RTL
STAR	STAR-TV
SVT1	SVT1
SVT2	SVT2
SW3	SUEDWEST3
TCC	TCC
TELE	TELE
TEL5	TELE5
TF1	TF1
TM3	TM3
TMC	TELEMONTECARLO
TNT	TNT INT
TRT	TRT INT
TSI	TSI
TSR	TSR
TV1	BRTN TV1
TV2	BRTN TV2
TV3	TV3
TV4	TV4
TV5	TV5
TV6	TV6
TVE1	TVE1
TVE2	TVE2
TVG	TV GALICIA
TVI	TV INDEPENDENT
TVN	TV NORGE
VCR	VIDEO
VERO	VERONICA
VH-1	VH-1
VIVA	VIVA
VIV2	VIVA2
VMTV	VIDEO MUSIC
VOX	VOX
VT4	VT4
VTM	VTM
WDR1	West1
WDR3	West3
YLE1	YLE1
YLE2	YLE2
ZDF	ZDF
ZTV	ZTV

* The "ID" abbreviation is what is shown on-screen in lieu of the station name. The "ID" abbreviation is listed in the Confirmation screen and is displayed on the TV screen when the recorder is tuned to a different station.

Fine-Tuning Channels Already Stored

Perform steps 1 and 2 of "Storing Channels Manually" on page 48 to access the Confirmation screen before continuing.

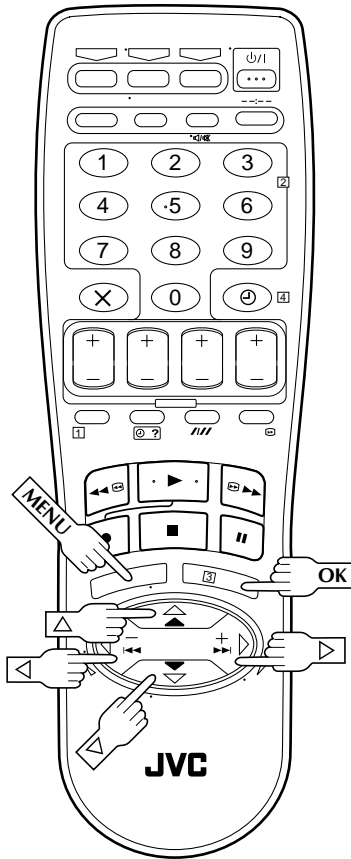

1 SELECT CHANNEL TO FINE-TUNE

Press $\Delta \nabla \triangleleft \triangleright$ until the channel you want to tune begins blinking.

2 ACCESS MANUAL CHANNEL SET SCREEN

Press **OK** twice. The Manual Channel Set screen appears.

3 PERFORM TUNING

Press \triangleright until "+/-" begins blinking, then press $\Delta \nabla$ until the picture is its clearest. Then press **OK**.

- The Confirmation screen appears.
- Repeat steps 1 through 3 as necessary.

4 CLOSE CONFIRMATION SCREEN

Press **MENU**.

SHOWVIEW Setup

IMPORTANT

Normally, Auto Set Up (pg. 4) or Auto Channel Set (pg. 46) sets the Guide Program Numbers automatically. You need to set the Guide Program Numbers manually only in the following cases.

- When timer-programming with SHOWVIEW, the channel position, where the station you wish to record is received on your recorder, is not selected.
 - Set the Guide Program Number for that station manually.
- When you add/delete a channel or change channel positions manually after Auto Set Up or Auto Channel Set has taken place.
 - Set the Guide Program Numbers for all the receivable stations manually.
- When you wish to timer-record a satellite programme with SHOWVIEW.
 - Set the Guide Program Numbers for all satellite broadcasts received on your satellite tuner.

Turn on the TV and select the VIDEO channel (or AV mode).

Guide Program Number Set

1

ACCESS MAIN MENU SCREEN

Press **MENU**.

2

ACCESS INITIAL SET SCREEN

Press $\Delta \nabla$ to move the highlight bar (pointer) to "INITIAL SET", then press **OK** or \triangleright .

3

ACCESS GUIDE PROG SET SCREEN

Press $\Delta \nabla$ to move the highlight bar (pointer) to "GUIDE PROG SET", then press **OK** or \triangleright .

4

ENTER GUIDE PROG NUMBER

Press $\Delta \nabla$ or **NUMBER** keys to enter the Guide Program number for the desired station as shown in the TV listings. Then press **OK** or \triangleright .

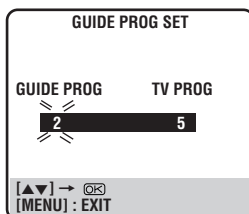

(Ex.) When inputting the Guide Program number 2 for ZDF.

5

ENTER RECEIVING CHANNEL POSITION NUMBER

Press $\Delta \nabla$ or **NUMBER** keys to input the number of the recorder's channel position on which the Guide Program number's broadcast is received. Then press **OK** or \triangleright .

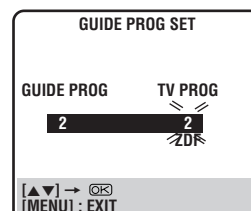

(Ex.) If ZDF is received on channel position 2.

- If the satellite broadcast is received on your recorder's auxiliary channel "L-2", select "L-2" for the channel position.
- Repeat steps 4 and 5 as necessary.

6

RETURN TO NORMAL SCREEN

Press **MENU**.

Guide Program Number

"Guide Program (GUIDE PROG) number" refers to the assigned TV station numbers, according to broadcast area, for SHOWVIEW timer recording. The Guide Program numbers can be found in most TV listings.

Clock Set

Turn on the TV and select the VIDEO channel (or AV mode).

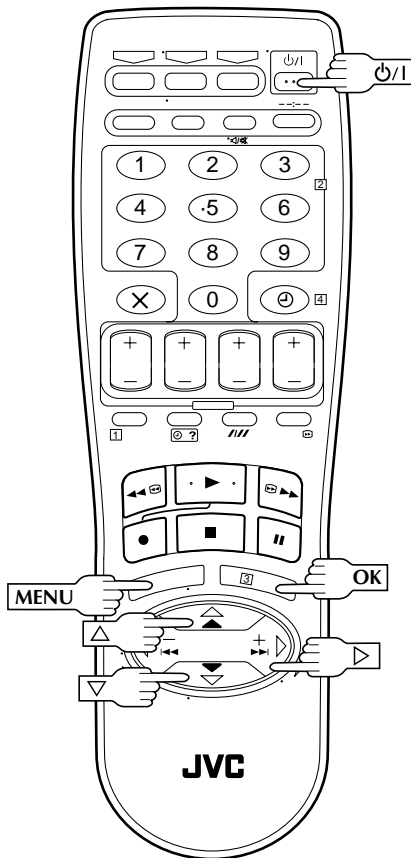

Just Clock

The Just Clock function provides accurate time keeping through automatic adjustments at regular intervals, by reading data from a PDC signal.

The Just Clock option can be set "ON" or "OFF" at the Clock Set screen (the default setting is "OFF"). Press **OK** until the Just Clock setting begins blinking, then press $\Delta\nabla$ to change the setting.

IMPORTANT: If you turn off Just Clock, the accuracy of your recorder's built-in clock may be reduced, which could adversely effect timer recording. We recommend you to keep Just Clock on. In cases where the clock setting data from a PDC signal is incorrect, however, you are advised to keep Just Clock set to "OFF".

IMPORTANT

If you performed Auto Set Up (☞ pg. 4) or Auto Channel Set (☞ pg. 46), without ever having set the clock previously, the recorder's built-in clock is also set automatically. Perform the following steps only if —

- Auto Clock Set has not been performed correctly by Auto Set Up or Auto Channel Set.
- or**
- the recorder's memory backup has expired.
- or**
- you want to change Just Clock setting (☞ "Just Clock" in the left column).

1 TURN THE RECORDER ON

Press ϕ/I .

2 ACCESS MAIN MENU SCREEN

Press **MENU**.

3 ACCESS INITIAL SET SCREEN

Move the highlight bar (pointer) to "INITIAL SET" by pressing $\Delta\nabla$, then press **OK** or \triangleright .

4 ACCESS CLOCK SET SCREEN

Move the highlight bar (pointer) to "CLOCK SET" by pressing $\Delta\nabla$, then press **OK** or \triangleright . The Clock Set screen appears.

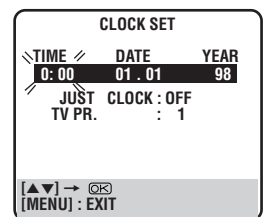
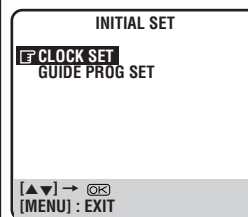

5 SET DATE AND TIME

Press $\Delta\nabla$ to set the time, then press **OK** or \triangleright . The "date" display begins blinking. Repeat the same procedure to set the date and year.

- When you set the time, press and hold $\Delta\nabla$ to change the time by 30 minutes.
- When you set the date, press and hold $\Delta\nabla$ to change the date by 15 days.

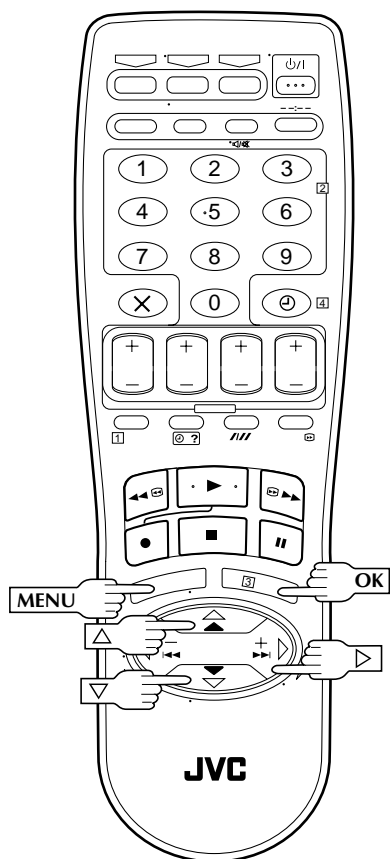

6 SET JUST CLOCK

The default setting is "OFF". Set as desired by pressing $\Delta\nabla$, then press **OK** or \triangleright .

- For the Just clock function, ☞ "Just Clock" on page 54.
- If you set to "OFF", you can disregard the next step as you won't be able to receive regular clock adjustments.

7 SET CLOCK DATA SOURCE CHANNEL POSITION

The recorder is preset to receive clock setting and adjustment data from channel position 1. Press $\Delta\nabla$ to set the channel position to the number representing the station transmitting clock setting data, then press **OK** or \triangleright .

8 START CLOCK OPERATION

Press **MENU**.

NOTES:

- *Just Clock* (when set to "ON") adjusts the recorder's built-in clock every hour, except for 23:00, 0:00, 1:00 and 2:00.
- *Just Clock* is not effective when . . .
 - the recorder's power is on.
 - the recorder is in the *Timer* mode.
 - a difference of more than 3 minutes exists between the built-in clock's time and the actual time.
 - the recorder is in the *Auto Satellite Prog Rec* mode (☞ pg. 32).
 - the recorder is in the *Power Save* mode (☞ pg. 9).
- If *Just Clock* is set to "ON", the recorder's clock is automatically adjusted at the start/end of *Summer Time*.
- *Just Clock* may not function properly depending on the reception condition.

Before requesting service for a problem, use this chart and see if you can repair the trouble yourself. Small problems are often easily corrected, and this can save you the trouble of sending your video recorder off for repair.

POWER		
SYMPTOM	POSSIBLE CAUSE	CORRECTIVE ACTION
1. No power is applied to the recorder.	<ul style="list-style-type: none"> • The mains power cord is disconnected. 	Connect the mains power cord.
2. The clock is functioning properly, but the recorder cannot be powered.	<ul style="list-style-type: none"> • "⊖" is displayed on the display panel with Auto Timer set to "OFF". 	Press the ⊖ button to turn the "⊖" indicator off.
3. The remote control won't function.	<ul style="list-style-type: none"> • The batteries are discharged. 	Replace the dead batteries with new ones.
TAPE TRANSPORT		
SYMPTOM	POSSIBLE CAUSE	CORRECTIVE ACTION
1. The tape does not run during recording.	<ul style="list-style-type: none"> • "⏏" is displayed on the display panel. 	Press PLAY to turn the "⏏" indicator off.
2. The tape will not rewind or fast-forward.	<ul style="list-style-type: none"> • The tape is already fully rewound or fast-forwarded. 	Check the cassette.
PLAYBACK		
SYMPTOM	POSSIBLE CAUSE	CORRECTIVE ACTION
1. The playback picture does not appear while the tape is running.	<ul style="list-style-type: none"> • If you're using the RF OUT connection the TV receiver's channel selector is not set to the VIDEO channel. . . . the recorder's VIDEO channel has not been correctly set. • If you're using the AV connection, the TV receiver is not set to the AV mode. 	<p>If you are using the RF OUT connection set the TV receiver to the VIDEO channel. (☞ pg. 5) . . . perform "Video Channel Set". (☞ pg. 45)</p> <p>If you are using the AV connection, set the TV to its AV mode.</p>
2. Noise appears during normal playback.	<ul style="list-style-type: none"> • The automatic tracking mode is engaged. 	Try manual tracking. (☞ pg. 14)
3. The playback picture is blurred or interrupted while TV broadcasts are clear.	<ul style="list-style-type: none"> • The video heads may be dirty. 	Consult your JVC dealer.
4. Breaks are noticeable in Hi-Fi soundtrack	<ul style="list-style-type: none"> • Automatic tracking is engaged. 	Engage and adjust tracking manually. (☞ pg. 14)
RECORDING		
SYMPTOM	POSSIBLE CAUSE	CORRECTIVE ACTION
1. Recording cannot be started.	<ul style="list-style-type: none"> • There is no cassette loaded, or the cassette loaded has had its Record Safety tab removed. 	Insert a cassette, or using adhesive tape, reseal the slot where the tab was removed.
2. TV broadcasts cannot be recorded.	<ul style="list-style-type: none"> • "L-1", "L-2" or "F-1" has been selected as the input mode. 	Set to the desired channel.
3. Tape-to-tape editing is not possible.	<ul style="list-style-type: none"> • The source (another video recorder, camcorder) has not been properly connected. • All necessary power switches have not been turned on. • The input mode is not correct. 	<p>Confirm that the source is properly connected.</p> <p>Confirm that all units' power switches are turned on. Set the input mode to "L-1", "L-2" or "F-1".</p>
4. Camcorder recording is not possible.	<ul style="list-style-type: none"> • The camcorder has not been properly connected. • The input mode is not correct. 	<p>Confirm that the camcorder is properly connected.</p> <p>Set the input mode to "L-1", "L-2" or "F-1".</p>

TIMER RECORDING

SYMPTOM	POSSIBLE CAUSE	CORRECTIVE ACTION
1. Timer recording won't work.	<ul style="list-style-type: none"> • The clock and/or the timer have been set incorrectly. • The timer is not engaged. 	Re-perform the clock and/or timer settings. Press \ominus and confirm that " \ominus " is displayed on the display panel.
2. Timer programming is not possible.	<ul style="list-style-type: none"> • Timer recording is in progress. 	Timer programming can't be performed while a timer recording is in progress. Wait until it finishes.
3. " \ominus " and " \square " on the display panel won't stop blinking.	<ul style="list-style-type: none"> • The timer is engaged but there's no cassette loaded. 	Load a cassette with the Record Safety tab intact, or cover the hole using adhesive tape.
4. The cassette is automatically ejected, and " \ominus " and " \square " on the display panel won't stop blinking.	<ul style="list-style-type: none"> • The loaded cassette has had its Record Safety tab removed. 	Remove the cassette and cover the hole with adhesive tape, or insert a cassette with the Record Safety tab intact.
5. " \ominus " blinks for 10 seconds and the Timer mode is disengaged.	<ul style="list-style-type: none"> • \ominus has been pressed when there are no programs in memory, or the timer record information has been programmed incorrectly. 	Check the programmed data and re-program as necessary, then press \ominus again.
6. The cassette is automatically ejected, the power shuts off and " \ominus " and " \square " won't stop blinking.	<ul style="list-style-type: none"> • The end of the tape was reached during timer recording. 	The programme may not have been recorded in its entirety. Next time make sure you have enough time on the tape to record the entire programme.
7. SHOWVIEW does not timer-record properly.	<ul style="list-style-type: none"> • The recorder's channel positions have been set incorrectly. 	Refer to "Guide Program Number Set" and re-perform the procedure (☞ pg. 53).

OTHER PROBLEMS

SYMPTOM	POSSIBLE CAUSE	CORRECTIVE ACTION
1. Whistling or howling is heard from the TV during camcorder recording.	<ul style="list-style-type: none"> • The camcorder's microphone is too close to the TV. • The TV's volume is too high. 	Position the camcorder so its microphone is away from the TV. Turn the TV's volume down.
2. When scanning channels, some of them are skipped over.	<ul style="list-style-type: none"> • Those channels have been designated to be skipped. 	If you need the skipped channels, restore them (☞ pg. 48).
3. The channel cannot be changed.	<ul style="list-style-type: none"> • Recording is in progress. 	Press PAUSE to pause the recording, change channels, then press PLAY to resume recording.
4. Channel settings that were made manually seem to have changed or disappeared.	<ul style="list-style-type: none"> • After the manual settings were made, Auto Channel Set was performed. 	Perform manual setting again.
5. No channels are stored in the recorder's memory.	<ul style="list-style-type: none"> • The TV aerial cable was not connected to the recorder when Auto Set Up was performed. 	Connect the TV aerial cable to the recorder properly and turn off the recorder power once, then turn the recorder power back on again. The recorder will try Auto Set Up again (☞ pg. 4).
6. The remote control won't operate the TV or satellite tuner.	<ul style="list-style-type: none"> • The remote control brand setting is incorrect. 	Re-set the remote control to the correct brand (☞ pg. 34, 35).

PLAYBACK

Q. What happens if the end of the tape is reached during playback or search?

A. The tape is automatically rewound to the beginning.

Q. Can the video recorder indefinitely remain in the still mode?

A. No. It stops automatically after 5 minutes to protect the heads.

Q. When returning from multi-speed search to normal playback, the picture is disturbed. Should I be concerned about this?

A. No, it is normal.

Q. Other than preventing further recording, what effect does removing the Record Safety tab have?

A. It disables marking of index codes.

Q. Sometimes, during Index Search, the video recorder can't find the programme I want to see. Why not?

A. There may be index codes too close together.

RECORDING

Q. When I pause and then resume a recording, the end of the recording before the pause is overlapped by the beginning of the continuation of recording. Why does this happen?

A. This is normal. It reduces distortion at the pause and resume points.

Q. Can the video recorder indefinitely remain in the Record-Pause mode?

A. No. The video recorder goes to its Stop mode automatically after 5 minutes to protect the heads.

Q. What happens if the tape runs out during recording?

A. The video recorder automatically rewinds it to the beginning.

TIMER RECORDING

Q. "⊙" and "⊖" remain lit on the display panel. Is there a problem?

A. No. This is a normal condition for a timer recording in progress.

Q. Can I programme the timer while I'm watching a tape or a TV broadcast?

A. You won't see the picture as it is replaced by the on-screen menu, but the audio from the programme or tape you're viewing can be heard.

Q. Is it possible to timer-record a TV programme broadcast in 2000?

A. Yes, it is possible.

ATTENTION

This recorder contains microcomputers. External electronic noise or interference could cause malfunctioning. In such cases, switch the recorder off and unplug the mains power cord. Then plug it in again and turn the recorder on. Take out the cassette. After checking the cassette, operate the unit as usual.

FRONT VIEW

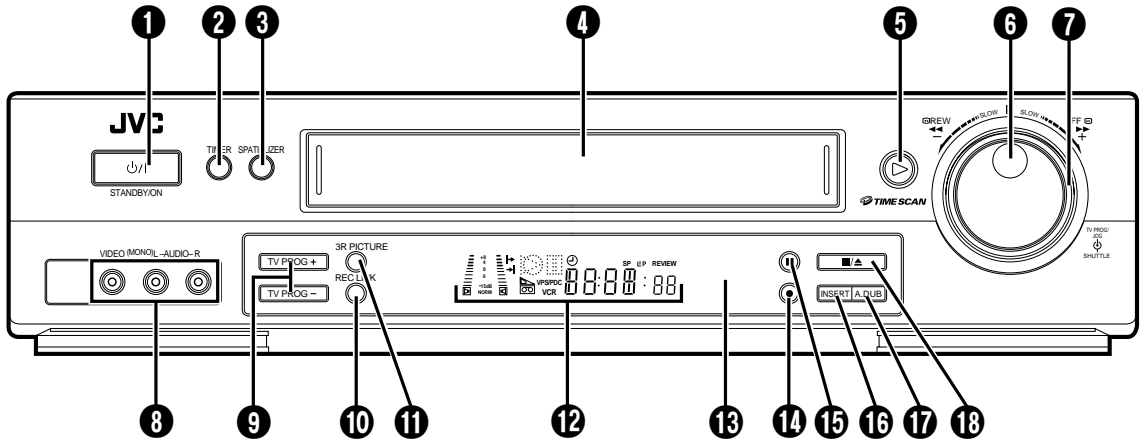

Attach the provided connector cover when you do not use the front panel connectors.

- ❶ STANDBY/ON ϕ /I Button \hookrightarrow pg. 4
- ❷ TIMER Button \hookrightarrow pg. 27, 29
- ❸ SPATIALIZER Button \hookrightarrow pg. 16
- ❹ Cassette Loading Slot
- ❺ PLAY Button \hookrightarrow pg. 11
- ❻ TV PROG Dial \hookrightarrow pg. 20
- ❼ TIME SCAN SHUTTLE Ring \hookrightarrow pg. 12 (HR-DD858E/EH)
SHUTTLE Ring \hookrightarrow pg. 13 (HR-J758E/EH)
- ❽ VIDEO/AUDIO Input Connectors \hookrightarrow pg. 38
- ❾ TV PROG +/- Buttons \hookrightarrow pg. 20
- ❿ REC LINK Button \hookrightarrow pg. 32
- ⓫ 3R PICTURE Button \hookrightarrow pg. 14
- ⓬ Display Panel \hookrightarrow pg. 60
- ⓭ Infrared Beam Receiving Window
- ⓮ RECORD Button \hookrightarrow pg. 20
- ⓯ PAUSE Button \hookrightarrow pg. 12, 13
- ⓰ INSERT Button \hookrightarrow pg. 40 (HR-DD858E/EH)
SP/LP Button \hookrightarrow pg. 20 (HR-J758E/EH)
- ⓱ A. DUB [Audio Dubbing] Button \hookrightarrow pg. 39 (HR-DD858E/EH)
DISPLAY Button \hookrightarrow pg. 21 (HR-J758E/EH)
- ⓲ STOP/EJECT Button \hookrightarrow pg. 11

REAR VIEW

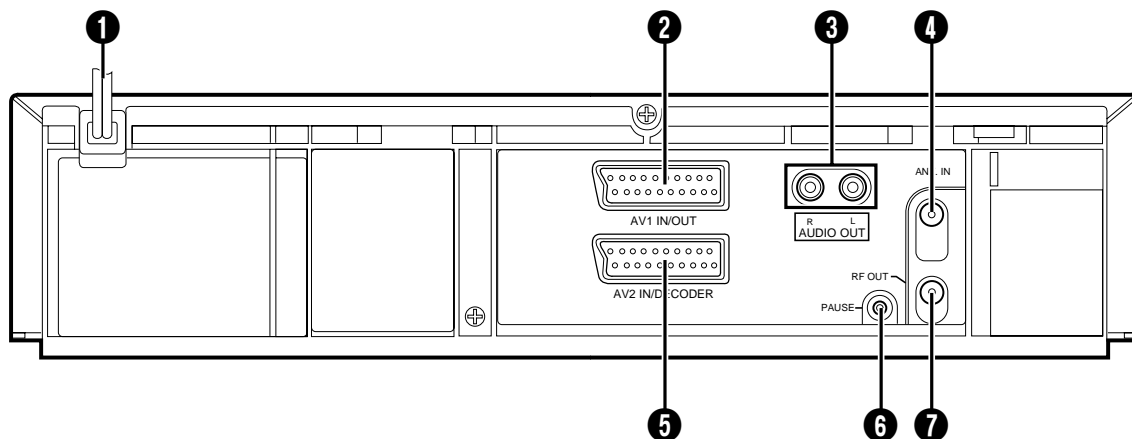

- ❶ Mains Power Cord ☞ pg. 3
- ❷ AV1 IN/OUT Connector ☞ pg. 3, 36
- ❸ AUDIO OUT (L/R) Connectors ☞ pg. 44
- ❹ ANT. IN Connector ☞ pg. 3
- ❺ AV2 IN/DECODER Connector ☞ pg. 37,42, 43
- ❻ Remote PAUSE Connector ☞ pg. 38
- ❼ RF OUT Connector ☞ pg. 3

DISPLAY PANEL

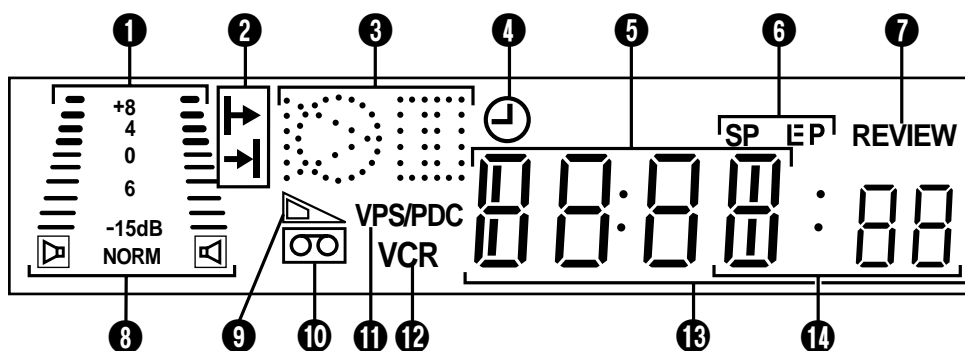

- ❶ B.E.S.T. Picture System Display ☞ pg. 24
Audio Level Indicator ☞ pg. 23
- ❷ Programme Time Indicators ☞ pg. 28
- ❸ Symbolic Mode Indicators
- ❹ "Timer" Indicator ☞ pg. 27, 29
- ❺ Channel/Clock Display ☞ pg. 6
- ❻ Tape Speed Indicators ☞ pg. 20
EP is only for NTSC playback
- ❼ Instant REVIEW Indicator ☞ pg. 15
- ❽ Audio Mode Indicator ☞ pg. 16
- ❾ Tape Remaining Time Indicator ☞ pg. 21
- ❿ "Cassette Loaded" Mark
- ⓫ VPS/PDC Indicator ☞ pg. 27, 29
- ⓬ VCR Indicator ☞ pg. 21
- ⓭ Counter/Remain Display
- ⓮ Mode Display (L-1, L-2 or F-1)

PLAY: FF/REW VARIABLE SHUTTLE SEARCH:		STILL: SLOW:	
		RECORD:	
		RECORD PAUSE:	
AUDIO DUBBING*:			
AUDIO DUBBING PAUSE*:			
INSERT*:			
INSERT PAUSE*:			
AUDIO DUBBING INSERT*:			
AUDIO DUBBING INSERT PAUSE*:			

* HR-DD858E/EH only.

REMOTE CONTROL

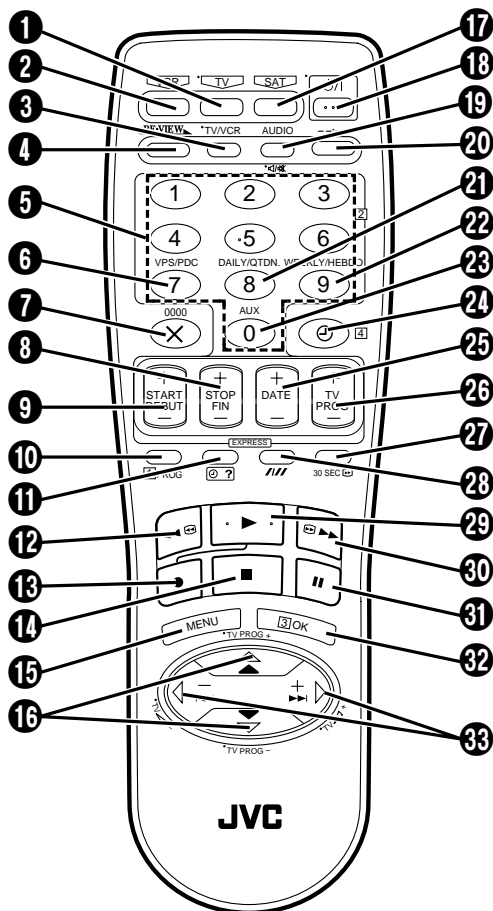

Buttons with a small dot on the left side of the name can also be used to operate your TV ☞ pg. 34.

- 1 TV Button ☞ pg. 34
- 2 VCR Button ☞ pg. 34
- 3 TV/VCR Button ☞ pg. 21, 34
- 4 REVIEW Button ☞ pg. 15
- 5 NUMBER Keys ☞ pg. 20, 26
- 6 VPS/PDC Button ☞ pg. 27, 29
- 7 X Button ☞ pg. 30
0000 Button ☞ pg. 21
- 8 STOP +/- Button ☞ pg. 28
- 9 START +/- Button ☞ pg. 28
- 10 PROG Button ☞ pg. 26
- 11 ? Button ☞ pg. 30
- 12 Rewind [REW] Button ☞ pg. 11, 12, 13
- 13 Record Button ☞ pg. 20
- 14 Stop Button ☞ pg. 11, 20
- 15 MENU Button ☞ pg. 7
- 16 Δ▽ Button ☞ pg. 4
TV PROG +/- ☞ pg. 34
- 17 SAT Button ☞ pg. 35
- 18 STANDBY/ON ⏻/⏻ Button ☞ pg. 4
- 19 AUDIO Button ☞ pg. 16
- 20 Muting (TV Muting) Button ☞ pg. 34
- 21 DISPLAY Button ☞ pg. 21
- 22 DAILY Button ☞ pg. 27, 29
- 23 WEEKLY Button ☞ pg. 27, 29
- 24 AUX Button ☞ pg. 36
- 25 ⊕ Button ☞ pg. 27, 29
- 26 DATE +/- Button ☞ pg. 28
- 27 TV PROG +/- Button ☞ pg. 20
- 28 30 SEC Button ☞ pg. 15
- 29 Auto Tracking Button ☞ pg. 14
SP/LP Button ☞ pg. 20
- 30 Play Button ☞ pg. 11
- 31 Fast Forward [FF] Button ☞ pg. 11, 12, 13
- 32 Pause Button ☞ pg. 12, 13
- 33 OK Button ☞ pg. 5
- 34 <|> Button ☞ pg. 12, 13, 15
TV Δ +/- Button ☞ pg. 34

How To Use

The remote control can operate most of your video recorder's functions, as well as basic functions of TV sets and satellite tuners of JVC and other brands. ☞ pg. 34, 35.

- Point the remote control toward the sensor window.
- The maximum operating distance of the remote control is about 8 m.

NOTES:

- When inserting the batteries, be sure to insert in the correct directions as indicated under the battery cover.
- If the remote control doesn't work properly, remove its batteries, wait a short time, replace the batteries and then try again.

ATTENTION

The remote control can operate not only the video recorder but also some of your TV and satellite tuner's functions.

- To operate your video recorder, first press the **VCR** button to set the remote control to the Video mode.
- To operate your TV, first press the **TV** button to set the remote control to the TV mode (☞ pg. 34).
- To operate your satellite tuner, first press the **SAT** button to set the remote control to the Satellite tuner mode (☞ pg. 35).

GENERAL

Power requirement	: AC 220 – 240 V~, 50/60 Hz
Power consumption	
Power on	: 24 W
Power off	: 5.5 W
Power save (HR-J758E and HR-DD858E only)	: 3 W
Temperature	
Operating	: 5°C to 40°C
Storage	: -20°C to 60°C
Operating position	: Horizontal only
Dimensions (WxHxD)	: 400 x 94 x 347 mm
Weight	: 3.8 kg
Format	: VHS PAL standard
Maximum recording time	
(SP)	: 240 min. with E-240 video cassette
(LP)	: 480 min. with E-240 video cassette

VIDEO/AUDIO

Signal system	: PAL-type colour signal and CCIR monochrome signal, 625 lines 50 fields
Recording system	: DA4 (Double Azimuth) head helical scan system
Signal-to-noise ratio	: 45 dB
Horizontal resolution	: 250 lines
Frequency range	: 70 Hz to 10,000 Hz (Normal audio) 20 Hz to 20,000 Hz (Hi-Fi audio)
Input/Output	: 21-pin scart connectors : IN/OUT x 1, IN/DECODER x 1 RCA connectors: VIDEO IN x 1, AUDIO IN x 1, AUDIO OUT x 1

TUNER/TIMER

TV channel storage capacity	: 99 positions (+AUX position)
Tuning system	: Frequency synthesized tuner
Channel coverage	: VHF 47 – 89/104 – 300/ 302 – 470MHz UHF 470 – 862MHz
Aerial output	: UHF channels 22 – 69 (Adjustable)
Memory backup time	: Approx. 60 min.

ACCESSORIES

Provided accessories	: RF cable, Infrared remote control unit, "R6" battery x 2, Connector cover (for front panel connectors)
----------------------	--

Specifications shown are for SP mode unless otherwise specified.

E. & O.E. Design and specifications subject to change without notice.

Auto Set Up - referring to the display panel

The Auto Set Up function sets the tuner channels, clock, Guide Program numbers and video channel* automatically.

* Useful for RF connection users.

BEFORE YOU START PLEASE MAKE SURE THAT:

- The TV aerial cable is connected to the ANT.IN jack on the rear panel of the video recorder.
- The video recorder's mains power cord is connected to a mains outlet.
- The video recorder is turned off.
- Load batteries into the remote control.

1 Press P/I (recorder/remote).



2 Press Δ/∇ (remote) to select the international telephone country code.

(Ex.) DEUTSCHLAND is selected.



- If you have selected a country code other than 32 (BELGIUM) or 41 (SUISSE), go to step 3.

International Telephone Country Code

SUISSE	: 41	SUOMI	: 358
ITALIA	: 39	PORTUGAL	: 351
ESPAÑA	: 34	DEUTSCHLAND	: 49
BELGIUM	: 32	NORGE	: 47
NEDERLAND	: 31	SVERIGE	: 46
GREECE	: 30	DANMARK	: 45
OTHERS	: --	ÖSTERREICH	: 43

- If you have selected 32 (BELGIUM) or 41 (SUISSE), press **OK** (remote) and select the language code by pressing Δ/∇ (remote), then go to step 3.

(Ex.) FRANCAIS is selected for BELGIUM

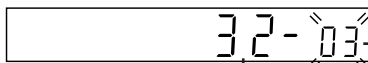

International Telephone
Country Code

Language Code

Language Code

ENGLISH	: 01	NEDERLANDS	: 06
DEUTSCH	: 02	SVENSKA	: 07
FRANCAIS	: 03	NORSK	: 08
ITALIANO	: 04	SUOMI	: 09
CASTELLANO	: 05	DANSK	: 10

3 Press **OK** (remote). Do NOT press any button on the video recorder or remote control until the display panel shows as follows.

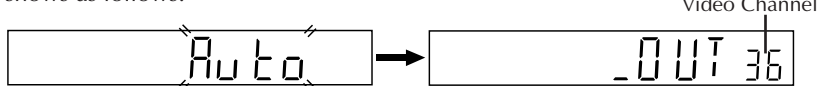

- If "-:--" appears on the display panel, see page 6 of the instructions.

- If you have connected the video recorder to your TV via RF connection, press **OK** to finish the Auto Set Up. To view picture signals from the video recorder, set your TV to the Video Channel.
- If you have connected the video recorder to your TV via AV connection, press **TV PROG** – until the display panel shows "-OUT--" to set the Video Channel to off, then press **OK** to finish the Auto Set Up. To view picture signals from the video recorder, set your TV to its AV mode.

* Once you have performed Auto Set Up, even if the recorder's memory backup has expired, the recorder will not perform Auto Set Up again. Perform tuner setting (☞ pg. 46), clock setting (☞ pg. 54) and/or Video Channel setting (☞ pg. 45) as required.

FOR MORE INFORMATION SEE INSTRUCTIONS/P4

JVC

VICTOR COMPANY OF JAPAN, LIMITED

Free Manuals Download Website

<http://myh66.com>

<http://usermanuals.us>

<http://www.somanuals.com>

<http://www.4manuals.cc>

<http://www.manual-lib.com>

<http://www.404manual.com>

<http://www.luxmanual.com>

<http://aubethermostatmanual.com>

Golf course search by state

<http://golfingnear.com>

Email search by domain

<http://emailbydomain.com>

Auto manuals search

<http://auto.somanuals.com>

TV manuals search

<http://tv.somanuals.com>