

JVC



VIDEO CASSETTE RECORDER

HR-J250E

ENGLISH

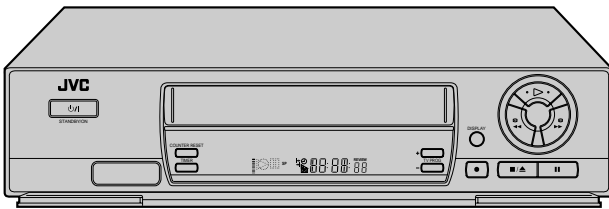

INSTRUCTIONS

CONTENTS

SAFETY FIRST	2
Safety Precautions	2
INSTALLING YOUR NEW RECORDER 3	
Basic Connections	3
INITIAL SETTINGS	4
Video Channel Set	4
Auto Set Up	5
On-Screen Displays	6
INFORMATION ON COLOUR SYSTEM	7
Colour System Set	7
PLAYBACK	8
Basic Playback	8
Playback Features	9
RECORDING	12
Basic Recording	12
Recording Features	13
B.E.S.T. Picture System	14
TIMER RECORDING	16
Express Timer Programming	16
EDITING	20
Edit To Or From Another Video Recorder	20
Edit From A Camcorder	21
SUBSIDIARY SETTINGS	22
Tuner Set	22
Clock Set	28
QUESTIONS AND ANSWERS	29
TROUBLESHOOTING	30
INDEX	32
SPECIFICATIONS	35

LPT0045-001A

EN

Safety Precautions

The rating plate and the safety caution are on the rear of the unit.

WARNING: DANGEROUS VOLTAGE INSIDE

WARNING: TO PREVENT FIRE OR SHOCK HAZARD, DO NOT EXPOSE THIS UNIT TO RAIN OR MOISTURE.

CAUTION

- When you are not using the recorder for a long period of time, it is recommended that you disconnect the power cord from the mains outlet.
- Dangerous voltage inside. Refer internal servicing to qualified service personnel. To prevent electric shock or fire hazard, remove the power cord from the mains outlet prior to connecting or disconnecting any signal lead or aerial.

WARNING

There are two different types of SECAM colour systems: SECAM-L, used in FRANCE (also called SECAM-West), and SECAM-B, used in Eastern European countries (also called SECAM-East).

1. This recorder can also receive SECAM-B colour television signals for recording and playback.
2. Recordings made of SECAM-B television signals produce monochrome pictures if played back on a video recorder of SECAM-L standard, or do not produce normal colour pictures if played back on a PAL video recorder with SECAM-B system incorporated (even if the TV set is SECAM-compatible).
3. SECAM-L prerecorded cassettes or recordings made with a SECAM-L video recorder produce monochrome pictures when played back with this recorder.
4. This recorder cannot be used for the SECAM-L standard. Use a SECAM-L recorder to record SECAM-L signals.

For Italy:

"It is declared that this product, brand JVC, conforms to the Ministry Decree n. 548 of 28 Aug.'95 published in the Official Gazette of the Italian Republic n. 301 of 28 Dec.'95"

The STANDBY/ON ϕ /I button does not completely shut off mains power from the unit, but switches operating current on and off. " ϕ " shows electrical power standby and " I " shows ON.

IMPORTANT

- Please read the various precautions on this page before installing or operating the recorder.
- It should be noted that it may be unlawful to re-record pre-recorded tapes, records, or discs without the consent of the owner of copyright in the sound or video recording, broadcast or cable programme and in any literary, dramatic, musical, or artistic work embodied therein.

Video tapes recorded with another recorder in the LP (Long Play) mode cannot be played back on this video recorder.

Failure to heed the following precautions may result in damage to the recorder, remote control or video cassette.

1. **DO NOT** place the recorder . . .

- ... in an environment prone to extreme temperatures or humidity.
- ... in direct sunlight.
- ... in a dusty environment.
- ... in an environment where strong magnetic fields are generated.
- ... on a surface that is unstable or subject to vibration.

2. **DO NOT** block the recorder's ventilation openings.

3. **DO NOT** place heavy objects on the recorder or remote control.

4. **DO NOT** place anything which might spill on top of the recorder or remote control.

5. **AVOID** violent shocks to the recorder during transport.

MOISTURE CONDENSATION

Moisture in the air will condense on the recorder when you move it from a cold place to a warm place, or under extremely humid conditions—just as water droplets form in the surface of a glass filled with cold liquid. Moisture condensation on the head drum will cause damage to the tape. In conditions where condensation may occur, keep the recorder turned on for a few hours to let the moisture dry.

ABOUT HEAD CLEANING

Accumulation of dirt and other particles on the video heads may cause the playback picture to become blurred or interrupted. Be sure to contact your nearest JVC dealer if such troubles occur.

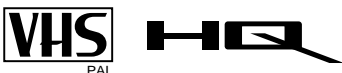

- Cassettes marked "VHS" (or "S-VHS") can be used with this video cassette recorder, however, only VHS signals can be played back and recorded.
- HQ VHS is compatible with existing VHS equipment.

Basic Connections

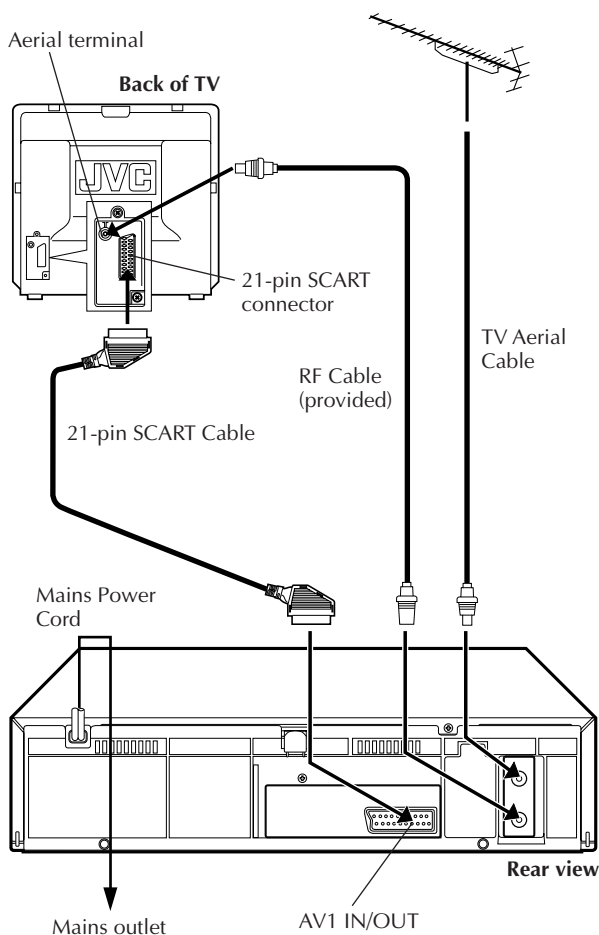

Make AV connection if your TV has a 21-pin AV input connector (SCART) in order to reduce the possibility of interference.

It's essential that your video recorder be properly connected. Follow these steps carefully. THESE STEPS MUST BE COMPLETED BEFORE ANY VIDEO OPERATION CAN BE PERFORMED.

1

CHECK CONTENTS

Make sure the package contains all of the accessories listed in "Specifications" (pg. 35).

2

SITUATE RECORDER

Place the recorder on a stable, horizontal surface.

3

CONNECT RECORDER TO TV

The connection method you use depends on the type of TV you have.

RF CONNECTION

- *To Connect To A TV With NO AV Input Terminals . . .*
 - a- Disconnect the TV aerial cable from the TV.
 - b- Connect the TV aerial cable to the ANT. IN jack on the rear panel of the recorder.
 - c- Connect the provided RF cable between the RF OUT jack on the rear panel of the recorder and the TV's aerial terminal.

AV CONNECTION

- *To Connect To A TV With AV Input Terminals . . .*
 - a- Connect the aerial, recorder and TV as per "RF CONNECTION".
 - b- Connect an optional SCART cable between the AV1 IN/OUT socket on the rear panel of the recorder and the TV's 21-pin SCART connector.

4

CONNECT RECORDER TO MAINS

Plug the end of the mains power cord into a mains outlet.

ATTENTION

If you have finished all the necessary connections, go to "Video Channel Set" on page 4, then perform Auto Set Up on page 5; do NOT press the $\psi/1$ button on the recorder/remote control to turn on the recorder's power before you start Auto Set Up.

Video Channel Set

Video Channel (RF Output Channel) is the channel on which your TV receives picture and sound signals from the video recorder through the RF cable.

If you have connected the video recorder to your TV via both the RF cable and a 21-pin SCART cable (AV connection), since you do not need the video channel you have to set the video channel to off.

If you have connected the video recorder to your TV via the RF cable only (RF connection), you have to set the correct video channel.

IMPORTANT:

Before performing the following steps, make sure the recorder's power is off and there is no cassette inserted in the recorder.

1

ACCESS VIDEO CHANNEL SET MODE

Hold down **STOP** (■/▲) on the recorder until the display panel shows the following.

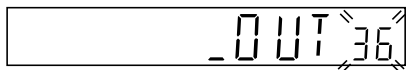

3

TURN OFF THE RECORDER

Press **⏻/I**.

With AV Connection:

To view picture signals from the video recorder, set your TV to its AV mode.

With RF Connection:

The channel on which the screen in step 2 appears clearly is your video channel.

To view picture signals from the video recorder, set your TV to the Video Channel.

After you finish this procedure, go to "Auto Set Up" on page 5.

2

SET VIDEO CHANNEL

With AV Connection

Press **TV PROG** – until the display panel shows "_OUT--".

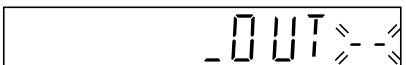

- Now the video channel is set to off.

With RF Connection

Set your TV to UHF channel 36.

- If the two vertical white bars appear clearly on the screen as shown to the right, go to step 3.
- If the two vertical white bars do not appear clearly, press **TV PROG** + or – to set the video recorder to a vacant channel between 28 and 60 which is not occupied by any local station in your area.

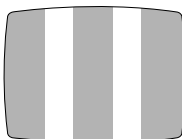

(Ex.) If channel 50 is available in your area

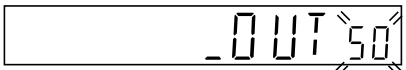

Then set your TV to UHF channel 50 and check if the two vertical white bars appear clearly on the screen; if so, go to step 3. If not, re-set the video recorder to another vacant channel and try again.

NOTES:

- If you set the video recorder to a channel which is occupied by a local station or has neighbouring channels that are occupied by local stations, the picture reception quality will be affected and some interference noise will appear on the TV screen. Be sure to select a vacant channel which has no broadcast on neighbouring channels.
- If you cannot obtain the two vertical white bars clearly with any channel between 28 and 60, consult your JVC dealer.

Auto Set Up

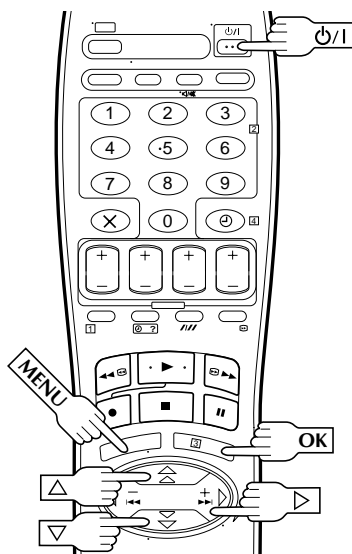
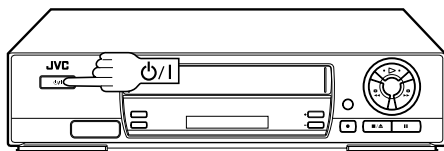

ATTENTION

Once you have performed Auto Set Up, even if the recorder's memory backup has expired, all the stored stations remain in the recorder's memory and the recorder will not perform Auto Set Up again. You only need to set the clock. (☞ pg. 28)

If you have moved to a different area, perform each setting as required.

- Tuner setting ☞ pg. 22
- Clock setting ☞ pg. 28

If a new station starts broadcasting in your area, perform tuner setting (☞ pg. 22).

NOTES:

- If you perform Auto Channel Set when the aerial cable is not connected properly, "SCAN COMPLETED -NO SIGNAL-" appears on the screen. When this happens, make sure of the aerial connection and press **OK**; Auto Channel Set will take place again.
- If there is a power cut, or if you press **⏻** or **MENU** while Auto Channel Set is in progress, Auto Channel Set will be interrupted; be sure to turn off the recorder power once and try again.

The Auto Set Up function simplifies clock and tuner set. To set the clock and tuner channels, simply follow the on-screen menu that appears when the **⏻** button on the recorder/remote control is pressed for the first time to power on the recorder after you plug the mains power cord into a mains outlet.

Before performing the following steps, make sure that:

- the TV aerial cable is connected to the recorder (☞ pg. 3).
- the Video Channel is set correctly (☞ pg. 4).
- the TV is turned on and the VIDEO channel or AV mode is selected.

START AUTO SET UP

Press **⏻**.

- The Clock Set screen appears.

SET DATE AND TIME

Press **Δ∇** to set the time, then press **OK** or **▷**. The "date" display begins blinking. Repeat the same procedure to set the date and year.

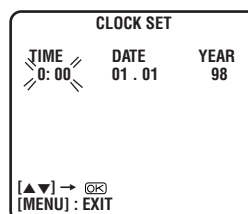

- When you set the time, press and hold **Δ∇** to change the time by 30 minutes.
- When you set the date, press and hold **Δ∇** to change the date by 15 days.

PERFORM AUTO CHANNEL SET

Press **MENU** and the "AUTO SET" screen appears. When Auto Channel Set is completed, "SCAN COMPLETED" appears for about 5 seconds on the screen, then the normal screen appears.

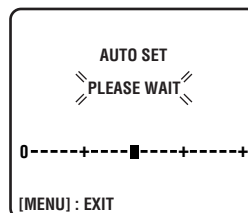

- The Auto Channel Set function scans all the channels that are receivable by your recorder. It then automatically assigns each receivable channels to the **TV PROG** buttons. It skips non-receivable channels.
- As Auto Channel Set progresses, the "■" mark on the screen moves from left to right.

If you want to set the tuner manually such as to add or skip channels, to change channel positions, or to set or change station names, see pages 24 – 26.

On-Screen Displays

Turn on the TV and select the VIDEO channel (or AV mode).

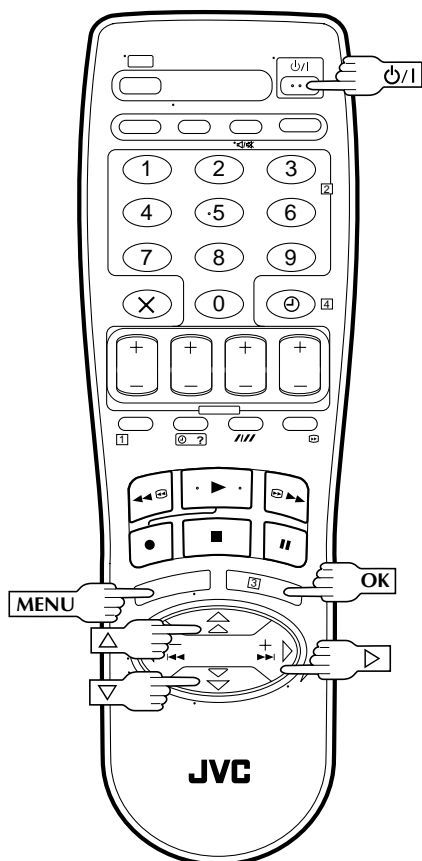

You can choose whether or not to have various operational indicators appear on screen, by setting this function ON or OFF.

1 TURN ON THE RECORDER

Press **⏻**.

2 ACCESS MAIN MENU SCREEN

Press **MENU**.

3 ACCESS MODE SET SCREEN

Place the pointer next to "MODE SET" by pressing **△▽**, then press **OK** or **▷**.

4 ENABLE/DISABLE ON-SCREEN DISPLAY

The default setting is "ON", so if you want on-screen displays, leave the setting as it is and go to step 5. If you don't want the displays to appear, press **△▽** to place the pointer next to "O.S.D." and press **OK** or **▷** to set "O.S.D." to "OFF".

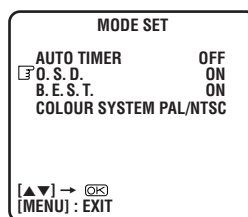

5 RETURN TO NORMAL

Press **MENU**.

NOTES:

- When you use this recorder as the player for editing, be sure to set "O.S.D." to "OFF" before starting.
- During playback, the operation mode indicators may be disturbed depending on the type of tape being used.

The superimposed indication on the TV screen tells you what the recorder is doing.

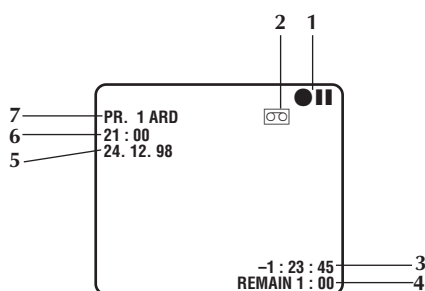

- 1- Operation mode indicators
 - 2- Cassette loaded mark
 - 3- Counter display
 - 4- Tape remaining time indicator (☞ pg. 13)
 - 5- Current day/month/year
 - 6- Clock display
 - 7- Channel position number and station name*/Aux. indicator (L-1)
- * Displayed if you have set station names manually (☞ pg. 26).

Colour System Set

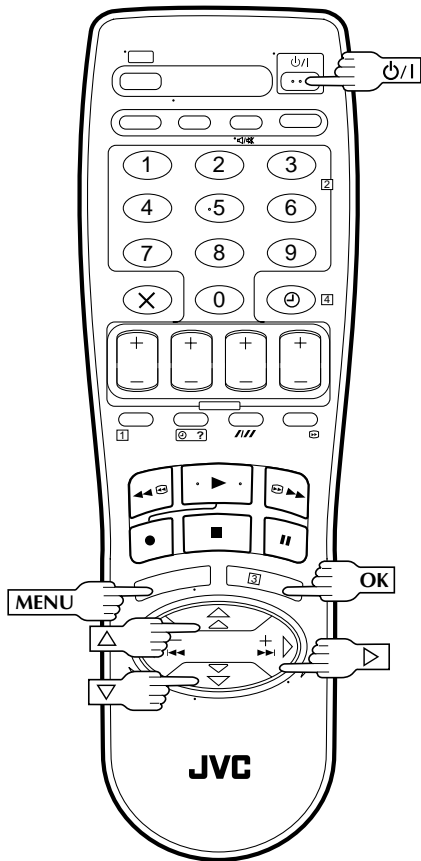

1 TURN ON THE RECORDER

Press \mathcal{P}/I .

2 ACCESS MAIN MENU SCREEN

Press MENU.

3 ACCESS MODE SET SCREEN

Press Δ/∇ to place the pointer next to "MODE SET", then press OK or \triangleright .

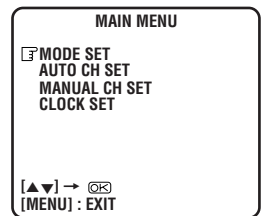

4 SELECT COLOUR SYSTEM MODE

Press Δ/∇ to place the pointer next to "COLOUR SYSTEM", then press OK or \triangleright to select the appropriate colour system.

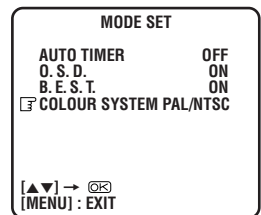

- a- PAL/NTSC: To record PAL signals, or play back a PAL or NTSC tape.
- b- MESECAM: To record SECAM signals, or play back a MESECAM tape.

5 RETURN TO NORMAL SCREEN

Press MENU.

NOTES:

About NTSC Playback

- Some TVs shrink the picture vertically and place black bars at the top and bottom of the screen. This is not a malfunction on the part of either the video recorder or the TV.
- The picture may roll up and down. This can be corrected using the V-HOLD control found on some TVs. (This cannot be corrected if the TV does not have a V-HOLD control.)
- The counter and tape remaining time readings will be incorrect.
- During search, still, or frame-by-frame playback, the picture will be distorted, and there may be a loss of colour.
- Depending on the type of TV, the top and bottom portions of superimposed displays may be cut off during NTSC playback.

Basic Playback

Turn on the TV and select the VIDEO channel (or AV mode).

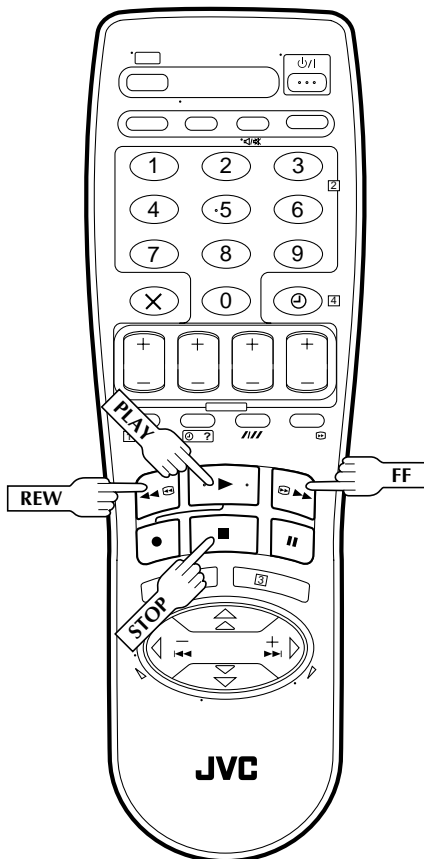
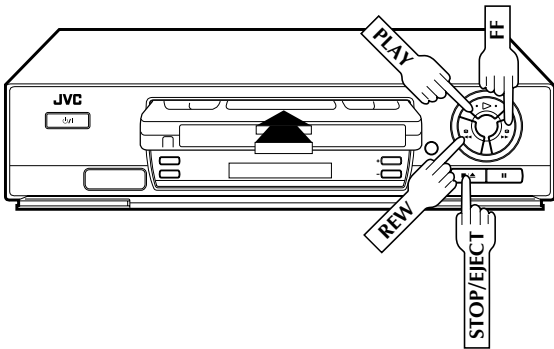

The easiest, most basic operation possible with your video recorder is tape playback. Already-recorded signals on a video tape are read by your video recorder and displayed on your TV just like a TV programme.

1

LOAD A CASSETTE

Make sure the window side is up, the rear label side is facing you and the arrow on the front of the cassette is point toward the recorder. Don't apply too much pressure when inserting.

- The recorder power comes on automatically and the counter is reset to 0:00:00.
- If the record safety tab has been removed, playback begins automatically.

2

FIND PROGRAMME START POINT

If the tape is advanced past the start point, press **REW**. To go forward, press **FF**.

3

START PLAYBACK

Press **PLAY**. "BEST" appears blinking in the recorder's display panel during automatic tracking. (☞ pg. 14)

4

STOP PLAYBACK

Press **STOP** on the remote or **STOP/EJECT** on the recorder's front panel. Then press **STOP/EJECT** to remove the cassette.

Usable cassettes

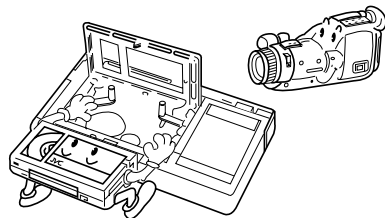

- Compact VHS camcorder recordings can be played on this video recorder. Simply place the recorded cassette into a VHS Cassette Adapter and it can be used just like any full-sized VHS cassette.
- This video recorder can record on regular VHS and Super VHS cassettes. However, it will record and play back regular VHS signals only. It is not possible to play back a recorded Super VHS tape.

Playback Features

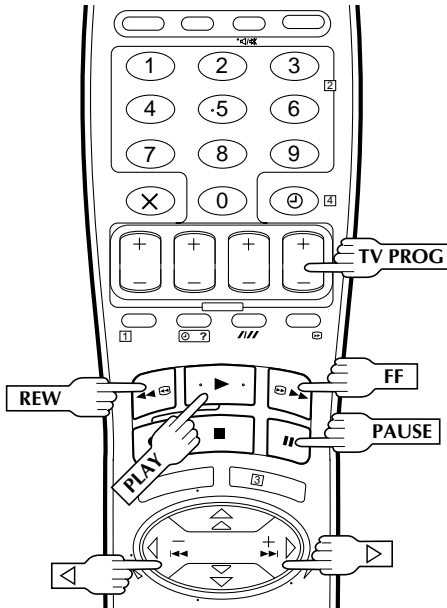
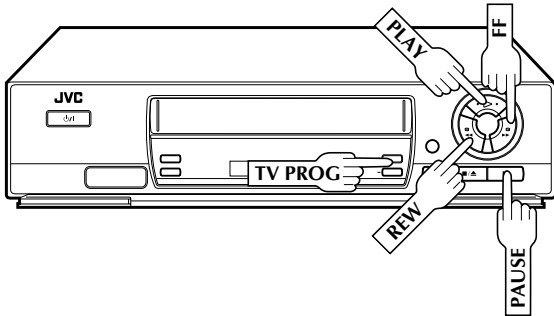

Still Picture/Frame-By-Frame Playback

1 PAUSE DURING PLAYBACK

Press **PAUSE**. If there is vertical jitter, use the **TV PROG** buttons to correct the picture.

2 ACTIVATE FRAME-BY-FRAME PLAYBACK

Press **PAUSE**.

OR

Press ◀ or ▶.

To resume normal playback, press **PLAY**.

Slow Motion

1 ACTIVATE SLOW-MOTION PLAYBACK

During still picture, press and hold **PAUSE** for 2 seconds, then release. Press and release again to return to still picture.

OR

During still picture, press and hold ◀ or ▶. Release to return to still picture.

To resume normal playback, press **PLAY**.

Variable-Speed Search

1 ACTIVATE VARIABLE-SPEED SEARCH

During playback, press ◀ or ▶.

- The more times you press, the faster the playback picture moves.
- To decrease speed, press the button for the opposite direction.

To resume normal playback, press **PLAY**.

ATTENTION

In the search, still, slow-motion or frame-by-frame playback mode,

- the picture will be distorted.
- the noise bars will appear.

High-Speed Search

1 ACTIVATE HIGH-SPEED SEARCH

During playback or still picture, press **FF** for forward high-speed search, or **REW** for reverse high-speed search.

To resume normal playback, press **PLAY**.

NOTE:

For short searches, press and hold **FF** or **REW** for over 2 seconds during playback or still picture. When released, normal playback resumes.

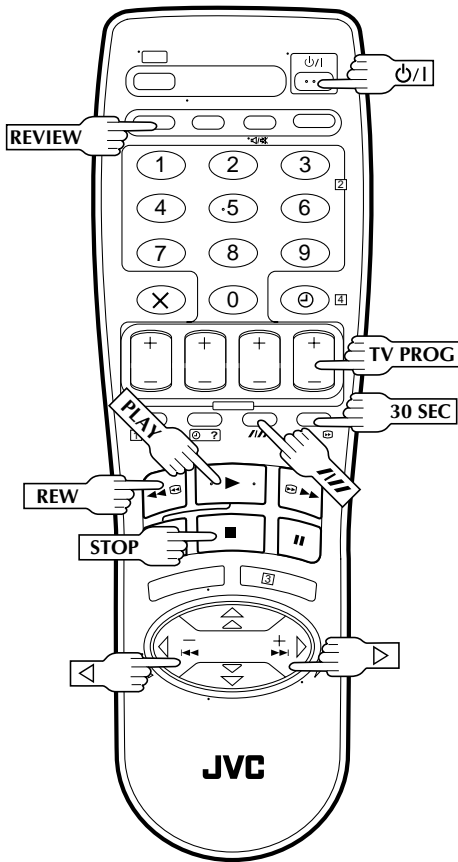
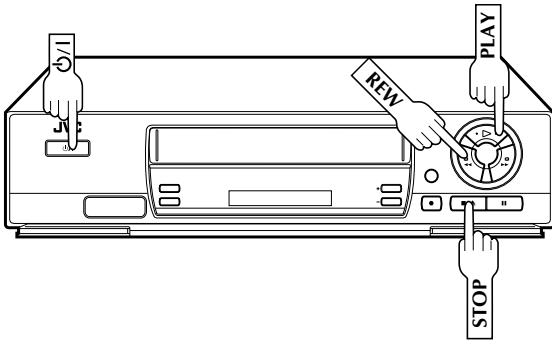

Manual Tracking

Your video recorder is equipped with automatic tracking control. During playback, you can override this and adjust the tracking manually by pressing the **TV PROG** buttons.

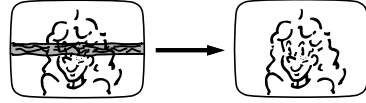

1 OVERRIDE AUTOMATIC TRACKING

Press **///** on the remote to engage manual tracking.

2 ADJUST TRACKING MANUALLY

Press **TV PROG +** or **-** to adjust tracking.

3 RETURN TO AUTOMATIC TRACKING

Press **///** on the remote to re-engage automatic tracking.

NOTE:

When a new tape is inserted, the recorder enters the automatic tracking mode automatically.

Instant ReView

Simply by pressing a single button, the recorder power comes on, rewinds, and begins playback of the last timer-recorded programme. If you have several programmes recorded, you can easily access any of them.

NOTE:

Before starting, make sure that the recorder is off and that the Timer mode is disengaged.

1 ACTIVATE INSTANT REVIEW

Press **REVIEW**. The recorder power comes on and the recorder searches for the index code indicating the start of the last timer-recorded programme. Once it's found, playback begins automatically.

- The front display panel tells you how many programmes have been timer-recorded. If you have, for example, 3 programmes, "REVIEW" and "3" appear and blink. To watch the first of the 3 programmes, press **REVIEW** three times. The recorder searches and begins playback automatically. You can access a programme as far as 9 index codes away from the current tape position.

NOTE:

Instant ReView is not possible while the recorder is in the Timer mode.

Index Search

Your recorder automatically marks index codes at the beginning of each recording. This function gives you quick access to any one of 9 index codes in either direction.

NOTE:

Before starting, make sure the recorder is in the Stop mode.



Repeat Playback

Your video recorder can automatically play back the whole tape 50 times repeatedly.



1 START PLAYBACK

Press **PLAY**.

2 ACTIVATE REPEAT PLAYBACK

Press **PLAY** and hold for over 5 seconds, then release.

- The Play indicator (▶) on the display panel blinks slowly.
- The tape plays 50 times automatically, and then stops.

3 STOP PLAYBACK

Press **STOP** at any time to stop playback.

NOTE:

Pressing **PLAY**, **REW**, **FF** or **PAUSE** also stops Repeat Playback.

1

ACTIVATE INDEX SEARCH

Press ◀ or ▶ (◀◀◀ or ▶▶▶). "◀◀◀ 1" or "▶▶▶ 1" is displayed on screen and search begins in the corresponding direction.

- To access index codes 2 through 9, press ◀ or ▶ repeatedly until the correct index number is displayed.
Ex.: To locate the beginning of B from the current position, press ◀ twice.
To locate the beginning of D from the current position, press ▶ once.

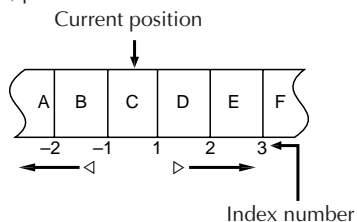

- When the specified index code is located, playback begins automatically.

Skip Search

1

SKIP OVER UNWANTED SECTIONS

Press **30 SEC 1** to 4 times during playback. Each press initiates a 30-second period of fast-motion playback. Normal playback resumes automatically.

NOTE:

To return to normal playback during a Skip Search, press **PLAY**.

Next Function Memory

You can set your recorder's power to go off automatically after the tape is fully rewound. Before starting, make sure the recorder is in the Stop mode.

For Automatic Power Off After Tape Rewind . . .
. . . press **REW**, then press **⏻/I** within 2 seconds.

Basic Recording

Turn on the TV and select the VIDEO channel (or AV mode).

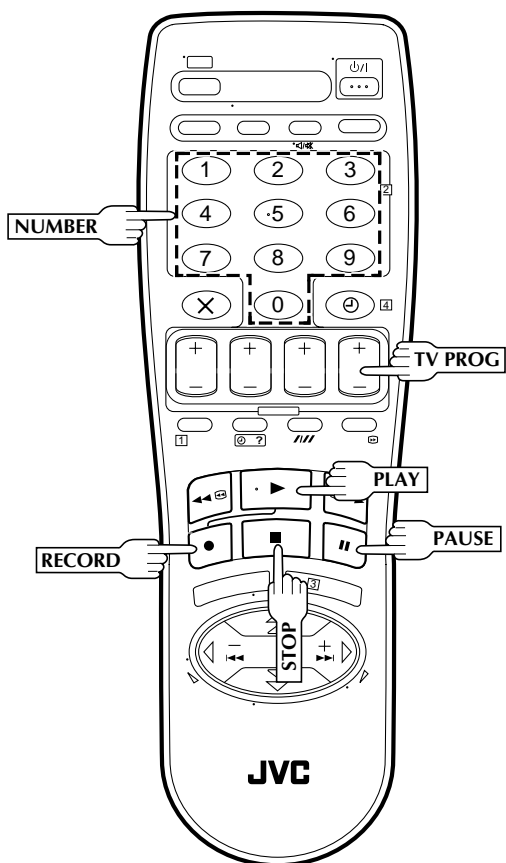
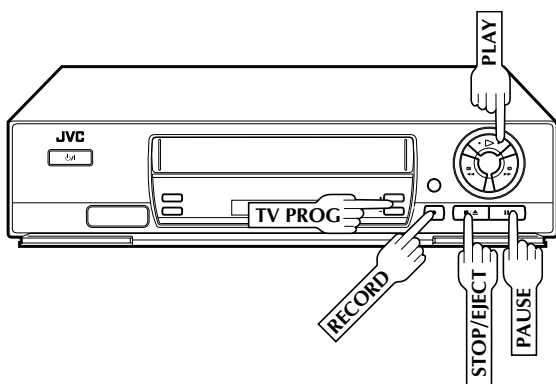

TV signals being received by the recorder's built-in tuner can be recorded onto a video tape. You can "capture" a TV programme using your video recorder.

LOAD A CASSETTE

Insert a cassette with the record safety tab intact.

- The counter is reset to 0:00:00 and the recorder power comes on automatically.

CHOOSE A PROGRAMME

Press **TV PROG +/-** or the **NUMBER** keys to select the channel you wish to record.

START RECORDING

Press and hold **RECORD** and press **PLAY** on the remote control, or press **RECORD** on the recorder.

B.E.S.T. takes place at the beginning of the first recording after inserting the cassette (see pg. 14).

PAUSE/RESUME RECORDING

Press **PAUSE**. Press **PLAY** to resume recording.

STOP RECORDING

Press **STOP** on the remote control or **STOP/EJECT** on the recorder. Then press **STOP/EJECT** to remove the cassette.

Recording Resume Function

If there is a power outage during recording (or Instant Timer Recording or timer recording), the recording will resume automatically when power is restored to the recorder unless the recorder's memory backup has expired.

Accidental erasure prevention

- To prevent accidental recording on a recorded cassette, remove its safety tab. To record on it later, cover the hole with adhesive tape.

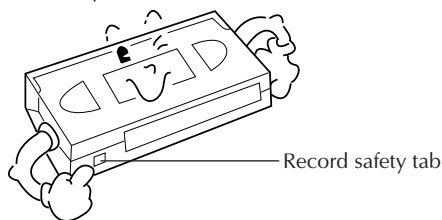

Recording Features

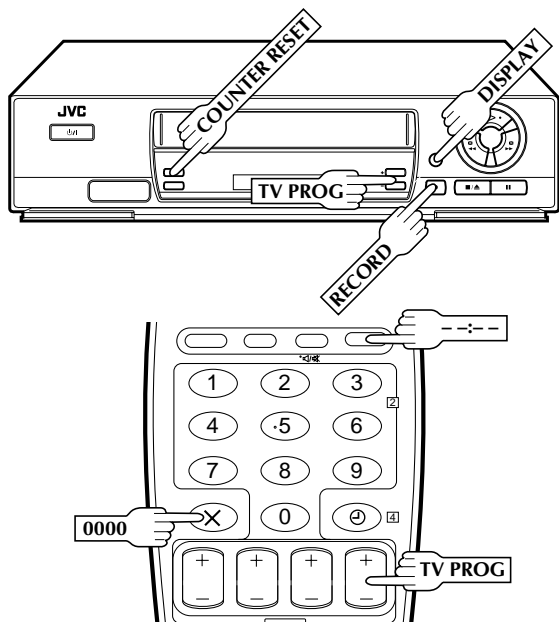

Instant Timer Recording (ITR)

This easy method lets you record for from 30 minutes to 6 hours (selectable in 30-min. increments), and shuts the recorder off after recording is finished.

- 1** **START RECORDING**
Press **RECORD** on the recorder.
- 2** **ENGAGE ITR MODE**
Press **RECORD** again. "0" blinks and 0:30 appears on the front display panel.
- 3** **SET RECORDING DURATION**
If you want to record for more than 30 minutes, press **RECORD** to extend the time. Each press extends recording time by 30 minutes.

NOTES:

- You can only perform ITR using the **RECORD** button on the recorder's front panel.
- After you set the ITR time, the counter display appears.
- To check the remaining time, press **RECORD** once during recording and the remaining time will be displayed for about 5 seconds. Be careful not to press **RECORD** again within these 5 seconds, or you will round the recording time up to the next 30 minute increment.

Record One Programme While Watching Another

- 1** **SELECT CHANNEL TO WATCH**
Once recording is in progress, all you need to do is to set the channel controls on the TV for the station you wish to view.
 - The programme selected with the TV's channel controls appears on the TV screen while the one selected with the recorder's **TV PROG** buttons is recorded on the tape.

Elapsed Recording Time Indication

You can check the exact time of a recording.

- 1** **SET COUNTER DISPLAY**
Press **DISPLAY** (or --:-- →) until a counter reading appears on the display panel.
- 2** **RESET COUNTER**
Press **COUNTER RESET** or **0000** before starting recording or playback.
 - The counter is reset to "0:00:00" and shows the exact elapsed time as the tape runs.

Tape Remaining Time

- 1** **DISPLAY REMAINING TIME**
Press **DISPLAY** (or --:-- →) until the time remaining on the tape appears.
 - The display panel shows the tape remaining time with "▶" displayed.
 - By pressing the **DISPLAY** (or --:-- →) button, you can change the display to show the counter reading, channel position*, clock time or tape remaining time.
 - * channel position is not displayed during playback.

NOTE:

Depending on the type of tape used, there may be times when the tape remaining time reading may not appear right away, or is not correct. "--:--" may sometimes appear, or the display may blink on occasion.

B.E.S.T. Picture System

Turn on the TV and select the VIDEO channel (or AV mode).

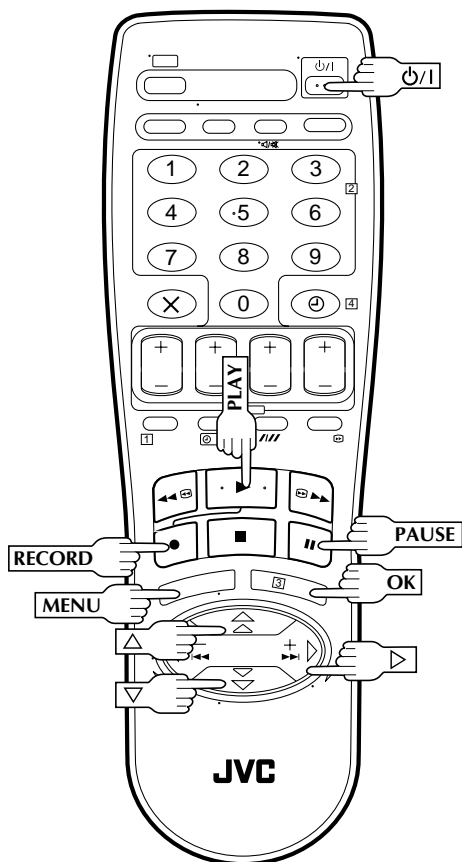
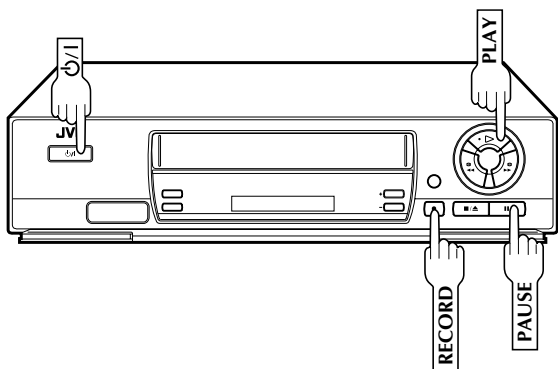

The B.E.S.T. (Biconditional Equalised Signal Tracking) system checks the condition of the tape in use during recording and playback, and compensates to provide the highest-possible recording and playback pictures. The default setting for both recording and playback is "ON".

Preparation

1 TURN ON THE RECORDER

Press P/I .

2 ACCESS MAIN MENU SCREEN

Press MENU.

3 ACCESS MODE SET SCREEN

Press Δ/∇ to place the pointer next to "MODE SET", then press OK or \triangleright .

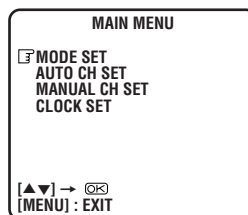

4 SELECT B.E.S.T. MODE

Press Δ/∇ to place the pointer next to "B.E.S.T.", then press OK or \triangleright to set to "ON" or "OFF".

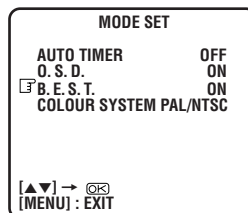

5 RETURN TO NORMAL SCREEN

Press MENU.

Recording

START RECORDING

1 Press and hold **RECORD** and press **PLAY** on the remote, or press **RECORD** on the recorder.

DURING B.E.S.T.



B.E.S.T. COMPLETE

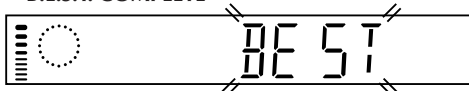

- The recorder spends approximately 7 seconds assessing the condition of the tape, then begins recording.

NOTES:

- The B.E.S.T. system works only after a tape has been inserted and the Record mode is first initiated. It does not work during recording.
- In the case of timer recording, the B.E.S.T. system works before recording is initiated.
- Once the cassette is ejected, the B.E.S.T. data is cancelled. The next time the cassette is used for recording, B.E.S.T. is re-performed.
- Pressing the recorder's **RECORD** button while "BEST" is displayed does not start Instant Timer Recording (⏏ pg. 13).

ATTENTION

*Since the B.E.S.T. system works before recording actually starts, there is a delay of approximately 7 seconds after **RECORD** and **PLAY** on the remote are pressed, or **RECORD** on the recorder is pressed. To make sure you record the desired scene or programme in its entirety, first perform the following steps:*

- 1) Press and hold **PAUSE** and press **RECORD** to engage the **RECORD PAUSE** mode.
 - The recorder then automatically checks the condition of the tape and, after approximately 7 seconds, re-enters **RECORD PAUSE**.
- 2) Press **PLAY** to start recording.
 - If you want to bypass the B.E.S.T. system and begin recording immediately, set "B.E.S.T." to "OFF" in step 4 on page 14.

Playback

The recorder assesses the quality of the tape once you initiate playback.

START PLAYBACK

1 Press **PLAY**.

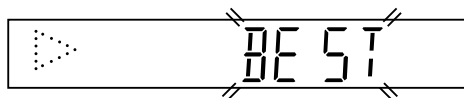

- The recorder adjusts the playback picture quality based on the quality of the tape in use.
- B.E.S.T. is active during Auto Tracking. "BEST" appears blinking on the recorder's display panel.

NOTES:

- When watching a tape recorded with "B.E.S.T." set to "ON", it is recommended that you leave B.E.S.T. on during playback as well.
- When watching a rental tape or one recorded on another video recorder, or when using this recorder as the player for editing, set B.E.S.T. to your preference by performing steps 1 through 5 on page 14.
- "BEST" only appears at the beginning of automatic tracking. Even though it doesn't appear after that, the B.E.S.T. function is operative.

Express Timer Programming

Before performing Express Timer Programming:

- Make sure that the recorder's built-in clock is set properly.
- Insert a cassette with the safety tab in place. The recorder will come on automatically.
- Turn on the TV and select the VIDEO channel (or AV mode).

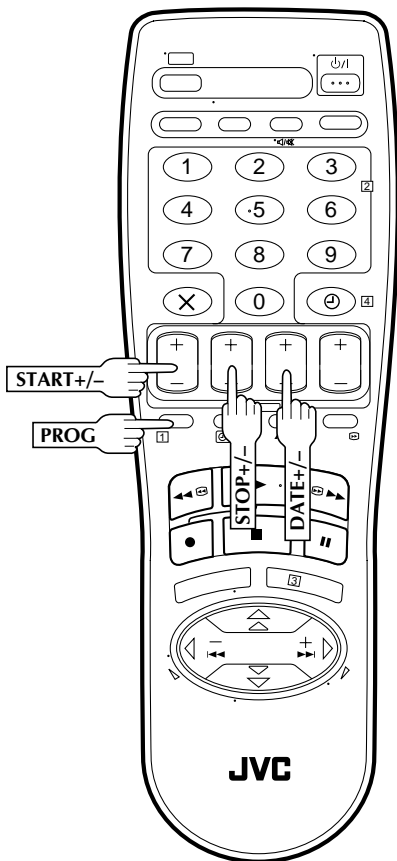

1

ACCESS PROGRAMME SCREEN

Press **PROG**. (If you're just starting out, "P1" appears.)

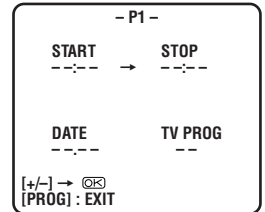

The front display panel looks like this:

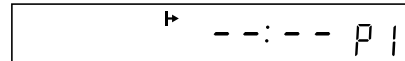

2

ENTER PROGRAMME START TIME

Press **START +/-** to enter the time you want recording to start.

- Press and hold **START +/-** to move in 30-minute increments, or press and release repeatedly to move 1 minute at a time.

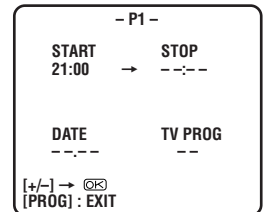

The front display panel looks like this:

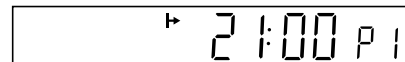

3

ENTER PROGRAMME STOP TIME

Press **STOP +/-** to enter the time you want recording to stop.

- Press and hold **STOP +/-** to move in 30-minute increments, or press and release repeatedly to move 1 minute at a time.

4

ENTER PROGRAMME DATE

Press **DATE +/-**. (The current date appears on screen. The date you enter appears in its place.)

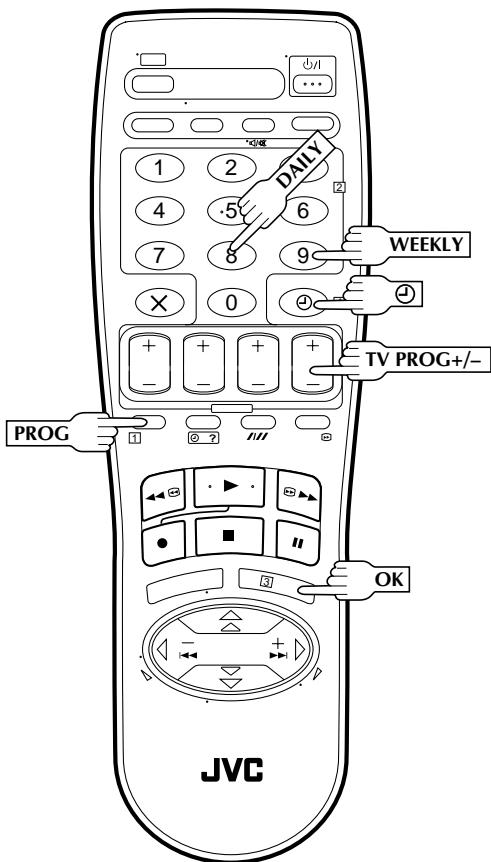
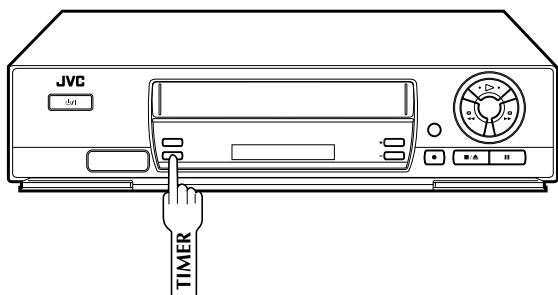

5

ENTER CHANNEL POSITION

Press TV PROG +/-.

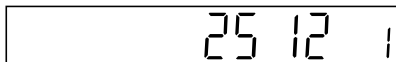
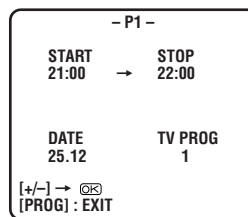

6

RETURN TO NORMAL SCREEN

After confirming all information is correct, press **PROG** or **OK**. "PROGRAM COMPLETED" appears on the screen for about 5 seconds, then normal screen appears.

- Repeat steps 1 – 6 for each additional programme.

7

ENGAGE RECORDER'S TIMER MODE

Press **⊖** or **TIMER**. The recorder turns off automatically and **⊖** appears on the display panel.

- To disengage the timer, press **⊖** or **TIMER** again.

To Timer-Record Weekly Or Daily Serials . . .
 . . . anytime during steps 1 through 6, press **WEEKLY** (NUMBER key "9") for weekly serials or **DAILY** (NUMBER key "8") for daily serials (Monday – Friday). Either "WEEKLY" or "DAILY" appears on the screen. Pressing the button again makes the corresponding indication disappear.

NOTE:

You can programme this recorder to timer-record as many as 8 programmes. If you try to programme the recorder to record a ninth, "PROGRAM FULL" appears on screen and "FULL" appears on the front display panel. To record the extra programme, you must first cancel any unnecessary programmes (pg. 18).

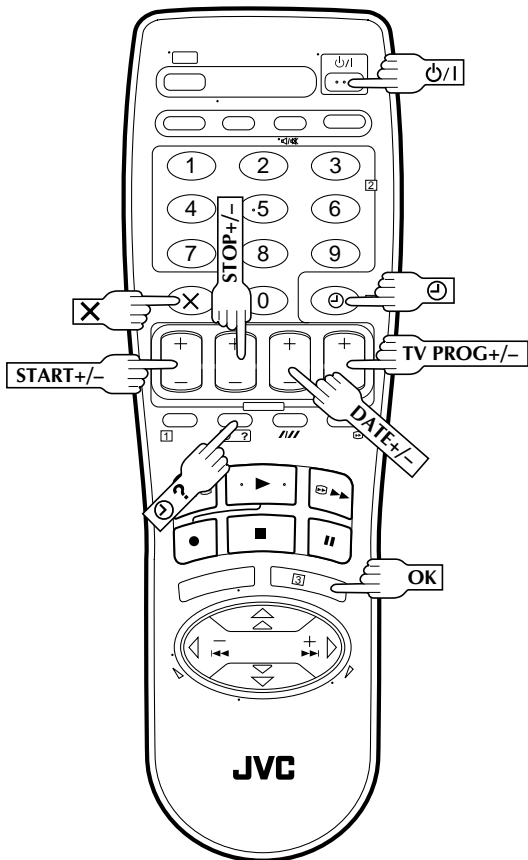
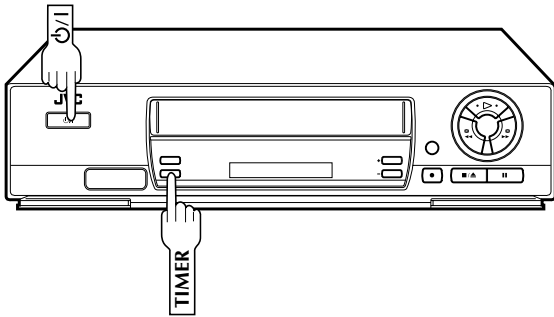

Check, Cancel And Replace Programmes

1 DISENGAGE TIMER MODE

Press \odot or **TIMER**, then press $\odot/|$.

2 ACCESS PROGRAM CHECK SCREEN/DISPLAY

Press $\odot ?$.

PR	START	STOP	CH	DATE
1	8:00	10:00	3	24.12
2	10:00	10:45	2	25.12
3	11:30	13:00	1	25.12
4				
5				
6				
7				
8				

[$\odot ?$] : NEXT

PIPB

3 ACCESS PROGRAM SCREEN/DISPLAY

Press $\odot ?$ again to check more information. Each time you press $\odot ?$, the next programme's information appears.

- P1 -	
START 8:00	STOP 10:00
DATE 24.12	TV PROG 3

[$\odot ?$] : NEXT

8:00 P1

- The display panel shows the programme start time. Pressing **OK** changes the display to the programme stop time, then the date and the channel position.

To cancel or replace a programme...

4 CANCEL OR REPLACE A PROGRAMME

Press **X** to cancel a programme. To replace a programme, press the appropriate button: **START+/-**, **STOP+/-**, **DATE+/-**, **TV PROG+/-**.

5 RETURN TO NORMAL SCREEN/DISPLAY

Press $\odot ?$ as many times as necessary. If there are still some programmes remaining, go on to step 6.

6 RETURN TO TIMER MODE

Press \odot or **TIMER**.

NOTE:

You can also check the programmes on the display panel even if the recorder's power is off or the recorder is in the Timer mode; however, it is not possible to cancel or replace the programmes.

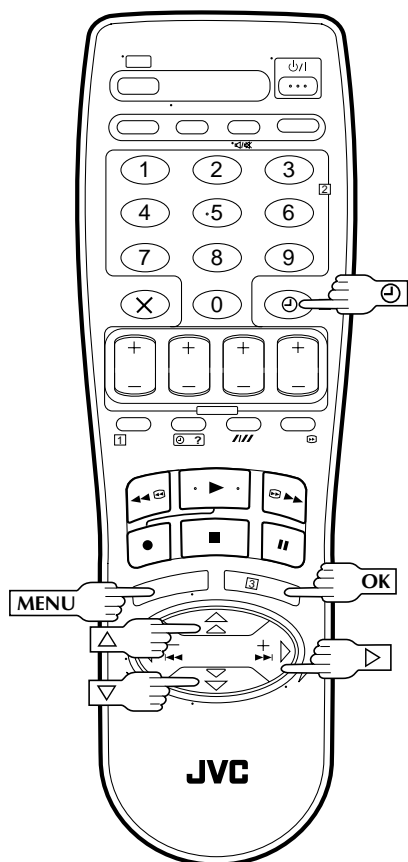
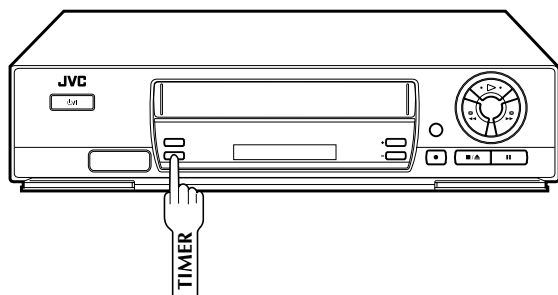

Auto Timer

When the Auto Timer is set to ON the timer is automatically engaged when the recorder power is turned off and automatically disengaged when the recorder is powered back on.

1 ACCESS MAIN MENU SCREEN

Press **MENU**.

2 ACCESS MODE SET SCREEN

Press Δ / ∇ to place the pointer next to "MODE SET", then press **OK** or \triangleright .

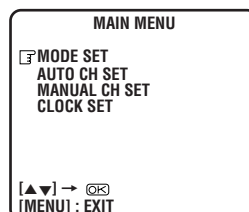

3 SELECT MODE

Press **OK** or \triangleright to select either "ON" or "OFF".

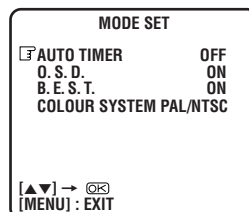

4 RETURN TO NORMAL SCREEN

Press **MENU**.

NOTE:

For safety, when Auto timer is set to "OFF", all other recorder functions are disabled while the Timer mode is engaged. To disengage the timer, press \ominus or **TIMER**.

Edit To Or From Another Video Recorder

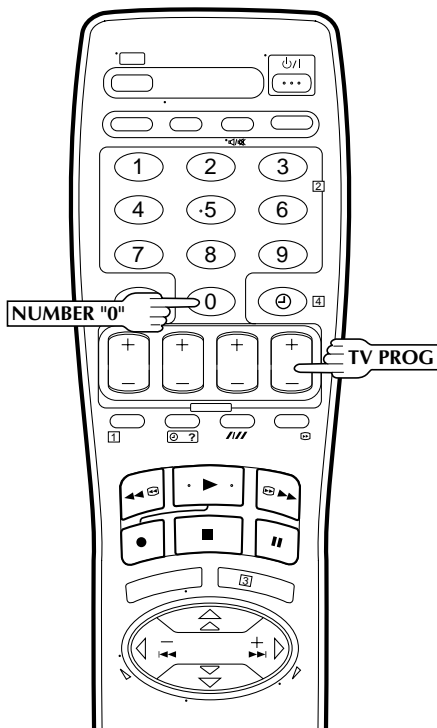

You can use your video recorder as the source player or the recording deck.

1 MAKE CONNECTIONS

Connect the player's 21-pin SCART (AV) connector to the recorder's 21-pin SCART (AV) connector as illustrated below.

2 SET RECORDING DECK'S INPUT MODE

Set to AUX. With this video recorder, press **NUMBER** key "0" and/or **TV PROG** so that "L-1" appears on the display panel.

3 START SOURCE PLAYER

Engage its Play mode.

4 START RECORDING DECK

Engage its Record mode.

NOTES:

- All necessary cables can be obtained from your dealer.
- When you use this recorder as the player for editing, be sure to set "O.S.D." to "OFF" before starting (☞ pg. 6).

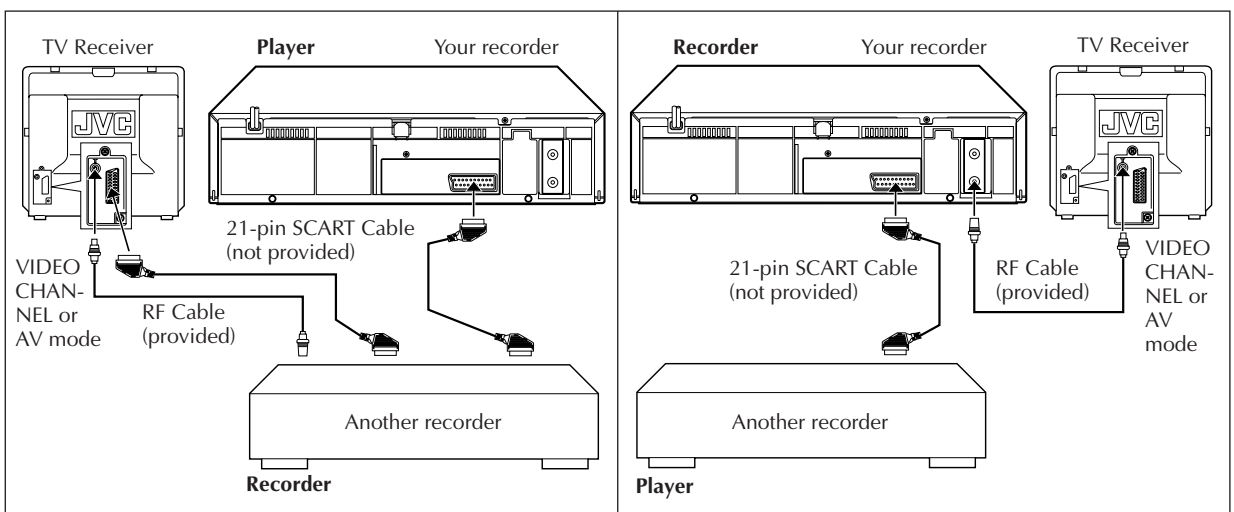

Edit From A Camcorder

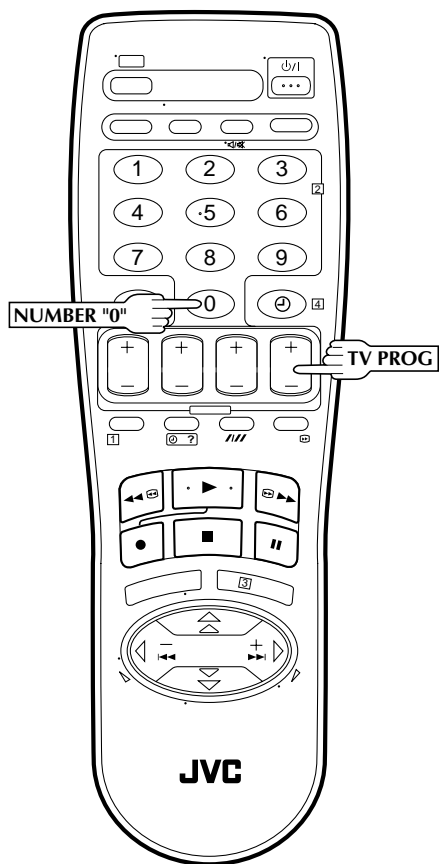

You can use a camcorder as the source player and your video recorder as the recorder.

1 MAKE CONNECTIONS

Connect the camcorder's AUDIO/VIDEO OUT connectors to the recorder's AV1 IN/OUT connector via the cable adapter.

2 SET RECORDER'S INPUT MODE

Press **NUMBER** key "0" and/or **TV PROG** so that "L-1" appears on the display panel.

3 START CAMCORDER

Engage its Play mode.

4 START RECORDER

Engage its Record mode.

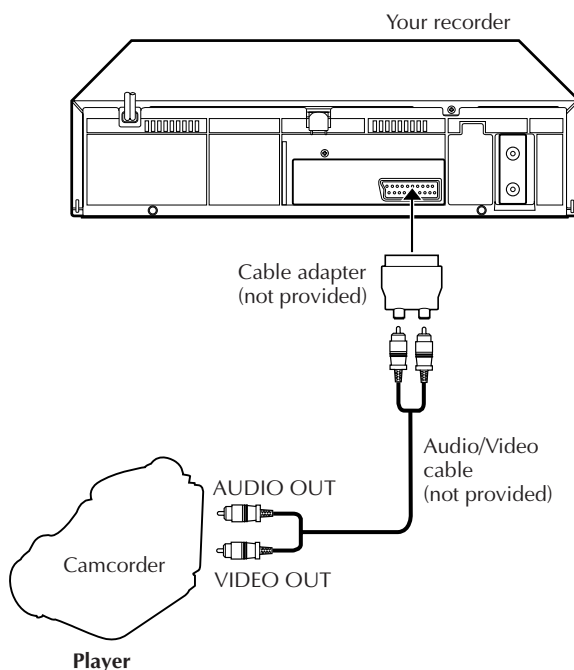

Tuner Set

Turn on the TV and select the VIDEO channel (or AV mode).

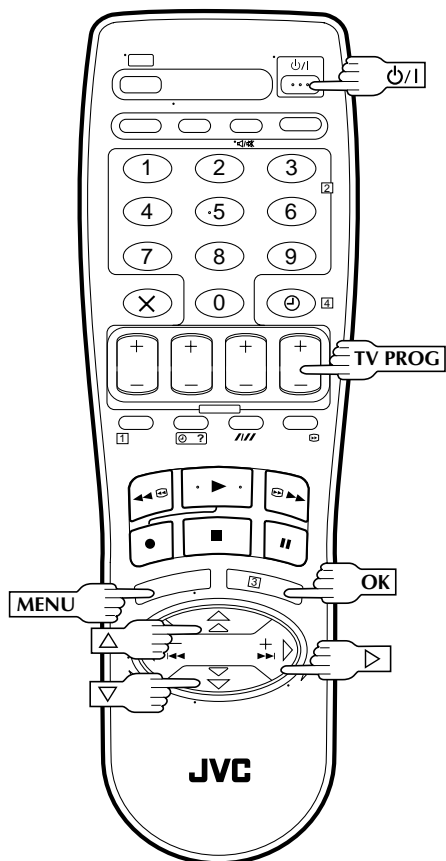

IMPORTANT

Perform the following steps only if —

- Auto Channel Set has not been set correctly by Auto Set Up function (see pg. 5).
- you have moved to a different area or if a new station starts broadcasting in your area.

Your recorder needs to memorise all necessary stations in channel positions in order to record TV programmes. Auto Channel Set automatically assigns all receivable stations in your area to call them up by using the **TV PROG** buttons without going through any vacant channel.

Auto Channel Set

TURN ON THE RECORDER

Press ϕ/I .

ACCESS MAIN MENU SCREEN

Press MENU.

PERFORM AUTO CHANNEL SET

Press Δ/∇ to place the pointer next to "AUTO CH SET", then press OK or \triangleright .

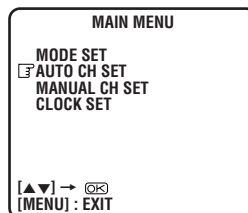

- The Auto Set screen appears, and remains on screen while the recorder searches for receivable stations. As Auto Channel Set progresses, the "■" mark on the screen moves from left to right. Wait until the screen as shown in step 4 appears.

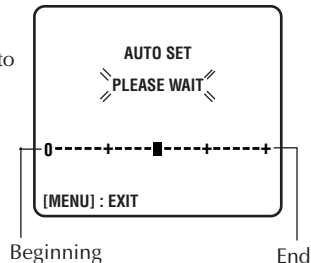

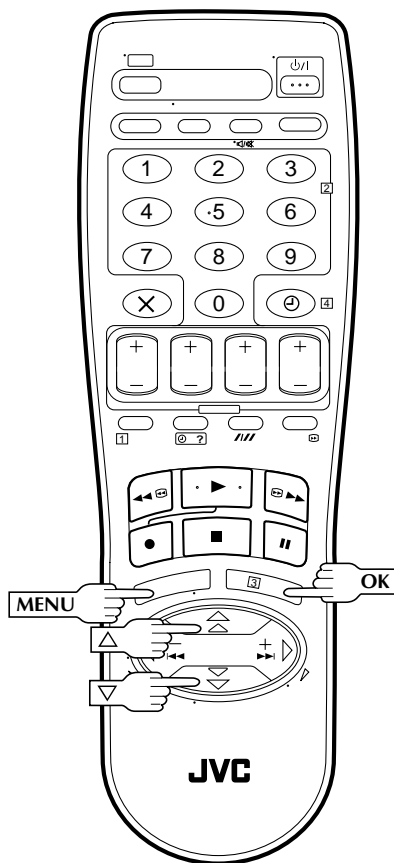

4

VIEW CONFIRMATION SCREEN

After "SCAN COMPLETED" is displayed on the screen for about 5 seconds, the Confirmation screen looking like the one to the right appears. The stations your recorder located appear on a Confirmation screen — channel positions (PR) and channels (CH).

PR	CH	ID	PR	CH	ID
01	25	---	07	C33	---
02	C08	---	08	C26	---
03	10	---	09	55	---
04	C65	---	10	C24	---
05	C31	---	11	C23	---
06	C32	---	12	C25	---

[▲▼] : EDIT
 → [OK] : EDIT
 → [X] : DELETE
 [MENU] : EXIT

C: Cable

The blueback screen and the program currently being broadcast by the blinking station appear alternately for 8 seconds each.

To view the next page, use the ▲▼ button on the remote control.

5

RETURN TO NORMAL SCREEN

Press **MENU**.

- Using the Confirmation screen, you can skip or add channel positions, enter station names and perform other operations. Refer to pages 24 – 26 for the procedures.

IMPORTANT

Your video recorder memorizes all detected stations even if reception of some of them is poor. In these cases picture quality may be poor. To delete those stations with an unacceptable picture "Delete A Channel" on page 25.

NOTES:

- Fine tuning is performed automatically during Auto Channel Set. If you want to perform it manually, refer to page 25.*
- If you perform Auto Channel Set when the aerial cable is not connected properly, "SCAN COMPLETED -NO SIGNAL-" appears on the screen in step 4. When this happens, make sure of the aerial connection and press **OK**; Auto Channel Set will take place again.*

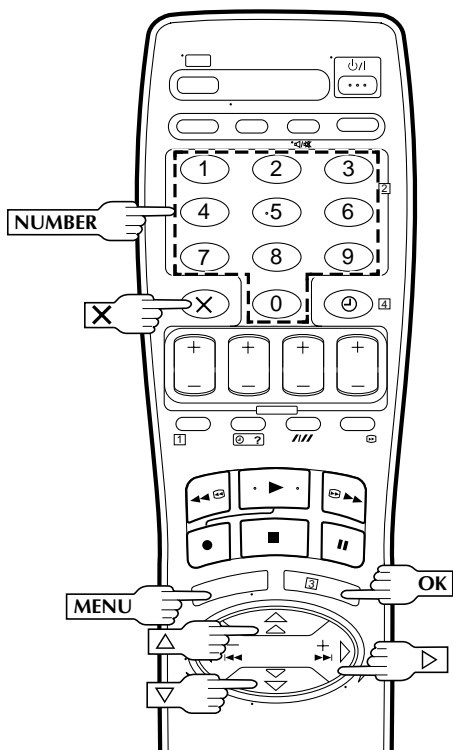

Storing Channels Manually

Store channels that were not stored during Auto Set Up (☞ pg. 5) or Auto Channel Set (☞ pg. 22).

- 1** **ACCESS MAIN MENU**
Press **MENU**.
- 2** **ACCESS CONFIRMATION SCREEN**
Press $\Delta\nabla$ to place the pointer next to "MANUAL CH SET", then press **OK** or \triangleright . The Confirmation screen appears.
- 3** **SELECT POSITION**
Press $\Delta\nabla$ until an open position in which you want to store a channel begins blinking, then press **OK**. The Manual Channel Set screen appears.

(Ex.) To store in position 12.

PR	CH	ID	PR	CH	ID
01	25	----	07	C33	----
02	CDB	----	08	C26	----
03	10	----	09	55	----
04	C65	----	10	C24	----
05	C31	----	11	C23	----
06	C32	----	12	----	----

[$\Delta\nabla$]:
 \rightarrow [OK]: EDIT
 \rightarrow [X]: DELETE
[MENU]: EXIT

The blueback screen and the programme currently being broadcast by the selected channel appear alternately for 8 seconds each.

- 4** **SELECT BAND**
Press $\Delta\nabla$ to change the band between CH (regular) and CC (cable), then press \triangleright .

```
PR  CH  ID  FINE
12  CH01 ---- +/-
```

[$\Delta\nabla$]: SELECT
[\leftarrow \rightarrow]: CURSOR \leftrightarrow
[OK]: OK
[MENU]: EXIT

The blueback screen and the programme currently being broadcast by the selected channel appear alternately for 8 seconds each.

- 5** **INPUT CHANNEL**
Press the **NUMBER** keys to input the channel number you want to store.
 - Input "0" before any single number entries.
 - To input the registered station name (ID – ☞ pg. 27), press \triangleright until "----" (ID setting) begins blinking, then press $\Delta\nabla$.
 - For fine tuning adjustment, press \triangleright until "+/-" begins blinking, then press $\Delta\nabla$. While tuning, "+" or "-" appears.

- 6** **ENTER NEW CHANNEL INFORMATION**
Press **OK** and the Confirmation screen appears.
 - Repeat steps 3 through 6 as necessary.

- 7** **CLOSE CONFIRMATION SCREEN**
Press **MENU**.
 - To change positions, see "Change Station Channel Position" (☞ pg. 25).
 - If you wish to set station names other than the ones registered in your recorder, ☞ "Set Stations (B)" on page 26.

Delete A Channel

Perform steps 1 and 2 of "Storing Channels Manually" on page 24 to access the Confirmation screen before continuing.

1 **SELECT ITEM**
Press $\Delta\nabla$ until the item you want to delete begins blinking.

2 **DELETE CHANNEL**

Press X.

- The item directly beneath the cancelled one moves up one line.
- Repeat steps 1 and 2 as necessary.

3 **CLOSE CONFIRMATION SCREEN**

Press MENU.

Change Station Channel Position

Perform steps 1 and 2 of "Storing Channels Manually" on page 24 to access the Confirmation screen before continuing.

1 **SELECT ITEM**
Press $\Delta\nabla$ until the item you want to move begins blinking. Then press **OK** and the station name (ID) and its channel (CH) number begin blinking.

2 **SELECT NEW POSITION**

Press $\Delta\nabla$ to move the station to the new channel position, then press **OK**.

Example: If you moved the station in position 4 to position 2, the stations originally in positions 2 and 3 each move down one space.

PR	CH	ID	PR	CH	ID	PR	CH	ID	PR	CH	ID
01	25	---	07	C33	---	01	25	---	07	C33	---
02	C08	---	08	C26	---	02	C65	---	08	C26	---
03	10	---	09	55	---	03	C08	---	09	55	---
04	C65	---	10	C24	---	04	10	---	10	C24	---
05	C31	---	11	C23	---	05	C31	---	11	C23	---
06	C32	---	12	C25	---	06	C32	---	12	C25	---

[▲▼]: MOVE
 [X]: MANUAL CH SET
 [MENU]: EXIT

[▲▼]: MOVE → [X]
 [MENU]: EXIT

- Repeat steps 1 and 2 as necessary.

3 **CLOSE CONFIRMATION SCREEN**

Press MENU.

Fine-Tuning Channels Already Stored

Perform steps 1 and 2 of "Storing Channels Manually" on page 24 to access the Confirmation screen before continuing.

1 **SELECT CHANNEL TO FINE-TUNE**

Press $\Delta\nabla$ until the channel you want to tune begins blinking.

2 **ACCESS MANUAL CHANNEL SET SCREEN**

Press **OK** twice. The Manual Channel Set screen appears.

3 **PERFORM TUNING**

Press \triangleright until "+/-" begins blinking, then press $\Delta\nabla$ until the picture is its clearest. Then press **OK**.

- The Confirmation screen appears.
- Repeat steps 1 through 3 as necessary.

4 **CLOSE CONFIRMATION SCREEN**

Press MENU.

Set Stations (A)

Set station names that are registered in your recorder.

Perform steps 1 and 2 of "Storing Channels Manually" on page 24 to access the Confirmation screen before continuing.

1

SELECT ITEM

Press $\Delta\nabla$ until the item you want begins blinking.

2

ACCESS MANUAL CHANNEL SET SCREEN

Press **OK** twice.

3

SELECT NEW STATION

Press \triangleright until the station name (ID) begins blinking, then press $\Delta\nabla$ until the new station's name (ID) you want to store begins blinking.

Registered station names (pg. 27) appear as you press $\Delta\nabla$.

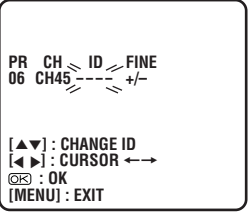

PR CH ID FINE
06 CH45 ---+/-

[$\Delta\nabla$] : CHANGE ID
[$\leftarrow\rightarrow$] : CURSOR \leftrightarrow
[**OK**] : OK
[MENU] : EXIT

4

SWITCH STATIONS

Press **OK**.

- The Confirmation screen appears.
- Repeat steps 1 through 4 as necessary.

5

CLOSE CONFIRMATION SCREEN

Press **MENU**.

Set Stations (B)

Set station names other than the ones registered in your recorder.

Perform steps 1 and 2 of "Storing Channels Manually" on page 24 to access the Confirmation screen and then perform step 1 and 2 of "Set Stations (A)" on the left before continuing.

1

SELECT STATION NAME CHARACTER

Press \triangleright until the first letter of the station name begins blinking.



PR CH ID FINE
06 CH45 ARD +/-

[$\Delta\nabla$] : A-Z, 0-9
[$\leftarrow\rightarrow$] : CURSOR \leftrightarrow
[**OK**] : OK
[MENU] : EXIT

2

ENTER NEW CHARACTER

Press $\Delta\nabla$ to cycle through the characters (A-Z, 0-9, -, *, +, _ (space)) and stop when the desired character is indicated, then press \triangleright to enter. Enter the remaining characters the same way (maximum of 4).

After entering all characters, press **OK**.

- The Confirmation screen appears.
- If you make a mistake, press \triangleleft until the incorrect character begins blinking. Then enter the correct character by pressing $\Delta\nabla$.

3

CLOSE CONFIRMATION SCREEN

Press **MENU**.

TV Station And ID List

ID*	STATION NAME
1000	TV1000
3SAT	3SAT
ADLT	ADULT
ANT3	ANTENA3
ARD	ARD
ARTE	ARTE
BBC	BBC GROUP
BBC1	BBC1
BBC2	BBC2
BR3	BAYERN3
C+	CANAL PLUS
C1	PORTUGUSES
CAN5	CANALE5
CH4	CHANNEL4
CH5	CHANNEL5
CHLD	CHILD
CINE	CINEMA
CLUB	TELECLUB
CMT	CMT
CNN	CNN
CSUR	ANDALUCIA
DISC	DISCOVERY
DR	DR TV
DRS	DRS
DSF	DSF
ETB1	ETB1
ETB2	ETB2
EURO	EURONEWS
EUSP	EUROSPORTS
FEMM	FEMMAN
FILM	FILM
FNET	FILMNET
FR2	France2
FR3	France3
GALA	GALAVISION
HR3	HESSEN3
INFO	INFO-KANAL
ITA1	ITALIA1
ITA7	ITALIA7
ITV	ITV
JSTV	JSTV
KA2	KA2
KAB1	KABEL1
KAN2	KANAL2
LOCA	LOCAL
M6	M6
MBC	MBR
MCM	MCM
MDR	MDR
MOVE	MOVIE
MTV	MTV
MTV3	MTV3
N3	NORD3
N-TV	N-TV
NBC	NBC SUPER
NDR3	NDR3
NED1	NED1
NED2	NED2
NED3	NED3
NEWS	
NICK	NICKELODEON
NRK	NRK
NRK2	NRK2
ODE	ODEON
ORF1	ORF1

ID*	STATION NAME
ORF2	ORF2
ORF3	ORF3
OWL3	OWL3
PREM	PREMIERE
PRO7	PRO7
RAI1	RAI1
RAI2	RAI2
RAI3	RAI3
RET4	RETE4
21	TELE21
RTBF	RTBF1 or 2
RTL	RTL
RTL2	RTL2
RTL4	RTL4
RTL5	RTL5
RTP	RTP
S4	SCHWEIZ4
SAT1	SAT1
SBS	SBS
SHOW	SHOW
SIC	SOCIEDADE
SKY	SKY CHANNEL
SKYN	SKY NEWS
SPRT	SPORT
SRTL	SUPER RTL
STAR	STAR-TV
SVT1	SVT1
SVT2	SVT2
SW3	SUEDWEST3
TCC	TCC
TELE	TELE
TEL5	TELE5
TF1	TF1
TM3	TM3
TMC	TELEMONTECARLO
TNT	TNT INT
TRT	TRT INT
TSI	TSI
TSR	TSR
TV1	BRTN TV1
TV2	BRTN TV2
TV3	TV3
TV4	TV4
TV5	TV5
TV6	TV6
TVE1	TVE1
TVE2	TVE2
TVG	TV GALICIA
TVI	TV INDEPENDENT
TVN	TV NORGE
VCR	VIDEO
VERO	VERONICA
VH-1	VH-1
VIVA	VIVA
VIV2	VIVA2
VMTV	VIDEO MUSIC
VOX	VOX
VT4	VT4
VTM	VTM
WDR1	West1
WDR3	West3
YLE1	YLE1
YLE2	YLE2
ZDF	ZDF
ZTV	ZTV

* The "ID" abbreviation is what is shown on-screen in lieu of the station name. The "ID" abbreviation is listed in the Confirmation screen and is displayed on the TV screen when the recorder is tuned to a different station.

Clock Set

Turn on the TV and select the VIDEO channel (or AV mode).

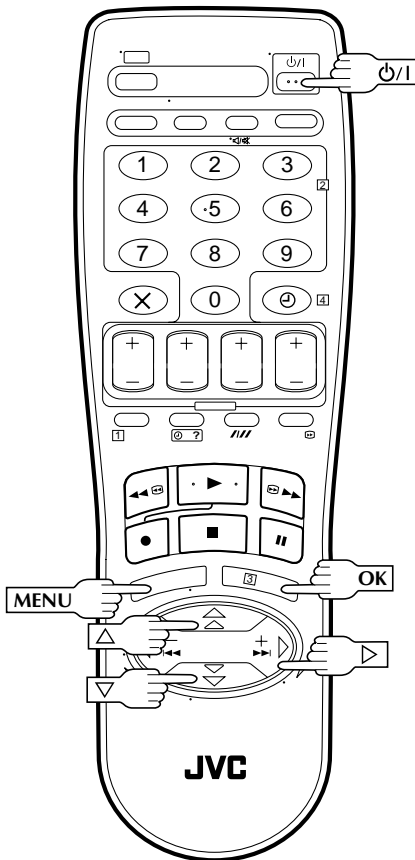

IMPORTANT

Perform the following steps only if —
 — the recorder's memory backup has expired.
 — you want to adjust the time lag of the recorder's built-in clock.

1 TURN THE RECORDER ON

Press P/I .

2 ACCESS MAIN MENU SCREEN

Press **MENU**.

3 ACCESS CLOCK SET SCREEN

Place the pointer next to "CLOCK SET" by pressing $\Delta\nabla$, then press **OK** or \triangleright . The Clock Set screen appears.

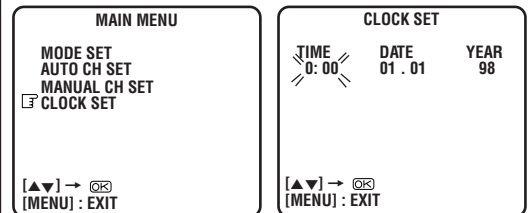

4 SET DATE AND TIME

Press $\Delta\nabla$ to set the time, then press **OK** or \triangleright . The "date" display begins blinking. Repeat the same procedure to set the date and year.

- When you set the time, press and hold $\Delta\nabla$ to change the time by 30 minutes.
- When you set the date, press and hold $\Delta\nabla$ to change the date by 15 days.

5 START CLOCK OPERATION

Press **MENU**.

PLAYBACK

- Q. What happens if the end of the tape is reached during playback or search?**
A. The tape is automatically rewound to the beginning.
.....
- Q. Can the video recorder indefinitely remain in the still mode?**
A. No. It stops automatically after 5 minutes to protect the heads.
.....
- Q. During search, slow, still and frame-by-frame playback, I can't hear any audio. What's the problem?**
A. This is normal.
.....
- Q. When returning from multi-speed search to normal playback, the picture is disturbed. Should I be concerned about this?**
A. No, it is normal.
.....
- Q. Noise bars appear during multi-speed search. What's the problem?**
A. This is normal.
.....
- Q. Other than preventing further recording, what effect does removing the Record Safety tab have?**
A. It disables marking of index codes.
.....
- Q. Sometimes, during Index Search, the video recorder can't find the programme I want to see. Why not?**
A. There may be index codes too close together.
.....

RECORDING

- Q. When I pause and then resume a recording, the end of the recording before the pause is overlapped by the beginning of the continuation of recording. Why does this happen?**
A. This is normal. It reduces distortion at the pause and resume points.
.....
- Q. Can the video recorder indefinitely remain in the Record-Pause mode?**
A. No. The video recorder goes to its Stop mode automatically after 5 minutes to protect the heads.
.....
- Q. What happens if the tape runs out during recording?**
A. The video recorder automatically rewinds it to the beginning.
.....

TIMER RECORDING

- Q. "⦿" and "⊖" remain lit on the display panel. Is there a problem?**
A. No. This is a normal condition for a timer recording in progress.
.....
- Q. Can I program the timer while I'm watching a tape or a TV broadcast?**
A. You won't see the picture as it is replaced by the on-screen menu, but the audio from the program or tape you're viewing can be heard.
.....
- Q. Is it possible to timer-record a TV programme broadcast in 2000?**
A. Yes, it is possible.
.....

ATTENTION

This recorder contains microcomputers. External electronic noise or interference could cause malfunctioning. In such cases, switch the recorder off and unplug the mains power cord. Then plug it in again and turn the recorder on. Take out the cassette. After checking the cassette, operate the unit as usual.

Before requesting service for a problem, use this chart and see if you can repair the trouble yourself. Small problems are often easily corrected, and this can save you the trouble of sending your video recorder off for repair.

POWER

SYMPTOM	POSSIBLE CAUSE	CORRECTIVE ACTION
1. No power is applied to the recorder.	<ul style="list-style-type: none"> The mains power cord is disconnected. 	Connect the mains power cord.
2. The clock is functioning properly, but the recorder cannot be powered.	<ul style="list-style-type: none"> "⊖" is displayed on the display panel with Auto Timer set to "OFF". 	Press the ⊖ button to turn the "⊖" indicator off.
3. The remote control won't function.	<ul style="list-style-type: none"> The batteries are discharged. 	Replace the dead batteries with new ones.

TAPE TRANSPORT

SYMPTOM	POSSIBLE CAUSE	CORRECTIVE ACTION
1. The tape does not run during recording.	<ul style="list-style-type: none"> "□□" is displayed on the display panel. 	Press PLAY to turn the "□□" indicator off.
2. The tape will not rewind or fast-forward.	<ul style="list-style-type: none"> The tape is already fully rewound or fast-forwarded. 	Check the cassette.











PLAYBACK

SYMPTOM	POSSIBLE CAUSE	CORRECTIVE ACTION
1. The playback picture does not appear while the tape is running.	<ul style="list-style-type: none"> If you're using the RF OUT connection the TV receiver's channel selector is not set to the VIDEO channel. . . . the recorder's VIDEO channel has not been correctly set. If you're using the AV connection, the TV receiver is not set to the AV mode. 	<p>If you are using the RF OUT connection set the TV receiver to the VIDEO channel. (☞ pg. 4) . . . perform "Video Channel Set". (☞ pg. 4)</p> <p>If you are using the AV connection, set the TV to its AV mode.</p>
2. Noise appears during visual search.	<ul style="list-style-type: none"> This is normal. 	
3. Noise appears during normal playback.	<ul style="list-style-type: none"> The automatic tracking mode is engaged. 	Try manual tracking. (☞ pg. 10)
4. The playback picture is blurred or interrupted while TV broadcasts are clear.	<ul style="list-style-type: none"> The video heads may be dirty. 	Consult your JVC dealer.



RECORDING

SYMPTOM	POSSIBLE CAUSE	CORRECTIVE ACTION
1. Recording cannot be started.	<ul style="list-style-type: none"> There is no cassette loaded, or the cassette loaded has had its Record Safety tab removed. 	Insert a cassette, or using adhesive tape, reseal the slot where the tab was removed.
2. TV broadcasts cannot be recorded.	<ul style="list-style-type: none"> "L-1" has been selected as the input mode. 	Set to the desired channel.
3. Tape-to-tape editing is not possible.	<ul style="list-style-type: none"> The source (another video recorder, camcorder) has not been properly connected. All necessary power switches have not been turned on. The input mode is not correct. 	<p>Confirm that the source is properly connected.</p> <p>Confirm that all units' power switches are turned on. Set the input mode to "L-1".</p>
4. Camcorder recording is not possible.	<ul style="list-style-type: none"> The camcorder has not been properly connected. The input mode is not correct. 	<p>Confirm that the camcorder is properly connected.</p> <p>Set the input mode to "L-1".</p>

TIMER RECORDING

SYMPTOM	POSSIBLE CAUSE	CORRECTIVE ACTION
1. Timer recording won't work.	<ul style="list-style-type: none"> • The clock and/or the timer have been set incorrectly. • The timer is not engaged. 	Re-perform the clock and/or timer settings. Press  and confirm that "  " is displayed on the display panel.
2. Timer programming is not possible.	<ul style="list-style-type: none"> • Timer recording is in progress. 	Timer programming can't be performed while a timer recording is in progress. Wait until it finishes.
3. "  " and "  " on the display panel won't stop blinking.	<ul style="list-style-type: none"> • The timer is engaged but there's no cassette loaded. 	Load a cassette with the Record Safety tab intact, or cover the hole using adhesive tape.
4. The cassette is automatically ejected, and "  " and "  " on the display panel won't stop blinking.	<ul style="list-style-type: none"> • The loaded cassette has had its Record Safety tab removed. 	Remove the cassette and cover the hole with adhesive tape, or insert a cassette with the Record Safety tab intact.
5. "  " blinks for 10 seconds and the Timer mode is disengaged.	<ul style="list-style-type: none"> •  has been pressed when there are no programs in memory, or the timer record information has been programmed incorrectly. 	Check the programmed data and re-program as necessary, then press  .
6. The cassette is automatically ejected, the power shuts off and "  " and "  " won't stop blinking.	<ul style="list-style-type: none"> • The end of the tape was reached during timer recording. 	The programme may not have been recorded in its entirety. Next time make sure you have enough time on the tape to record the entire programme.

OTHER PROBLEMS

SYMPTOM	POSSIBLE CAUSE	CORRECTIVE ACTION
1. Whistling or howling is heard from the TV during camcorder recording.	<ul style="list-style-type: none"> • The camcorder's microphone is too close to the TV. • The TV's volume is too high. 	Position the camcorder so its microphone is away from the TV. Turn the TV's volume down.
2. When scanning channels, some of them are skipped over.	<ul style="list-style-type: none"> • Those channels have been designated to be skipped. 	If you need the skipped channels, restore them ( pg. 24).
3. The channel cannot be changed.	<ul style="list-style-type: none"> • Recording is in progress. 	Press PAUSE to pause the recording, change channels, then press PLAY to resume recording.
4. Channel settings that were made manually seem to have changed or disappeared.	<ul style="list-style-type: none"> • After the manual settings were made, Auto Channel Set was performed. 	Perform manual setting again.
5. No channels are stored in the recorder's memory.	<ul style="list-style-type: none"> • The TV aerial cable was not connected to the recorder when Auto Set Up was performed. 	Connect the TV aerial cable to the recorder properly and turn off the recorder power once, then turn the recorder power back on again. The recorder will try Auto Set Up again ( pg. 5).

FRONT VIEW

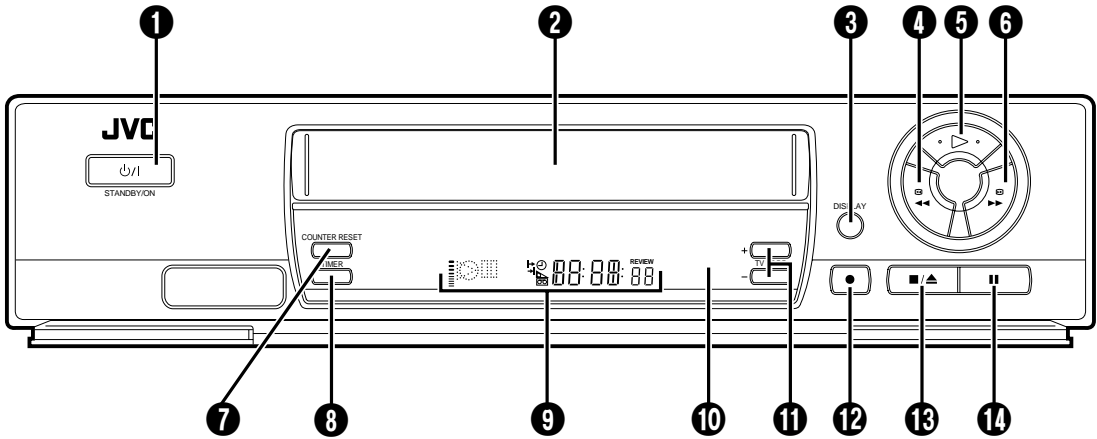

- ❶ STANDBY/ON ϕ /I Button \rightarrow pg. 5
- ❷ Cassette Loading Slot
- ❸ DISPLAY Button \rightarrow pg. 13
- ❹ Rewind [REW] Button \rightarrow pg. 8, 9
- ❺ PLAY Button \rightarrow pg. 8
- ❻ Fast Forward Button \rightarrow pg. 8, 9
- ❼ COUNTER RESET Button \rightarrow pg. 13

- ❽ TIMER Button \rightarrow pg. 17
- ❾ Display Panel \rightarrow pg. 33
- ❿ Infrared Beam Receiving Window
- ⓫ TV PROG +/- Buttons \rightarrow pg. 12
- ⓬ RECORD Button \rightarrow pg. 12
- ⓭ STOP/EJECT Button \rightarrow pg. 8
- ⓮ PAUSE Button \rightarrow pg. 9

REAR VIEW

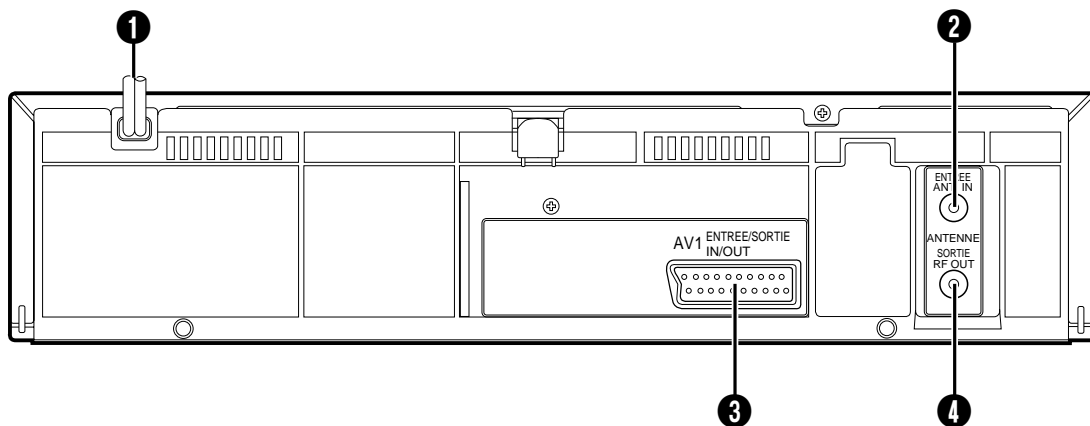

- ❶ Mains Power Cord ↗ pg. 3
- ❷ ANT. IN Connector ↗ pg. 3

- ❸ AV1 IN/OUT Connector ↗ pg. 3, 20
- ❹ RF OUT Connector ↗ pg. 3

DISPLAY PANEL

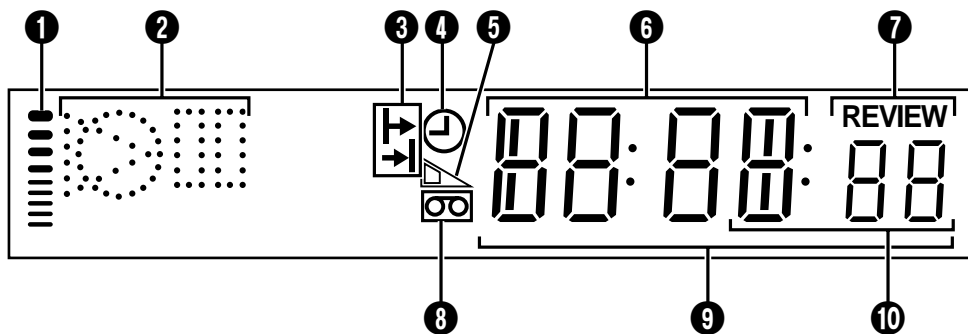

- ❶ B.E.S.T. Picture System Display ↗ pg. 14
- ❷ Symbolic Mode Indicators

PLAY: FF/REW VARIABLE SHUTTLE SEARCH:		STILL:	
		SLOW:	
		RECORD PAUSE:	

- ❸ Programme Time Indicators ↗ pg. 16

- ❹ "Timer" Indicator ↗ pg. 17
- ❺ Tape Remaining Time Indicator ↗ pg. 13
- ❻ Channel/Clock Display
- ❼ Instant REVIEW Indicator ↗ pg. 10
- ❽ "Cassette Loaded" Mark
- ❾ Counter/Remain Display
- ❿ Mode Display (L-1)

REMOTE CONTROL

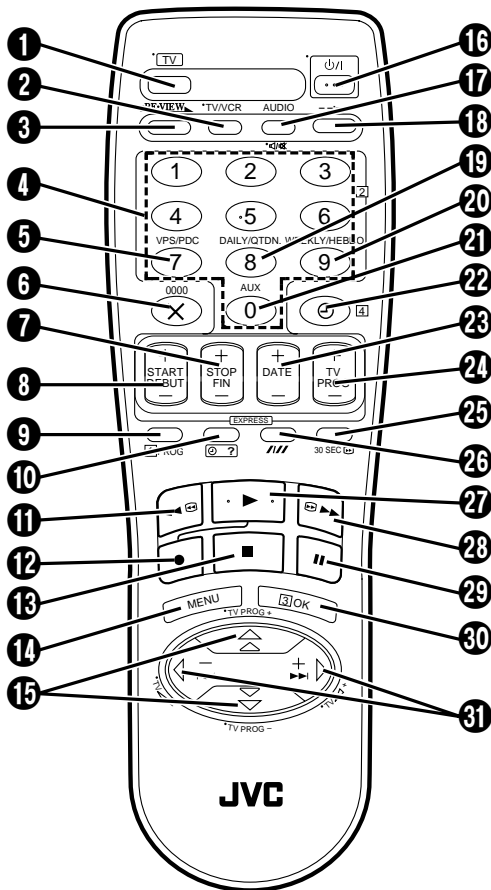

- ❶ TV Button (See below)
- ❷ TV/VCR Button (See below)
- ❸ REVIEW Button ☞ pg. 10
- ❹ NUMBER KEYS ☞ pg. 12
- ❺ VPS/PDC Button (No Function with this recorder)
- ❻ X Button ☞ pg. 18
0000 Button ☞ pg. 13
- ❼ STOP +/- Button ☞ pg. 16
- ❽ START +/- Button ☞ pg. 16
- ❾ PROG Button ☞ pg. 16
- ❿ ? Button ☞ pg. 18
- ⓫ Rewind [REW] Button ☞ pg. 8, 9
- ⓬ Record Button ☞ pg. 12
- ⓭ Stop Button ☞ pg. 8
- ⓮ MENU Button ☞ pg. 6
- ⓯ $\Delta \nabla$ Button ☞ pg. 6
TV PROG +/- (See below)
- ⓶ STANDBY/ON ψ / I Button ☞ pg. 5
- ⓷ \square / Mute (TV Muting) Button (See below)
- ⓸ DISPLAY Button ☞ pg. 13
- ⓹ DAILY Button ☞ pg. 17
- ⓺ WEEKLY Button ☞ pg. 17
- ⓻ AUX Button ☞ pg. 20
- ⓼ ? Button ☞ pg. 17
- ⓽ DATE +/- Button ☞ pg. 16
- ⓿ TV PROG +/- Button ☞ pg. 12
- ⓾ 30 SEC Button ☞ pg. 11
- ⓿ Auto Tracking Button ☞ pg. 10
- ⓿ Play Button ☞ pg. 8
- ⓿ Fast Forward Button ☞ pg. 8, 9
- ⓿ Pause Button ☞ pg. 9
- ⓿ OK Button ☞ pg. 6
- ⓿ $\triangleleft \triangleright$ Button ☞ pg. 9, 10
TV \triangleleft +/- Button (See below)

Buttons with a small dot on the left side of the name can also be used to operate your JVC TV while holding down the TV button. ☞ "Operating JVC TVs" below.

This remote control transmits A code signals only; it is not applicable to B code signals.

How To Use

The remote control can operate most of your video recorder's functions, as well as basic functions of JVC TV sets. (See below.)

- Point the remote control toward the sensor window.
- The maximum operating distance of the remote control is about 8 m.

Operating JVC TVs

To operate your TV, while holding down TV, press the corresponding button: STANDBY/ON ψ / I , TV/VCR, TV PROG +/-, TV \triangleleft +/-, \square / Mute (TV Muting).

NOTES:

- When inserting the batteries, be sure to insert in the correct directions as indicated under the battery cover.
- Depending on the type of JVC TV, there may be cases where some or all functions cannot be operated using the remote control.
- If the remote control doesn't work properly, remove its batteries, wait a short time, replace the batteries and then try again.

GENERAL

Power requirement	: AC 220 – 240 V~, 50/60 Hz
Power consumption	
Power on	: 18 W
Power off	: 4 W
Temperature	
Operating	: 5°C to 40°C
Storage	: –20°C to 60°C
Operating position	: Horizontal only
Dimensions (WxHxD)	: 400 x 94 x 277 mm
Weight	: 3.3 kg
Format	: VHS PAL standard
Maximum recording time	: 240 min. with E-240 video cassette

VIDEO/AUDIO

Signal system	: PAL-type colour signal and CCIR monochrome signal, 625 lines 50 fields
Recording system	: Rotary two-head helical scan system
Signal-to-noise ratio	: 45 dB
Horizontal resolution	: 250 lines
Frequency range	: 70 Hz to 10,000 Hz
Input/Output	: 21-pin SCART connector: IN/OUT x 1

TUNER/TIMER

TV channel storage capacity	: 99 positions (+AUX position)
Tuning system	: Frequency synthesized tuner
Channel coverage	: VHF 47 – 89/104 – 300/302 – 470MHz UHF 470 – 862MHz
Aerial output	: UHF channels 28 – 60 (Adjustable)
Memory backup time	: Approx. 10 min.

ACCESSORIES

Provided accessories	: RF cable, Infrared remote control unit, "R6" battery x 2
----------------------	--

E. & O.E. Design and specifications subject to change without notice.



Free Manuals Download Website

<http://myh66.com>

<http://usermanuals.us>

<http://www.somanuals.com>

<http://www.4manuals.cc>

<http://www.manual-lib.com>

<http://www.404manual.com>

<http://www.luxmanual.com>

<http://aubethermostatmanual.com>

Golf course search by state

<http://golfingnear.com>

Email search by domain

<http://emailbydomain.com>

Auto manuals search

<http://auto.somanuals.com>

TV manuals search

<http://tv.somanuals.com>