

# JVC®



## ENGLISH

### VIDEO CASSETTE RECORDER

# HR-J277MS HR-J271MS

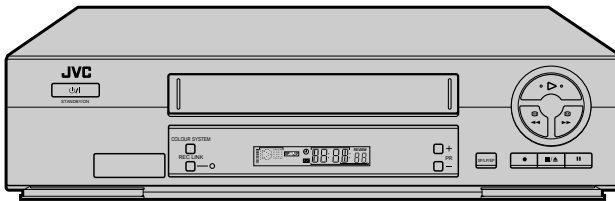

## INSTRUCTIONS

### CONTENTS

<b>SAFETY FIRST</b>	<b>2</b>
Safety Precautions .....	2
<b>INSTALLING YOUR NEW RECORDER</b>	<b>3</b>
Basic Connections .....	3
<b>INITIAL SETTINGS</b>	<b>4</b>
Video Channel Set .....	4
Auto Set Up .....	6
On-Screen Displays .....	8
Select Language .....	9
Clock Set .....	10
<b>PLAYBACK</b>	<b>11</b>
Basic Playback .....	11
Playback Features .....	12
<b>RECORDING</b>	<b>16</b>
Basic Recording .....	16
Recording Features .....	17
B.E.S.T. Picture System .....	18
<b>TIMER RECORDING</b>	<b>20</b>
Express Timer Programming .....	20
Automatic Satellite Programme Recording .....	25
<b>SPECIAL FEATURES</b>	<b>26</b>
Remote Control Functions .....	26
<b>EDITING</b>	<b>30</b>
Edit To Or From Another Video Recorder .....	30
Edit From A Camcorder .....	31
<b>INFORMATION ON MULTI-SYSTEM COMPATIBILITY</b>	<b>32</b>
<b>TUNER SET</b>	<b>34</b>
<b>TROUBLESHOOTING</b>	<b>38</b>
<b>QUESTIONS AND ANSWERS</b>	<b>41</b>
<b>INDEX</b>	<b>42</b>
<b>SPECIFICATIONS</b>	<b>45</b>

LPT0421-001B

# EN

# Safety Precautions

The rating plate and the safety caution are on the rear of the unit.

**WARNING: DANGEROUS VOLTAGE INSIDE**

**WARNING: TO PREVENT FIRE OR SHOCK HAZARD, DO NOT EXPOSE THIS UNIT TO RAIN OR MOISTURE.**

## CAUTION

- When you are not using the recorder for a long period of time, it is recommended that you disconnect the power cord from the mains outlet.
- Dangerous voltage inside. Refer internal servicing to qualified service personnel. To prevent electric shock or fire hazard, remove the power cord from the mains outlet prior to connecting or disconnecting any signal lead or aerial.
- Use the conversion plug (not provided in certain areas) depending on the type of your AC wall outlet.

## ATTENTION

1. This recorder can also receive SECAM colour television signals for recording and playback.
2. Recordings made of SECAM television signals produce monochrome pictures if played back on another video recorder of SECAM standard, or do not produce normal colour pictures if played back on another video recorder of PAL standard.
3. SECAM prerecorded cassettes or recordings made with a SECAM video recorder produce monochrome pictures when played back with this recorder.

## POWER SYSTEM

This set operates on voltage of AC110 – 240 V $\sim$  (Rating), AC90 – 260 V $\sim$  (Operating), 50/60 Hz with automatic switching.

## Caution on Replaceable lithium battery

The battery used in this device may present a fire or chemical burn hazard if mistreated. Do not recharge, disassemble, heat above 100°C or incinerate. Replace battery with Panasonic (Matsushita Electric), Sanyo, Sony or Maxell CR2025. Danger of explosion or Risk of fire if the battery is incorrectly replaced.

- Dispose of used battery promptly.
- Keep away from children.
- Do not disassemble and do not dispose of in fire.

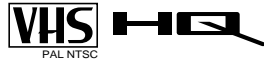

- Only cassettes marked "VHS" (or "S-VHS") can be used with this videorecorder. However, S-VHS recording is not possible with this model.
- HQ VHS is compatible with existing VHS equipment.

## IMPORTANT

- Please read the various precautions on this page before installing or operating the recorder.
- It should be noted that it may be unlawful to re-record pre-recorded tapes, records, or discs without the consent of the owner of copyright in the sound or video recording, broadcast or cable programme and in any literary, dramatic, musical, or artistic work embodied therein.

The STANDBY/ON  $\text{\textcircled{I}}$  button does not completely shut off mains power from the unit, but switches operating current on and off. "  $\text{\textcircled{I}}$  " shows electrical power standby and " I " shows ON.

Video tapes recorded with this video recorder in the LP (Long Play) or EP (Extended Play) mode cannot be played back on a single-speed video recorder.

**Failure to heed the following precautions may result in damage to the recorder, remote control or video cassette.**

1. **DO NOT** place the recorder . . .
  - ... in an environment prone to extreme temperatures or humidity.
  - ... in direct sunlight.
  - ... in a dusty environment.
  - ... in an environment where strong magnetic fields are generated.
  - ... on a surface that is unstable or subject to vibration.
2. **DO NOT** block the recorder's ventilation openings.
3. **DO NOT** place heavy objects on the recorder or remote control.
4. **DO NOT** place anything which might spill on top of the recorder or remote control.
5. **AVOID** violent shocks to the recorder during transport.

# Basic Connections

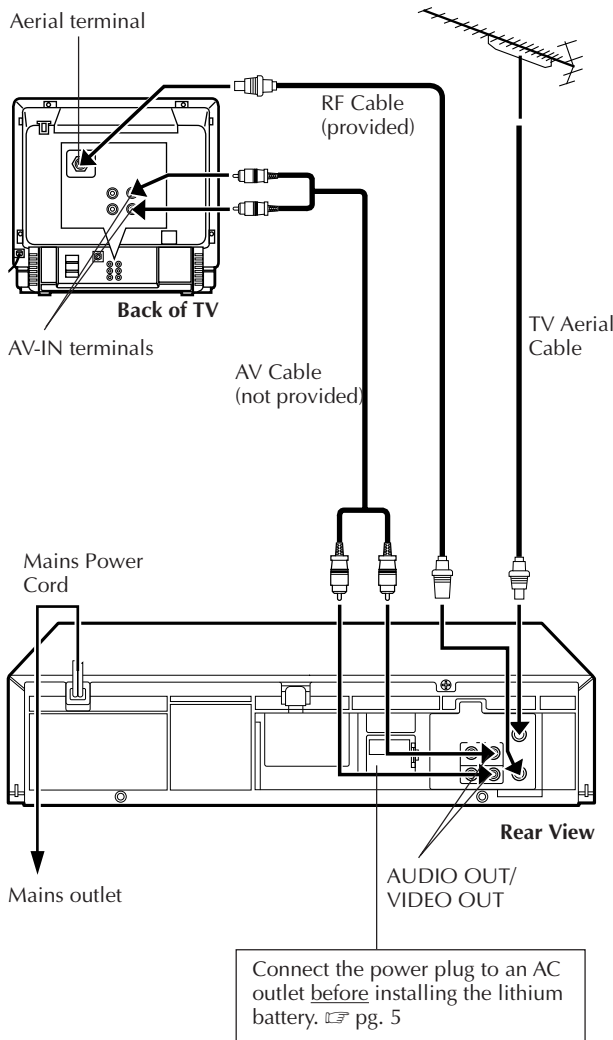

It's essential that your video recorder be properly connected. Follow these steps carefully. THESE STEPS MUST BE COMPLETED BEFORE ANY VIDEO OPERATION CAN BE PERFORMED.

- 1 CHECK CONTENTS**  
Make sure the package contains all of the accessories listed in "Specifications" (pg. 43).
- 2 SITUATE RECORDER**  
Place the recorder on a stable, horizontal surface.
- 3 CONNECT RECORDER TO TV**  
The connection method you use depends on the type of TV you have.
  - RF CONNECTION**
    - To Connect To A TV With NO AV Input Terminals . . .
      - a- Disconnect the TV aerial cable from the TV.
      - b- Connect the TV aerial cable to the ANT. IN jack on the rear panel of the recorder.
      - c- Connect the provided RF cable between the RF OUT jack on the rear panel of the recorder and the TV's aerial terminal.
    - AV CONNECTION**
      - To Connect To A TV With AV Input Terminals . . .
        - a- Connect the aerial, recorder and TV as per "RF CONNECTION".
        - b- Connect an optional AV cable between the AUDIO OUT and VIDEO OUT connectors on the rear panel of the recorder and the TV's AV-IN terminals .
  - 4 CONNECT RECORDER TO MAINS**  
Plug the end of the mains power cord into a mains outlet.
 

**NOTE:**  
Use the conversion plug (not provided in certain areas) depending on the type of your AC wall outlet.

**ATTENTION**  
If you have finished all the necessary connections, go to "Video Channel Set" on page 4, then perform Auto Set Up on page 6; do NOT press the  $\Psi/1$  button on the recorder/remote control to turn on the recorder's power before you start Auto Set Up.

# Video Channel Set

Video Channel (RF Output Channel) is the channel on which your TV receives picture and sound signals from the video recorder through the RF cable.

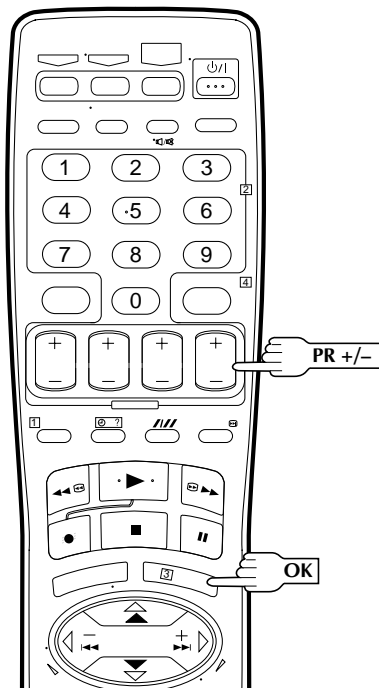
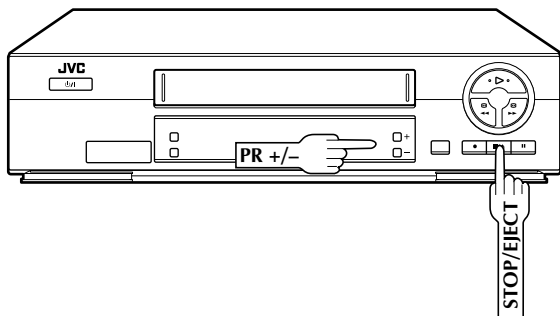

## TEST SIGNAL

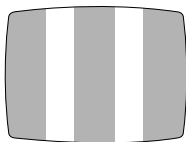

The channel on which the screen to the left appear clearly in step 3 is your Video Channel.

To view picture signals from the video recorder, set your TV to the Video Channel.

If you have connected the video recorder to your TV via the provided RF cable only (RF connection) – Go to "With RF Connection" below.

If you have connected the video recorder to your TV via both the provided RF cable and an AV cable (AV connection) – Go to "With AV Connection" on next page.

## With RF Connection

### IMPORTANT:

Before performing the following steps, make sure the recorder's power is off and there is no cassette inserted in the recorder.

## ACCESS VIDEO CHANNEL SET MODE

1

Hold down **STOP/EJECT** on the recorder until the display panel shows the following.



## SELECT TV SYSTEM

2

Press **PR +** or **-** to set appropriate TV system that matches the system of TV being used (refer to the table below).

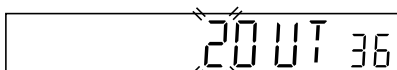

1 : B/G 2 : D/K 3 : I 4 : H

Major Countries/Areas	TV System
New Zealand, Kuwait, U.A.E., Indonesia, Singapore, Thailand, Malaysia, Iran, Saudi Arabia, Egypt, Morocco, Lebanon, Iraq	B/G
China, Mongolia, Russia	D/K
Hong Kong	I
Australia	H

## 3 SET VIDEO CHANNEL

Set your TV to UHF channel 34.

- If the two vertical white bars appear clearly on the screen as shown in the illustration (⇨ "TEST SIGNAL" on page 4), press **OK** and then go to step 4.
- If the two vertical white bars do not appear clearly, press **OK** and then **PR +** or **-** to set the video recorder to a vacant channel between 28 and 60 which is not occupied by any local station in your area.

(Ex.) If channel 50 is available in your area

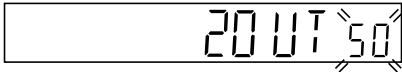

Then set your TV to UHF channel 50 and check if the two vertical white bars appear clearly on the screen; if so, go to step 4. If not, re-set the video recorder to another vacant channel and try again.

### NOTES:

- If you set the video recorder to a channel which is occupied by a local station or has neighbouring channels that are occupied by local stations, the picture reception quality will be affected and some interference noise will appear on the TV screen. Be sure to select a vacant channel which has no broadcast on neighbouring channels.
- If you cannot obtain the two vertical white bars clearly with any channel between 28 and 60, consult your JVC dealer.

## 4 FINISH VIDEO CHANNEL SET

Press **OK**.

- If Auto Set Up (⇨ pg. 6) or Tuner Set (⇨ pg. 34) has not previously been performed, the Language Select screen appears and Auto Set Up function takes place automatically.

## With AV Connection

### IMPORTANT:

Before performing the following steps, make sure the recorder's power is off and there is no cassette inserted in the recorder.

## 1 ACCESS VIDEO CHANNEL SET MODE

Hold down **STOP/EJECT** on the recorder until the display panel shows the following.



## 2 SET VIDEO CHANNEL

Press **OK**, then press **PR -** until the display panel shows the following.

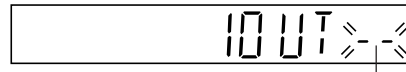

Now the video channel is set to off (- -).

## 3 FINISH VIDEO CHANNEL SET

Press **OK**.

- If Auto Set Up (⇨ pg. 6) or Tuner Set (⇨ pg. 34) has not previously been performed, the Language Select screen appears and Auto Set Up function takes place automatically.

To view picture signals from the video recorder, set your TV to its AV mode.

Be sure to connect the power plug to an AC outlet first before installing the lithium battery; otherwise, the battery's service life will be drastically shortened.

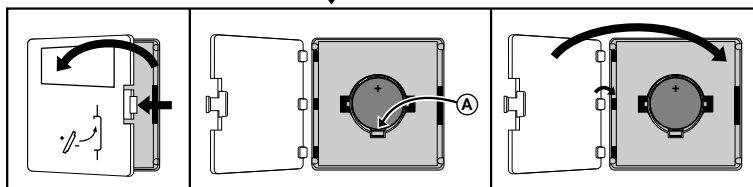
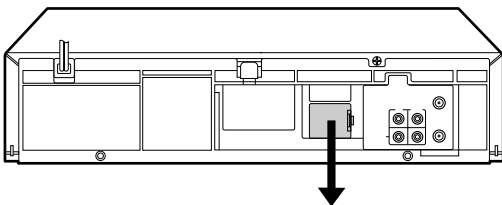

### Installing/Removing the lithium battery

- 1 Make sure that the power plug is connected to an AC outlet and turn off the recorder power.
- 2 Open the battery cover while pressing the release tab as illustrated.
- 3 Insert a lithium battery with the plus (+) side up and push it in.
  - To remove the lithium battery, press the latch (A) downward using a pointed non-metallic object, then pull out the lithium battery.
- 4 Close the battery cover until it clicks in place.

# Auto Set Up

## IMPORTANT

- Don't press any buttons on the recorder or remote that are not directly related to the step you are performing while Auto Set Up is in progress.
- If you perform Auto Set Up successfully during installation, there's no need to separately perform the Language Select, Clock Set or Channel Set procedures, but if adjustments become necessary they can be performed as follows:
  - To change the selected language [pg. 9](#)
  - To reset or adjust the time [pg. 10](#)
  - To add/delete channels manually [pg. 35](#)
  - To reset the tuner after moving to a different location [pg. 34](#)

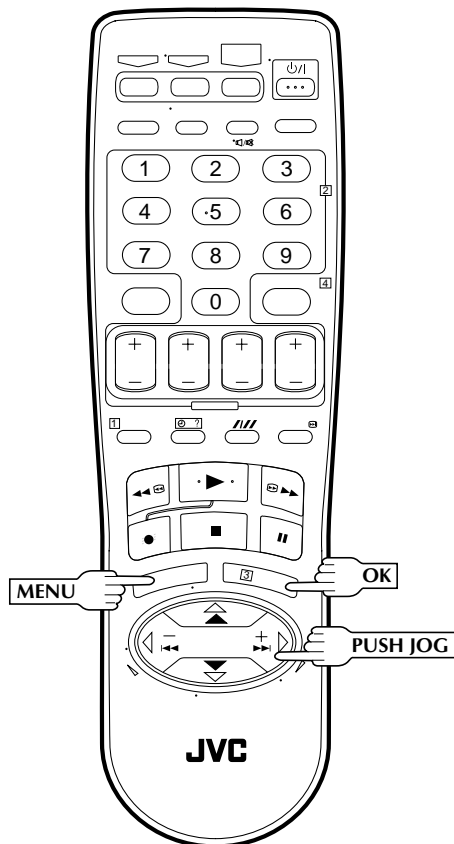

The Auto Set Up function simplifies installation by guiding you through the procedures of setting the language, clock and tuner channels — simply follow the on-screen menus that appear.

Before starting, make sure of the following:

- The TV aerial cable should be connected to the recorder.
- The recorder's mains power cord should be connected to a mains outlet. [pg. 3](#)
- The "Video Channel Set" procedure should be done first and the TV should be set to its AV mode (With AV connection [pg. 5](#)) or video channel (With RF connection [pg. 4](#)).

## SELECT LANGUAGE

**1** Press **PUSH JOG**  $\Delta\nabla$  to place the pointer next to your desired language (English, Arabic or Russian), then press **OK** or **PUSH JOG**  $\triangleright$ .

- The Clock Set screen appears.

## SET TIME

**2** Press **PUSH JOG**  $\Delta\nabla$  to set the time, then press **OK** or **PUSH JOG**  $\triangleright$ .

- Press and hold either button to delay or advance the time by 30 minutes.

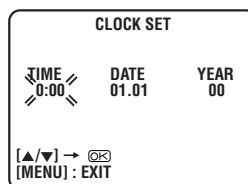

## SET DATE

**3** Press **PUSH JOG**  $\Delta\nabla$  to set the date, then press **OK** or **PUSH JOG**  $\triangleright$ .

- Press and hold either button to change the date by 15 days.

## SET YEAR

**4** Press **PUSH JOG**  $\Delta\nabla$  to set the year, then press **MENU**.

Major Countries/Areas	TV System
Australia, New Zealand, Kuwait, U.A.E., Indonesia, Singapore, Thailand, Malaysia, Iran, Saudi Arabia, Egypt, Morocco, Lebanon, Iraq	B/G
China, Mongolia, Russia	D/K
Hong Kong	I

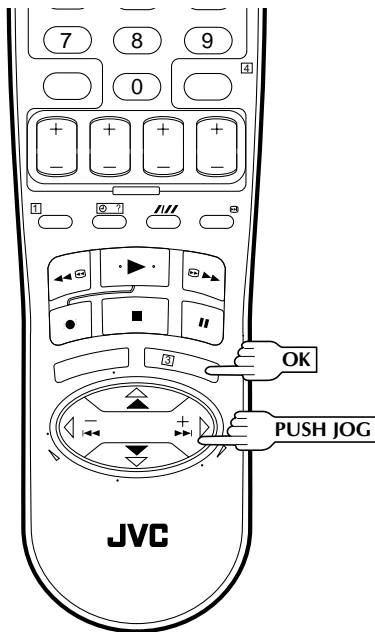

## 5 SELECT TV SYSTEM

Press **PUSH JOG**  $\Delta \nabla$  to place the pointer next to the appropriate TV system (refer to the table on the left).

## 6 START AUTO CHANNEL SET

Press **OK** or **PUSH JOG**  $\triangleright$ .

- The Auto Set Up function scans all the channels that are receivable by your recorder. It then automatically assigns each receivable channels to the **PR**  $+/-$  buttons. It skips non-receivable channels.
- As Auto Set Up progresses, the "■" mark on the screen moves from left to right. (See below.)

**DO NOT** press any button on the recorder or remote control while Auto Set Up is in progress.

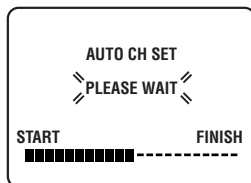

**During Auto Set Up**  
"PLEASE WAIT" blinks on the screen and "Auto" blinks on the front display panel.

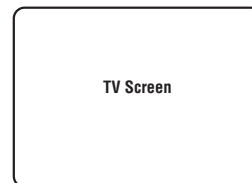

When Auto Set Up is completed, the lowest position number will appear on the front display panel.

## NOTES:

- If you perform Auto Set Up when the aerial cable is not connected properly, "SCAN COMPLETED -NO SIGNAL-" appears on the screen. When this happens, make sure of the aerial connection and press **OK**; Auto Set Up will take place again.
- If there is a power cut, or if you press  $\mathcal{O}/I$  or **MENU** while Auto Set Up is in progress, Auto Set Up will be interrupted; be sure to turn off the recorder power once and try again.
- If you want to set the tuner manually such as to add or skip channels, to swap channel positions, or to fine-tune channels,  $\square$  pg. 35-37.
- If no sound accompanies the picture or the audio sounds unnatural on some channels that have been stored by Auto Set Up, the TV system setting for those channels may be incorrect. Select the appropriate TV system for those channels.  $\square$  "TV System Selection - When you see the picture but the audio can't be heard or sounds unnatural" on page 37.

# On-Screen Displays

Turn on the TV and select the VIDEO channel (or AV mode).

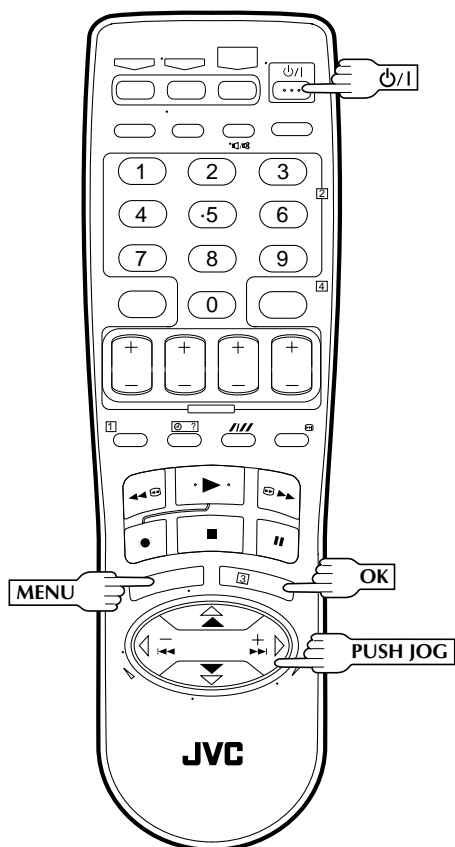

You can choose whether or not to have various operational indicators appear on screen, by setting this function ON or OFF.

## 1 TURN ON THE RECORDER

Press **⏻/I**.

## 2 ACCESS MAIN MENU SCREEN

Press **MENU**.

## 3 ACCESS FUNCTION SET SCREEN

Place the pointer next to "FUNCTION SET" by pressing **PUSH JOG**  $\Delta \nabla$ , then press **OK** or **PUSH JOG**  $\triangleright$ .

## 4 ENABLE/DISABLE ON-SCREEN DISPLAY

The default setting is "ON", so if you want on-screen displays, leave the setting as it is and go to step 5. If you don't want the displays to appear, press **PUSH JOG**  $\Delta \nabla$  to place the pointer next to "O.S.D." and press **OK** or **PUSH JOG**  $\triangleright$  to set to "OFF".

FUNCTION SET		
B.E.S.T.		ON
PICTURE CONTROL		AUTO
AUTO TIMER		OFF
O.S.D.		ON
AUTO SP→LP TIMER		OFF
[▲/▼] → [OK]		
[MENU] : EXIT		

## 5 RETURN TO NORMAL SCREEN

Press **MENU**.

### NOTES:

- When you use this recorder as the player for editing, be sure to set "O.S.D." to "OFF" before starting.
- During playback, the operation mode indicators may be disturbed depending on the type of tape being used.

The superimposed indication on the TV screen tells you what the recorder is doing.

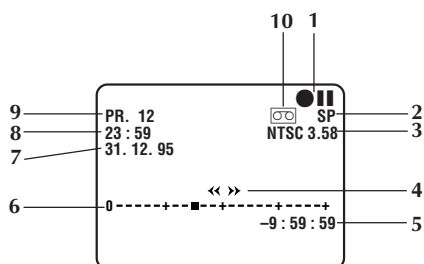

- 1- Operation mode indicators
- 2- Tape speed SP/LP/EP
- 3- Colour system indicator (pg. 32)
- 4- Tape direction
- 5- Counter display
- 6- Tape position indicator (pg. 15)
- 7- Current day/month/year
- 8- Clock display
- 9- Channel position number/Aux. indicator (L-1)
- 10- Cassette loaded mark



# Select Language

Turn on the TV and select the VIDEO channel (or AV mode).

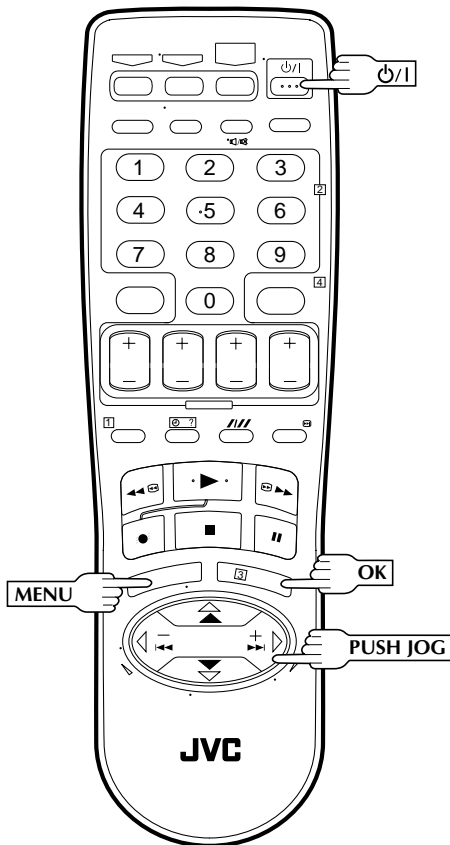

## 1 TURN ON THE RECORDER

Press **⏻/I**.

## 2 ACCESS MAIN MENU SCREEN

Press **MENU**.

## 3 ACCESS INITIAL SET SCREEN

Press **PUSH JOG**  $\Delta\nabla$  to place the pointer next to "INITIAL SET", then press **OK** or **PUSH JOG**  $\triangleright$ .

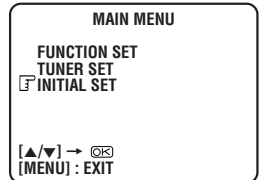

## 4 ACCESS LANGUAGE SELECT SCREEN

Press **PUSH JOG**  $\Delta\nabla$  to place the pointer next to "LANGUAGE", then press **OK** or **PUSH JOG**  $\triangleright$ .

## 5 SELECT LANGUAGE

Place the pointer next to the language of your choice (English, Arabic or Russian) by pressing **PUSH JOG**  $\Delta\nabla$ , then press **OK** or **PUSH JOG**  $\triangleright$ .

## 6 RETURN TO NORMAL SCREEN

Press **MENU**.

# Clock Set

Turn on the TV and select the VIDEO channel (or AV mode).

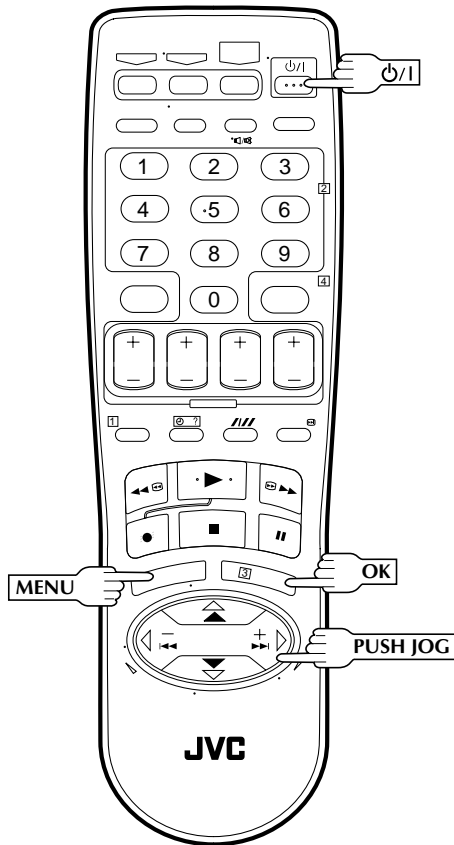

## 1 TURN THE RECORDER ON

Press **1**.

## 2 ACCESS MAIN MENU SCREEN

Press **2**.

## 3 ACCESS INITIAL SET SCREEN

Press **3** **PUSH JOG**  $\Delta$ / $\nabla$  to place the pointer next to "INITIAL SET", then press **OK** or **PUSH JOG**  $\triangleright$ .

## 4 ACCESS CLOCK SET SCREEN

Press **4** **PUSH JOG**  $\Delta$ / $\nabla$  to place the pointer next to "CLOCK SET", then press **OK** or **PUSH JOG**  $\triangleright$ . The Clock Set screen appears.



## 5 SET TIME

Press **5** **PUSH JOG**  $\Delta$ / $\nabla$  to set the time, then press **OK** or **PUSH JOG**  $\triangleright$ .

- Press and hold either button to delay or advance the time by 30 minutes.

## 6 SET DATE

Press **6** **PUSH JOG**  $\Delta$ / $\nabla$  to set the date, then press **OK** or **PUSH JOG**  $\triangleright$ .

- Press and hold either button to change the date by 15 days.

## 7 SET YEAR

Press **7** **PUSH JOG**  $\Delta$ / $\nabla$  to set the year.

## 8 START CLOCK OPERATION

Press **8** **MENU**.

### NOTE:

If the year digits are automatically cleared, it is possible that you have input February 29th in a non-leap year. Input the correct data.

# Basic Playback

Turn on the TV and select the VIDEO channel (or AV mode).

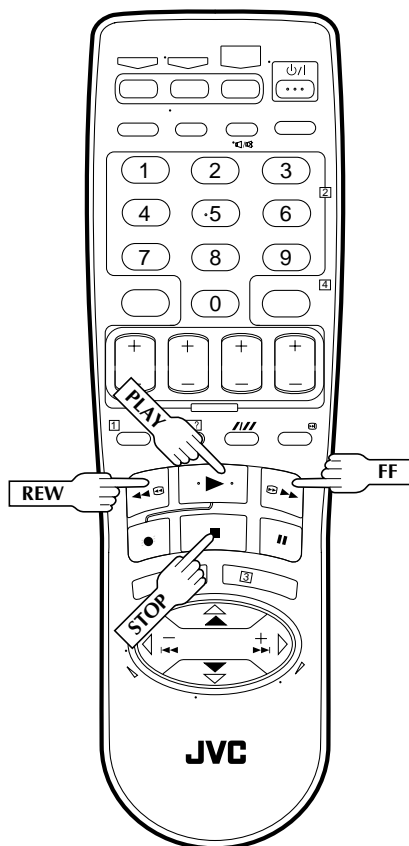
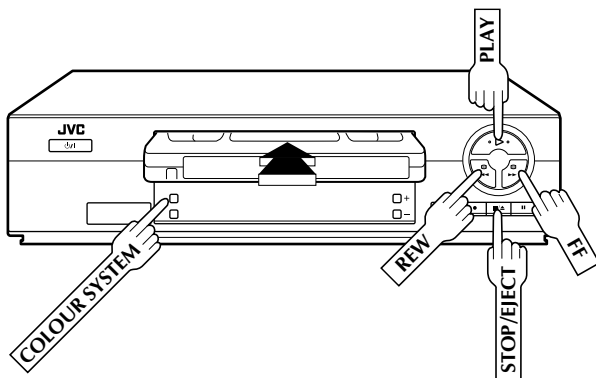

The easiest, most basic operation possible with your video recorder is tape playback. Already-recorded signals on a video tape are read by your video recorder and displayed on your TV just like a TV programme.

1

## LOAD A CASSETTE

Make sure the window side is up, the rear label side is facing you and the arrow on the front of the cassette is point toward the recorder. Don't apply too much pressure when inserting.

- The recorder power comes on automatically and the counter is reset to 0:00:00.
- Select the appropriate colour system by pressing the **COLOUR SYSTEM** button. (☞ pg. 32)
- If the record safety tab has been removed, playback begins automatically. (☞ pg. 16)

2

## FIND PROGRAMME START POINT

If the tape is advanced past the start point, press **REW**. To go forward, press **FF**.

3

## START PLAYBACK

Press **PLAY**. "BEST" appears blinking in the recorder's display panel during automatic tracking. (☞ pg. 18)

4

## STOP PLAYBACK

Press **STOP** on the remote or **STOP/EJECT** on the recorder's front panel. Then press **STOP/EJECT** to remove the cassette.

## Clean the video heads using a dry cleaning cassette--TCL-2UX--when:

- Rough, poor picture appears while a tape is played back.
- The picture is unclear or no picture appears.
- "USE CLEANING CASSETTE" appears on the screen (only with "O.S.D." set to "ON" (☞ pg. 8).

### Usable cassettes

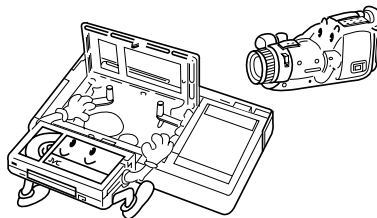

- Compact VHS camcorder recordings can be played on this video recorder. Simply place the recorded cassette into a VHS Cassette Adapter and it can be used just like any full-sized VHS cassette.
- This video recorder can record on regular VHS and Super VHS cassettes. However, it will record and play back regular VHS signals only. It is not possible to play back a recorded Super VHS tape.

# Playback Features

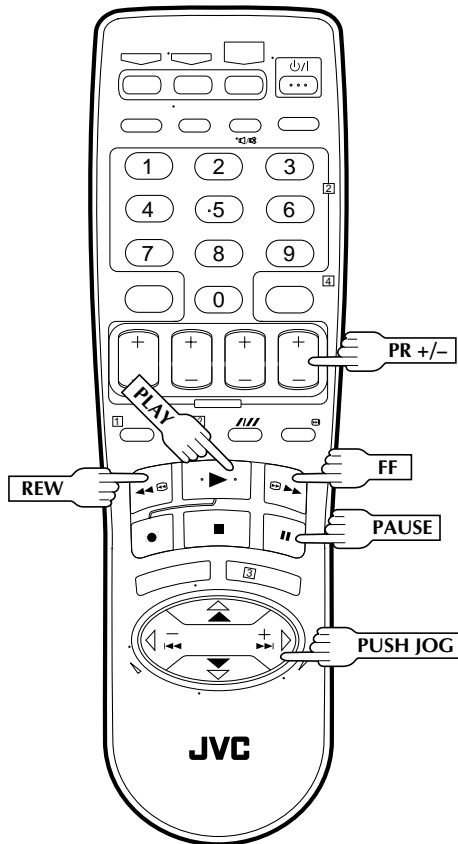
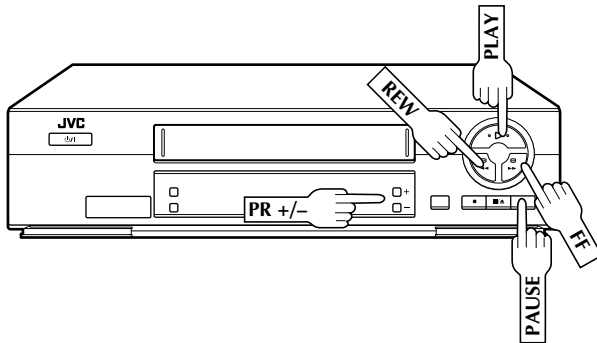

## ATTENTION

In the search, still, slow-motion or frame-by-frame playback mode,

- the picture will be distorted.
- the noise bars will appear.
- the picture may not appear.

## Variable-Speed Search

### 1 ACTIVATE VARIABLE-SPEED SEARCH

During playback, press **PUSH JOG** ◀ or ▶.

- The more times you press, the faster the playback picture moves.
- To decrease speed, press the button for the opposite direction.

To resume normal playback, press **PLAY**.

## Still Picture/Frame-By-Frame Playback

### 1 PAUSE DURING PLAYBACK

Press **PAUSE**. If there is vertical jitter, use the **PR +/-** buttons to correct the picture.

### 2 ACTIVATE FRAME-BY-FRAME PLAYBACK

Press **PAUSE**.

**OR**

Press **PUSH JOG** ◀ or ▶.

To resume normal playback, press **PLAY**.

## Slow Motion

### 1 ACTIVATE SLOW-MOTION PLAYBACK

During still picture, press and hold **PAUSE** for 2 seconds, then release. Press and release again to return to still picture.

**OR**

During still picture, press and hold **PUSH JOG** ◀ or ▶. Release to return to still picture.

To resume normal playback, press **PLAY**.

## High-Speed Search

### 1 ACTIVATE HIGH-SPEED SEARCH

During playback or still, press **FF** for forward high-speed search, or **REW** for reverse high-speed search.

To resume normal playback, press **PLAY**.

## NOTE:

For short searches, press and hold **FF** or **REW** during playback or still picture. When released, normal playback resumes.

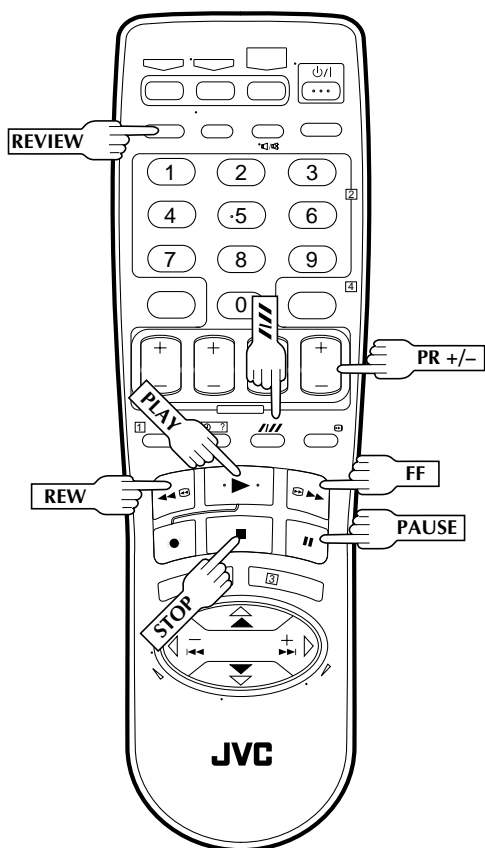

## Manual Tracking

Your video recorder is equipped with automatic tracking control. During playback, you can override this and adjust the tracking manually by pressing the **PR +/-** buttons.

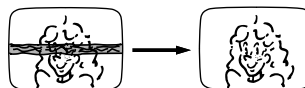

### 1 OVERRIDE AUTOMATIC TRACKING

Press **PR +** and **-** on the recorder to engage manual tracking.

### 2 ADJUST TRACKING MANUALLY

Press **PR +** or **-** to adjust tracking.

### 3 RETURN TO AUTOMATIC TRACKING

Press **PR +** and **-** on the recorder to re-engage automatic tracking.

#### NOTE:

When a new tape is inserted, the recorder enters the automatic tracking mode automatically.

## Repeat Playback

Your video recorder can automatically play back the whole tape 100 times repeatedly.

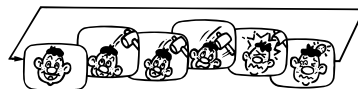

### 1 START PLAYBACK

Press **PLAY**.

### 2 ACTIVATE REPEAT PLAYBACK

Press **PLAY** and hold for over 5 seconds, then release.

- The Play indicator (▶) on the display panel blinks slowly.
- The tape plays 100 times automatically, and then stops.

### 3 STOP PLAYBACK

Press **STOP** at any time to stop playback.

#### NOTE:

Pressing **PLAY**, **REW**, **FF** or **PAUSE** also stops Repeat Playback.

## Instant ReView

Simply by pressing a single button, the recorder power comes on, rewinds, and begins playback of the last timer-recorded programme. If you have several programmes recorded, you can easily access any of them.

#### NOTE:

Before starting, make sure that the recorder is off and that the Timer mode is disengaged.

### 1 ACTIVATE INSTANT REVIEW

Press **REVIEW**. The recorder power comes on and the recorder searches for the index code indicating the start of the last timer-recorded programme. Once it's found, playback begins automatically.

- If you have, for example, 3 programmes and you want to watch the first of the 3 programmes, press **REVIEW** three times. The recorder searches and begins playback automatically. You can access a programme as far as 9 index codes away from the current tape position.

#### NOTE:

Instant ReView is not possible while the recorder is in the Timer mode.

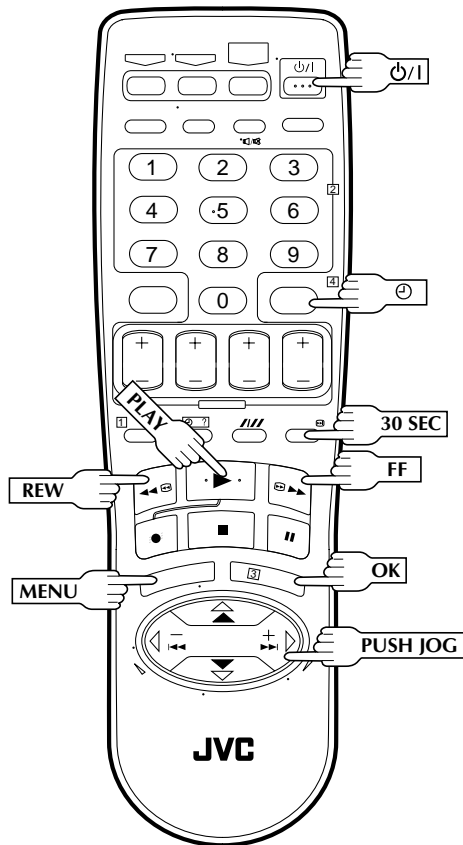

## Index Search

Your recorder automatically marks index codes at the beginning of each recording. This function gives you quick access to any one of 9 index codes in either direction.

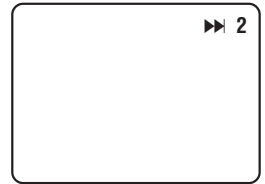

### NOTE:

Before starting, make sure the recorder is in the Stop mode.

## 1 ACTIVATE INDEX SEARCH

Press **PUSH JOG** < or > (◀◀ or ▶▶) on the remote control. "◀◀ 1" or "▶▶ 1" is displayed on screen and search begins in the corresponding direction.

- To access index codes 2 through 9, press **PUSH JOG** < or > repeatedly until the correct index number is displayed.

Ex.: To locate the beginning of B from the current position, press **PUSH JOG** < twice.

To locate the beginning of D from the current position, press **PUSH JOG** > once.

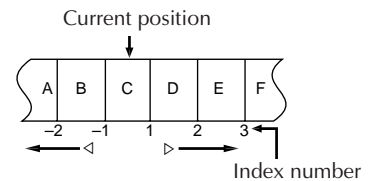

- When the specified index code is located, playback begins automatically.

## Skip Search

### 1 SKIP OVER UNWANTED SECTIONS

Press **30 SEC** 1 to 4 times during playback. Each press initiates a 30-second period of fast-motion playback. Normal playback resumes automatically.

### NOTE:

To return to normal playback during a Skip Search, press **PLAY**.

## Next Function Memory

The Next Function Memory "tells" the recorder what to do after rewinding. Before continuing, ensure that the recorder is in the Stop mode.

- a- For Automatic Start Of Playback After Tape Rewind...  
...press **REW**, then press **PLAY** within 2 seconds.
- b- For Automatic Power Off After Tape Rewind...  
...press **REW**, then press **⏻/I** within 2 seconds.
- c- For Automatic Timer Standby After Tape Rewind...  
...press **REW**, then press **⏻** within 2 seconds.

### NOTE:

It is not possible to select the Automatic Timer functions if the cassette's record safety tab is removed.

## Tape Position Indicator

The tape position indicator appears on screen when, from the Stop mode, you press **FF**, **REW** or perform an Index Search. The position of "■" in relation to "0" (beginning) or "+" (end) shows you where you are on the tape. "O.S.D." (ⓘ pg. 8) must be set to "ON", or the indicator will not appear.

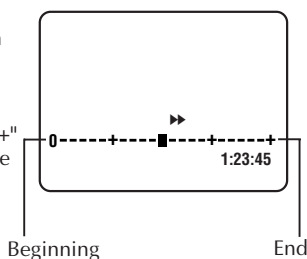

### NOTE:

Depending on the type of tape used, there may be times when the indication is not correct.

## Picture Control

This feature helps you to adjust the playback picture quality according to your preference. \*The default setting is "AUTO."

### 1 ACCESS MAIN MENU SCREEN

Press **MENU**.

### 2 ACCESS FUNCTION SET SCREEN

Place the pointer next to "FUNCTION SET" by pressing **PUSH JOG Δ∇**, then press **OK** or **PUSH JOG ▷**.

### 3 SELECT PICTURE CONTROL SET MODE

Place the pointer next to "PICTURE CONTROL" by pressing **PUSH JOG Δ∇**, then press **OK** or **PUSH JOG ▷** to select the desired mode.

**AUTO\***: Normally select "AUTO."

It automatically adjusts the picture quality.

\* When the B.E.S.T. function is set to "OFF" (ⓘ pg. 18), you can only select "NORM" instead of "AUTO."

**EDIT**: Select when you dub tapes.

**SOFT**: Select when you want to soften the picture.

**SHARP**: Select when you want to sharpen the picture.

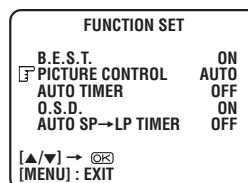

### NOTES:

- When you select "EDIT", "SHARP" or "SOFT", the selected mode will not change until you select again.
- When you select "EDIT" to dub tapes, be sure to select "AUTO" (or "NORM" when the B.E.S.T. function is set to "OFF") after you finish dubbing the tapes.

### 4 RETURN TO NORMAL SCREEN

Press **MENU**.

### NOTE:

Select **EDIT** when you are dubbing tapes. Refer to page 30, 31.

# Basic Recording

Turn on the TV and select the VIDEO channel (or AV mode).

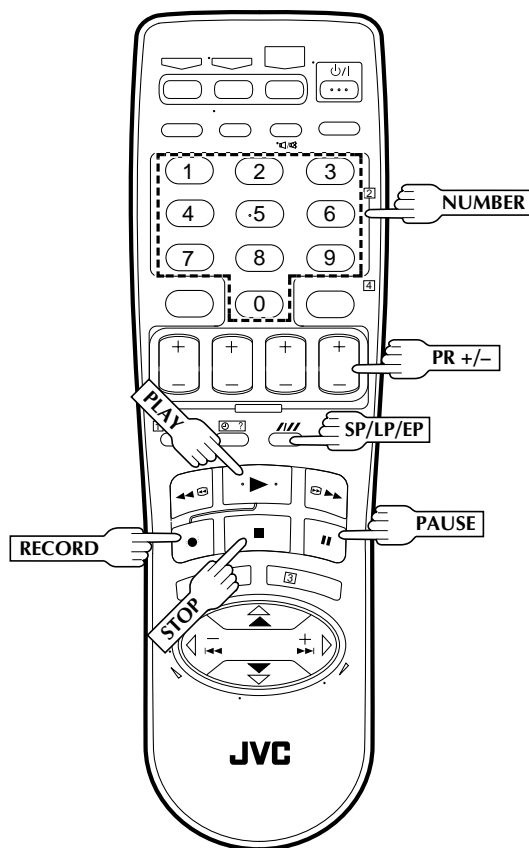
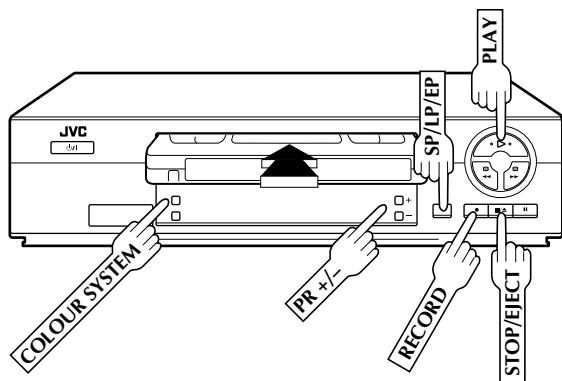

TV signals being received by the recorder's built-in tuner can be recorded onto a video tape. You can "capture" a TV programme using your video recorder.

1

## LOAD A CASSETTE

Insert a cassette with the record safety tab intact.

- The counter is reset to 0:00:00 and the recorder power comes on automatically.
- Select the appropriate colour system by pressing the **COLOUR SYSTEM** button (see pg. 32).

2

## CHOOSE A PROGRAMME

Press **PR +/-** or the **NUMBER** keys to select the channel you wish to record.

3

## SET TAPE SPEED

Press **SP/LP/EP** (//). Check the SP/LP/EP indicator on the recorder display panel to confirm the selected tape speed.

4

## START RECORDING

Press and hold **RECORD** and **PLAY** on the remote control, or press **RECORD** on the recorder.

B.E.S.T. takes place at the beginning of each first SP and first LP (or EP) recording after inserting the cassette (see pg. 18).

5

## PAUSE/RESUME RECORDING

Press **PAUSE**. Press **PLAY** to resume recording.

6

## STOP RECORDING

Press **STOP** on the remote control or **STOP/EJECT** on the recorder. Then press **STOP/EJECT** to remove the cassette.

## Recording Resume Function

If there is a power outage during recording (or Instant Timer Recording or timer recording), the recording will resume automatically when power is restored to the recorder unless the recorder's memory backup has expired.

### Accidental erasure prevention

- To prevent accidental recording on a recorded cassette, remove its safety tab. To record on it later, cover the hole with adhesive tape.

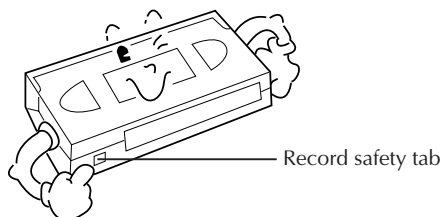



# Recording Features

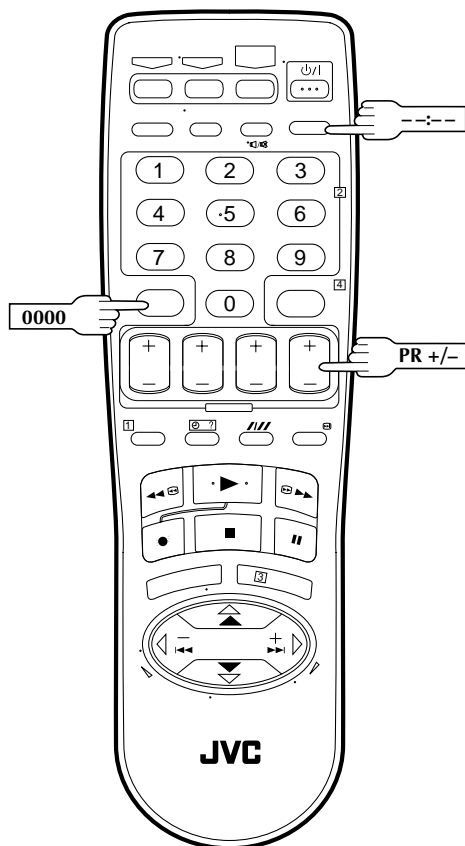
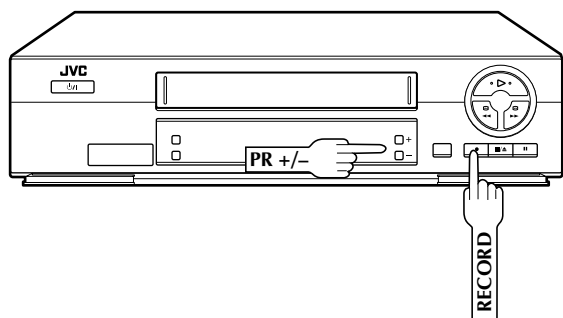

## Record One Programme While Watching Another

### 1 SELECT CHANNEL TO WATCH

Once recording is in progress, all you need to do is to set the channel controls on the TV for the station you wish to view.

- The programme selected with the TV's channel controls appears on the TV screen while the one selected with the **PR +/-** buttons is recorded on the tape.

## Elapsed Recording Time Indication

You can check the exact time of a recording.

### 1 SET COUNTER DISPLAY

Press **--:--** until a counter reading appears on the display panel.

- By pressing the **--:--** button, you can change the display to show the counter reading, channel position\*, clock time.  
\*Channel position is not displayed during playback.

### 2 RESET COUNTER

Press **0000** before starting recording or playback.

- The counter is reset to "0:00:00" and shows the exact elapsed time as the tape runs.

## Instant Timer Recording (ITR)

This easy method lets you record for from 30 minutes to 6 hours (selectable in 30-min. increments), and shuts the recorder off after recording is finished.

### 1 START RECORDING

Press **RECORD** on the recorder.

### 2 ENGAGE ITR MODE

Press **RECORD** again. "ⓘ" blinks and 0:30 appears on the front display panel.

### 3 SET RECORDING DURATION

If you want to record for more than 30 minutes, press **RECORD** to extend the time. Each press extends recording time by 30 minutes.

## NOTE:

You can only perform ITR using the **RECORD** button on the recorder's front panel.

# B.E.S.T. Picture System

Turn on the TV and select the VIDEO channel (or AV mode).

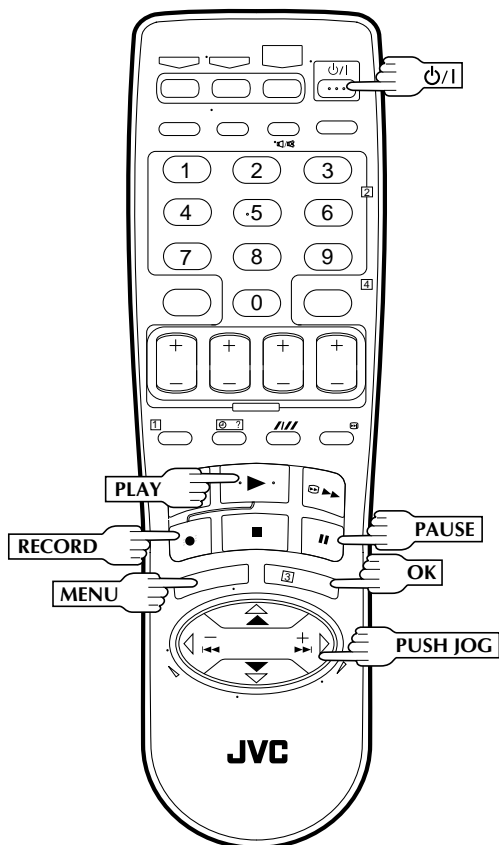
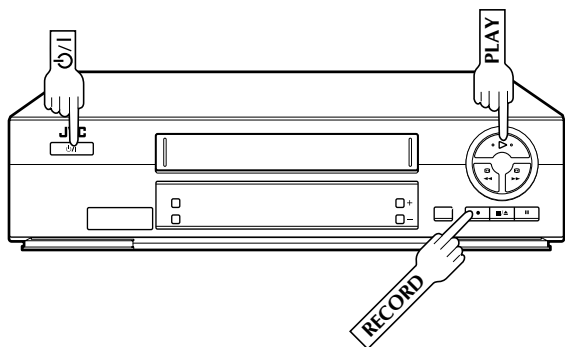

The B.E.S.T. (Biconditional Equalised Signal Tracking) system checks the condition of the tape in use during recording and playback, and compensates to provide the highest-possible recording and playback pictures. The default setting for both recording and playback is "ON".

## Preparation

### 1 TURN ON THE RECORDER

Press P/1.

### 2 ACCESS MAIN MENU SCREEN

Press MENU.

### 3 ACCESS FUNCTION SET SCREEN

Place the pointer next to "FUNCTION SET" by pressing **PUSH JOG**  $\Delta$  $\nabla$ , then press **OK** or **PUSH JOG**  $\triangleright$ .

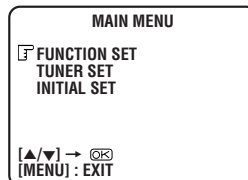

### 4 SELECT MODE

Place the pointer next to "B.E.S.T." by pressing **PUSH JOG**  $\Delta$  $\nabla$ , then press **OK** or **PUSH JOG**  $\triangleright$  to set to "ON" or "OFF".

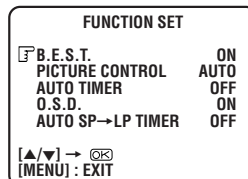

### 5 RETURN TO NORMAL SCREEN

Press MENU.

## Recording

1

### START RECORDING

Press and hold **RECORD** and press **PLAY** on the remote, or press **RECORD** on the recorder.

**DURING B.E.S.T.**

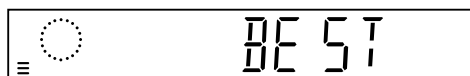

**B.E.S.T. COMPLETE**

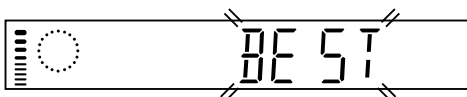

- The recorder spends approximately 7 seconds assessing the condition of the tape, then begins recording.

### NOTES:

- The B.E.S.T. system works for both SP and LP (or EP) modes only after a tape has been inserted and the Record mode is first initiated. It does not work during recording.
- In the case of timer recording, the B.E.S.T. system works before recording is initiated.
- Once the cassette is ejected, the B.E.S.T. data is cancelled. The next time the cassette is used for recording, B.E.S.T. is re-performed.
- Pressing the recorder's **RECORD** button while "BEST" is displayed does not start Instant Timer Recording (☞ pg. 17).

### ATTENTION

*Since the B.E.S.T. system works before recording actually starts, there is a delay of approximately 7 seconds after **RECORD** and **PLAY** on the remote are pressed, or **RECORD** on the recorder is pressed. To make sure you record the desired scene or programme in its entirety, first perform the following steps:*

- 1) Press and hold **PAUSE** and press **RECORD** to engage the **RECORD PAUSE** mode.
  - The recorder then automatically checks the condition of the tape and, after approximately 7 seconds, re-enters **RECORD PAUSE**.
- 2) Press **PLAY** to start recording.
  - If you want to bypass the B.E.S.T. system and begin recording immediately, set "B.E.S.T." to "OFF" in step 4 on page 18.

## Playback

The recorder assesses the quality of the tape once you initiate playback.

1

### START PLAYBACK

Press **PLAY**.

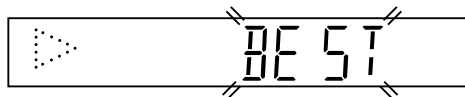

- The recorder adjusts the playback picture quality based on the quality of the tape in use.
- B.E.S.T. is active during Auto Tracking. "BEST" appears blinking on the recorder's display panel.

### NOTES:

- When watching a tape recorded with "B.E.S.T." set to "ON", it is recommended that you leave B.E.S.T. on during playback as well.
- When watching a rental tape or one recorded on another video recorder, or when using this recorder as the player for editing, set B.E.S.T. to your preference by performing steps 1 through 5 on page 18.
- "BEST" only appears at the beginning of automatic tracking. Even though it doesn't appear after that, the B.E.S.T. function is operative.

# Express Timer Programming

Remember, the clock must be set before you can programme the timer (see pg. 10).

Before performing the following steps:

- Insert a cassette with the safety tab in place. The recorder will come on automatically.
- Turn on the TV and select the VIDEO channel (or AV mode).
- Select the appropriate colour system by pressing the **COLOUR SYSTEM** button (see pg. 32).

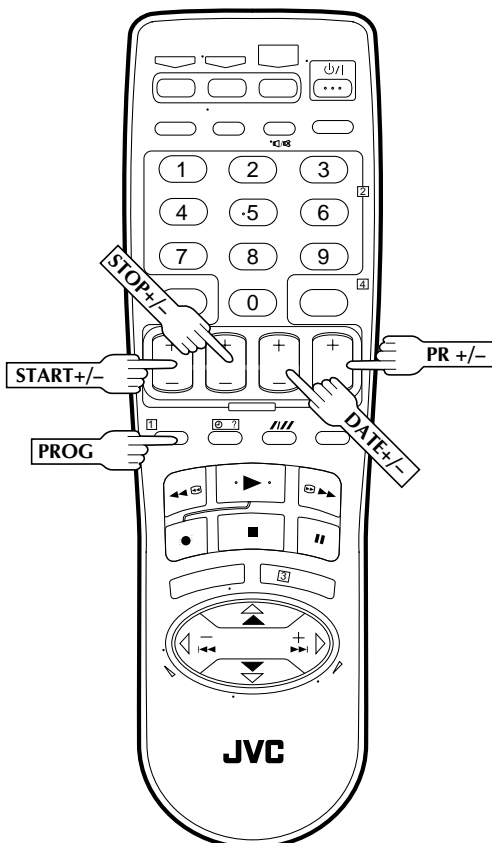
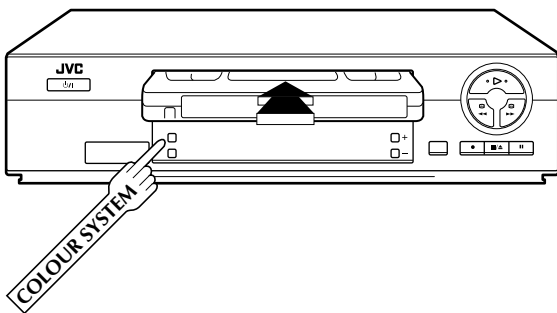

1

## ACCESS TIMER PROGRAMMING SCREEN

Press **PROG** (If you're just starting out, "P1" appears).

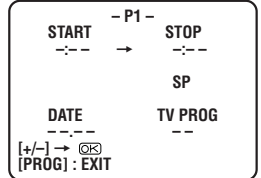

2

## ENTER PROGRAMME START TIME

Press **START +/-** to enter the time you want recording to start.

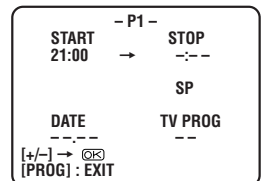

- Press and hold **START +/-** to move in 30-minute increments, or press and release repeatedly to move 1 minute at a time.

3

## ENTER PROGRAMME STOP TIME

Press **STOP +/-** to enter the time you want recording to stop.

- Press and hold **STOP +/-** to move in 30-minute increments, or press and release repeatedly to move 1 minute at a time.

4

## ENTER PROGRAMME DATE

Press **DATE +/-**. (The current date appears on screen. The date you enter appears in its place.)

5

## ENTER CHANNEL POSITION

Press **PR +/-**.

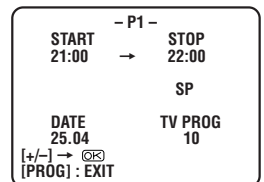

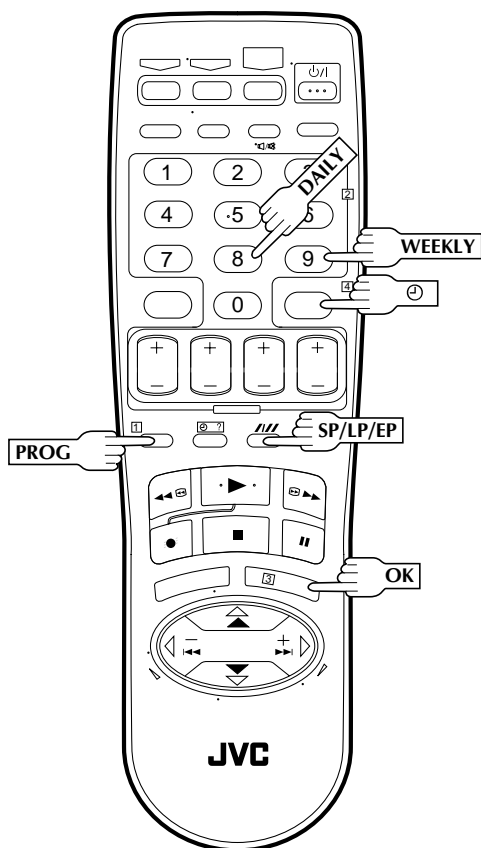
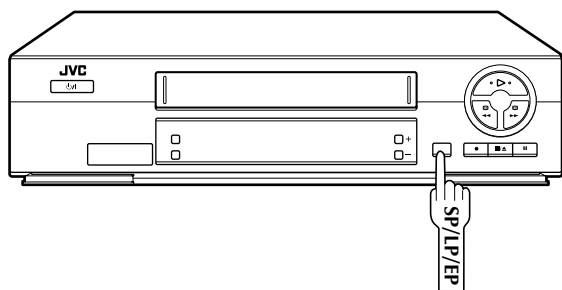

6

## SET TAPE SPEED

Press **SP/LP/EP** (//) to set the tape speed.

7

## RETURN TO NORMAL SCREEN

After confirming all information is correct, press **PROG** or **OK**. "PROGRAM COMPLETED" appears on the screen for about 5 seconds, then normal screen appears.

- Repeat steps 1 – 7 for each additional programme.

8

## ENGAGE RECORDER'S TIMER MODE

Press **⏸**. The recorder turns off automatically and "⏸" appears on the display panel.

- To disengage the timer, press **⏸** again.

*To Timer-Record Weekly Or Daily Serials . . .*

. . . anytime during steps 2 through 7, press **WEEKLY** (NUMBER key "9") for weekly serials or **DAILY** (NUMBER key "8") for daily serials (Monday–Friday). Either "WEEKLY" or "DAILY" appears on the screen. Pressing the button again makes the corresponding indication disappear.

*At the programme check screen*

When the weekly serials are programmed, a day of the week appears. When the daily serials are programmed, "DAILY" appears.

### NOTE:

*You can programme this recorder to timer-record as many as 8 programmes. If you try to programme the recorder to record a ninth, "PROGRAM FULL" appears on screen. To record the extra programme, you must first cancel any unnecessary programmes (☞ pg. 22).*

## Check, Cancel And Replace Programmes

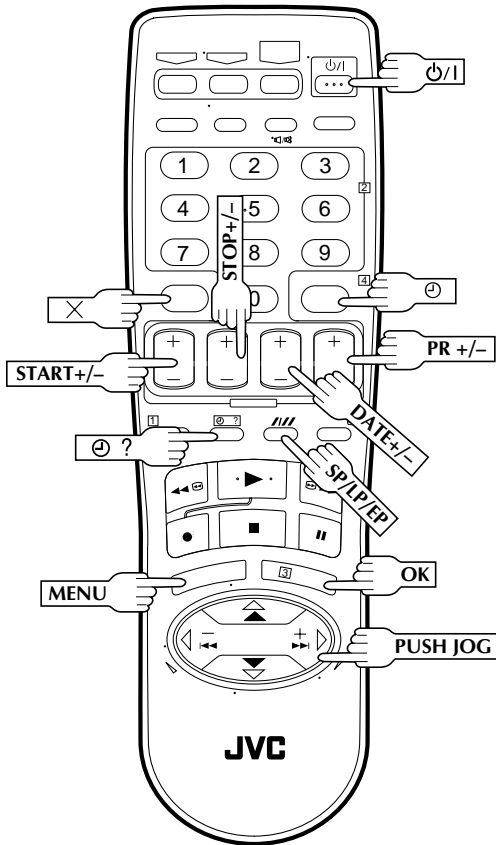

### 1 DISENGAGE TIMER MODE

Press **⏻**, then press **⏻/I**.

### 2 ACCESS PROGRAMME CHECK SCREEN

Press **⏻?**.

PR	START	STOP	CH	DATE
1	8:00	10:00	3	24.04
2	10:00	10:45	2	TUE
3	11:30	13:00	1	25.04
4				
5				
6				
7				
8				
[ ⏻? ] : NEXT				

### 3 ACCESS PROGRAMME SCREEN

Press **⏻?** again to check more information. Each time you press **⏻?**, the next programme's information appears.

START	- P1 -	STOP
8:00	→	10:00
		SP
DATE		TV PROG
24:04		3
[ ⏻? ] : NEXT		

## To cancel or replace a programme...

### 4 CANCEL OR REPLACE A PROGRAMME

Press **X** to cancel a programme. To replace a programme, press the appropriate button: **START+/-**, **STOP+/-**, **DATE+/-**, **PR+/-**, **SP/LP/EP (///)**.

### 5 RETURN TO NORMAL SCREEN

Press **⏻?** as many times as necessary. If there are still some programmes remaining, go on to step 6.

### 6 RETURN TO TIMER MODE

Press **⏻**.

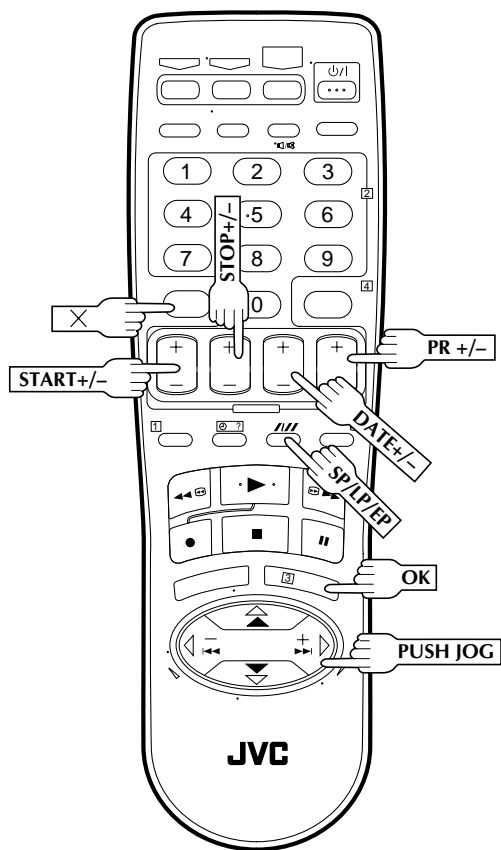

## When programmes overlap each other

If "PROGRAM OVERLAPPED" appears, you have another programme overlapping the programme you have just made. The Programme Check screen appears and conflicting programmes will start blinking.

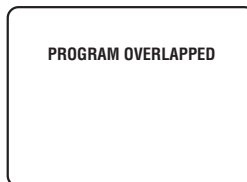

PR	START	STOP	CH	DATE
1	8:00	10:00	3	24.04
2	10:00	10:45	2	TUE
3	11:30	13:00	1	25.04
4	9:00	10:00	92	DAILY
5				
6				
7				
8				

[▲/▼] → [PROG] : EXIT

Example: Programme 1 (you have just made) and Programme 4 overlap each other.

### 1 CONFIRM THE OVERLAPPING PROGRAMMES

Overlapping programmes blink on the TV screen.

### 2 SELECT THE PROGRAMME TO MODIFY

Press **PUSH JOG**  $\triangle$ / $\nabla$ , then press **OK** or **PUSH JOG**  $\triangleright$ .

- You can only select one of the overlapping programmes.

#### NOTE:

If you do not mind this overlap, press **PROG** to finish the timer programme setting. The programme with the lower programme number will be recorded and the other one will not be recorded correctly. If no changes are made for approximately 1 minute, the recorder will return to the normal screen.

### 3 CANCEL OR CHANGE PROGRAMME SETTING

**To cancel a programme**, press  $\times$  when the Programme screen you do not want is shown. "PROGRAM COMPLETED" appears on the TV screen for about 5 seconds, then the normal screen appears. **To change a programme**, press the appropriate button: **START+/-**, **STOP +/-**, **DATE+/-**, **PR+/-** and/or **SP/LP/EP** (////) when the Programme screen on which you want to make changes is shown, then press **OK**. "PROGRAM COMPLETED" appears on the TV screen for about 5 seconds, then the normal screen appears.

#### NOTE:

If the overlap is not yet solved, or another overlap occurs with the timer programme setting after making the last correction on a programme, the conflicting programmes will be shown on the Programme Check screen again. Repeat the above steps again until the overlap is solved.

## Auto SP→LP Timer

If, when timer-recording in SP mode, there is not enough tape to record the entire programme, the recorder automatically switches to LP mode (with PAL broadcasts) or EP mode (with NTSC broadcasts) to allow complete recording.

### For Example . . .

Recording a PAL-broadcast programme of 210 minutes in length onto a 180-minute tape.

Approximately 150 minutes      Approximately 60 minutes

SP mode	LP mode
---------	---------

Total 210 minutes

Make sure you set "AUTO SP→LP TIMER" to "ON" at the Function Set screen before the timer-recording starts.

### 1 ACCESS MAIN MENU SCREEN

Press **MENU**.

### 2 ACCESS FUNCTION SET SCREEN

Press **PUSH JOG**  $\Delta \nabla$  to place the pointer next to "FUNCTION SET", then press **OK** or **PUSH JOG**  $\triangleright$ .

### 3 SELECT MODE

Press **PUSH JOG**  $\Delta \nabla$  to place the pointer next to "AUTO SP→LP TIMER", then press **OK** or **PUSH JOG**  $\triangleright$  to select "ON".

FUNCTION SET

B. E. S. T.	ON
PICTURE CONTROL	AUTO
AUTO TIMER	OFF
O. S. D.	ON
<input checked="" type="checkbox"/> AUTO SP→LP TIMER	ON

[▲/▼] → [OK] [MENU] : EXIT

### 4 RETURN TO NORMAL SCREEN

Press **MENU**.

## Auto Timer

When the Auto Timer is set to ON the timer is automatically engaged when the recorder power is turned off and automatically disengaged when the recorder is powered back on.

### 1 ACCESS MAIN MENU SCREEN

Press **MENU**.

### 2 ACCESS FUNCTION SET SCREEN

Press **PUSH JOG**  $\Delta \nabla$  to place the pointer next to "FUNCTION SET", then press **OK** or **PUSH JOG**  $\triangleright$ .

MAIN MENU

FUNCTION SET  
TUNER SET  
INITIAL SET

[▲/▼] → [OK] [MENU] : EXIT

### 3 SELECT MODE

Press **PUSH JOG**  $\Delta \nabla$  to place the pointer next to "AUTO TIMER", then press **OK** or **PUSH JOG**  $\triangleright$  to select either "ON" or "OFF".

FUNCTION SET

B. E. S. T.	ON
PICTURE CONTROL	AUTO
<input checked="" type="checkbox"/> AUTO TIMER	OFF
O. S. D.	ON
AUTO SP→LP TIMER	OFF

[▲/▼] → [OK] [MENU] : EXIT

### 4 RETURN TO NORMAL SCREEN

Press **MENU**.

### NOTE:

For safety, when Auto timer is set to "OFF", all other recorder functions are disabled while the Timer mode is engaged. To disengage the timer, press  $\text{⏏}$ .

### NOTES:

- If you have programmed the recorder to timer-record 2 or more programmes, the second programme and those thereafter may not fit on the tape if you set "AUTO SP→LP TIMER" to "ON". In this case, make sure the mode is not engaged, then set the tape speed manually during timer programming.
- In order to ensure that the recording fits on the tape, this feature may leave a slight non-recorded section at the end of the tape.
- There may be some noise and sound disturbance at the point on the tape where the recorder switches from SP to LP (or EP) mode.
- The Auto SP→LP Timer feature is not available during ITR (Instant Timer Recording), and the feature will not work properly with any tapes longer than E-180 or with some tapes of shorter lengths.



# Automatic Satellite Program Recording

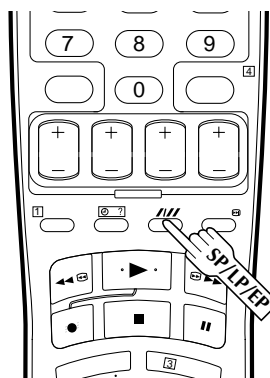
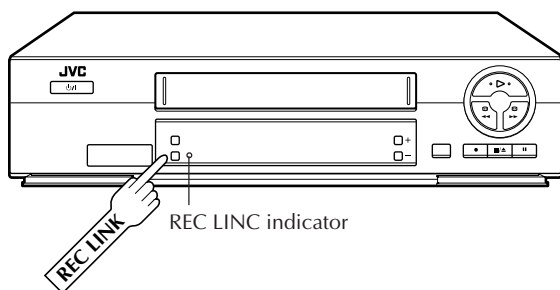

This facility allows you to automatically record a satellite program which is timer-programmed on your external satellite receiver. Connect a satellite receiver to the recorder's rear AUDIO/VIDEO IN connectors and program the timer on the satellite receiver; the recorder starts recording when the signals input from the satellite receiver to the rear AUDIO/VIDEO IN connectors, and when there is no input signals the recorder stops recording and the power shuts off.

## Before performing the following steps:

- Program the timer on the satellite receiver.
- Insert a cassette with the safety tab in place.

## 1 SET TAPE SPEED

Press **SP/LP/EP** to set the tape speed.

## 2 ENGAGE AUTO SATELLITE PROG REC MODE

Press and hold **REC LINK** for about 2 seconds. The REC LINK indicator lights up and the recorder turns off automatically.

- To disengage the Auto Satellite Prog Rec mode, press REC LINK. The REC LINK indicator goes off.
- If the recorder's power is off, it is not possible to engage the Auto Satellite Prog Rec mode.

## ATTENTION

- Be sure not to turn on the satellite receiver before the program is executed; otherwise, the recorder will start recording when the satellite receiver's power is turned on.
- If you have connected another appliance other than a satellite receiver to the rear AUDIO/VIDEO IN connectors, be sure not to engage the Auto Satellite Prog Rec mode; otherwise, the recorder will start recording when the connected appliance's power is turned on.
- Auto Satellite Prog recording and timer-recording cannot be done at the same time.

## NOTES:

- Auto Satellite Prog recording is only possible with the rear AUDIO/VIDEO IN connectors.
- When the Auto Satellite Prog Rec mode is engaged or the recorder's power is turned off after Auto Satellite Prog recording is finished, the recorder will not enter the Timer mode even though "AUTO TIMER" is set to "ON".
- For timer programming of the satellite receiver, refer to the instruction manual of the satellite receiver.
- Auto Satellite Prog recording is not possible if your satellite receiver does not have a timer.
- The **REC LINK** indicator blinks while Auto Satellite Prog recording is in progress.
- Pressing the recorder's  $\odot/1$  button while Auto Satellite Prog recording is in progress turns off and recorder's power and disengages the Auto Satellite Prog Rec mode.
- If there is more than one satellite program you wish to record with Auto Satellite Prog Recording, it is not possible to set a different tape speed for each; the tape speed selected in step 1 will apply to all the programs for Auto Satellite Prog recording.
- The B.E.S.T. ( pg. 18) does not work while Auto Satellite Prog recording is in progress.
- Depending on the type of satellite receiver, the recorder may not record a short portion at the beginning of the program or may record slightly longer than the actual length of the program.
- If you engage the Auto Satellite Prog Rec mode when the satellite receiver's power is on, the recorder will not start Auto Satellite Prog recording even though the **REC LINK** indicator blinks. When the satellite receiver shuts off once and is turned back on again, the recorder starts recording.
- You can also record a program from your cable system in the same way if the system has a timer and is connected to the recorder's rear AUDIO/VIDEO IN connectors.
- When you press the recorder's **REC LINK** button to engage the Auto Satellite Prog Rec mode, if the **REC LINK** indicator does not light but instead blinks quickly even though your satellite receiver's power is off, Auto Satellite Prog Recording will not work properly with that satellite receiver\*. If this is the case, perform "Express Timer Programming" ( pg. 20) to timer-record a satellite program.

\* Some satellite receivers output signals even if the power is off. Auto Satellite Prog Recording is not possible with those satellite receivers.

# Remote Control Functions

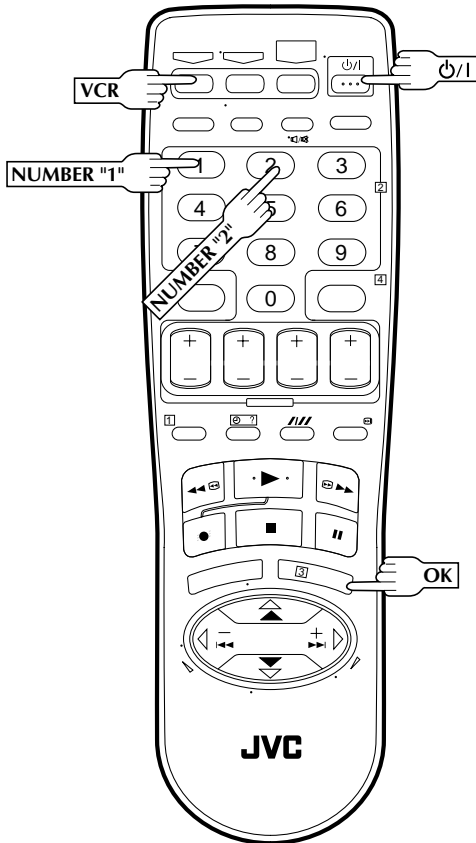

## Remote A/B Code Switching

The remote control is capable of controlling two JVC video recorders independently; one set to respond to the remote control's A code control signals and another set to respond to B code control signals. The remote control is preset to send A code signals because your video recorder is initially set to respond to A code signals. You can easily modify your video recorder to respond to B code signals.

### 1 REMOVE POWER SUPPLY

Unplug the mains power cord from the mains outlet.

### 2 SET REMOTE CONTROL CODE

While holding down **VCR** on the remote control, press the **NUMBER** key "2" and then press **OK**.

### 3 RE-SUPPLY POWER

Plug the mains power cord back into the mains outlet.

### 4 TURN THE RECORDER ON

Press **⏻/I** on the remote control. The recorder will now only respond to B code signals.

### NOTE:

To set the recorder back to respond to A code signals, repeat the same procedure as shown above except pressing **NUMBER** key "1" instead of "2" in step 2.

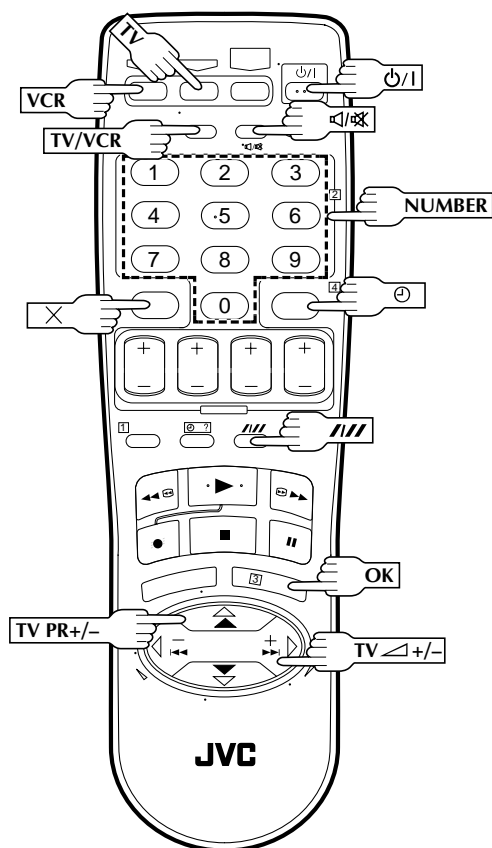

## TV Multi-brand Remote Control

Your remote control can operate the basic functions of your TV set. In addition to JVC TVs, other manufacturer's TVs can also be controlled.

Before you start . . .

- Turn on the TV using its remote control.

### 1 SET TV BRAND CODE

Refer to the chart below. While holding down **TV** on the recorder's remote control, enter your TV's brand code using the **NUMBER** keys, then press **OK**. Check if the TV's power goes off as it should. If it does, try other operations (☞ step 2).

- Once you have set the remote control to operate the TV, you don't have to repeat this step until you replace your remote control's batteries.
- Some TV brands have more than one code. If the TV does not function with one code, try entering another.

### 2 OPERATE TV

First, press **TV** to set the remote control to TV mode, then press the corresponding button: **☺/I**, **TV PR +/-**, **TV/VCR**, **TV**  $\triangle$  +/- (Volume), **🔇/🔊** (Muting), **NUMBER** keys.

- For some brands of TV, you must press **OK** after having pressed the **NUMBER** keys.

## IMPORTANT

Although the provided remote control unit is compatible with JVC televisions, as well as many other models, it may not work with your TV, or in some instances, may have limited function capability.

### ATTENTION

The remote control can operate not only the video recorder but also some of your TV's functions.

- To operate your video recorder, first press the **VCR** button to set the remote control to the Video mode.
- To operate your TV, first press the **TV** button to set the remote control to the TV mode.
- To operate your satellite receiver, cable box or DVD, first press the **CABLE/SAT/DVD** to set the remote control to the satellite receiver, cable box or DVD mode.

### Control Your TV Using Additional Buttons

Use the **NUMBER** keys, and the **///** button, **X** button or **☺** button to select the TV's channel.

- With televisions under Code 01, 02, 07, 08, 10, 11, 14, 20, 22, 23, 24, 25, 27, 33, 35, 38, 40 or 42, the **///** button corresponds to the 1-digit/2-digit entry switching button (often labelled - / -) of your TV's remote control.
- With televisions under Code 01, 16, 28, 29, 34 or 39, the **X** button corresponds to the 10 + button, and the **☺** button corresponds to the 20 + button of your TV's remote control.

### NOTE:

The way these buttons are used is determined by your TV. Use these buttons as instructed for your TV's remote control.

TV BRAND NAME	CODE
JVC	01, 23, 24, 25
AIWA	36
BEIJING	22
CCE	02
CHANGHONG	34
DAEWOO	17, 37
FERGUSON	27
FINLUX	30
FUNAI	32
GRADIENTE	15
GRUNDIG	19
HITACHI	10
ITT	28
JINXING	38
KONKA	40
LG/GOLDSTAR	18
MITSUBISHI	03
MIVER	29
NEC	20
NOBLEX	22
NOKIA	31
PANASONIC	04, 11
PEONY	34, 38, 39
PHILICO	10, 17, 21
PHILIPS	02, 42
SAMSUNG	12, 33, 34, 35
SANYO	13, 16
SHARP	06
SONY	07
TCL	41
THOMSON	26
TOSHIBA	08, 14

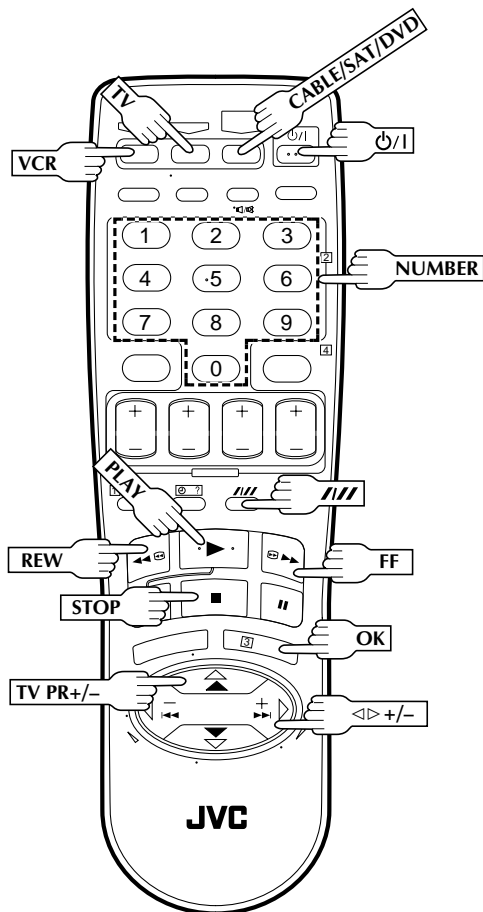

## ATTENTION

The remote control can operate not only the video recorder but also some of your TV, cable box, satellite receiver and DVD.

- To operate your video recorder, first press the **VCR** button to set the remote control to the Video mode.
- To operate your TV, first press the **TV** button to set the remote control to the TV mode.
- To operate your satellite receiver, cable box or DVD, first press the **CABLE/SAT/DVD** to set the remote control to the satellite receiver, cable box or DVD mode.

## Multi-brand Remote Control

For satellite receiver, cable box and DVD

Your remote control can operate the basic functions of your satellite receiver, cable box or DVD.

Before you start . . .

- Turn on the satellite receiver, cable box or DVD using its remote control.

## 1 SET BRAND CODE

Refer to the chart below. While holding down **CABLE/SAT/DVD** on the recorder's remote control, enter one of the brand code corresponding to the make of your unit using the **NUMBER** keys, then press **OK**. Check if the unit's power goes off as it should. If it does, try other operations (☞ step 2).

- Once you have set the remote control to operate the unit, you don't have to repeat this step until you replace your remote control's batteries.
- Some brands have more than one code. If the unit does not function with one code, try entering another.

## 2 OPERATE UNIT

First, press **CABLE/SAT/DVD** to set the remote control to unit mode, then press the corresponding button:

For satellite receiver and cable box . . .  
 ⏻, TV PR +/-, NUMBER keys.

For DVD . . .  
 ⏻, PLAY, STOP, PAUSE, FF, REW,  
 ⏪ (⏩) keys.

- For some brands of unit, you must press **OK** after having pressed the **NUMBER** keys.

## IMPORTANT

Although the provided remote control unit is compatible with JVC satellite receiver and DVD, as well as many other models, it may not work with your unit, or in some instances, may have limited function capability.

## NOTES:

- It's not possible to set the two units at the same time. You can only set the remote control to operate one of these units at a time.
- You have to subscribe to a satellite or cable service to receive satellite or cable channels.

## Cable Box or Satellite Receiver Multi-brand Code

CABLE BOX BRAND NAME	CODE
JVC	72, 73,
AMSTRAD	60, 61, 62, 63, 92
BT	72
CANAL+	81
CANAL SATELLITE	81
D-box	85
ECHOSTAR	51, 78, 79, 80, 82
FINLUX	68
GALAXIS	69, 88
GRUNDIG	64, 65
HIRSCHMANN	64
ITT	68
JERROLD	01, 04, 06, 11, 12, 15, 28, 75
KATHREIN	70, 71
LUXOR	68
MASPRO	70
NOKIA	68, 87
PACE	67, 86, 92
PANASONIC	13, 14, 74
PFT	69
PHILIPS	66, 84
PHONOTREND	69
SALORA	68
SKYMASTER	69
TPS	83
VIDEOWAY	03, 09, 22, 76, 77
WISI	64

## DVD Multi-brand Code

DVD BRAND NAME	CODE
JVC	55
MATSUSHITA	58
PHILIPS	56
TOSHIBA	57

# Edit To Or From Another Video Recorder

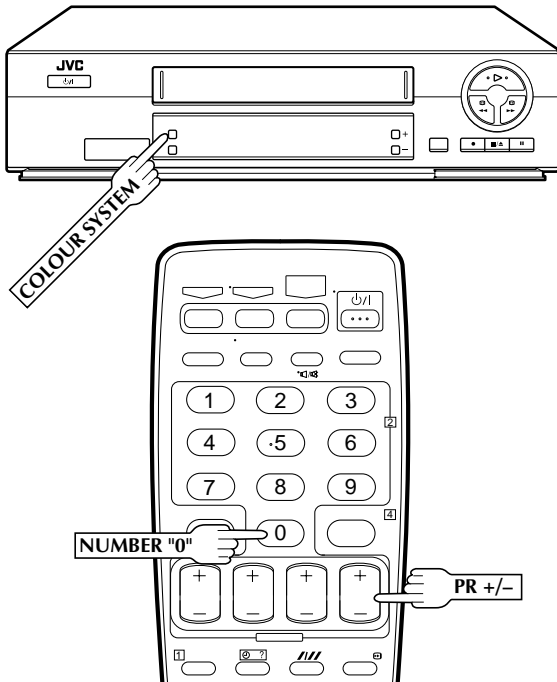

## IMPORTANT:

- To edit, both the player and the recorder must be of the same colour system. Press your recorder's **COLOUR SYSTEM** button to select the appropriate colour system.
- For more information on multi-system compatibility, see pg. 32.

You can use your video recorder as the source player or the recording deck.

## 1 MAKE CONNECTIONS

Connect the player's AUDIO/VIDEO OUT connector to the recorder's AUDIO/VIDEO IN connector.

- Use the L connector for monaural connection.

## 2 SET RECORDING DECK'S INPUT MODE

Set to AUX. With this video recorder, press **NUMBER** key "0" and/or **PR +/-** to "L-1".

## 3 SELECT "EDIT" FOR PICTURE CONTROL SET MODE

Follow the "Picture Control" section on page 15, then select "EDIT."

## 4 START SOURCE PLAYER

Engage its Play mode.

## 5 START RECORDING DECK

Engage its Record mode.

## NOTES:

- All necessary cables can be obtained from your dealer.
- When you use this recorder as the player for editing, be sure to set "O.S.D." to "OFF" before starting (see pg. 8).
- NTSC tapes being played back in the NTSC → PAL mode (see pg. 33) cannot be dubbed to another recorder.
- When you dub an NTSC tape using your recorder as the playback deck, select NTSC 3.58 (or NTSC 4.43) with the **COLOUR SYSTEM** button (see pg. 32).
- When you select "EDIT" to dub tapes, be sure to select "AUTO" (or "NORM" when the B.E.S.T. function is set to "OFF") after you finish dubbing the tapes (see pg. 15).

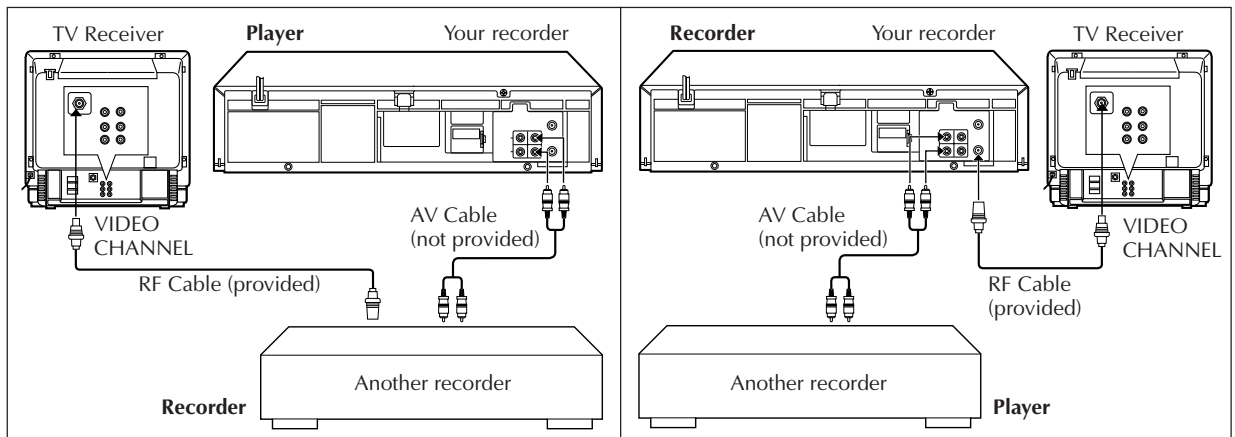

# Edit From A Camcorder

You can use a camcorder as the source player and your video recorder as the recorder.

## 1 MAKE CONNECTIONS

Connect the camcorder's AUDIO/VIDEO OUT connectors to the recorder's rear panel AUDIO/VIDEO input connectors.

- Use the L connector for monaural connection.

## 2 SET RECORDER'S INPUT MODE

Press **NUMBER** key "0" and/or **PR +/-** so that "L-1" appears on the display panel.

## 3 SELECT "EDIT" FOR PICTURE CONTROL SET MODE

Follow the "Picture Control" section on page 15, then select "EDIT."

## 4 START CAMCORDER

Engage its Play mode.

## 5 START RECORDER

Engage its Record mode.

### NOTES:

- All necessary cables can be obtained from your dealer.
- You can also use another video recorder as the player instead of a camcorder.
- When you select "EDIT" to dub tapes in step 3, be sure to select "AUTO" (or "NORM" when B.E.S.T. is set to "OFF") after you finish dubbing the tapes (☞ pg. 15).

### IMPORTANT:

- To edit, both the player and the recorder must be of the same colour system. Press your recorder's **COLOUR SYSTEM** button to select the appropriate colour system.
- PAL, SECAM and NTSC camcorders can be used as a player for editing.
- For more information on multi-system compatibility, ☞ pg. 32.

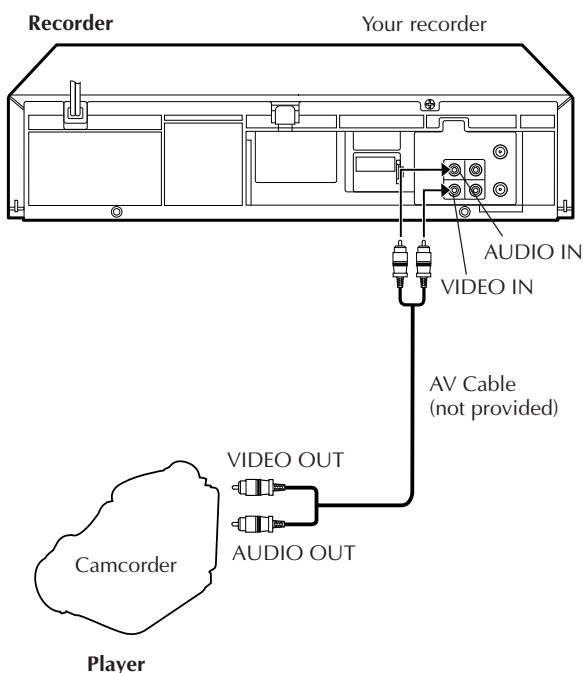
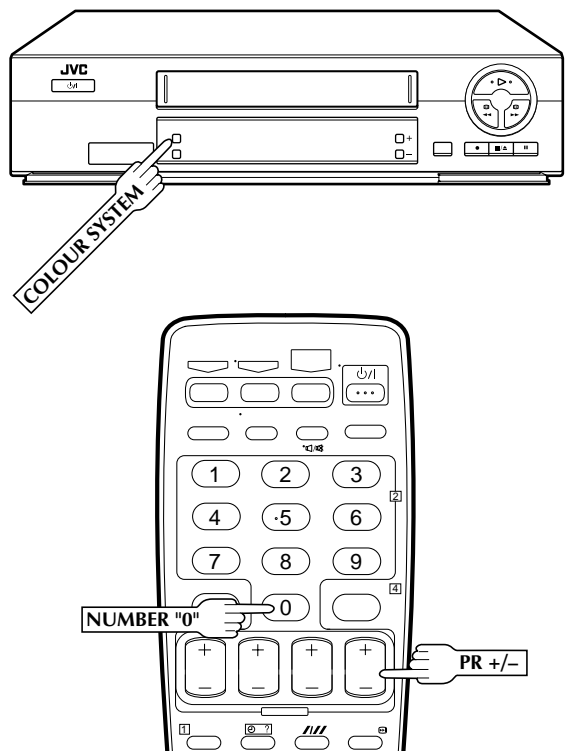

## Setting Of The Colour System Select Buttons

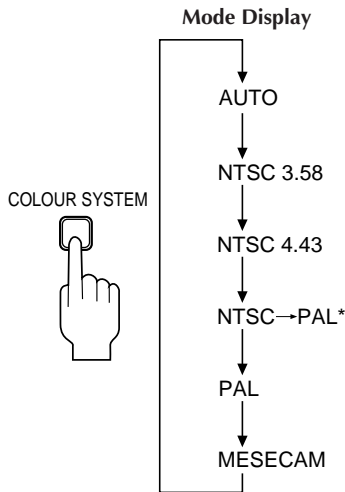

Use the **COLOUR SYSTEM** button on the front panel to select the colour system. Pressing the **COLOUR SYSTEM** displays the current setting on the screen. While the current setting is displayed, press **COLOUR SYSTEM** again to change the mode as illustrated on the left. The On-Screen display will show which mode is selected.

Mode	Description
AUTO	Usually set to this mode. This mode automatically detects PAL, NTSC, SECAM or MESECAM and adjusts to the colour system being recorded or played back. When it does not perform properly, set the colour system manually.
MANUAL	For recording, there is a choice of 4 selectable modes; PAL/MESECAM/NTSC 3.58/NTSC4.43. Select the mode that matches the colour signal being received. For playback, there is an additional mode which allows NTSC tapes to be played back and viewed on PAL TVs.

\* "NTSC->PAL" appears during playback only.

### NOTES:

- In the **AUTO** mode, **NTSC** signals will be automatically recorded as **NTSC 3.58**.
- In the **AUTO** mode, **NTSC** tapes will be played back as **NTSC 3.58**.
- **SECAM** signals will always be recorded as **MESECAM**. Select the **AUTO** or the **MESECAM** mode when recording **SECAM** signals.
- When playing back a **SECAM** tape, select the **AUTO** or **MESECAM** mode. The playback picture will always be monochrome.
- In the **NTSC4.43** mode, with some TVs, on-screen displays (Program screen etc.) may roll up or down and there may be a loss of colour. When this happens, select the **AUTO** mode.

## Off-Air Recording

The built-in multi-system tuner is capable of receiving PAL B/G, I and D/K, and SECAM B/G and D/K broadcasts.

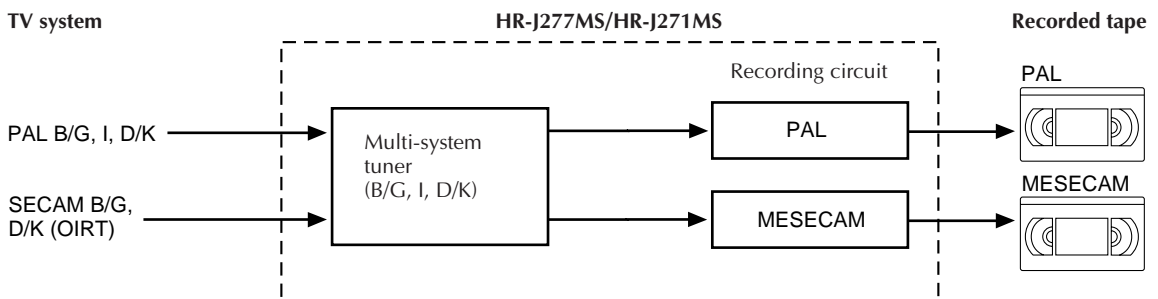

### NOTE:

This model does not operate in **BRAZIL (PAL-M)** or **ARGENTINA (PAL-N)**.



## Playback

This recorder can play back all 3 types of recorded tape.

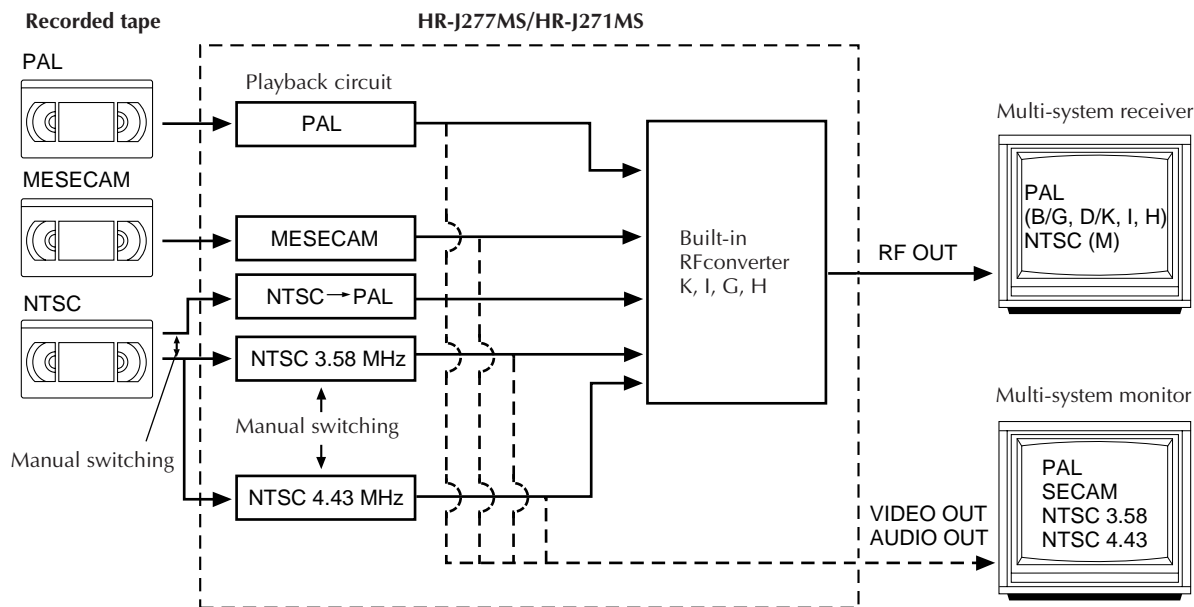

### NOTES:

When viewing NTSC tapes on a PAL TV set:

- The picture may shrink vertically with black bars appearing at the top and bottom of the screen. This is not a malfunction on the part of the video recorder nor the TV.
- The picture may roll up or down. This can be corrected using the V-HOLD control found on some TVs. (This cannot be corrected if the TV does not have a V-HOLD control.)
- During search, still, or frame-by-frame playback, the picture will be distorted, and there may be a loss of colour.

### ATTENTION:

When this recorder is connected to a multi-system TV, the audio signal may not be heard or may be noisy if the colour system select switch of the TV is adjusted to the AUTO position. In such a case, set the TV's colour system select switch to the appropriate position which corresponds to the TV system you have selected at the TV System Select screen.

## Tape-To-Tape Editing

There are 4 different types of recorded tape, depending on the signal recorded.

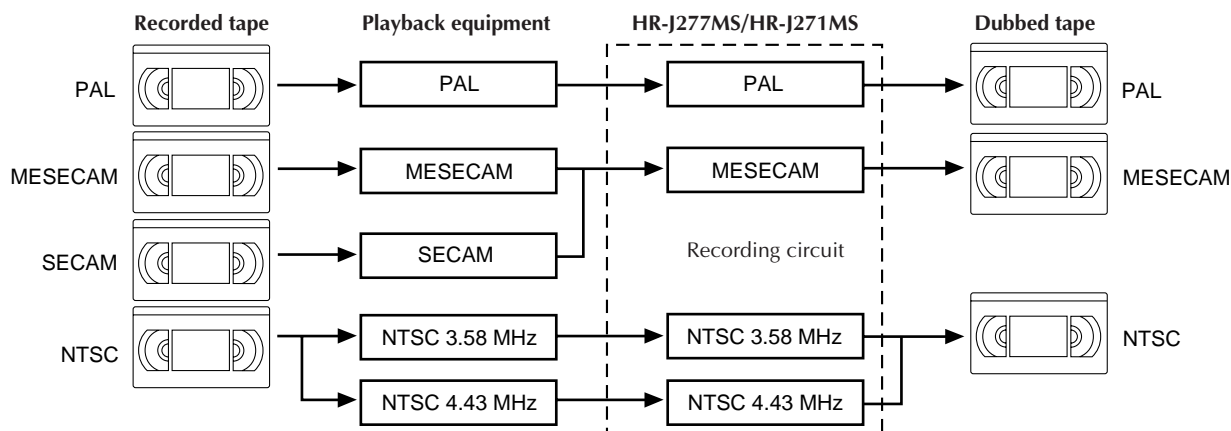

Turn on the TV and select the VIDEO channel (or AV mode).

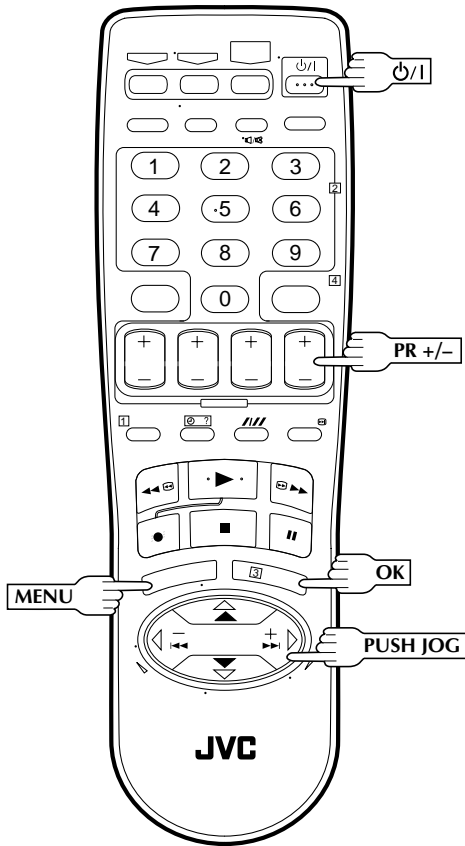

## IMPORTANT

Perform the following steps only if auto channel set has not been set correctly by Auto Set Up function (see pg. 6) or if you have moved to a different area or if a new station starts broadcasting in your area.

Your recorder needs to memorise all necessary stations in channel positions in order to record TV programmes. Auto Channel Set automatically assigns all receivable stations in your area so that you can call them up with the **PR +/-** buttons without going through any vacant channels.

## Auto Channel Set

### TURN ON THE RECORDER

Press **⏻/I**.

### ACCESS MAIN MENU SCREEN

Press **MENU**.

### ACCESS TUNER SET SCREEN

Press **PUSH JOG**  $\Delta \nabla$  to place the pointer next to "TUNER SET", then press **OK** or **PUSH JOG**  $\triangleright$ .

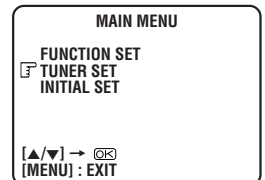

### SELECT AUTO CH SET MODE

Press **PUSH JOG**  $\Delta \nabla$  to place the pointer next to "AUTO CH SET", then press **OK** or **PUSH JOG**  $\triangleright$ .

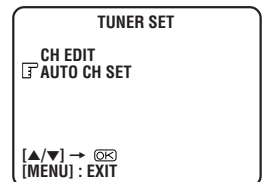

## 5 SELECT TV SYSTEM

Press **PUSH JOG**  $\Delta \nabla$  to place the pointer next to the appropriate TV system (refer to the table on page 7), then press **OK** or **PUSH JOG**  $\triangleright$ .

- Auto Channel Set will start.

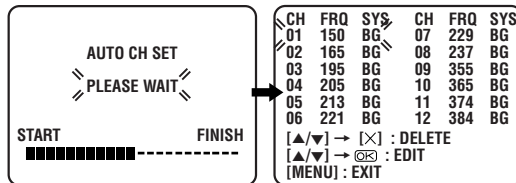
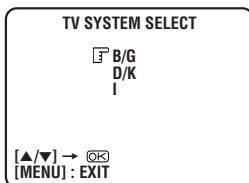

## 6 RETURN TO NORMAL SCREEN

Press **MENU**.

### IMPORTANT

- If no sound accompanies the picture or the audio sounds unnatural on some channels that have been stored by Auto Channel Set, the TV system setting for those channels may be incorrect. Select the appropriate TV system for those channels.  $\rightarrow$  "TV System Selection – When you see the picture but the audio can't be heard or sounds unnatural" on page 37.
- Since your video recorder memorizes all detected stations even if the reception condition is poor, some of those stored stations may produce a noisy picture. To delete those stations,  $\rightarrow$  "Delete A Channel" on page 36.

Major Countries/Areas	TV System
Australia, New Zealand, Kuwait, U.A.E., Indonesia, Singapore, Thailand, Malaysia, Iran, Saudi Arabia, Egypt, Morocco, Lebanon, Iraq	B/G
China, Mongolia, Russia	D/K
Hong Kong	I

## Manual Channel Set

Store channels that were not stored during Auto Set Up ( $\rightarrow$  pg. 6) or Auto Channel Set ( $\rightarrow$  pg. 34).

## 1 ACCESS TUNER SET SCREEN

Perform steps 1 – 3 of "Auto Channel Set" on page 32.

## 2 ACCESS CHANNEL LIST

Press **PUSH JOG**  $\Delta \nabla$  to place the pointer next to "CH EDIT", then press **OK** or **PUSH JOG**  $\triangleright$ .

## 3 SELECT POSITION

Press **PUSH JOG**  $\Delta \nabla$  to place the pointer next to an open channel position, then press **OK** or **PUSH JOG**  $\triangleright$ .

## 4 SELECT BAND

Press **PUSH JOG**  $\Delta \nabla$  to place the pointer next to the band of your choice, then press **OK** to initiate Manual Channel Set.

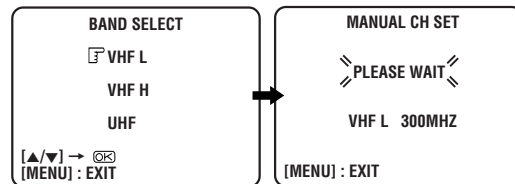

## 5 SET DESIRED STATION

The screen to the right appears when a station is detected.

*If you do not want to store the detected station...*

Press **PUSH JOG**  $\Delta \nabla$  to place the pointer next to "CONTINUE", then press **OK** or **PUSH JOG**  $\triangleright$ .

Channel search will resume.

*If you want to store the detected station...*

Press **PUSH JOG**  $\Delta \nabla$  to place the pointer next to "STORE", then press **OK** or **PUSH JOG**  $\triangleright$ . The Channel List appears again.

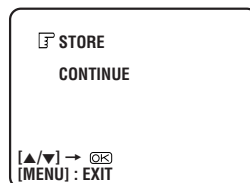

- The blueback screen and the TV picture currently being broadcast appear alternately for 8 seconds each.
- If you want to store another channel, repeat steps 3 – 5.
- When channel search completes for that band, the Band Select screen appears again. To set channels for other bands, select another band and start Manual Channel Set again ( $\rightarrow$  step 4 and 5).
- For fine tuning adjustment, see "Fine-Tuning Channels" on page 37.

## 6 RETURN TO NORMAL SCREEN

Press **MENU**.

## Delete A Channel

**1** ACCESS TUNER SET SCREEN

Perform steps 1 – 3 of "Auto Channel Set" on page 34.

**2** ACCESS CHANNEL LIST

Press **PUSH JOG**  $\Delta \nabla$  to place the pointer next to "CH EDIT", then press **OK** or **PUSH JOG**  $\triangleright$ .

**3** SELECT CHANNEL

Press **PUSH JOG**  $\Delta \nabla$  to until the channel you want to delete begins blinking.

CH	FRQ	SYS	CH	FRQ	SYS
01	150	BG	07	229	BG
02	165	BG	08	237	BG
03	195	BG	09	355	BG
04	205	BG	10	365	BG
05	213	BG	11	374	BG
06	221	BG	12	384	BG

[ $\Delta$ / $\nabla$ ]  $\rightarrow$  [X]: DELETE  
 [ $\Delta$ / $\nabla$ ]  $\rightarrow$  [OK]: EDIT  
 [MENU]: EXIT

**4** DELETE CHANNEL

Press X.

- To re-store it, simply press **PUSH JOG**  $\triangleleft$ .
- Repeat steps 3 – 4 as necessary.

CH	FRQ	SYS	CH	FRQ	SYS
01	---	--	07	229	BG
02	165	BG	08	237	BG
03	195	BG	09	355	BG
04	205	BG	10	365	BG
05	213	BG	11	374	BG
06	221	BG	12	384	BG

[ $\Delta$ / $\nabla$ ]  $\rightarrow$  [ $\triangleleft$ ]: ADD  
 [MENU]: EXIT

**5** RETURN TO NORMAL SCREEN

Press **MENU**.

## Swap Channel Positions

Example: To swap CH03 and CH09.

**1** ACCESS TUNER SET SCREEN

Perform steps 1 – 3 of "Auto Channel Set" on page 32.

**2** ACCESS CHANNEL LIST

Press **PUSH JOG**  $\Delta \nabla$  to place the pointer next to "CH EDIT", then press **OK** or **PUSH JOG**  $\triangleright$ .

**3** SELECT POSITION (e.g. 03)

Press **PUSH JOG**  $\Delta \nabla$  until the section of CH "03" begins blinking, then press **OK** or **PUSH JOG**  $\triangleright$ .

CH	FRQ	SYS	CH	FRQ	SYS
01	150	BG	07	229	BG
02	165	BG	08	237	BG
03	195	BG	09	355	BG
04	205	BG	10	365	BG
05	213	BG	11	374	BG
06	221	BG	12	384	BG

[0 – 9]: INPUT CH  
 [OK]: FINE TUNING  
 [MENU]: EXIT

- Only "03" will blink.

**4** SELECT POSITION (e.g. 09)

Press **NUMBER** keys to input "0" and "9".

CH	FRQ	SYS	CH	FRQ	SYS
01	150	BG	07	229	BG
02	165	BG	08	237	BG
03	355	BG	09	195	BG
04	205	BG	10	365	BG
05	213	BG	11	374	BG
06	221	BG	12	384	BG

[ $\triangleleft$ ]: CANCEL  
 [OK]: OK  
 [MENU]: EXIT

- The two selected channels will be swapped.
- To cancel the channel swapping, press **PUSH JOG**  $\triangleleft$ .

**5** STORE NEW POSITIONS

Press **OK** or **PUSH JOG**  $\triangleright$ .

- Repeat steps 3 – 5 as necessary.

**6** RETURN TO NORMAL SCREEN

Press **MENU**.

## Fine-Tuning Channels

**1** Perform steps 1 – 3 of "Auto Channel Set" on page 32.

### ACCESS CHANNEL LIST

**2** Press **PUSH JOG**  $\Delta\nabla$  to place the pointer next to "CH EDIT", then press **OK** or **PUSH JOG**  $\triangleright$ .

### SELECT CHANNEL TO FINE-TUNE

**3** Press **PUSH JOG**  $\Delta\nabla$  until the channel you want to tune begins blinking, then press **OK** twice.

- The "FRQ" number for that channel starts blinking.

CH	FRQ	SYS	CH	FRQ	SYS
01	150	BG	07	229	BG
02	165	BG	08	237	BG
03	195	BG	09	355	BG
04	205	BG	10	365	BG
05	213	BG	11	374	BG
06	221	BG	12	384	BG

[ $\Delta$ / $\nabla$ ] : FINE TUNING  
 [OK] : SELECT SYSTEM  
 [MENU] : EXIT

### PERFORM TUNING

**4** Press **PUSH JOG**  $\Delta\nabla$  until the picture becomes clearer, then press **OK** or **PUSH JOG**  $\triangleright$ .

- Repeat steps 3 and 4 as necessary.

### RETURN TO NORMAL SCREEN

**5** Press **MENU**.

## TV System Selection – When you see the picture but the audio can't be heard or sounds unnatural

### ACCESS TUNER SET SCREEN

**1** Perform steps 1 – 3 of "Auto Channel Set" on page 32.

### ACCESS CHANNEL LIST

**2** Press **PUSH JOG**  $\Delta\nabla$  to place the pointer next to "CH EDIT", then press **OK** or **PUSH JOG**  $\triangleright$ .

### SELECT CHANNEL

**3** Press **PUSH JOG**  $\Delta\nabla$  until the channel you want to change its TV system begins blinking, then press **OK** three times.

- The "SYS" display for that channel starts blinking.

CH	FRQ	SYS	CH	FRQ	SYS
01	150	BG	07	229	BG
02	165	BG	08	237	BG
03	195	BG	09	355	BG
04	205	BG	10	365	BG
05	213	BG	11	374	BG
06	221	BG	12	384	BG

[ $\Delta$ / $\nabla$ ] : SELECT SYSTEM  
 [OK] : OK  
 [MENU] : EXIT

### SELECT TV SYSTEM

**4** Press **PUSH JOG**  $\Delta\nabla$  to select the appropriate TV system (BG  $\rightarrow$  DK  $\rightarrow$  I). Then press **OK** or **PUSH JOG**  $\triangleright$ .

- Repeat steps 3 and 4 as necessary.

### RETURN TO NORMAL SCREEN

**5** Press **MENU**.

Before requesting service for a problem, use this chart and see if you can repair the trouble yourself. Small problems are often easily corrected, and this can save you the trouble of sending your video recorder off for repair.

## POWER

SYMPTOM	POSSIBLE CAUSE	CORRECTIVE ACTION
1. No power is applied to the recorder.	<ul style="list-style-type: none"> <li>The mains power cord is disconnected.</li> </ul>	Connect the mains power cord.
2. The clock is functioning properly, but the recorder cannot be powered.	<ul style="list-style-type: none"> <li>"⊖" is displayed on the display panel with Auto Timer set to "OFF".</li> </ul>	Press the ⊖ button to turn the "⊖" indicator off.
3. The remote control won't function.	<ul style="list-style-type: none"> <li>The batteries are discharged.</li> </ul>	Replace the dead batteries with new ones.

## TAPE TRANSPORT

SYMPTOM	POSSIBLE CAUSE	CORRECTIVE ACTION
1. The tape does not run during recording.	<ul style="list-style-type: none"> <li>"⏏" is displayed on the display panel.</li> </ul>	Press <b>PLAY</b> to turn the "⏏" indicator off.
2. The tape will not rewind or fast-forward.	<ul style="list-style-type: none"> <li>The tape is already fully rewound or fast-forwarded.</li> </ul>	Check the cassette.

## PLAYBACK

SYMPTOM	POSSIBLE CAUSE	CORRECTIVE ACTION
1. The playback picture does not appear while the tape is running.	<ul style="list-style-type: none"> <li>If you're using the RF OUT connection . . . . . the TV receiver's channel selector is not set to the VIDEO channel. . . . the recorder's VIDEO channel has not been correctly set.</li> <li>If you're using the AV connection, the TV receiver is not set to the AV mode.</li> </ul>	<p>If you are using the RF OUT connection . . . . . set the TV receiver to the VIDEO channel. (☞ pg. 4)</p> <p>. . . Perform "Video Channel Set" (☞ pg. 4)</p> <p>If you are using the AV connection, set the TV to its AV mode.</p>
2. Noise appears during visual search.	<ul style="list-style-type: none"> <li>This is normal.</li> </ul>	
3. Noise appears during normal playback.	<ul style="list-style-type: none"> <li>The automatic tracking mode is engaged.</li> </ul>	Try manual tracking. (☞ pg. 13)
4. Noise appears during slow-motion playback.	<ul style="list-style-type: none"> <li>The automatic tracking mode is engaged.</li> </ul>	Try manual tracking. (☞ pg. 13)
5. Noise appears during still playback.		Press <b>PR +</b> or <b>-</b> a few times to remove the noise bars from the screen.
6. The playback picture is blurred or interrupted while TV broadcasts are clear.	<ul style="list-style-type: none"> <li>The video heads may be dirty.</li> </ul>	Use a dry cleaning cassette TCL-2UX or consult your JVC dealer.
7. Playback picture has a loss of colour.	<ul style="list-style-type: none"> <li>The wrong colour system is selected for the tape being played back.</li> <li>The wrong colour system was selected during recording.</li> </ul>	<p>Select the correct colour system by pressing the <b>COLOUR SYSTEM</b> button. (☞ pg. 32)</p> <p>Once recorded, the signal cannot be corrected. Be sure to choose the correct setting before recording.</p>
8. No sound accompanies the playback picture.	<ul style="list-style-type: none"> <li>The TV system you have selected at the TV System Select screen is incorrect.</li> </ul>	Set it to the correct position for the TV broadcast system used in your area. (☞ pg. 37)

## RECORDING

SYMPTOM	POSSIBLE CAUSE	CORRECTIVE ACTION
1. Recording cannot be started.	<ul style="list-style-type: none"> <li>There is no cassette loaded, or the cassette loaded has had its Record Safety tab removed.</li> </ul>	Insert a cassette, or using adhesive tape, reseal the slot where the tab was removed.
2. TV broadcasts cannot be recorded.	<ul style="list-style-type: none"> <li>"L-1" has been selected as the input mode.</li> </ul>	Set to the desired channel.
3. Tape-to-tape editing is not possible.	<ul style="list-style-type: none"> <li>The source (another video recorder, camcorder) has not been properly connected.</li> <li>All necessary power switches have not been turned on.</li> <li>The input mode is not correct.</li> </ul>	<p>Confirm that the source is properly connected.</p> <p>Confirm that all units' power switches are turned on. Set the input mode to "L-1".</p>
4. Camcorder recording is not possible.	<ul style="list-style-type: none"> <li>The camcorder has not been properly connected.</li> <li>The input mode is not correct.</li> </ul>	<p>Confirm that the camcorder is properly connected.</p> <p>Set the input mode to "L-1".</p>

## TIMER RECORDING

SYMPTOM	POSSIBLE CAUSE	CORRECTIVE ACTION
1. Timer recording won't work.	<ul style="list-style-type: none"> <li>The clock and/or the timer have been set incorrectly.</li> <li>The timer is not engaged.</li> </ul>	<p>Re-perform the clock and/or timer settings. Press <b>⊖</b> and confirm that "⊖" is displayed on the display panel.</p>
2. On-screen timer programming is not possible.	<ul style="list-style-type: none"> <li>Timer recording is in progress.</li> </ul>	Timer programming can't be performed while a timer recording is in progress. Wait until it finishes.
3. "⊖" and "⊖" on the display panel won't stop blinking.	<ul style="list-style-type: none"> <li>The timer is engaged but there's no cassette loaded.</li> </ul>	Load a cassette with the Record Safety tab intact, or cover the hole using adhesive tape.
4. The cassette is automatically ejected, and "⊖" and "⊖" on the display panel won't stop blinking.	<ul style="list-style-type: none"> <li>The loaded cassette has had its Record Safety tab removed.</li> </ul>	Remove the cassette and cover the hole with adhesive tape, or insert a cassette with the Record Safety tab intact.
5. "⊖" blinks for 10 seconds and the Timer mode is disengaged.	<ul style="list-style-type: none"> <li><b>⊖</b> has been pressed when there are no programs in memory, or the timer record information has been programmed incorrectly.</li> </ul>	Check the programmed data and re-program as necessary, then press <b>⊖</b> again.
6. The cassette is automatically ejected, the power shuts off and "⊖" and "⊖" won't stop blinking.	<ul style="list-style-type: none"> <li>The end of the tape was reached during timer recording.</li> </ul>	The programme may not have been recorded in its entirety. Next time make sure you have enough time on the tape to record the entire programme.

## OTHER PROBLEMS

SYMPTOM	POSSIBLE CAUSE	CORRECTIVE ACTION
1. Whistling or howling is heard from the TV during camcorder recording.	<ul style="list-style-type: none"> <li>• The camcorder's microphone is too close to the TV.</li> <li>• The TV's volume is too high.</li> </ul>	Position the camcorder so its microphone is away from the TV. Turn the TV's volume down.
2. When scanning channels, some of them are skipped over.	<ul style="list-style-type: none"> <li>• Those channels have been designated to be skipped.</li> </ul>	If you need the skipped channels, restore them. (☞ pg. 35)
3. The channel cannot be changed.	<ul style="list-style-type: none"> <li>• Recording is in progress.</li> </ul>	Press <b>PAUSE</b> to pause the recording, change channels, then press <b>PLAY</b> to resume recording.
4. Channel settings that were made manually seem to have changed or disappeared.	<ul style="list-style-type: none"> <li>• After the manual settings were made, Auto Channel Set was performed.</li> </ul>	Perform manual setting again.
5. No channels are stored in the recorder's memory.	<ul style="list-style-type: none"> <li>• The TV aerial cable was not connected to the recorder when Auto Set Up was performed.</li> </ul>	Connect the TV aerial cable to the recorder properly and turn off the recorder power once, then turn the recorder power back on again. The recorder will try Auto Set Up again. (☞ pg. 6)
6. "--:--" is displayed on the front display panel after a power outage.	<ul style="list-style-type: none"> <li>• The lithium battery is exhausted.</li> </ul>	Replace the lithium battery with a new one. (☞ pg. 5)



**PLAYBACK**

- Q. What happens if the end of the tape is reached during playback or search?**  
A. The tape is automatically rewound to the beginning.  
.....
- Q. Can the video recorder indefinitely remain in the still mode?**  
A. No. It stops automatically after 5 minutes to protect the heads.  
.....
- Q. During search, slow, still and frame-by-frame playback, I can't hear any audio. What's the problem?**  
A. This is normal.  
.....
- Q. When returning from multi-speed search to normal playback, the picture is disturbed. Should I be concerned about this?**  
A. No, it is normal.  
.....
- Q. Noise bars appear during multi-speed search. What's the problem?**  
A. This is normal.  
.....
- Q. Other than preventing further recording, what effect does removing the Record Safety tab have?**  
A. It disables marking of index codes.  
.....
- Q. Sometimes, during Index Search, the video recorder can't find the programme I want to see. Why not?**  
A. There may be index codes too close together.  
.....

**RECORDING**

- Q. When I pause and then resume a recording, the end of the recording before the pause is overlapped by the beginning of the continuation of recording. Why does this happen?**  
A. This is normal. It reduces distortion at the pause and resume points.  
.....
- Q. Can the video recorder indefinitely remain in the Record-Pause mode?**  
A. No. The video recorder goes to its Stop mode automatically after 5 minutes to protect the heads.  
.....
- Q. What happens if the tape runs out during recording?**  
A. The video recorder automatically rewinds it to the beginning.  
.....

**TIMER RECORDING**

- Q. "⦿" and "⊖" remain lit on the display panel. Is there a problem?**  
A. No. This is a normal condition for a timer recording in progress.  
.....
- Q. Can I program the timer while I'm watching a tape or a TV broadcast?**  
A. You won't see the picture as it is replaced by the on-screen menu, but the audio from the program or tape you're viewing can be heard.  
.....
- Q. Is it possible to timer-record a TV programme broadcast in 2000?**  
A. Yes, it is possible.  
.....

**ATTENTION:**

This recorder contains microcomputers. External electronic noise or interference could cause malfunctioning. In such cases, switch the recorder off and unplug the mains power cord. Then plug it in again and turn the recorder on. Take out the cassette. After checking the cassette, operate the unit as usual.

## FRONT VIEW

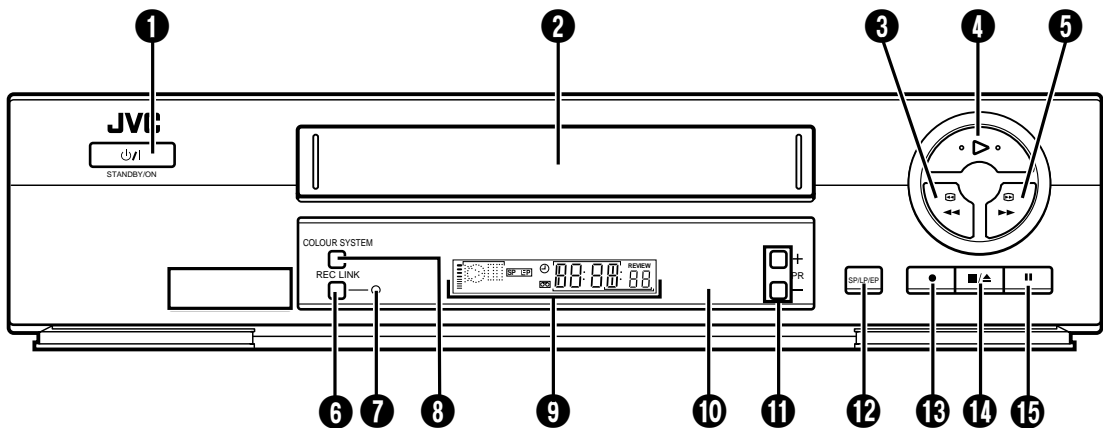

- |   |   |    |  |
|---|---|----|--|
| 1 | STANDBY/ON $\psi$ /I Button $\hookrightarrow$ pg. 8   | 9  | Display Panel $\hookrightarrow$ pg. 43     |
| 2 | Cassette Loading Slot                                 | 10 | Infrared Beam Receiving Window             |
| 3 | Rewind [REW] Button $\hookrightarrow$ pg. 11, 12      | 11 | PR +/- Buttons $\hookrightarrow$ pg. 17    |
| 4 | PLAY Button $\hookrightarrow$ pg. 11                  | 12 | SP/LP/EP Button $\hookrightarrow$ pg. 17   |
| 5 | Fast Forward [FF] Button $\hookrightarrow$ pg. 11, 12 | 13 | RECORD Button $\hookrightarrow$ pg. 17     |
| 6 | REC LINK Button $\hookrightarrow$ pg. 25              | 14 | STOP/EJECT Button $\hookrightarrow$ pg. 11 |
| 7 | REC LINK indicator $\hookrightarrow$ pg. 25           | 15 | PAUSE Button $\hookrightarrow$ pg. 12      |
| 8 | COLOUR SYSTEM Button $\hookrightarrow$ pg. 32         |    |  |

## REAR VIEW

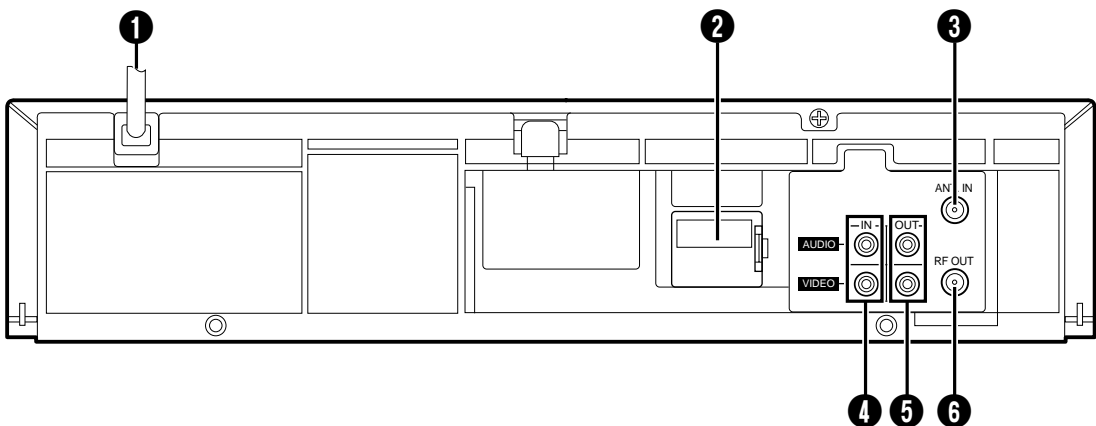

- |   |   |   |  |
|---|---|---|--|
| 1 | Mains Power Cord $\hookrightarrow$ pg. 3            | 4 | AUDIO/VIDEO IN Connectors $\hookrightarrow$ pg. 30     |
| 2 | Lithium Battery Compartment $\hookrightarrow$ pg. 5 | 5 | AUDIO/VIDEO OUT Connectors $\hookrightarrow$ pg. 3, 30 |
| 3 | ANT. IN Connector $\hookrightarrow$ pg. 3           | 6 | RF OUT Connector $\hookrightarrow$ pg. 3               |

## DISPLAY PANEL

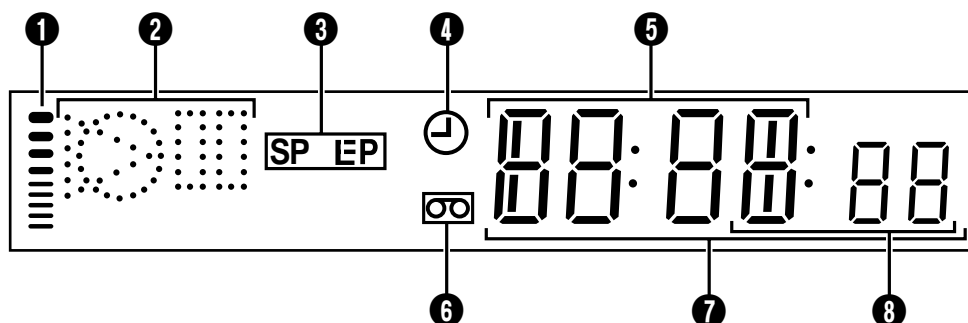

❶ B.E.S.T. Picture System Display pg. 18

❷ Symbolic Mode Indicators

PLAY: FF/REW VARIABLE SHUTTLE SEARCH:		STILL:	
		SLOW:	
		RECORD:	
		RECORD PAUSE:	

❸ Tape Speed Indicators pg. 16

❹ "Timer" Indicator pg. 21

❺ Channel Display

Clock Display

❻ "Cassette Loaded" Mark

❼ Counter Display

❽ Mode Display (L-1)

## REMOTE CONTROL

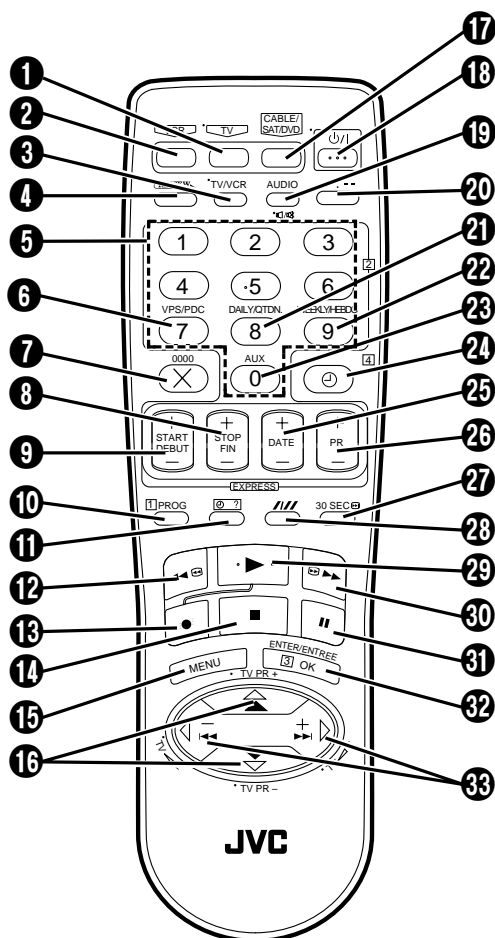

Buttons with a small dot on the left side of the name can also be used to operate your TV ☞ pg. 27.

- 1 TV Button ☞ pg. 27
- 2 VCR Button ☞ pg. 27
- 3 TV/VCR Button ☞ pg. 27
- 4 REVIEW Button ☞ pg. 13
- 5 NUMBER KEYS ☞ pg. 16
- 6 VSP/PDC Button (no function)
- 7 X Button ☞ pg. 22  
0000 Button ☞ pg. 17
- 8 STOP +/- Button ☞ pg. 20
- 9 START +/- Button ☞ pg. 20
- 10 PROG Button ☞ pg. 20
- 11 ? Button ☞ pg. 22
- 12 Rewind [REW] Button ☞ pg. 11, 12
- 13 RECORD Button ☞ pg. 16
- 14 STOP Button ☞ pg. 11
- 15 MENU Button ☞ pg. 8
- 16 PUSH JOG  $\Delta \nabla$  Button ☞ pg. 6  
TV PR +/- Button ☞ pg. 27
- 17 CABLE/SAT/DVD Button ☞ pg. 27
- 18 STANDBY/ON  $\psi / I$  Button ☞ pg. 8
- 19 AUDIO Button (no function)
- 20  $\square / \times$  (TV Muting) Button ☞ pg. 27
- 21 --:-- Button ☞ pg. 17
- 21 DAILY Button ☞ pg. 21
- 22 WEEKLY Button ☞ pg. 21
- 23 AUX Button ☞ pg. 26
- 24  $\odot$  Button ☞ pg. 21
- 25 DATE +/- Button ☞ pg. 20
- 26 PR +/- Button ☞ pg. 16, 20
- 27 30 SEC Button ☞ pg. 14
- 28 SP/LP/EP Button ☞ pg. 16
- 29 PLAY Button ☞ pg. 11
- 30 Fast Forward [FF] Button ☞ pg. 11, 12
- 31 PAUSE Button ☞ pg. 12
- 32 OK Button ☞ pg. 4  
ENTER/ENTREE Button
- 33 PUSH JOG  $\triangleleft \triangleright$  (  $\triangleleft \triangleleft \triangleright \triangleright$  ) Button ☞ pg. 12, 14  
TV  $\triangleleft$  +/- Button ☞ pg. 27

### How To Use

The remote control can operate most of your video recorder's functions, as well as basic functions of TV, cable box, satellite receiver and DVD sets of JVC and other brands. ☞ pg. 27.

- Point the remote control toward the sensor window.
- The maximum operating distance of the remote control is about 8 m.

### NOTES:

- When inserting the batteries, be sure to insert in the correct directions as indicated under the battery cover.
- If the remote control doesn't work properly, remove its batteries, wait a short time, replace the batteries and then try again.

### ATTENTION

The remote control can operate not only the video recorder but also some of your TV, cable box, satellite receiver and DVD functions.

- To operate your video recorder, first press the **VCR** button to set the remote control to the Video mode.
- To operate your TV, first press the **TV** button to set the remote control to the TV mode (☞ pg. 27).
- To operate your satellite receiver, cable box or DVD, first press the **CABLE/SAT/DVD** to set the remote control to the satellite receiver, cable box or DVD mode.

## GENERAL

Power requirement	
Rating	: AC 110 V – 240 V~, 50/60 Hz
Operating	: AC 90 V – 260 V~, 50/60 Hz
Power consumption	: 14 W
Temperature	
Operating	: 5°C to 40°C
Storage	: -20°C to 60°C
Operating position	: Horizontal only
Dimensions (WxHxD)	: 360 mm x 94 mm x 278 mm
Weight	: 3.1 kg
Format	: VHS standard
Maximum recording time	
(SP)	: 240 min. with E-240 video cassette (PAL/MESECAM)
	: 160 min. with T-160 video cassette (NTSC)
(LP)	: 480 min. with E-240 video cassette (PAL/MESECAM)
(EP)	: 480 min. with T-160 video cassette (NTSC)

## VIDEO/AUDIO

Signal system	: PAL-type colour signal and CCIR monochrome signal, 625 lines 50 fields
	: NTSC colour and EIA monochrome signals, 525 lines/60 fields
Recording system	: Rotary 2 head helical scan system
Signal-to-noise ratio	: 45 dB
Horizontal resolution	: 250 lines (PAL/MESECAM)
	: 220 lines (NTSC)
Frequency range	: 70 Hz to 10,000 Hz
Input/Output	: RCA connectors (IN x 1, OUT x 1)

## TUNER/TIMER

TV channel storage capacity	: 99 positions (+AUX position)
Tuning system	: Frequency synthesized tuner
Channel coverage	: VHF (Low) 42 MHz – 175 MHz (High) 175 MHz – 470 MHz UHF 470 MHz – 870 MHz
Aerial output	: UHF channels (Adjustable E28 – E60)
Memory backup time	: Approx. 6 months Estimated figure based on supplied fresh battery; actual performance may differ.

## ACCESSORIES

Provided accessories	: RF cable, Infrared remote control unit, "R6/UM-3" battery x 2, Lithium battery CR2025
----------------------	--

*Specifications shown are for SP mode unless otherwise specified.*

*Design and specifications subject to change without notice.*

### \*\*MOISTURE CONDENSATION

Moisture in the air will condense on the recorder when you move it from a cold place to a warm place, or under extremely humid conditions—just as water droplets form in the surface of a glass filled with cold liquid. Moisture condensation on the head drum will cause damage to the tape. In conditions where condensation may occur, keep the recorder turned on for a few hours to let the moisture dry.

### \*\*ABOUT HEAD CLEANING

Accumulation of dirt and other particles on the video heads may cause the playback picture to become blurred or interrupted. Be sure to contact your nearest JVC dealer if such troubles occur.

#### **Auto Head Cleaner**

A built-in head cleaner automatically cleans the video heads and head drum whenever a tape is loaded or unloaded to reduce head clogging.



## Free Manuals Download Website

<http://myh66.com>

<http://usermanuals.us>

<http://www.somanuals.com>

<http://www.4manuals.cc>

<http://www.manual-lib.com>

<http://www.404manual.com>

<http://www.luxmanual.com>

<http://aubethermostatmanual.com>

Golf course search by state

<http://golfingnear.com>

Email search by domain

<http://emailbydomain.com>

Auto manuals search

<http://auto.somanuals.com>

TV manuals search

<http://tv.somanuals.com>