

JVC VIDEO CASSETTE RECORDER

HR-J4009UM

INSTRUCTIONS

VHS
SQPB

LPT0701-001A
COPYRIGHT © 2002 VICTOR COMPANY OF JAPAN, LTD.



Printed in Thailand
4F11501A [K]
02/01

Dear Customer,

Thank you for purchasing the JVC VHS video cassette recorder. Before use, please read the safety information and precautions to ensure safe use of your new VCR.

CAUTIONS

WARNING: DANGEROUS VOLTAGE INSIDE
WARNING: TO PREVENT FIRE OR SHOCK HAZARD, DO NOT EXPOSE THIS UNIT TO RAIN OR MOISTURE.

The POWER /I button does not completely shut off mains power from the unit, but switches operating current on and off. "I" shows electrical power standby and "I" shows ON.

This unit is produced to comply with Standard IEC 60065.

POWER SYSTEM:

This set operates on voltage of AC 110 – 220V~, 50/60 Hz with automatic switching.

Use the conversion plug (provided) depending on the type of your AC WALL outlet.

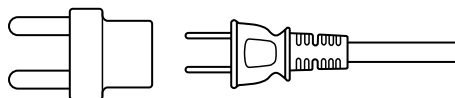

The rating plate and safety caution are on the rear of the unit.

IMPORTANT:

It may be unlawful to record or play back copyrighted material without the consent of the copyright owner.

CAUTION

- When you are not using the VCR for a long period of time, it is recommended that you disconnect the power cord from the AC outlet.
- Dangerous voltage inside. Refer internal servicing to qualified service personnel. To prevent electric shock or fire hazard, remove the power cord from the AC outlet prior to connecting or disconnecting any signal lead or aerial.
- Changes or modifications not approved by JVC could void user's authority to operate the equipment.

VHS SQPB HQ

- Cassettes marked "VHS" (or "S-VHS") can be used with this video cassette recorder. However, S-VHS recording is not possible with this model.
- This model is equipped with SQPB (S-VHS QUASI PLAYBACK) that makes it possible to play back S-VHS recordings with regular VHS resolution.
- HQ VHS is compatible with existing VHS equipment.

When the equipment is installed in a cabinet or a shelf, make sure that it has sufficient space on all sides to allow for ventilation (10 cm or more on both sides, on top and at the rear).

When discarding batteries, environmental problems must be considered and the local rules or laws governing the disposal of these batteries must be followed strictly.

Failure to heed the following precautions may result in damage to the VCR, Remote or video cassette.

1. DO NOT place the VCR ...
 - ... in an environment prone to extreme temperatures or humidity.
 - ... in direct sunlight.
 - ... in a dusty environment.
 - ... in an environment where strong magnetic fields are generated.
 - ... on a surface that is unstable or subject to vibration.
2. DO NOT block the VCR's ventilation openings or holes.
(If the ventilation openings or holes are blocked by a newspaper or cloth, etc., the heat may not be able to get out.)
3. DO NOT place heavy objects on the VCR or Remote.
4. DO NOT place anything which might spill on top of the VCR or Remote.
(If water or liquid is allowed to enter this equipment, fire or electric shock may be caused.)
5. DO NOT expose the apparatus to dripping or splashing.
6. DO NOT use this equipment in a bathroom or places with water.
Also DO NOT place any containers filled with water or liquids (such as cosmetics or medicines, flower vases, potted plants, cups, etc.) on top of this unit.
7. DO NOT place any naked flame sources, such as lighted candles, on the apparatus.
8. AVOID violent shocks to the VCR during transport.

MOISTURE CONDENSATION

Moisture in the air will condense on the VCR when you move it from a cold place to a warm place, or under extremely humid conditions—just as water droplets form on the surface of a glass filled with cold liquid. Moisture condensation on the head drum will cause damage to the tape. In conditions where condensation may occur, keep the VCR's power turned on for a few hours to let the moisture dry.

How to use the Remote

Before use, insert two AAA size batteries into the Remote with the polarity (⊕ and ⊖) matched correctly as indicated on the battery compartment or on the lid.

- Point the Remote toward the remote sensor on the target component.
- The maximum operating distance of the remote control is about 5 m.

NOTE:

If the Remote does not work properly, remove its batteries, wait for a few seconds, replace the batteries and then try again.

Video heads cleaning

The heads get dirty in the following cases:

- in an environment prone to extreme temperature or humidity.
- in a dusty environment
- flaw, dirt or mold on video tapes
- continuous usage for a long time

Use a dry cleaning cassette – TCL-2 – when:

- Rough, poor picture appears while a tape is played back.
- The picture is unclear or no picture appears.

Buttons, Connectors and Indicators

Front Panel

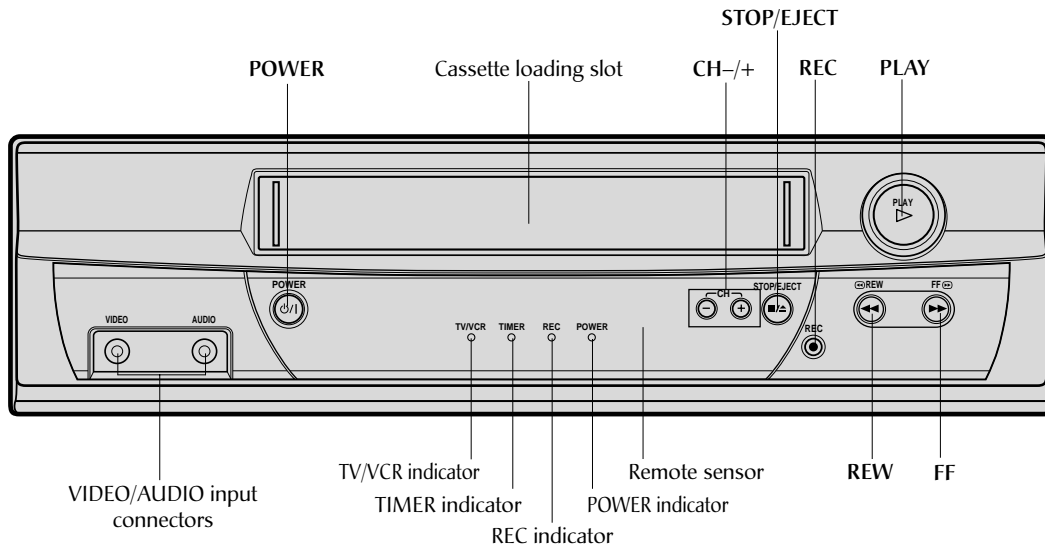

Rear Panel

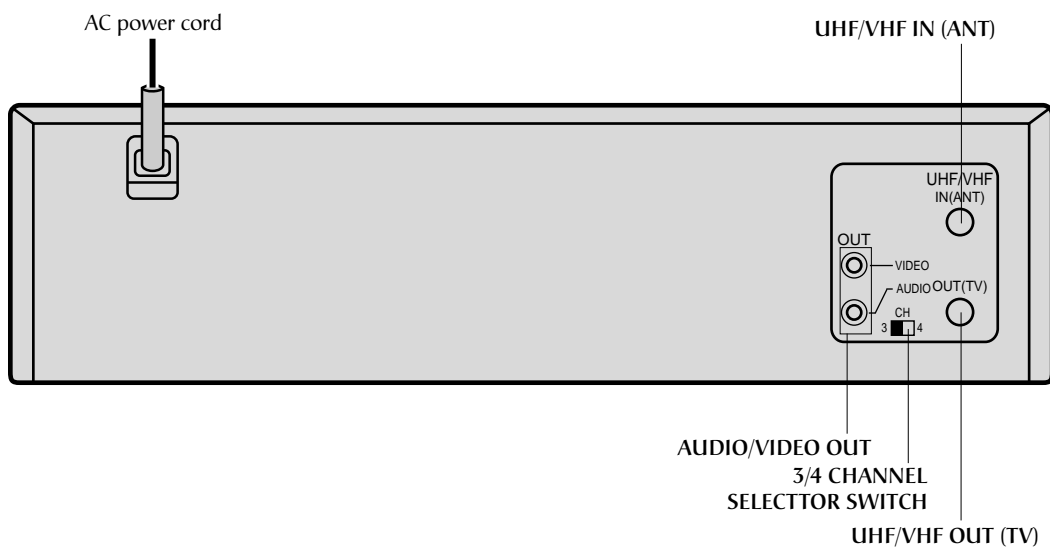

Remote

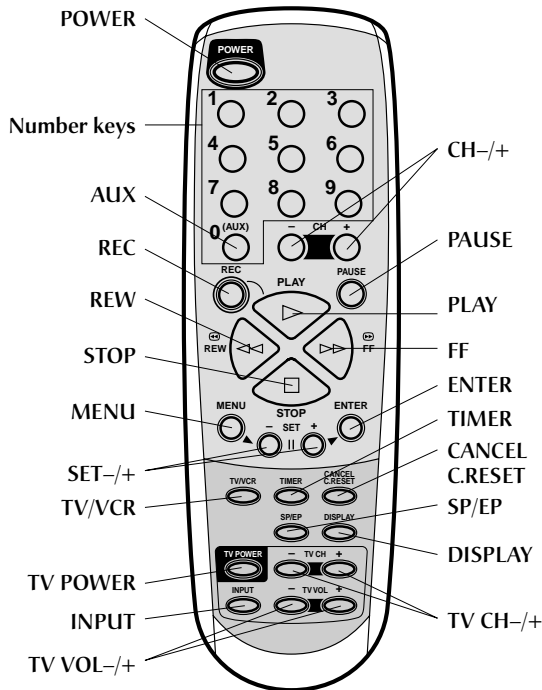

This Remote transmit A code signals only; it is not applicable to B code signals.

On-screen display

If you press DISPLAY on the Remote, you can see the current VCR status on the TV screen. Press DISPLAY again to exit on-screen display. The indications are not recorded even if the VCR is in the recording mode.

WHILE WATCHING TV

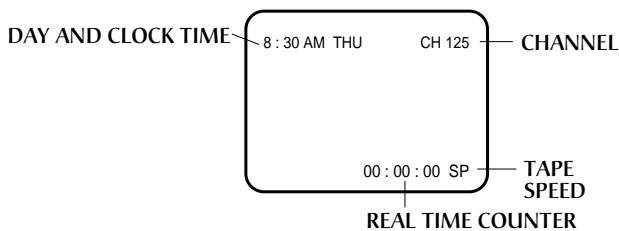

WHILE OPERATING A TAPE

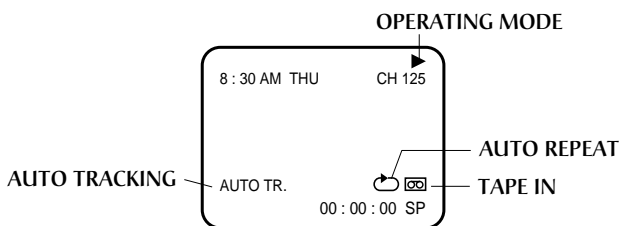

Connections and VCR channel Setting

1 Check contents

Make sure the package contains all of the accessories listed in "Specifications".

2 Situate VCR

Place the VCR on a stable, horizontal surface.

3 Connect VCR to TV

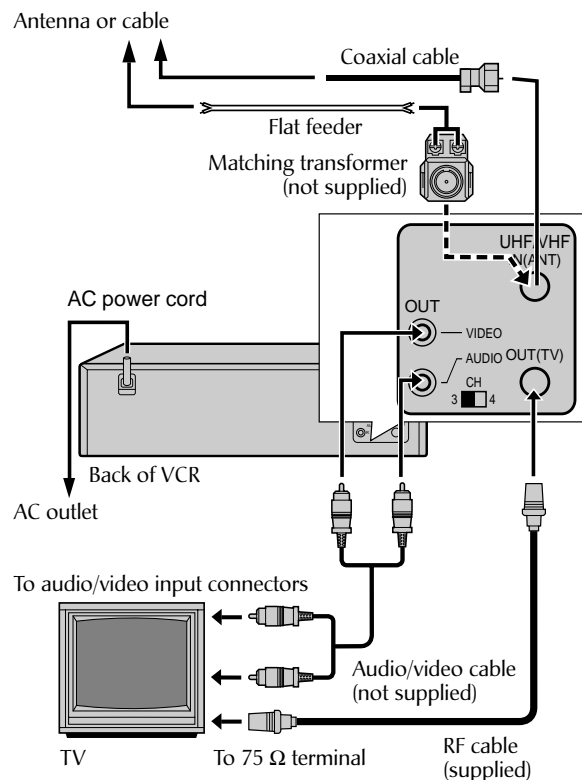

RF Connection

- 1 Disconnect the TV antenna from the TV.
- 2 Connect the TV antenna cable to the UHF/VHF IN terminal on the rear of the VCR.
- 3 Connect the supplied RF cable between the UHF/VHF OUT terminal on the rear of the VCR and the TV's antenna input terminal.

AV Connection

(improves picture quality during tape playback)

If your TV is equipped with audio/video input connectors

- 1 Connect the antenna, VCR and TV as shown in the illustration.
 - 2 Connect an audio/video cable between the AUDIO/VIDEO OUT connectors on the rear of the VCR and the audio/video input connectors on the TV.
- Even if you are using audio/video cables to connect your VCR to your TV, you must also connect it using the RF cable. This will ensure that you can record one show while watching another.

4 Set VCR channel

To view playback of a recorded tape, or to watch a program selected by the VCR's channel selector, the TV must be set to channel 3 or 4 (video channel) when a TV is connected with the 75 ohm coaxial cable only.

- 1 Set the 3/4 Channel selector switch (Rear of the VCR) to CH 3 or 4.
- 2 Turn ON the TV and set to CH 3 or 4 to correspond with the channel selected in 1.
- 3 Press **POWER** to turn on the VCR. The POWER indicator will light.
- 4 Press **TV/VCR** to select the VCR position. The TV/VCR indicator will light.
- 5 Select any channel to receive a TV station in your area. The channel number will appear on the screen for about 4 seconds.

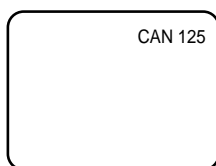

Initial Settings

Language Setting

The default setting is "ESPAÑOL".

1 Access Menu screen, then Language screen

Press MENU on the Remote. Press SET -/+ to select "LANGUAGE", then press ENTER.

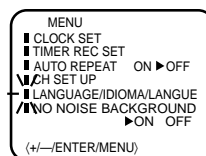

2 Select language

This VCR offers you the language choice to view menus and some messages – in English, Spanish or French. Press SET -/+ to select your desired language, then press ENTER.

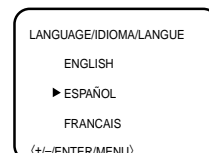

Press MENU twice to return to normal screen.

Clock Setting

Preparations

You must set the date and time for timer recording.

1 Access Menu screen, then Clock Set screen

Press MENU on the Remote. Press SET -/+ to select "CLOCK SET", then press ENTER.

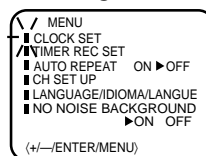

2 Set month, day, year and time

Press SET -/+ until the desired month appears, then press ENTER. Set the day, year and time in the same way.

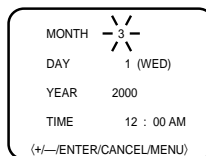

3 Start clock

Press MENU twice and normal screen appears.

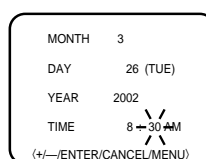

To make corrections any time during the process

Press CANCEL repeatedly until the item you want to change blinks, then press SET -/+.

NOTE:

After a power failure or disconnection of the power over 18 hours, the timer settings will be lost. In this case, reset the present time.

Tuner Setting

This VCR is equipped with a channel memory feature which allows channels to skip up or down to the next channel set into memory, skipping over unwanted channels. Before selecting channels, they must be programmed into the VCR's memory. In addition to normal VHF and UHF channels, this VCR can receive up to 113 Cable TV channels. To use this VCR with an antenna, set the TV/CATV menu option to the TV mode. When shipped from the factory, this menu option is in the CATV mode.

– TV/CATV Selection

1 Access Menu screen, then CH Set Up screen

Press MENU on the Remote. Press SET -/+ to select "CH SET UP", then press ENTER.

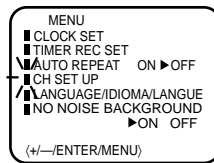

2 Perform TV/CATV Selection

Press SET -/+ to select "TV/CATV", then press ENTER to select the TV or CATV mode. The arrow indicates the selected mode.

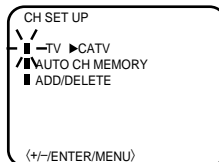

TV - VHF/UHF channels
 CATV - CABLE TV channels

Press MENU twice to return to normal screen.

Setting channels automatically

– Auto Channel Memory

The VCR can receive a maximum of 181 channels by presetting the channels into memory.

1 Access Menu screen, then CH Set Up screen

Press MENU on the Remote. Press SET -/+ to select "CH SET UP", then press ENTER.

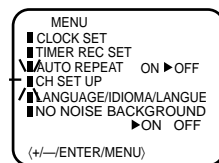

2 Perform Auto Channel Memory

Press SET -/+ to select "AUTO CH MEMORY", then press ENTER.

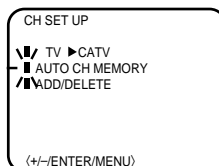

3 Complete Auto Channel Memory

The auto tuning will start. The channel display will count up and when finished, the screen returns to normal.

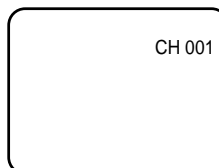

Setting channels manually

– Manual Channel Set

You can add the channels you want or delete the channels you do not want manually.

1 Access Menu screen, then CH Set Up screen

Press MENU on the Remote. Press SET -/+ to select "CH SET UP", then press ENTER.

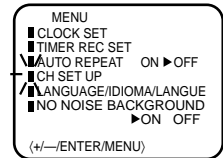

2 Access ADD/DELETE Mode

Press SET -/+ to select "ADD/DELETE", then press ENTER.

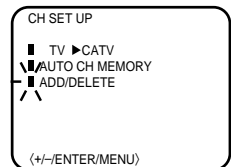

3 Add or Delete desired channels

1 Press SET -/+ on the Remote to select a channel number you want to add or delete.

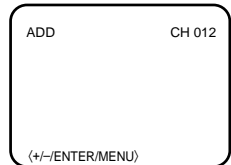

2 To add channels

Press ENTER until "ADD" appears on the screen to set to add the unmemorized channel.

To delete channels

Press ENTER until "DELETE" appears on the screen to set to delete the channel from memory.

Repeat 1 to 2 to add or delete other channel.

3 Press MENU three times to return to normal screen.

NOTE: You can't select "CH SET UP" if you set the channel to "L".

Playback

Basic Playback

1 Load a cassette

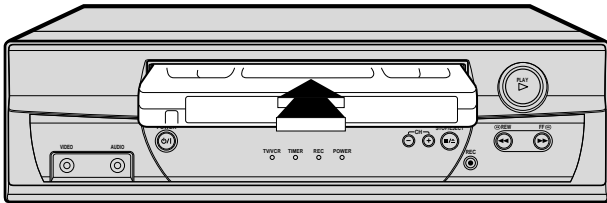

Make sure the window side is up, the rear label side is facing you and the arrow on the front of the cassette is pointing towards the VCR.

- Do not apply too much pressure when inserting.
- The VCR turns on, and the counter on the on-screen display is reset, automatically.
- If the cassette's record safety tab has been removed, playback begins automatically.

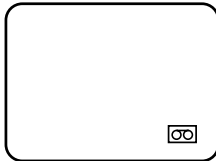

2 Start playback

Press **PLAY** (▶) on the Remote.



During playback

Stop playback

Press **STOP** (■) on the Remote.

OR Press **STOP/EJECT** (■/▲) on the VCR.



Pause playback and view still picture

Press **PAUSE**.

- Press **PLAY** (▶) to resume normal playback.

Pause and Frame-by-Frame playback

Press **PAUSE** to pause, then press **PAUSE** repeatedly. Press **PLAY** (▶) to resume normal playback.

Slow-motion

Press **PLAY** (▶) on the Remote.

OR Press **Play** (▶) on the VCR.

- Playback will proceed at 1/10 th of the normal speed.
- Press **PLAY** (▶) to resume normal playback.

NOTE:

During slow motion picture, some noise might appear on the TV screen. Use the **SET-/+** on the Remote to eliminate the noise.

Speed search

Press **REW** (◀◀) or **FF** (▶▶) on the Remote.

OR Press **REW** (◀◀) or **FF** (▶▶) on the VCR.

- Press **PLAY** (▶) to resume normal playback.

Variable speed search

Press **REW** (◀◀) or **FF** (▶▶) repeatedly on the Remote.

OR Press **REW** (◀◀) or **FF** (▶▶) repeatedly on the VCR.

- Press **PLAY** (▶) to resume normal playback.
- Each time you press **REW** (◀◀) or **FF** (▶▶) the playback speed changes.

TAPE SPEED	PICTURE SEARCH SPEED	
	PRESS ONCE	PRESS TWICE
SP	3X	5X
EP	9X	15X

When the tape is not running

Rewind/fast-forward

Press **REW** (◀◀) or **FF** (▶▶) on the Remote.

OR Press **REW** (◀◀) or **FF** (▶▶) on the VCR.



Eject the tape

Press **STOP/EJECT** (■/▲) on the VCR.

- You can also eject the cassette when the VCR is turned off.

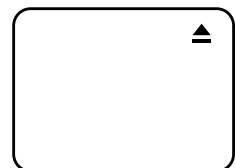

Turn off the VCR

Press **POWER** on the Remote.

OR Press **POWER** (⏻/⏻) on the VCR.

Playback Features

Adjusting tracking condition

- Tracking Adjustment

Automatic tracking adjustment

Whenever you insert a tape and start playback, automatic tracking starts working and continuously analyzes the signal to enable optimum picture quality during playback.

Manual tracking adjustment

If automatic tracking cannot eliminate noises well during playback, press SET +/- on the Remote to eliminate the noises. Press it briefly for a fine adjustment, or press and hold for a coarse adjustment.

- Press SP/EP on the Remote to reactivate automatic tracking.

Playing back tape repeatedly

- Auto Repeat Play

1 Access Menu screen

Press MENU on the Remote. Press SET +/- to select "AUTO REPEAT".

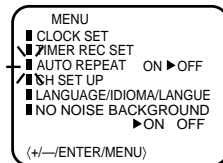

2 Select ON/OFF

Press ENTER to select "ON" or "OFF". Press MENU to return to normal screen.

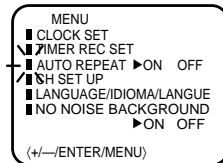

3 Start Auto Repeat Play

Press PLAY. The tape will play over and over until the repeat mode is canceled.

Recording

It may be unlawful to record or play back copyrighted material without the consent of the copyright owner.

Accidental erasure prevention

To prevent accidental recording on a recorded cassette, remove its record safety tab. To record on it later, cover the hole with adhesive tape.



Record safety tab

Basic Recording

1 Load a cassette

Make sure the record safety tab is intact. If not, cover the hole with adhesive tape before inserting the cassette.

- The VCR turns on, and the counter is reset, automatically.

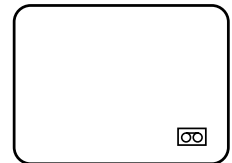

2 Select recording channel

Press CH +/- or the Number keys on the Remote [CH +/- on the VCR].

- If you connect the TV and the VCR only using the RF connection, press TV/VCR on the Remote so that the TV/VCR indicator lights to view the program to be recorded.

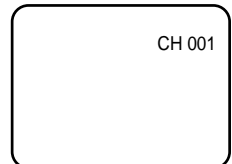

3 Set tape speed

Press SP/EP.

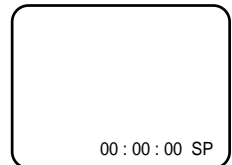

4 Start recording

On the VCR, press REC. Or on the Remote, while holding REC, press PLAY (▷).

The REC indicator will light.

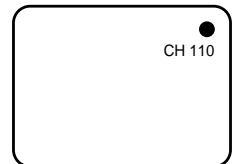

During recording

Pause recording

Press PAUSE.

- Press PAUSE to resume recording.
- You can select channel in the recording pause mode.



Stop recording

Press STOP (□) on the Remote.

OR Press STOP/EJECT (■/▲) on the VCR.



Recording Features

Specifying recording length - One Touch Timer Recording (OTR)

The One-touch Timer Recording feature provides a simple and convenient way to make a timed recording.

EXAMPLE: One-touch Timer Recording for 30 minutes.

When a TV is connected with an audio/video cable, turn the TV on and select the video input mode on the TV.

- 1 Load a cassette tape with the erase prevention tab intact.

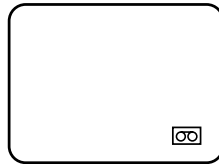

- 2 Press SP/EP to select the desired tape speed SP or EP. The counter and SP or EP will appear on the screen for about 4 seconds.

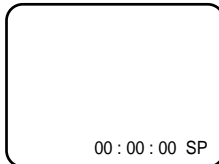

- 3 Press the Number keys or CH +/- to select the channel to be recorded. The channel number will appear on the screen and display for about 4 seconds.

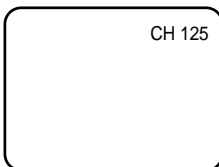

- 4 Press REC on the VCR or while holding REC, press PLAY (▷) on the Remote to begin recording. Press REC on the VCR again to stop recording after 30 minutes. Each additional press of REC will increase recording time as shown in the chart below, up to a maximum of 5 hours. The OTR and recording time will appear on screen for about 4 seconds.

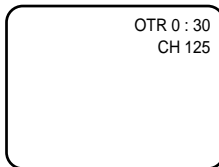

- NOTES:
- Press REC to increase the time needed for recording (See the chart).
 - To cancel OTR, press STOP (□) or turn off the power.

Press	Recording time
once	NORMAL REC
twice	0:30
3 times	1:00
4 times	1:30
5 times	2:00
6 times	3:00
7 times	4:00
8 times	5:00
9 times	NORMAL REC

Watching one program while recording another

During recording...

- If you connect the TV and the VCR only using the RF connection to view pictures from the VCR, press TV/VCR on the Remote so that TV/VCR indicator goes off. (The TV broadcast being recorded disappears.)
- If you are using the AV connection to view pictures from the VCR, change the TV's input mode from AV to TV. Then, select the channel you want to watch, on the TV.

Timer Recording

Timer recording can be programmed on-screen with the remote control. The built-in timer allows automatic unattended recording of up to 8 programs within 1 month.

NOTES:

- After timer recording is completed, the VCR turns off automatically.
- You can program the timer recording while a regular recording is in progress; the menu screens will not be recorded.
- The timer recording will start at 20 seconds before the time you predetermined.

EXAMPLE: Program a timer recording for the 26th day, channel 125 (CATV), 11:00 - 11:30 PM on timer program number 1 (Tape speed: EP).

When a TV is connected with an audio/video cable, turn the TV and this VCR on and select the video input mode on the TV.

- 1 Press MENU on the Remote. Check the "TIMER REC SET" option is selected, then press ENTER.

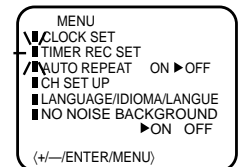

- 2 Press SET +/- to select one of the program lines, then press ENTER.

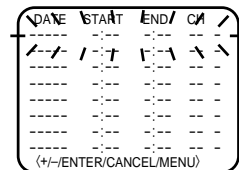

- 3 Press SET +/- to select the date, then press ENTER.

- 4 Set the start time, end time, channel and tape speed as in step 3.

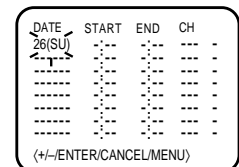

NOTE: To record from external source, press SET +/- and set the channel to "L". "L" will appear next to CH 125 (or 69).

- 5 To enter other programs, repeat step 2 through 4. Or, press MENU twice to return to the normal screen.

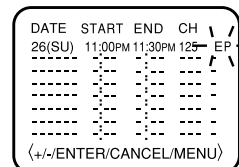

- 6 Press TIMER on the Remote. The power will go off, the TIMER indicator will light and the VCR stands by for recording.

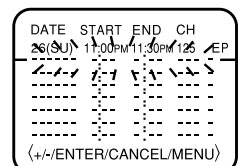

To use the VCR while it is in timer recording standby mode Press TIMER. After you use the VCR, press TIMER again to put the VCR into timer recording standby mode.

TO CORRECT THE SETTINGS

When setting the Timer Recording, press **ENTER** until the desired setting blinks, then re-enter the setting using **SET +/-**. When finished, press **ENTER**.

- NOTES:**
- The VCR cannot be used while the **TIMER** indicator is lit.
 - After a power failure or disconnection of the power plug over 18 hours, all programmed recording settings must be reset upon resumption of power. In this case, reset the clock and reprogram any timer recordings.
 - Press **CANCEL** to move cursor backward for correction.

TO SET DAILY/WEEKLY TIMER

When setting the date in step 3 in the Setting the Timer Recording section on the previous page, press **SET +/-** repeatedly.

The setting changes as follows:

Example

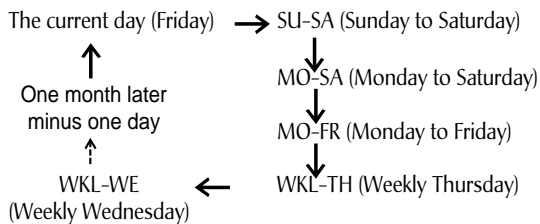

TO CONFIRM THE SETTINGS

Press **SET +/-** to select the "TIMER REC SET" option in the MENU. Then press **ENTER** to display the timer program list. Press **MENU** twice to return to the normal screen.

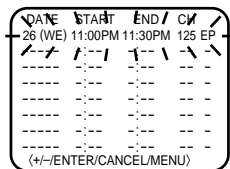

TO CANCEL A PROGRAM

Press the **SET +/-** to select the "TIMER REC SET" option in the MENU. Then press **SET +/-** to select the unnecessary program, and press **CANCEL** to cancel the program.

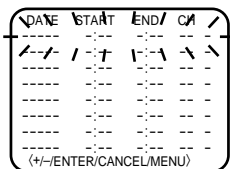

IF THE PROGRAM OVERLAPS ANOTHER

NOTE: Do not overlap programs as portions of the conflicting programs will be lost. The first recording time has priority over the next recording time as shown in the diagram.

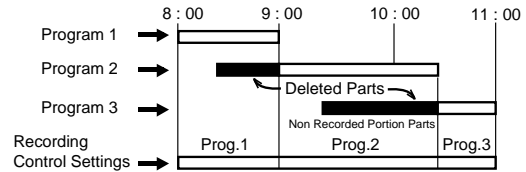

- NOTES:**
- The everyday/every week recording can be made continuously until the recording is canceled or the tape reaches the end.
 - During timer recording, the automatic rewinding mechanism does not function.

Other Functions

■ BLUE BACK – ON/OFF

When this function is set to "ON", the TV screen becomes all blue in the following cases:

When receiving a channel not in use.

When stopping playback.

- 1** Press **MENU** on the remote. Press **SET -/+** to select "NO NOISE BACKGROUND".
- 2** Press **ENTER** to select "ON".
- 3** Press **MENU** to return to normal screen.

JVC TV Remote Control

This Remote can control some functions (**TV POWER**, **INPUT**, **TV CH -/+** and **TV VOL -/+**) of a remote controllable JVC TV without setting.

NOTE:

- It's not possible to operate a unit not equipped with a remote sensor.
- This Remote can control a JVC TV only.

Editing

You can use your VCR as the playback or recording VCR. You can use a camcorder as the playback VCR and your VCR as the recording VCR. Refer also to the other components' instruction manuals for connection and its operations.

1 Make connections

Example: When using this VCR as the playback VCR

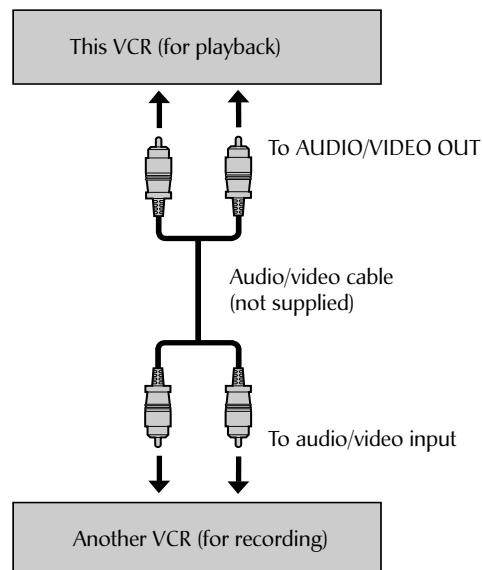

- When using this VCR as the recording VCR, connect this VCR's audio/video input connectors to the audio/video output connectors on the other VCR. If the playback VCR is monaural, connect the audio output connector on the playback VCR to the left audio input connector on this VCR.

2 Load cassettes

Insert the playback cassette into the playback VCR and the cassette to be recorded on into the recording VCR.

3 Select input mode on recording VCR

Select the correct external input on the recording VCR. On this VCR (when using this VCR as the recording VCR); Select "L" – when connecting the other VCR to the audio/video input connectors on the front panel. Press **O (AUX)** or **CH-/+** on the Remote [**CH-/+** on the VCR].

4 Start playback

Press **PLAY (▶)** on the playback VCR.

5 Start recording

Press **REC** on the recording VCR.

Before Requesting Service

Make sure by first checking the following points.

SYMPTOM	CAUSE	POSSIBLE SOLUTION
POWER		
No power.	The AC power cord is not connected.	Connect the AC power cord to the AC outlet.
Although the power is on, it does not operate.	Cassette is not inserted.	Insert a video cassette.
TV BROADCAST RECEPTION		
A TV program that is selected by the VCR does not appear on the screen.	Antenna connection is not correct.	Connect it correctly.
	Antenna cable is disconnected.	Reconnect the antenna cable.
	The video channel is not in the correct position.	Set it to CH 3 or 4.
	The TV is not set to the video channel 3 or 4.	Set the TV channel selector to the 3 or 4 position.
	The TV/VCR selector is set at TV mode (The TV/VCR indicator is not lit).	Press the TV/VCR selector button (The TV/VCR indicator will light).
	INPUT is set to the LINE mode.	Press the Number key or CH -/+ button to select your desired TV program.
RECORDING		
TV recording does not work.	The erase prevention tab of the video cassette is broken off.	Place a piece of vinyl tape over the gap.
	INPUT is set to the LINE mode.	Press the Number key or CH -/+ button to select your desired TV program.
Timer recording does not work.	The time is not set correctly.	Reset the present time.
	The recording start/end time is not set correctly.	Set the start/end time.
	The TIMER button has not been pressed (The TIMER indicator is not lit).	Press the TIMER button (The TIMER indicator is lit).
PLAYBACK		
No picture on screen when playing back a recorded tape.	The TV is not set to the video channel 3 or 4.	Set to the video channel 3 or 4 or adjust the fine tuning button on your TV set.
Noise bars on screen.	Tracking adjustment beyond range of automatic tracking circuit.	Adjust tracking manually using the SET - or + buttons on the remote control.
	Video heads are dirty.	Have the video heads cleaned.
	The tape is worn or damaged.	Try another tape.
REMOTE CONTROL		
Remote control does not work.	It is not aimed at the remote sensor.	Aim it at the remote sensor.
	Distance too far or too much light in the room.	Operate within 15 feet (5 meters) reduce the light in the room.
	There is an obstacle in the path of the beam.	Clear the path of the beam.
	The batteries are weak.	Replace the batteries.
	The +, - polarity of the batteries are not inserted correctly.	Insert correctly.
TV programs cannot be seen using the TV selector.	The TV/VCR function is in the VCR mode.	Set to TV, or turn off the VCR power button.

Specifications

GENERAL

Power requirement	:	AC 110 V-220 V~, 50Hz/60 Hz
Power consumption	:	
Power on	:	9 W
Power off	:	2.0 W
Temperature	:	
Operating	:	5°C to 40°C (41°F to 104°F)
Storage	:	-20°C to 60°C (-4°F to 140°F)
Operating position	:	Horizontal only
Dimensions (W x H x D)	:	360 mm x 95 mm x 224 mm
Weight	:	3.2 kg
Format	:	VHS NTSC standard
Maximum recording time	:	
SP	:	210 min. with ST-210 video cassette
EP	:	630 min. with ST-210 video cassette

VIDEO/AUDIO

Signal system	:	NTSC-type color signal and EIA monochrome signal, 525 lines/60 fields
Recording/Playback system	:	DA-4 (Double Azimuth) head helical scan system
Signal-to-noise ratio	:	42 dB
Horizontal resolution	:	230 lines
Frequency range	:	
Normal audio	:	100 Hz to 10,000 Hz
Input/Output	:	RCA connectors (IN x 1, OUT x 1)

TUNER

Tuning system	:	Frequency-synthesized tuner
Channel coverage	:	
VHF	:	Channels 2-13
UHF	:	Channels 14-69
CATV	:	113 Channels
RF output	:	Channel 3 or 4 (switchable; preset to Channel 3 when shipped) 75 ohms, unbalanced

TIMER

Clock reference	:	Quartz
Program capacity	:	1-month programmable timer/8 programs
Memory backup for timer	:	Approx. 18 hours

ACCESSORIES

Provided accessories	:	RF cable (F-type), Infrared remote control unit, "AAA" battery x 2, Conversion plug
----------------------	---	---

Specifications shown are for SP mode unless specified otherwise.
E. & O.E. Design and specifications subject to change without notice.

Free Manuals Download Website

<http://myh66.com>

<http://usermanuals.us>

<http://www.somanuals.com>

<http://www.4manuals.cc>

<http://www.manual-lib.com>

<http://www.404manual.com>

<http://www.luxmanual.com>

<http://aubethermostatmanual.com>

Golf course search by state

<http://golfingnear.com>

Email search by domain

<http://emailbydomain.com>

Auto manuals search

<http://auto.somanuals.com>

TV manuals search

<http://tv.somanuals.com>