

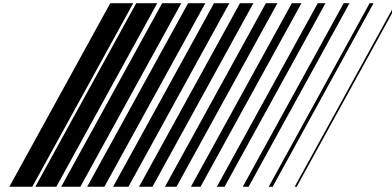

JVC



VIDEO CASSETTE RECORDER

HR-VP639U

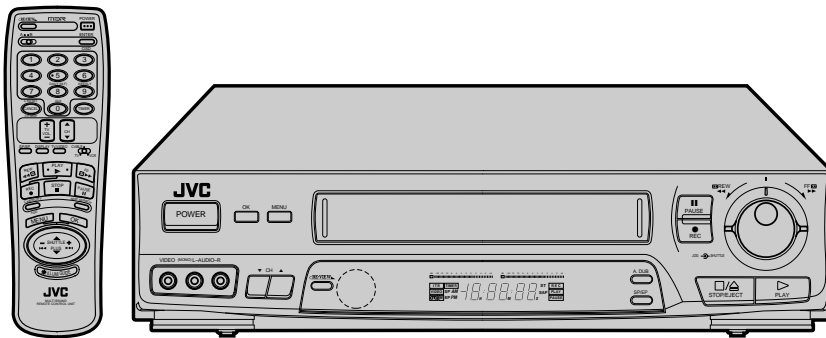

VCRplus[®]c³
w/Cable Channel
Changer

Hi-Fi **VHS**

INSTRUCTIONS

For Customer Use:

Enter below the Serial No. which is located on the rear of cabinet. Retain this information for future reference.

Model No. HR-VP639U(U)(C)



Serial No. _____

PU30425-1832

Dear Customer,

Thank you for purchasing the JVC VHS video cassette recorder. Before use, please read the safety information and precautions contained in the following pages to ensure safe use of your new VCR.

CAUTIONS

	CAUTION RISK OF ELECTRIC SHOCK DO NOT OPEN	
<p>CAUTION: TO REDUCE THE RISK OF ELECTRIC SHOCK, DO NOT REMOVE COVER (OR BACK). NO USER-SERVICEABLE PARTS INSIDE. REFER SERVICING TO QUALIFIED SERVICE PERSONNEL.</p>		



The lightning flash with arrowhead symbol, within an equilateral triangle, is intended to alert the user to the presence of uninsulated "dangerous voltage" within the product's enclosure that may be of sufficient magnitude to constitute a risk of electric shock to persons.



The exclamation point within an equilateral triangle is intended to alert the user to the presence of important operating and maintenance (servicing) instructions in the literature accompanying the appliance.

WARNING:

TO PREVENT FIRE OR SHOCK HAZARD, DO NOT EXPOSE THIS UNIT TO RAIN OR MOISTURE.

CAUTION:

This video cassette recorder should be used with AC 120V~, 60Hz only. To prevent electric shocks and fire hazards, DO NOT use any other power source.

CAUTION:

TO PREVENT ELECTRIC SHOCK, MATCH WIDE BLADE OF PLUG TO WIDE SLOT, FULLY INSERT.

ATTENTION:

POUR ÉVITER LES CHOCS ÉLECTRIQUES, INTRODUIRE LA LAME LA PLUS LARGE DE LA FICHE DANS LA BORNE CORRESPONDANTE DE LA PRISE ET POUSSER JUSQU'AU FOND.

Note to CATV system installer:

This reminder is provided to call the CATV system installer's attention to Article 820-40 of the NEC that provides guidelines for proper grounding and, in particular, specifies that the cable ground shall be connected to the grounding system of the building, as close to the point of cable entry as practical.

CAUTION:

Changes or modifications not approved by JVC could void user's authority to operate the equipment.

Failure to heed the following precautions may result in damage to the VCR, remote control or video cassette.

- DO NOT** place the VCR . . .
 - ... in an environment prone to extreme temperatures or humidity.
 - ... in direct sunlight.
 - ... in a dusty environment.
 - ... in an environment where strong magnetic fields are generated.
 - ... on a surface that is unstable or subject to vibration.
- DO NOT** block the VCR's ventilation openings.
- DO NOT** place heavy objects on the VCR or remote control.
- DO NOT** place anything which might spill on top of the VCR or remote control.
- AVOID** violent shocks to the VCR during transport.

****MOISTURE CONDENSATION**

Moisture in the air will condense on the VCR when you move it from a cold place to a warm place, or under extremely humid conditions—just as water droplets form on the surface of a glass filled with cold liquid. Moisture condensation on the head drum will cause damage to the tape. In conditions where condensation may occur, keep the VCR's power turned on for a few hours to let the moisture dry.

****ABOUT HEAD CLEANING**

Accumulation of dirt and other particles on the video heads may cause the playback picture to become blurred or interrupted. Be sure to contact your nearest JVC dealer if such troubles occur.

VCR Plus+C³ and PlusCode are trademarks of Gemstar Development Corporation. The VCR Plus+C³ system is manufactured under licence from Gemstar Development Corporation.



- Cassettes marked "VHS" (or "S-VHS") can be used with this video cassette recorder. However, only "VHS" recordings can be played back in this model.
- HQ VHS is compatible with existing VHS equipment.

IMPORTANT PRODUCT SAFETY INSTRUCTIONS

Electrical energy can perform many useful functions. But improper use can result in potential electrical shock or fire hazards. This product has been engineered and manufactured to assure your personal safety. In order not to defeat the built-in safeguards, observe the following basic rules for its installation, use and servicing.

ATTENTION:

Follow and obey all warnings and instructions marked on your product and its operating instructions. For your safety, please read all the safety and operating instructions before you operate this product and keep this booklet for future reference.

INSTALLATION

1. Grounding or Polarization

(A) Your product may be equipped with a polarized alternating-current line plug (a plug having one blade wider than the other). This plug will fit into the power outlet only one way. This is a safety feature.

If you are unable to insert the plug fully into the outlet, try reversing the plug. If the plug should still fail to fit, contact your electrician to replace your obsolete outlet. Do not defeat the safety purpose of the polarized plug.

(B) Your product may be equipped with a 3-wire grounding-type plug, a plug having a third (grounding) pin. This plug will only fit into a grounding-type power outlet. This is a safety feature.

If you are unable to insert the plug into the outlet, contact your electrician to replace your obsolete outlet. Do not defeat the safety purpose of the grounding-type plug.

2. Power Sources

Operate your product only from the type of power source indicated on the marking label. If you are not sure of the type of power supply to your home, consult your product dealer or local power company. If your product is intended to operate from battery power, or other sources, refer to the operating instructions.

3. Overloading

Do not overload wall outlets, extension cords, or integral convenience receptacles as this can result in a risk of fire or electric shock.

4. Power Cord Protection

Power supply cords should be routed so that they are not likely to be walked on or pinched by items placed upon or against them, paying particular attention to cords at plugs, convenience receptacles, and the point where they exit from the product.

5. Ventilation

Slots and openings in the cabinet are provided for ventilation. To ensure reliable operation of the product and to protect it from overheating, these openings must not be blocked or covered.

- Do not block the openings by placing the product on a bed, sofa, rug or other similar surface.
- Do not place the product in a built-in installation such as a bookcase or rack unless proper ventilation is provided or the manufacturer's instructions have been adhered to.

6. Wall or Ceiling Mounting

The product should be mounted to a wall or ceiling only as recommended by the manufacturer.

ANTENNA INSTALLATION INSTRUCTIONS

1. Outdoor Antenna Grounding

If an outside antenna or cable system is connected to the product, be sure the antenna or cable system is grounded so as to provide some protection against voltage surges and built-up static charges. Article 810 of the National Electrical Code, ANSI/NFPA 70, provides information with regard to proper grounding of the mast and supporting structure, grounding of the lead-in wire to an antenna discharge unit, size of grounding connectors, location of antenna discharge unit, connection to grounding electrodes, and requirements for the grounding electrode.

2. Lightning

For added protection for this product during a lightning storm, or when it is left unattended and unused for long periods of time, unplug it from the wall outlet and disconnect the antenna or cable system. This will prevent damage to the product due to lightning and power-line surges.

3. Power Lines

An outside antenna system should not be located in the vicinity of overhead power lines or other electric light or power circuits, or where it can fall into such power lines or circuits. When installing an outside antenna system, extreme care should be taken to keep from touching such power lines or circuits as contact with them might be fatal.

EXAMPLE OF ANTENNA GROUNDING AS PER NATIONAL ELECTRICAL CODE, ANSI/NFPA 70

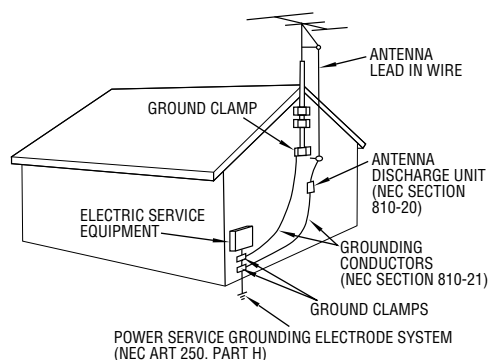

NEC - NATIONAL ELECTRICAL CODE

USE

1. Accessories

To avoid personal injury:

- Do not place this product on an unstable cart, stand, tripod, bracket, or table. It may fall, causing serious injury to a child or adult, and serious damage to the product.
- Use only with a cart, stand, tripod, bracket, or table recommended by the manufacturer or sold with the product.
- Use a mounting accessory recommended by the manufacturer and follow the manufacturer's instructions for any mounting of the product.
- Do not try to roll a cart with small casters across thresholds or deep-pile carpets.

2. Product and Cart Combination

A product and cart combination should be moved with care. Quick stops, excessive force, and uneven surfaces may cause the product and cart combination to overturn.

PORTABLE CART WARNING
(Symbol provided by RETAC)



3. Water and Moisture

Do not use this product near water—for example, near a bath tub, wash bowl, kitchen sink or laundry tub, in a wet basement, or near a swimming pool and the like.

4. Object and Liquid Entry

Never push objects of any kind into this product through openings as they may touch dangerous voltage points or short-out parts that could result in a fire or electric shock. Never spill liquid of any kind on the product.

5. Attachments

Do not use attachments not recommended by the manufacturer of this product as they may cause hazards.

6. Cleaning

Unplug this product from the wall outlet before cleaning. Do not use liquid cleaners or aerosol cleaners. Use a damp cloth for cleaning.

7. Heat

The product should be situated away from heat sources such as radiators, heat registers, stoves, or other products (including amplifiers) that produce heat.

SERVICING

1. Servicing

If your product is not operating correctly or exhibits a marked change in performance and you are unable to restore normal operation by following the detailed procedure in its operating instructions, do not attempt to service it yourself as opening or removing covers may expose you to dangerous voltage or other hazards. Refer all servicing to qualified service personnel.

2. Damage Requiring Service

Unplug this product from the wall outlet and refer servicing to qualified service personnel under the following conditions:

- When the power supply cord or plug is damaged.
- If liquid has been spilled, or objects have fallen into the product.
- If the product has been exposed to rain or water.
- If the product does not operate normally by following the operating instructions. Adjust only those controls that are covered by the operating instructions as an improper adjustment of other controls may result in damage and will often require extensive work by a qualified technician to restore the product to its normal operation.
- If the product has been dropped or damaged in any way.
- When the product exhibits a distinct change in performance—this indicates a need for service.

3. Replacement Parts

When replacement parts are required, be sure the service technician has used replacement parts specified by the manufacturer or have the same characteristics as the original part. Unauthorized substitutions may result in fire, electric shock or other hazards.

4. Safety Check

Upon completion of any service or repairs to this product, ask the service technician to perform safety checks to determine that the product is in safe operating condition.

HOW TO USE THIS INSTRUCTION MANUAL

- All major sections and subsections are listed in the Table Of Contents on page 5. Use this when searching for information on a specific procedure or feature.
- The Index on pages 57–59 lists frequently-used terms, and the number of the first page on which they are used or explained in the manual. This section also illustrates the controls and connections on the front and rear panel, the front display panel and the remote control.
- The  mark signals a reference to another page for instructions or related information.
- Operation buttons necessary for the various procedures are clearly indicated through the use of illustrations at the beginning of each major section.

BEFORE YOU INSTALL YOUR NEW VCR . . .

. . . please read the sections/literature listed below.

- "Cautions" on page 2
- "Important Products Safety Instructions" on the previous pages

I **NSTALLING YOUR NEW VCR** **6**

Basic Connections6

I **NITIAL SETTINGS** **7**

Dual Quick Set7

Language8

Clock9

Preparation9

Semi-Auto10

Manual11

Auto11

Tuner12

Set Receivable Channels12

Add Or Delete A Channel14

Tuner And Cable Box Controller.....15

Situate And Connect Controller15

Set Cable Box Output Channel16

Set Cable Box Brand17

VCR Plus+ Setup19

S **IMPLE PLAYBACK AND RECORDING** **22**

Simple Playback22

Simple Recording23

P **LAYBACK AND RECORDING FEATURES** **24**

Playback24

Still Picture/Frame-By-Frame Playback24

Slow Motion/Reverse Slow Motion24

Variable-Speed Search/Reverse Play25

High-Speed Search25

Manual Tracking26

Select The Soundtrack27

Superimpose28

Skip Search29

Repeat Playback29

Index Search29

Instant ReView30

Counter Reset30

Counter Memory30

Tape Position Indicator31

Next-Function Memory31

AV COMPU LINK Playback31

Active Video Calibration33

Preparation33

Recording34

Playback35

Recording36

Record One Program While

Watching Another36

Display Elapsed Recording Time36

Stereo And SAP (Second Audio Program)37

To Record SAP Programs37

T **IMER RECORDING** **38**

VCR Plus+ Timer Programming38

On-Screen Timer Programming40

Check And Cancel Programs42

Auto Timer43

Instant Timer Recording (ITR)44

E **DITING** **45**

Edit To Or From Another VCR45

Edit From A Camcorder46

Assemble Editing48

Audio Dubbing49

S **PECIAL FEATURES** **50**

TV Multi-Brand Remote Control50

Cable Box Multi-Brand Remote Control51

Control Two JVC VCRs52

Child Lock52

T **ROUBLESHOOTING** **53**

Power53

Tape Transport53

Playback53

Recording54

Timer Recording54

Other Problems55

Q **UESTIONS AND ANSWERS** **56**

Playback56

Recording56

Timer Recording56

I **NDEX** **57**

List Of Terms57

Front View58

Rear View58

Front Display Panel59

Remote Control59

S **PIFICATIONS** **60**

F **OR SERVICING** **61**

W **ARRANTY** **62**



6

INSTALLING YOUR NEW VCR

Basic Connections

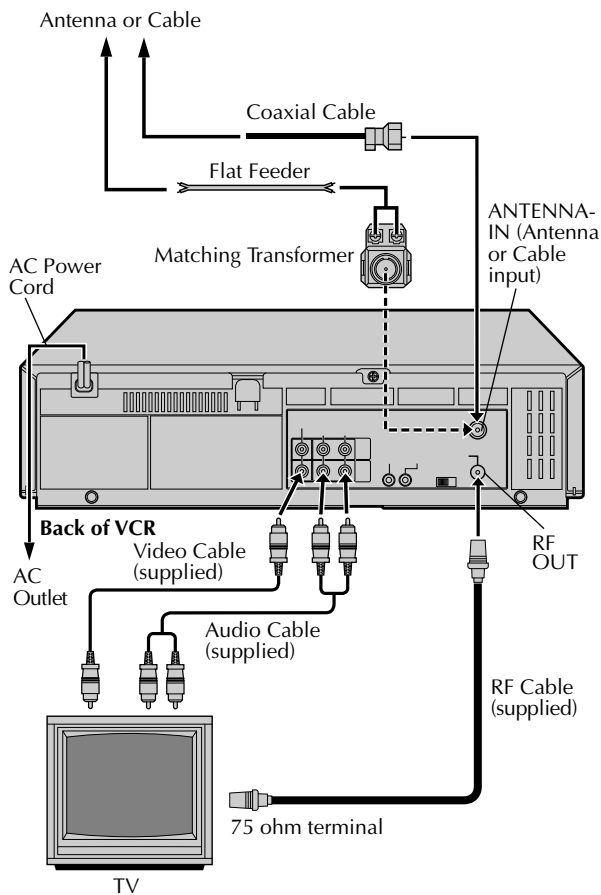

Back of VCR

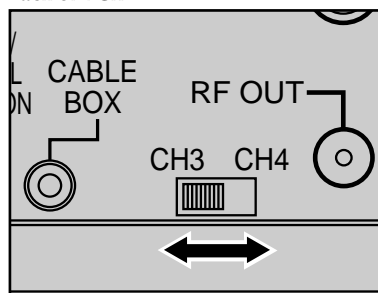

1

CHECK CONTENTS

Make sure the package contains all of the accessories listed in "SPECIFICATIONS" (☞ pg. 60).

2

SITUATE VCR

Place the VCR on a stable, horizontal surface.

3

CONNECT VCR TO TV

The connection method you use depends on the type of TV you have.

RF Connection

- To Connect To A TV With NO AV Input Terminals . . .
 - a- Disconnect the TV antenna cable from the TV.
 - b- Connect the TV antenna cable to the ANT IN jack on the rear of the VCR.
 - c- Connect the supplied RF cable between the RF OUT jack on the rear of the VCR and the TV's antenna terminal.

AV Connection

- To Connect To A TV With AV Input Terminals . . .
 - a- Connect the antenna, VCR and TV as shown in the illustration.
 - b- Connect an Audio/Video Cable (supplied) between the AUDIO OUT and VIDEO OUT jacks on the rear of the VCR and the AV IN jacks on the TV.

4

CONNECT VCR TO POWER SOURCE

Connect the power plug to an AC outlet.

- The clock and tuner will automatically be set when the antenna is connected and when the AC is first connected to the VCR (☞ pg. 7).

5

FINAL PREPARATION FOR USE

Select the VCR channel (3 or 4) by setting the switch on the rear of the VCR as shown in the illustration.

Turn on the power to the TV. You are now able to perform simple playback (☞ pg. 22) and recording (☞ pg. 23). (If 'Auto' is displayed on the front display panel, the clock is being set automatically. Wait for the time to be displayed before powering on the VCR.)

NOTES:

- The VCR channel is the channel on the TV which will display the audio and video signals from the VCR. The VCR's CH3-CH4 switch sets the VCR channel to CH3 or CH4.
- The CH3-CH4 switch is preset to the CH3 position. Set to CH4 if CH3 is used for broadcasting in your area.
- If your TV has no AV input terminals, set the channel on the TV to correspond to the CH3-CH4 switch on the back of the VCR.
- Even if your TV has AV input terminals, you must connect it to the VCR using an RF cable in order to record one show while watching another (☞ pg. 36).
- For full identification of the VCR's rear panel, refer to the Index (REAR VIEW ☞ pg. 58).

Dual Quick Set

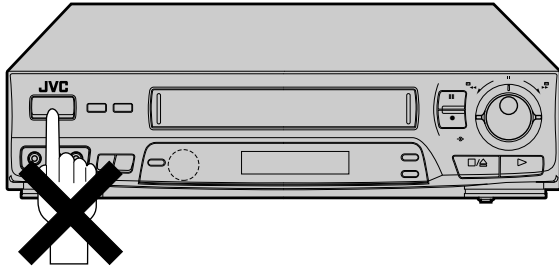

IMPORTANT

- Don't press any buttons on the VCR or remote during Dual Quick Set.
- If you perform Dual Quick Set successfully, there's no need to perform the Clock (☞ pg. 9) and Tuner (☞ pg. 12) procedures. If, however, you want to add or delete channels, refer to "Add Or Delete A Channel" on page 14.

ATTENTION CABLE BOX SUBSCRIBERS

If you perform the Dual Quick Set procedure . . .

- Select the PBS channel on your cable box before plugging your VCR's power plug into the AC outlet. (If you have more than one PBS channel, you may have to select an alternative PBS channel if Dual Quick Set is not successful.)
- If there is no PBS channel in your area, perform the Manual Clock Set procedure (☞ pg. 11).
- For automatic clock adjustment to take place the VCR's power must be off and the cable box must be set to the PBS channel at clock adjustment times.
- If you perform Dual Quick Set successfully, D.S.T. will be set to "AUTO". At the D.S.T. adjustment time (☞ pg. 11), your VCR's power must be off and your cable box must be set to the host PBS channel in your area for the D.S.T. adjustment to take place. If the clock is not set correctly, change the D.S.T. setting to "ON" or "OFF". See step 9 of Semi-Auto procedure (☞ pg. 10) or step 6 of Manual procedure (☞ pg. 11).

Dual Quick Set sets the clock and tuner channels automatically when power is first connected to the VCR. The antenna cable must be connected for dual quick set.

The time and date can be set automatically from clock setting data that is transmitted by one of the regular TV broadcast channels. We call this TV channel the "Host Channel" and it is a PBS channel in your area.

PERFORM DUAL QUICK SET

1

Make sure that the antenna cable is connected to the VCR. Then connect the VCR's power plug to an AC outlet. For connection configuration, refer to "Basic Connections" (☞ pg. 6). The clock and tuner channels will automatically be set.

- Auto clock set is performed first. The auto clock set function scans all the channels received by your VCR to find the Host Channel and then sets the clock. AUTO is displayed on the front display panel during Auto clock set.
- Auto channel is performed next. The auto channel set function scans all the channels that are receivable by your VCR. It then automatically assigns each receivable channels to the CH▲▼ buttons. It skips non-receivable channels. During auto channel set the channel numbers are displayed in ascending order.
- When Dual Quick Set has been completed successfully the correct time is displayed.
- The clock can be adjusted automatically by the Host PBS every hour on the hour (except for 11:00 PM, midnight, 1:00 AM and 2:00 AM) by the incoming PBS channel clock setting data. (This automatic clock adjustment can only be performed when the VCR's power is turned off.)
- If an incorrect time is displayed on the front display panel, you may be receiving the clock setting data of a PBS channel from an adjacent time zone, or an incorrect PBS channel from a cable TV system. In this case, perform the Semi-Auto procedure (☞ pg. 10). Auto channel set has already taken place and it need not be set again.
- If "-: -:" appears on the display, your antenna cable may not be connected to the VCR, there may not be a Host PBS signal available in your area, or your cable box may not be set to the PBS channel. If everything is connected and set correctly, perform the Manual Clock Set procedure (☞ pg. 11). Auto channel set has not yet taken place, so please also perform the "Set Receivable Channels" procedure (☞ pg. 12).

NOTE:

If, due to a power outage or other event, the memory backup fails, Dual Quick Set is performed when power is restored to the VCR.



During Auto Clock Set



During Auto Channel Set
The channels appear in ascending order, beginning with 1.



Dual Quick Set Completed
The current time (including AM/PM) is displayed.

Language

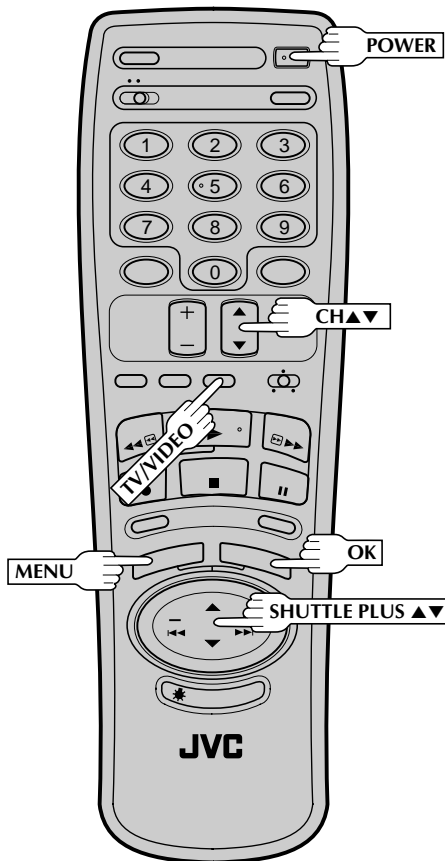
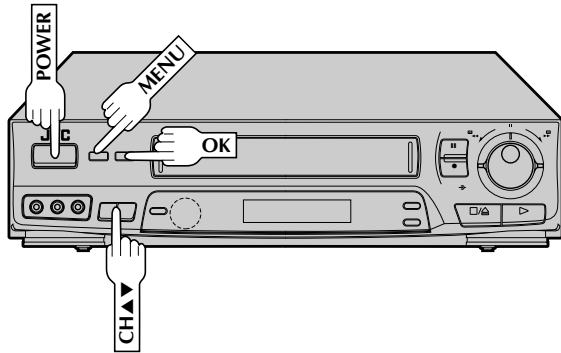

This VCR offers you the choice to view on-screen messages in English, Spanish or French (not including messages superimposed on the TV picture). Select the desired language using this procedure. The default setting is "ENGLISH".

1 TURN ON THE VCR

Press **POWER**. If watching channel 3 or 4, press **TV/VIDEO** to select the VIDEO mode. VIDEO is displayed on the front display panel.

2 ACCESS ON-SCREEN MENU

Press **MENU** as many times as necessary to bring up the Main Menu screen.

3 ACCESS CUSTOM SET SCREEN

At the Main Menu screen, place the arrow next to "CUSTOM SET" by pressing **CH▲▼** or **SHUTTLE PLUS ▲▼**, then press **OK**.

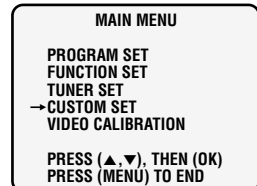

4 ACCESS LANGUAGE SELECT SCREEN

The messages are preset to appear in English. If you want to see them in Spanish or French, place the arrow next to "LANGUAGE SELECT" by pressing **CH▲▼** or **SHUTTLE PLUS ▲▼**, then press **OK**.



5 SELECT LANGUAGE

At the Language Select screen, place the arrow next to the desired language by pressing **CH▲▼** or **SHUTTLE PLUS ▲▼**, then press **MENU** as many times as necessary to return to the normal screen.



Clock

Perform clock setting only if the clock has not been set correctly by Dual Quick Set. Access the Override Auto Clock Set screen to choose the Auto, Semi-Auto or Manual clock setting procedure. Each procedure starts from step 5. *Auto need only be selected if Semi-Auto or Manual had previously been selected.

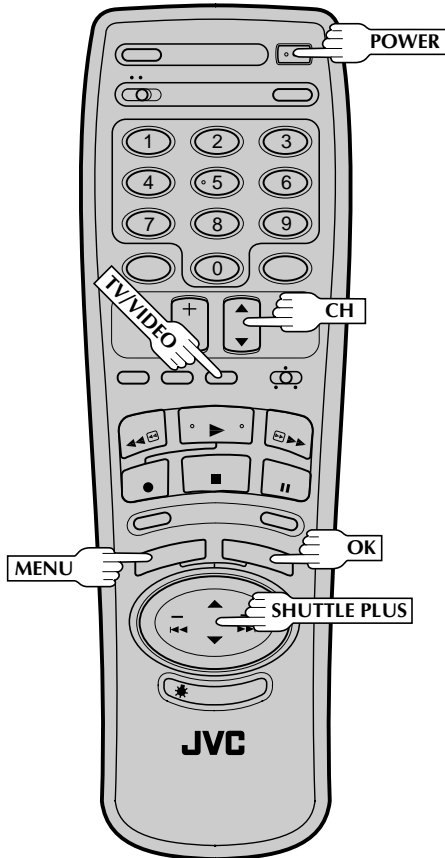
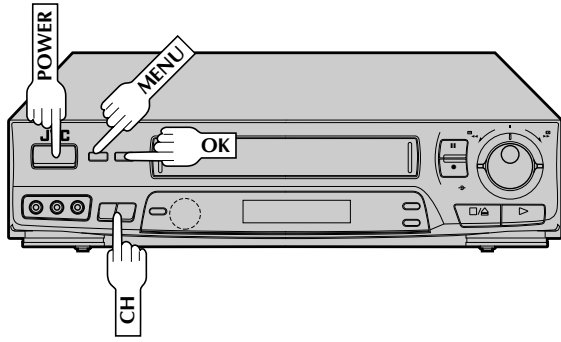

Preparation

1 TURN ON THE VCR
Press **POWER**. If watching channel 3 or 4, press **TV/VIDEO** to select the VIDEO mode. VIDEO is displayed on the front display panel.

2 ACCESS ON-SCREEN MENU
Press **MENU** as many times as necessary to bring up the Main Menu screen.

3 ACCESS CUSTOM SET SCREEN
At the Main Menu screen, place the arrow next to "CUSTOM SET" by pressing **CH▲▼** or **SHUTTLE PLUS ▲▼**, then press **OK**.



4 ACCESS OVERRIDE AUTO CLOCK SET SCREEN
Place the arrow at the Custom Set screen next to "OVERRIDE AUTO CLOCK SET" by pressing **CH▲▼** or **SHUTTLE PLUS ▲▼**, then press **OK**.



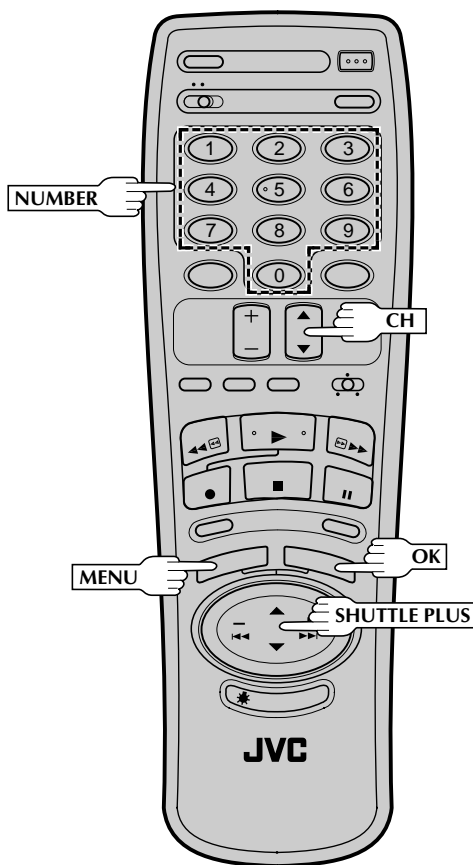
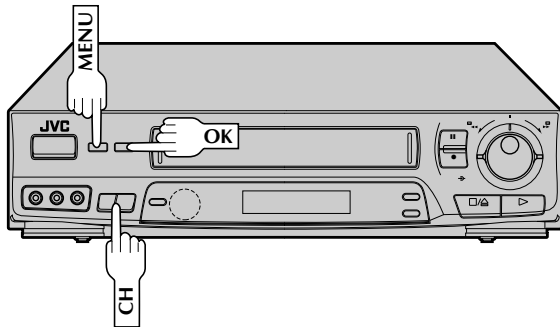

Semi-Auto

5

SELECT MODE

At the Override Auto Clock Set screen, place the arrow next to "SEMI-AUTO CLOCK SET" by pressing **CH▲▼** or **SHUTTLE PLUS ▲▼**, then press **OK**.

OVERRIDE AUTO CLOCK SET

AUTO CLOCK SET
 → SEMI-AUTO CLOCK SET
 MANUAL CLOCK SET

PRESS (▲, ▼), THEN (OK)
 PRESS (MENU) TO END

6

ACCESS SELECT SCREENS

At the Semi-Auto Clock Set screen, place the arrow next to the desired mode by pressing **CH▲▼** or **SHUTTLE PLUS ▲▼**, then press **OK**.

SEMI-AUTO CLOCK SET

→ HOST CHANNEL SELECT
 TIME ZONE SELECT
 D.S.T. SELECT

PRESS (▲, ▼), THEN (OK)
 PRESS (MENU) TO END

To select the Host Channel — step 7

To select the Time Zone — step 8

To select the D.S.T. mode — step 9

7

SELECT HOST CHANNEL

You can either select "AUTO", or enter a PBS channel number. For automatic channel selection, simply press **MENU**. To manually select the PBS channel, press the appropriate **NUMBER** key, **CH▲▼** or **SHUTTLE PLUS ▲▼** to cycle through the channel numbers (hold button down to speed through numbers) and stop when the desired number appears. Press **MENU** and the Semi-Auto Clock Set screen reappears.

HOST CHANNEL SELECT

(CATV)
 CH AUTO

PRESS (▲, ▼) TO SELECT
 PRESS (MENU) TO END

NOTES:

- For cable box users: Select "AUTO" or the channel on your VCR that receives the cable box channels, and set the cable box to the PBS channel.
- There are some PBS channels that do not transmit clock setting data.

8

SELECT TIME ZONE

You can either select "AUTO", or select the correct zone. If you selected "AUTO" in step 7 and if you live near the boundary of an adjacent time zone, or receive cable TV channels, a PBS channel from a different time zone may become your host channel. Therefore, in this case make sure to manually select the correct time zone. Place the arrow next to your choice by pressing **CH▲▼** or **SHUTTLE PLUS ▲▼**, then press **MENU** to return to the Semi-Auto Clock Set screen.

TIME ZONE SELECT

→ AUTO MOUNTAIN
 ATLANTIC PACIFIC
 EASTERN ALASKA
 CENTRAL HAWAII

PRESS (▲, ▼) TO SELECT
 PRESS (MENU) TO END

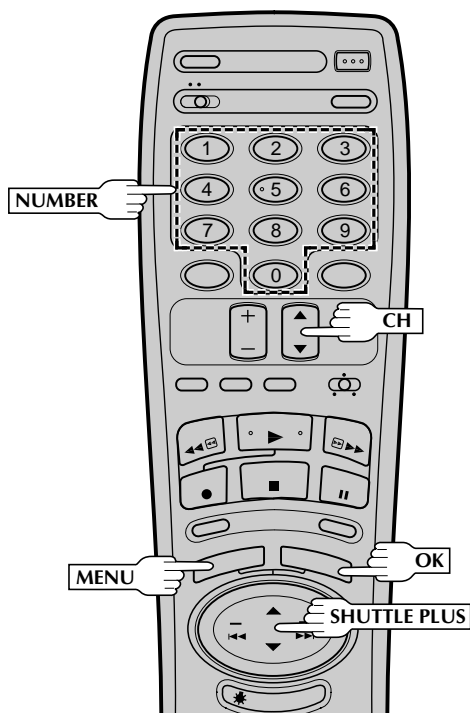
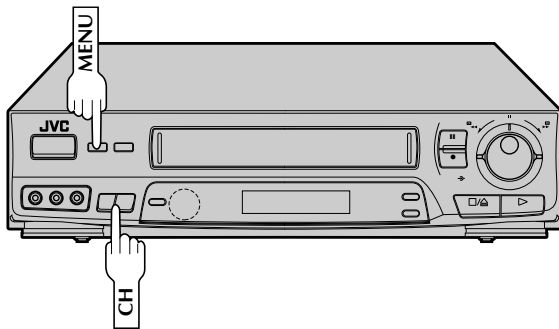

**AUTO DAYLIGHT SAVING TIME

This function enables automatic adjustment of the VCR's clock at the start and end of Daylight Saving Time. With Auto DST activated, . . .
 . . . on the first Sunday of April at 2:00 AM, the clock is adjusted to 3:00 AM.
 . . . on the last Sunday of October at 2:00 AM, the clock is adjusted to 1:00 AM.

Auto

5

SELECT MODE

At the Override Auto Clock Set screen, place the arrow next to "AUTO CLOCK SET" by pressing **CH▲▼** or **SHUTTLE PLUS ▲▼**, then power off the VCR. Do not power it on again until the clock has been adjusted. The clock is automatically adjusted on the hour except at 11:00 PM, midnight, 1:00 AM and 2:00 AM.

9

SELECT D.S.T. MODE

You have three choices:
a–Select "AUTO" and the adjustment to your VCR's clock will be made according to the incoming signal from the host channel.
b–Select "ON" and the adjustment will be made based on the clock itself.
c–Select "OFF" if Daylight Saving Time doesn't apply to you.

D.S.T. SELECT

→AUTO
ON
OFF

PRESS (▲, ▼) TO SELECT
PRESS (MENU) TO END

Place the arrow next to your choice by pressing **CH▲▼** or **SHUTTLE PLUS ▲▼**, then press **MENU** and the Semi-Auto Clock Set screen reappears.

IMPORTANT

After setting the Semi-Auto clock set, make sure that the VCR is off before the next hour so that the clock can be adjusted. (The clock is automatically adjusted on the hour except at 11:00 PM, midnight, 1:00 AM and 2:00 AM.)

Manual

5

SELECT MODE

At the Override Auto Clock Set screen (pg. 10), place the arrow next to "MANUAL CLOCK SET" by pressing **CH▲▼** or **SHUTTLE PLUS ▲▼**, then press **OK**.

6

SET DATE, TIME AND D.S.T.

The Manual Clock Set screen is displayed and the first setting that can be set begins flashing. Press the appropriate **NUMBER** keys to set the date and time (if only 1 digit, press "0" first). Press **CH▲▼** or **SHUTTLE PLUS**

MANUAL CLOCK SET

DATE 1/1/96 MON
TIME --:-- AM
D.S.T. ON

PRESS NUMBER KEY(0-9)
OR (▲, ▼), THEN (OK)
PRESS (MENU) TO END

▲▼ to set AM/PM and D.S.T. (Daylight Saving Time) to "ON" (automatic adjustment based on VCR's clock) or "OFF" (if D.S.T. doesn't apply to you).

Press **OK** after AM/PM and D.S.T. settings. The next setting that can be set begins flashing. When you're finished with this set-up procedure, press **MENU** to start the clock.

NOTE:

CH▲▼ and **SHUTTLE PLUS ▲▼** can be used to perform all operations. (In this case, press **OK** after each setting.)

7

MAKE CORRECTIONS

To change any of the settings, press **OK** or **SHUTTLE PLUS** **◀▶** until the item you want to change blinks, then set as in step 6.

Tuner

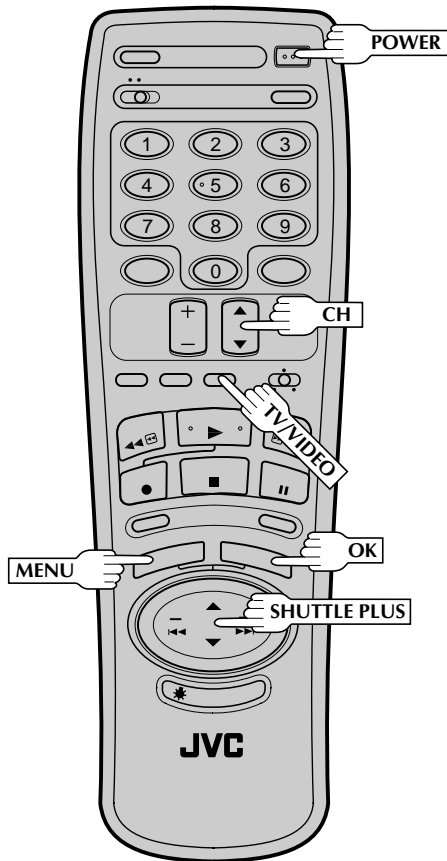
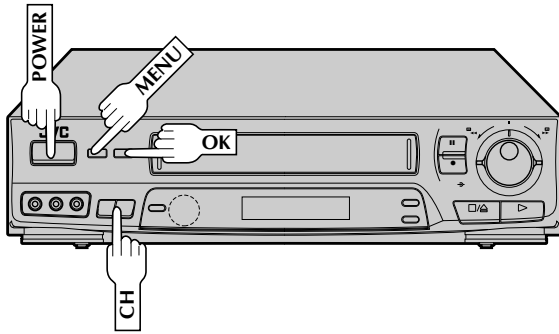

Set Receivable Channels

1

TURN ON THE VCR

Press **POWER**. If watching on channel 3 or 4, press **TV/VIDEO** to select the VIDEO mode. VIDEO is displayed on the front display panel.

2

ACCESS MAIN MENU SCREEN

Press **MENU** as many times as necessary.

3

ACCESS TUNER SET SCREEN

Place the arrow next to "TUNER SET" by pressing **CH▲▼** or **SHUTTLE PLUS ▲▼**, then press **OK**.

4

ACCESS BAND SCREEN

Place the arrow next to "BAND" by pressing **CH▲▼** or **SHUTTLE PLUS ▲▼**, then press **OK**.

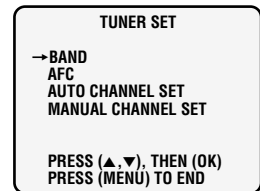

5

SET FREQUENCY BAND

If you receive your TV channels from an external antenna, select "TV". If you receive your TV channels from a cable TV system, select "CATV".

Place the arrow next to your choice by pressing **CH▲▼** or **SHUTTLE PLUS ▲▼**, then press **MENU** to return to the Tuner Set screen.

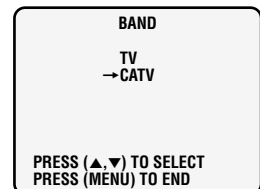

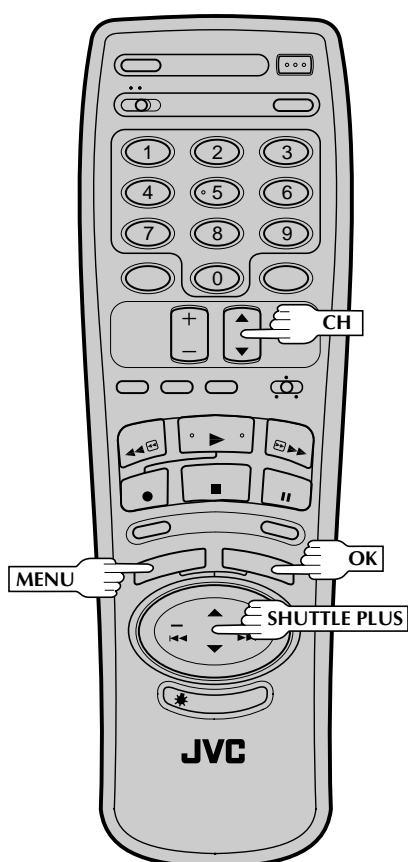
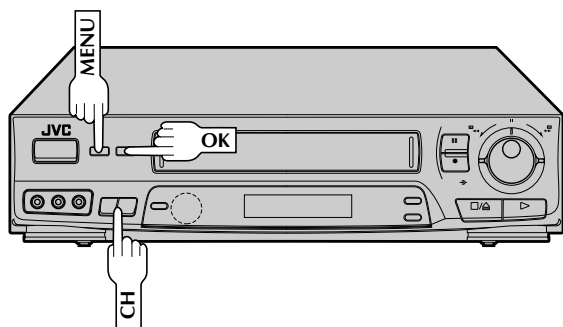

6

PERFORM AUTO CHANNEL SET

Place the arrow next to "AUTO CHANNEL SET" by pressing **CH▲▼** or **SHUTTLE PLUS ▲▼**, then press **OK**. Receivable channels in your area are automatically assigned to the **CH▲▼** buttons, and non-receivable channels are skipped.

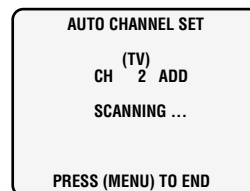

NOTES:

- At the end of Auto Channel Set, "SCAN COMPLETED" appears on screen.
- If the scan was unsuccessful, "SCAN COMPLETED-NO SIGNAL" appears on screen. Check the band setting and connections and start again.

RETURN TO NORMAL SCREEN

7

Press **MENU** as many times as necessary.

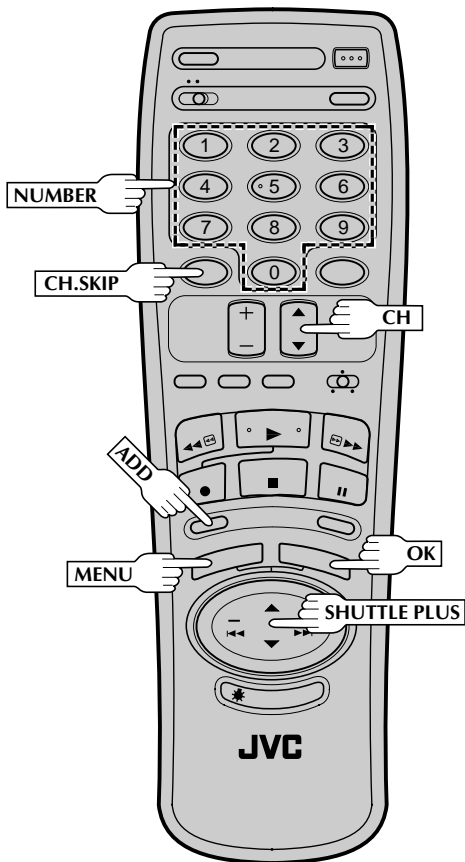
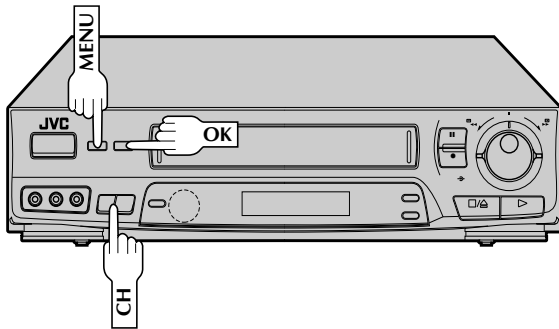

Add Or Delete A Channel

1

ACCESS TUNER SET SCREEN

Access by performing steps 2 and 3 of the Tuner procedure on page 12.

- To add a channel, go to step 2.
- To delete a channel, skip to step 4.

2

ACCESS AFC SCREEN

Place the arrow next to "AFC" by pressing **CH▲▼** or **SHUTTLE PLUS ▲▼**, then press **OK**.

3

MAKE SELECTION

Place the arrow next to "SPCL" by pressing **CH▲▼** or **SHUTTLE PLUS ▲▼**, then press **MENU** to return to the Tuner Set screen.

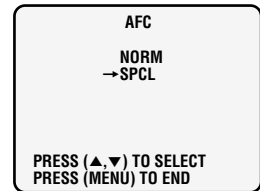

4

ACCESS MANUAL CHANNEL SET SCREEN

Place the arrow next to "MANUAL CHANNEL SET" by pressing **CH▲▼** or **SHUTTLE PLUS ▲▼**, then press **OK**.

5

STORE DESIRED CHANNEL

Input the channel number using the **NUMBER** keys or by pressing **CH▲▼** or **SHUTTLE PLUS ▲▼**, then press **ADD** to add or **CH.SKIP** to delete. Repeat for each channel you want to store or skip.

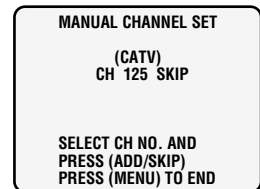

6

RETURN TO NORMAL SCREEN

Press **MENU** as many times as necessary.

Tuner And Cable Box Controller

Suggested Location

Place the cable box on top of the VCR. Attach the VCR's Cable Box Controller to the top of the VCR with the Controller's transmitter pointed towards the cable box's remote sensor.

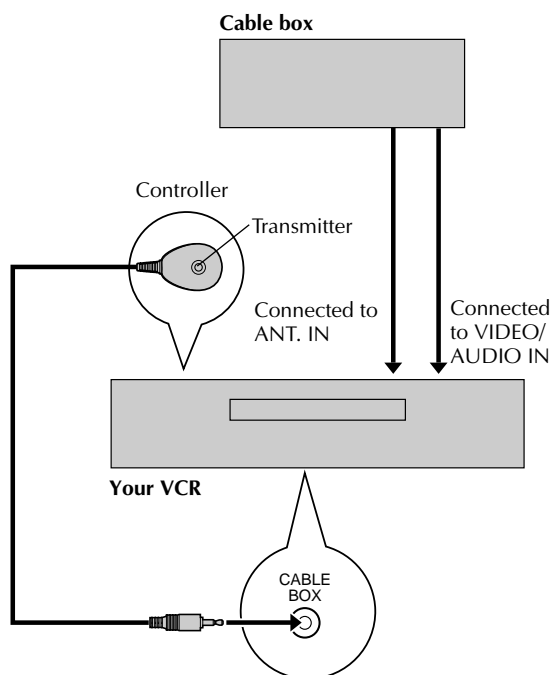
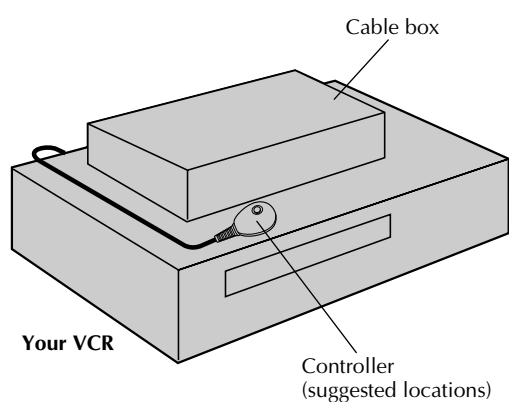

This procedure is required if you receive your TV channels through a cable box (descrambler). The Cable Box Controller allows the VCR to automatically switch cable box channels, allowing you to timer-record programs from various cable stations. The Cable Box Controller is effective for recording shows that have been programmed using VCR Plus+ (pg. 38) or On-Screen Timer Programming (pg. 40).

Situate And Connect Controller

SITUATE CONTROLLER

1 Place the Cable Box Controller so that the path between its transmitter and the cable box's remote sensor is unobstructed.

ATTACH CONTROLLER

2 Fasten securely using the supplied adhesive strips.

CONNECT CABLE BOX TO VCR

3 The connection method depends on the type of cable box you have.

If your cable box has AUDIO and VIDEO OUT connectors . . .

. . . connect them to the AUDIO and VIDEO IN connectors on your VCR.

If your cable box doesn't have AUDIO and VIDEO OUT connectors . . .

. . . connect the antenna output connector on the cable box to the ANT.IN connector on the rear of your VCR.

NOTE:

Refer to your cable box's instruction manual during connection.

CONNECT CONTROLLER TO VCR

4 Connect to the CABLE BOX connector on your VCR.

About Your Cable Box

This VCR has two separate methods to control your Cable Box.

- *The VCR's Wireless Remote Control Unit can control your Cable Box. This eliminates the need for a separate Cable Box Remote Control Unit.*
- *The VCR's Cable Box Controller can also control your Cable Box. This allows the VCR to change your Cable Box's channel number during timer recording.*

Each method must be set up separately. To set up the VCR's Remote Control unit, refer to page 51. To set up the Cable Box Controller go to page 16.

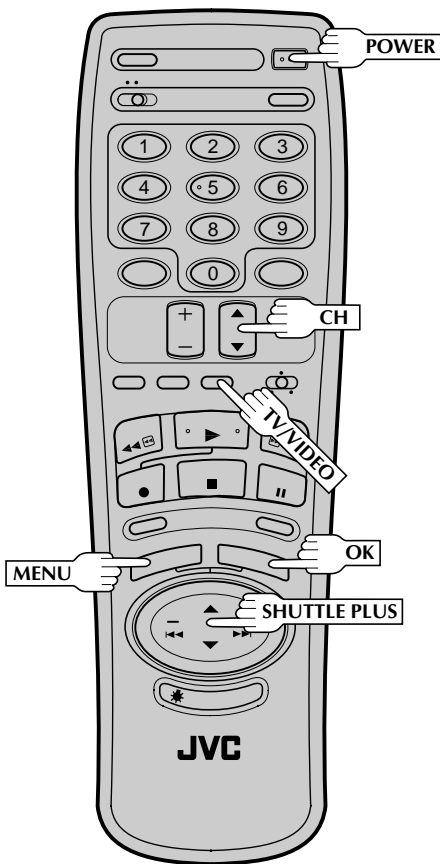
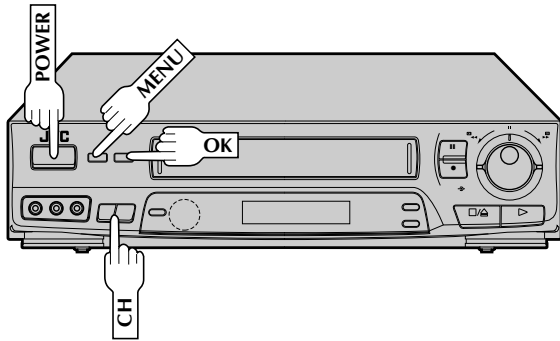

Set Cable Box Output Channel

1 TURN ON THE VCR
 Press **POWER**. If watching channel 3 or 4, press **TV/VIDEO** to select the VIDEO mode. VIDEO is displayed on the front display panel.

2 ACCESS MAIN MENU SCREEN
 Press **MENU** as many times as necessary.

3 ACCESS CUSTOM SET SCREEN
 Press **CH▲▼** or **SHUTTLE PLUS ▲▼** to place the arrow next to "CUSTOM SET", then press **OK**.



4 ACCESS VCR PLUS+ SET-UP SCREEN
 Press **CH▲▼** or **SHUTTLE PLUS ▲▼** to place the arrow next to "VCR PLUS+ SET-UP", then press **OK**.



5 ACCESS CABLE BOX OUTPUT SCREEN
 Press **CH▲▼** or **SHUTTLE PLUS ▲▼** to place the arrow next to "CABLE BOX OUTPUT", then press **OK**.



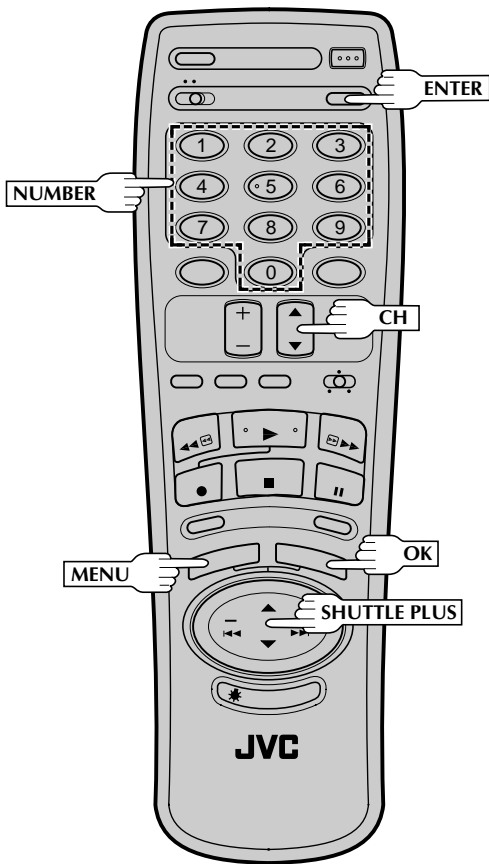
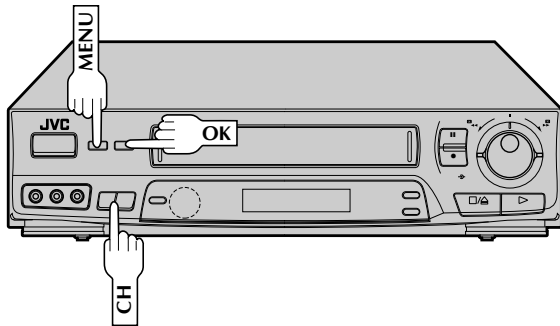

6 SELECT CABLE BOX OUTPUT CHANNEL

Your selection depends on how your cable box is connected to your VCR.

If your cable box is connected to your VCR using an RF connection . . .

. . . press CH▲▼ or SHUTTLE PLUS ▲▼ to place the arrow next to the channel number representing the cable box's output (2-6).

If your cable box is connected to your VCR's AUDIO/VIDEO IN connectors . . .

. . . press CH▲▼ or SHUTTLE PLUS ▲▼ to place the arrow next to "ON LINE".

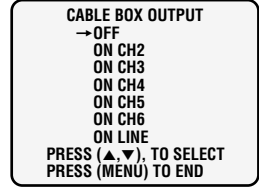

7 RETURN TO VCR PLUS+ SET-UP SCREEN

Press MENU.

Set Cable Box Brand

1 TURN ON CABLE BOX

Select a channel other than channel 9 on your Cable Box.

2 ACCESS CABLE BOX BRAND SET SCREEN

At the VCR Plus+ Set-Up screen, press CH▲▼ or SHUTTLE PLUS ▲▼ to place the arrow next to "CABLE BOX BRAND SET", then press OK.



3 ENTER CABLE BOX BRAND

Press the appropriate NUMBER keys to enter the Cable Box Code from the CABLE BOX BRAND LIST on page 18, then press ENTER.



- If the cable box's channel changes to 9, setting is complete.
- If there are more than one code number listed for your brand of cable box, repeat step 3 until the cable box's channel changes to 9.
- If you go through all listed code numbers and the channel doesn't change, try all other numbers between 1 and 69.

CONTINUED ON NEXT PAGE.

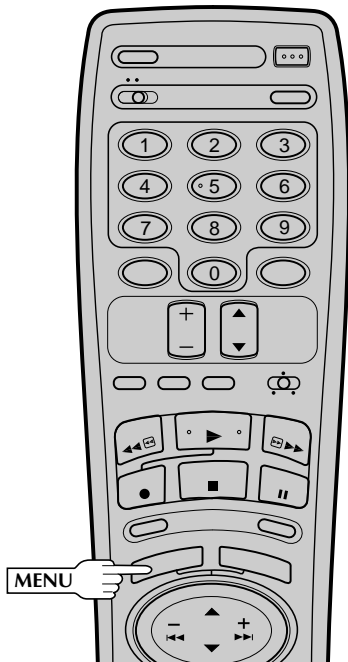
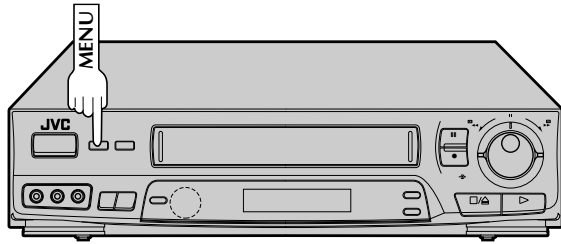

4 RETURN TO NORMAL SCREEN

Press MENU as many times as necessary.

You can now set up the VCR Plus+ feature (pg. 19).

CABLE BOX BRAND LIST

BRAND	CODE
ARCHER	49, 52, 53, 54
CABLEVIEW	49, 53
CITIZEN	49, 53
CURTIS	9, 10, 62, 63
DIAMOND	52, 53, 54
EAGLE	30, 31, 32, 33, 34, 35, 36, 37
EASTERN	51
GC BRAND	49, 53
GEMINI	8, 56
GENERAL ELECTRIC	67
GENERAL INSTRUMENTS	1, 2, 3, 4, 5, 6, 7, 8
HAMLIN	15, 16, 17, 18
JERROLD	1, 2, 3, 4, 5, 6, 7, 8
MACOM, HITACHI	57, 58, 59
MAGNAVOX	30, 31, 32, 33, 34, 35, 43
MOVIE TIME	44, 45, 46
NSC	44, 45, 46
OAK	19, 20, 21, 30, 47, 48
PANASONIC	24, 25, 26
PHILIPS	30, 31, 32, 33, 42
PIONEER	13, 14
PULSER	49, 53
RCA	24, 25, 26
REGAL	15, 16, 17, 18, 33
REGENCY	51
SAMSUNG	8, 13, 49, 50
SCIENTIFIC ATLANTA	9, 10, 62, 63
SIGMA	19, 20, 21
SL MARX	8, 13, 49, 50
SPRUCER	24, 25, 26
STARGATE	8, 13, 49, 50
SYLVANIA	29
TEKNIKA	68, 69
TELECATION	27
TELEVIEW	8, 13, 49, 50
TEXSCAN	28, 29
TOCOM	22, 23, 64, 65, 66
UNIKA	52, 53, 54
UNIVERSAL	38, 39, 40, 41
VIDEOWAY	11, 12, 60, 61
VIDEO TECH	55
VIDTER	55
VIEWSTAR	30, 31, 32, 33, 34, 35, 36, 37
ZENITH	11, 12, 60, 61

NOTES:

- Although the supplied Cable Box Controller is compatible with many different cable box brands, it is possible that it will not work with your cable box.
- If your cable box doesn't respond to any code between 1 and 69, you can't use the Controller to change cable box channels. In this case, make sure to leave the cable box turned on and tuned to the proper channel before the scheduled start of timer recording. Please contact your cable company about the possibility of exchanging your current cable box with one that is compatible with your VCR.
- The VCR can only change the cable box channel through the Cable Box Controller during timer recording.
- If your cable box is one that can't be operated with a remote control (has no remote sensor), you can't use the Cable Box Controller to change its channels. Make sure to leave the cable box turned on and tuned to the proper channel before the scheduled start of timer recording.
- If you are unable to set the Cable Box Controller, please contact JVC toll free at 1-800-252-5722.

VCR Plus+ Setup

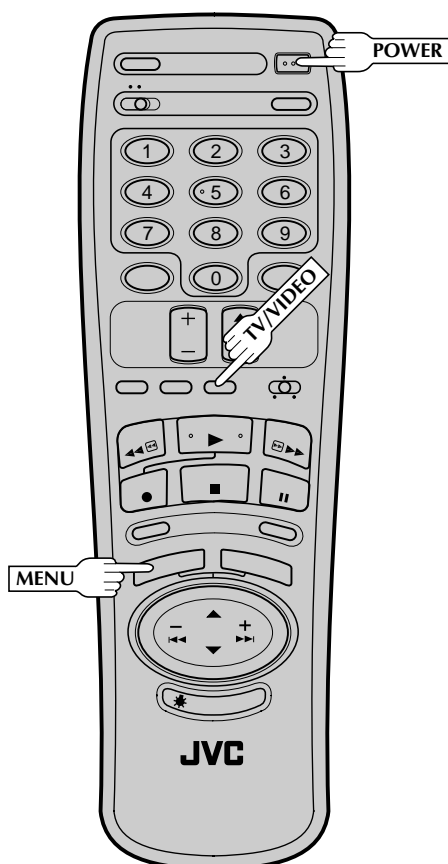
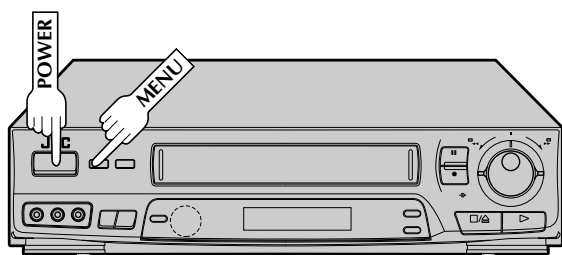

The VCR Plus+ timer programming system eliminates the need to input channel, date, start and stop time data when setting the timer record function. Simply key in the PlusCode number for the TV program you wish to record (found in most TV listings) and the VCR's timer is automatically programmed.

Depending on the TV or cable stations that you receive and the channel numbers that they are received on in your area, you may have to make certain changes in your VCR's "Guide Channel Set" menu to get proper results. Please read the following information carefully to find out which tasks you need to perform.

Before VCR Plus+ setup you must have performed the following procedures:

- Dual Quick setting (☞ pg. 7)

or

- Clock setting (☞ pg. 9)
- Tuner setting (☞ pg. 12)
- Tuner and cable box setting if you receive your TV channels through a cable box (☞ pg. 15)

Channel Number Matching

Most TV listings have a chart indicating the "Guide Channel" number assigned to each station for purposes of VCR Plus+ programming. Check the chart in your TV listings and see if the Guide Channel numbers listed for the stations you receive are the same as the channel number on which each is received by your VCR or cable box.

SPECIAL NOTES FOR CABLE SUBSCRIBERS

- In many instances, cable TV stations have VCR Plus+ Guide Channel numbers that **DO NOT** match the number of the channel on which you receive the station. Check your TV listings, or contact your cable supplier for details.
- Many normal broadcast TV stations can be viewed on cable. Check your TV listing, or contact your cable supplier for details.

If the numbers match, go directly to "VCR Plus+ Timer Programming" (☞ pg. 38).

If the numbers are different, and you want to be able to timer record programs from those stations, you have to inform the VCR of the mismatch. Go to step 1. If you will not want to timer record from those stations, you can go directly to "VCR Plus+ Timer Programming" (☞ pg. 38).

1 TURN ON THE VCR

Press **POWER**. If watching channel 3 or 4, press **TV/VIDEO** to select the TV's VIDEO mode. VIDEO is displayed on the front display panel.

2 ACCESS MAIN MENU SCREEN

Press **MENU** as many times as necessary.

CONTINUED ON NEXT PAGE.

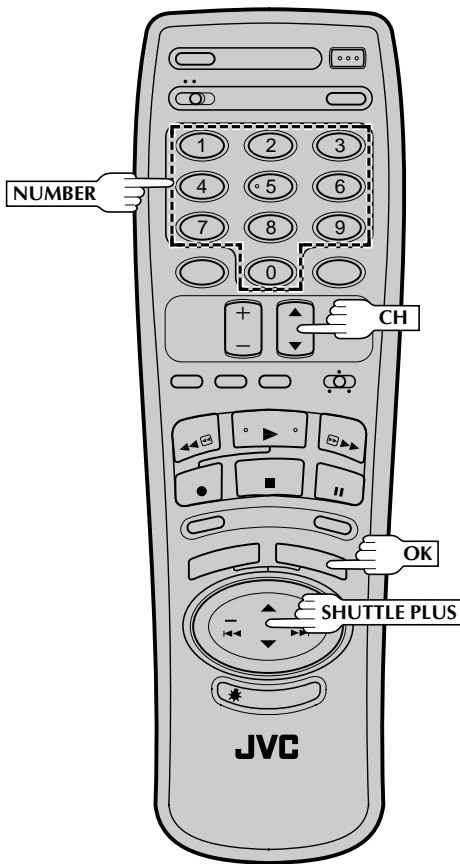
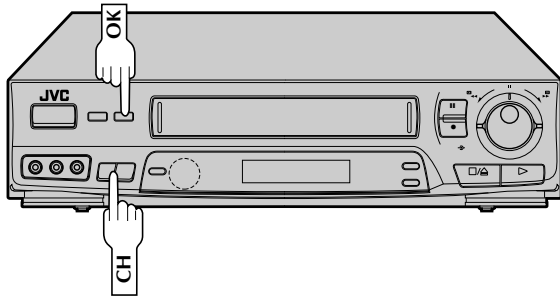

3

ACCESS CUSTOM SET SCREEN

Press **CH▲▼** or **SHUTTLE PLUS ▲▼** to place the arrow next to "CUSTOM SET", then press **OK**.



4

ACCESS VCR PLUS+ SET-UP SCREEN

Press **CH▲▼** or **SHUTTLE PLUS ▲▼** to place the arrow next to "VCR PLUS+ SET-UP", then press **OK**.



5

ACCESS GUIDE CHANNEL SET SCREEN

Press **CH▲▼** or **SHUTTLE PLUS ▲▼** to place the arrow next to "GUIDE CHANNEL SET", then press **OK**.



6

INPUT GUIDE CHANNEL NUMBER

Press **CH▲▼**, **SHUTTLE PLUS ▲▼** or the appropriate **NUMBER** keys to input the Guide Channel number as shown in the TV listing. Then press **OK**.

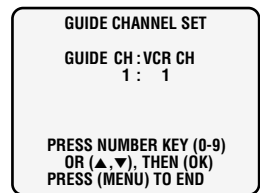

- If you receive your channels with a cable box and if you have properly set your Cable Box Controller, "CABLE CH" appears in place of "VCR CH". If not, refer to pages 15-16 and re-perform the procedure.

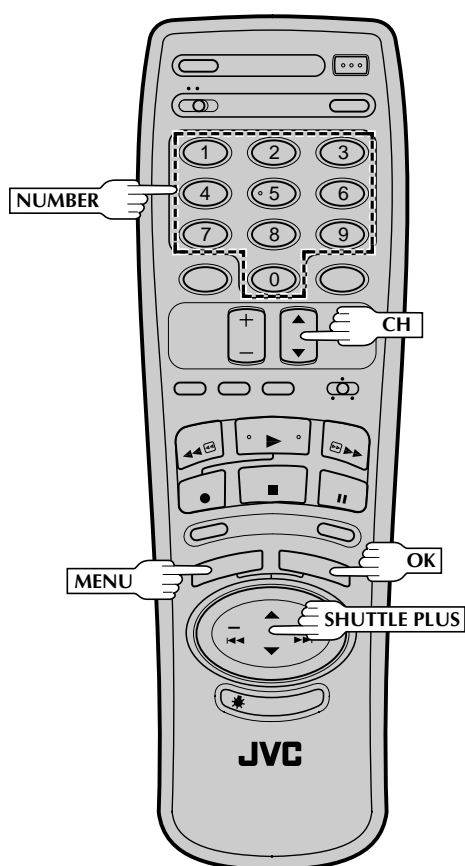
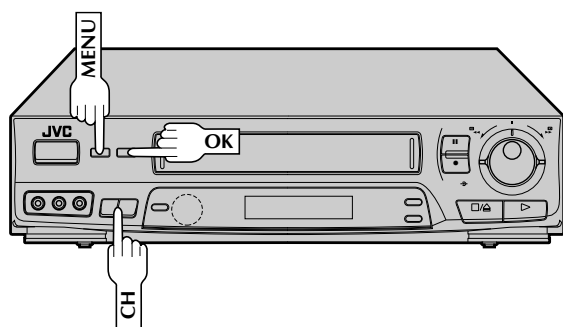

7 INPUT RECEIVING CHANNEL NUMBER

Press **CH**▲▼, **SHUTTLE PLUS** ▲▼ or the appropriate **NUMBER** keys to input the number of the channel on which the Guide Channel's broadcasts are received. Then press **OK**.

- If there is more than one mismatch, repeat steps 6 and 7 for each instance.

8 RETURN TO VCR PLUS+ SET-UP SCREEN

Press **MENU**.

9 CHECK INPUT DATA

Press **CH**▲▼ or **SHUTTLE PLUS** ▲▼ to place the arrow next to "GUIDE CHANNEL MAP", then press **OK**.

- The Guide Channel and VCR or cable box channel numbers you input appear on the screen in ascending order. Check to ensure you've entered them correctly.
- If you entered more than 10 sets of numbers, press **OK** to see the next set of numbers.

VCR PLUS+ SET-UP

GUIDE CHANNEL SET
→ GUIDE CHANNEL MAP
CABLE BOX OUTPUT
CABLE BOX BRAND SET

PRESS (▲, ▼), THEN (OK)
PRESS (MENU) TO END

GUIDE CHANNEL MAP

GUIDE : VCR	GUIDE : VCR
6 : 47	10 : 55
12 : 41	15 : 38
33 : 28	67 : 49

PRESS (OK) TO NEXT
PRESS (MENU) TO END

10 RETURN TO NORMAL SCREEN

Press **MENU** as many times as necessary.

You can now use VCR Plus+ for quick and simple timer programming (pg. 38).

Simple Playback

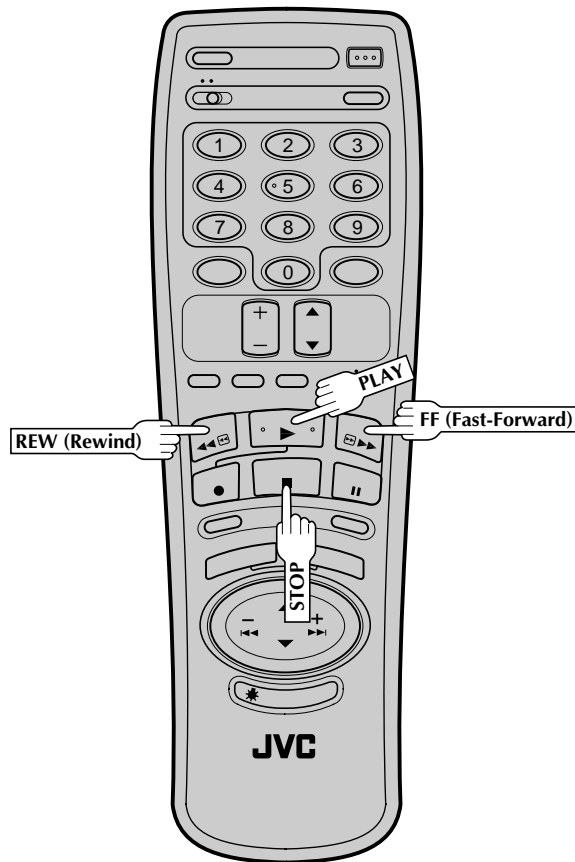
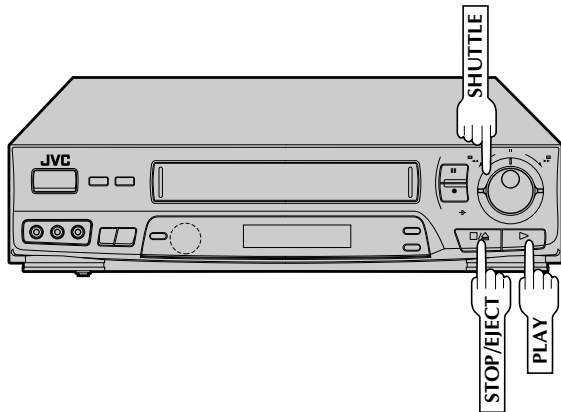

1 LOAD A CASSETTE

Make sure the window side is up, the rear label side is facing you and the arrow on the front of the cassette is pointing towards the VCR. Don't apply too much pressure when inserting.

- The VCR's power comes on automatically.
- The counter is automatically reset to "0H 00M 00S".
- If the cassette's record safety tab has been removed, playback begins automatically.

2 FIND PROGRAM START POINT

If the tape is advanced past the start point, press **REW** or turn the **SHUTTLE** ring to the left and release it. To go forward, press **FF** or turn the **SHUTTLE** ring to the right and release it.

3 START PLAYBACK

Press **PLAY**. "VIDEO CALIBRATION" appears on screen (see pg. 35).

4 STOP PLAYBACK

Press **STOP** or **STOP/EJECT**. Then press **STOP/EJECT** to remove the cassette.

Usable cassettes

Full-Size VHS
T-30 (ST-30**)
T-60 (ST-60**)
T-90
T-120 (ST-120**)
T-160 (ST-160**)
ST-210**

Compact VHS*
TC-20 (ST-C20**)
TC-30 (ST-C30**)
TC-40 (ST-C40**)

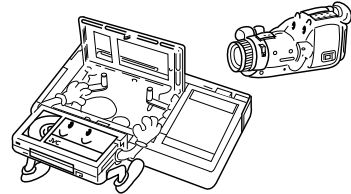

* Compact VHS camcorder recordings can be played on this video recorder. Simply place the recorded cassette into a VHS Cassette Adapter and it can be used just like any full-sized VHS cassette.

** This video recorder can record on regular VHS and Super VHS cassettes. However, it will record and play back regular VHS signals only. It is not possible to play back Super VHS recordings.

Simple Recording

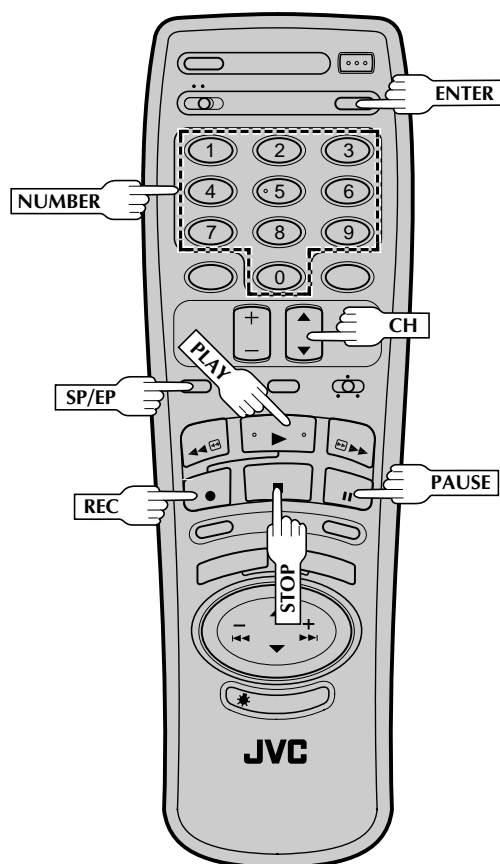
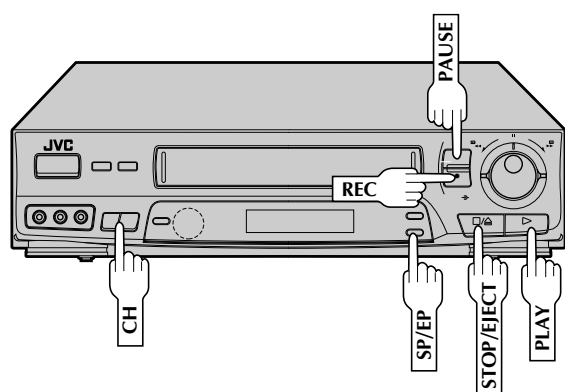

1 LOAD A CASSETTE

Make sure the record safety tab is intact. If not, cover the hole with adhesive tape before inserting the cassette.

2 SELECT RECORDING CHANNEL

Press **CH▲▼**. Or press the appropriate **NUMBER** keys, then press **ENTER**. (The channel changes after a few seconds whether you press **ENTER** or not.)

3 SET TAPE SPEED

Press **SP/EP** to set the recording speed.

4 START RECORDING

Press and hold **REC** and press **PLAY** on the remote control, or press **REC** on the VCR's front panel.

Active Video Calibration takes place at the beginning of both the first SP and the first EP recording after inserting the cassette (see pg. 34).

5 PAUSE/RESUME RECORDING

Press **PAUSE**. Press **PLAY** to resume recording.

- During record pause, you can change the recording channel by using the **CH▲▼** buttons.

6 STOP RECORDING

Press **STOP** or **STOP/EJECT**. Then press **STOP/EJECT** to remove the cassette.

Accidental erasure prevention

- To prevent accidental recording on a recorded cassette, remove its record safety tab. To record on it later, cover the hole with adhesive tape.

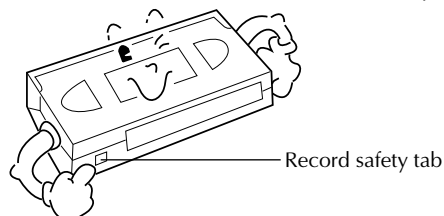

Playback

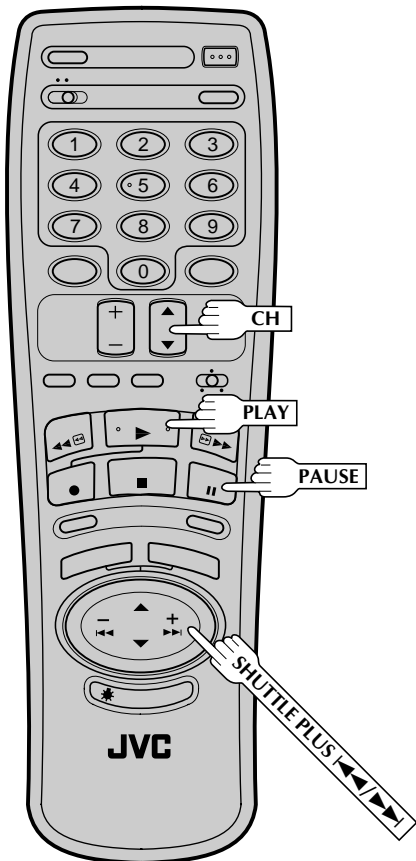
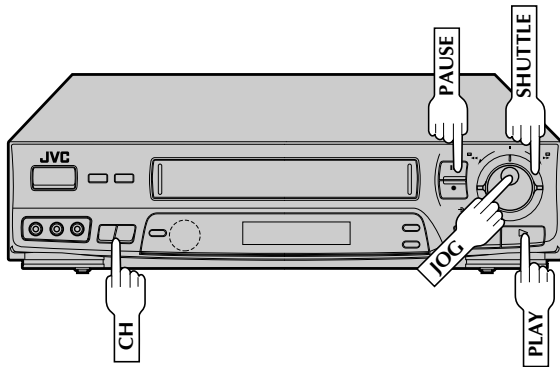

Take advantage of special functions possible with the recorder's controls or the remote control.

NOTE:

Refer to the **SHUTTLE** ring illustration below as you read the following procedures.

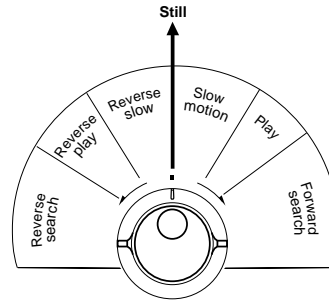

Still Picture/Frame-By-Frame Playback

1 PAUSE DURING PLAYBACK

Press **PAUSE**. If there is vertical jitter, use the **CH** ▲ or ▼ button to correct the picture.

2 ACTIVATE FRAME-BY-FRAME PLAYBACK

Turn the **JOG** dial to the right for forward frame-by-frame playback, or to the left for reverse frame-by-frame playback.

OR

Press **PAUSE**.

OR

Press **SHUTTLE PLUS** ◀◀ or ▶▶.

To resume normal playback, press **PLAY**.

Slow Motion/Reverse Slow Motion

1 ACTIVATE SLOW-MOTION PLAYBACK

During playback or still, turn the **SHUTTLE** ring to the right for forward slow motion, or to the left for reverse slow motion (refer to the illustration above).

To resume normal playback, press **PLAY**.

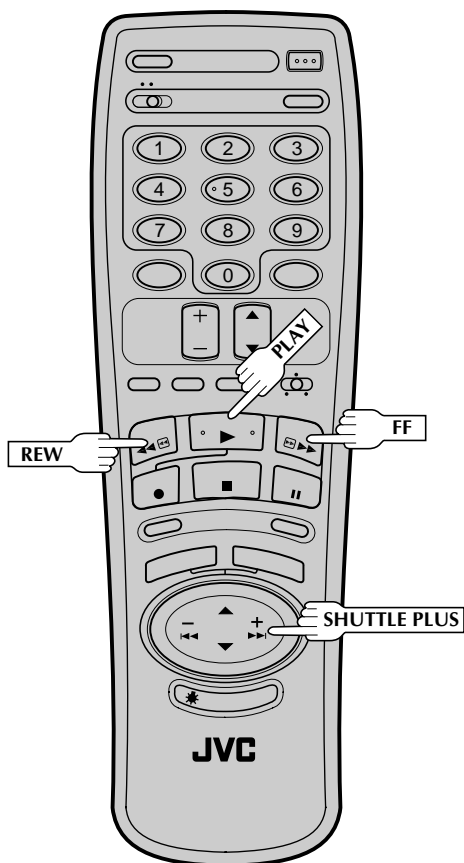
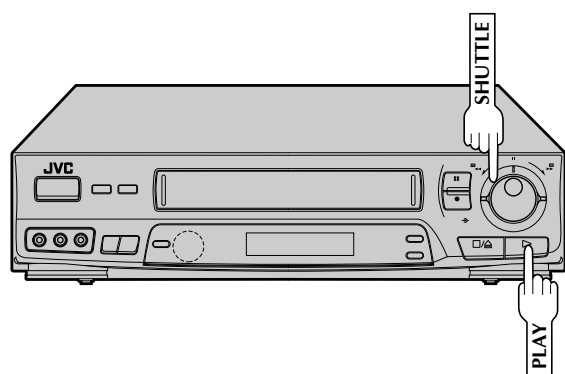

Variable-Speed Search/ Reverse Play

1 ACTIVATE VARIABLE-SPEED SEARCH

During playback or still, turn the **SHUTTLE** ring to the right for forward variable-speed search, or to the left for reverse variable-speed search (refer to the illustration on page 24).

OR

During playback, press **SHUTTLE PLUS** ◀◀ or ▶▶.

- To increase the speed in the forward direction, press ▶▶.
- To decrease the speed in the forward direction, press ◀◀.
- To play in reverse slow motion, and in reverse play mode, continue to press ◀◀ after selecting all the forward slow motion modes.

To resume normal playback, press **PLAY**.

High-Speed Search

1 ACTIVATE HIGH-SPEED SEARCH

During playback or still, turn the **SHUTTLE** ring all the way to the right for forward high-speed search, or to the left for reverse high-speed search.

- For forward search with a visible picture, during playback or still turn the **SHUTTLE** ring all the way to the right and release it within 1 second.
- For reverse search with a visible picture, during playback or still turn the **SHUTTLE** ring all the way to the left and release it within 1 second.

OR

During playback or still press **FF** for forward high-speed search, or **REW** for reverse high-speed search.

To resume normal playback, press **PLAY**.

NOTE:

For short searches, during playback or still press and hold **FF** or **REW** for over 2 seconds. When released, normal playback resumes.

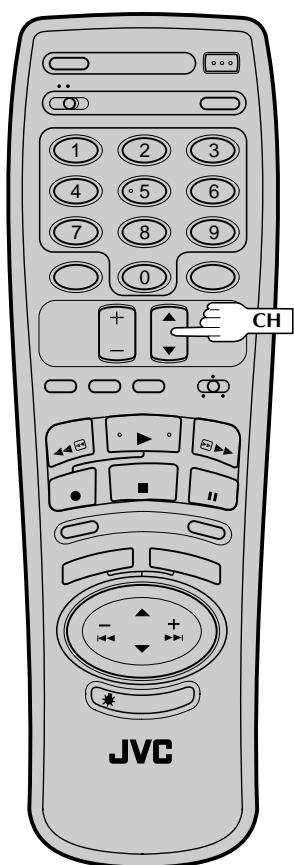
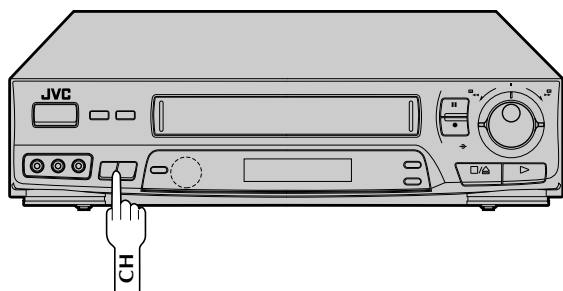

Manual Tracking

Once playback begins, the VCR's automatic tracking function is engaged. If noise appears in the picture, you can override this and make the adjustment manually.

1

ENGAGE MANUAL TRACKING MODE

During playback, press the **CH▲▼** buttons on the VCR's front panel simultaneously to cancel the automatic tracking mode and enable manual tracking adjust.

2

ADJUST MANUAL TRACKING

Press **CH▲▼** on the VCR's front panel or remote. Press lightly for fine adjust, or press and hold for coarse adjust. Watch the screen and continue adjusting until optimum picture and sound quality are achieved.

3

RE-ENGAGE AUTOMATIC TRACKING

Press the **CH▲▼** buttons on the VCR's front panel simultaneously.

- When automatic tracking is re-engaged, video calibration is automatically activated.

NOTE:

During slow-motion playback, simply press **CH▲** or **▼** on the VCR's front panel or remote to adjust tracking.

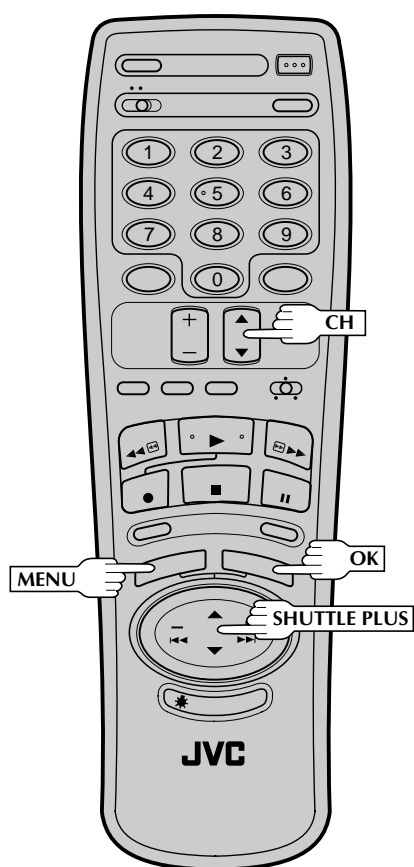
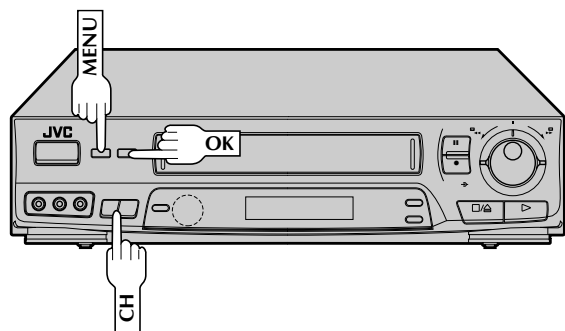

Select The Soundtrack

Your VCR can record two soundtracks simultaneously (Normal and Hi-Fi) and play back the selected one, or both together.

1

ACCESS MAIN MENU SCREEN

Press **MENU** during playback or when VCR is in stop mode.

- If the VCR Plus+ screen appears press **MENU** again.

2

ACCESS FUNCTION SET SCREEN

Place the arrow next to "FUNCTION SET" by pressing **CH▲▼** or **SHUTTLE PLUS ▲▼**, then press **OK**.

3

ACCESS AUDIO MONITOR SCREEN

Place the arrow next to "AUDIO MONITOR" by pressing **CH▲▼** or **SHUTTLE PLUS ▲▼**, then press **OK**.

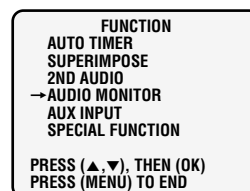

4

SELECT MODE

You have three choices:

- a- Hi-Fi
- b- Normal
- c- Mix

Place the arrow next to your choice by pressing **CH▲▼** or **SHUTTLE PLUS ▲▼**.



5

RETURN TO NORMAL SCREEN

Press **MENU** as many times as necessary.

NOTE:

If the tape being played back has no Hi-Fi soundtrack, the Normal soundtrack will be heard no matter what choice you make at the Audio Monitor screen.

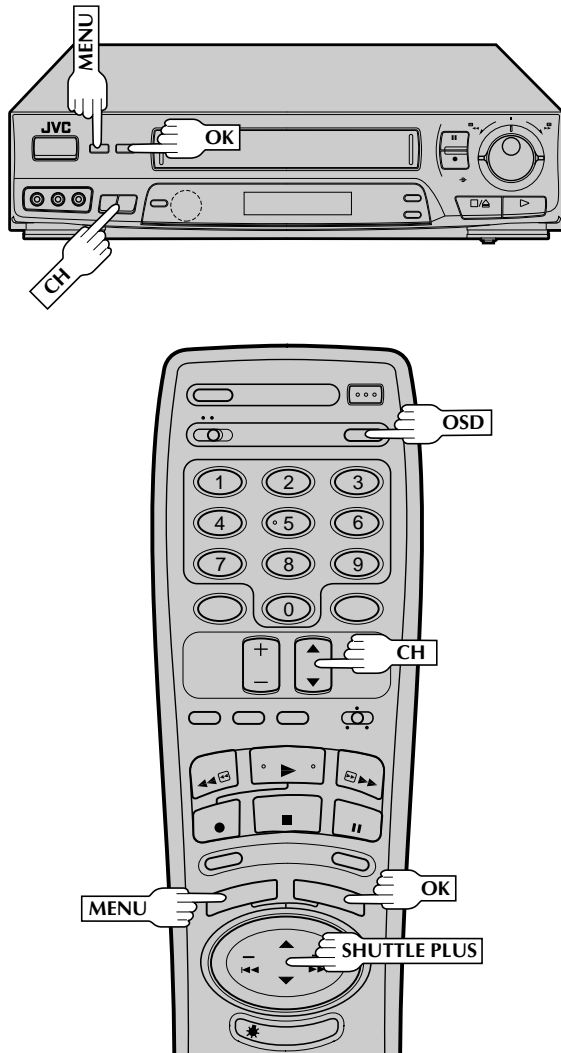

Superimpose

This function, switchable between ON and OFF, determines whether or not operational indicators will appear on screen.

- 1
- 2
- 3
- 4
- 5

ACCESS MAIN MENU SCREEN

Press MENU as many times as necessary.

ACCESS FUNCTION SET SCREEN

Place the arrow next to "FUNCTION SET" by pressing CH▲▼ or SHUTTLE PLUS ▲▼, then press OK.

ACCESS SUPERIMPOSE SCREEN

Place the arrow next to "SUPERIMPOSE" by pressing CH▲▼ or SHUTTLE PLUS ▲▼, then press OK.

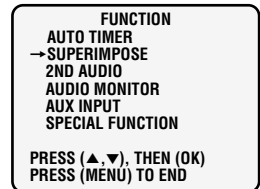

SELECT MODE

Place the arrow next to "ON" or "OFF" by pressing CH▲▼ or SHUTTLE PLUS ▲▼.

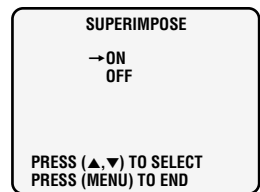

RETURN TO NORMAL SCREEN

Press MENU as many times as necessary.

To recall an indication

- 1 Press OSD.
 - All indications corresponding to the current status are displayed for 5 seconds, leaving the counter information, and RECORD/PAUSE if in the Record Pause mode, on the screen. (No indication during still and search.)
- 2 Press OSD again to clear the display.

NOTE:

If you engage the Record Pause mode, RECORD/PAUSE is displayed whether "SUPERIMPOSE" is set to "ON" or "OFF".

The superimposed indication on the TV screen tells you what the VCR is doing.

Tuned-in channel or AUX(iliary) mode
When the channel is changed, the new channel is displayed on the screen for 5 seconds.

Clock time

Tape position indicator

"Cassette Loaded" mark
When a cassette is loaded, the mark is displayed for 5 seconds. It blinks when the VCR's EJECT button is pushed.

Audio mode indicators

Operation mode
When the operation mode is changed, the new mode is displayed — RECORD (5 sec.), PLAY (5 sec.), FF/REW (5 sec. when engaged from Stop mode), RECORD PAUSE (for as long as Pause is engaged), and ITR **:*(5 sec.).

Tape speed indicator

INDEX indication

Counter reading

Counter memory on/off

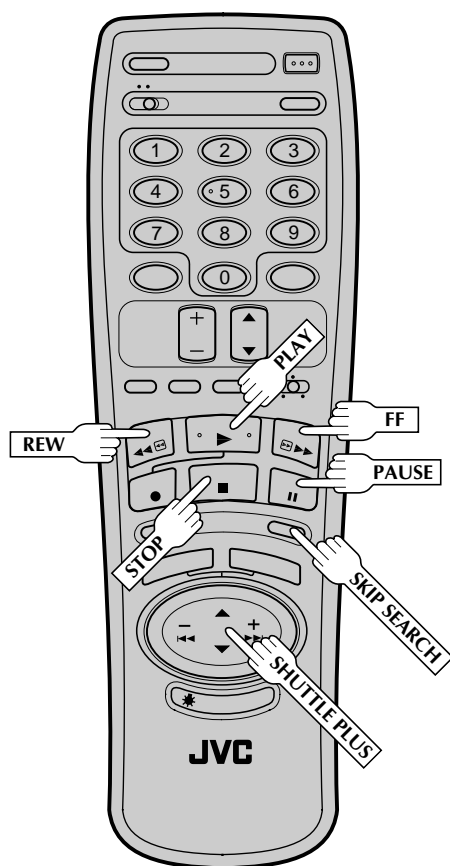
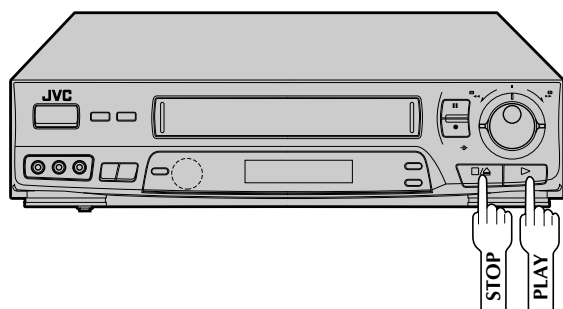

Skip Search

SKIP OVER UNWANTED SECTIONS

- 1 Press **SKIP SEARCH** 1 to 4 times during playback. Each press initiates a 30-second period of fast-motion playback. Normal playback resumes automatically.

NOTE:

To return to normal playback during a Skip Search, press **PLAY**.

Repeat Playback

START REPEAT

- 1 Press and hold **PLAY** (until "PLAY" blinks on the front display panel) during playback, then release.

- The entire tape is played back 20 times.

STOP REPEAT

- 2 To stop, press **STOP** at any time.

NOTE:

Pressing **PLAY**, **REW**, **FF**, **PAUSE** or **SHUTTLE PLUS** ◀◀ or ▶▶ also stops Repeat Playback.

Index Search

This function seeks out index codes that are placed on the tape at recording start.

START SEARCH

- 1 While the tape is stopped, press **SHUTTLE PLUS** ◀◀ or ▶▶.

ACCESS DISTANT CODE

- 2 To access a recording 2–9 index codes away, press **SHUTTLE PLUS** ◀◀ or ▶▶ repeatedly until the correct number is displayed on screen (only if **SUPER-IMPOSE** is set to ON (pg. 28)). Playback begins automatically when the desired recording is located.

- To find the very beginning of the desired program, press **REW** or **FF** and search visually for the start point.

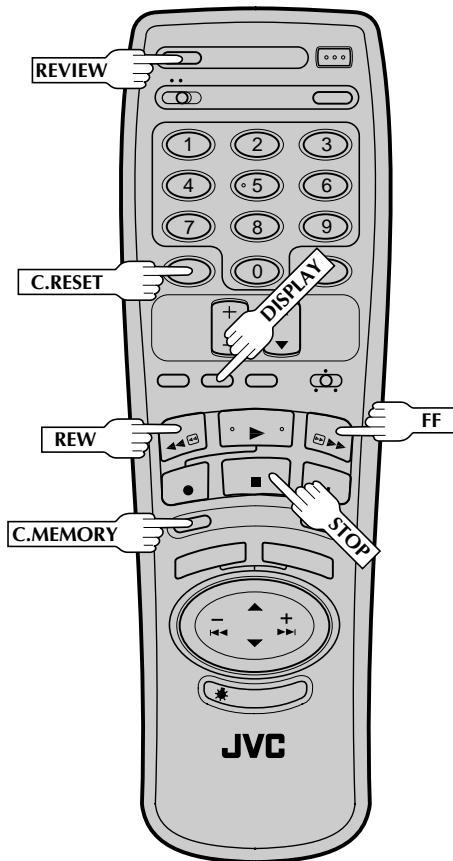
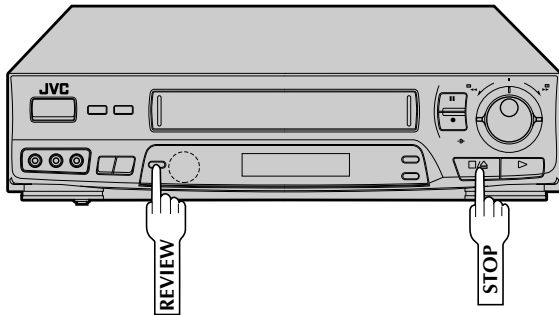

Instant ReView

At the press of a button, you can power up your VCR, rewind the tape and begin viewing the most recent timer-recorded program.

1

ACTIVATE INSTANT REVIEW

After ensuring that the VCR is off and the Timer mode is disengaged, press **REVIEW**.

- The power comes on and the VCR searches for the index code indicating the start of the last timer-recorded program, then begins playback automatically.
- You can access a program 2–9 index codes away from the current position on the tape. If, for example, you have 5 programs recorded and you want to watch the third one, press **REVIEW** three times.
- To find the very beginning of the desired program, press **REW** or **FF** and search visually for the program's start point.

Counter Reset

1

RESET COUNTER TO ZERO

Press **C.RESET**.

NOTE:

By pressing the **DISPLAY** button, you can change the display to show the counter reading, channel number or clock time. (Channel number is not displayed during playback.)

Counter Memory

When activated, this feature returns the tape to counter position "zero".

1

ACTIVATE COUNTER MEMORY

Press **C.RESET** during playback at a point you want to have quick access to later. The counter reads "0H 00M 00S".

Then press **C.MEMORY**. The Counter Memory indicator in the front display panel lights.

2

RETURN TO COUNTER POSITION ZERO

Press **STOP** (during playback), then press **REW**. The tape rewinds and stops at approximately "0H 00M 00S" automatically.

- To cancel Counter Memory, press **C.MEMORY**.

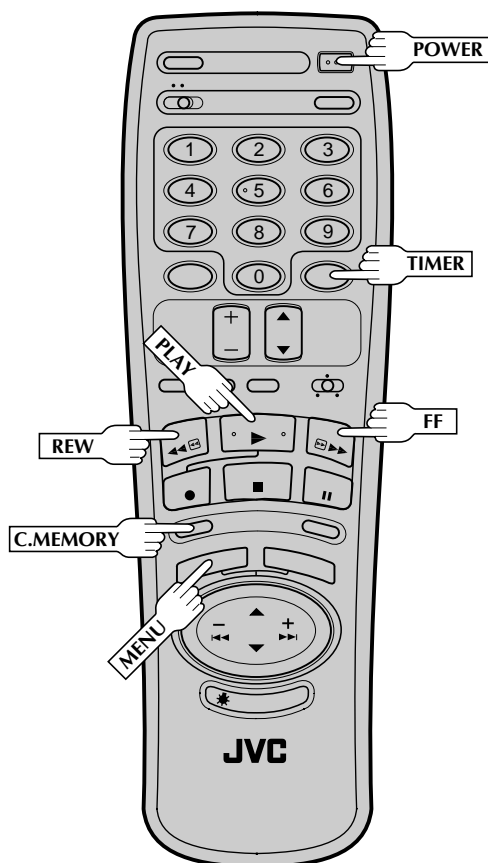
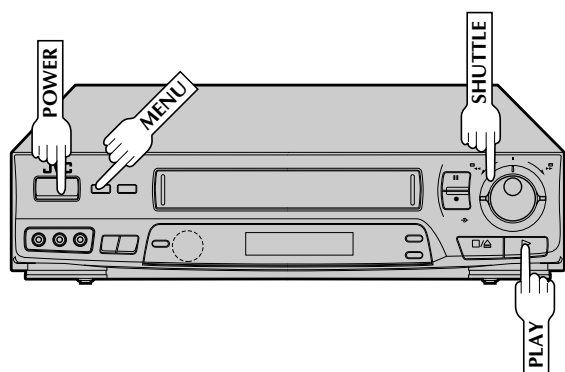

Tape Position Indicator

The Tape position indicator appears on screen when, from the stop mode, you press **FF**, **REW**, or use the **SHUTTLE** ring, or perform an Index Search or Instant ReView. The position of "■" in relation to "B" (Beginning) or "E" (End) shows you where you are on the tape.



NOTE:

"SUPERIMPOSE" must be set to "ON", or the indicator will not appear (☞ pg. 28).

Next-Function Memory

The Next Function Memory "tells" the VCR what to do after rewinding. * Before continuing, ensure that the VCR is in stop mode.

- a- For Automatic Start Of Playback After Tape Rewind . . .
... press **REW**, then press **PLAY** within 2 seconds.
- b- For Automatic Power Off After Tape Rewind . . .
... press **REW**, then press **POWER** within 2 seconds.
- c- For Automatic Timer Standby After Tape Rewind . . .
... press **REW**, then press **TIMER** within 2 seconds.

NOTES:

- To do the above using the VCR's controls:
During Stop, turn the **SHUTTLE** all the way to the left and release it instead of pressing **REW**, and then press **PLAY** or **POWER** within 2 seconds.
- If you want the "next function" to automatically start when the counter reads "0H 00M 00S" (instead of at the beginning of the tape), press **C. MEMORY** so that the counter memory indicator appears on the front display panel before pressing **REW**.

AV COMPU LINK Playback

Your VCR is compatible with JVC's AV COMPU LINK components, including amplifiers (or receivers) and televisions. AV COMPU LINK provides one touch control of the audio and video components that are linked via their AV COMPU LINK connectors.

For example: simply load a cassette in the VCR and press **PLAY** and the AV COMPU LINK components automatically power on, the TV's VIDEO mode is selected and the VCR goes into play mode. (PLAY need not be pressed if the cassette's record safety tab is removed.)

MAKE CONNECTION

1

Connect your VCR to an AV COMPU LINK component as shown in the illustration on page 32.

- The mini-plug cable is a mono 3.5 mm mini-plug to mono 3.5 mm mini-plug connector.

TURN ON THE VCR

2

Press **POWER**.

ACCESS MAIN MENU SCREEN

3

Press **MENU** as many times as necessary.

CONTINUED ON NEXT PAGE.

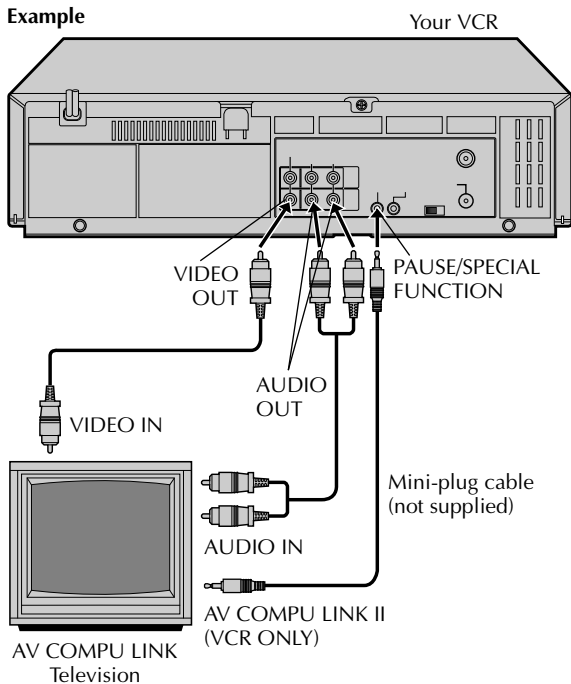
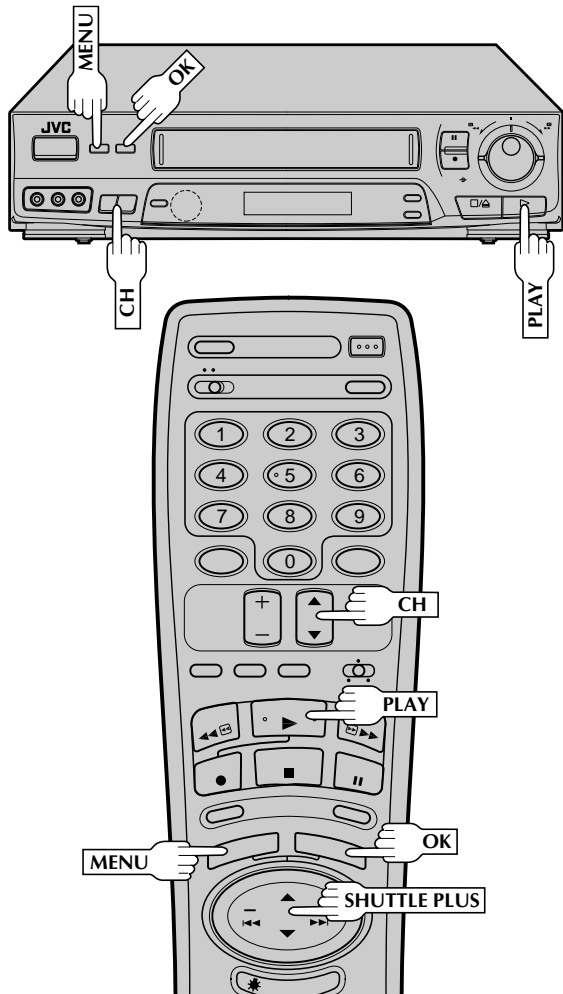

4 ACCESS FUNCTION SET SCREEN

Press CH▲▼ or SHUTTLE PLUS ▲▼ to place the arrow next to "FUNCTION SET", then press OK.

5 ACCESS SPECIAL FUNCTION SCREEN

Press CH▲▼ or SHUTTLE PLUS ▲▼ to place the arrow next to "SPECIAL FUNCTION", then press OK.

FUNCTION
AUTO TIMER
SUPERIMPOSE
2ND AUDIO
AUDIO MONITOR
AUX INPUT
→SPECIAL FUNCTION
PRESS (▲,▼), THEN (OK)
PRESS (MENU) TO END

6 ENABLE AV COMPU LINK PLAYBACK

Press CH▲▼ or SHUTTLE PLUS ▲▼ to place the arrow next to "AV COMPU LINK".

SPECIAL FUNCTION
PAUSE
→AV COMPU-LINK
PRESS (▲,▼) TO SELECT
PRESS (MENU) TO END

7 RETURN TO NORMAL SCREEN

Press MENU as many times as necessary.

8 PERFORM AV COMPU LINK PLAYBACK

Simply insert a cassette and press PLAY (if the cassette's record safety tab has been removed, playback begins automatically). Linked components are turned on, and the TV set to its VIDEO mode, automatically!

NOTE:

Connection varies depending on the type of JVC TV you have. Please refer to the TV's instruction manual when making this connection.

Active Video Calibration

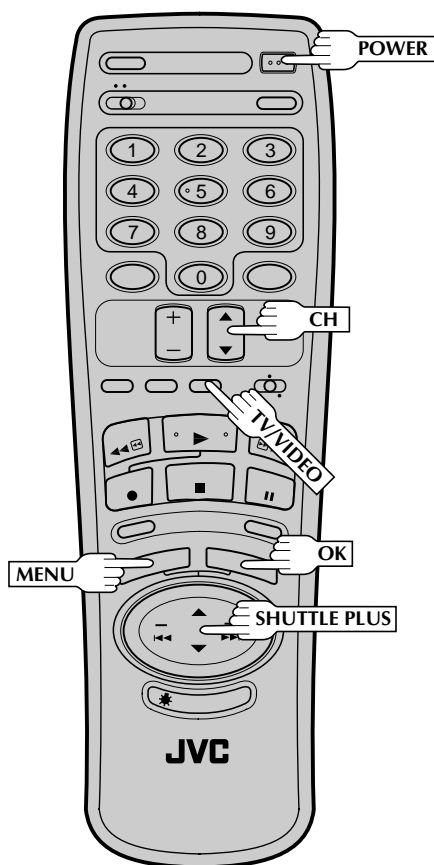
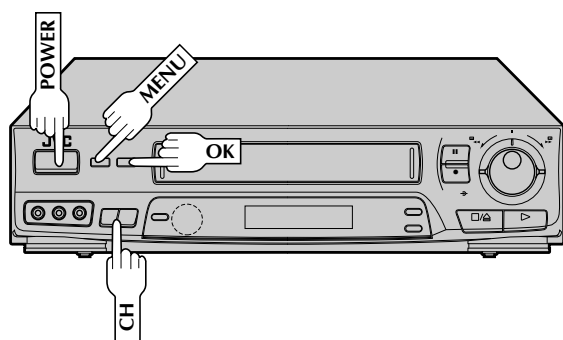

Your VCR is equipped with the Active Video Calibration feature, which checks the condition of the tape in use during recording and playback, and compensates to provide the highest-possible recording and playback pictures. *The default setting for both recording and playback is "ON".

Preparation

1 TURN ON THE VCR

Press **POWER**. If watching channel 3 or 4, press **TV/VIDEO** to select the VIDEO mode. VIDEO is displayed on the front display panel.

2 ACCESS MAIN MENU SCREEN

Press **MENU** as many times as necessary.

3 ACCESS VIDEO CALIBRATION SCREEN

Press **CH▲▼** or **SHUTTLE PLUS** to place the arrow next to "VIDEO CALIBRATION", then press **OK**.

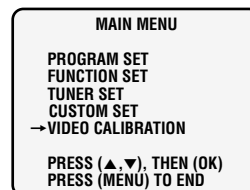

4 SELECT MODE

Place the arrow next to "ON" by pressing **CH▲▼** or **SHUTTLE PLUS ▲▼**, then press **OK** to move the arrow to the Playback section. Set Playback to "ON", then press **MENU** as many times as necessary to return to the normal screen. (Pressing **OK** returns the arrow to the Recording section.)

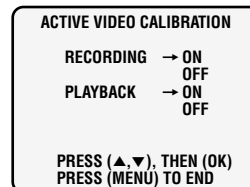

NOTE:

When recording or when playing back tapes recorded on this VCR set the Active Video Calibration to "ON".

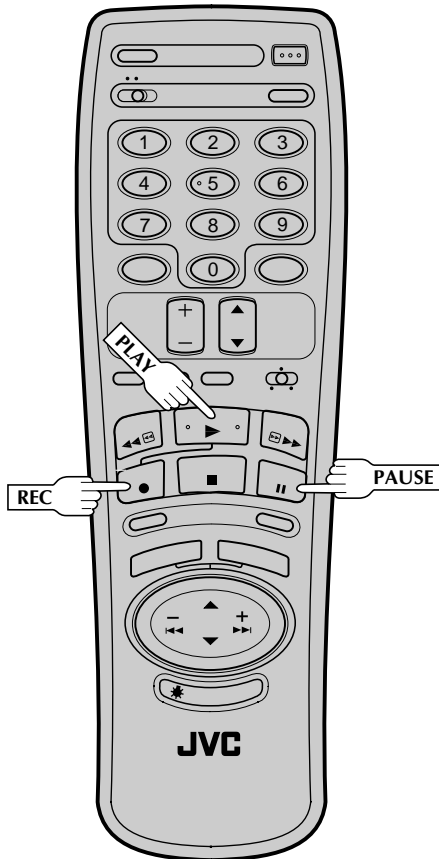
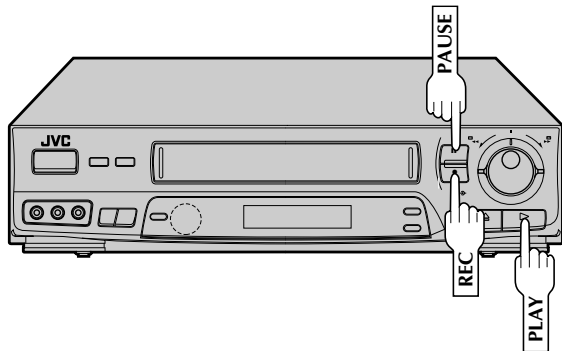

Recording

Perform steps 1 – 3 on page 23 ("Simple Recording") before continuing.

START RECORDING

1

Press and hold **REC** and press **PLAY** on the remote control, or press **REC** on the VCR's front panel.

- The VCR takes about 7 seconds to assess the quality of the tape in use, then recording begins with the picture level optimized.

NOTES:

- Calibration occurs immediately prior to both the first SP and the first EP recording after inserting the cassette. It does not take place during recording.
- In the case of timer recording, calibration takes place for both SP and EP before the first timer recording after inserting the cassette (regardless of the tape speed selected for that recording).
- Once the cassette is ejected, the calibration data is canceled. The next time the cassette is used for recording, calibration is re-performed.
- While Active Video Calibration is operative, the PAUSE button will not function.
- SUPERIMPOSE must be set to "ON" or the Active Video Calibration screen will not appear (pg. 28).

DURING CALIBRATION

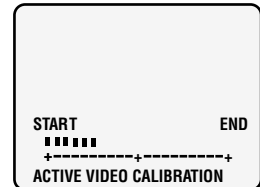

CALIBRATION COMPLETE

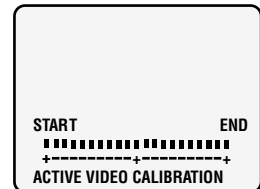

ATTENTION:

- As calibration takes place before recording actually starts, there is a delay of about 7 seconds after **REC** and **PLAY** on the remote, or **REC** on the VCR's front panel, are pressed. To make sure you record the desired scene or program completely, first perform the following steps:
 - 1) Press and hold **PAUSE**, and press **REC** to engage the RECORD PAUSE mode.
 - The VCR then automatically checks the condition of the tape and, after about 7 seconds, re-enters RECORD PAUSE.
 - 2) Press **PLAY** to start recording.
- If you want to bypass Active Video Calibration and start recording right away, set "RECORDING" to "OFF" in step 4 of the Preparation procedure (pg. 33).

Playback

The VCR assesses the quality of the tape once you initiate playback.

Before beginning, perform steps 1 and 2 on page 22.

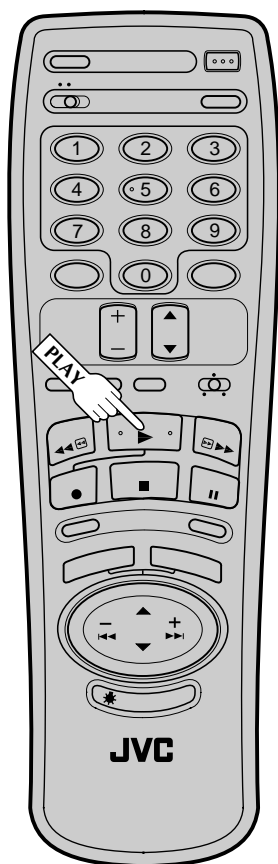
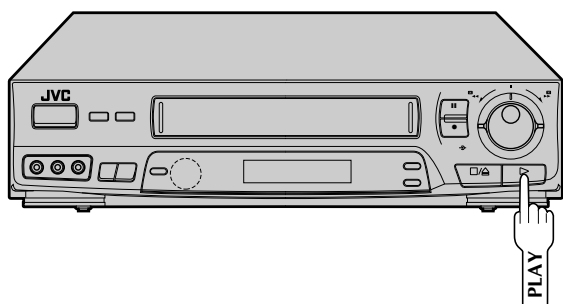

START PLAYBACK

1

Press **PLAY**.

- The VCR adjusts the playback picture quality based on the quality of the tape in use.



NOTES:

- When using rental tapes, or tapes recorded on other VCRs, set "PLAYBACK" in step 4 of the Preparation procedure to either "ON" or "OFF" as desired (☞ pg. 33).
- The Video Calibration screen only appears at the beginning of automatic tracking. Even though the screen doesn't appear after that, the Active Video calibration function is operative.
- "SUPERIMPOSE" must be set to "ON" or the Video Calibration screen will not appear (☞ pg. 28).

Recording

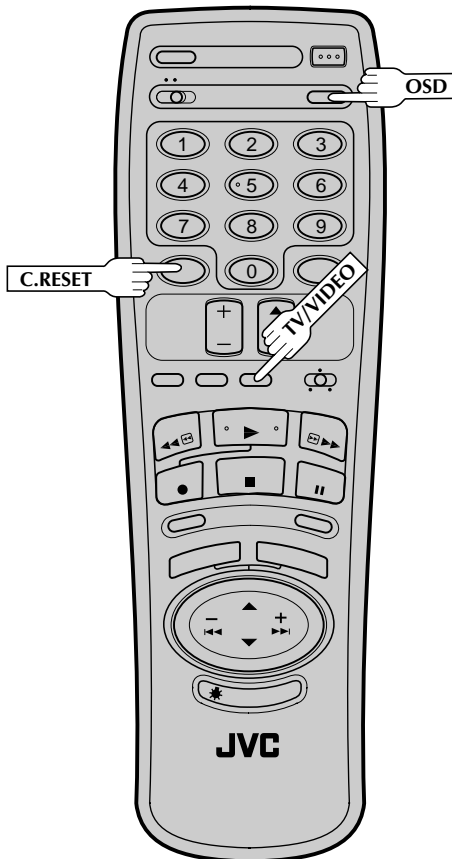
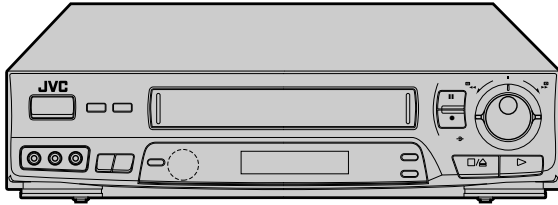

Record One Program While Watching Another

1 ENGAGE TV MODE

During recording...

- Press **TV/VIDEO**. The VCR's VIDEO indicator goes out. (If you are using the RF connection (☞ pg. 6), to view the output from your VCR, the TV broadcast being recorded disappears.)
- If you are using the AV connection (☞ pg. 6), to view the output from your VCR, change the TV's input mode from AV to TV.

2 SELECT CHANNEL FOR VIEWING

Use the TV's channel selector to set the channel you want to watch.

Display Elapsed Recording Time

1 RESET COUNTER TO ZERO

Before recording starts, press **C.RESET**. The counter resets to zero and displays the exact elapsed time as the tape runs.

2 DISPLAY ELAPSED TIME ON SCREEN

During recording, press **OSD** at any time to see the elapsed time. All indications corresponding to the current status of the VCR are displayed for 5 seconds. The counter display remains on the screen indicating the elapsed time. Press **OSD** again to remove the display.

- Make sure "SUPERIMPOSE" is set to "ON" (☞ pg. 28).

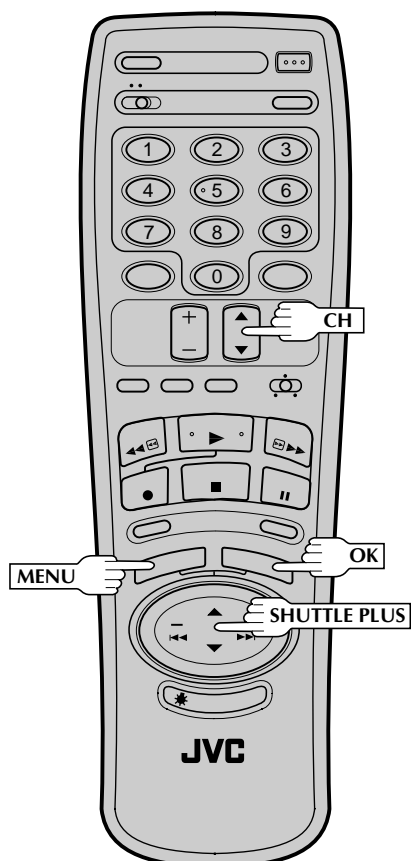
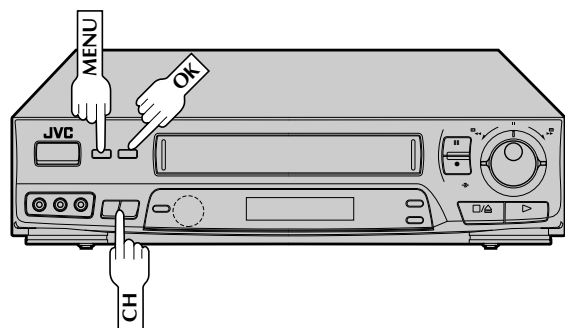

Stereo And SAP (Second Audio Program)

Your VCR's built-in MTS decoder enables reception of Multi-channel TV Sound broadcasts.

- The ST indicator on the front display panel lights during stereo broadcast reception, and SAP lights during SAP program reception.
- Both indicators light when a stereo program is accompanied by SAP audio.

To Record Stereo Programs . . .

. . . simply follow the basic recording procedure.

To Listen To Stereo Soundtrack During Recording . . .

. . . select "HI-FI" at the Audio Monitor screen (☞ pg. 27).

To Record SAP Programs . . .

1 ACCESS MAIN MENU SCREEN

Press **MENU** as many times as necessary.

2 ACCESS FUNCTION SET SCREEN

Place the arrow next to "FUNCTION SET" by pressing **CH▲▼** or **SHUTTLE PLUS ▲▼**, then press **OK**.

3 ACCESS 2ND AUDIO SCREEN

Place the arrow next to "2ND AUDIO" by pressing **CH▲▼** or **SHUTTLE PLUS ▲▼**, then press **OK**.

4 SELECT MODE

Place the arrow next to "ON" by pressing **CH▲▼** or **SHUTTLE PLUS ▲▼**.

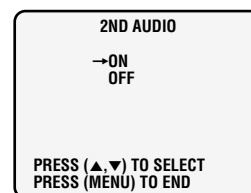

5 RETURN TO NORMAL SCREEN

Press **MENU** as many times as necessary.

NOTES:

- If a SAP program is received, the SAP audio is recorded on both the Normal and Hi-Fi tracks. The main audio program is not recorded.
- If a non-SAP program is received, the main audio is recorded on both the Hi-Fi and Normal audio tracks.

VCR Plus+ Timer Programming

Before VCR Plus+ Timer programming, see "VCR Plus+ Setup" on page 19.

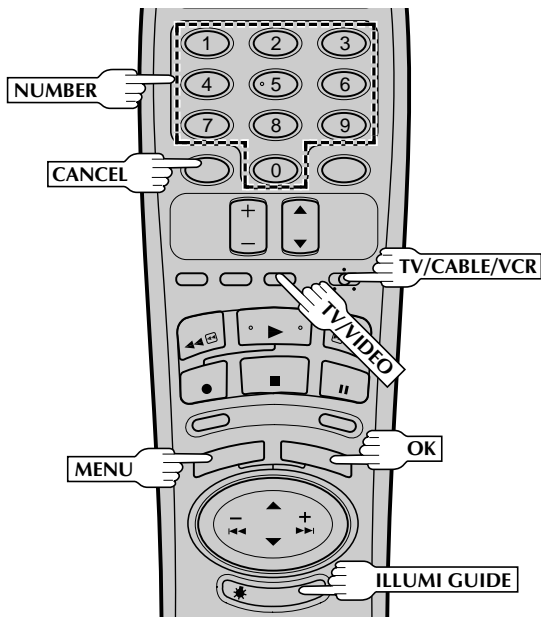
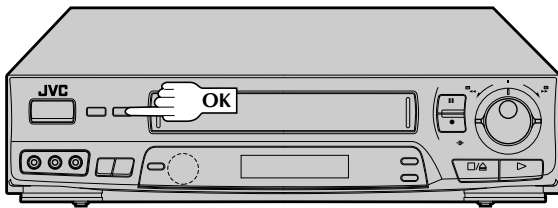

During VCR Plus+ and on-screen timer programming, the Illumi-Guide feature tells you which button on the remote control must be pressed next by lighting it up. To use this feature, with the **TV/CABLE/VCR** switch set to "VCR", press **ILLUMI GUIDE** before performing step 2. (**MENU**, **REW**, **PLAY**, **FF** light up at this time.)

If you aren't going to use the Illumi-Guide feature, go directly to step 1.

1 LOAD A CASSETTE

Make sure the record safety tab is present.

- The VCR's power comes on automatically.
- If you're watching on channel 3 or 4, press **TV/VIDEO** to select the VIDEO mode. VIDEO is displayed on the front display panel.

2 ACCESS VCR PLUS+ SCREEN

Press **MENU** on the remote control.

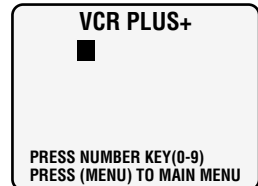

- The clock must be set in order to access the VCR Plus+ screen. If you haven't set the clock, the Main Menu screen appears when you press **MENU**. Refer to page 7 for the Dual Quick Set procedure or page 9 for the clock setting procedure.
- If you are using the Illumi-Guide feature, the following buttons will light up: **NUMBER** keys (0 – 9), **CANCEL** and **MENU**.

3 ENTER PLUSCODE NUMBER

Press the appropriate **NUMBER** keys to enter the PlusCode number printed in the TV listings for the TV program you wish to record.

- To make corrections, press **CANCEL** and input the correct PlusCode number.
- If the PlusCode number you input is incorrect, "ERROR" may appear on the screen to advise you of the error. This happens when the PlusCode number is for a program which has already passed. "ERROR" is displayed for about 4 seconds and the VCR Plus+ screen reappears (step 2).
- If you are using the Illumi-Guide feature, **OK** blinks when the following buttons are lit: **NUMBER** keys (0 – 9), **CANCEL** and **MENU**.

When Using The Illumi-Guide Feature

- Buttons light or blink on the remote control for approximately 10 seconds. If the button or buttons extinguish during timer programming, press **ILLUMI GUIDE** and the button or buttons previously lit or blinking come back on. If the button or buttons do not re-light or start blinking again, press **MENU** as many times as necessary to return to the normal screen and extinguish all illuminated buttons, and re-perform the timer programming procedure from the beginning.
- If for some reason the remote control's signal is not received by the VCR, press **MENU** as many times as necessary to return to the normal screen and extinguish all illuminated buttons, and re-perform the timer programming procedure from the beginning.

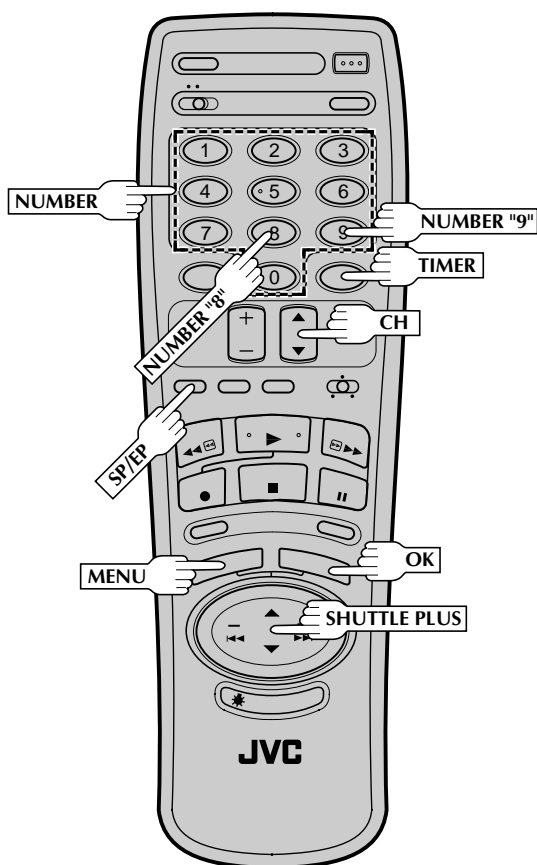
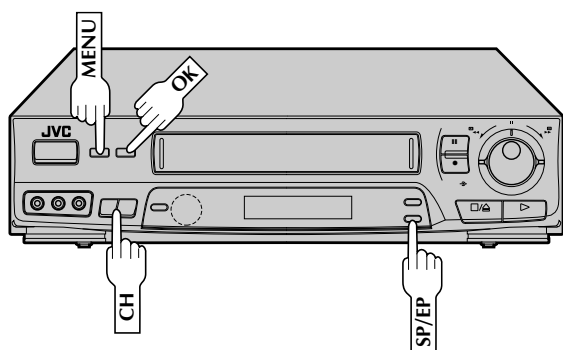

4 CHECK INPUT DATA

Press **OK** and the Program screen appears. The PlusCode number you entered appears in the Program screen. Check to make sure it's accurate.

PROGRAM 1 (VCR PLUS+ 12345678)	
DATE	7/10 FRI
START	8:00 PM
STOP	9:00 PM
CHANNEL	8 SP
PRESS (8=DAILY, 9=WEEKLY SP/EP=REC SPEED) PRESS (MENU) TO END	

- To timer-record daily or weekly serials, press **DAILY** (NUMBER "8") or **WEEKLY** (NUMBER "9"). "DAILY" or "WEEKLY" appears on the Program screen.
- If you made a mistake, press **CANCEL** and, after pressing **MENU** as many times as necessary to access the VCR Plus+ screen, input the correct PlusCode number.
- If you are using the Illumi-Guide feature, **MENU** lights up for about 10 seconds.

5 SET TAPE SPEED

Press **SP/EP**.

6 CHECK/CORRECT INPUT DATA

If the data is correct as it is, go to step 7. If not, press **OK** or **SHUTTLE PLUS** $\leftarrow\rightarrow$ until the item you want to change begins to blink. Then press the appropriate **NUMBER** keys, **CH** \blacktriangle or **SHUTTLE PLUS** \blacktriangle to obtain the desired setting.

7 RETURN TO NORMAL SCREEN

Press **MENU** as many times as necessary.

- Press just once to access the Auto Timer screen (pg. 43).

8 ENGAGE TIMER MODE

Press **TIMER**. The VCR turns off automatically.

NOTES:

- To disengage the timer before recording starts, press **TIMER** again. Pressing once more re-engages it.
- In case of a power failure after programming, the VCR's memory backup keeps your selections for 10 minutes.
- When timer-recording cable channels received through a Cable Box, be sure to keep the Cable Box set to ON.

On-Screen Timer Programming

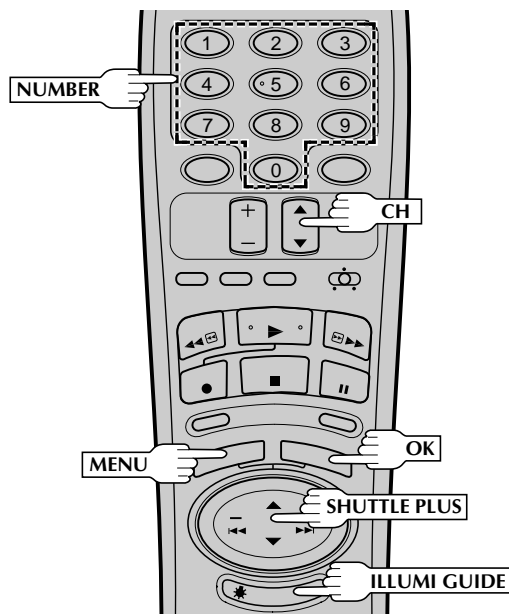
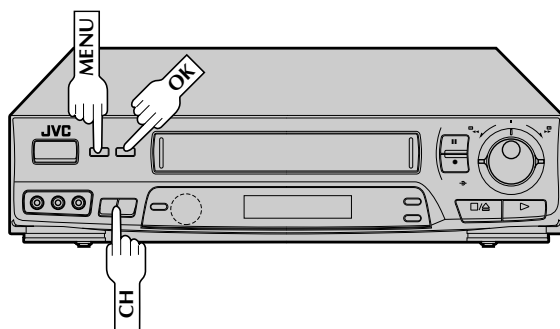

When Using The Illumi-Guide Feature

- Buttons light or blink on the remote control for approximately 10 seconds. If the button or buttons extinguish during timer programming, press **ILLUMI GUIDE** and the button or buttons previously lit or blinking come back on. If the button or buttons do not re-light or start blinking again, press **MENU** as many times as necessary to return to the normal screen and extinguish all illuminated buttons, and re-perform the timer programming procedure from the beginning.
- If for some reason the remote control's signal is not received by the VCR, press **MENU** as many times as necessary to return to the normal screen and extinguish all illuminated buttons, and re-perform the timer programming procedure from the beginning.

You can directly program the VCR's timer to record up to 8 shows, as far as a year in advance. Remember, the clock must be set before you can program the timer (pg. 7 or 9). Or you can use the Illumi-Guide feature, where the remote control tells you which button to press next by lighting it up. To use the Illumi-Guide feature, with the **TV/CABLE/VCR** switch set to "VCR", press **ILLUMI GUIDE** before performing step 2. (**MENU**, **REW**, **PLAY**, **FF** light up at this time.)

If you aren't going to use the Illumi-Guide feature, go directly to step 1.

1

LOAD A CASSETTE

Make sure the record safety tab is intact. If not, cover the hole with adhesive tape, then load.

- The VCR comes on, and the counter is reset, automatically.
- If watching channel 3 or 4, press **TV/VIDEO** to select the VIDEO mode. VIDEO is displayed on the front display panel.

2

ACCESS ON-SCREEN MENU

Press **MENU** as many times as necessary to bring up the Main Menu screen.

- If you are using the Illumi-Guide feature, **MENU** lights up and **OK** blinks.

3

ACCESS PROGRAM SET SCREEN

Make sure the arrow is to the left of "PROGRAM SET", then press **OK**.

- If you are using the Illumi-Guide feature, **OK** blinks when the following buttons are lit: **NUMBER** keys (0 - 9), **SHUTTLE PLUS**, **CANCEL** and **MENU**.

PROGRAM 1	
DATE	--/--
START	--:-- AM
STOP	--:-- AM
CHANNEL	-- SP
PRESS NUMBER KEY(0-9) OR (▲, ▼), THEN (OK) PRESS (MENU) TO END	

4

SELECT PROGRAM NUMBER

Press the appropriate **NUMBER** keys or **CH▲▼** or **SHUTTLE PLUS▲▼** to select a vacant program number, then press **OK**. The first time you do this, all numbers will be vacant, so just press **OK** when the screen appears.

- If you are using the Illumi-Guide feature, **OK** blinks when the following buttons are lit: **NUMBER** keys (0 - 9), **SHUTTLE PLUS**, **CANCEL** and **MENU**.

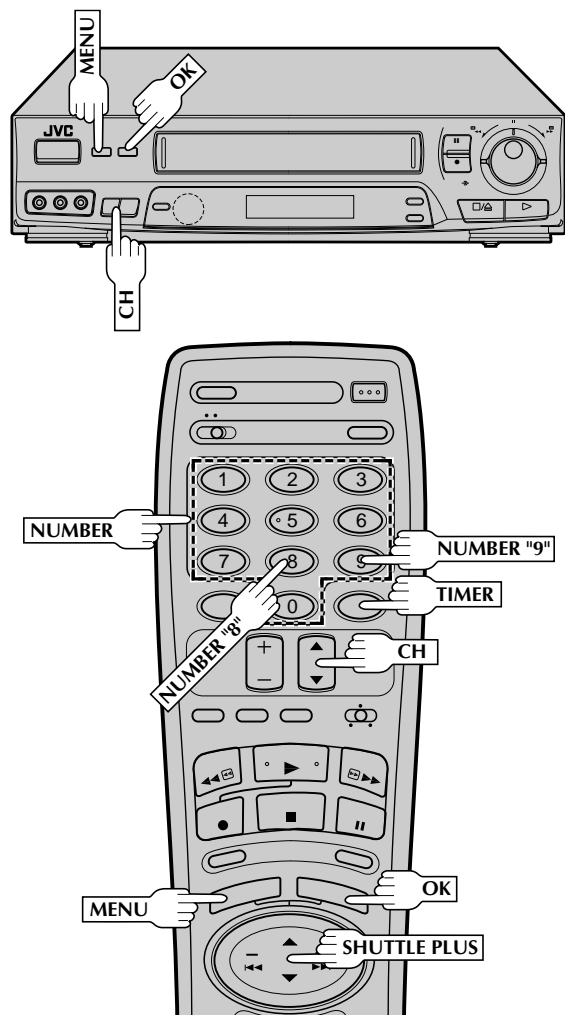
**EXAMPLE**

If you program the VCR to timer record a show on September 6 on channel 40 from 12:00 noon to 1:00 PM in SP mode, the screen will look like this:

PROGRAM 1	
DATE	9/6 SUN
START	12:00 PM
STOP	1:00 PM
CHANNEL	40 SP
PRESS NUMBER KEY(0-9) OR (▲,▼), THEN (OK) PRESS (MENU) TO END	

NOTES:

- To disengage the timer before recording starts, press **TIMER** again. Pressing once more re-engages it.
- In case of a power failure after programming, the VCR's memory backup keeps your selections for 10 minutes.
- If you select "PROGRAM SET" without having set the date and time, an error message appears. Follow its instructions.
- If you enter a start time that has already passed, "ERROR" appears on the screen and flashes.
- Programs that start after midnight must have the next day's date.

5**SET PROGRAM INFORMATION**

Press the appropriate **NUMBER** keys to set the date, start/stop time and channel number. Press **CH▲▼** or **SHUTTLE PLUS ▲▼** to set AM/PM and tape speed. Press **OK** after AM/PM, channel number and tape speed settings. The next setting that can be set begins flashing.

- Any information comprised of 1 digit (except the channel number) should have a "0" entered before it.
- It is possible to set all information using the **CH▲▼** or **SHUTTLE PLUS ▲▼** button. (In this case, press **OK** after each setting.) Do not use the **CH ▼** or **SHUTTLE PLUS ▼** button to set the date.
- If you are using the Illumi-Guide feature, **OK** blinks when the following buttons are lit: **NUMBER** keys (0 - 9), **SHUTTLE PLUS**, **CANCEL** and **MENU**.

NOTE:

If you are using a cable box, enter the cable box channel, not the channel to be recorded. The channel to be recorded must be selected on the cable box. (The cable box channel is the VCR's channel that displays the channels received by the cable box.)

** You can record selected programs at the same time every weekday, or once a week. Before entering the month, press **NUMBER** key "8" (DAILY) or "9" (WEEKLY). Either "DAILY" or "WEEKLY" appears. Press again and "DAILY" or "WEEKLY" disappears.

6**MAKE CORRECTIONS**

To change any of the settings, press **OK** or **SHUTTLE PLUS** ◀▶ until the item you want to change begins blinking. Then set as in step 5.

- If you are using the Illumi-Guide feature, **OK** blinks when the following buttons are lit: **NUMBER** keys (0 - 9), **SHUTTLE PLUS**, **CANCEL** and **MENU**.

7**RETURN TO NORMAL SCREEN**

Press **MENU** as many times as necessary.

- Press just once to access the Auto Timer screen (pg. 43).
- If you are using the Illumi-Guide feature, all buttons go out.

8**ENGAGE TIMER MODE**

Press **TIMER**. The VCR turns off automatically.

- After timer recording is completed, the VCR's power goes off automatically.
- You can program the timer while a regular recording is in progress; the on-screen menu will not be recorded.
- If the end of tape is reached during timer recording, the cassette is automatically ejected.
- When timer-recording cable channels received through a Cable Box, be sure to keep the Cable Box set to ON.

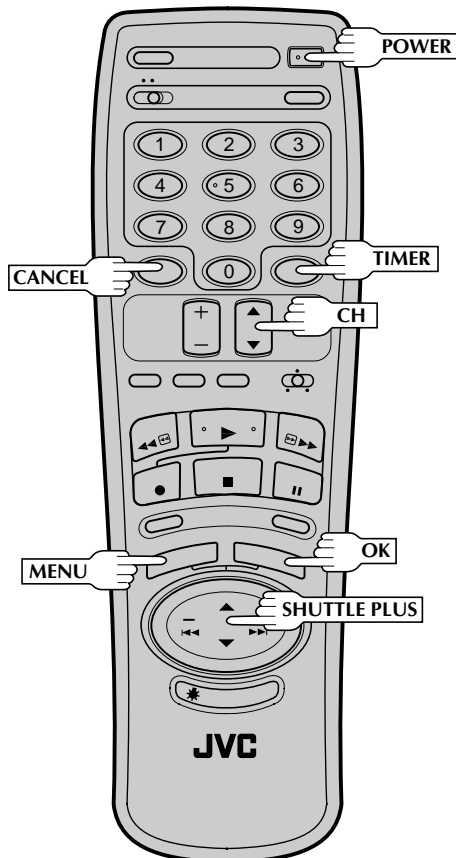
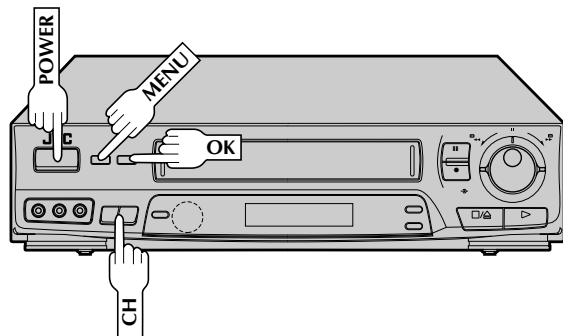

Check And Cancel Programs

1

DISENGAGE TIMER

Press **TIMER**, then press **POWER**.

2

ACCESS MAIN MENU SCREEN

Press **MENU** as many times as necessary.

3

ACCESS PROGRAM SET SCREEN

Press **CH▲▼** or **SHUTTLE PLUS ▲▼** to place the arrow next to "PROGRAM SET", then press **OK**.

4

CHECK PROGRAM INFORMATION

Press **CH▲▼** or **SHUTTLE PLUS ▲▼** to check the programs in succession.

To Cancel A Program . . .

5

CANCEL A PROGRAM

Press **CANCEL**.

- Repeat steps 4 and 5 as many times as necessary.

6

RETURN TO NORMAL SCREEN

Press **MENU** as many times as necessary. If there are still programs remaining, go to step 7.

7

RE-ENGAGE TIMER

Press **TIMER** again.

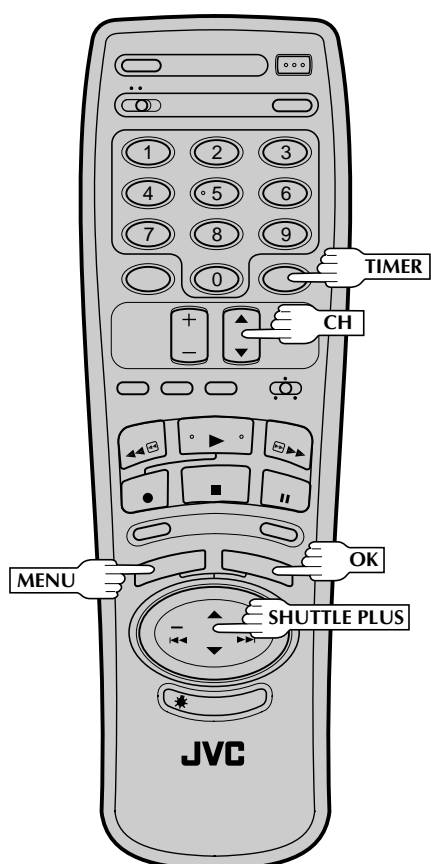
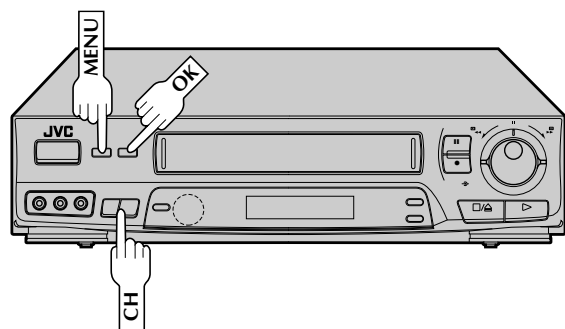

Auto Timer

When the Auto Timer is set to ON the timer is automatically engaged when the VCR's power is turned off and automatically disengaged when the VCR is powered back on.

ACCESS MAIN MENU SCREEN

1 Press **MENU** as many times as necessary.

ACCESS FUNCTION SET SCREEN

2 Place the arrow next to "FUNCTION SET" by pressing **CH▲▼** or **SHUTTLE PLUS ▲▼**, then press **OK**.

ACCESS AUTO TIMER SCREEN

3 Place the arrow next to "AUTO TIMER" by pressing **CH▲▼** or **SHUTTLE PLUS ▲▼**, then press **OK**. Now skip to step 2 of the procedure below.

Or, during on-screen timer programming ...

ACCESS AUTO TIMER SCREEN

1 In step 7 in the VCR Plus+ Timer Programming procedure (pg. 39) or in step 7 in the On-Screen Timer Programming procedure (pg. 41), press **MENU**.

SELECT MODE

2 Place the arrow next to your choice ("ON" or "OFF") by pressing **CH▲▼** or **SHUTTLE PLUS ▲▼**.

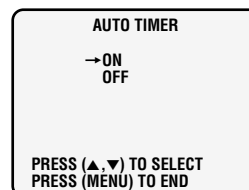

RETURN TO NORMAL SCREEN

3 Press **MENU** as many times as necessary.

NOTE:

For safety, when *AUTO TIMER* is set to "OFF", all other VCR functions are disabled while the Timer mode is engaged. To disengage the timer, press **TIMER**.

Instant Timer Recording (ITR)

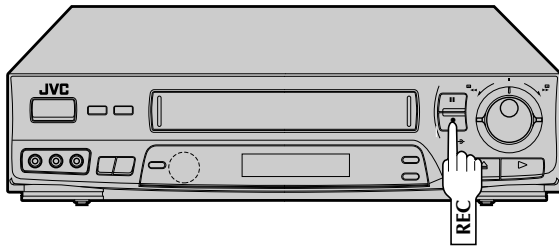

This easy method lets you record for from 30 minutes to 6 hours (selectable in 30-min. increments), and shuts the VCR off after recording is finished.

1 START RECORDING

Press **REC**.

2 ENGAGE ITR MODE

Press **REC** again. ITR blinks and 0:30 appears on the front display panel.

3 SET RECORDING DURATION

If you want to record for more than 30 minutes, press **REC** to extend the time. Each press extends recording time by 30 minutes.

NOTES:

- You can only perform ITR using the **REC** button on the VCR's front panel.
- After you set the time, the previous display reappears.
- To check the remaining time, press **REC** once during recording and the remaining time will be displayed for about 5 seconds. Be careful not to press **REC** again within these 5 seconds, or you will round the recording time up to the next 30 minute increment.

Edit To Or From Another VCR

You can use your VCR as the player or the recorder.

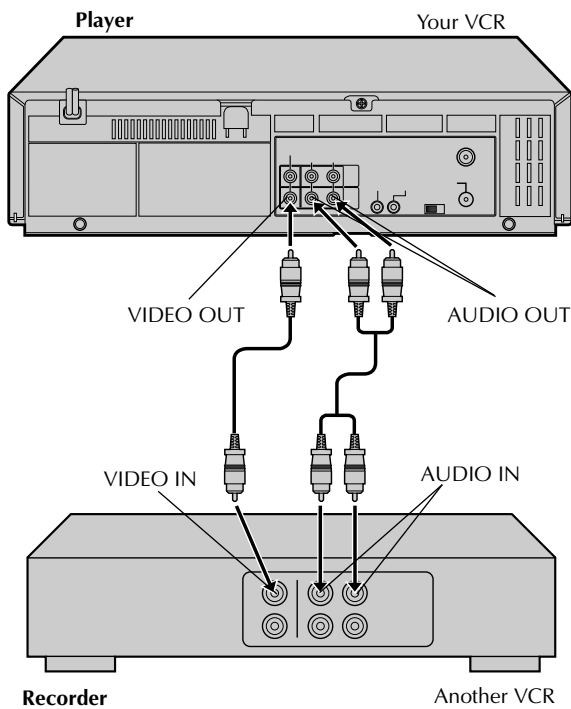

1

MAKE CONNECTIONS

Connect an AV cable between the player's VIDEO OUT and AUDIO OUT connectors and the recorder's VIDEO IN and AUDIO IN connectors.

- When using your VCR as the recorder and a monaural VCR as the player, connect the player's AUDIO OUT connector to the AUDIO IN L connector on the recorder.

2

LOAD CASSETTES

Insert the playback cassette into the player and the cassette to be recorded on into the recorder.

3

SET RECORDER'S INPUT MODE

Set to AUX. With this VCR, press **NUMBER** key "0" (AU appears on the front display panel in place of a channel number).

NOTE:

When using this VCR as the recorder, make sure to select "FRONT" or "REAR" (depending on which input connectors you use) at the Aux Input Screen. (To select the correct AUX input connector, follow steps 4, 5, 9 – 11 from the "Edit From A Camcorder" section, pg. 46.)

4

START PLAYER

Set to its play mode.

NOTE:

If the player is equipped with a superimpose/OSD disable feature then set "SUPERIMPOSE" to OFF before pressing **PLAY** (pg. 28).

5

START RECORDER

Set to its record mode.

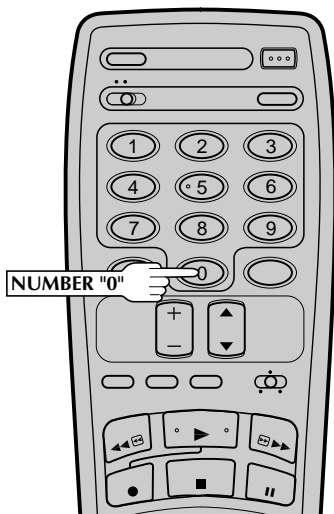

Edit From A Camcorder

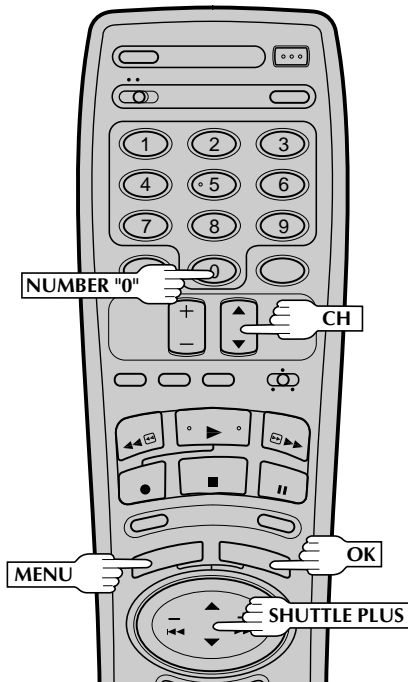
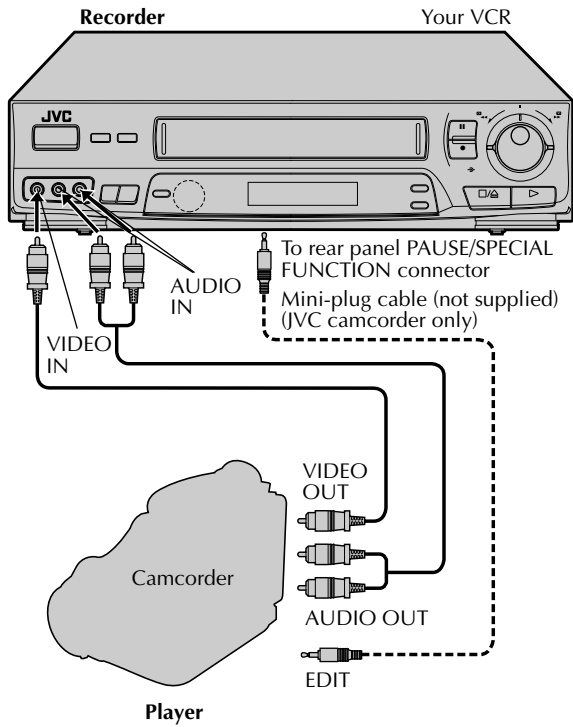

You can use a camcorder as the player and your VCR as the recorder.

1 MAKE CONNECTIONS

Connect an AV cable between the camcorder's VIDEO OUT and AUDIO OUT connectors and your VCR's VIDEO IN and AUDIO IN connectors.

- When a Master Edit Control-equipped JVC camcorder is used, the camcorder is capable of controlling your VCR. The mini-plug cable is a mono 3.5 mm mini-plug to mono 3.5 mm mini-plug connector.

2 LOAD A CASSETTE

Insert the cassette to be recorded on into the recorder.

3 SET RECORDER'S INPUT MODE

Press **NUMBER** key "0" to set to AUX.

4 ACCESS MAIN MENU SCREEN

Press **MENU** as many times as necessary.

5 ACCESS FUNCTION SET SCREEN

Press **CH▲▼** or **SHUTTLE PLUS ▲▼** to place the arrow next to "FUNCTION SET", then press **OK**.

*If you're using a JVC Master Edit Control-equipped camcorder — step 6
If not — step 9*

6 ACCESS SPECIAL FUNCTION SCREEN

Press **CH▲▼** or **SHUTTLE PLUS ▲▼** to place the arrow next to "SPECIAL FUNCTION", then press **OK**.

7 SELECT MODE

Press **CH▲▼** or **SHUTTLE PLUS ▲▼** to place the arrow next to "PAUSE".

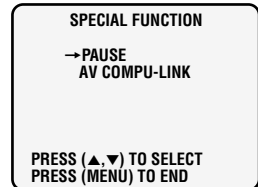

8 RETURN TO FUNCTION SET SCREEN

Press **MENU**.

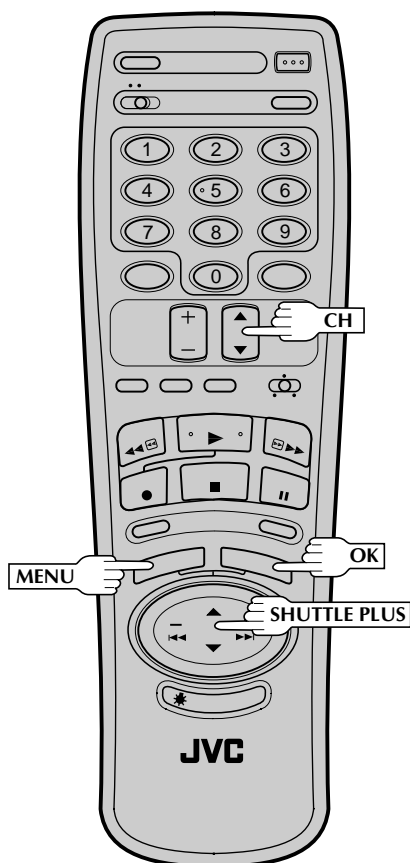
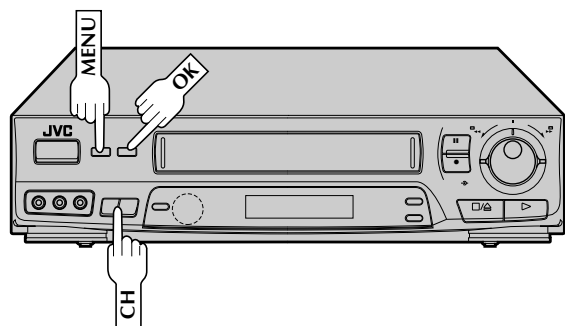

9 ACCESS AUX INPUT SCREEN

Press **CH▲▼** or **SHUTTLE PLUS ▲▼** to place the arrow next to "AUX INPUT", then press **OK**.

10 SELECT INPUT

If you are connecting the AV cable to the AV connectors on the front of the VCR, place the arrow next to "FRONT" by pressing **CH▲▼** or **SHUTTLE PLUS ▲▼**. If you are connecting the AV cable to the AV connectors on the back of the VCR, place the arrow next to "REAR" by pressing **CH▲▼** or **SHUTTLE PLUS ▲▼**.

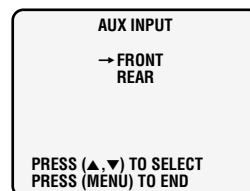

11 RETURN TO NORMAL SCREEN

Press **MENU** as many times as necessary.

12 START PLAYER

Set the camcorder to its play mode.

NOTE:

If the camcorder is equipped with a superimpose/OSD disable feature then set its superimpose or display feature to OFF before pressing play.

13 START RECORDER

Set your VCR to its record mode.

- If you are using a Master Edit Control-equipped JVC camcorder, it can put the recorder automatically into Record mode. (Refer to camcorder's instruction manual.)

Assemble Editing

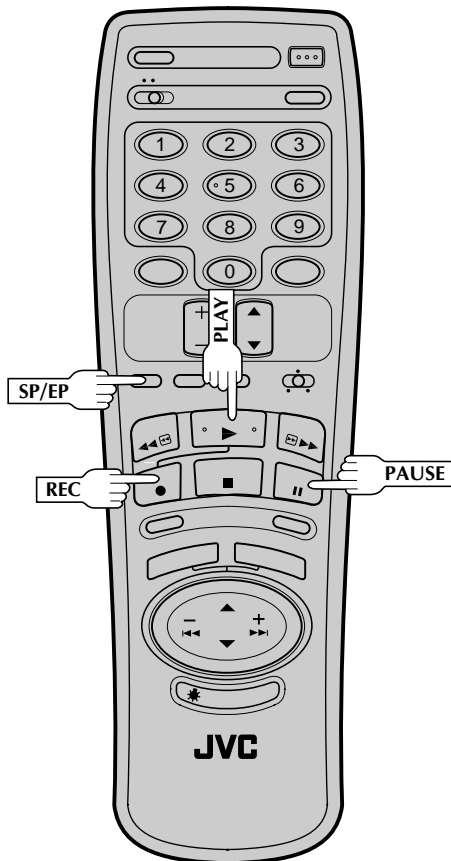
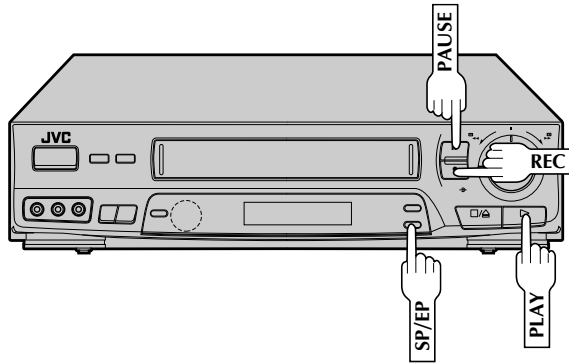

Assemble Editing adds one recorded scene to another in succession.
To use your VCR as the recorder ...

- 1 LOAD CASSETTES**
Insert the original cassette in the player, and the recording cassette in the recorder.
- 2 SET TAPE SPEED**
Set to "SP" or "EP" by pressing the **SP/EP** button.
- 3 ENGAGE RECORD-STANDBY MODE**
Press and hold **PAUSE**, and press **REC**.
- 4 FIND EDIT START POINT**
Play back the original tape until you reach the scene to be edited.
- 5 START EDITING**
When you reach the scene on the original tape to be edited, press **PLAY** to initiate the recorder's record mode.
- 6 STOP EDITING**
Press **PAUSE** to pause the tape in the recorder.
- 7 CONTINUE EDITING**
Repeat steps 4 through 6 to add additional scenes.

NOTE:

Assemble Editing is also possible using your VCR as the playback deck.

Audio Dubbing

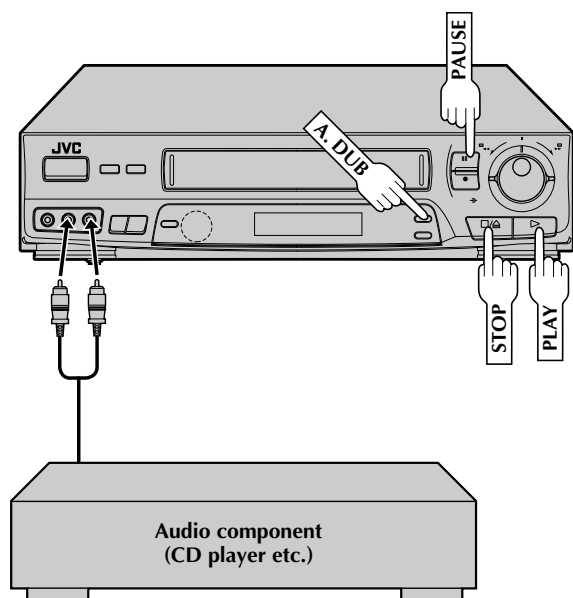

Audio dubbing replaces the normal audio sound of a previously recorded tape with a new soundtrack. Use your VCR as the recorder.

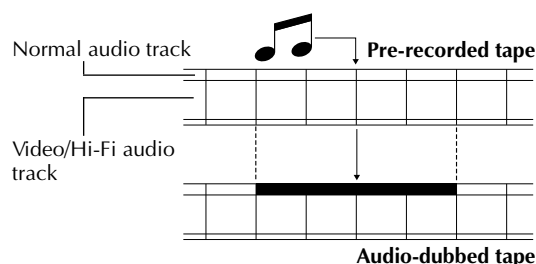

MAKE CONNECTIONS

- 1 Connect an audio component to the AUDIO IN L + R connectors on the VCR's front panel. *When connecting monaural equipment, use only the VCR's AUDIO IN L connector.

SET INPUT MODE

- 2 Press **NUMBER** key "0" on the remote control. "AU" appears in place of a channel number.
 - Be sure to select "FRONT" at the AUX Input Screen. (To select the correct AUX Input connector, follow steps 4, 5, 9 – 11 from the "Edit From A Camcorder" section, pg. 46.)

LOCATE START POINT

- 3 Press **PLAY** to start playback of the tape in your VCR, and press **PAUSE** when you find the point where you want to start dubbing.

ENGAGE AUDIO DUBBING

- 4 Press **A. DUB**.
 - Your VCR enters the Audio Dubbing Pause mode. (REC blinks, PLAY and PAUSE light up on the front display panel.)

START DUBBING

- 5 Engage the audio component's Play mode, then press **PLAY** to start the tape in your VCR. Audio dubbing begins at this point.
 - REC blinks and PLAY is displayed on the front display panel.
 - To stop dubbing temporarily, press **PAUSE**. Press **PLAY** to resume dubbing.

END AUDIO DUBBING

- 6 Press **STOP** to stop the tape in your VCR, and engage the audio component's Stop mode.

NOTES:

- When monitoring the sound during Audio Dubbing, the normal soundtrack is automatically selected. If you wish to hear the Hi-Fi or mixed sound (Hi-Fi + Normal soundtracks), refer to the "Select The Soundtrack" section (pg. 27) and select the soundtrack you wish to hear.
- Audio dubbing stops automatically when the counter reaches "0:00:00s", and the VCR enters the Play mode. Check the counter reading before dubbing.
- Audio dubbing is also possible using the rear AUDIO IN connectors. When using these connectors, make sure to select "REAR" at the Aux Input screen. To select the correct Aux Input connector, follow steps 4, 5, 9 – 11 from the "Edit From A Camcorder" section pg. 46.
- Audio dubbing cannot be performed on a cassette that has had its record safety tab removed.
- When playing back an audio-dubbed tape, refer to the "Select The Soundtrack" section (pg. 27) to select the soundtrack you wish to hear.
- It may be unlawful to record or play back copyrighted material without the consent of the copyright owner.

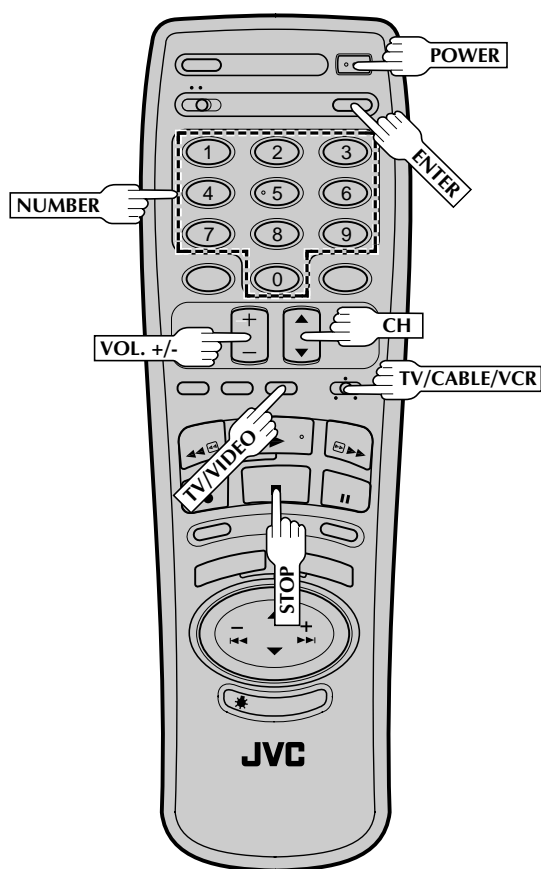

TV Multi-Brand Remote Control

The VCR's remote control can control several functions on JVC remote control TVs and on the brands of remote control TVs listed below.

- 1** **TURN ON THE TV**
 Turn the power on using the TV's remote control.
- 2** **SET REMOTE CONTROL MODE**
 Set the **TV/CABLE/VCR** switch on the VCR's remote control to TV.
- 3** **SET TV BRAND CODE**
 Refer to the chart below. While holding down **POWER**, enter your TV's brand code using the **NUMBER** keys, then press **STOP**.
 - Once you have set the remote control to operate the TV, you don't have to repeat this step until you replace your remote control's batteries.
 - PANASONIC has two codes. If the TV does not function with one code, try entering the other.
- 4** **OPERATE TV**
 First, press **POWER** on the remote to see if the TV's power goes off as it should. If it does, try other operations.
 - The **POWER**, **TV/VIDEO**, **CH▲▼**, **VOL +/-** and **NUMBER** keys on the remote can all be used to operate the TV. *For some brands of TV, you must press **ENTER** after having pressed the **NUMBER** keys.
 - To return the remote to VCR control, set the **TV/CABLE/VCR** switch to **VCR**.

NOTE:

Depending on the kind of TV, there may be cases where some or all functions cannot be operated using the remote control.

TV BRAND NAME	BRAND CODE
JVC	01
MAGNAVOX	02
MITSUBISHI	03
PANASONIC	04, 11
RCA	05
SHARP	06
SONY	07
TOSHIBA	08
ZENITH	09
HITACHI	10
SAMSUNG	12
SANYO	13
SEARS	13

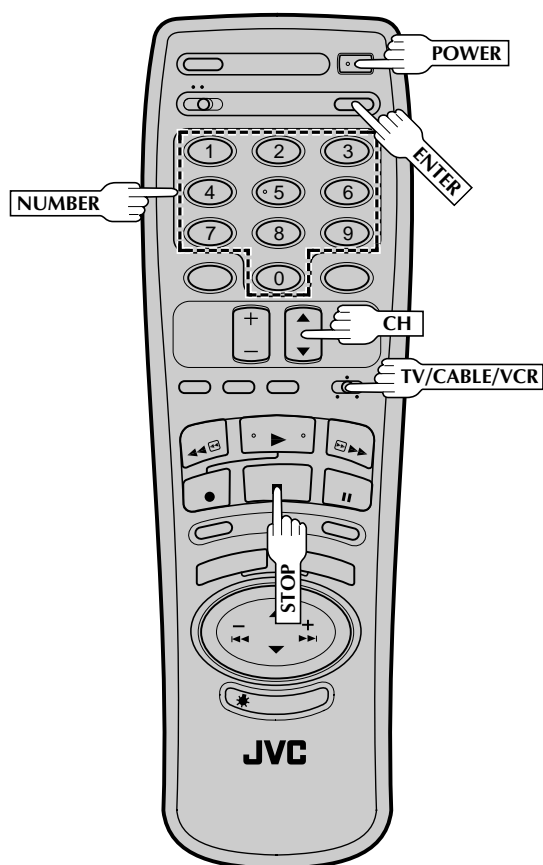

Cable Box Multi-Brand Remote Control

The VCR's remote control can control functions on the brands of cable boxes listed below. Some cable box brands have more than one code. If your cable box does not function with a specified code, try other codes.

1 TURN ON THE CABLE BOX

Turn the power on using the cable box's remote control.

2 SET REMOTE CONTROL MODE

Set the **TV/CABLE/VCR** switch on the VCR's remote control to **CABLE**.

3 ENTER CABLE BOX BRAND

While holding down **POWER**, use the **NUMBER** keys to enter the cable box brand number from the chart below and then press **STOP**.

- Once you have set the remote control to operate the cable box, you don't have to repeat this step until you replace the remote control's batteries.

4 OPERATE CABLE BOX

First, press **POWER** to see if the cable box's power goes off as it should. If it does, try other functions (**CH▲▼** and the **NUMBER** keys can be used to operate the cable box).

- For some brands of cable box, you must press **ENTER** after having pressed the **NUMBER** keys.
- To return the remote to VCR control, set the **TV/CABLE/VCR** switch to **VCR**.

CABLE BOX BRAND NAME	BRAND CODE
CURTIS	09, 10
GEMINI	08
GENERAL INSTRUMENTS	01, 02, 03, 04, 05, 06, 07, 08
HAMLIN	15, 16, 17, 18
JERROLD	01, 02, 03, 04, 05, 06, 07, 08
OAK	19, 20, 21
PANASONIC	24, 25, 26
PIONEER	13, 14
RCA	24, 25, 26
REGAL	15, 16, 17, 18
SAMSUNG	08, 13
SCIENTIFIC ATLANTA	09, 10
SIGMA	19, 20, 21
SL MARX	08, 13
SPRUCER	24, 25, 26
TELEVIEW	08, 13
TOCOM	22, 23
VIDEOWAY	11, 12
ZENITH	11, 12

NOTES:

- You must set the cable box brand for your remote control and the cable box brand for your Cable Box Controller (pg. 17) separately. The list of cable box brands that can be controlled by your remote control is different from the list of cable box brands that can be controlled by your cable box controller.
- It is possible that the remote control will not operate your cable box even if the cable box's channels automatically change during timer recording using the Cable Box Controller.

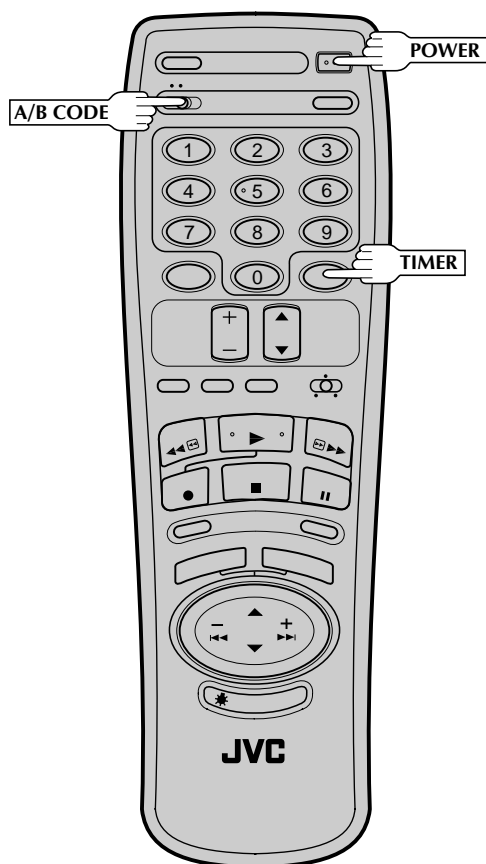

Control Two JVC VCRs

The supplied remote control is capable of controlling two JVC VCRs independently using the **A/B CODE** switch. You can set this VCR so it responds to remote commands only when the switch is set to **B**, and another VCR so it responds to commands when the switch is set to **A**. The switch is preset to **A** because this VCR normally responds to A-code signals. You can easily modify this VCR to accept B-code commands.

1 UNPLUG VCR'S POWER CORD

Unplug from the AC outlet.

2 SET A/B CODE SWITCH

Set the **A/B CODE** switch on the remote control to **B**.

3 PLUG IN POWER CORD

Plug back in to the AC outlet.

4 TURN VCR POWER ON

Press **POWER** on the remote.

The VCR will now respond only to B-code commands.

Child Lock

This feature allows you to prevent the operation of the VCR.

1 TURN VCR POWER ON

Press **POWER**.

2 ENGAGE CHILD LOCK

Press and hold **POWER** on the remote control until the Child Lock indicator ("—") appears on the front display panel.

- To cancel Child Lock, press and hold **POWER** on the remote to turn the VCR on. During timer recording, pressing **TIMER** also cancels Child Lock.

NOTES:

- When *Child Lock* is engaged, make sure to keep the remote control out of the reach of children.
- Timer recording of programs that were previously set can be performed while the *Child Lock* is engaged. The feature remains in effect after the recording is finished.





TROUBLESHOOTING

Before requesting service for a problem, use this chart and see if you can repair the trouble yourself. Small problems are often easily corrected, and this can save you the trouble of sending your VCR off for repair.

POWER		
SYMPTOM	POSSIBLE CAUSE	CORRECTIVE ACTION
1. The power won't come on.	<ul style="list-style-type: none"> • The power cord is disconnected. 	Connect the power cord.
2. The clock works, but the VCR's power won't come on.	<ul style="list-style-type: none"> • The TIMER mode is engaged with Auto Timer set to "OFF" (☞ pg. 43). 	Press TIMER to disengage.
3. The remote control won't function.	<ul style="list-style-type: none"> • The batteries are discharged. • The A/B CODE switch is in the wrong position. • The TV/CABLE/VCR switch is in the wrong position. 	Replace the dead batteries with new ones. Re-perform the A/B Code setting (☞ pg. 52). Set the switch to the position corresponding with the unit you want to operate.
TAPE TRANSPORT		
SYMPTOM	POSSIBLE CAUSE	CORRECTIVE ACTION
1. The cassette gets stuck partway during loading, and is ejected.	<ul style="list-style-type: none"> • The cassette was inserted incorrectly. 	Make sure the window side is up, the rear label side is facing you and the arrow on the front of the cassette is pointing towards the VCR. Then insert the cassette
2. The tape stops during rewind or fast forward.	<ul style="list-style-type: none"> • The Counter Memory indicator ("M") is lit on the front display panel. 	Press C.MEMORY to disengage the Counter Memory mode and extinguish the indicator.
PLAYBACK		
SYMPTOM	POSSIBLE CAUSE	CORRECTIVE ACTION
1. The tape is running but the picture won't appear.	<ul style="list-style-type: none"> • If you're using the RF OUT connection (☞ pg. 6), the channel selector on the TV is set incorrectly. • If you're using the AV connection (☞ pg. 6), the TV receiver is set to the wrong mode. 	Set the channel selector to channel 3 or 4. Set the TV receiver to its AV mode.
2. Noise appears during visual search.	<ul style="list-style-type: none"> • This is normal. 	
3. Breaks are noticeable in Hi-Fi soundtrack.	<ul style="list-style-type: none"> • Automatic tracking is engaged. 	Engage and adjust tracking manually (☞ pg. 26).
4. The playback picture is blurred or interrupted, even though TV broadcasts are clear.	<ul style="list-style-type: none"> • The video heads may be dirty. 	The heads must be cleaned. Consult your JVC dealer (☞ pg. 61).
5. The Hi-Fi soundtrack cannot be heard.	<ul style="list-style-type: none"> • The AUDIO MONITOR option at the Function Set screen was set incorrectly. 	Set AUDIO MONITOR to "HI-FI" (☞ pg. 27).
6. SHUTTLE ring does not work properly during search.	<ul style="list-style-type: none"> • A turn of the SHUTTLE which is too rapid may not be properly recognized. 	Release the SHUTTLE , then turn it again more slowly.

CONTINUED ON NEXT PAGE.

RECORDING		
SYMPTOM	POSSIBLE CAUSE	CORRECTIVE ACTION
1. Recording won't start.	<ul style="list-style-type: none"> There's no cassette loaded. The loaded cassette has had its record safety tab removed. 	<p>Insert a cassette.</p> <p>Remove the cassette and cover the hole with adhesive tape, or load a cassette on which the record safety tab is intact.</p>
2. TV broadcasts won't record properly.	<ul style="list-style-type: none"> The VCR has been set to its AUX mode by mistake. 	<p>Set the VCR to the appropriate channel.</p>
3. Tape-to-tape editing won't work.	<ul style="list-style-type: none"> The VCRs or the camcorder and the VCR have been incorrectly connected. The power to one or more of the units has not been turned on. The recorder's input mode has been set incorrectly. 	<p>Refer to the directions and the illustration under "Edit To Or From Another VCR" (pg. 45) or "Edit From A Camcorder" (pg. 46) and properly connect the units.</p> <p>Make sure the power to all units is on.</p> <p>Set the recorder's input mode to AUX and select "FRONT" or "REAR" at the Aux Input Screen (pg. 47).</p>
TIMER RECORDING		
SYMPTOM	POSSIBLE CAUSE	CORRECTIVE ACTION
1. Timer recording won't work.	<ul style="list-style-type: none"> The clock and/or the timer have been set incorrectly. The timer is not engaged. The VCR has not been set up properly. 	<p>Check or re-perform the clock/timer settings to ensure correctness.</p> <p>Press TIMER and check to make sure that TIMER appears on the front display panel.</p> <p>Re-perform the set-up procedures. Make sure you have compensated for Guide Channel and VCR or cable box channel number mismatches (pg. 19).</p>
2. On-screen timer programming won't work.	<ul style="list-style-type: none"> Timer recording is in progress. 	<p>Timer programming can't be performed when timer recording is in progress. Wait until it finishes.</p>
3. TIMER and  on the front display panel won't stop blinking.	<ul style="list-style-type: none"> The timer is engaged but there's no cassette loaded. 	<p>Load a cassette with the record safety tab intact, or with the hole covered with adhesive tape.</p>
4. The cassette is automatically ejected, and TIMER and  on the front display panel won't stop blinking.	<ul style="list-style-type: none"> The loaded cassette has had its record safety tab removed. 	<p>Remove the cassette and cover its hole with adhesive tape, or replace it with a cassette on which the safety tab is intact.</p>
5. TIMER blinks for 10 seconds and the timer mode is disengaged.	<ul style="list-style-type: none"> TIMER has been pressed when there are no programs in memory, or the timer record program information has not been programmed correctly. 	<p>Check the programmed data and re-program as necessary, then press TIMER again.</p>
6. The cassette is automatically ejected, the power shuts off and TIMER and  won't stop blinking.	<ul style="list-style-type: none"> The end of tape was reached during timer recording. 	<p>The program may not have been recorded in its entirety. Next time make sure you have enough time on the tape to record the entire program.</p>
7. Cable channels are not automatically switched during timer recording.	<ul style="list-style-type: none"> The Cable Box Controller is not properly connected to the VCR. The output channel selected in the Cable Box Output screen is incorrect. The cable box's power is off. 	<p>Connect the Cable Box Controller correctly (pg. 15).</p> <p>After confirming your cable box's output channel number, re-access the Cable Box Output screen and select the correct number (pg. 17).</p> <p>Make sure the power is on before timer recording starts.</p>



8. Timer recording begins as scheduled, but the channel is always incorrect.	<ul style="list-style-type: none"> • Even though you don't use an external Cable Box, "CABLE BOX OUTPUT" is set to "ON". 	Set "CABLE BOX OUTPUT" to "OFF" (☞ pg. 16).
9. We moved, and now VCR Plus+ doesn't work properly.	<ul style="list-style-type: none"> • The receivable stations in the new area are received on different channels than those in the previous area. 	Re-perform the VCR Plus+ setup procedure (☞ pg. 19).
10. "PROGRAM FULL" is displayed on the VCR Plus+ screen.	<ul style="list-style-type: none"> • All 8 programs of the VCR's timer memory are used. 	Wait until a space in memory clears, or cancel unnecessary program information (☞ pg. 42).

OTHER PROBLEMS

SYMPTOM	POSSIBLE CAUSE	CORRECTIVE ACTION
1. When scanning channels, some of them are skipped over.	<ul style="list-style-type: none"> • Those channels have been preset to be skipped. 	If you need the skipped channels, restore them (☞ pg. 14).
2. The channel can't be changed.	<ul style="list-style-type: none"> • Recording is in progress. 	Press PAUSE to pause the recording, change channels, then press PLAY to resume recording.
3. The remote control won't operate my TV.	<ul style="list-style-type: none"> • The TV/CABLE/VCR switch is set to a position other than TV. 	Set the switch to TV.
4. The remote control won't operate my cable box.	<ul style="list-style-type: none"> • The TV/CABLE/VCR switch is set to a position other than CABLE. 	Set the switch to CABLE.
5. Even though Auto or Semi-Auto clock setting has been selected, the clock is incorrect.	<ul style="list-style-type: none"> • The clock setting data received from the Host Channel is incorrect. 	Select a different Host Channel during the Semi-Auto setting procedure (☞ pg. 10), or perform the Manual setting procedure (☞ pg. 11).

ATTENTION:

This recorder contains microcomputers. External electronic noise or interference could cause malfunctioning. In such cases, switch the power off and unplug the power cord. Then plug it in again and switch power on. Take out the cassette. After checking the cassette, operate the unit as usual.



PLAYBACK

Q. What happens if the end of the tape is reached during playback or search?

A. The tape is automatically rewound to the beginning.

Q. Can the VCR indefinitely remain in the still mode?

A. No. It stops automatically after 5 minutes to protect the heads.

Q. During search, slow, still and frame-by-frame playback, I can't hear any audio. What's the problem?

A. This is normal.

Q. During search, still and frame-by-frame playback, the picture is intermittent. What's the cause?

A. Picture loss occurs when these types of playback are attempted with a tape recorded in LP mode. Pressing **PLAY** to return to normal playback will restore the picture.

Q. When returning from multi-speed search to normal playback, the picture is disturbed. Should I be concerned about this?

A. No, it is normal.

Q. Noise bars appear during multi-speed search. What's the problem?

A. This is normal.

Q. Other than preventing further recording, what effect does removing the safety tab have?

A. It disables marking of index codes.

Q. Sometimes, during Index Search, the VCR can't find the program I want to see. Why not?

A. There may be index codes too close together.

Q. During playback, on-screen operational indicators sometimes jitter. Why does this happen?

A. If the condition of the tape being played back is not good, jittering of the video (including on-screen indicators) may occur.

RECORDING

Q. When I pause and then resume a recording, the end of the recording before the pause is overlapped by the new recording. Why does this happen?

A. This is normal. It reduces distortion at the pause and resume points.

Q. Can the VCR indefinitely remain in the Record-Pause mode?

A. No. The VCR automatically goes to its Stop mode after 5 minutes to protect the heads. When paused during Instant Timer Recording (ITR), the VCR shuts off automatically after 5 minutes.

Q. What happens if the tape runs out during recording?

A. The VCR automatically rewinds it to the beginning.

TIMER RECORDING

Q. REC and TIMER remain lit on the front display panel. Is there a problem?

A. No. This is a normal condition for a timer recording in progress.

Q. Can I program the timer while I'm watching a tape or a TV broadcast?

A. You won't see the picture as it is replaced by the on-screen menu, but the audio from the program or tape you're viewing is present.



List Of Terms

This guide serves as a quick way to locate frequently used terms and on-screen display names. The first page on which the term appears is listed. Most terms appear more than once in the instruction manual.

A

A/B Code	52
Active Video Calibration	33
Add Channel	14
AFC	14
Audio Dubbing	49
Audio Monitor	27
Auto Channel Setting	13
Auto Clock Setting	11
Auto Daylight Saving Time	11
Auto Timer	43
Automatic Tracking	26
Aux Input	47
AV Compu Link Playback	31
AV Connection	6

B

Band	12
------------	----

C

Cable Box	15
Cable Box Brand Setting	17
Cable Box Controller	15
Cancel Program	42
Cassette Adapter	22
Check Program	42
Child Lock	52
Connection to TV	6
Contents	5
Counter Memory	30
Counter Reset	30

D

Delete Channel	14
Dual Quick Setting	7

E

Editing	45
---------------	----

F

Frame-by-Frame Playback	24
Function Setting	27

G

Guide Channel Map	21
Guide Channel Setting	20

H

Host Channel Selection	10
------------------------------	----

I

Illumi Guide	38
Index Search	29
Insert Cassette	22
Instant ReView	30
ITR (Instant Timer Recording)	44

J

Jog Dial	24
----------------	----

L

Language Selection	8
--------------------------	---

M

Main Menu	8
Manual Channel Setting	14
Manual Clock Setting	11
Manual Tracking	26
MBR (Multi-Brand Remote) Code Setting	50

N

Next-Function Memory	31
----------------------------	----

O

On-Screen Display	28
On-Screen Timer Programming	40
On-Screen Timer Recording	40
Override Auto Clock Setting	9

P

PBS Channel	7
Playback	22

R

Record Safety Tab	23
Recording	23
Repeat Playback	29
Reverse Motion Playback	25
Reverse Slow Motion Playback	24
RF Connection	6

S

SAP (Second Audio Program)	37
Second Audio	37
Select Cable Box Output Channel	16
Semi-Auto Clock Setting	10
Shuttle Plus	8
Skip Search	29
Slow Motion Playback	24
Specifications	60
Still Picture Playback	24
SHUTTLE Ring	24
Superimpose	28

T

Tape Position Indicator	31
Tape Speed Setting	23
Time Zone Selection	10
Tuner Setting	12

V

Variable-Speed Search	25
VCR Plus+	19
VCR Plus+ Timer Programming	38
VCR Plus+ Timer Recording	38

FRONT VIEW

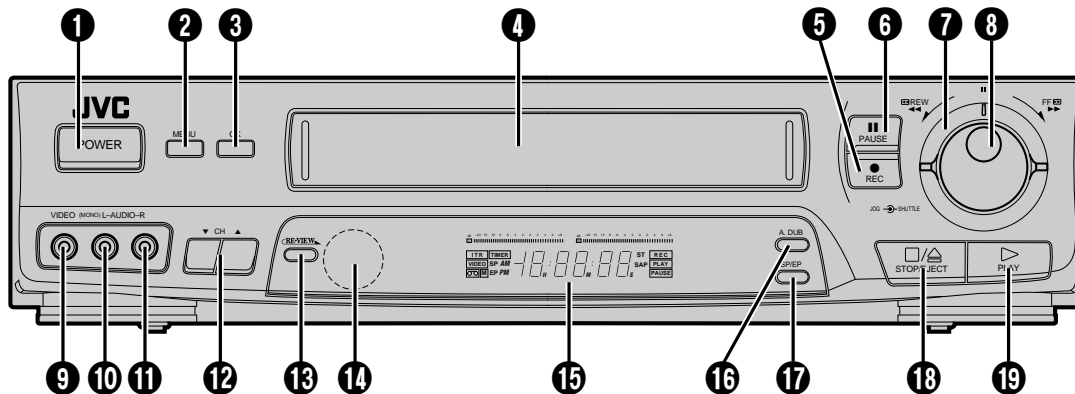

- 1 Power ON/OFF Button (☞ pg. 8)
- 2 Menu Button (☞ pg. 8)
- 3 OK Button (☞ pg. 8)
- 4 Cassette Loading Slot
- 5 Record [REC] Button (☞ pg. 23)
- 6 Pause Button (☞ pg. 23)
- 7 SHUTTLE Ring (☞ pg. 24)
- 8 JOG Dial (☞ pg. 24)
- 9 Video Input Connector (☞ pg. 46)
- 10 Mono Audio Input Connector (☞ pg. 46)
Audio Input Connector [L] (☞ pg. 46)
- 11 Audio Input Connector [R] (☞ pg. 46)
- 12 Channel ▲▼ Buttons (☞ pg. 8)
- 13 Instant REVIEW Button (☞ pg. 30)
- 14 Remote Control Sensor
- 15 Front Display Panel (☞ pg. 59)
- 16 Audio Dubbing [A. DUB] Button (☞ pg. 49)
- 17 SP/EP Button (☞ pg. 23)
- 18 Stop/Eject Button (☞ pg. 22)
- 19 Play Button (☞ pg. 22)

REAR VIEW

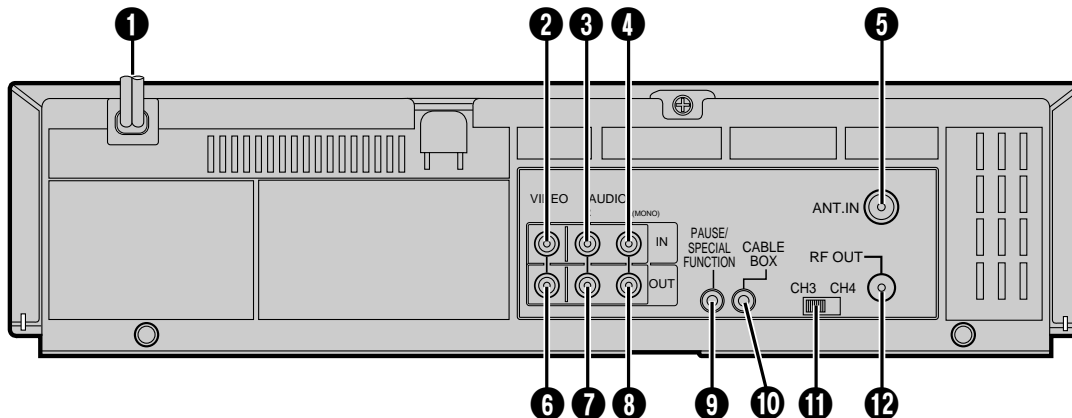

- 1 Power Cord (☞ pg. 6)
- 2 Video Input Connector (☞ pg. 45)
- 3 Audio Input Connector [R] (☞ pg. 45)
- 4 Mono Audio Input Connector (☞ pg. 45)
Audio Input Connector [L] (☞ pg. 45)
- 5 ANT. IN Connector (☞ pg. 6)
- 6 Video Output Connector (☞ pg. 6)
- 7 Hi-Fi Audio Output Connector [R] (☞ pg. 6)
- 8 Hi-Fi Audio Output Connector [L] (☞ pg. 6)
- 9 PAUSE/SPECIAL FUNCTION connector
 - Remote PAUSE Connector (☞ pg. 46)
 - AV COMPU LINK Connector (☞ pg. 31)
- 10 CABLE BOX Connector (☞ pg. 15)
- 11 Channel 3/4 Switch (☞ pg. 6)
- 12 RF OUT Connector (☞ pg. 6)

FRONT DISPLAY PANEL

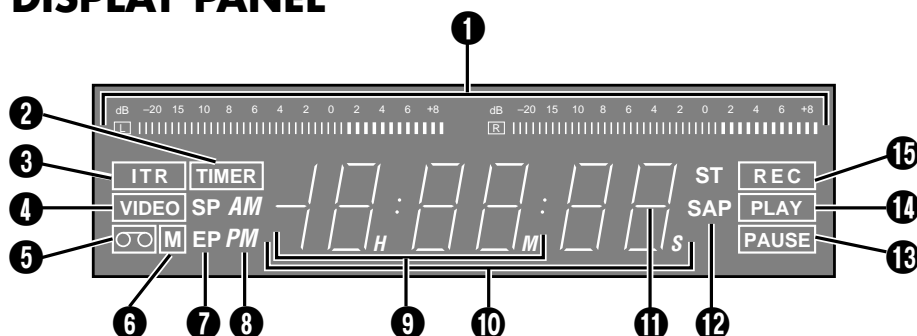

- 1 Audio Level Meter
- 2 Timer Mode Indicator (☞ pg. 39)
- 3 Instant Timer Recording Indicator (☞ pg. 44)
- 4 Video Mode Indicator (☞ pg. 8)
- 5 "Cassette Loaded" Mark
- 6 Counter Memory Mark (☞ pg. 30)
- 7 Tape Speed Indicators (☞ pg. 23)
- 8 AM/PM Indicators (☞ pg. 7)
- 9 Clock Display (☞ pg. 7)
- 10 Channel Display ["AU" for AUX mode] (☞ pg. 7)
- 11 Counter Display (☞ pg. 22)
- 12 Child Lock Indicator (☞ pg. 52)
- 13 Multi-Channel TV Sound Indicators (☞ pg. 37)
- 14 Pause Mode Indicator (☞ pg. 23)
- 15 Play Mode Indicator (☞ pg. 22)
- 16 Recording Mode Indicator (☞ pg. 23)

REMOTE CONTROL (Provided)

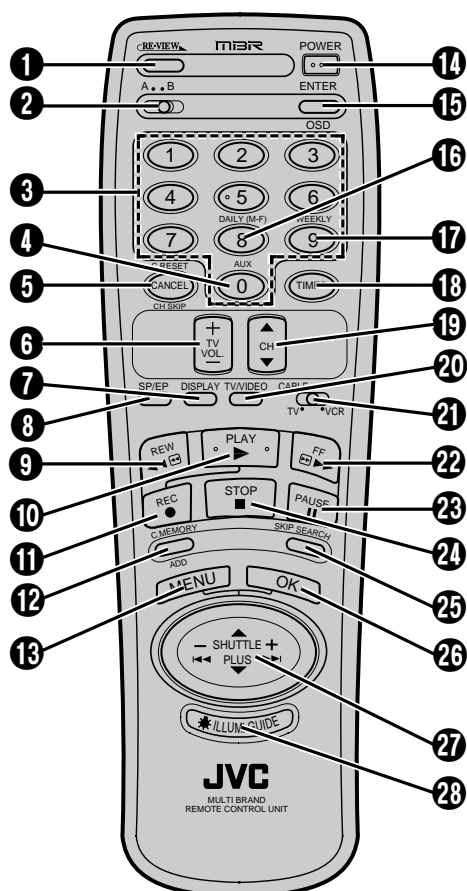

- 1 Instant REVIEW Button (☞ pg. 30)
- 2 A/B Code Select Switch (☞ pg. 52)
- 3 NUMBER Buttons (☞ pg. 10)
- 4 "AUX" Mode Select Button (☞ pg. 45)
- 5 CANCEL Button (☞ pg. 42)
- 6 Counter [C.] RESET (☞ pg. 30)
- 7 Channel [CH.] SKIP Button (☞ pg. 14)
- 8 Volume [VOL] +/- Buttons (☞ pg. 50)
- 9 DISPLAY Button (☞ pg. 30)
- 10 Recording Speed [SP/EP] Button (☞ pg. 23)
- 11 Rewind [REW] Button (☞ pg. 22)
- 12 PLAY Button (☞ pg. 22)
- 13 Record [REC] Button (☞ pg. 23)
- 14 Counter [C.] MEMORY Button (☞ pg. 30)
- 15 ADD Button (☞ pg. 14)
- 16 MENU Button (☞ pg. 8)
- 17 POWER ON/OFF Button (☞ pg. 8)
- 18 ENTER Button (☞ pg. 23)
- 19 On-Screen Display [OSD] Button (☞ pg. 28)
- 20 DAILY Timer Recording Button (☞ pg. 39)
- 21 WEEKLY Timer Recording Button (☞ pg. 39)
- 22 TIMER Button (☞ pg. 39)
- 23 Channel [CH] ▲▼ Buttons (☞ pg. 8)
- 24 TV/VIDEO Button (☞ pg. 8)
- 25 TV/CABLE/VCR Switch (☞ pg. 50)
- 26 Fast-Forward [FF] Button (☞ pg. 22)
- 27 PAUSE Button (☞ pg. 23)
- 28 STOP Button (☞ pg. 22)
- 29 SKIP SEARCH Button (☞ pg. 29)
- 30 OK Button (☞ pg. 8)
- 31 SHUTTLE PLUS Button (☞ pg. 8)
- 32 ILLUMI GUIDE Button (☞ pg. 38)

** If the remote control doesn't work properly, remove its batteries, wait a short time and then try again.

**GENERAL**

Power requirement	: AC 120 V \sim , 60 Hz
Power consumption	: 21 W
Temperature	
Operating	: 5°C to 40°C (41°F to 104°F)
Storage	: -20°C to 60°C (-4°F to 140°F)
Operating position	: Horizontal only
Dimensions (W x H x D)	: 400 x 94 x 291 mm (15-3/4" x 3-3/4" x 11-1/2")
Weight	: 3.7 kg (8.2 lbs)
Format	: VHS NTSC standard
Maximum recording time	
SP	: 210 min. with ST-210 video cassette
EP	: 630 min. with ST-210 video cassette

VIDEO/AUDIO

Signal system	: NTSC-type color signal and EIA monochrome signal, 525 lines/60 fields
Recording/ Playback system	: DA-4 (Double Azimuth) head helical scan system
Signal-to-noise ratio	: 45 dB
Horizontal resolution	: 240 lines
Frequency range	
Normal audio	: 70 Hz to 10,000 Hz
Hi-Fi audio	: 20 Hz to 20,000 Hz
Input/Output	: RCA connectors (IN x 2, OUT x 1)

TUNER

Tuning system	: Frequency-synthesized tuner
Channel coverage	
VHF	: Channels 2-13
UHF	: Channels 14-69
CATV	: 113 Channels
RF output	: Channel 3 or 4 (switchable; preset to Channel 3 when shipped) 75 ohms, unbalanced

TIMER

Clock reference	: Quartz
Program capacity	: 1-year programmable timer/8 programs
Memory backup time	: Approx. 10 min.

ACCESSORIES

Provided accessories	: RF cable (F-type), Infrared remote control unit, "AA" battery x 2, Cable Box Controller, Audio/Video cable
----------------------	--

Specifications shown are for SP mode unless otherwise specified. E. & O.E. Design and specifications subject to change without notice.



HOW TO LOCATE YOUR JVC SERVICE CENTER

TOLL FREE: 1-800-252-5722

Dear customer:

In order to receive the most satisfaction from your purchase, read the instruction booklet before operating the unit. In the event that repair is necessary, or for the address nearest your location, please refer to the factory service center list below or within the Continental United States, call 1-800-252-5722 for your authorized servicer. Remember to retain your Bill of Sale for Warranty Service.

— JVC

**JVC SERVICE & ENGINEERING
COMPANY OF AMERICA
DIVISION OF US JVC CORP.**

FACTORY SERVICE CENTER LOCATIONS

107 Little Falls Road
Fairfield, NJ 07004-2105
(201) 808-9279

1500 Lakes Parkway
Lawrenceville, GA 30243-5357
(770) 339-2522

705 Enterprise Street
Aurora, IL 60504-8149
(708) 851-7855

5665 Corporate Avenue
Cypress, CA 90630-0024
(714) 229-8011

10700 Hammerly, Suite 110
Houston, TX 77043-2310
(713) 935-9331

2969 Mapunapuna Place
Honolulu, HI 96819-2040
(808) 833-5828

230 Eliot Street
Ashland, MA 01721-2377
(508) 881-5923

14505 Commerce Way
Miami Lakes, FL 33016-1512
(305) 362-6252

890 Dubuque Avenue
South San Francisco, CA 94080-1804
(415) 871-2666

Sophisticated electronic products may require occasional service. Just as quality is a keyword in the engineering and production of the wide array of JVC products, service is the key to maintaining the high level performance for which JVC is world famous. The JVC service and engineering organization stands behind our products.

NATIONAL HEADQUARTERS
JVC SERVICE & ENGINEERING COMPANY OF AMERICA
DIVISION OF US JVC CORP.
107 Little Falls Road
Fairfield, NJ 07004-2105

If you ship the product...

Pack your JVC unit in the original carton or one of equivalent size and strength. Enclose, with the unit, a letter stating the problem or symptom that exists and also a copy of the receipt or bill of sale you received when you purchased your JVC unit. Print your home return address on the outside and the inside of the carton. Send to the appropriate JVC Factory Service Center as listed above.

Don't service it yourself.

CAUTION

*To prevent electrical shock, do not open the cabinet. No user serviceable parts inside.
Refer servicing to qualified service personnel.*

ACCESSORIES

*To purchase accessories for your JVC product, you may contact your local JVC Dealer.
Or from the 48 Continental United States call toll free:
1-800-882-2345.*



LIMITED WARRANTY

CONSUMER VIDEO 1-90

JVC COMPANY OF AMERICA warrants this product and all parts thereof, except as set forth below ONLY TO THE ORIGINAL PURCHASER AT RETAIL to be FREE FROM DEFECTIVE MATERIALS AND WORKMANSHIP from the date of original retail purchase for the period as shown below. ("The Warranty Period")

PARTS	1 YR	LABOR	90 DAYS
-------	-------------	-------	----------------

THIS LIMITED WARRANTY IS VALID ONLY IN THE FIFTY (50) UNITED STATES, THE DISTRICT OF COLUMBIA AND IN COMMONWEALTH OF PUERTO RICO.

WHAT WE WILL DO:

If this product is found to be defective, JVC will repair or replace defective parts at no charge to the original owner. Such repair and replacement services shall be rendered by JVC during normal business hours at JVC authorized service centers. Parts used for replacement are warranted only for the remainder of the Warranty Period. All products and parts thereof may be brought to a JVC authorized service center on a carry-in basis except for Television sets having a screen size 25 inches and above which are covered on an in-home basis.

WHAT YOU MUST DO FOR WARRANTY SERVICE:

Return your product to a JVC authorized service center with a copy of your bill of sale. For your nearest JVC authorized service center, please call toll free: (800) 252-5722.

If service is not available locally, box the product carefully, preferably in the original carton, and ship, insured, with a copy of your bill of sale plus a letter of explanation of the problem to the nearest JVC Factory Service Center, the name and location of which will be given to you by the toll-free number.

If you have any questions concerning your JVC Product, please contact our Customer Relations Department.

WHAT IS NOT COVERED:

This limited warranty provided by JVC does not cover:

1. Products which have been subject to abuse, accident, alteration, modification, tampering, negligence, misuse, faulty installation, lack of reasonable care, or if repaired or serviced by anyone other than a service facility authorized by JVC to render such service, or if affixed to any attachment not provided with the products, or if the model or serial number has been altered, tampered with, defaced or removed;
2. Initial installation and installation and removal for repair;
3. Operational adjustments covered in the Owner's Manual, normal maintenance, video and audio head cleaning;
4. Damage that occurs in shipment, due to act of God, and cosmetic damage;
5. Signal reception problems and failures due to line power surge;
6. Video Pick-up Tubes/CCD Image Sensor, Cartridge, Stylus (Needle) are covered for 90 days from the date of purchase;
7. Accessories;
8. Batteries (except that Rechargeable Batteries are covered for 90 days from the date of purchase); from the date of purchase);

There are no other express warranties except as listed above.

THE DURATION OF ANY IMPLIED WARRANTIES INCLUDING THE IMPLIED WARRANTY OF MERCHANTABILITY, IS LIMITED TO THE DURATION OF THE EXPRESS WARRANTY HEREIN.

JVC SHALL NOT BE LIABLE FOR THE LOSS OF USE OF THE PRODUCT, INCONVENIENCE, LOSS OR ANY OTHER DAMAGES, WHETHER DIRECT, INCIDENTAL OR CONSEQUENTIAL (INCLUDING, WITHOUT LIMITATION, DAMAGE TO TAPES, RECORDS OR DISCS) RESULTING FROM THE USE OF THIS PRODUCT, OR ARISING OUT OF ANY BREACH OF THIS WARRANTY. ALL EXPRESS AND IMPLIED WARRANTIES, INCLUDING THE WARRANTIES OF MERCHANTABILITY AND FITNESS FOR PARTICULAR PURPOSE, ARE LIMITED TO THE WARRANTY PERIOD SET FORTH ABOVE.

Some states do not allow the exclusion of incidental or consequential damages or limitations on how long an implied warranty lasts, so these limitations or exclusions may not apply to you. This warranty gives you specific legal rights and you may also have other rights which vary from state to state.

JVC COMPANY OF AMERICA
DIVISION OF US JVC CORP.

41 Slater Drive
Elmwood Park, New Jersey 07407

REFURBISHED PRODUCTS CARRY A SEPARATE WARRANTY, THIS WARRANTY DOES NOT APPLY. FOR DETAILS OF REFURBISHED PRODUCT WARRANTY, PLEASE REFER TO THE REFURBISHED PRODUCT WARRANTY INFORMATION PACKAGED WITH EACH REFURBISHED PRODUCT.

For customer use:

Enter below the Model No. and Serial No. which is located either on the rear, bottom or side of the cabinet. Retain this information for future reference.

Model No.: _____

Serial No.: _____

Purchase date: _____

Name of dealer: _____

HR-VP639U

JVC

JVC COMPANY OF AMERICA
DIVISION OF US JVC CORP.
41 Slater Drive, Elmwood Park, N.J. 07407

COPYRIGHT © 1996 VICTOR COMPANY OF JAPAN, LTD.

U/U(C)  Printed in Malaysia
0596HOV*UN*PJ

Free Manuals Download Website

<http://myh66.com>

<http://usermanuals.us>

<http://www.somanuals.com>

<http://www.4manuals.cc>

<http://www.manual-lib.com>

<http://www.404manual.com>

<http://www.luxmanual.com>

<http://aubethermostatmanual.com>

Golf course search by state

<http://golfingnear.com>

Email search by domain

<http://emailbydomain.com>

Auto manuals search

<http://auto.somanuals.com>

TV manuals search

<http://tv.somanuals.com>