

# JVC®

## VIDEO CASSETTE RECORDER

# SR-9090U

## INSTRUCTIONS

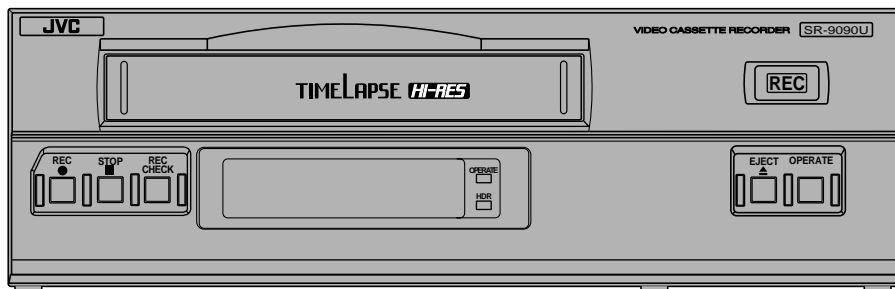

# TIME LAPSE

Thank you for purchasing this JVC product. Before operating this unit, please read the instructions carefully to ensure the best possible performance.

This instruction manual is made from 100% recycled paper.

### For Customer Use:

Enter below the Serial No. which is located on the rear of cabinet. Retain this information for future reference.

Model No. SR-9090U

Serial No. \_\_\_\_\_

INTRODUCTION

CONTROLS AND CONNECTORS

CONNECTIONS

ON-SCREEN/MENU SWITCHES

PREPARATION

RECORDING



PLAYBACK AND SPECIAL-EFFECTS PLAYBACK

TROUBLE-SHOOTING

OPTIONAL SA-K97U RS-232C INTERFACE BOARD

APPENDICES

# SAFETY PRECAUTIONS

	<b>CAUTION</b> RISK OF ELECTRIC SHOCK DO NOT OPEN	
<p>CAUTION: TO REDUCE THE RISK OF ELECTRIC SHOCK, DO NOT REMOVE COVER (OR BACK). NO USER-SERVICEABLE PARTS INSIDE. REFER SERVICING TO QUALIFIED SERVICE PERSONNEL</p>		

	<b>ATTENTION</b> RISQUE D'ELECTROCUTION NE PAS OUVRIR	
<p>ATTENTION: POUR EVITER TOUT RISQUE D'ELECTROCUTION NE PAS OUVRIR LE BOITER. AUCUNE PIECE INTERIEURE N'EST A REGLER PAR L'UTILISATEUR. SE REFERER A UN AGENT QUALIFIE EN CAS DE PROBLEME.</p>		

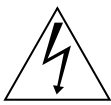

The lightning flash with arrowhead symbol, within an equilateral triangle, is intended to alert the user to the presence of uninsulated "dangerous voltage" within the product's enclosure that may be of sufficient magnitude to constitute a risk of electric shock to persons.



The exclamation point within an equilateral triangle is intended to alert the user to the presence of important operating and maintenance (servicing) instructions in the literature accompanying the appliance.

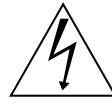

Le symbole de l'éclair à l'intérieur d'un triangle équilatéral est destiné à alerter l'utilisateur sur la présence d'une "tension dangereuse" non isolée dans le boîtier du produit. Cette tension est suffisante pour provoquer l'électrocution de personnes.



Le point d'exclamation à l'intérieur d'un triangle équilatéral est destiné à alerter l'utilisateur sur la présence d'opérations d'entretien importantes au sujet desquelles des renseignements se trouvent dans le manuel d'instructions.

\*Ces symboles ne sont utilisés qu'aux Etats-Unis.

**WARNING:**  
TO REDUCE THE RISK OF FIRE OR ELECTRIC SHOCK, DO NOT EXPOSE THIS APPLIANCE TO RAIN OR MOISTURE.

This unit should be used with 120 V AC only.

**CAUTION:**  
To prevent electric shocks and fire hazards, DO NOT use any other power source.

#### NOTE:

The rating plate (serial number plate) is on the rear of the unit.

#### INFORMATION

This equipment has been tested and found to comply with the limits for a Class B digital device, pursuant to Part 15 of the FCC Rules. These limits are designed to provide reasonable protection against harmful interference in a residential installation. This equipment generates, uses, and can radiate radio frequency energy and, if not installed and used in accordance with the instructions, may cause harmful interference to radio communications. However, there is no guarantee that interference will not occur in a particular installation. If this equipment does cause harmful interference to radio or television reception, which can be determined by turning the equipment off and on, the user is encouraged to try to correct the interference by one or more of the following measures:

- Reorient or relocate the receiving antenna.
- Increase the separation between the equipment and receiver.
- Connect the equipment into an outlet on a circuit different from that to which the receiver is connected.
- Consult the dealer or an experienced radio/TV technician for help.

#### CAUTION

CHANGES OR MODIFICATIONS NOT APPROVED BY JVC COULD VOID USER'S AUTHORITY TO OPERATE THE EQUIPMENT.

THIS DEVICE COMPLIES WITH PART 15 OF THE FCC RULES. OPERATION IS SUBJECT TO THE FOLLOWING TWO CONDITIONS: (1) THIS DEVICE MAY NOT CAUSE HARMFUL INTERFERENCE, AND (2) THIS DEVICE MUST ACCEPT ANY INTERFERENCE RECEIVED, INCLUDING INTERFERENCE THAT MAY CAUSE UNDESIRED OPERATION.

**AVERTISSEMENT:**  
POUR EVITER LES RISQUES D'INCENDIE OU D'ELECTROCUTION, NE PAS EXPOSER L'APPAREIL A L'HUMIDITE OU A LA PLUIE.

Ce magnétoscope ne doit être utilisé que sur du courant alternatif en 120 V.

**ATTENTION:**  
Afin d'éviter tout risque d'incendie ou d'électrocution, ne pas utiliser d'autres sources d'alimentation électrique.

#### REMARQUE:

La plaque d'identification (numéro de série) se trouve sur le panneau arrière de l'appareil.

#### WARNING:

The battery used in the SR-9090U must be replaced by a JVC authorized service dealer only.

This digital apparatus does not exceed the Class B limits for radio noise emissions from digital apparatus as set out in the interference-causing equipment standard entitled "Digital Apparatus", ICES-003 of the Department of Communications.

Cet appareil numérique respecte les limites de bruits radioélectriques applicables aux appareils numériques de Classe B prescrites dans la norme sur le matériel brouilleur: "Appareils Numériques", NMB-003 édictée par le ministre des Communications.

# OPERATION LOCK

By engaging the operation lock system [LOCK], you can prevent accidental or deliberate interference with recording operation or power supply.

When this function is activated, all operation buttons are disabled. However, you can still control the recorder with the remote control.

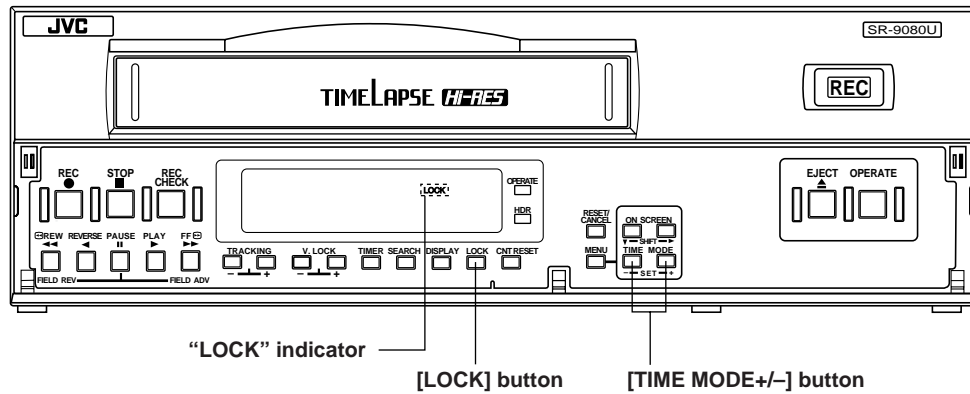

- 1 Engage the mode you want to lock (such as the Rec or Play mode).
- 2 While pressing the [LOCK] button, press the [TIME MODE+/-] button. "LOCK" is shown on the display, indicating that the Operation Lock mode is engaged.
- 3 To unlock the VCR, press the [TIME MODE+/-] button while pressing the [LOCK] button. The "LOCK" indication on the display disappears and the unit can now be operated normally.

To prevent unauthorized use, detach this page and keep it in a safe place.



# CONTENTS

---

## 1 INTRODUCTION

---

1-1 Major Features .....	6
1-2 Periodical Maintenance .....	7
1-3 Precautions .....	7
1-4 Daily Inspection .....	8

## 2 CONTROLS AND CONNECTORS

---

2-1 Front Panel .....	9
2-2 Display .....	11
2-3 Rear Panel .....	12

## 3 CONNECTIONS

---

3-1 Connecting to a Camera .....	14
3-2 System Using Sequential Switcher .....	15
3-3 Connecting the Rear Panel Input/Output Terminal Connections .....	16

## 4 ON-SCREEN/MENU SWITCHES

---

4-1 On-Screen Display .....	17
4-2 Main Menu Display .....	18
4-3 Date and Time Setting .....	19
4-4 Hour Meter Display .....	20
4-5 Alarm Input/Power Loss Data Display .....	21
4-6 Menu Switch Setting .....	22
4-7 Contents of Menu Switches .....	23

## 5 PREPARATION

---

5-1 Cassette Loading/Unloading .....	27
5-2 Recording/Playback Speed Mode Selection .....	28

## 6 RECORDING

---

6-1 Switch Setting During Recording .....	29
6-2 Recording Basic Operation .....	30
6-3 Timer Recording .....	31
• Timer Recording Program Setting .....	31
• Holiday Timer Recording Setting .....	35
• Canceling/Changing Timer Recording Program .....	36
• Notes on Timer Recording .....	37
6-4 Alarm Recording .....	38
6-5 Sensor Recording .....	40
6-6 Series Recording .....	41
6-7 Repeat Recording .....	43
6-8 Recording with External VCR Activation Signal .....	44
6-9 How to Restore Recording After Power Failure .....	45
6-10 External Timer Recording .....	45
6-11 Tape End Buzzer .....	45

## 7 PLAYBACK AND SPECIAL-EFFECTS PLAYBACK

---

7-1 Preparation .....	46
7-2 Playback .....	46
7-3 Special-Effects Playback .....	47
• Still/Field Advance/Reverse Playback .....	47
• Shuttle Search .....	48
7-4 Alarm Search/Date and Time Search .....	49
7-5 Repeat Playback .....	51
7-6 Counter Memory Function .....	51
7-7 Tracking/V. Lock Adjustment .....	52
7-8 V. Pulse .....	52

## 8 TROUBLESHOOTING

---

8-1 Error Indications .....	53
8-2 No Error Indication .....	54

## 9 OPTIONAL SA-K97U RS-232C INTERFACE BOARD

---

9-1 Installation of the SA-K97U .....	55
9-2 SA-K97U Specifications .....	56
9-3 SA-K97U RS-232C Protocol & Commands .....	57

## 10 APPENDIXES

---

10-1 Tape Reel Counter/Tape Remaining Time Table .....	64
10-2 Rear Panel's Inputs/Outputs .....	65
10-3 Specifications .....	66

The SR-9090U is a video cassette recorder able to execute timelapse recording with VHS cassettes.

Use only video cassettes bearing the **VHS** mark.

This unit is designed for professional use.

JVC is not liable for compensation for loss or damage to recordings in the event this unit fails to record or play back properly because the unit malfunctions or a defective video cassette tape is used.

Please note that it may be unlawful to use any material recorded from TV broadcast programs or pre-recorded programs without the consent of the owner of copyright, except in cases where this material is recorded exclusively for personal use.

# 1 INTRODUCTION

## 1-1 Major Features

- **Extended timelapse recording for up to 960 hours**  
Recording times are selectable from 2 hours (SP mode), 6 hours (EP mode) and 24/48/72/120/168/240/480/960 (Timelapse mode) (when T-120 tape is used).
  - **High-resolution recording**  
Delivers horizontal resolution of more than 400 lines even in color mode.  
\*When a tape recorded on this unit is played back on another VCR, noise may appear on playback picture.
  - **High-density recording (HDR) function**  
Using the EP head, the tape is advanced at a fine pitch for timelapse recording. In this way, about three times more information is recorded in the same period than in conventional timelapse modes. While this results in some degradation of picture quality, the increased coverage allows you to analyze the development of a situation in greater detail. The actual recording duration on the tape is the same as that of an ordinary timelapse recording (select with menu switch <HDR>).
  - **Alarm recording function**  
When an alarm signal is input in the Record mode, the 2/6-hour mode is automatically engaged. Alarm recording time can be selected from 5, 10, 15, 30, 60, 120, or 180 sec., to tape end, or set manually. An index code is automatically recorded at the start point of the alarm recording for use as an alarm cue signal. Alarm recording points can be accessed quickly with the alarm search function.
  - **Sensor recording**  
Whenever an alarm signal is input in the Stop mode (Stop, Timer Recording Standby or Operating Off mode), the Record mode is automatically engaged.
  - **Time/date generator**  
Superimposes date, month, year, hour, minute and second on the image during recording. Also allows you to display the number of alarms, alarm time, and the number of the power failures on a monitor.
  - **Timer-recording function**  
Up to 8 programs can be set for daily, weekly, or weekday timer-recording. You can also set timer recording for up to 16 days a year by specifying the date (holidays, for example).
  - **Tape position search function**  
You can automatically search the start of an alarm recording or search for a recording made at a specified date and time.
  - **Recording check function**  
Recording conditions (quality) can be checked at any time during recording by pressing the recording check button.
  - **Operation lock system**  
The secret operation lock system prevents an accidental or deliberate interference with VCR operation.
  - **Camera switching signal output terminal**
  - **Warning function**  
Error indications are shown on the front panel display. Error warnings include condensation and problems with cassette loading, cassette unloading, or the rotating system operation mode.
  - **Operating mode-off video throughout function**  
Even when the operating mode is off, the camera's EE input can be output from the VCR.
  - **Series recording function**  
Two or more SR-9090U can be connected for extended, long-term series recording. As the tape in each VCR reaches the end, the next unit in the series will automatically start recording.
  - **Automatic re-start of recording after a power failure**
  - **Time adjust function**  
With the IN/OUT terminal for time adjustment, the time difference can be set to "0" with multiple SR-9090Us connected. (adjustment time: 00:00/12:00)
  - **Digital hour meter display**
  - **Repeat playback/recording**
  - **Alarm recording, tape end and warning electronic buzzer**
  - **Recording control with external activation signal**
  - **Counter end function**
  - **External timer connection**
  - **Summer time compensation function**
  - **Wired remote control (optional)**
- Used when an optional SA-K97U RS-232C interface board is installed.
- **RS-232C control**  
The SR-9090U can be controlled via a personal computer. Operation status can be monitored on the computer.

# 1 INTRODUCTION

## 1-2 Periodical Maintenance

This VCR incorporates precision mechanical parts which will collect dirt over time and ultimately deteriorate and wear out. Over long periods of use, dirt and dust accumulates on the heads, drums and tape transport mechanisms. Dust which penetrates the VCR (especially during outdoor use) also promotes the wear and deterioration of mechanical parts by causing poor contact between tape and heads. This also prevents the VCR from maintaining video and audio quality at high levels. To prevent wear and deterioration, clean the heads regularly using a head cleaning tape. However, because a head cleaning tape alone cannot clean the entire tape transport mechanism, this should also be inspected periodically to prevent any problems that could result from a sudden failure.

As replacement and adjustment of parts require advanced skills and specialized equipment, please contact the person in charge of professional video equipment at your nearest JVC-authorized service agent for servicing.

### Monitoring Usage Time

The total operation time reached by an ordinary home VCR in 5 or 6 years may be reached by a professional VCR in as few as 5 or 6 months. Therefore, it is important that the total hours of operation be carefully monitored. An hour meter in the on-screen display (see page 20) shows the accumulated time. In the chart below, the hours accumulated in each month are shown in relation to the number of hours used per day. Times shown in the shaded area indicate that maintenance should be performed.

Usage time per day	1 month	2 months	3 months	6 months	12 months
2 hours	60	120	180	360	720
8 hours	240	480	720	1440	2880
12 hours	360	720	1080	2160	4320
24 hours	720	1440	2160	4320	8640

### Periodic Maintenance

Check or replace the following mechanical parts according to the running time.

Running time	1000H	2000H	3000H	4000H
Drum ass'y (including heads)	△	○	○	●
Pinch rollers	△	○	○	●
Drive parts	△	△	△	○

- △ : Cleaning
- : Check or replace as required.
- : Replace

- Maintenance requirements may vary depending on the operating environment and usage. The information above should be used as a reference guide. Replace the built-in lithium battery approximately every two years.

## 1-3 Precautions

### Handling and storage place

- **Avoid using the unit in places subject to the following conditions:**
  - extreme heat or cold
  - strong magnetic fields (do not use a transceiver within 2 meters of this unit)
  - high humidity
  - dust and soil
  - vibrations
  - variations in temperature
- **Use this unit in horizontal (flat position) only.**
- **To avoid overheating the unit, do not block ventilation slots or stack the units. If the internal temperature rises too high, the tape may be damaged.**

- **Do not leave the unit in the Still or Record Pause mode for a long time as this may damage the tape.** After about 3 minutes, this unit automatically enters the Stop mode.
- **Handle the unit carefully**
  - Do not place anything heavy on the unit (a monitor, etc.). A malfunction may occur.
  - Do not put any foreign substance into the cassette loading slot.
  - Avoid violent shocks to the recording chassis during transportation. Remove the cassette tape from the unit for transportation.
- **Turn off the power to save electricity when not using the unit.**

### Condensation

- **Condensation**  
When cold beer is poured into a glass, water drops appear on the glass's surface. This phenomenon is called "condensation". When condensation occurs on the VCR's head drum and tape guides it may damage the tape.
- **Condensation occurs in the following cases:**
  - When the VCR is moved from a cold place to a warm place.
  - In a room that has just been heated or in an area directly exposed to a cooler.
  - When there is excessive humidity.

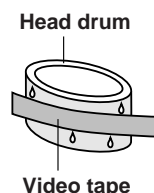

- **When condensation is expected to occur**  
Turn the power of the VCR on before use.
- **If condensation has occurred**  
The VCR automatically ejects the cassette and the error indication "E-08" blinks on the display. Operation is disabled until the "E-08" indication on the display goes out.

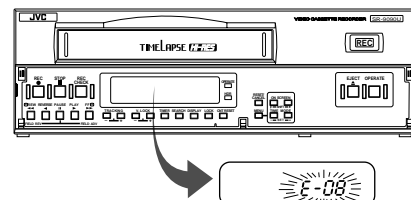

# 1 INTRODUCTION

## 1-3 Precautions

### Video cassette

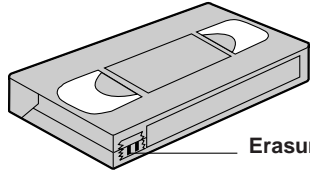

**Timelapse recording is performed over very long periods of time which means that a durable tape is required. When using VHS tapes, do not use tapes with recording times of more than 120 minutes (T-160/T-180 etc.). For best results, use a T-120 tape.**

- Only use video cassette bearing the **VHS** mark.
- To prevent accidental erasure of a recorded tape, break the erasure prevention tab on the cassette. To use a cassette with a broken tab, place a piece of cellophane tape over the broken tab.
- Video cassettes cannot be used upside down.
- Leaving the tape in a partially wound condition for a long time may damage the tape. Rewind the tape to the beginning before storage.

**To obtain the best picture quality, use an HG (high grade) tape (a JVC cassette is recommended). Degradation of picture quality may result with some types of tape. Make a test recording before performing any important recording to check the picture quality.**

## 1-4 Daily Inspection

Although this unit has been designed for reliable operation over a long period of time, a daily inspection is recommended to ensure optimum performance. In particular, be sure to check the repeat recording/playback function on a daily basis.

### Inspection procedure

- 1 Turn on the power for all units connected to the surveillance system.
- 2 Check the quality of the image shown on the monitor.

- 3 Check that the date and time shown on the monitor are correct.
- 4 Rewind the tape recorded the previous day for several seconds.
- 5 Press the play button for playback.
- 6 Check that the playback picture is normal.
- 7 Check that the recorded date and time are correct.

- This unit includes a Recording Check function (using the [REC CHECK] button). Use these features to quickly check recording quality on a daily basis.

If any problems are found after inspection, turn the power off, unplug the power plug from the AC outlet, and contact your JVC dealer.



# 2 CONTROLS AND CONNECTORS

## 2-1 Front Panel

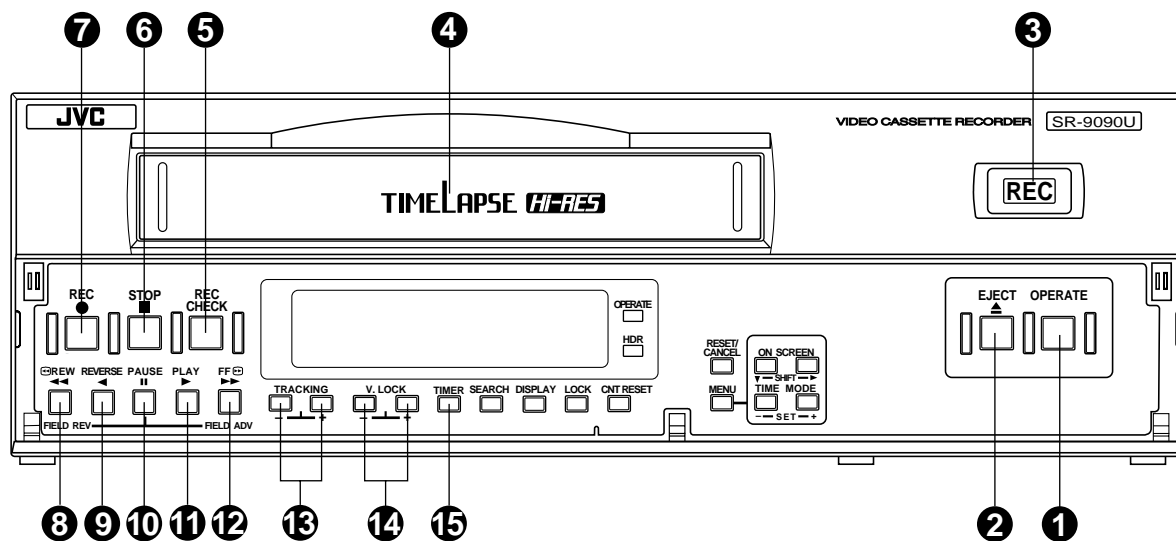

### 1 [OPERATE] button

Press to turn the operating mode ON/OFF. When this button is ON, the OPERATE indicator (2) lights and the unit can be operated. When a cassette is loaded, operating mode is switched on and the OPERATE indicator lights automatically.

The OPERATE button does not completely shut off the mains power to the unit, but switches the operating current on and off.

### 2 [EJECT] button

Press to eject the cassette.

\* The cassette cannot be ejected during recording.

### 3 [REC] indicator

This indicator lights during recording if menu switch <REC TALLY> on the <F. DISP> screen is set to "ON".

### 4 Cassette loading slot

Insert a cassette in this slot. Use a VHS cassette tape.

### 5 [REC CHECK] button

Use this button to check recording.

When pressed in the Record mode, the VCR will rewind the tape for about 5 seconds of tape time and then play back the rewound section in the 2H/6H mode to check recording quality. Recording is resumed automatically after playback at the point where recording was interrupted.

- If picture quality is judged to be inferior during recording check, the heads are cleaned automatically and the error code "E-09" is shown on the display for about 10 seconds. Recording will continue regardless of the results of the recording check.

### 6 [STOP] button

Press this button to stop the tape.

### 7 [REC] button

Press this button in the Stop mode to engage the Record mode.

### 8 [REW] button

- Press this button to rewind the cassette.
- Starts reverse playback when pressed in the Play mode.
- Starts reverse alarm search or date/time search when the Search mode is specified with the (16) [SEARCH] button.
- Also controls field-by-field playback in the reverse direction.

### 9 [REVERSE] button

Starts reverse playback when pressed in any mode except Record, Record-Pause and Record Check.

### 10 [PAUSE] button

- Engages the Record-Pause mode when pressed in the Record mode.
- Displays a still picture when pressed in the Play mode.
- Field advance or reverse playback is executed each time the [FF] or [REW] button is pressed while pressing this button in the Still mode. (When the [FF] or [REW] button is pressed for more than 2 seconds, Continuous Field Advance Playback mode is engaged. After about 3 minutes, the Stop mode is engaged.)

### 11 [PLAY] button

- Press to play back the tape.
- Press to engage the Record mode in the Rec-Pause mode.

### 12 [FF] button

- Press to fast-forward the tape.
- Starts fast-forward playback when pressed in the Play mode.
- Starts forward alarm search or date/time search when the Search mode is specified with the (16) [SEARCH] button.
- Also controls field-by-field playback in the forward direction.

### 13 [TRACKING +/-] buttons

If picture noise appears during play or field advance, press these buttons to adjust tracking so that noise is reduced. When the [+ ] and [- ] buttons are pressed simultaneously, tracking is reset to the preset level.

### 14 [V. LOCK +/-] buttons

Press to reduce vertical picture jitter in the Still, Field Advance Playback and Linear Slow Timelapse Play modes.

### 15 [TIMER] button

Normally use this button for timer recording. For details, refer to "Timer Recording" on page 31.

## 2 CONTROLS AND CONNECTORS

### 2-1 Front Panel

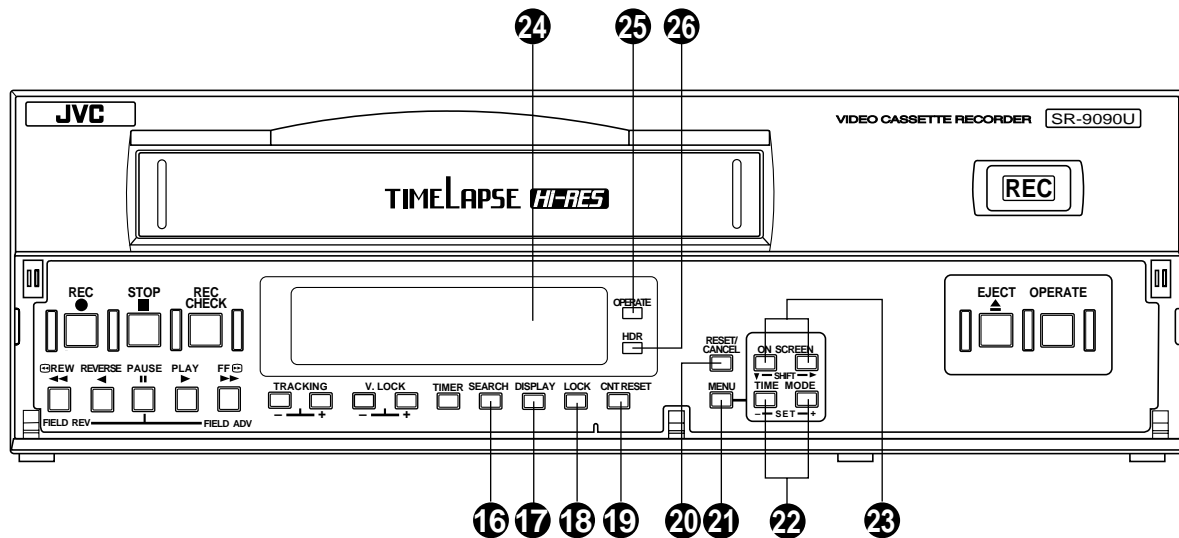

#### 16 [SEARCH] button

Use to search the alarm recorded section or a section recorded at a specified date and time. In the Stop mode, select the search mode by pressing this button.

- Press once to engage the Alarm Search mode.
- Press twice to engage the Alarm Scan mode.
- Press three times to engage the Date/Time Search mode.
- Press four times to release the search mode.

After the search mode is selected with this button, press the [FF] or [REW] button to execute the search operation in the selected mode.

For details, refer to page 49.

#### 17 [DISPLAY] button

Selects which data — current time, control tape counter (00H 00M 00s — 23H 59M 59s) or reel tape counter (0 — 9999) — is displayed. Each time this button is pressed, the display switches to the next item.

#### 18 [LOCK] button

Press to activate the operation lock function.

#### 19 [CNT RESET] button

When the display shows the control tape counter or reel tape counter, press this button to reset to "00H00M00s" or "0000".

#### 20 [RESET/CANCEL] button

• In the Timer Program Setting mode, press this button to cancel the program settings. For details, refer to "Timer Recording" on page 36.

• Also press this button to interrupt alarm recording or to reset the alarm input data or power loss (power failure) data. For details, refer to pages 21 and 39.

• Resets the seconds in the currently displayed time to 00 when pressed together with the 19 [CNT RESET] button (except in menu setting mode).

- When the seconds value is 29 or less, the minutes value is the same but the seconds value is reset to 0. (e.g. 12:34:29 → 12:34:00)

- When the seconds value is 30 or more, the seconds value is reset to "00" and the minutes value is increased by one. (e.g. 12:34:30 → 12:35:00)

#### 21 [MENU] button

Press to display the date/time, timer program, and various other menu setting screens, as well as the hour meter, on the monitor. Press again to cancel the menu or hour meter display.

#### 22 [TIME MODE/SET +/-] buttons

- Use to select the recording and playback speed mode. Available recording/playback speed modes vary depending on the setting of menu switch <HDR> on the <VTR MODE> screen.

Each time these buttons are pressed, the recording/playback speed mode changes as follows. The recording/playback speed mode is shown on the display.

HDR recording: OFF	HDR recording: ON
2H: Standard	2H: Standard
6H: 3x	6H: 3x
24H: 24-hour SP timelapse	24H: 24-hour EP timelapse
48H: 48-hour SP timelapse	48H: 48-hour EP timelapse
72H: 72-hour SP timelapse	72H: 72-hour EP timelapse
120H: 120-hour SP timelapse	120H: 120-hour EP timelapse
168H: 168-hour SP timelapse	168H: 168-hour EP timelapse
240H: 240-hour SP timelapse	240H: 240-hour EP timelapse
480H: 480-hour SP timelapse	480H: 480-hour EP timelapse
960H: 960-hour SP timelapse	960H: 960-hour EP timelapse

- Also use these buttons during date/time setting, timer program setting and menu switch setting to specify setting values.

#### 23 [ON SCREEN/SHIFT ▼/▶] buttons

- Use these buttons on the normal screen to move the display position or recording position of on-screen information. The position can be moved down by pressing the ▼ button and to the right by pressing the ▶ button.
- Use these buttons on the menu screen to select the desired item in date/time setting, timer program setting and menu switch setting.

#### 24 Display section

For details, refer to page 11.

#### 25 [OPERATE] indicator

Lights when the [OPERATE] button is turned on.

#### 26 [HDR] indicator

Lights in the HDR recording and HDR playback modes.

\* HDR: High Density Recording

- For details on HDR recording, refer to page 28.

## 2 CONTROLS AND CONNECTORS

### 2-2 Display

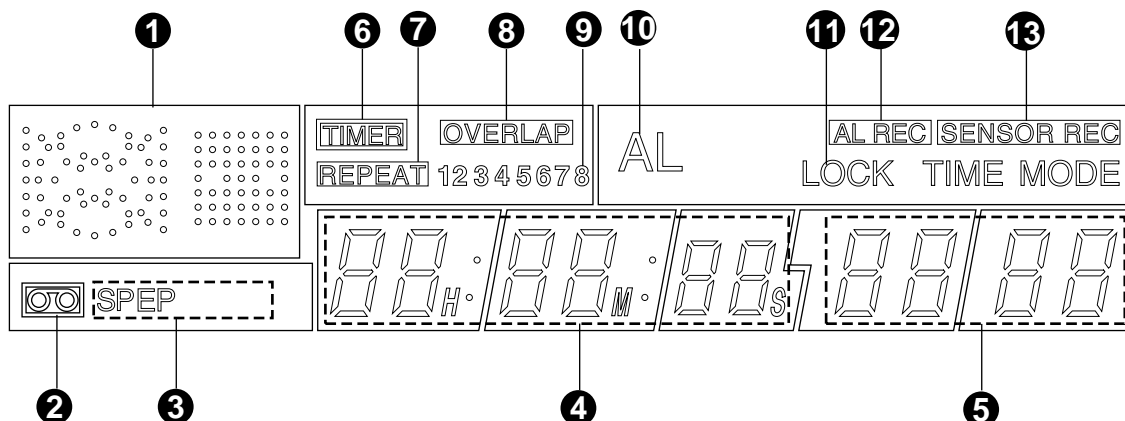

#### 1 Operation mode display

Shows the operation modes.

Playback	Recording	Rewind	Fast-forward	Timelapse playback
Still	Record-pause	Rewind search	Fast-forward search	Reverse playback

\* ( ) mark in the Rec/Pause mode is shown in red.

#### 2 Cassette indication

Lights when a cassette is loaded. Blinks when a cassette is being ejected.

#### 3 [SP/EP] indication

Shows the standard (SP) mode or extended (EP) mode during recording/playback. During ordinary timelapse recording/playback, the [SP] indication is shown. The [EP] indication is shown during recording in the HDR (High-Density Record) mode or during playback of a tape section recorded in the HDR mode.

#### 4 Tape counter/clock indication

- Shows the current time (hour: minute: second), tape control counter (00H 00M 00S — 23H 59M 59S) or tape reel counter (0 — 9999) when the operating mode is on. The display can be selected with the [DISPLAY] button. Shows the current time when the operating mode is off. When a cassette is ejected, the tape control counter and tape reel counter are reset automatically.
- When the cassette is rewound to the beginning in the Repeat Recording or Auto Rewind mode using the counter end output function, the tape control counter and tape reel counter are reset.
- The control and reel counter counts slowly in the Timelapse mode.
- In the timelapse mode, the control counter shows the time equivalent to that shown when a tape is played back in the 2H or 6H mode. (Example: The control counter advances 1 second for about 8 minutes in the 960H ordinary timelapse mode.)
- During date/time search setting and operation, "td" is shown in place of the seconds.
- Shows the setting item during menu switch setting.

#### 5 Recording/playback speed display

- Normally shows the recording/playback speed mode set with the [TIME MODE] button.
- Shows the following indications in the Alarm Search mode.
  - During alarm search: Shows the specified alarm number (example: AL12)
  - During alarm scan: Shows the alarm scan mode (ALSC).
  - During date/time search: Shows the specified date and time (example 2310).
- Shows setting details in menu switch setting.
- When an error occurs, the error indication "E-\*\*\*" blinks (if the menu switch <WARNING> on the <F. DISP> screen is set to "ON").
  - For error indications, refer to page 53.

#### 6 [TIMER] indication

Lights during timer recording programming/operation.

#### 7 [REPEAT] indication

When <REPEAT REC> in the <VTR MODE> menu is set to "ON", this indication is shown. When <TAPE END MODE> in the <ALARM/SENSOR MODE> menu is set to "STOP" and the Repeat Record mode is engaged, the [REPEAT] indication goes out if alarm recording or sensor recording takes place.

#### 8 [OVERLAP] indication

Blinks when programs scheduled for timer recording overlap.

#### 9 Timer program number

All programmed timer recording numbers light. During timer recording, the number of the program being recorded blinks. When the timer recording ends, this number goes out.

#### 10 [AL] (alarm) indication

Shown during alarm recording or sensor recording. Blinks when alarm recording or sensor recording ends.

#### 11 [LOCK] indication

Lights when the operation lock function is activated.

#### 12 [AL REC] (alarm recording) indication

Lights when the menu switch <REC MODE> on the <ALARM/SENSOR MODE> screen is set to "ALARM" or "ALL".

#### 13 [SENSOR REC] (sensor recording) indication

Lights when the menu switch <REC MODE> on the <ALARM/SENSOR MODE> screen is set to "SENSOR" or "ALL".

## 2 CONTROLS AND CONNECTORS

### 2-3 Rear Panel

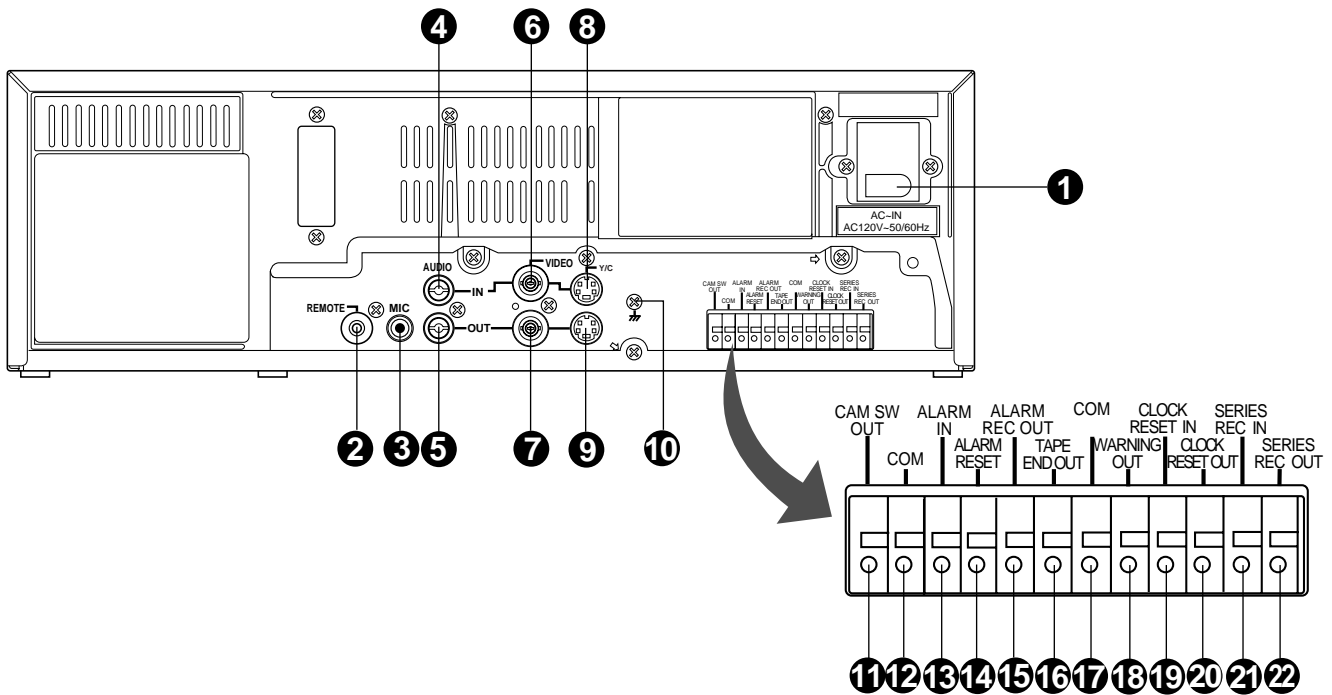

- 1 [AC IN] connector**  
Connect to an AC 120 V, 50/60 Hz power outlet using the provided AC power cable.
- 2 [REMOTE] remote connector (RCA)**  
Connect the optional RM-G30U remote control.
- 3 [MIC IN] mic input connector**  
Connect a microphone with 3.6-mm dia. plug. When signals are input from both the microphone connector and the audio input connector, audio signals are mixed and recorded.
- 4 [AUDIO IN] audio input connector (RCA)**  
Receives audio signals from a connected audio source.
- 5 [AUDIO OUT] audio output connector (RCA)**  
Outputs audio signals. No signal is output in the Timelapse Recording/Playback mode.
- 6 [VIDEO IN] video input connector (BNC)**  
Receives composite video signals from a connected camera or other video source.  
• For composite video signal input, set the <INPUT> menu switch in <VIDEO MODE> to LINE.
- 7 [VIDEO OUT] video output connector (BNC)**  
Outputs composite video signals. Even when the power is not supplied to this unit, input signals (composite video signals) from a camera can be output through this connector (Operating mode-Off Video Throughout function).
- 8 [Y/C IN] connector (4 pin)**  
Inputs separate Y/C signals.  
• For separate Y/C signal input, set the <INPUT> menu switch in <VIDEO MODE> to Y/C.
- 9 [Y/C OUT] connector (4 pin)**  
Outputs separate Y/C signals.
- 10 Signal ground terminal**  
This ground terminal is not provided for safety purposes. It is used to ground signals. Connect this terminal to ground the signal between VCRs.
- 11 [CAM SW OUT] camera switching signal output terminal**  
When a sequential switcher is connected, this terminal outputs camera switching timing control signals. For details on these signals, refer to page 65.
- 12 [COM] common ground terminal**  
Connect to the signal ground terminal of a connected unit.
- 13 [ALARM IN] alarm signal input terminal**  
Receives signals to start alarm or sensor recording.
- 14 [ALARM RESET] alarm signal reset input terminal**  
Receives signals to cancel alarm recording.  
\* Alarm input data is not reset.
- 15 [ALARM REC OUT] alarm recording mode signal output terminal**  
Outputs +12 V signals during alarm recording.

## 2 CONTROLS AND CONNECTORS

### 2-3 Rear Panel

#### 16 [TAPE END OUT] tape end signal output terminal

Outputs a signal when the tape ends during recording. If the menu switch <CNT TAPE END> on the <SRI/EXT MODE> screen is set, signals are output when the specified tape reel counter value is exceeded.

- Outputs a +12 V signal during recording. When the tape ends or the specified counter value is passed, a 0 V (GND level) signal is output.
- When the tape ends during auto repeat recording or auto rewind recording, 0 V signal is output for about 2 seconds.
- Connect an external alarm or buzzer via an external interface.
- To cancel the output, press the [EJECT] button, [PLAY] button, [FF] button or [REW] button.

#### 17 [COM] common ground terminal

Connect to the signal ground terminal of a connected unit.

#### 18 [WARNING OUT] warning signal output terminal

Outputs warning signals (+12 V) when a tape running or mechanism problem occurs.

#### 19 [CLOCK RESET IN] clock reset input terminal

Connect to a master clock or another SR-9090U's [CLOCK RESET OUT] terminal. When the clock reset signal is input, the time is automatically synchronized with the master clock or another SR-9090U's clock. However, the time difference between VCRs should be within  $\pm 30$  seconds.

When the clock reset signal is input, the clock in this unit is reset as shown below.

- When the seconds value is 29 or less, the minutes value is the same but the seconds value is reset to 0. (eg. 12:34:29  $\rightarrow$  12:34:00)
- When the seconds value is 30 or more, the second value is reset to 00 and the minutes value is increased by one. (e.g. 12:34:30  $\rightarrow$  12:35:00)

#### 20 [CLOCK RESET OUT] clock reset output terminal

Outputs the clock reset signal.

The clock reset signal is output in the following cases.

- When the internal clock is at 0:00 or 12:00  
When this unit is connected to another SR-9090U's [CLOCK RESET IN] terminal, the other VCR's clock can be set to the clock in this unit. However, the time difference should be within  $\pm 30$  seconds.

#### 21 [SERIES REC IN] series recording/VCR activation signal input terminal

Receives series recording signal or VCR activation signal from an external control device.

Select the input signal with the menu switches in the <SRI/EXT MODE> menu.

##### ■ Series recording input

A series recording signal is input when [SRI/EXT REC] is set to "SERIES".

- Connect to another VCR's series recording signal output terminal.
- When the tape in the preceding VCR ends, a signal is delivered to this terminal and recording starts automatically.

When the menu switch <CNT TAPE END> on the <SRI/EXT MODE> screen is set, the signals are delivered when the specified tape reel counter value is reached. Recording starts automatically.

##### ■ VCR activation signal input

When [SRI/EXT REC] is set to "EXT", recording is started and stopped with an external signal.

- Connect to an external control device.  
If a VCR activation signal (ground input) is input to this terminal, the VCR starts recording automatically and continues recording for as long as the VCR activation signal is input.

#### 22 [SERIES REC OUT] series recording signal output terminal

Outputs series recording signals.

A series recording signal is output when [SRI/EXT REC] is set to "SERIES".

- Connect to another VCR's series recording signal input terminal.
- Outputs a signal when the tape being recorded in this unit ends.

When the menu switch <CNT TAPE END> on the <SRI/EXT MODE> screen is set, the signals are output when the specified tape reel counter value is reached.

# 3 CONNECTIONS

## 3-1 Connecting to a Camera

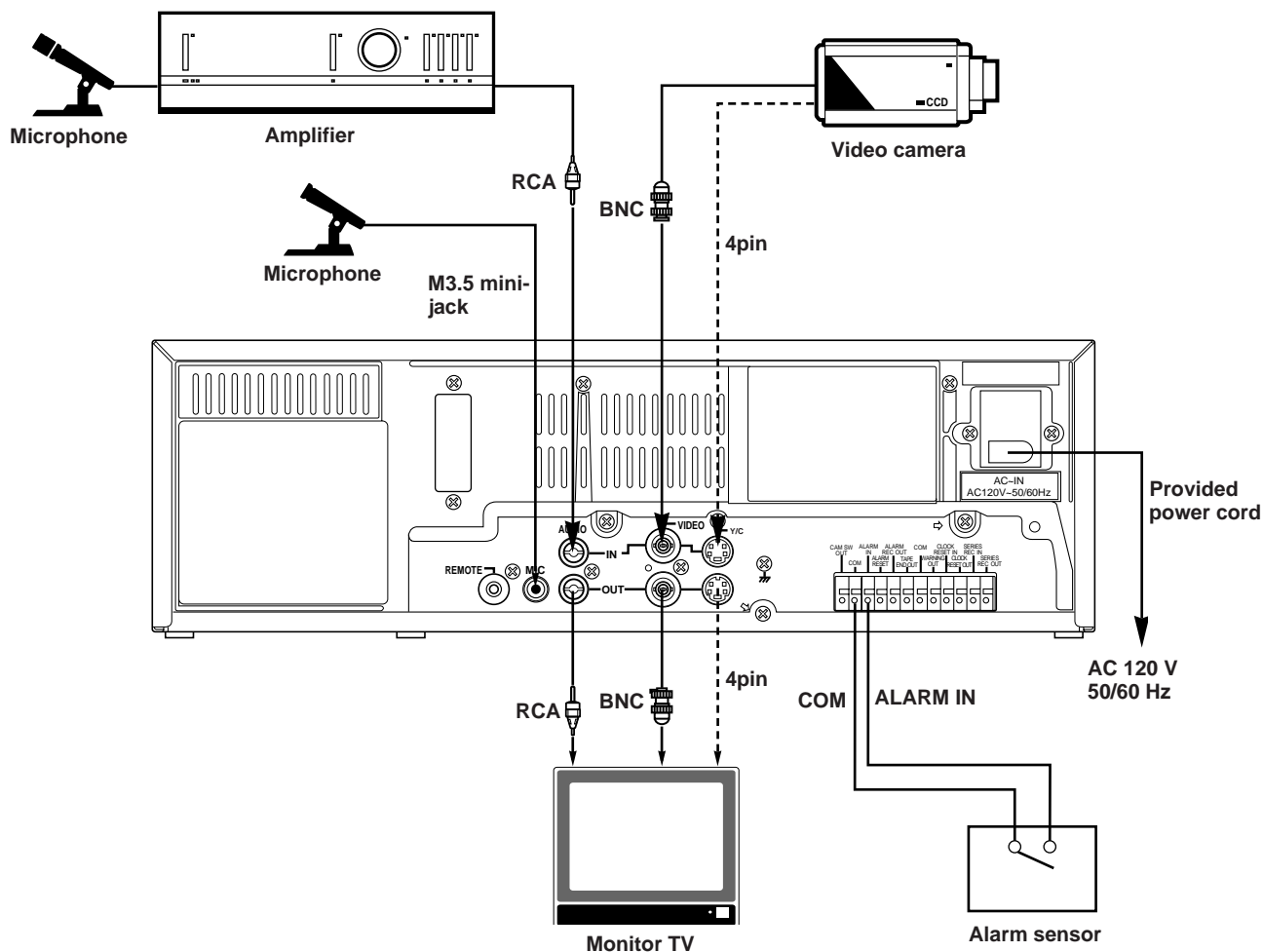

- 1 Connect the monitor's video/audio input connectors to the SR-9090U's video/audio output connectors.
- 2 Connect the video camera's video output connector to the SR-9090U's video input connector.
- 3 Input audio signals to the audio input connectors via an amplifier.
- 4 When connecting an alarm sensor, connect it to the SR-9090U's alarm input terminal.
- 5 When the connection is complete, connect the power plug to an AC 120 V, 50/60 Hz outlet.

## 3 CONNECTIONS

### 3-2 System Using Sequential Switcher

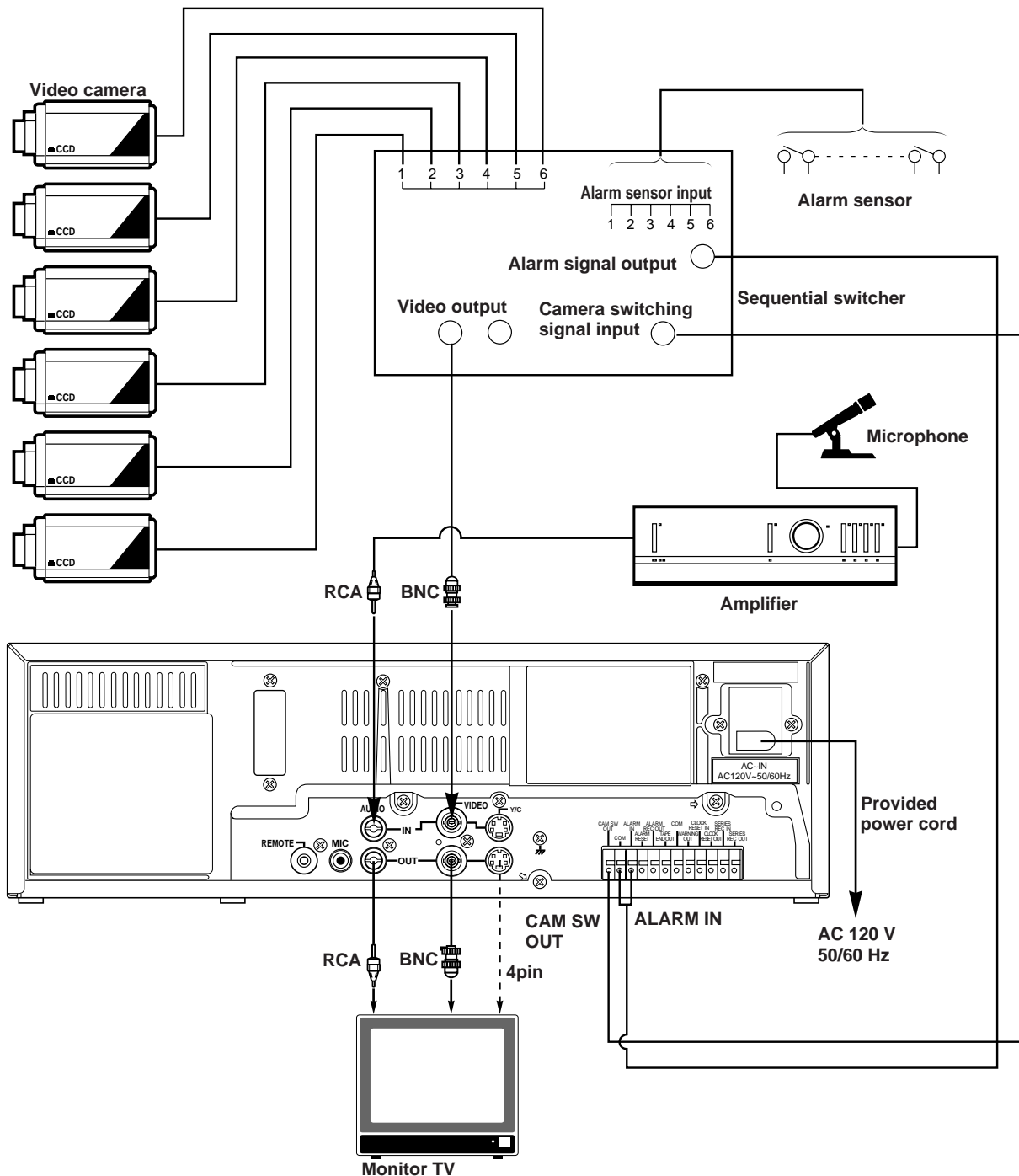

- 1 Connect video cameras and alarm sensor to a sequential switcher (frame switcher).
- 2 Connect the sequential switcher's (frame switcher) alarm signal output, camera switching signal input and video output to the SR-9090U.
- 3 Connect the monitor's video/audio input connectors to the SR-9090U's video/audio output connectors.
- 4 When the connection is complete, connect the power plug to an AC 120 V, 50/60 Hz outlet.
- 5 Synchro should be applied to all connected video cameras.
- 6 If you are connecting the camera switching signal input from a sequential switcher (frame switcher) to the SR-9090U, be sure to set the <CAMERA SW> menu switch.

# 3 CONNECTIONS

## 3-3 Connecting the Rear Panel Input/Output Terminal Connections

[CAM SW OUT] camera switching signal output terminal

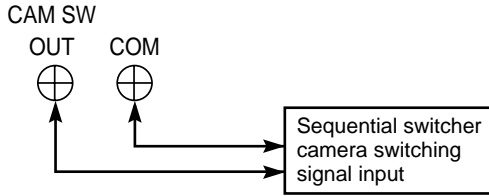

[ALARM IN] alarm signal input terminal

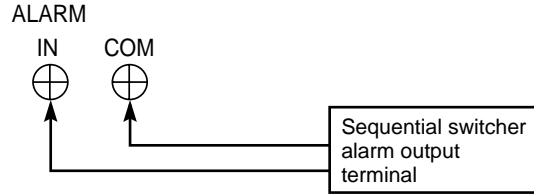

[ALARM RESET] alarm reset terminal

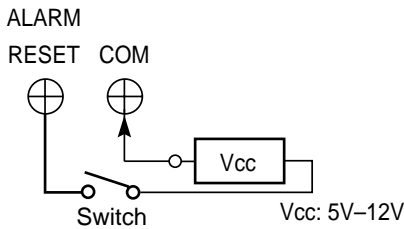

[ALARM REC OUT] alarm recording mode signal output terminal

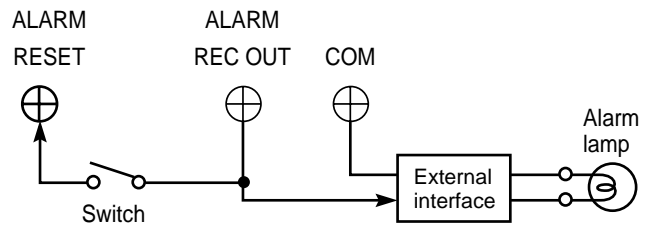

[TAPE END OUT] tape end output terminal

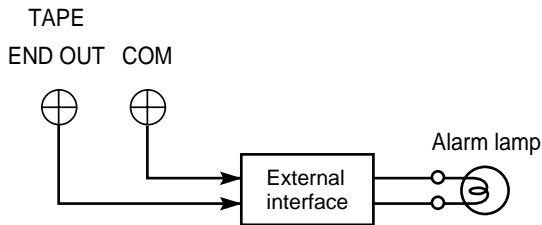

[WARNING OUT] warning signal output terminal

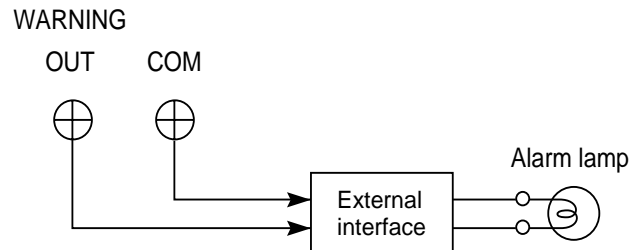

[CLOCK RESET] clock reset terminal

■ When setting the clock to the first VCR's clock

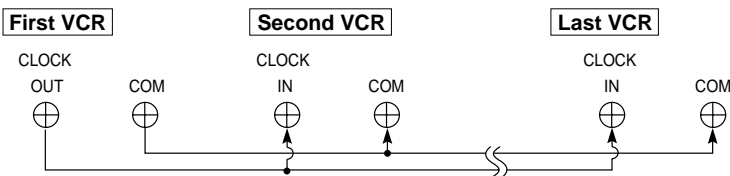

■ When setting the clock to the external master clock

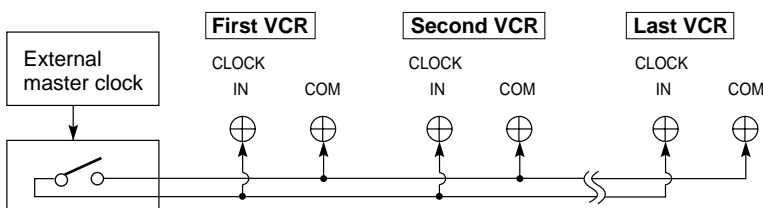

### External interface example

Example: Lamp lights with HIGH signal

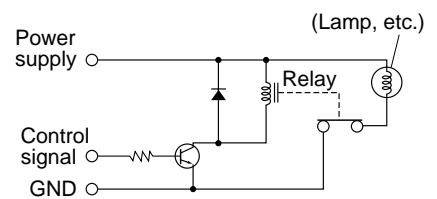

■ Use appropriately rated devices.



# 4 ON-SCREEN/MENU SWITCHES

## 4-1 On-Screen Display

Displays the time date (date and time), recording speed, number of alarms and number of power losses (power failures) on screen in the Stop mode, Record mode and Record-Pause mode.

During recording, the on-screen data is recorded together with video signals.

- The on-screen display position can be moved with the [ON SCREEN] buttons.
- The type of data shown and display brightness can be selected on the <ON SCREEN /F. DISP MODE> screen.

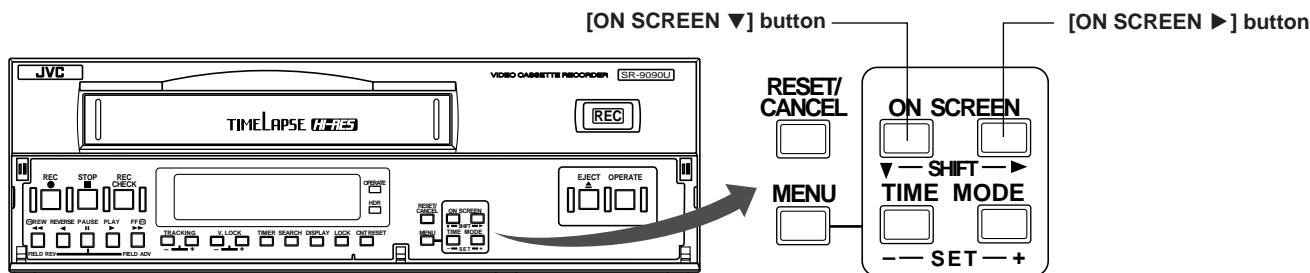

### On-screen display

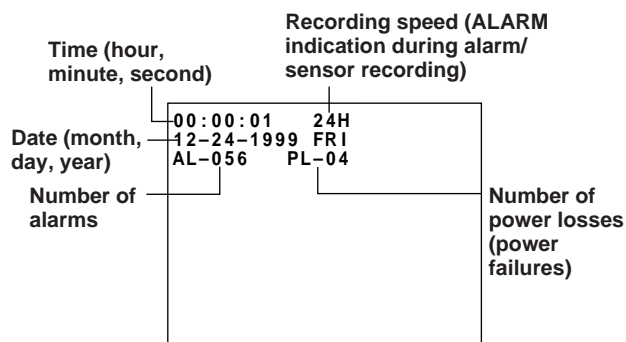

### [ON SCREEN ►] button

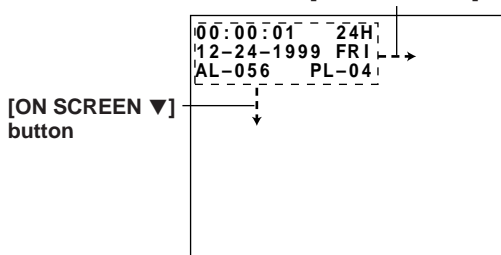

### ON SCREEN MODE screen

[ONSCREEN MODE]	
1. TONE	100 *****
2. DATE	ON
3. TIME	ON
4. REC SPEED	ON
5. ALARM CNT	ON
6. POWER LOSS CNT	ON
[FRONT DISPLAY]	
1. REC TALLY	ON
2. WARNING	ON

### Preparation

- 1 Connect the video output connector of this unit to the monitor's video input connector.
- 1 Turn on the monitor and VCR.
- 2 When a video signal from a camera is input to the video input connector, on-screen data is superimposed on the picture. When there is no input signal, on-screen data is shown on a black background.

### Changing the on-screen display position

- **Move horizontally.**  
Press the [ON SCREEN ►] button.  
→ The display position is moved to the right
- **Move downward.**  
Press the [ON SCREEN ▼] button.  
→ The display position is moved down.

### Selecting the data display

The data displayed on-screen can be selected on the <ON SCREEN MODE> screen.

Set the <ONSCREEN/F. DISP MODE> setting to "ON".

- When you do not want to display or record on-screen data, set the corresponding menu item to "OFF".

### Changing the on-screen display brightness

Set the brightness with the menu switch <TONE> on the <ON SCREEN MODE> screen. Select 0, 30, 70 or 100.

- The higher the number, the brighter the characters.

\* For details on menu operation, refer to page 22.

## 4 ON-SCREEN/MENU SWITCHES

### 4-2 Main Menu Display

You can display date and time data recorded when an alarm input or power failure occurs, as well as the hour meter (drum rotating time) by selecting the desired item in the main menu.

The date/time setting screen, menu switch setting screen for each application, and timer recording program setting screen can also be displayed by selecting the desired item in the main menu.

Date/time setting, menu switch setting and hour meter can be checked on the VCR's display as well.

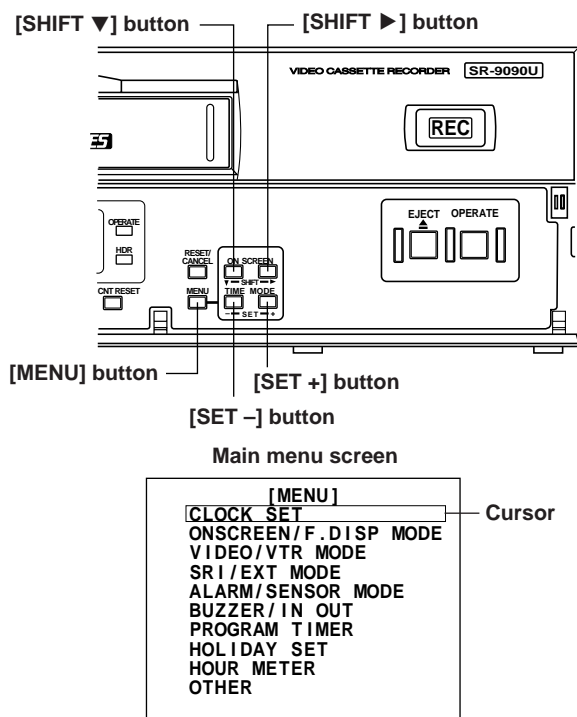

#### Operation

- Connect the video output connector of this unit to the monitor's video input connector.
- 1 Turn on the monitor and VCR.
- 2 Press the [MENU] button.  
→ The main menu screen is shown on the monitor screen.
- 3 Press the [SHIFT ▼] button to move the cursor to the item you want to display.
- 4 Press the [SET +/-] button to display the selected menu screen on the monitor (see below).
- 5 To restore the main menu screen, press the [MENU] button.  
To cancel the main menu mode, press the [MENU] button again. The normal screen is restored.

#### Contents of the main menu items

- **CLOCK SET (VCR's display *clSEt*)**  
Displays the date/time setting screen.  
\* Set the clock before operating the VCR (refer to page 19).
- **ONSCREEN/F. DISP MODE (VCR's display *dISP*)**  
Let's you choose whether or not to display on-screen display items, brightness selection, [REC] indicator and warning indicator.
- **VIDEO/VTR MODE (VCR's display *vidEo*)**  
For VCR operation settings such as V. Pulse ON/OFF, HDR recording, counter memory function and repeat recording/playback.
- **SRI/EXT MODE (VCR's display *Sr i Et*)**  
For setting series recording or automatic recording with an external signal.
- **ALARM/SENSOR MODE (VCR's display *ALSEn*)**  
For setting alarm recording or sensor recording operation.
- **BUZZER/IN OUT (VCR's display *bUZZ io*)**  
Turn ON/OFF buzzers such as the tape end buzzer and alarm/sensor buzzer and set camera switch signal output.
- **PROGRAM TIMER (VCR's display *PrG*)**  
Shows timer recording program settings with the day of the week.
- **HOLIDAY SET (VCR's display *HoL idY*)**  
Shows timer recording program settings at specified dates.
- **HOUR METER (VCR's display *HoUr*)**  
Shows the VCR's operating time (drum rotation time).
- **OTHER (VCR's display *otHEr*)**  
Shows the date and time when an alarm was input or a power failure occurred.

## 4 ON-SCREEN/MENU SWITCHES

### 4-3 Date and Time Setting

The time/date generator and timer recording will not function if the time and date are not set.

Set the month/day/year, hour/minute and Summer Time Compensation ON/OFF on the CLOCK SET screen. The setting can be checked even on the display.

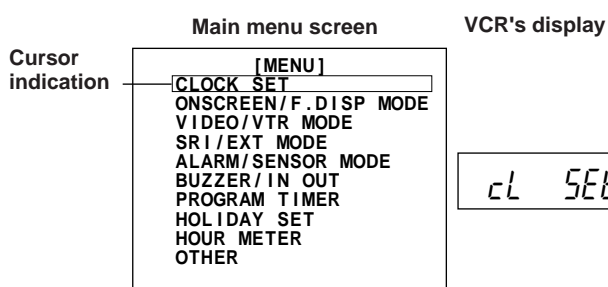
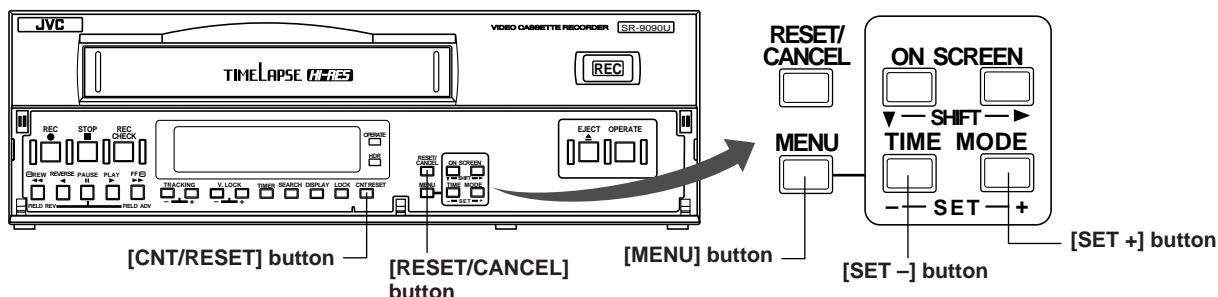

[SET +] button

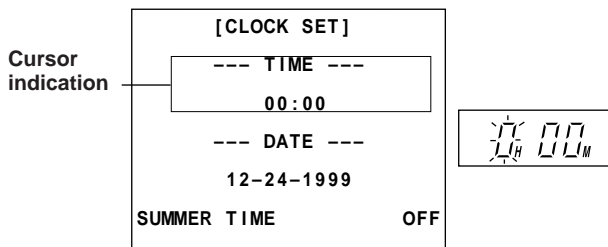

[SHIFT ▼/▶] and [SET +/-] buttons

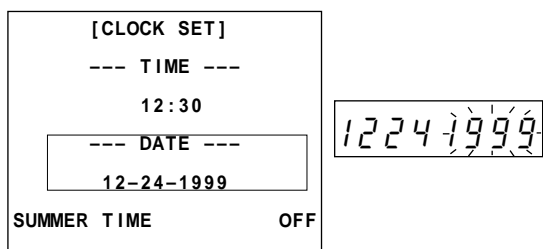

Press twice the [MENU] button.

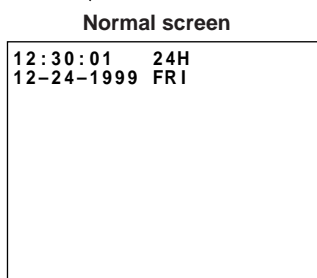

#### Operation

- 1 Turn on the monitor and VCR.
- 2 Press the [MENU] button to display the main menu screen.
- 3 Press the [SHIFT ▼] button to set the cursor on <CLOCK SET> on the main menu.
- 4 Press the [SET +/-] button.
  - The <CLOCK SET> screen is shown. The cursor shows the <TIME> setting item and the hour digit blinks.
  - \* Check that <SUMMER TIME> on the last line is set to "OFF".
- 5 Set the "hour" by pressing the [SET +/-] button. This VCR uses the 24-hour system.
  - Press the [SET +] button to increase the numerical value and the [SET -] button to decrease it (same for minute, month, day and year setting).
  - During summer time period, set the time with a one-hour delay.
  - During standard time period, set the actual time.
- 6 Press the [SHIFT ▶] button so that the minutes digit blinks.
- 7 Press the [SET +/-] button to set the minutes.
- 8 Press the [SHIFT ▼] button.
  - The <DATE> setting item is shown by the cursor and the year item blinks.
  - Press the [SET +/-] button to set the year.
- 9 Press the [SHIFT ▶] button so that the month item blinks and set the month with the [SET +/-] button.
- 10 In the same way, press the [SHIFT ▶] button so that the day item blinks and set the day with the [SET +/-] button.
- 11 For summer time compensation
  - Press the [SHIFT ▼] button to set the cursor to <SUMMER TIME> and press the [SET +/-] button to set <SUMMER TIME> to "ON".
  - The time is automatically adjusted one hour forward in the summer.
- 12 End date/time setting.
  - Press the [MENU] button.
  - The monitor screen returns to the main menu screen and the time count starts from 00 second.
  - Press the [MENU] button again to restore the normal screen.

## 4 ON-SCREEN/MENU SWITCHES

### 4-3 Date and Time Setting

#### Summer Time Compensation

- When setting the time, make sure the <SUMMER TIME> item is set to "OFF".  
When this unit is shipped, this item is set to "OFF".

#### During daylight savings time

- 1 Set the time with a one-hour delay.
- 2 After setting the time, set the <SUMMER TIME> item to "ON".
  - The set time advances one hour.
- 3 At the end of the daylight savings time season, set the <SUMMER TIME> item to "OFF".
  - The standard time instead of <SUMMER TIME> is displayed.

#### Standard time

- 1 Set the clock to the actual time.
- 2 When daylight savings start, set the <SUMMER TIME> item to "ON".
  - The time advances one hour on the display.

#### Time setting for 29 seconds or less

When the seconds value is 29 or less, you can reset it to 00 by pressing the [CNT RESET] button while pressing the [RESET/CANCEL] button.

- For 30 or more, the seconds value is reset to 00 and the minutes value is increased by one.

#### Notes:

- If the power plug has been disconnected from an AC outlet for a long time, make sure the set time is correct before using the unit. (Clock time may be affected by environmental factors.)
- When the built-in backup battery capacity is low, the error indication E-10 appears on the display. Contact your local JVC dealer to replace the built-in battery.

### 4-4 Hour Meter Display

Drum rotation time is displayed on the monitor's screen and the VCR's display in the form of an hour meter. Use this data to schedule maintenance.

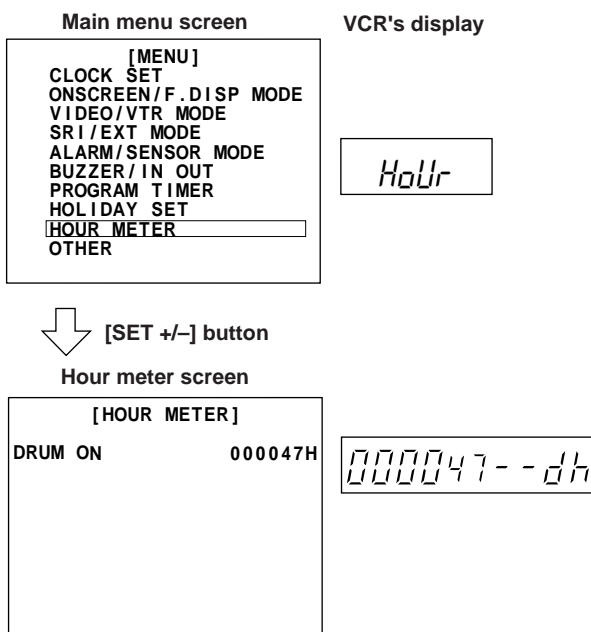

#### Operation

- 1 Turn on the VCR and monitor.
- 2 Press the [MENU] button to display the main menu.
- 3 Press the [SHIFT ▼] button to set the cursor on the <HOUR METER> on the main menu.
- 4 Press the [SET +/-] button to show the hour meter (drum rotating time) on the monitor.
- 5 Press the [MENU] button twice to restore the normal screen.

## 4 ON-SCREEN/MENU SWITCHES

### 4-5 Alarm Input/Power Loss Data Display

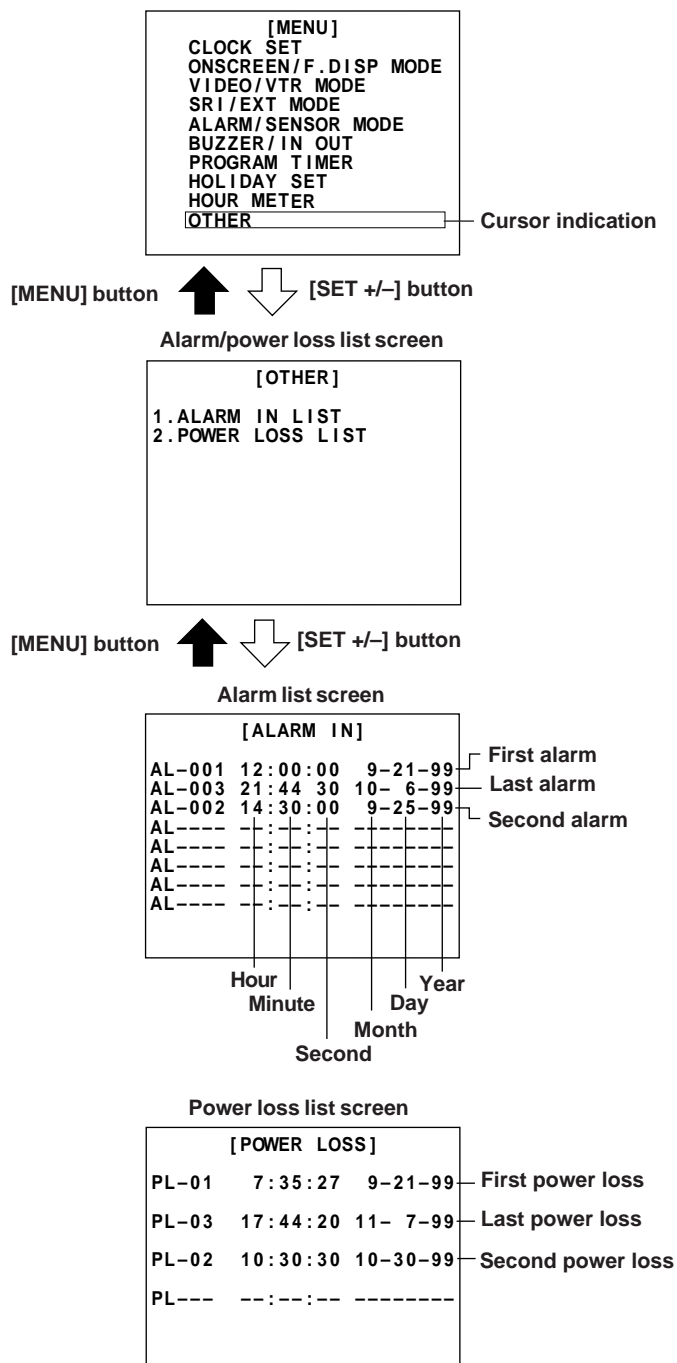

The dates and times of up to 8 alarm inputs or 4 power losses (failures) can be displayed.

#### Operation

- 1 Turn on the VCR and monitor.
- 2 Press the [MENU] button to display the main menu on the monitor.
- 3 Press the [SHIFT ▼] button to set the cursor on <OTHER>.
- 4 Press the [SET +/-] button to display the <OTHER> screen.
- 5 Press the [SHIFT ▼] button to set the cursor on the item you want to display (ALARM LIST or POWER LOSS LIST).
- 6 Press the [SET +/-] button to display the alarm or power loss list.
  - Alarm list: Up to 8 alarms are shown. When 9 or more alarms are input, the most recent data will replace the earliest data (beginning with the second item).
  - Power loss list: Up to 4 power losses are shown. When 5 or more power losses are input, the most recent data will replace the earliest data (beginning with the second item).
- 7 Press the [MENU] button three times to restore the normal screen.
  - Press the [MENU] button once to restore the <OTHER> screen and press once more to restore the main menu.

#### Resetting alarm input/power loss (failure) data

Press the [RESET/CANCEL] button on the alarm list screen to reset the alarm input data stored in memory. Press the [RESET/CANCEL] button on the power loss list screen to reset the power loss data stored in memory.

## 4 ON-SCREEN/MENU SWITCHES

### 4-6 Menu Switch Setting

You can customize the VCR's functions to suit the requirements of your application using the four menu switch setting screens accessible from the main menu screen.

- ON SCREEN/F. DISPLAY MODE
- VIDEO/VTR MODE
- SRI/EXT, ALARM/SENSOR MODE
- BUZZER/IN OUT

Each menu switch setting screen can be accessed independently from the main menu.

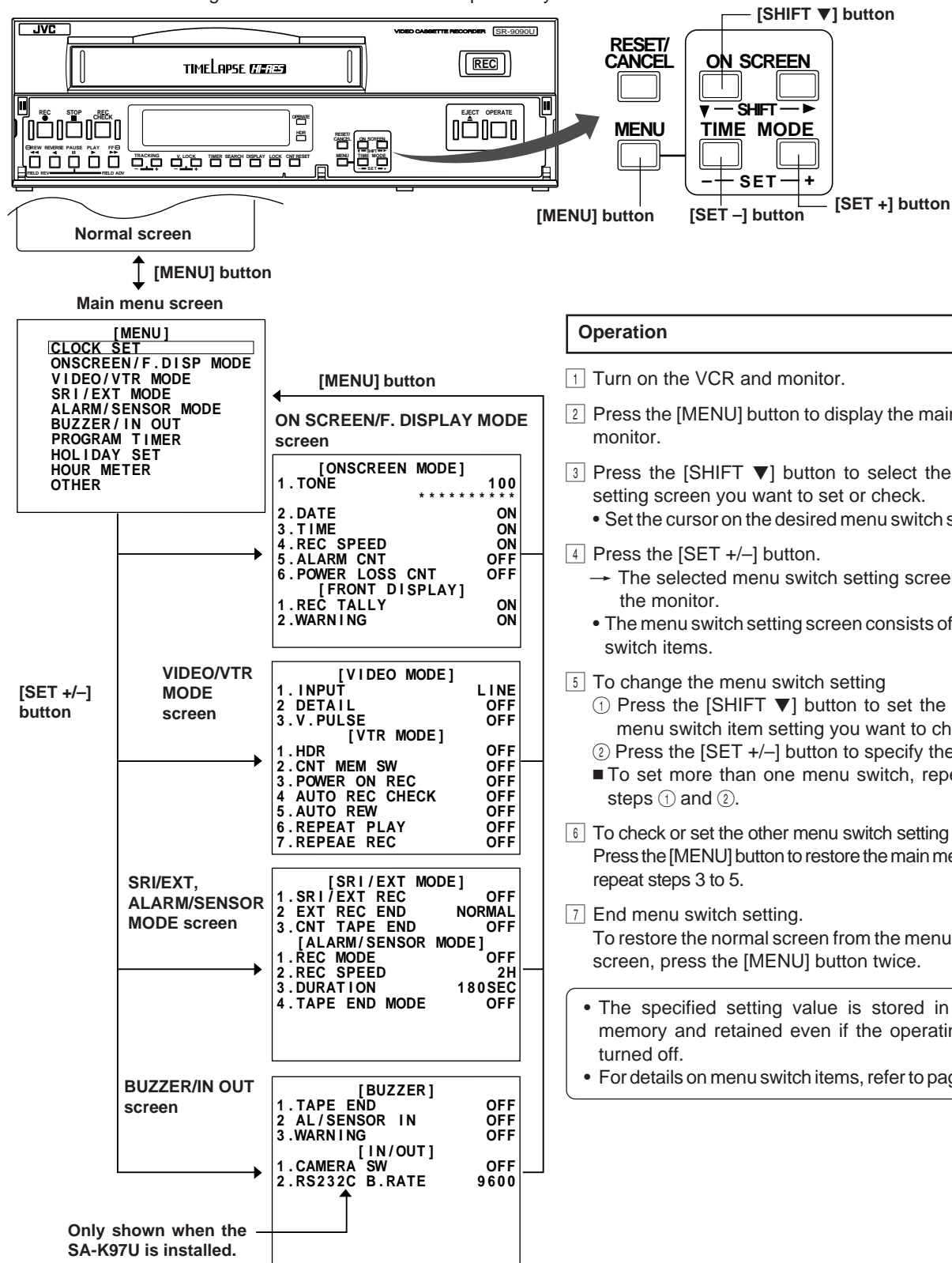

## 4 ON-SCREEN/MENU SWITCHES

### 4-7 Contents of Menu Switches

[ ]: Factory setting • The lower section in the items and set values columns shows what's on the VCR's display.

Screens	Items	Set values	Function
ON SCREEN MODE	TONE	0 30 70 [100]	The higher the numeric value, the brighter the display. The brightness is shown on the line under the setting value. 0 : ***** (black indication) 30 : *** 70 : ***** 100 : ***** (white indication)
	(VCR's display) <i>o5d 1</i>	<i>0</i> <i>30</i> <i>70</i> <i>100</i>	
	DATE	[ON] OFF	Sets whether or not the year, month and day are shown on screen. ON: Shown. OFF: Not shown.
	<i>o5d 2</i>	<i>on</i> <i>off</i>	
	TIME	[ON] OFF	Sets whether or not the time is shown. ON: Shown. OFF: Not shown.
	<i>o5d 3</i>	<i>on</i> <i>off</i>	
	REC SPEED	ON [OFF]	Sets whether or not the recording speed mode is shown on screen. ON: Shown. OFF: Not shown.
<i>o5d 4</i>	<i>on</i> <i>off</i>		
ALARM CNT	ON [OFF]	Sets whether or not the number of alarms is shown on screen. ON: Shown. OFF: Not shown.	
<i>o5d 5</i>	<i>on</i> <i>off</i>		
POWER LOSS CNT	[ON] OFF	Sets whether or not the number of power losses is shown on screen. ON: Shown. OFF: Not shown.	
<i>o5d 6</i>	<i>on</i> <i>off</i>		
F. DISP	REC TALLY	[ON] OFF	Sets whether or not the [REC] indicator lights in the Record mode. ON: Lights. OFF: Does not light .
	<i>Fd iP 1</i>	<i>on</i> <i>off</i>	
	WARNING	[ON] OFF	Sets whether or not a warning indication (error code display) is shown when a problem occurs. ON: Shown. OFF: Not shown.
<i>Fd iP 2</i>	<i>on</i> <i>off</i>		
VIDEO MODE	INPUT	[LINE] Y/C	Selects input video signals. LINE: Inputs composite video signals from the rear panel's [VIDEO IN] connector. Y/C: Inputs separate Y/C video signals from the rear panel's [Y/C IN] connector.
	<i>u id 1</i>	<i>L in</i> <i>Yc</i>	
	DETAIL	[OFF] ON	Selects the picture quality in the Play mode. OFF: Normal picture quality. ON: Enhanced detail reproduction. However, the S/N ratio is degraded.
<i>u id 2</i>	<i>off</i> <i>on</i>		

## 4 ON-SCREEN/MENU SWITCHES

### 4-7 Contents of Menu Switches

[ ]: Factory setting • The lower section in the items and set values columns shows what's on the VCR's display.

Screens	Items	Set values	Function
VIDEO MODE	V. PULSE	[OFF] ON	Sets whether or not the V. pulse is added during ordinary playback (2H and 6H modes). OFF: V. pulse is not added. Normally set to this position. ON: V. pulse is added. • When a camera synchronized with the power supply is switched with a switcher, the picture may be distorted at the switching point. In this case, set this switch to "ON". This locks the monitor, preventing the picture distortion at switching points (only in the 2/6H mode). • V. pulse is always added in the Still mode and Timelapse mode.
	(VCR's display) u id 3	oFF oN	
VTR MODE	HDR	[OFF] ON	Sets the mode during timelapse recording. OFF: Records in the normal timelapse mode (timelapse recording with the SP heads). ON: Records in the HDR timelapse mode (timelapse recording with the EP heads). Refer to page 28.
	u tr 1	oFF oN	
	CNT MEM SW	[OFF] ON	Sets whether or not the counter memory function is activated. OFF: The counter memory function is not activated. ON: The counter memory function is activated. When the tape reel counter value reaches 0000 in the FF/REW mode, the VCR enters the Stop mode automatically. * The counter memory function is not available during repeat recording/playback, auto REW, alarm search, alarm scan and date/time search.
	u tr 2	oFF oN	
	POWER ON REC	[OFF] ON	Enables or disables automatic external timer recording or automatic restart of recording after a power failure. OFF: External timer recording or automatic recording after power failure does not function regardless of whether power is supplied or not. ON: Recording starts automatically when power is turned on.
	u tr 3	oFF oN	
	AUTO REC CHECK	[OFF] ON	Sets whether or not Recording Check is automatically performed at the beginning of a tape in the Repeat Recording mode. OFF: Automatic recording check function is disabled. ON: Automatic recording check function is enabled.
u tr 4	oFF oN		
AUTO REW	[OFF] ON	Sets whether or not the tape is rewound automatically when the tape ends. OFF: The tape stops at the end. ON: The tape automatically rewinds and enters the Stop mode (auto REW).  * When the repeat recording/playback function is set to "ON", the repeat function has priority. * If the menu switch <TAPE END MODE> on the <ALARM/SENSOR MODE> screen is set to "STOP", the Stop mode is engaged when the tape ends even when there is an alarm or sensor recording. The tape does not rewind.	
u tr 5	oFF oN		
REPEAT PLAY	[OFF] ON	Enables or disables the repeat playback function. OFF: The repeat playback function is disabled. ON: When the tape ends, it is automatically rewound and played back again from the beginning.	
u tr 6	oFF oN		



## 4 ON-SCREEN/MENU SWITCHES

### 4-7 Contents of Menu Switches

[ ]: Factory setting • The lower section in the items and set values columns shows what's on the VCR's display.

Screens	Items	Set values	Function
VTR MODE	REPEAT REC	[OFF] ON	<p>Enables or disables the repeat recording function.</p> <p>OFF: The repeat recording function is disabled.</p> <p>ON: When the tape ends, it is automatically rewound and recording starts again from the beginning. When set to "ON", the [REPEAT] indication on the VCR's display lights.</p> <div style="border: 1px solid black; padding: 5px; margin-top: 10px;"> <p>* If the menu switch &lt;TAPE END MODE&gt; on the &lt;ALARM/SENSOR MODE&gt; screen is set to "STOP", the Stop mode is engaged when the tape ends even when there is an alarm or sensor recording. The repeat recording is not executed.</p> <p>* When this menu switch is set to "ON", externally activated recording is not executed.</p> </div>
	(VCR's display) uTr 7	oFF oN	
SRI/EXT MODE	SRI/EXT REC	[OFF] SERIES EXT	<p>Selects series recording or automatic recording with an external VCR activation signal.</p> <p>OFF: The series recording and automatic recording with an external signal functions are disabled.</p> <p>SERIES: The series recording function is enabled.</p> <p>EXT: The automatic recording function with an external signal is enabled.</p> <p>* When the menu switch &lt;REPEAT REC&gt; is set to "ON", externally activated recording is not executed.</p>
	Sr Et 1	oFF SEr Et	
	EXT REC END	[NORMAL] OPE OFF	<p>Selects the mode engaged when externally activated automatic recording ends.</p> <p>NORMAL: The Stop mode is engaged.</p> <p>OPE OFF: The Stop mode is engaged and the operating power mode is turned off.</p>
	Sr Et 2	noRm PoFF	
CNT TAPE END		[OFF] 500 1000 : 9500	<p>Outputs a tape end signal from the rear panel's [TAPE END OUT] terminal when the tape reaches the set tape reel counter value during recording. During series recording, a series recording signal is output to a connected VCR for continuous recording.</p> <p>OFF: The counter end output function is disabled.</p> <p>500: A tape end signal is output when the set tape reel counter value is reached during recording. A buzzer sounds when the menu switch &lt;END BUZ&gt; on the &lt;BUZZER/IN OUT&gt; is set to "ON". For more information on the relationship between the tape reel counter value and the tape remaining time, refer to page 64.</p>
	Sr Et 3	oFF 500 : 9500	
ALARM/SENSOR MODE	REC MODE	[OFF] ALARM SENSOR ALL	<p>Selects the alarm recording or sensor recording function.</p> <ul style="list-style-type: none"> <li>• Alarm recording: When an alarm signal is input to the rear panel's [ALARM IN] terminal during recording, the mode switches to the 2H (SP) or 6H (EP) recording mode for realtime recording of the alarm event.</li> <li>• Sensor recording: When an alarm signal is input to the rear panel's [ALARM IN] terminal in the Stop mode (Stop mode, Timer Recording Standby or Operating Off mode), recording starts in the 2H (SP) or 6H (EP) mode.</li> </ul> <p>OFF: Alarm or sensor recording is not executed.</p> <p>ALARM: Alarm recording is executed.</p> <p>SENSOR: Sensor recording is executed.</p> <p>ALL: Both alarm and sensor recording are executed.</p>
	AL SE 1	oFF ALAr SEnS ALL	
REC SPEED		[2H] 6H	<p>Selects the recording mode for alarm or sensor recording.</p> <p>2H: Records in the 2H (SP) mode.</p> <p>6H: Records in the 6H (EP) mode.</p>
	AL SE 2	2H 6H	

## 4 ON-SCREEN/MENU SWITCHES

### 4-7 Contents of Menu Switches

[ ]: Factory setting • The lower section in the items and set values columns shows what's on the VCR's display.

Screens	Items	Set values	Function
ALARM/ SENSOR MODE	DURATION	5 SEC 10 SEC 15 SEC 30 SEC 60 SEC 120 SEC [180 SEC] TAPE END MANUAL	Selects the recording duration for alarm or sensor recording. 5 — 180 SEC: Alarm or sensor recording is performed for the specified time (5 sec. to 180 sec.) TAPE END: Alarm or sensor recording continues to the end of the tape. MANUAL: Alarm or sensor recording continues for as long as alarm signals are input. Set to this position when specifying the alarm recording time with a switcher. *To ensure accurate alarm search and alarm scan operation, be sure to set the recording time to 5 seconds or more.
	(VCR's display) AL SE 3	5 : 180 tPEn nRnU	
	TAPE END MODE	[OFF] STOP	Selects whether or not the Stop mode is forcibly engaged when the tape ends even if there is an alarm or sensor recording. OFF: The forced Stop mode is not engaged. • When the tape ends, the mode set with the menu switch <AUTO REW> or <REPEAT REC> on the <VTR MODE> screen is engaged. STOP: The Forced Stop mode is engaged.
	AL SE 4	oFF StoP	
BUZZER	TAPE END	[OFF] ON	Sets whether or not the buzzer sounds when the tape ends in the Record mode. OFF: The buzzer does not sound. ON: The buzzer sounds when the tape ends during recording. Also, the buzzer sounds when the tape reel counter value set with the menu switch <CNT TAPE END> on the SRI/EXT MODE screen is reached. When the mode is changed by pressing the [REW] button, [EJECT] button or [OPERATE] button, the buzzer sound stops.
	BU 22 1	oFF on	
	AL/SENSOR IN	[OFF] ON	Selects whether or not the buzzer sounds during alarm or sensor recording. OFF: The buzzer does not sound. ON: The buzzer sounds.
	BU 22 2	oFF on	
	WARNING	[OFF] ON	Sets whether or not the buzzer sounds when a warning occurs. OFF: The buzzer does not sound. ON: The buzzer sounds. When the warning is released, the buzzer sound stops.
	BU 22 3	oFF on	
IN/OUT	CAMERA SW	[OFF] 1 FIELD 2 FIELD	Sets the camera switching signal output interval. OFF: No camera switching signal is output. 1 FIELD: Set to this position to switch cameras every 1 field. 2 FIELD: Set to this position to switch cameras every two fields (1 frame).
	IO 1	oFF 1Frd 2Frd	
	RS-232C B. RATE	This screen is shown only when the optional SA-K97U RS-232C board is installed.	
		600 1200 2400 4800 [9600]	Selects the RS-232C data transfer rate (600 bps, 1200 bps, 2400 bps, 4800 bps and 9600 bps).
	IO 3	600 : 9600	

# 5 PREPARATION

## 5-1 Cassette Loading/Unloading

### Loading

Insert the cassette with its label side facing you.

Gently push the center of the cassette until the machine starts automatic loading.

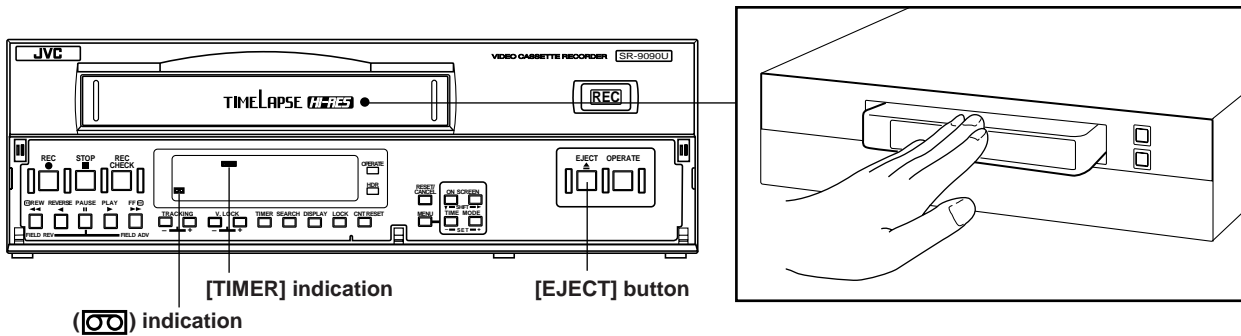

#### Notes:

- To avoid damage or injury, do not insert your hand or other foreign objects into the cassette loading slot.
- For best results, use a T-120 tape.

#### Auto operate on

When a cassette is loaded, the operating mode automatically turns on and the (  ) cassette indication appears.

#### Auto play

When a cassette with no erasure prevention tab is loaded, playback starts automatically.

### Unloading

#### ■ Press the [EJECT] button.

→ The cassette is ejected.

- The tape reel counter is reset to "0000".

If the operating mode is not on when the [EJECT] button is pressed, operating mode is automatically switched on and the cassette is ejected. Once the cassette is unloaded, the operating mode turns off again automatically.

If the Timer Recording Standby mode is engaged (TIMER indication is shown on the display), the cassette will not be ejected when the [EJECT] button is pressed.

To unload the cassette, press the [TIMER] button to release the Timer Recording Standby mode, then press the [EJECT] button.

## 5 PREPARATION

### 5-2 Recording/Playback Speed Mode Selection

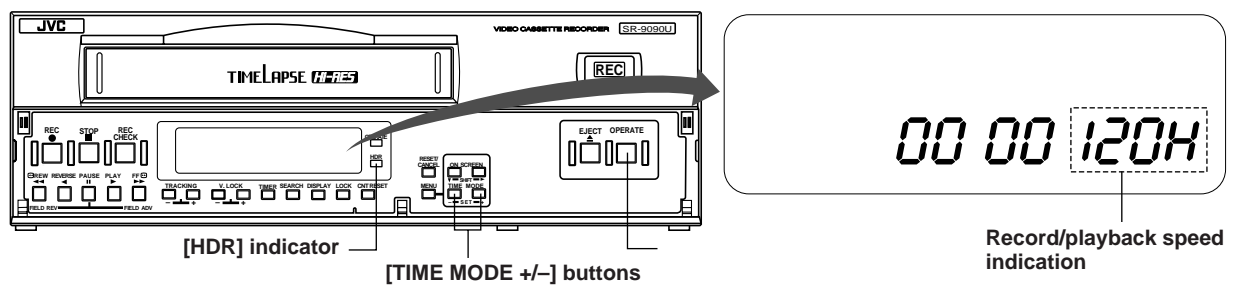

- 1 Press the [OPERATE] button to turn the operating mode on.
- 2 Select whether or not the HDR mode is engaged with the <HDR> menu switch on the <VTR MODE> screen. When the During HDR recording or HDR playback, the [HDR] indicator lights.
- 3 Select the Record or Playback speed with the [TIME MODE +/-] button. Refer to the table below.  
The selected recording or playback speed mode is shown on the display.
  - Available modes differ depending on whether HDR is ON or OFF.

Display	Recording/playback interval (sec.)		Mode	Available recording time (hours)				Audio recording
	HDR OFF	HDR ON		T-30	T-60	T-90	T-120	
2H	—	—	Standard (SP)	0.5	1	1.5	2	Possible
6H	—	—	3x (EP)	1.5	3	4.5	6	Possible
24H	0.2	0.08	24-hour timelapse	6	12	18	24	Impossible
48H	0.4	0.15	48-hour timelapse	12	24	36	48	Impossible
72H	0.6	0.2	72-hour timelapse	18	36	54	72	Impossible
120H	1	0.35	120-hour timelapse	30	60	90	120	Impossible
168H	1.4	0.5	168-hour timelapse	48	96	144	168	Impossible
240H	2	0.7	240-hour timelapse	60	120	180	240	Impossible
480H	4	1.35	480-hour timelapse	120	240	360	480	Impossible
960H	6	2.7	960-hour timelapse	240	480	720	960	Impossible

- HDR ON/OFF can be activated in any recording mode except the 2H/6H mode.
- Available recording time may vary depending on the type of cassette used.

- For best results, use a T-120 tape.
- Replace the cassette at least once every 15 days when using the 2H - 168H modes. In the 240 - 960H modes, replace the cassette with a new one at the completion of recording.

#### High-Density Recording

HDR is performed with the EP heads. When HDR is set to "OFF", recording is performed with the SP heads. In the HDR mode, the interval between frames (fields) is reduced by about a third, allowing three times as many frames to be recorded as in the ordinary timelapse mode. This does not affect the actual recording time of the tape (the recording time is the same as it would be if recorded in the normal (SP) Timelapse mode). The quality of the picture recorded in the HDR mode is inferior to that in ordinary timelapse recording (equivalent to the EP mode).

# 6 RECORDING

## 6-1 Switch Setting During Recording

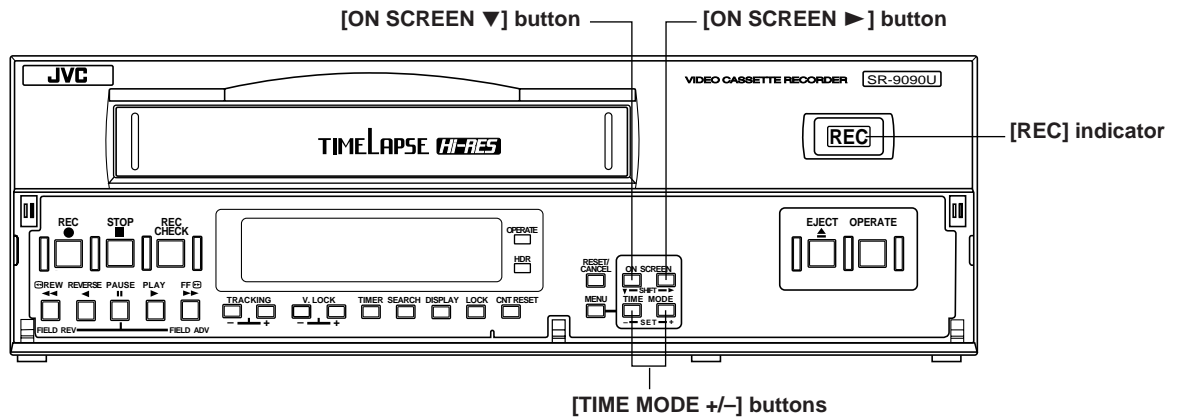

### Connection

Connect the input and output connectors on the rear panel correctly. Refer to "CONNECTIONS" on pages 14 to 16.

### Menu switch settings

Set menu switches as required.

#### ■ INPUT

- Select LINE (composite) or Y/C video signal input.

#### ■ ON SCREEN/F. DISPLAY MODE

- Select the brightness and ON/OFF for each indication (date, time and recording speed, etc). During recording, the selected on-screen data is recorded together with video signals. If you do not want to display or record a specific item, set it to "OFF".
- <REC TALLY> setting  
Set whether or not the [REC] indicator lights in the Record mode.

#### ■ VTR MODE

- HDR  
Set to "ON" to record in the High-Density Recording mode during timelapse recording.
- POWER ON REC  
Set to "ON" for external timer recording or automatic restart of recording after a power failure. For details, refer to "6-9 How to Restore Recording After Power Failure" and "6-10 External Timer Recording" on page 45.
- AUTO REW  
Select the mode engaged when the tape ends.  
"OFF": The Stop mode is engaged.  
"ON": The tape automatically rewinds to the beginning.

When the <REPEAT REC> menu switch is set to "ON", repeat recording takes place regardless of the setting of this switch.

#### • REPEAT REC

Set to "ON" to perform repeat recording. For details, refer to "6-7 Repeat Recording" on page 43.

#### • AUTO REC CHECK

Set to "ON" to perform Recording Check automatically at the beginning of a tape in the Repeat Recording mode.

#### ■ SRI/EXT MODE

##### • SRI/EXT REC

- Set to "SERIES" to perform series recording. For details, refer to "6-6 Series Recording" on page 41.
- Set to "EXT" to execute automatic recording when activated by an external signal. For details, refer to "6-8 Recording with External VCR Activation Signal" on page 44.

#### ■ ALARM/SENSOR MODE

##### • REC MODE

- For alarm recording, set to "ALARM" or "ALL". For details, refer to "6-4 Alarm Recording" on page 38.
- For sensor recording, set to "SENSOR" or "ALL". For details, refer to "6-5 Sensor Recording" on page 40.

#### ■ BUZZER

##### • TAPE END

Set to "ON" if you want the buzzer to sound when the tape ends during recording.

#### ■ IN/OUT

##### • CAMERA SW

Set the camera switching timing signal output to an external sequential switcher during recording.

- To switch cameras every 1 field or 1 frame, set this menu switch to "1 FIELD" or "2 FIELD".

### Recording tape

Use an HG (high grade) tape for recording with this unit (a JVC cassette is recommended). Before recording, perform a test recording to check the picture quality. Tapes recorded on this VCR cannot be played back on normal VHS VCRs. To avoid inadvertently trying to play back tapes recorded in this unit on standard VHS VCRs, label the cassette appropriately to distinguish it from tapes recorded in the normal VHS mode.

# 6 RECORDING

## 6-2 Recording Basic Operation

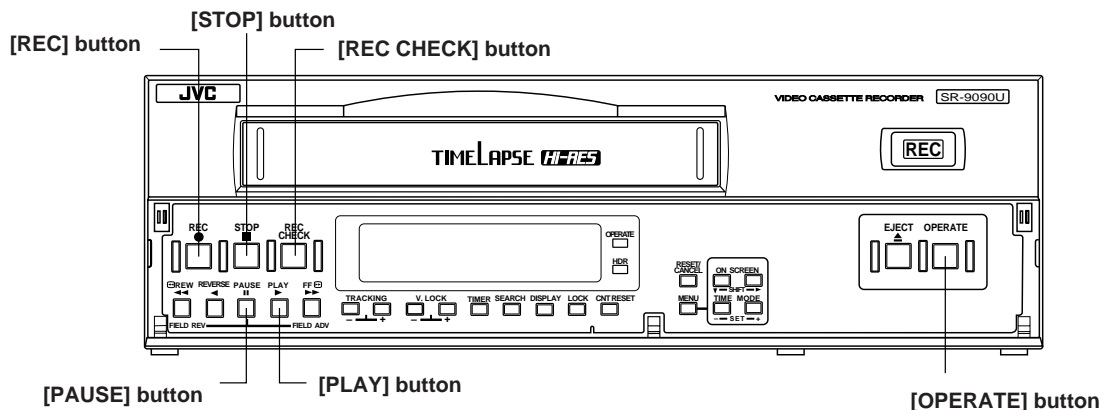

- 1 Press the [OPERATE] button to turn the operating mode on.  
→ The [OPERATE] indicator lights.
- 2 Select the recording speed mode with the [TIME MODE +/-] button.  
For details, refer to "5-2 Recording/Playback Speed Mode Selection" on page 28.
- 3 Select the on-screen display position with the [ON SCREEN ▼/▶] button.
- 4 Insert a cassette with safety tab in place.  
→ The ( ) cassette indicator lights on the display.  
\* If a cassette is loaded when the operating mode is off, the operating mode is switched on automatically (auto operate on function).
- 5 Press the [REC] button to start recording.  
→ The recording indicator lights on the display, showing that the Record mode is engaged.  
\* No sound is recorded during Timelapse Recording.

### To stop recording temporarily

- 6 Press the [PAUSE] button.  
→ The record-pause indicator is shown on the display and the Pause mode is engaged.

\* If the VCR remains in the Record-Pause mode for about 3 minutes, the head drum stops rotating to protect the tape. Although the Record-Pause mode remains engaged, there may be some distortion in the picture at the recording transition when you start recording again.

### To start recording again

- 7 Press the [PLAY] button.  
→ The record-pause indicator on the display goes out and the Recording mode is engaged.

### To stop recording

- 8 Press the [STOP] button.  
→ The tape stops and the Stop mode is engaged.

### To check the recording

- To check recording in the Timelapse mode, the recording duration must be equivalent to at least 8 seconds at 2H(SP) or 6H(EP) speed. Recording check cannot be performed correctly if the recording duration is too short. (Example : In the 960-hour normal timelapse mode, the recording duration should be 64 minutes or more.)
- During recording check, the audio signal is not output.

- Press the [REC CHECK] button during recording.  
→ The tape is automatically played back in reverse for about 5 seconds, then the Play mode is engaged to allow you to check recording. After the sequence has played back, the recording mode is automatically re-engaged at the point where the recording was interrupted.
- During playback in the Recording Check mode, check the picture to ensure that the recording is satisfactory. If the signals are not recorded properly, the built-in head cleaner cleans the heads and recording continues. In this case, the error code "E-09" is shown on the display for about 10 seconds.

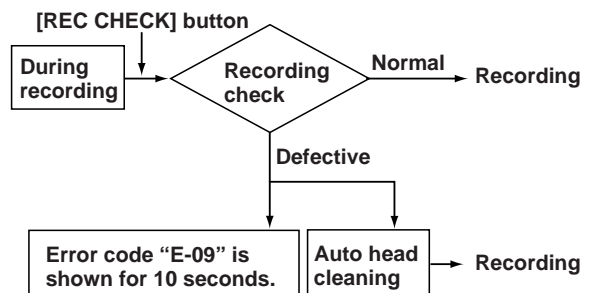

If the recording speed is as shown below, the VCR cleans the heads automatically and continues recording whenever continuous 24-hour recording is performed.  
 Normal timelapse mode: 72H or more  
 HDR timelapse mode: 240H or more  
 Images recorded during the cleaning period may be unstable due to the interference with the servo control. This is not a malfunction.

#### Note:

- When a tape recorded in this unit is played back on another VCR (except another SR-9090U), noise may appear in the picture.

## 6 RECORDING

### 6-3 Timer Recording

This unit is provided with 2 different setting screens for timer recording program; one allows you to specify the day of week, the other allows you to specify a date (a holiday, for example). You can select the desired setting screen from the main menu screen.

- Program timer setting: Day-of-the-week (Sun. to Sat.) timer recording program and daily timer recording program are available (for up to 8 programs).
- Holiday setting: Timer recording can be programmed for a specified date.
  - \* The holiday setting has priority over the program timer setting.

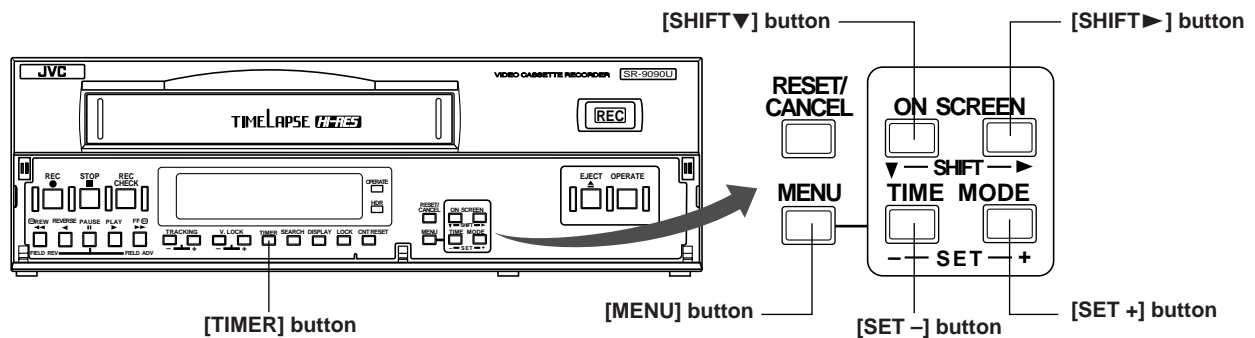

#### Notes:

- Timer programming is not possible if the date and time are not set. If you select program timer or holiday setting from the main menu when the date and time have not been set, the clock setting screen opens. Set the date and time.
- Do not try to program the regular timer or holiday timer when the Timer Record mode is engaged. To do so, you must first release the Timer Record mode by pressing the [TIMER] button.

#### Preparation

- Make sure all equipment is connected correctly.
- Check the current time.
- Load a cassette with safety tab in place.

If a cassette is loaded when the operating mode is off, the operating mode is switched on automatically (auto operate on function).

### Timer Recording Program Setting

- Timer recording programming for the specified day of the week

(Example)

HDR is performed in the 24-hour recording speed mode from 8:00 a.m. to 5:00 p.m. on Saturday.

#### Main menu screen

[MENU]
CLOCK SET
ONSCREEN/F. DISP MODE
VIDEO/VTR MODE
SRT/EXT MODE
ALARM/SENSOR MODE
BUZZER/IN OUT
PROGRAM TIMER
HOLIDAY SET
HOURLY METER
OTHER

#### VIDEO/VTR MODE screen

[VIDEO MODE]	
1. INPUT	LINE
2. DETAIL	OFF
3. V. PULSE	OFF
[VTR MODE]	
HDR 1. HDR	ON
2. CNT MEM SW	OFF
3. POWER ON REC	OFF
4. AUTO REC CHECK	OFF
5. AUTO REW	OFF
6. REPEAT PLAY	OFF
7. REPEAE REC	OFF

- 1 Turn on the VCR and monitor and engage the Stop mode.
- 2 Press the [MENU] button.
  - The main menu is shown on the monitor.
- 3 Select the HDR mode.
  - ① Press the [SHIFT ▼] button to move the cursor to <VIDEO/VTR MODE> on the main menu. Then press the [SET +/-] button.
    - The <VIDEO/VTR MODE> menu is shown on the monitor.
  - ② Press the [SHIFT ▼] button to put the cursor on <HDR>.
  - ③ Press the [SET +/-] button to set <HDR> to "ON".
- 4 Press the [MENU] button to restore the main menu screen.

## 6 RECORDING

### 6-3 Timer Recording

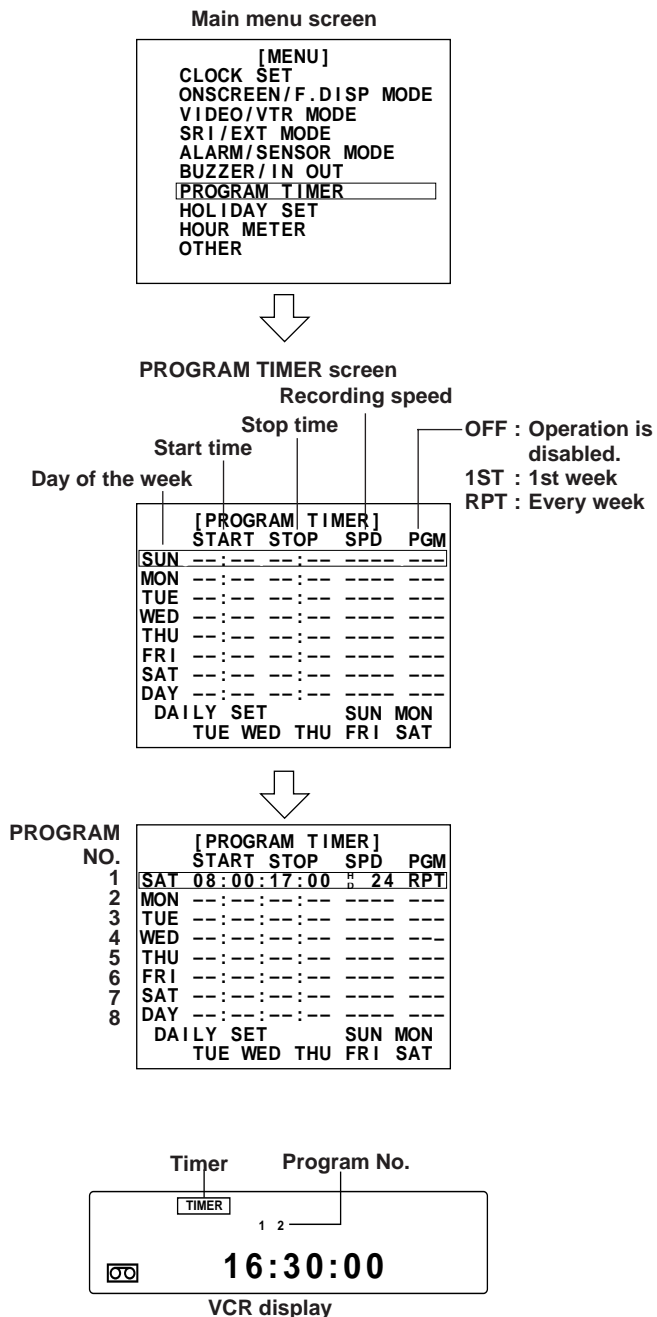

- 5 Press the [SHIFT ▼] button to select <PROGRAM TIMER> in the main menu and press the [SET +/-] button.  
→The <PROGRAM TIMER> menu is shown on the monitor and "SUN" blinks.
- 6 Set the day of the week (SAT).  
Press the [SET +/-] button to set the day of the week to "SAT".
- 7 Set the hour for the start time (8).  
Press the [SHIFT ►] button so that "hour" for "START" blinks. Press the [SET +/-] button to set the hour of the start time to "8".
- 8 Set the minute for the start time (00).  
Press the [SHIFT ►] button so that "minute" for "START" blinks. Press the [SET +/-] button to set the minute of the start time to "00".
- 9 In the same way, set the hour (17) and minute (00) for the stop time.

\* When the stop time is earlier than the start time or the same as the start time, "T" is added to the beginning of the stop time, showing that the stop time is for the next day.

- 10 Set the recording speed mode (H/D 24).  
Press the [SHIFT ►] button so that "SPD" blinks and press the [SET +/-] button to set the recording speed to (H/D 24).  
\* When the HDR mode is selected, H/D is shown for "SPD".
- 11 Set the program item.  
Press the [SHIFT ►] button so that "PGM" blinks and set the program item with the [SET +/-] button.  
1ST: Timer recording is executed only once on the most recent specified day of the week (Saturday).  
RPT: Timer recording is executed on the specified day of the week (Saturday) every week.  
OFF: Programmed timer recording is not executed.  
■ To program timer recording at another time or day, press the [SHIFT ▼] button so that the next setting line blinks and repeat steps 6 to 11.  
\* If changing the HDR mode, do so before programming the timer again.

- 12 End timer program setting.  
• Press the [MENU] button twice.  
→The normal screen is restored.
- 13 Press the [TIMER] button.  
→The [TIMER] indication and effective timer-recording programmed numbers light on the display and the operating mode is automatically turned off to engage the Timer-Recording Standby mode.



# 6 RECORDING

## 6-3 Timer Recording

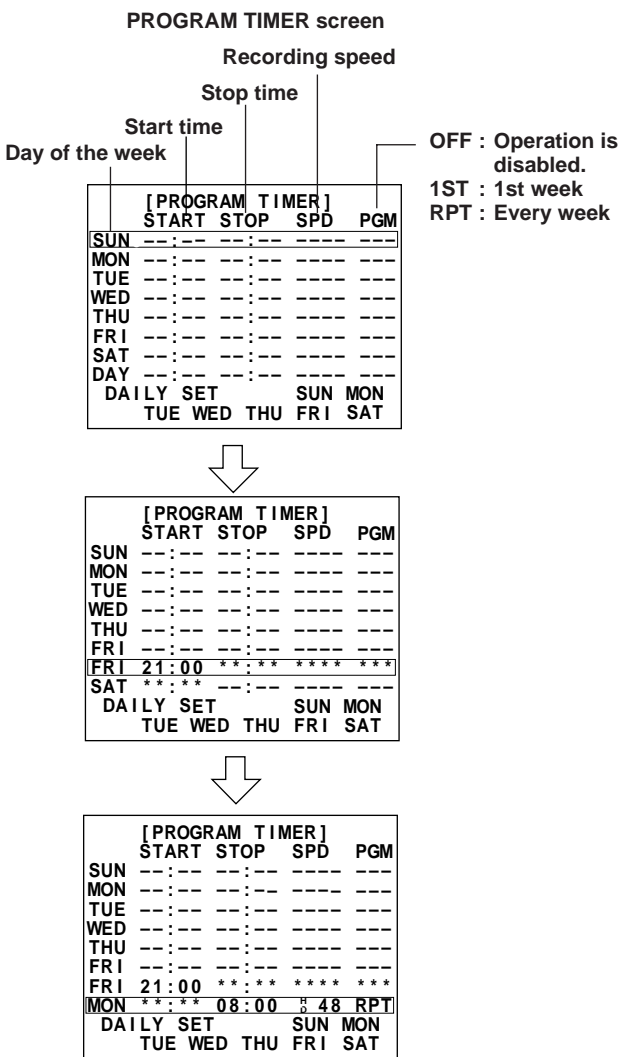
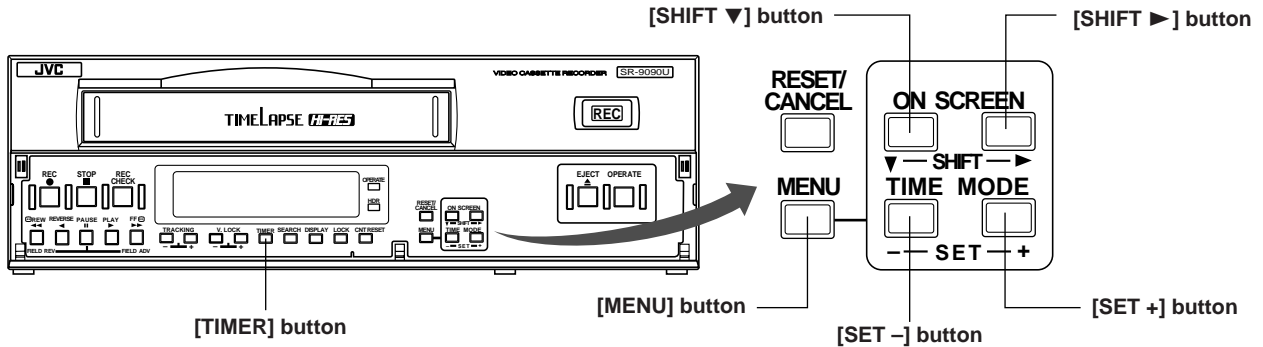

### ■ Programming timer recording for more than 24 hours

(Example)

HDR is performed with the 48-hour recording speed from 9:00 p.m. on every Friday to 8:00 a.m. on every Monday.

- Follow steps 1 to 5 in "Timer Recording Program Setting" on pages 31 and 32.
- Press the [SHIFT ▼] button so that the 7th line "SAT" blinks on the <PROGRAM TIMER>. Programs lasting for more than 24 hours can only be set on the seventh line.
- Press the [SET +/-] button to set the day of the week to "FRI" and press the [SHIFT ►] button.  
→ "Hour" for the start time blinks.
- Press the [SET +/-] button to set the hour of the start time to "21" and press the [SHIFT ►] button.  
→ "Minute" for the start time blinks.
- Press the [SET +/-] button to set the minute of the start time to "00" and press the [SHIFT ►] button.  
→ "Hour" for the stop time blinks.
- Press the [SET +/-] button to set the hour of the stop time to "\*\*\*".  
→ "\*\*\*.\*\* \*\*\*\* \*\*" is shown for the items after "STOP", the "DAY" on the 8th line changes to the next day of the week (SAT) automatically and "\*\*\*.\*\*" is shown for "START".
- Press the [SHIFT ▼] button so that the day of the week on the 8th line blinks.
- Press the [SET +/-] button to set the day of the week to "MON" and press the [SHIFT ►] button three times.  
→ "Hour" for the stop time blinks.
- Press the [SET +/-] button to set the hour of the stop time to "8".
- In the same way, press the [SHIFT ►] button and [SET +/-] button to set the minute of the stop time to "00", the recording speed to "H/D 48" and "PGM" to "RPT".
- End timer program setting.  
Press the [MENU] button twice.  
→ The normal screen is restored.
- Press the [TIMER] button.  
→ The [TIMER] indication and program number "7" light on the display and the operating mode is automatically turned off to engage the Timer-Recording Standby mode.

## 6 RECORDING

### 6-3 Timer Recording

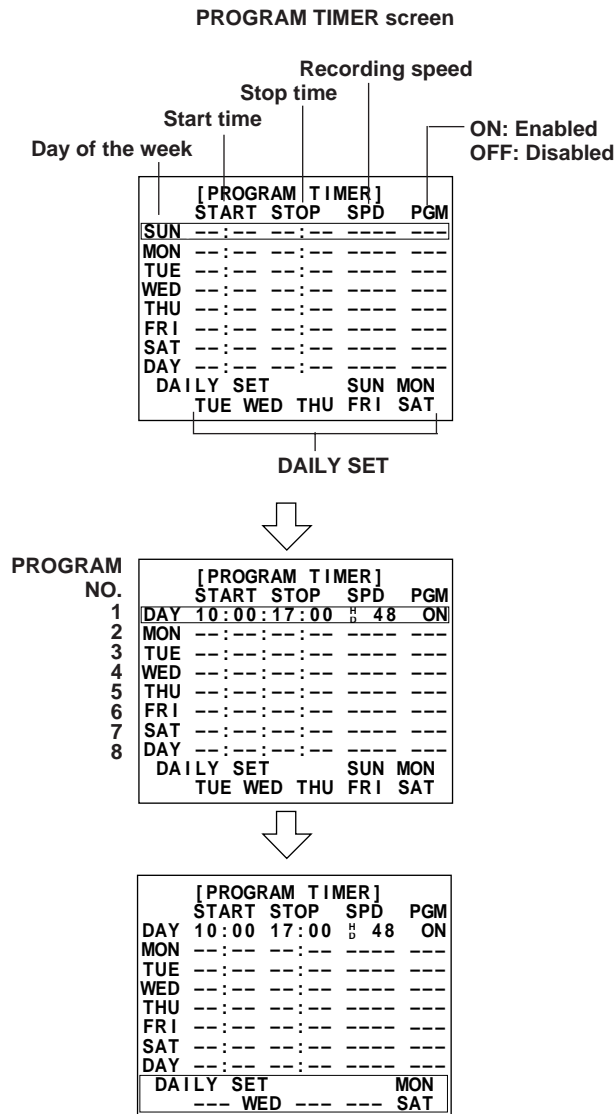

- Programming timer recording for more than one day (every day)  
This programming is to timer-record at the same time on specified days of the week.

*(Example)*  
HDR is performed in the 48-hour mode from 10:00 a.m. to 5:00 p.m. on Monday, Wednesday and Saturday.

- 1 Repeat steps 1 to 5 in "Timer Recording Program Setting" on pages 31 and 32.
- 2 Set the day of the week on <PROGRAM TIMER> to "DAY" with the [SET +/-] button.
- 3 Press the [SHIFT ►] button so that the "hour" for the start time blinks and set "hour" to "10" with the [SET +/-] button.
- 4 Press the [SHIFT ►] button so that the "minute" for the start time blinks and set "minute" to "00" with the [SET +/-] button.
- 5 Press the [SHIFT ►] button and [SET +/-] button to set the hour of the stop time to "17", the minute of the stop time to "00", the recording speed to "H/D48" and "PGM" to "ON".
- 6 Set the days of the week when timer recording is to be executed (Monday, Wednesday, Saturday). Set the days with "DAILY SET" at the lower section of the screen.
  - Press the [SHIFT ▼] button so that "SUN" in the lowest line blinks.
- 7 Press the [SET +/-] button to set "SUN" to "--".
- 8 Press the [SHIFT ►] button to select the day of the week and set the operating day of the week with the [SET +/-] button. Set the items for "Tuesday", "Thursday" and "Friday" to "--".
  - Timer recording will take place on the days of the week shown on the display. Timer recording will not take place on days of the week indicated by "--".
- 9 End timer program setting. Press the [MENU] button twice.
  - The normal screen is restored.
- 10 Press the [TIMER] button.
  - The [TIMER] indication and active timer program numbers light on the display and the operating mode is automatically turned off to engage the Timer-Recording Standby mode.

## 6 RECORDING

### 6-3 Timer Recording

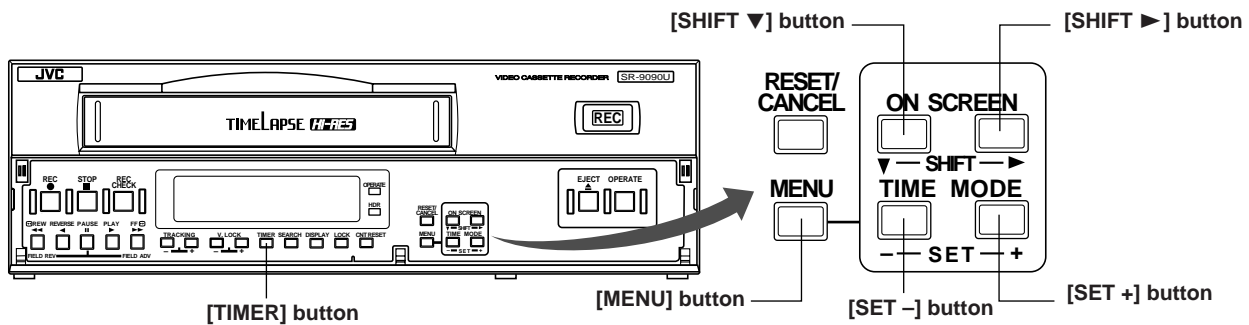

#### Holiday Timer Recording Setting

This lets you preset the VCR to record on specified dates (such as holidays) at any time over a period of a year. Up to 16 dates can be set. When holiday settings and program settings overlap, holiday setting is given priority

(Example)

Recording is performed in the 960-hour normal timelapse mode from 0:00 a.m. to 0:00 a.m. the next day.

Main menu screen

[MENU]
CLOCK SET
ONSCREEN/F.DISP MODE
VIDEO/VTR MODE
SR1/EXT MODE
ALARM/SENSOR MODE
BUZZER/IN OUT
PROGRAM/TIMER
<b>HOLIDAY SET</b>
HOURLY METER
OTHER



HOLIDAY SET screen

[HOLIDAY SET]			
START	STOP	SPD	PGM
1: ----	2: ----		
3: ----	4: ----		
5: ----	6: ----		
7: ----	8: ----		
9: ----	10: ----		
11: ----	12: ----		
13: ----	14: ----		
15: ----	16: ----		



[HOLIDAY SET]			
START	STOP	SPD	PGM
00:00	T00:00	960	ON
1: 1-15	2: 9-15		
3: 2-11	4: 9-23		
5: 3-21	6: 10-10		
7: 4-29	8: 11-03		
9: 5-01	10: 11-23		
11: 5-03	12: 12-23		
13: 5-05	14: ----		
15: 8-15	16: ----		

• When "PGM" is set to "OFF", the setting is disabled and holiday timer recording is not executed.

- 1 Press the [MENU] button to show the main menu on the monitor.
- 2 Set HDR to "OFF".
  - ① Press the [SHIFT ▼] button to set the cursor on the main menu's <VIDEO/VTR MODE>. Then press the [SET +/-] button.
  - ② Set <HDR> on <VIDEO/VTR MODE> to "OFF" with the [SET +/-] button.
  - ③ Press the [MENU] button to restore the main menu screen.
- 3 Call the <HOLIDAY SET> screen.
  - Press the [SHIFT ▼] button to select <HOLIDAY SET> in the main menu and press the [SET +/-] button.
- 4 Press the [SET +/-] button to set the hour of the start time to "0" and press the [SHIFT ►] button.
  - "Minute" for the start time blinks.
- 5 Press the [SET +/-] button to set the minute of the start time to "00" and press the [SHIFT ►] button.
  - "Hour" for the stop time blinks.
- 6 Press the [SET +/-] button to set the hour of the stop time to "00" and press the [SHIFT ►] button.
  - "T" is shown at the beginning of the stop time.
  - \* When the stop time is earlier than the start time or the same as the start time, the stop time is assumed to be the next day and "T" is added to the beginning of the stop time.
- 7 Press the [SHIFT ►] button and [SET +/-] button to set the minute of the stop time to "00", the recording speed to "960" and "PGM" to "ON".
- 8 Set the day.
  - Press the [SHIFT ►] button or [SHIFT ▼] button to select the line and enter the day for timer recording with the [SET +/-] button.
- 9 End holiday timer recording setting.
  - Press the [MENU] button twice.
  - The normal screen is restored.
- 10 Press the [TIMER] button.
  - The **TIMER** indication lights on the display and the operating mode is automatically turned off to engage the Timer-Recording Standby mode.
  - \* The timer program numbers are not shown on the display.

## 6 RECORDING

### 6-3 Timer Recording

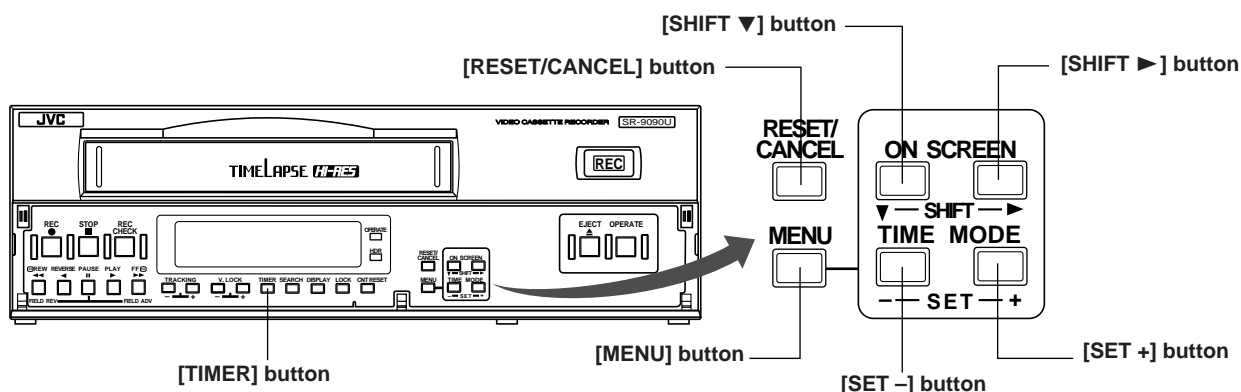

#### Canceling/Changing Timer Recording Program

##### To stop timer programming before finishing

- 1 Press the [RESET/CANCEL] button.  
→ The program being set is canceled.
- 2 Press the [MENU] button twice.  
→ The normal screen mode is restored.

##### To cancel preset timer programs

- 1 Press the [TIMER] button so that the **TIMER** indication goes out on the display.
- 2 Turn on the VCR and monitor.
- 3 Press the [MENU] button to show the main menu screen and press the [SHIFT ▼] button to select <PROGRAM TIMER> or <HOLIDAY SET>. Then, press the [SET +/-] button.  
→ The <PROGRAM TIMER> or <HOLIDAY SET> menu is shown on the monitor.
- 4 Press the [SHIFT ▼] button or [SHIFT ►] button to move the cursor to the program you want to cancel.
- 5 Press the [RESET/CANCEL] button.  
→ The specified timer recording program is canceled.
- 6 Press the [MENU] button twice.  
→ The normal screen is restored.

#### To modify timer programs

- 1 Press the [TIMER] button so that the **TIMER** indication goes out on the display.
- 2 Turn on the VCR and monitor
- 3 Press the [MENU] button to show the main menu screen and press the [SHIFT ▼] button to select <PROGRAM TIMER> or <HOLIDAY SET>. Then, press the [SET +/-] button.  
→ The <PROGRAM TIMER> or <HOLIDAY SET> menu is shown on the monitor.
- 4 Press the [SHIFT ▼] button or [SHIFT ►] button so that the section you want to change blinks.
- 5 Press the [SET +/-] button to change the value.
- 6 Press the [MENU] button twice.  
→ The normal screen is restored.

#### To use the VCR when the Timer-Recording Standby mode is engaged

- Press the [TIMER] button so that the **TIMER** indication goes out. After using the VCR, press the [TIMER] button again to engage the Timer-Recording Standby mode. The **TIMER** indication will light.
- When all timer recording programs are completed, the **TIMER** indication goes out.

### 6-3 Timer Recording

#### Notes on Timer Recording

- If you make a mistake when programming or no program is set and the [TIMER] button is pressed, the [TIMER] indication blinks for about 10 seconds and a warning buzzer sounds if <WARNING> in the <BUZZER> menu is set to "ON".  
↓  
Perform programming for timer recording
- **If programmed data overlap**  
When the [TIMER] button is pressed, the Timer-Recording Standby mode is engaged and the [OVERLAP] indication blinks for about 10 seconds, then lights.  
(However, if program timer settings and holiday timer settings overlap, the [OVERLAP] indication is not shown. In this case, the holiday timer setting has priority. The [OVERLAP] indication is not shown when a daily timer recording program overlaps with another program (even during program timer setting). The program with the earlier start time has priority.)  
↓  
Check the program contents.  
(With program timer settings, the program with the earlier program time has priority.)
- When more than one timer recording is programmed  
↓
  - The preset programs are executed consecutively beginning with the program with the earliest start time. The number of the program being executed blinks.
  - \* Program numbers are not displayed for holiday timer recording programs.
- When the timer recording mode is engaged after the start time has passed ...  
When a power failure occurs within the set times and power is restored ...  
↓
  - Timer recording starts within the set times.
  - \* If holiday timer and program timer settings overlap, the holiday timer setting has priority and starts.
  - \* When program timer settings overlap, the program with the lower program number has priority and starts.
- When the timer recording settings are changed during timer recording  
↓  
Changing the settings on the program timer setting screen or holiday timer setting screen during timer recording will have no effect. To change the settings, you must disengage the timer recording mode.

- **During timer recording**

The [PAUSE] or [STOP] button has no effect.



Operation after pressing the [TIMER] button.

- **Timer recording**

The operating mode is turned on about 20 seconds before recording starts and the VCR pauses. Recording starts about 2 seconds before the actual programmed start time.

- **If no cassette is loaded**

The [TIMER] and [⏏] indications blink and a warning buzzer sounds if <WARNING> in the <BUZZER> menu is set to "ON".



Load a cassette with safety tab. Cassettes with no tab are ejected.

- When the tape ends during timer recording



The cassette tape is ejected.

When a cassette with safety tab is loaded, the timer recording re-starts.

\* However, if timer recording is executed in the Repeat Record mode, the cassette tape is not ejected at the tape end and repeat recording continues.

## 6 RECORDING

### 6-4 Alarm Recording

Alarm recording functions during timelapse recording. When an alarm signal is input to the rear panel's ALARM IN terminal, an index code is recorded on the tape and the VCR automatically switches to the 2H (SP) or 6H (EP) mode for realtime recording of the alarm situation. Normal timelapse recording is restored after the preset alarm recording duration has passed.

\* Alarm recording will not start from the Pause mode.

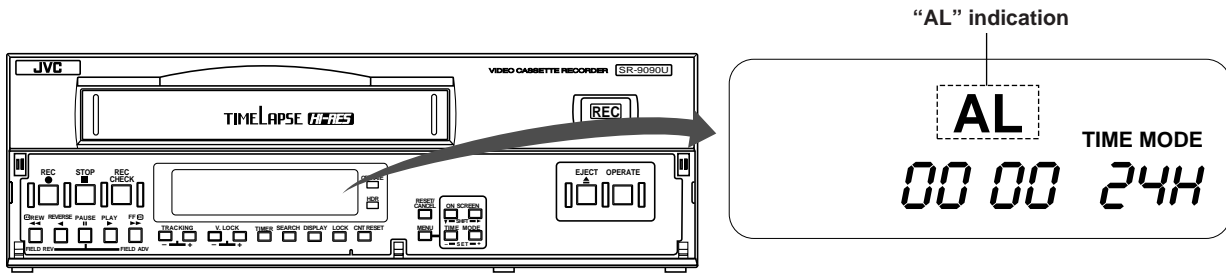

- Menu switches are provided for alarm recording mode, alarm recording duration, buzzer ON/OFF in alarm recording, and Forced Stop mode ON/OFF at tape end.
- During alarm recording, the [AL] indication is lit on the VCR and the [ALARM] indication is lit on the monitor display. After alarm recording is complete, the "AL" indication blinks on the display to show that an alarm signal has been input.

\* If the alarm recording function is activated a hundred times a day or more, a malfunction may occur because the guaranteed range is exceeded. If you want to use this unit more than a hundred times a day, set the recording speed mode to 2H/6H and perform regular maintenance, replacing parts as necessary.

On-screen "ALARM" indication	Extinguished	Shown	Extinguished	Shown	Extinguished
Display "AL" indication	Extinguished	Lit	Blinking	Lit	Blinking
Record mode	Timelapse mode	2H (SP) /6H (EP)	Timelapse mode	2H (SP) /6H (EP)	Timelapse mode
	Timelapse recording	Alarm recording	Timelapse recording	Alarm recording	Timelapse recording
		Alarm signal input		Alarm signal input	

\* An index code (VISS) is recorded at the start point of the alarm recording as an alarm cue signal.

\* During alarm recording, a +12 V signal is output from the rear panel's ALARM REC OUT terminal.

\* If a new alarm signal is input during alarm recording, alarm recording restarts from that point.

## 6 RECORDING

### 6-4 Alarm Recording

#### Preparation Connect an alarm sensor to the rear panel's alarm input terminal.

- 1 Press the [OPERATE] button to turn the operating mode on.
- 2 Open the main menu's <ALARM/SENSOR MODE> and set the alarm recording-related menu switches.

##### ① REC MODE

Set to "ALARM" or "ALL" to activate alarm recording.

- When set to "ALL", both alarm recording and sensor recording will be performed.

- The [ALARM] indication lights on the display.

##### ② REC SPEED

Select the alarm recording speed from the 2H (SP) mode or the 6H (EP) mode.

##### ③ DURATION

Set the alarm recording duration to 5 sec., 10 sec., 15 sec., 30 sec., 60 sec., 120 sec., 180 sec., TAPE END (to tape end) or MANUAL (for as long as alarm signals are input).

\* When the alarm recording time is set to "MANUAL", the alarm cue signal (index code) will not be recorded correctly if alarm input lasts for less than 5 seconds.

\* When alarm recording duration is set with an external switcher, set the alarm recording duration to "MANUAL".

##### ④ TAPE END MODE

Selects whether or not the Stop mode is forcibly engaged when the tape ends even if there is an alarm recording during recording.

- When set to "STOP", the Stop mode is engaged at tape end even if repeat recording or auto rewind is set.
- When set to "OFF", VCR operation is determined by the repeat recording or auto rewind setting.

- 3 Set the other menu switches.

##### ■ Setting the alarm buzzer

Set the menu switch <AL/SENSOR IN> in <BUZZER> to "ON" to sound the alarm buzzer during alarm recording.

##### ■ Setting the on-screen brightness and display items

Select the monitor display setting with the menu switch.

On-screen information is recorded together with the video signals.

You can change the on-screen display position with the [ON SCREEN ▼/▶] buttons on the front panel.

##### ■ Setting the HDR

To record in the HDR mode during timelapse recording, set the menu switch <HDR> in <VTR MODE> to "ON".

#### ALARM/SENSOR MODE screen

[SRI/EXT MODE]	
1. SRI/EXT	OFF
2. EXT REC END	NORMAL
3. CNT TAPE END	OFF
[ALARM/SENSOR MODE]	
1. REC MODE	ALARM
2. REC SPEED	2H
3. DURATION	180SEC
4. TAPE END MODE	OFF

→ Set to "ALARM" or "ALL".

- 4 Select the timelapse recording mode with the [TIME MODE +/-] button on the front panel.  
→ The selected recording speed mode is shown on the VCR's display and on the monitor.
- 5 Follow the procedure described in "Recording Basic Operation" on page 30.
- 6 When an alarm signal is input to the rear panel's [ALARM IN] terminal, alarm recording is executed in accordance with the specified settings.
- 7 To stop alarm recording and clear the [ALARM] indication, press the [RESET/CANCEL] button.
  - If the [RESET/CANCEL] button is pressed when the [AL] indication is lit (during alarm recording), alarm recording stops, the [AL] indication goes out, and timelapse recording is restored. If the alarm buzzer is on, the buzzer sound also stops.
  - If the [AL] indication blinks and the [RESET/CANCEL] button is pressed, the [AL] indication goes out.
- 8 The alarm input data can be checked in the main menu's <OTHER> menu (refer to page 21). Display the alarm list screen and press the [RESET/CANCEL] button to reset the alarm input data.

\* There may be some picture distortion at the start or end of an alarm recording. This is not a malfunction.

## 6 RECORDING

### 6-5 Sensor Recording

Sensor recording is executed only when the VCR is in the Stop mode (Stop, Timer Record Standby or Operating Off mode) and an alarm signal is input to the rear panel's ALARM IN terminal.

Perform the settings for sensor recording in the same way as for "Alarm Recording" on page 39.

The mechanism of the SR-9090U cannot be guaranteed if the sensor recording function is used frequently (100 times/day or more).

#### Preparation **Connect an alarm sensor to the rear panel's alarm input terminal.**

1 Press the [OPERATE] button to turn the operating mode on.

2 Open the main menu's <ALARM/SENSOR MODE> and set the sensor recording-related menu switches.

① REC MODE

Set to "SENSOR" or "ALL" to activate alarm recording.

- When set to "ALL", both alarm recording and sensor recording will be performed.
- The [SENSOR REC] indication lights on the display.

② REC SPEED

Select the alarm recording speed from the standard (2H) mode or the extended EP (6H) mode.

③ DURATION

Set the sensor recording duration to 5 sec., 10 sec., 15 sec., 30 sec., 60 sec., 120 sec., 180 sec., TAPE END (to tape end) or MANUAL (for as long as alarm signals are input).

\* The sensor recording time will be shorter than the specified value.

\* When the sensor recording time is set to "MANUAL", the alarm cue signal (index code) will not be recorded correctly if sensor input lasts for less than 5 seconds.

\* When sensor recording duration is set with an external switcher, set the sensor recording duration to "MANUAL".

④ TAPE END MODE

Selects whether or not the Stop mode is forcibly engaged when the tape ends during sensor recording.

- When set to "STOP", the Stop mode is engaged at tape end even if repeat recording or auto rewind is set.
- When set to "OFF", VCR operation is determined by the repeat recording or auto rewind setting

3 Set the other menu switches.

■ **Setting the alarm buzzer**

Set the menu switch <AL/SENSOR IN> in <BUZZER> to "ON" to sound the alarm buzzer during sensor recording.

■ **Setting the on-screen brightness and display items**

Select the monitor display setting with the menu switch. On-screen information is recorded together with the video signals.

You can change the on-screen display position with the [ON SCREEN ▼/▶] buttons on the front panel.

#### ALARM/SENSOR MODE screen

[SRI/EXT MODE]	
1. SRI/EXT REC	OFF
2. EXT REC END	NORMAL
3. CNT TAPE END	OFF
[ALARM/SENSOR MODE]	
1. REC MODE	SENSOR
2. REC SPEED	2H
3. DURATON	60SEC
4. TAPE END MODE	OFF

— Set to "SENSOR" or "ALL".

4 Turn the operating mode on to engage the Stop mode.

- 5
- When an alarm signal is input to the rear panel's [ALARM IN] terminal, recording starts automatically in the specified recording mode (2H or 6H) and the [AL] indication is lit. The [ALARM] indication is shown on screen.
  - After the specified recording duration expires, recording stops.

\* As sensor recording starts from the Stop mode, it takes several seconds before actual recording starts.

- 6
- To stop sensor recording and clear the [ALARM] indication, press the [RESET/CANCEL] button.
- In this case, even if the menu switch <TAPE END MODE> is set to "STOP", the operation executed at end of the tape is determined by the setting of the <AUTO REW> or <REPEAT REC> menu switch in the <VTR MODE> menu.

- 7
- To release the Sensor Record mode, set the <REC MODE> menu switch in <ALARM/SENSOR MODE> to "OFF" or "ALARM".

\* During playback, there may be some noise or picture distortion at the point where one sensor recording stops and another starts. This is not a malfunction.

\* When a new alarm is input during sensor recording, sensor recording restarts from that point.



# 6 RECORDING

## 6-6 Series Recording

The series recording function facilitates recording over much longer periods using several connected SR-9090Us. As soon as the tape ends in one VCR, the next VCR in the series starts recording. Using the counter end output function enables smoother switchovers during series recording, mostly eliminating interruptions between tapes.

### Connections

- Connect the first VCR's [SERIES REC OUT] terminal to the second VCR's [SERIES REC IN] terminal. Connect the second VCR's [SERIES REC OUT] terminal to the third VCR's [SERIES REC IN] terminal. Repeat for all connected VCRs. Connect the VCR's [COM] terminals as well.
- Connect a video camera and/or other source equipment to the first VCR's video and audio input connectors. Connect the first VCR's video and audio output connectors to the second VCR's video and audio input connectors. Connect the second VCR's video and audio output connectors to the third VCR's video and audio input connectors. Repeat for all connected VCRs. Connect the last VCR's video and audio output connectors to the monitor's video and audio input connectors.

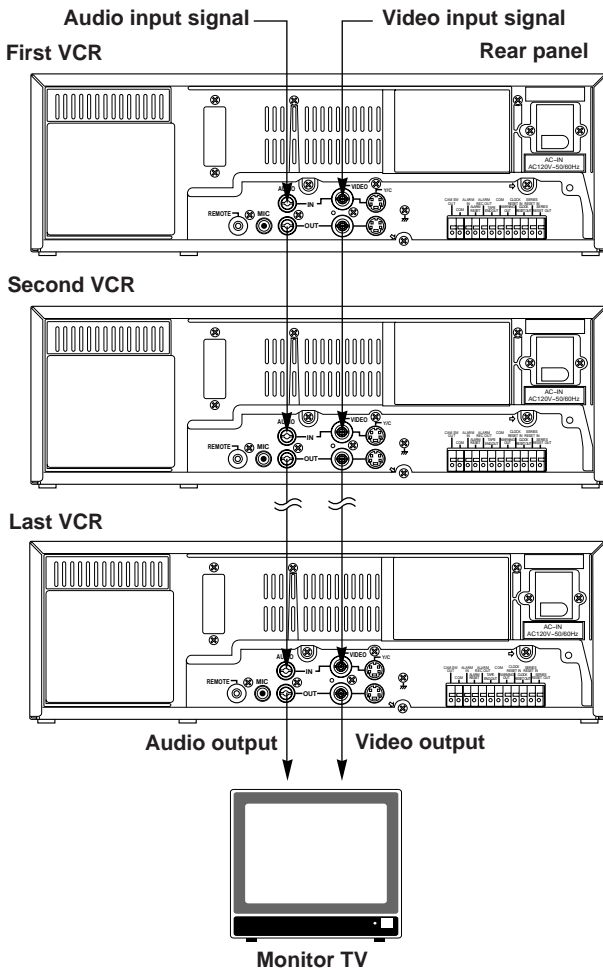

[SRI / EXT MODE]	
1. SRI / EXT REC	SERIES
2. EXT REC END	NORMAL
3. CNT TAPE END	5000
[ALARM / SENSOR MODE]	
1. REC MODE	OFF
2. REC SPEED	2H
3. DURATION	158SEC
4. TAPE END MODE	OFF

- Normally the next VCR starts recording when the tape ends. If the menu switch counter end output function is on, a series recording signal is output when the selected tape reel counter value is passed, and the next VCR starts recording. Select the counter end value from "500", "1000" ... "9500" with the <CNT TAPE END> menu switch.
  - The tape reel counter value from the beginning of the tape to the end is about 5800 on a T-120 cassette tape. (Refer to page 64.)

- 2 Press the [MENU] button to restore the normal screen.
- 3 Load cassettes with safety tab in place in all connected VCRs.
  - To use the counter end output function, set the counter to the tape reel counter display with the [DISPLAY] button. When a cassette is loaded, the counter is reset to "0000".
- 4 Start recording on the first VCR.

## 6 RECORDING

### 6-6 Series Recording

- 5 When the first VCR ends recording, the second VCR starts recording automatically, then the third and so on.
- When the tape end output is set, series recording signals are output from the [SERIES REC OUT] terminal at the specified tape reel counter value, signaling the next VCR to start recording. The first VCR continues recording until the tape ends.

- If the <AUTO REW> menu switch in <VTR MODE> is set to "OFF", the Stop mode is engaged when the end of the tape is reached during recording. If <AUTO REW> is set to "ON", the tape rewinds to the beginning and stops.
- **Counter value**  
When the tape is rewound to the beginning in the Repeat Recording or Auto Rewind mode using the counter end output function, the tape reel counter value is reset to "0000".

#### Non-stop continuous series recording

The series recording function allows you to record indefinitely using two VCRs. Recording alternates between each VCR. To use this function, connect and set the VCRs as follows.

##### ■ Connection

- Connect the [SERIES REC OUT] terminal of the first VCR to the [SERIES REC IN] terminal of the second VCR, and the [SERIES REC OUT] terminal of the second VCR to the [SERIES REC IN] terminal of the first VCR. The [COM] terminals of both VCRs should be connected.

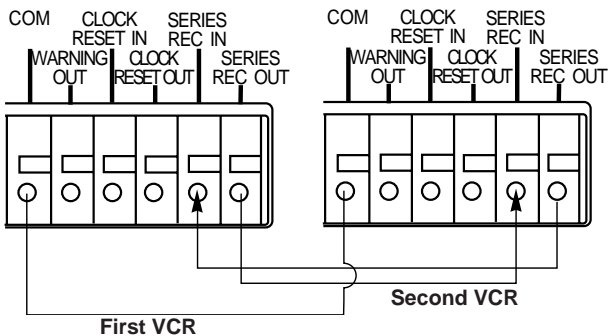

- Connect audio and video terminals as shown in the connection diagram on page 41.

##### ■ Setting

- Set the <SRI/EXT REC> menu switch on both units to "SERIES".
  - Set the <AUTO REW> menu switch in <VTR MODE> to "ON".
  - Set the <AUTO REC CHECK> and <REPEAT REC> menu switch in <VTR MODE> to "OFF".
- For uninterrupted endless series recording, use the counter end output function together. Set <CNT TAPE END> so that the counter end signal is output just before the tape end.
- Set <CNT TAPE END> in the <SRI/EXT MODE> menu to "5500" (when a T-120 tape is used).

\* When the tape is rewound to the beginning in the Auto Rewind mode using the counter end output function, the tape reel counter is reset automatically to "0000".

##### Note:

- Continuous series recording over a long period may produce excessive wear and tear on the tapes and VCRs. Be sure to replace the tapes periodically (refer to page 28).

# 6 RECORDING

## 6-7 Repeat Recording

When the tape comes to the end during recording, it is automatically rewound and recording starts again from the beginning.

- To execute repeat recording, set <REPEAT REC> in <VTR MODE> to "ON".
  - The [REPEAT] indication in the VCR's display lights.
- Setting the <TAPE END MODE> menu switch in <ALARM/SENSOR MODE>
  - If this menu switch is set to "STOP", the Stop mode is forcibly engaged when the tape ends even if there is an alarm or sensor recording.
  - To continue repeat recording even if an alarm recording or sensor recording takes place during recording, set <TAPE END MODE> to "OFF".

When the Tape End Forced Stop mode and Repeat Rec mode are engaged and an alarm or sensor recording takes place, the [REPEAT] indication goes out.

VIDEO/VTR MODE screen

[VIDEO MODE]	
1. INPUT	LINE
2. DETAIL	OFF
3. V. PULSE	OFF
[VTR MODE]	
1. HDR	OFF
2. CNT MEM SW	OFF
3. POWER ON REC	OFF
4. AUTO REC CHECK	OFF
5. AUTO REW	OFF
6. REPEAT PLAY	OFF
7. REPEAE REC	ON

Set to "ON".

ALARM/SENSOR MODE screen

[SR1/EXT MODE]	
1. SR1/EXT REC	OFF
2. EXT REC END	NORMAL
3. CNT TAPE END	OFF
[ALARM/SENSOR MODE]	
1. REC MODE	SENSOR
2. REC SPEED	2H
3. DURATION	60SEC
4. TAPE END MODE	OFF

Set to "OFF"

\* When repeat recording is executed, any previously executed alarm recordings will be erased.

### Automatic recording check function

This unit is provided with an automatic recording check function which automatically determines whether or not recording is satisfactory at the tape beginning in repeat recording.

- To activate the automatic recording check function, set the <AUTO REC CHECK> menu switch in <VTR MODE> to "ON".

### Operation of the automatic recording check function

- Recording is performed from the beginning of the tape for several seconds during repeat recording. Then the recorded section is automatically played back to check whether or not the signals have been recorded properly. If the recording is satisfactory, recording resumes.
- If the recording is unsatisfactory, the heads are cleaned automatically. Recording is restarted for several seconds and then the recording is checked again. If the recording is still unsatisfactory, the error code "E-09" is shown on the display and recording resumes.

### When the <AUTO REC CHECK> menu switch is set to "ON"

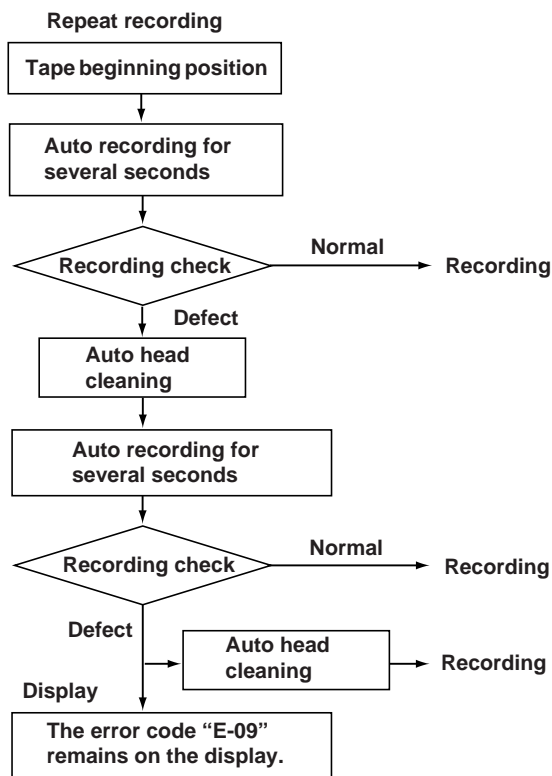

### Note:

- Continuous repeat recording over long periods may produce excessive wear and tear on the tape and VCR. Be sure to replace the tape periodically (refer to page 28).

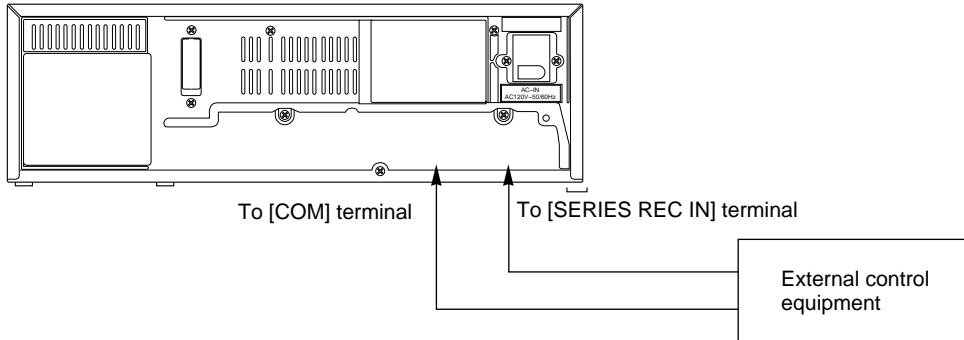

[SR1/EXT MODE]	
1. SR1/EXT REC	EXT
2. EXT REC END	EXT
3. CNT TAPE END	7000
[ALARM/SENSOR MODE]	
1. REC MODE	OFF
2. REC SPEED	2H
3. DURATION	15SEC
4. TAPE END MODE	OFF

## 6 RECORDING

### 6-9 How to Restore Recording After Power Failure

If a power failure occurs during recording, recording will restart in the same mode as soon as power is restored.

To use this function, set the <POWER ON REC> menu switch in <VTR MODE> to "ON".

If this menu switch is set to "ON" and operating mode is turned off and on again in the Stop mode, the VCR enters the Record mode automatically. Be careful.

VTR MODE screen

[ VIDEO MODE ]		
1. INPUT		LINE
2. DETAIL		OFF
3. V. PULSE		OFF
[ VTR MODE ]		
1. HDR		OFF
2. CNT MEM SW		OFF
3. POWER ON REC		ON
4. AUTO REC CHECK		OFF
5. AUTO REW		OFF
6. REPEAT PLAY		OFF
7. REPEAE REC		OFF

— Set to "ON"

### 6-10 External Timer Recording

External timer recording can be performed by connecting the SR-9090U to an external timer.

- 1 Check that a cassette is loaded in the VCR.
  - \* If the cassette's safety tab has been removed, recording will not take place.
  - \* This function does not work when the Timer Record mode is engaged.
- 2 Set the <POWER ON REC> menu switch in <VTR MODE> to "ON".

Power is supplied from the external timer at the specified time and recording starts.

  - Recording is performed at the preset recording speed. If alarm recording or sensor recording is executed before the power is supplied, the Alarm Record mode or Sensor Record mode is released and normal recording starts.

### 6-11 Tape End Buzzer

You can switch the buzzer sound which lets you know when the tape ends during recording ON/OFF.

- To sound the buzzer, set the menu switch <TAPE END> in <BUZZER> to "ON".
  - If <CNT TAPE END> in the <SRI/EXT MODE> menu is set to any position except "OFF", the buzzer sounds when the reel counter value is reached.
- The buzzer continues to sound. To stop the buzzer sound, set the menu switch <TAPE END> to "OFF", perform another operation (such as pressing the [REW] button) or press the [OPERATE] button.
- During repeat recording and auto rewind, the buzzer sounds for about 2 seconds.

BUZZER screen

[ BUZZER ]		
1. TAPE END		ON
2. AL / SENSOR IN		OFF
3. WARNING		OFF
[ IN / OUT ]		
1. CAMERA SW		OFF
2. RS232C B. RATE		9600

— Set to "ON"

Shown only when the SA-K97U is installed

# 7 PLAYBACK AND SPECIAL-EFFECTS PLAYBACK

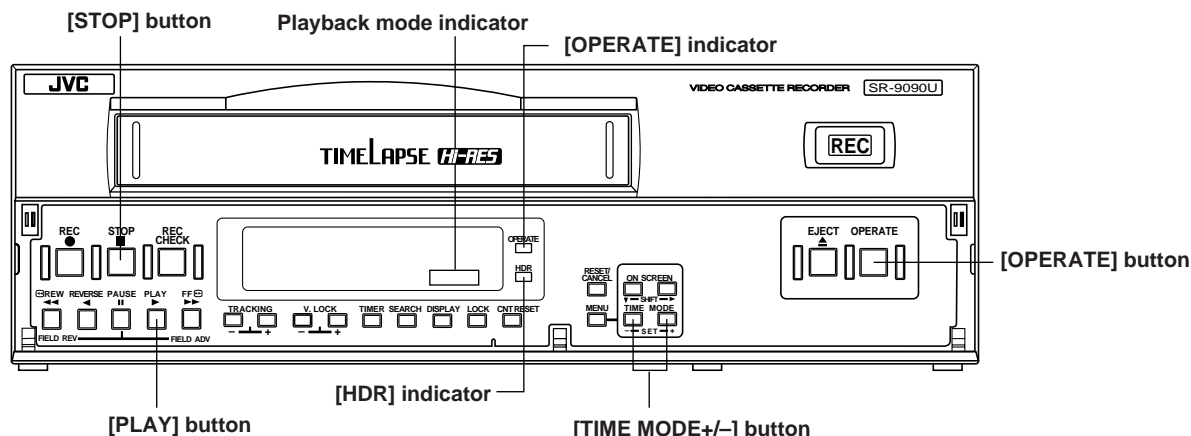

## 7-1 Preparation

### Connection

Connect the output connectors on the rear panel correctly.

### Menu switch setting

Set the menu switches in <VIDEO/VTR MODE> as required.

- **[DETAIL] ... Factory setting: OFF**  
Set to "ON" to improve reproduction of picture detail. However, the S/N ratio will be degraded.
- **[V. PULSE] ... Factory setting: OFF**  
Set to "ON" to add V. pulse in the normal play (2H or 6H) mode.
- **[CNT MEM SW] ... Factory setting: ON**  
Counter memory ON/OFF.
  - Set to "ON" to use the counter memory function.
- **[AUTO REW] ... Factory setting: OFF**  
Automatic rewind ON/OFF.
  - Set to "ON" to rewind the tape to the beginning when the tape ends.
- **[REPEAT PLAY] ... Factory setting: OFF**  
Repeat playback ON/OFF.
  - Set to "ON" to execute repeat playback.

\* Noise may appear in the picture with tapes not recorded on the SR-9090U.

### Notes on playback

Tapes recorded on this VCR cannot be played back on standard VHS VCRs. Use this VCR, an S-VHS VCR or a VCR with SQPB function to play back tapes recorded on this unit. Also be aware that not all S-VHS VCRs will be able to play back tapes recorded on this unit, because some use different S-VHS/VHS detection methods. Try to avoid operations such as shuttle search or field advance playback as much as possible. These put a comparatively high stress load on the tape and can lead to picture degradation over time. During shuttle search or field advance playback, noise may appear. This is normal with this unit and is not a malfunction.

## 7-2 Playback

- 1 Press the [OPERATE] button to turn the operating mode on.  
The [OPERATE] indicator lights.
- 2 Press the [TIME MODE +/-] button to set the play mode to 2H (SP) or 6H (EP) mode.

The [2H] or [6H] indication is shown on the display.

- To play back a tape recorded in the timelapse mode at slow speed, press the [TIME MODE +/-] button to set the desired mode (24H, 48H..... 960H) (slow play).
- Avoid using slow-motion playback continuously for long periods (more than several hours).

- 3 Load the recorded cassette correctly.
  - \* If a cassette is loaded when the operating mode is off, the operating mode is switched on automatically (auto operate on function). If the cassette's safety tab has been removed, the operating mode is turned on and play starts automatically (auto play function).
- 4 Press the [PLAY] button to start play.

 The play indicator is shown on the display and the Play mode is engaged.

When a tape recorded in the HDR mode is played back, the [HDR] indicator lights.

\* No sound is output in the Timelapse Play mode.

When the play mode is set to 2H (SP) or 6H (EP), playback operates as follows.

- Cassettes recorded in the 2H or ordinary (SP) Timelapse modes are played back in the 2H (SP) mode. [2H] is shown on the display.
- Cassettes recorded in the 6H or HDR Timelapse mode are played back in the 6H (EP) mode. [6H] is shown on the display

### To stop playback

- 5 Press the [STOP] button.  
The tape stops and the Stop mode is engaged.

## 7 PLAYBACK AND SPECIAL-EFFECTS PLAYBACK

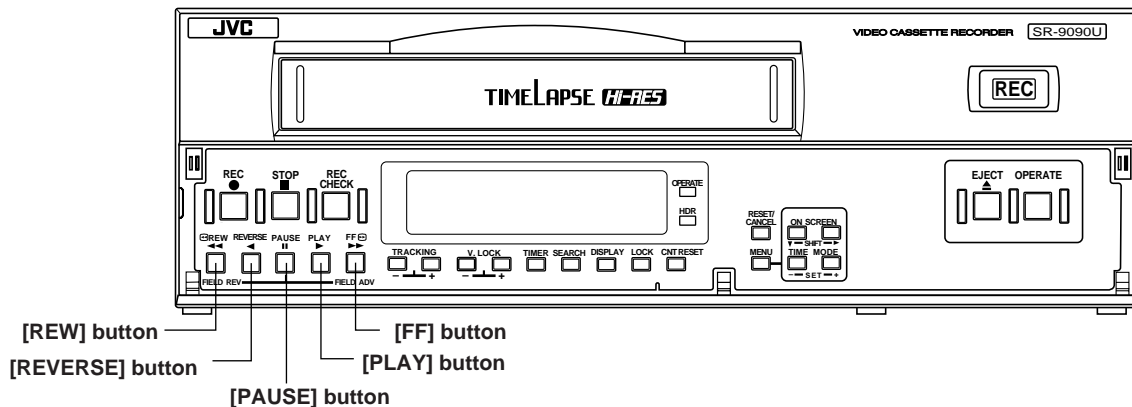

### 7-3 Special-Effects Playback

#### Still playback

- 1 Press the [PAUSE] button during playback.  
 The still indicator is shown on the display and the still picture is shown.
- 2 Press the [PLAY] button to restore the Normal Play mode.

The Stop mode is automatically engaged if the VCR remains in the Still mode for 3 minutes (approx.).

#### Field advance playback

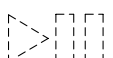
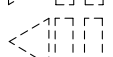
- 1 Press the [PAUSE] button in the Play mode to engage the Still mode.
- 2 While pressing the [PAUSE] button, press the [FF] button or [REW] button.  
 The operation varies depending on how the [FF] or [REW] button is pressed.
  - Each time the [FF] button or [REW] button is pressed, the picture is advanced or reversed one field.
  - When the [FF] button or [REW] button is pressed for more than 2 seconds, the picture is advanced or reversed continuously field by field (continuous field advance playback).  
 
- 3 Press the [PAUSE] button in the Continuous Field Advance Play mode to restore the Still mode.  
 Press the [PLAY] button to restore normal playback.

- In the Continuous Field Advance Play mode, no sound is output.
- When continuous field advance playback continues for about 3 minutes, the Stop mode is automatically engaged to protect the tape.
- When forward field-by-field playback is switched to reverse field-by-field playback, noise may appear in the picture for several seconds.
- During reverse field-by-field playback, noise may appear in the picture.

#### Reverse playback

- 1 Press the [REVERSE] button in any mode except Record, Record-Pause or Record Check.  
 The reverse indicator is shown on the display and the Reverse mode is engaged.
  - The tape is played back in reverse in the 2H or 6H mode regardless of the playback speed mode setting.
- 2 Press the [PAUSE] button to engage the Still mode.  
 To restore the normal playback, press the [PLAY] button.

\* No sound is output.

# 7 PLAYBACK AND SPECIAL-EFFECTS PLAYBACK

## 7-3 Special-Effects Playback

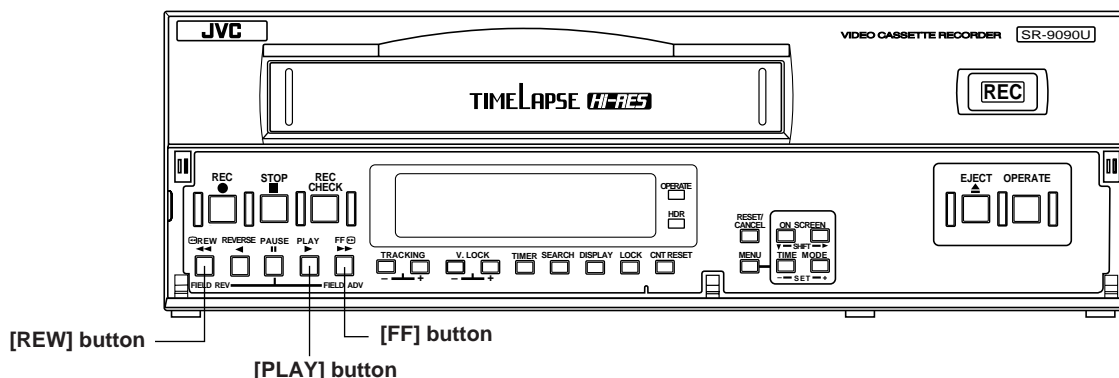

### Shuttle search (reverse and fast-forward) playback

Press the [FF] button or [REW] button in the Play mode to engage the Fast-Forward Shuttle Search mode or Reverse Shuttle Search mode.

#### ■ Fast-forward shuttle search

Press the [FF] button during play.

The fast-forward search indicator is shown on the display and the Fast-Forward Shuttle Search mode is engaged.

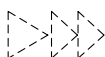

#### ■ Reverse shuttle search

Press the [REW] button during play.

The rewind search indicator is shown on the display and the Reverse Shuttle Search mode is engaged.



- The operation varies depending on how the [FF] or [REW] button is pressed. Refer to the table below for details.

Operation of the [REW] and [FF] buttons	Type of recording	Tape recorded in the 2H (SP) mode or the ordinary Timelapse mode	Tape recorded in the 6H (EP) mode or the HDR Timelapse mode
Press the button once.		7 times 2H (SP) speed (latch). Press the [PLAY] button to restore the normal play mode	21 times the 6H (EP) speed (latch). Press the [PLAY] button to restore the normal play mode.
Hold the button pressed for more than 2 seconds.		7 times 2H (SP) speed. Release the button to restore the normal play mode.	13 times the 6H (EP) speed. Release the button to restore the normal play mode.

- Latch: Even if the button is released, shuttle search continues.

\* During shuttle search, no sound is output.



## 7 PLAYBACK AND SPECIAL-EFFECTS PLAYBACK

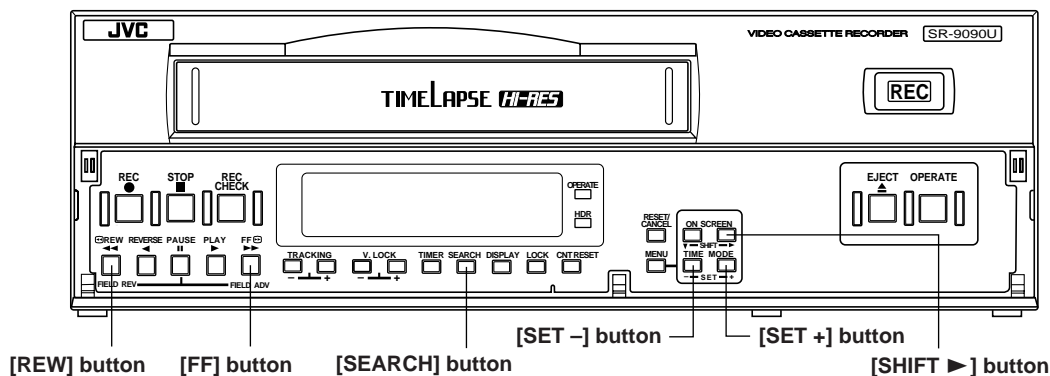

### 7-4 Alarm Search/Date and Time Search

There are three different ways you can search a tape position.

When the [SEARCH] button is pressed, the Search mode is engaged. Each time the [SEARCH] button is pressed, the Search mode changes.

- (Once) alarm search: To search the start of an alarm recording.
  - (Twice) alarm scan: To play back around the start of each alarm recording for several seconds.
  - (Three times) date/time search: To search for a recording made at a specified date and time.
- Press the [SEARCH] button four times to cancel the Search mode.

#### Note on date/time search

Recording duration is especially important with timelapse recordings. If the duration is too short, date/time search will not function correctly. The recording duration must be equivalent to at least 5 seconds at Standard (2H) or EP (6H) speed.

(Example) In the 960-hour normal timelapse mode, the recording time should be 40 minutes or more.

#### Alarm search setting screen

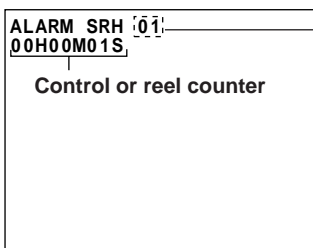

Alarm number (01- 99)  
To specify the alarm recording to be cued, enter the alarm number with respect to the current tape position in the forward or reverse direction.

#### VCR's display

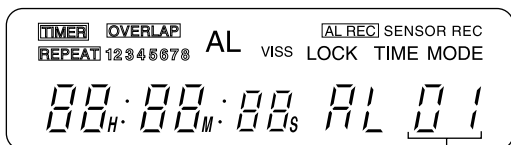

Alarm number

#### Alarm search

A specified alarm recording is searched and the Stop mode is engaged.

- 1 Press the [SEARCH] button once in the Stop mode.
  - The VCR enters the Alarm Search mode and the alarm search setting screen is shown on the monitor. The [AL01] indication blinks in the record/playback speed mode indication section on the display.
  - \* To cancel the Alarm Search mode, press the [SEARCH] button three times.
- 2 Specify the alarm recording you want to search. Press the [SET +] or [SET -] button to specify an alarm number from 01 to 99. The specified alarm number is shown on the monitor and the VCR's display. The alarm number is not absolute; it depends on the current tape position.
- 3 Press the [FF] or [REW] button.
  - The VCR fast forwards or rewinds. When the start of the alarm recording with the specified alarm number is located, search stops and the Stop mode is engaged. The Alarm Search mode is automatically canceled.

## 7 PLAYBACK AND SPECIAL-EFFECTS PLAYBACK

### Alarm scan screen

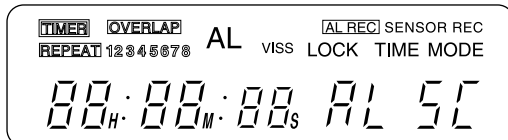
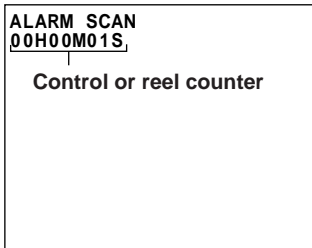

### Date/time search setting screen

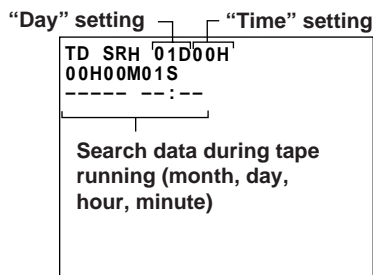

### VCR's display

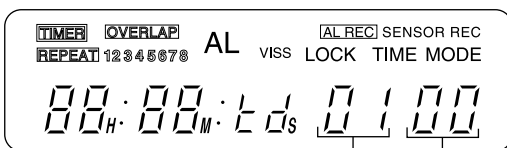

"Day" setting "Hour" setting

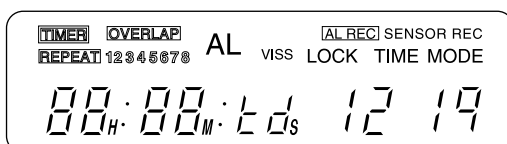
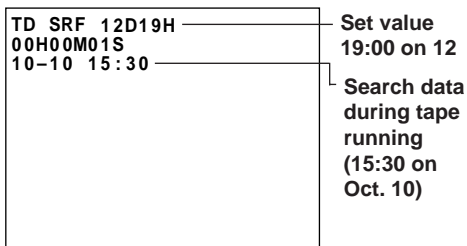

### Alarm scan

The section around the start of each alarm recording is played back for about 5 seconds.

- \* Playback may start a few seconds after the actual start of the alarm recording.
- \* If the interval between alarm recordings is short, the tape may play back continuously for 5 seconds or more.
- \* Sound is not output.

- 1 Press the [SEARCH] button twice in the Stop mode.
  - The Alarm Scan mode is engaged and the [ALARM SCAN] indication is shown on the monitor screen. The [ALSC] indication is shown in the display's record/playback speed mode indication section.
  - \* To release the Alarm Scan mode, press the [SEARCH] button twice.
- 2 Press the [FF] or [REW] button.
  - The VCR fast-forwards or rewinds the tape from the current position and the section around the start of each alarm recording is played back for about 5 seconds.
- 3 Press the [PLAY] button when you want to start playback.
  - Normal playback starts and the Alarm Scan mode is canceled.

- To cancel alarm search or alarm scan, press the [STOP] button, [PLAY] button, [REVERSE] button or the [REW]/[FF] button (whichever is opposite to the current tape running direction).
- When the end or beginning of the tape is reached during alarm search or alarm scan, the mode is canceled and the Stop mode is engaged.

### Date/time search

A section recorded at a specified date and time is searched and the Stop mode is engaged.

- 1 Press the [SEARCH] button three times in the Stop mode.
  - The Date/Time Search mode is engaged and the date/time search setting screen is shown on the monitor.
  - "td 0100" is shown on the VCR's display.
  - \* To cancel the Date/Time Search mode, press the [SEARCH] button once.
- 2 Press the [SET +] or [SET -] button to set the "date" you want to search (01 - 31).
- 3 Press the [SHIFT ►] button so that "hour" blinks.
- 4 Press the [SET +/-] button to set the "hour" you want to search (00 - 23).
- 5 Press the [FF] button or [REW] button.
  - The VCR fast-forwards or rewinds the tape from the current position to search the specified date and time. When the recording is located, the Stop mode is engaged.
  - The Date/Time Search mode is canceled.
  - During date/time search, the month, day, hour and minute which are being searched are shown on-screen.
  - If the specified date and time cannot be found and the tape ends, the Date/Time Search mode is canceled and the Stop mode is engaged.

#### Notes:

- If the specified date and time is near the start of an alarm recording, the date/time search may not be successful.
- If the specified date/time is the same as the timer-recording start time, the VCR may not operate correctly.
- Date/time search cannot be executed if no date and time are available in the search direction.

## 7 PLAYBACK AND SPECIAL-EFFECTS PLAYBACK

### 7-5 Repeat Playback

The tape is automatically rewound and played back repeatedly.

- To execute repeat playback, set <REPEAT PLAY> in <VTR MODE> to "ON".

VIDEO/VTR MODE screen

[VIDEO MODE]		LINE
1. INPUT		OFF
2. DETAIL		OFF
3. V. PULSE		OFF
[VTR MODE]		
1. HDR		OFF
2. CNT MEM SW		OFF
3. POWER ON REC		OFF
4. AUTO REC CHECK		OFF
5. AUTO REW		OFF
6. REPEAT PLAY		ON
7. REPEAE REC		OFF

Set to "ON".

#### Auto rewind

When the tape ends during recording, playback, or forward search, the VCR automatically rewinds the tape to the start and enters the Stop mode.

- To auto-rewind the tape, set the <AUTO REW> menu switch in <VTR MODE> to "ON".

VIDEO/VTR MODE screen

[VIDEO MODE]		LINE
1. INPUT		OFF
2. DETAIL		OFF
3. V. PULSE		OFF
[VTR MODE]		
1. HDR		OFF
2. CNT MEM SW		OFF
3. POWER ON REC		OFF
4. AUTO REC CHECK		OFF
5. AUTO REW		ON
6. REPEAT PLAY		OFF
7. REPEAE REC		OFF

Set to "ON".  
Set to "OFF".

#### Note:

- When the <REPEAT PLAY> or <REPEAT REC> menu switch is set to "ON", the tape restarts playback or recording after rewinding to the beginning.

### 7-6 Counter Memory Function

VIDEO/VTR MODE

[VIDEO MODE]		LINE
1. INPUT		OFF
2. DETAIL		OFF
3. V. PULSE		OFF
[VTR MODE]		
1. HDR		OFF
2. CNT MEM SW		ON
3. POWER ON REC		OFF
4. AUTO REC CHECK		OFF
5. AUTO REW		OFF
6. REPEAT PLAY		OFF
7. REPEAE REC		OFF

Set to "ON".

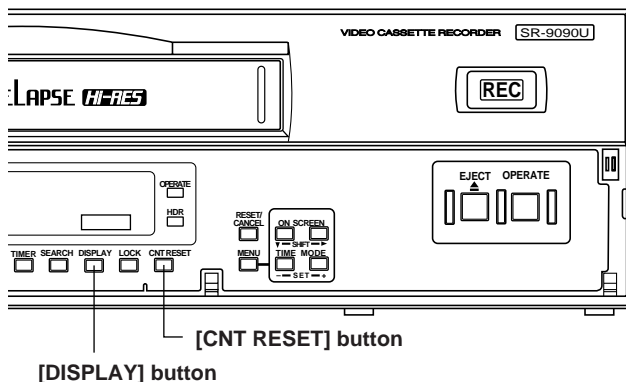

When the counter memory function is ON, the VCR automatically enters the Stop mode when the control tape counter reaches "00:00:00" or when the reel tape counter reaches "0000" in the FF or REW mode.

- To activate the counter memory function, set <CNT MEM SW> in <VTR MODE> to "ON".

#### Operation

- Select the counter display mode.
  - Press the [DISPLAY] button on the front panel to set the counter display mode to the control tape counter or reel tape counter.
- Press the [CNT RESET] button at the position where you want to stop the tape.
  - The counter is set to "00H00M00s" or "0000".
- Execute recording or playback.
  - Engage the Stop mode and press the [FF] or [REW] button.
    - When the counter reaches "00H00M00s" or "0000", the Stop mode is automatically engaged.

#### Note:

- Repeat record/play, auto rewind and alarm search/ alarm scan/date and time search have priority over the counter memory function.

## 7 PLAYBACK AND SPECIAL-EFFECTS PLAYBACK

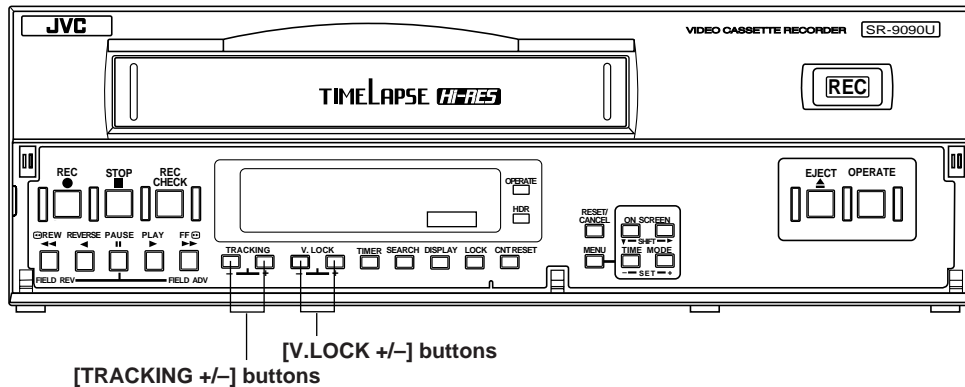

### 7-7 Tracking/V. Lock Adjustment

#### When noise appears in the picture in the Play/Field Advance mode

Tracking adjustment is possible in the following modes.

- 2H (SP), 6H (EP) and timelapse play mode
- Field advance play

■ Press either the [TRACKING +/-] button until picture noise is eliminated or minimized.

To return to the Tracking Preset mode, press the + and – buttons simultaneously.

#### When a picture moves up and down in the Still mode and Timelapse Play mode

Press either the [V.LOCK +/-] button to minimize vertical jitter.

### 7-8 V. PULSE

When the picture is distorted, set the <V. PULSE> menu switch in <VIDEO MODE> to "ON".

This menu switch is effective only in the 2H and 6H modes.

Normally set to "OFF".

- When cameras synchronized with a power supply are switched with a switcher, the pictures may be distorted at the switching point. This switch locks the monitor to prevent distortion of the displayed picture. (Only operates in the Normal Play [2H/6H] mode)
- In the Still or Timelapse Play mode, V. pulses are always output.

VIDEO/VTR MODE screen

[VIDEO MODE]	
1. INPUT	LINE
2. DETAIL	OFF
3. V. PULSE	ON
[VTR MODE]	
1. HDR	OFF
2. CNT MEM SW	OFF
3. POWER ON REC	OFF
4. AUTO REC CHECK	OFF
5. AUTO REW	OFF
6. REPEAT PLAY	OFF
7. REPEAE REC	OFF

Set to "ON".

# 8 TROUBLESHOOTING

## 8-1 Error Indications

Error indications are shown on the display whenever condensation occurs or there are problems with cassette loading, unloading or mechanism operation.

- When a problem occurs, the error indication "E-\*\*\*" lights (when the <WARNING> menu switch in <F. DISP> is set to "ON").
- When any one of error indications (E01 - E08) is shown, a 12-V warning signal is output from the rear panel's WARNING OUT connector.
- When the <WARNING> menu switch in <BUZZER> is set to "ON", the buzzer sounds if a problem occurs (E-01 - E-08 and E-11 (during recording)).

When an error indication appears or the buzzer sounds, turn the operating mode on again to clear the error indication and buzzer sound (E-01-E07). When the error indication "E-\*\*\*" is shown, turning the operating mode on again may not clear the problem. In this case, consult your local JVC dealer.

Display section

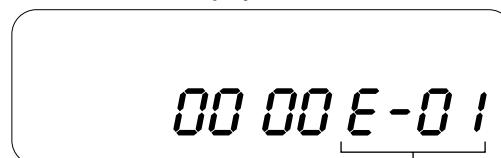

Error indication

BUZZER screen

[BUZZER]		
1. TAPE END		OFF
2. AL/SENSOR IN		OFF
3. WARNING		ON
[IN/OUT]		
1. CAMERA SW		OFF
2. RS232C B.RATE		9600

Buzzer sound

Error indication	Contents	VCR operation	Measures
E-01	Problem with loading operation	The operating mode is turned off.	Turn the operating mode on again.
E-02	Problem with unloading operation	The operating mode is turned off.	Turn the operating mode on again.
E-03	Problem with supply reel rotation	The operating mode is turned off.	Turn the operating mode on again.
E-04	Problem with drum rotation	The operating mode is turned off.	Turn the operating mode on again.
E-05	Problem with take-up reel rotation	The operating mode is turned off.	Turn the operating mode on again.
E-06	Problem with capstan rotation	The operating mode is turned off.	Turn the operating mode on again.
E-07	Problem with eject operation	The operating mode is turned off.	Turn the operating mode on again.
E-08	Condensation	The cassette is ejected and the drum starts rotating. Cassette loading is not possible.	Turn the operating mode on and wait until the error indication goes out.
E-09	Error with recording check (recording defect)	The head cleaner in the VCR cleans the heads.	Clean the heads with a head cleaning tape, then check the recording picture quality again. The tape may be defective. Replace the tape and check again. If the picture quality is still inferior, contact your local JVC dealer.
E-10	Insufficient battery capacity for clock and timer backup.	If a power failure occurs, clock and timer setting data and record/playback speed settings may be reset.	Consult your local JVC dealer for replacement of the built-in battery.
E-11	No input video signal	—	Input video signals.
E-12	It is not possible to write in EEPROM.	—	Consult your local JVC dealer.
E-13	The tape is broken.	The cassette is ejected. The error indication is shown only while the cassette is being ejected.	Replace the cassette.
E-98	System error	The operating mode is turned off.	Consult your local JVC dealer.
E-99	System error	The operating mode is turned off.	

This unit uses a microprocessor and may not function properly if there is external noise or interference. In this case, turn the operating mode off and unplug the power cord from the AC outlet. Then plug the power cord in again and check operation.

## 8 TROUBLESHOOTING

### 8-2 No Error Indication

Symptoms	Causes	Remedies
No power is supplied.	<ul style="list-style-type: none"> <li>● Is the power cord disconnected?</li> <li>● Is the [TIMER] indication shown?</li> <li>● Is the Operation Lock mode engaged?</li> </ul>	<ul style="list-style-type: none"> <li>● Connect the power cord to an AC outlet.</li> <li>● Press the [TIMER] button so that the [TIMER] indication goes out.</li> <li>● Release the Operation Lock mode.</li> </ul>
Operation buttons have no effect during recording and playback.	Is the Operation Lock mode engaged?	Release the Operation Lock mode.
No picture is shown during playback.	<ul style="list-style-type: none"> <li>● Is the monitor connected correctly?</li> <li>● Is the [TIMER] indication lit?</li> </ul>	<ul style="list-style-type: none"> <li>● Connect the monitor correctly.</li> <li>● Press the [TIMER] button to clear the [TIMER] indication.</li> </ul>
Noise appears in the picture in the Shuttle Search mode, Still mode and Field Advance mode.	This is not a malfunction.	—
Noise appears in part of the playback picture.	Is the tracking adjusted properly?	Adjust the tracking with the [TRACKNG +/-] button.
When the cassette is played back, the picture becomes rough or disappears.	Dust may have accumulated on the video heads.	Clean the heads with a commercially-available head cleaning tape. If the picture quality is still unsatisfactory, consult your local JVC dealer.
No sound is heard during playback.	<ul style="list-style-type: none"> <li>● Are you recording in a timelapse mode? If so, sound is not recorded.</li> <li>● During alarm scan, no sound is output.</li> </ul>	Use a tape on which sound is recorded.
Recording is impossible.	Has the cassette safety tab been removed?	Paste a piece of cellophane tape over the hole.
Timer recording is not working.	<ul style="list-style-type: none"> <li>● Is the clock set correctly? Is the timer properly programmed?</li> <li>● Is the [TIMER] indication lit?</li> </ul>	<ul style="list-style-type: none"> <li>● Check again.</li> <li>● Check it again.</li> </ul>
The clock cannot be set.	Is the [TIMER] indication lit?	Press the [TIMER] button so that the [TIMER] indication goes out.
Tape running sound is heard in the Record, Play, FF and REW modes.	During recording and playback, the VCR's motor and rotary heads are running. The sound this generates is normal and not a malfunction.	If you feel it is too noisy, install the VCR in a rack.
The time/date is not shown.	<ul style="list-style-type: none"> <li>● Is the clock set?</li> <li>● Is the &lt;ON SCREEN MODE&gt; menu switch set to "OFF"?</li> </ul>	<ul style="list-style-type: none"> <li>● Set the clock.</li> <li>● Set the &lt;ON SCREEN MODE&gt; menu switch to "ON".</li> </ul>
Auto REW and repeat recording are not possible during recording.	Is the <TAPE END MODE> menu switch in <ALARM/SENSOR MODE> set to "STOP"?	Set the <TAPE END MODE> menu switch to "OFF".
Camera image is not switched.	Is the <CAMERA SW> menu switch in <IN/OUT> set to "OFF"?	When setting the camera switching timing on this unit, set the menu switch to "1 FIELD" or "2 FIELD".
External recording is not possible.	Is the <REPEAT REC> menu switch in the <VTR MODE> menu set to "ON"?	To perform repeat recording using external recording activation, set <REPEAT REC> to "OFF" and <AUTO REW> to "ON".

# 9 OPTIONAL SA-K97U RS-232C INTERFACE BOARD

Functions that can be controlled with front panel buttons and switches can also be controlled from a personal computer when the optional SA-K97U RS-232C interface board is installed. Operation status can also be monitored on the computer.

## 9-1 Installation of the SA-K97U

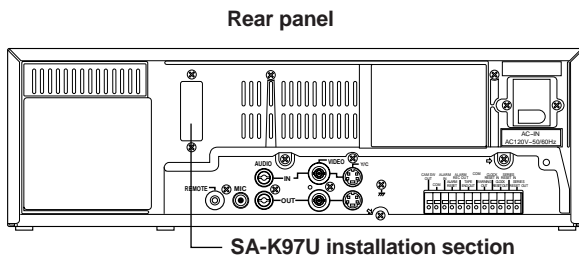

The procedure is shown below. However, to avoid electric shock or injury, contact your local JVC service center for details.

**Note:**

To avoid electric shock, be sure to unplug the power cord from the AC outlet before installing the SA-K97U.

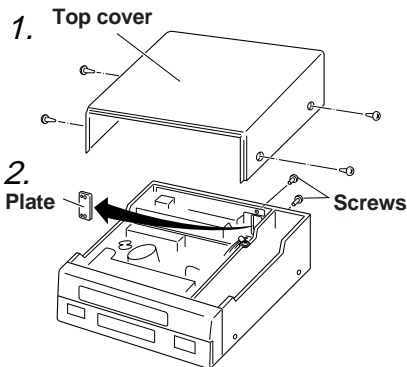

1. Detach the top cover.

**Note:**

Be careful when removing the top cover. The edges of the cover could injure you if handled improperly.

Remove the 4 screws securing the top cover and lift it off.

2. Detach the plate in the VCR.

Remove the 2 screws on the rear panel. Detach the plate from the inside of the VCR.

3. Detach the SA-K97U's wire.

\* The SA-K97U's wire is not used.

4. Install the SA-K97U in the VCR.

Hold the board as shown in the illustration and secure it using the screws removed previously in step 2.

5. Connect the VCR's wire to the SA-K97U's connector.

- Check the direction of the connector and connect it.
- Press both ends of the connector to firmly connect it.

6. Replace the top cover on the VCR and secure it with the four screws previously removed in step 1.

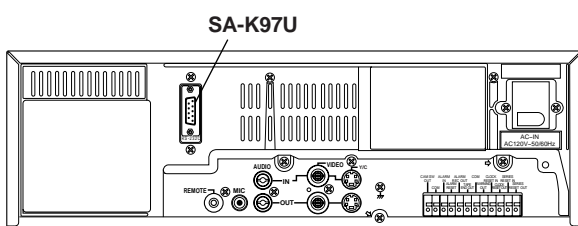
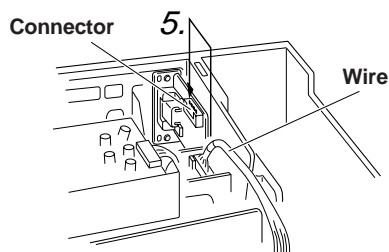
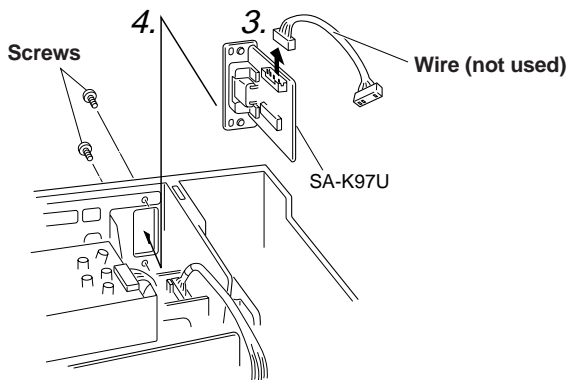

## 9 OPTIONAL SA-K97U RS-232C INTERFACE BOARD

### 9-2 SA-K97U Specifications

#### 9-pin connector specifications

Pin NO.	Signals	Operations	Direction of signals
2	RXD	Receive data	VTR ← CPU
3	TXD	Transmit data	VTR → CPU
4	DTR	Data terminal ready	VTR → CPU
5	GND	Signal ground	
6	DSR	Data set ready	VTR ← CPU

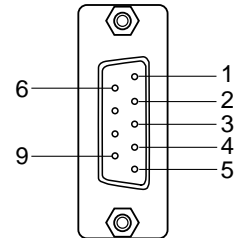

Output level  
 ON : +5 V or more  
 OFF: -5 V or less

#### Data format

- **Mode** : Non-synchronized
- **Character length** : 8 bits
- **Data rate** : 600, 1200, 2400, 4800, 9600 bps  
 (switched with on-screen menu switch, set to 9600 bps before shipment)
- **Parity check** : No
- **Stop bit** : 1 bit

#### Configuration

0 (SPACE)      Start bit | D0 | D1 | D2 | D3 | D4 | D5 | D6 | D7 | Stop bit  
 1 (MARX)



## 9 OPTIONAL SA-K97U RS-232C INTERFACE BOARD

### 9-3 SA-K97U RS-232C Protocol & Commands

#### RS-232C protocol

This VCR is provided with JVC basic table commands in addition to the JVC table-1 commands shown below.

The commands in the shaded area in the table below are contained in both the JVC table-1 and JVC basic table. The JVC basic table commands include only those in the shaded areas.

#### JVC table-1

	0	1	2	3	4	5	6	7	8	9	A	B	C	D	E	F
0			Data "0"	ENTER		TIMER ON	ON SCREEN ON					VISS FWD		FRAME CODE (COUNT)		
1	COMPLETION		Data "1"	CLEAR ERROR		TIMER OFF	ON SCREEN OFF					VISS REV	REC CHECK	DEVICE TYPE	AL . PL RESET	
2	ERROR		Data "2"			PRG/CLK	ROM VER							HOUR METER SENSE	COUNT RESET	
3	CASSETTE OUT		Data "3"			SHFT+	POS V+			EJECT	SEARCH (VISS)					
4			Data "4"			SHFT-	ON SCREEN SELECT									
5	NOT TARGET		Data "5"			SET+	POS H+							PL . AL COUNT SENSE		
6	ALARM INPUT		Data "6"		CLEAR	SET-		TL STATUS SET						TL STATUS SENSE		JVC TABLE1 ON
7			Data "7"			CANCEL								STATUS SENSE		JVC TABLE1 OFF
8			Data "8"													
9			Data "9"			OPE LOCK ON										
A	ACK		PLAY	REV PLAY		OPE LOCK OFF							REC			REC REQUEST
B	NAK						OPERATE ON			FF			REC PAUSE			VTR INQ
C							OPERATE OFF			REW						
D							MODE SHIFT			F-FIELD STEP						
E							MODE	DATE SET		R-FIELD STEP	DATE SENSE					
F			STOP	STILL				TIME SET			TIME SENSE					

## 9 OPTIONAL SA-K97U RS-232C INTERFACE BOARD

### 9-3 SA-K97U RS-232C Protocol & Commands

This section provides technical data for programmers.

#### Command description

To use the commands described in the following pages, prepare the VCR for communications as follows:

Transmit the command "JVC TABLE 1 ON" (F6H) to the VCR. The VCR will return "ACK" (0AH). When the operating mode is turned on, the VCR is in the "ON" status.  
The VCR can now receive any command described in this section. To cancel the communications mode, transmit the command "JVC TABLE 1 OFF" (F7H).

#### 1 VCR control commands

Commands (1) through (12) are 1-byte commands. The VCR will return "ACK" (0AH) when the command is received. Confirm that "ACK" (0AH) has been returned before transmitting the next command.

- |                         |  |
|-------------------------|--|
| (1) OPERATE ON (7BH)    | : VCR operating mode is turned "ON".   |
| OPERATE OFF (7CH)       | : VCR operating mode is turned "OFF".  |
| (2) PLAY (3AH)          | : Playback   |
| (3) STILL (4FH)         | : Pause/Still  |
| (4) STOP (3FH)          | : Stop   |
| (5) FF (ABH)            | : FF/Forward search in the Play mode.  |
| (6) REW (ACH)           | : REW/Reverse search in the Play mode.   |
| (7) REV PLAY (4AH)      | : Reverse playback at normal speed   |
| (8) TIMER ON (60H)      | : Timer "ON"   |
| TIMER OFF (61H)         | : Timer "OFF"  |
| (9) OPE LOCK ON (69H)   | : Operation lock "ON"  |
| OPE LOCK OFF (6AH)      | : Operation lock "OFF"   |
| (10) EJECT (A3H)        | : Cassette ejection  |
|                         | VCR returns "ACK", and then returns CASSETTE OUT (03H) after cassette has been ejected.        |
| (11) F-FIELD STEP (ADH) | : Advances the tape by one field when the VCR is in the Still mode and engages the Still mode. |
|                         | If the VCR is in any other play mode, the Still mode is engaged.                               |
| (12) R-FIELD STEP (AEH) | : Reverses the tape by one field when the VCR is in the Still mode and engages the Still mode. |
|                         | If the VCR is in any other play mode, the Still mode is engaged.                               |
| (13) REC CHECK (C1H)    | : Engages REC CHECK. (function is the same as when locally controlled on the VCR.)             |

Before transmitting either of the following commands ((14) or (15)), first transmit REC/DUB REQUEST (FAH), and confirm that "ACK" (0AH) is returned by the VCR.

- |                      |   |
|----------------------|---|
| (14) REC (CAH)       | : Starts recording. The VCR returns "ACK" (0AH).<br>If the cassette tape's safety tab [REC TAB] has been removed, NAC (0BH) is returned. <ul style="list-style-type: none"><li>• When REC PAUSE (FAH + CBH) is sent in the Record mode, the Record-Pause mode is engaged.</li><li>• When STOP (3FH) is sent in the Record mode, the Stop mode is engaged.</li></ul> |
| (15) REC PAUSE (CBH) | : Engages Record-Pause mode. The VCR returns "ACK" (0AH).<br>If the cassette tape's safety tab has been removed, NAC (0BH) is returned. <ul style="list-style-type: none"><li>• To re-start recording, transmit REC (FAH+CAH).</li><li>• To cancel Record-Pause, transmit STOP (3FH). The VCR will enter the Stop mode.</li></ul>                                   |

After transmitting commands VISS FWD (16) or VISS REV (17), transmit the appropriate numeric data (1-byte ASCII codes from 30H to 39H) and the data input command (40H).

ASCII codes "30H – 39H" correspond with the numbers "0 – 9" (ie.: 0: 30H, 1: 31H, ... 9: 39H).

Each byte of numeric data and the data input command should be transmitted separately with "ACK" (0AH) confirmation from the VCR after each transmission. \* Transmit the commands (16) and (17) in the Stop mode.

- |                     |   |
|---------------------|---|
| (16) VISS FWD (B0H) | : To advance the tape in the forward search mode to the designated alarm-input point. The alarm point's 2-byte numeric data should be input after transmission of this command. |
| (17) VISS REV (B1H) | : To reverse the tape in the reverse search mode to the designated alarm-input point. The alarm point's 2-byte numeric data should be input after transmission of this command. |

Eg: To search for the 3rd alarm-input point from the current position.

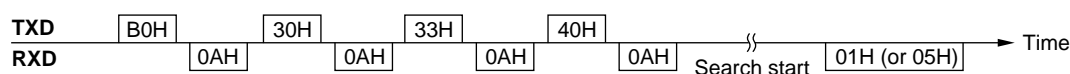

The VCR starts search after returning "ACK". When the specified point is reached, the VCR returns COMPLETION (01H). If the end or beginning of the tape is reached before the specified point, the VCR returns NOT TARGET (05H). (Sending either the 30H,30H or 30H,31H command will cause the VCR to search for the 1st alarm-input point).

## 9 OPTIONAL SA-K97U RS-232C INTERFACE BOARD

After transmitting the VISS SEARCH command (18), transmit the appropriate 2-byte numeric data (from 30H to 39H), the data input command (40H), and either FF (ABH) or REW (ACH). All commands should be transmitted separately one byte at a time with "ACK" (0AH) confirmation from the VCR after each transmission. \* Execute in the Stop mode.

(18) VISS SEARCH (B3H) : To search for a designated alarm-input point on the tape.

The VCR starts search after returning "ACK". When the specified point is reached, the VCR returns COMPLETION (01H). If the end or beginning of the tape is reached before the specified point, the VCR returns NOT TARGET (05H). This command differs from commands (16) and (17) only in that the FF (ABH) or REW (ACH) command is included separately.

### 2 VCR setting commands

Commands available include control of recording/playback mode setting, timelapse VCR operation mode setting, date and time setting, timer programming, on-screen setting, and others.

#### ■ Recording/playback mode setting commands

Two commands are available. One allows you to rotate through recording/playback modes, the other permits you to directly select the mode.

- (1) MODE SHIFT (7DH) : Switches from one recording/playback mode to the next each time the command is transmitted. Use the TL STATUS SENSE (D6H) command to check the current mode. Transmit 1 byte at a time with "ACK" (0AH) confirmation from the VCR after each transmission.
- (2) MODE (7EH) : Sets recording/playback mode directly. After transmitting this command, transmit the appropriate 2-byte ASCII codes (from 30H to 39H) and the data input command (40H). Correspondence of ASCII codes with recording/playback modes is as shown below.

Eg: To set to "24H".

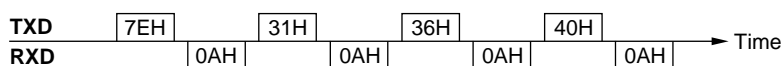

Mode	1st byte	2nd byte
2H	30H	30H
6H	30H	31H
24H	31H	36H
48H	30H	34H
72H	30H	35H
120H	30H	37H
168H	30H	38H
240H	30H	39H
480H	31H	31H
960H	31H	33H

#### ■ Timelapse VCR operation mode setting commands

- (1) TL STATUS SET (86H) : Set the timelapse VCR operation mode with 3-byte data. Send one byte at a time by checking ACK (0AH) from the VCR.

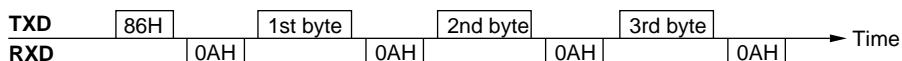

• The setting details for the first to the third bytes are shown below.

1st byte		2nd byte	
BIT	When the bit is "1"	BIT	When the bit is "1"
0	Repeat recording function ON	0	Unused
1	Unused	1	Alarm recording function ON
2	POWER ON REC mode ON	2	Unused
3	Auto rewind ON	3	Sensor recording function ON
4	Unused	4	External recording function ON
5	Series recording function ON	5	Unused
6	Tape end buzzer ON during recording	6	Unused
7	Alarm recording buzzer ON	7	Warning buzzer ON

3rd byte	
BIT	When the bit is "1"
0	Unused
1	Summer time compensation ON
2	Unused
3	Unused
4	HDR mode ON
5	Auto record check function ON
6	Unused
7	Unused

## 9 OPTIONAL SA-K97U RS-232C INTERFACE BOARD

### ■ Date and time setting commands

- (1) DATE SET (8EH) : Set the current date (month, day, year) for the VCR. After this command (8EH) is sent, input 1-byte numerical data (30H — 39H).

(Example) Oct., 30, 1998

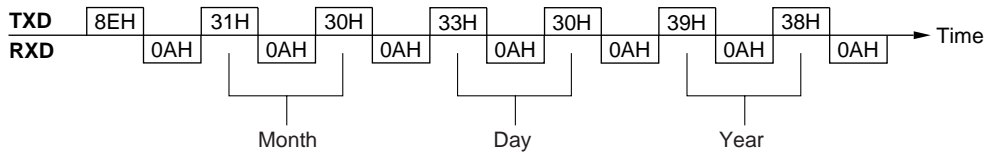

- (2) TIME SET (8FH) : Set the current time (hour, minute, second) for the VCR. After this command (8FH) is sent, input 1-byte numerical data (30H — 39H).

(Example) 15 hours, 29 minutes, 59 seconds

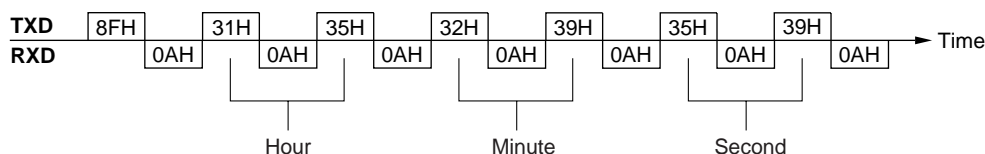

### ■ Timer programming commands

- (1) PRG/CLK (62H) : Engages timer programming mode.  
 (2) SHIFT - (64H) : Selects setting items. (-)  
 SHIFT + (63H) : Selects setting items. (+)  
 (3) SET - (66H) : Sets data selected with SHIFT.  
 SET + (65H) : Sets data selected with SHIFT.  
 (4) CANCEL (67H) : Cancels program data in timer programming or engages the Cancel Program mode.

Setting procedure is the same as when using the VCR controls. Be sure to transmit commands 1 byte at a time with "ACK" (0AH) confirmation from the VCR after each transmission.

### ■ On-screen setting command

- (1) ON SCREEN ON (70H) : Activates on-screen indication.  
 ON SCREEN OFF (71H) : Deactivates on-screen indication.

Setting procedure for the following command (2) is the same as when using the VCR controls. Be sure to transmit commands 1 byte at a time with "ACK" (0AH) confirmation from the VCR after each transmission.

- (2) ON SCREEN SELECT (74H): Switches the on-screen display items.  
 POS V+ (73H): Moves the on-screen indication in the vertical direction.  
 POS H+ (75H): Moves the on-screen indication in the horizontal direction.

### ■ Other commands

- (1) AL/PL RESET (E1H) : When transmitted during alarm recording, the recording mode switches back to the previous mode. The VCR's "AL" indication goes off. Transmit again after "AL" indicator goes off to reset the alarm/power loss memory.  
 (2) COUNT RESET (E2H) : Resets the tape counter to "0000".

## 9 OPTIONAL SA-K97U RS-232C INTERFACE BOARD

### 3 Commands for VCR status verification

When the command is sent, the VCR returns the corresponding information.

- (1) DATE SENSE (BEH) : The VCR returns the currently set month, day and year as 6 bytes. Each byte has a value of 30H to 39H. 30H corresponds to 0 and 39H to 9.  
(Example: For Oct., 14, 1998, the VCR returns 31H, 30H, 31H, 34H, 39H and 38H.)
- (2) TIME SENSE (BFH) : The VCR returns the currently set hour, minute and second as 6 bytes. Each byte has a value of 30H to 39H. 30H corresponds to 0 and 39H to 9.  
(Example: For 15:30:45, the VCR returns 31H, 35H, 33H, 30H, 34H and 35H.)
- (3) COUNT CODE (D0H) : VCR returns the counter data beginning with the 4th digit from the right in 4 bytes. ASCII codes "30H – 39H" correspond with the numbers "0 – 9" (eg: 1234: 31H, 32H, 33H, 34H).
- (4) DEVICE TYPE (D1H) : VCR returns the last 4 characters of the SR-9090 model name in ASCII code.  
39H, 30H, 39H, 30H
- (5) VTR INQ (FBH) : Used to make sure that the connected unit is the VCR. The VCR will return "ACK" (0AH).
- (6) PL/AL COUNT SENSE (D5H) : VCR will return a total of 6 bytes. The first 3 bytes show the number of alarm inputs in 3 digits and the last 3 bytes show the number of power losses in 3 digits. ASCII codes "30H – 39H" correspond with the numbers "0 – 9" (eg: 123 alarm inputs and 45 power losses: 31H, 32H, 33H, 30H 34H, 35H).
- (7) HOUR METER SENSE (D2H) : VCR returns the hour meter data in 5 bytes. (eg: 1234 hours: 31H, 32H, 33H, 34H).
- (8) TL STATUS SENSE (D6H) : VCR returns Timelapse mode data in 6 bytes. The contents of each byte are as follows:

#### 1st/2nd byte

Recording/playback mode

Correspondence of the code and the mode is the same as MODE (7EH) (see page 59).

#### 3rd byte

Conditions of each setting

BIT	Status when BIT is "1".
0	Repeat Record mode ON.
1	Power is ON.
2	POWER ON REC mode is ON.
3	Auto rewind mode is ON.
4	Operation lock is ON.*
5	Series recording is ON.
6	Tape end buzzer is ON.
7	Alarm buzzer is ON.

#### 5th byte

Settings status

BIT	Status when BIT is "1".
0	Always 1.
1	SUMMER TIME is ON.
2	Always 0.
3	Always 0.
4	HDR mode is ON.
5	Auto record check function ON.
6	Always 0.
7	Always 0.

#### 4th byte

Conditions of each setting

BIT	Status when BIT is "1".
0	Alarm recording is in progress.
1	ALARM REC function is ON.
2	Not defined. Always 0.
3	Sensor recording is ON.
4	External recording function is ON.
5	V.pulse is ON.
6	Always 0.
7	Warning buzzer is ON.

#### 6th byte

Types of warnings

HEX.Data	Types of warnings
0	No abnormality
1	Loading error
2	Unloading error
3	Supply reel error
4	Drum error
5	Take-up reel error
6	Capstan error
7	Cassette eject error
8	DEW sensor error.
9	Recording check error
A	Battery backup error
B	Input signal error

\* Operation with commands from the RS-232C is accepted even in the Operation Lock mode.

## 9 OPTIONAL SA-K97U RS-232C INTERFACE BOARD

(9) STATUS SENSE (D7H) : The VCR will return current status information in 5 bytes.

### 1st byte

BIT	Status when BIT is "1".
0 Error	Indicates that an illegal command has been received. No further commands will be accepted. To restore to normal operation, transmit CLEAR ERROR (41H) to the VCR.
1 Not defined	Always 0.
2 Not defined	Always 0.
3 Cassette out	The tape has not been loaded.
4 REC inhibit	A tape with no safety tab has been loaded. In this case, no recording commands will be accepted.
5 Not defined	Always 0.
6 Not defined	Always 0.
7 Not defined	Always 1.

### 2nd byte

BIT	Status when BIT is "1".
0 Tape End	Tape end sensor is detected.
1 Tape Begin	Tape begin sensor is detected.
2 Not defined	Always 0.
3 Warning	VCR malfunction.*
4 Not defined	Always 0.
5 Not defined	Always 0.
6 A EE Mode	An externally-input audio signal is being output.
7 V EE Mode	An externally-input video signal is being output.

### 3rd byte

BIT	Status when BIT is "1".
0 Not defined	Always 0.
1 Search Mode	Search is in progress. (VISS)
2 Repeat Mode	Repeat recording is in progress.
3 Not defined	Always 0.
4 Repeat	VCR's REPEAT REC menu switch is set to ON.
5 Counter	Counter memory is set to ON.
6 Timer REC ON	VCR's TIMER button is set to ON.
7 Not defined	Always 0.

### 4th byte

BIT	Status when BIT is "1".
0 Not defined	Always 0.
1 REC Mode	VCR is in the Record mode.
2 Eject	A cassette is being ejected.
3 Not defined	Always 1.
4 Stop Mode	VCR is in the Stop mode.
5 REW Mode	VCR is in the Rewind mode.
6 FF Mode	VCR is in the Fast-Forward mode.
7 PB Mode	VCR is in the Play mode.

### 5th byte

BIT	Status when BIT is "1".
0 Speed Code 0	VCR's current tape running mode. See below.
1 Speed Code 1	VCR's current tape running mode. See below.
2 Speed Code 2	VCR's current tape running mode. See below.
3 Speed Code 3	VCR's current tape running mode. See below.
4 Shuttle REV	Reverse search is in progress.
5 Shuttle FWD	Forward search is in progress.
6 Not defined	Always 0.
7 Rec-Pause Mode	VCR is in the Pause mode.

#### Contents of 5th byte BIT 0/1/2/3 "Speed Code"

Speed Code	3	2	1	0	
BIT	0	0	0	0	Still
	0	0	0	1	Timelapse playback
	0	1	0	1	Timelapse recording/2H (SP)/6H (EP) playback
	1	0	0	0	Search (X7 or X13)
	1	0	0	1	Search (X21)

\* When an error occurs in the VCR and the Warning mode is engaged, the third bit of the second byte sent back with the STATUS SENSE (D7H) is set to "1", showing the warning status. In this case, release the warning via the RS-232C with the CLEAR (56H). To release it on the VCR, turn the [OPERATE] button off and on again.

(10) ALARM INPUT (06H) : SR-9090U return code  
This is returned when an alarm signal is input during recording.

# 9 OPTIONAL SA-K97U RS-232C INTERFACE BOARD

## 4 Others (Input data correction/Error cancellation)

These are return codes from the SR-9090U. (Error-related codes only)

(1) ERROR (02H) : This is returned when commands of more than 1 byte are transmitted to the VCR and an illegal command is received in the 2nd byte (or later) of the transmitted command.  
In this status, no command can be accepted and only STATUS SENSE will be returned.  
To restore normal operation, transmit CLEAR ERROR (41H) or CLEAR (56H) to the VCR.

CLEAR ERROR (41H)	: Used to cancel previously-transmitted 1-byte numeric data when inputting numeric data such as search point. Also used to cancel error status.
CLEAR (56H)	: Clears the whole command. Cancels the current status and stops the VCR. Also cancels the error status.

Eg : After setting the recording/playback mode to "L24H", 32H is mistakenly transmitted . Cancel 32H with "41H" and input "33H" instead.

TXD	7EH	30H	32H	41H	33H	40H	Time →
RXD	0AH	0AH	0AH	0AH	0AH	0AH	

(2) NAK (0BH) : VCR will return this code when non-defined or non-functional command is received in the 1st byte of the transmitted command. In this case, it is not necessary to input CLEAR. Check whether the transmitted command is acceptable to the VCR or not.

## 3 Commands reference chart

VCR control commands	
	Page
OPERATE ON/OFF	58
PLAY/REV PLAY	58
STOP	58
FF/REW	58
TIMER ON/OFF	58
OPE ON/OFF	58
EJECT	58
F-FIELD STEP	58
R-FIELD STEP	58
REC CHECK	58
REC/REC PAUSE	58
VISS FWD/REV	58
VISS SEARCH	59

VCR setting commands	
	Page
■ Recording/playback mode	59
MODE SHIFT	59
MODE	59
■ Timelapse VCR operation mode	59
TL STATUS SET	59
■ Date and time setting	60
DATE SET	60
TIME SET	60
■ Timer programming	60
PRG/CLK	60
SHIFT -/+	60
SET -/+	60
CANCEL	60
■ On-screen setting	60
ON SCREEN ON/OFF	60
ON SCREEN SELECT	60
POS V+	60
POS H+	60
■ Others	60
AL/PL RESET	60
COUNT RESET	60

Commands for VCR status verification		
	Page	Byte returned from VCR
COUNT CODE	61	4 bytes
DEVICE TYPE	61	4 bytes
VTR INQ	61	1 byte
PL/AL COUNT SENSE	61	6 bytes
HOUR METER SENSE	61	4 bytes
TL STATUS SENSE	61	6 bytes
STATUS SENSE	62	5 bytes
DATE SENSE	61	6 bytes
TIME SENSE	61	6 bytes

Return codes from VCR	
	Page
ACK	58
NAK	63
ERROR	63
CASSETTE OUT	58
COMPLETION	58
NOT TARGET	58
ALARM INPUT	62

Others	
	Page
JVC TABLE 1 ON/OFF	58

# 10 APPENDIXES

## 10-1 Tape Reel Counter/Tape Remaining Time Table

The table below shows the tape remaining time with the tape reel counter value in each record/playback speed mode (when a T-120 tape is used).

Since actual tape remaining time may differ from the values in the table below, use these values for reference only.

When a T-120 tape is used: Tape remaining time when the tape reel counter is "0000" at the beginning of the tape.

		Record/playback speed modes					
HDR OFF		2H	6H	24H	48H	72H	120H
HDR ON		2H	6H	24H	48H	72H	120H
Tape reel counter	0	2 h 2 m	6 h 8 m	24 h 35 m	49 h 10 m	73 h 45 m	122 h 56 m
	500	1 h 47 m	5 h 22 m	21 h 29 m	42 h 58 m	64 h 27 m	107 h 25 m
	1,000	1 h 32 m	4 h 38 m	18 h 34 m	37 h 8 m	55 h 42 m	92 h 51 m
	1,500	1 h 19 m	3 h 57 m	15 h 50 m	31 h 40 m	47 h 31 m	79 h 12 m
	2,000	1 h 6 m	3 h 19 m	13 h 17 m	26 h 35 m	39 h 53 m	66 h 29 m
	2,500	54 m	2 h 44 m	10 h 56 m	21 h 53 m	32 h 49 m	54 h 42 m
	3,000	43 m	2 h 11 m	8 h 46 m	17 h 32 m	26 h 18 m	43 h 51 m
	3,500	33 m	1 h 41 m	6 h 47 m	13 h 34 m	20 h 21 m	33 h 56 m
	4,000	24 m	1 h 14 m	4 h 59 m	9 h 59 m	14 h 58 m	24 h 57 m
	4,500	16 m	50 m	3 h 22 m	6 h 45 m	10 h 8 m	16 h 54 m
	5,000	9 m	29 m	1 h 57 m	3 h 54 m	5 h 52 m	9 h 47 m
	5,500	3 m	10 m	43 m	1 h 26 m	2 h 9 m	3 h 35 m
	5,832	0 m	0 m	0 m	0 m	0 m	0 m

		Record/playback speed modes			
HDR OFF		168H	240H	480H	960H
HDR ON		168H	240H	480H	960H
Tape reel counter	0	172 h 6 m	245 h 52 m	491 h 45 m	983 h 30 m
	500	150 h 23 m	214 h 51 m	429 h 42 m	859 h 25 m
	1,000	129 h 59 m	185 h 42 m	371 h 24 m	742 h 48 m
	1,500	110 h 53 m	158 h 24 m	316 h 49 m	633 h 38 m
	2,000	93 h 5 m	132 h 58 m	265 h 57 m	531 h 55 m
	2,500	76 h 35 m	109 h 25 m	218 h 50 m	437 h 40 m
	3,000	61 h 24 m	87 h 43 m	175 h 26 m	350 h 53 m
	3,500	47 h 31 m	67 h 53 m	135 h 46 m	271 h 32 m
	4,000	34 h 56 m	49 h 55 m	99 h 50 m	199 h 40 m
	4,500	23 h 40 m	33 h 48 m	67 h 37 m	135 h 14 m
	5,000	13 h 41 m	19 h 34 m	39 h 8 m	78 h 17 m
	5,500	5 h 2 m	7 h 11 m	14 h 23 m	28 h 46 m
	5,832	0 m	0 m	0 m	0 m

- When the cassette tape is ejected, the tape reel counter is reset to "0000".
- When the tape is rewound to the beginning in the Repeat Recording or Auto Rewind mode using the counter end output function, the tape reel counter is reset to "0000".

Counter end output function: Set the menu switch <CNT TAPE END> to any position except "OFF".



10-2 Rear Panel's Inputs/Outputs

Terminals	Signal levels	Remarks
<b>CAM SW OUT</b> Camera switching signal output		Open-collector output
<b>ALARM IN</b> Alarm signal input		Input at ground level
<b>ALARM RST IN</b> Alarm signal reset input		Input at high level
<b>ALARM REC OUT</b> Alarm recording mode signal output		Output at high level
<b>TAPE END OUT</b> Tape end signal output		Output at ground level
<b>WARNING OUT</b> Warning signal output		Output at high level
<b>CLOCK RESET IN</b> Clock reset input		Input at ground level
<b>CLOCK RESET OUT</b> Clock reset output		Output at ground level
<b>SERIES REC IN</b> Series recording signal input		Input at ground level
<b>SERIES REC OUT</b> Series recording signal output		Output at ground level
<b>SERIES REC IN</b> External automatic recording signal input		Input at ground level

## 10-3 Specifications

- **Recording system** Luminance: FM recording  
Color: down-converted direct recording
- **Signal system** NTSC-type color signal,  
EIA monochrome signal,  
525 lines/60 fields
- **Tape speed** 33.35 mm/sec., Standard (2H) mode  
11.12 mm/sec., Extended (6H) mode
- **Recording and playback time (with T-120 cassette)** 2 hours (Standard (2H) mode),  
6 hours (Extended (6H) mode), 24,  
48, 72, 120, 168, 240, 480, 960  
hours (including the HDR recording/  
playback mode)  
(Timelapse mode: field recording)
- **Fast-forward/rewind time** Within about 4 minutes  
(with T-120 cassette)
- **Power supply** AC 120 V, 50/60 Hz
- **Power consumption** 19 watts
- **Dimensions** 360 (W) x 115 (H) x 370 (D) mm
- **Weight** Approx. 5.5 kg
- **Operating temperature** 5°C — 40°C
- **Operating humidity** 30%RH or more, 80%RH or less
- **Storage temperature** -20°C — 60°C

### [Video System]

- **Signal input** LINE 1.0 Vp-p, 75 ohms,  
unbalanced BNC  
Y/C Y: 1.0 Vp-p, 75 ohms,  
unbalanced  
C: 0.286 Vp-p, 75 ohms,  
unbalanced (burst)
- **Signal output** LINE 1.0 Vp-p, 75 ohms,  
unbalanced BNC  
Y/C Y: 1.0 Vp-p, 75 ohms,  
unbalanced  
C: 0.286 Vp-p, 75 ohms,  
unbalanced (burst)
- **Horizontal resolution** 400 lines or more (with an HG tape)
- **Video S/N** 43 dB or more (2H mode) (with an HG tape)

### [Audio system]

- **Number of tracks** 1 (normal)
- **Line input** -8 dBs, 50 kohms, unbalanced RCA
- **Mic input** -67 dBs, 600 ohms, unbalanced
- **Line output** -8 dBs, 1 kohm, unbalanced RCA
- **Frequency response** 100 Hz — 10 kHz (2H mode)
- **Audio S/N** 40 dB or more (2H mode at 4% distortion level)
- **Wow and flutter** 0.15% WRMS or less (2H mode)

### [Time/date]

- **Display** Month, day, year, hours, minutes,  
seconds, recording mode, alarm  
input data, power loss data
- **Display position** Variable
- **Character size** 16H
- **Power backup** Approx. two years (may be less  
depending on the operating  
environment)

### [Alarm]

- **Alarm input** Input at ground level
- **Camera switching output** Negative pulse output (5 msec.)  
Open-collector output
- **Accessory** Power cord x 1

### Outer dimensions

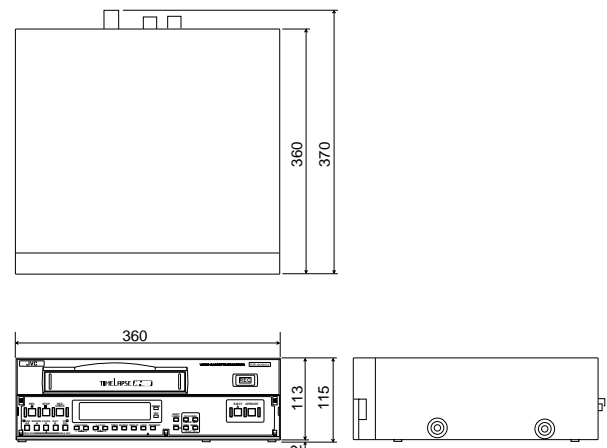

Unit: mm

\* Design and specifications subject to change without notice.





## Free Manuals Download Website

<http://myh66.com>

<http://usermanuals.us>

<http://www.somanuals.com>

<http://www.4manuals.cc>

<http://www.manual-lib.com>

<http://www.404manual.com>

<http://www.luxmanual.com>

<http://aubethermostatmanual.com>

Golf course search by state

<http://golfingnear.com>

Email search by domain

<http://emailbydomain.com>

Auto manuals search

<http://auto.somanuals.com>

TV manuals search

<http://tv.somanuals.com>