

# JVC

# ENGLISH

## Mini DV/S-VHS VIDEO CASSETTE RECORDER

# SR-VS30E

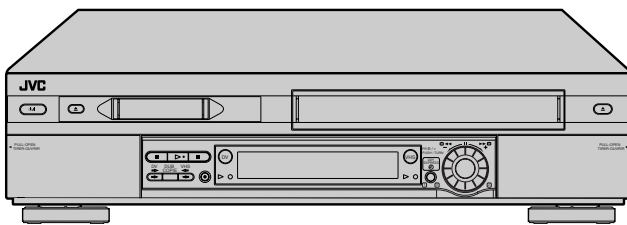

**SHOWVIEW<sup>®</sup>** DELUXE **Hi-Fi** **S-VHS** 625 **Mini DV** PAL

**Super VHS ET**

# INSTRUCTIONS

## CONTENTS

<b>SAFETY FIRST</b>	<b>2</b>
Safety Precautions .....	2
<b>INDEX</b>	<b>4</b>
<b>INSTALLING YOUR NEW RECORDER</b>	<b>10</b>
Basic Connections .....	10
S-VIDEO Connection .....	11
<b>INITIAL SETTINGS</b>	<b>12</b>
Auto Set Up .....	12
Preset Download .....	14
Language .....	16
<b>SAT CONTROL SET</b>	<b>17</b>
Satellite Receiver Control Setting .....	17
<b>T-V LINK</b>	<b>19</b>
T-V Link Functions .....	19
<b>PLAYBACK/RECORDING ON VHS DECK</b>	<b>20</b>
Basic Playback (VHS deck) .....	20
Basic Recording (VHS deck) .....	21
Playback Features (VHS deck) .....	22
Recording Features (VHS deck) .....	26
B.E.S.T. Picture System (VHS deck) .....	29
<b>PLAYBACK/RECORDING ON DV DECK</b>	<b>30</b>
Basic Playback (DV deck) .....	30
Basic Recording (DV deck) .....	31
Playback Features (DV deck) .....	32
Recording Features (DV deck) .....	34
<b>TIMER RECORDING</b>	<b>36</b>
SHOWVIEW <sup>®</sup> Timer Programming .....	36
Express Timer Programming .....	38
24 Hour Express Timer Programming .....	40
<b>EDITING</b>	<b>44</b>
Tape Dubbing (from DV to VHS) .....	44
Tape Dubbing (from VHS to DV) .....	45
Normal Dubbing (from DV to VHS) .....	46
Normal Dubbing (from VHS to DV) .....	47
Edit From A Camcorder .....	48
Edit To Or From Another Video Recorder .....	50
Output/Input Set .....	52
Audio Dubbing .....	54
Insert Editing .....	56
Random Assemble Editing .....	58
<b>REMOTE CONTROL</b>	<b>60</b>
Remote Control Functions .....	60
<b>SYSTEM CONNECTIONS</b>	<b>63</b>
Connecting To A Printer .....	63
Connecting To A Satellite Receiver .....	64
Connecting/Using A Decoder .....	66
Connecting/Using A Stereo System .....	67
<b>SUBSIDIARY SETTINGS</b>	<b>68</b>
Mode Set .....	68
Tuner Set .....	74
Clock Set .....	80
SHOWVIEW <sup>®</sup> System Setup .....	82
<b>TROUBLESHOOTING</b>	<b>83</b>
<b>QUESTIONS AND ANSWERS</b>	<b>87</b>
<b>SPECIFICATIONS</b>	<b>88</b>
<b>LIST OF TERMS</b>	<b>89</b>

LPT0678-001B

# EN

# Safety Precautions

The rating plate and the safety caution are on the rear of the unit.

**WARNING: DANGEROUS VOLTAGE INSIDE**

**WARNING: TO PREVENT FIRE OR SHOCK HAZARD, DO NOT EXPOSE THIS UNIT TO RAIN OR MOISTURE.**

## CAUTION

- When you are not using the recorder for a long period of time, it is recommended that you disconnect the power cord from the mains outlet.
- Dangerous voltage inside. Refer internal servicing to qualified service personnel. To prevent electric shock or fire hazard, remove the power cord from the mains outlet prior to connecting or disconnecting any signal lead or aerial.

## WARNING

There are two different types of SECAM colour systems: SECAM-L, used in FRANCE (also called SECAM-West), and SECAM-B, used in Eastern European countries (also called SECAM-East).

1. This recorder can also receive SECAM-B colour television signals for recording and playback.
2. Recordings made of SECAM-B television signals produce monochrome pictures if played back on a video recorder of SECAM-L standard, or do not produce normal colour pictures if played back on a PAL video recorder with SECAM-B system incorporated (even if the TV set is SECAM-compatible).
3. SECAM-L prerecorded cassettes or recordings made with a SECAM-L video recorder produce monochrome pictures when played back with this recorder.
4. This recorder cannot be used for the SECAM-L standard. Use a SECAM-L recorder to record SECAM-L signals.

## IMPORTANT

- Please read the various precautions on pages 2 and 3 before installing or operating the recorder.
- It should be noted that it may be unlawful to re-record pre-recorded tapes, records, or discs without the consent of the owner of copyright in the sound or video recording, broadcast or cable programme and in any literary, dramatic, musical, or artistic work embodied therein.



- Cassettes marked "S-VHS" and "VHS" can be used with this video cassette recorder. However, S-VHS recordings are possible only with cassettes marked "S-VHS".  
By using the S-VHS ET function, it is possible to record and play back with S-VHS picture quality on VHS cassettes with this recorder.
- Cassettes marked "Mini DV" can be used with the DV deck of this recorder. The DV deck can play back and record only PAL signals.
- SHOWVIEW is a registered trademark of Gemstar Development Corporation. The SHOWVIEW system is manufactured under licence from Gemstar Development Corporation.

**For Italy:**

"It is declared that this product, brand JVC, conforms to the Ministry Decree n. 548 of 28 Aug.'95 published in the Official Gazette of the Italian Republic n. 301 of 28 Dec.'95"

The STANDBY/ON  $\cup/\text{I}$  button does not completely shut off mains power from the unit, but switches operating current on and off. " $\cup$ " shows electrical power standby and "I" shows ON.

Video tapes recorded with this video recorder in the LP (Long Play) mode cannot be played back on a single-speed video recorder.

When the equipment is installed in a cabinet or a shelf, make sure that it has sufficient space on all sides to allow for ventilation (10 cm or more on both sides, on top and at the rear.)

When discarding batteries, environmental problems must be considered and the local rules or laws governing the disposal of these batteries must be followed strictly.

**Failure to heed the following precautions may result in damage to the recorder, remote control or video cassette.**

**1. DO NOT place the recorder ...**

- ... in an environment prone to extreme temperatures or humidity.
- ... in direct sunlight.
- ... in a dusty environment.
- ... in an environment where strong magnetic fields are generated.
- ... on a surface that is unstable or subject to vibration.

**2. DO NOT block the recorder's ventilation openings or holes.**

(If the ventilation openings or holes are blocked by a newspaper or cloth, etc., the heat may not be able to get out.)

**3. DO NOT place heavy objects on the recorder or remote control.**

**4. DO NOT place anything which might spill on top of the recorder or remote control.**

(If water or liquid is allowed to enter this equipment, fire or electric shock may be caused.)

**5. DO NOT expose the apparatus to dripping or splashing.**

**6. DO NOT use this equipment in a bathroom or places with water. Also **DO NOT** place any containers filled with water or liquids (such as cosmetics or medicines, flower vases, potted plants, cups, etc.) on top of this unit.**

**7. DO NOT place any naked flame sources, such as lighted candles, on the apparatus.**

**8. AVOID violent shocks to the recorder during transport.**

**MOISTURE CONDENSATION**

Moisture in the air will condense on the recorder when you move it from a cold place to a warm place, or under extremely humid conditions—just as water droplets form in the surface of a glass filled with cold liquid. Moisture condensation on the head drum will cause damage to the tape. In conditions where condensation may occur, keep the recorder turned on for a few hours to let the moisture dry.

## FRONT VIEW

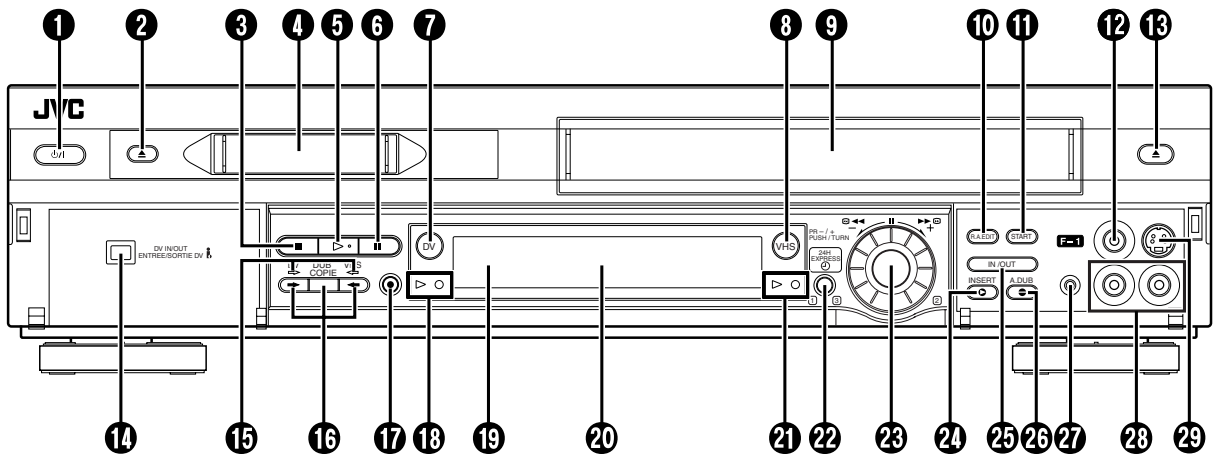

- ❶ STANDBY/ON  $\text{O/I}$  Button ☞ pg. 12
- ❷ DV Eject  $\blacktriangle$  Button ☞ pg. 30, 31
- ❸ Stop  $\blacksquare$  Button ☞ pg. 20, 21, 30, 31
- ❹ Mini DV Cassette Loading Slot
- ❺ Play  $\blacktriangleright$  Button ☞ pg. 20, 30
- ❻ Pause  $\text{II}$  Button ☞ pg. 21, 22, 31, 32
- ❼ DV Button ☞ pg. 30, 31
- ❽ VHS Button ☞ pg. 20, 21
- ❾ VHS Cassette Loading Slot
- ❿ Random Assemble Edit (R.A.EDIT) Button ☞ pg. 58
- ⓫ Random Assemble Edit START Button ☞ pg. 59
- ⓬ VIDEO Input Connector ☞ pg. 48, 56
- ⓭ VHS Eject  $\blacktriangle$  Button ☞ pg. 20, 21
- ⓮ DV IN/OUT connector (i.Link\*) ☞ pg. 48
- ⓯ Dubbing Direction (DV ⇌ VHS) Indicators ☞ pg. 44, 45
- ⓰ Dubbing (DUB) Button ☞ pg. 44, 45
- ⓱ Record  $\bullet$  Button ☞ pg. 21, 31
- ⓲ DV mode Indicators ☞ pg. 30, 31
- ⓳ Infrared Beam Receiving Window
- ⓴ Front Display Panel ☞ pg. 6
- ⓵ VHS mode Indicators ☞ pg. 20, 21
- ⓶ 24H EXPRESS  $\odot$  Button ☞ pg. 40
- ⓷ Advanced JOG Dial ☞ pg. 20, 30, 40
- ⓸ INSERT Button ☞ pg. 57
- ⓹ Random Assemble Edit IN/OUT Button ☞ pg. 58
- ⓺ Audio Dubbing (A.DUB) Button ☞ pg. 55
- ⓻ Remote PAUSE Connector ☞ pg. 48
- ⓼ AUDIO Input Connectors ☞ pg. 48, 54, 56
- ⓽ S-VIDEO Input Connector ☞ pg. 48, 56

\* i.Link refers to the IEEE1394-1995 industry specification and extensions thereof. The  $\text{IL}$  logo is used for products compliant with the i.Link standard.

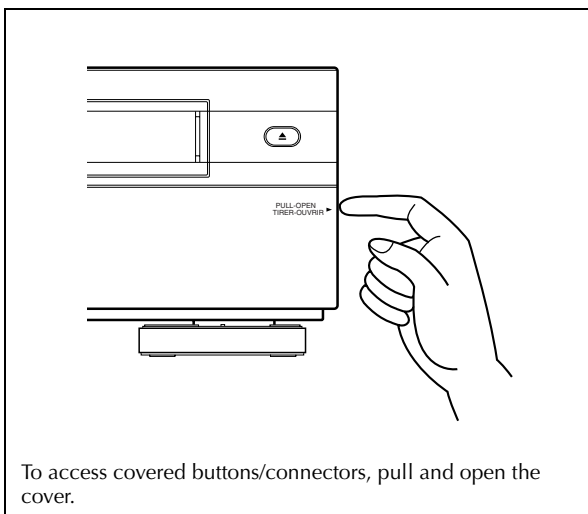

To access covered buttons/connectors, pull and open the cover.

## REAR VIEW

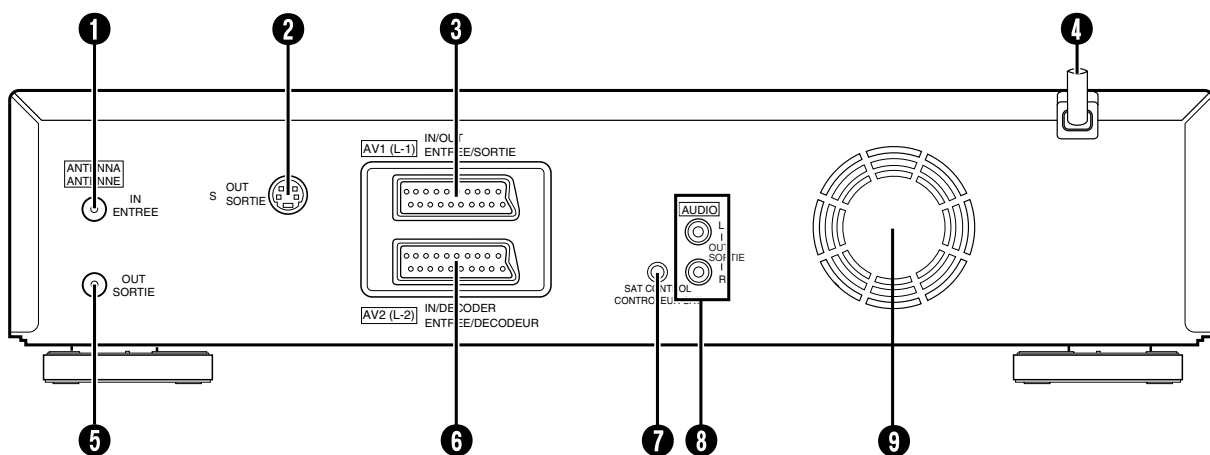

**1** ANTENNA IN Connector ☞ pg. 10

**2** S OUT Connector ☞ pg. 11

**3** AV1 (L-1) IN/OUT Connector  
☞ pg. 10, 50, 64, 65, 66

**4** Mains Power Cord ☞ pg. 10

**5** ANTENNA OUT Connector ☞ pg. 10

**6** AV2 (L-2) IN/DECODER Connector  
☞ pg. 17, 50, 64, 65, 66

**7** SAT CONTROL Connector ☞ pg. 17

**8** AUDIO OUT (L/R) Connectors ☞ pg. 67

**9** Cooling fan

- This prevents the temperature from rising inside the recorder. Do not remove it.
- Install the recorder so as not to block the area around the fan.
- The fan may be activated even if the recorder is turned off.

## FRONT DISPLAY PANEL

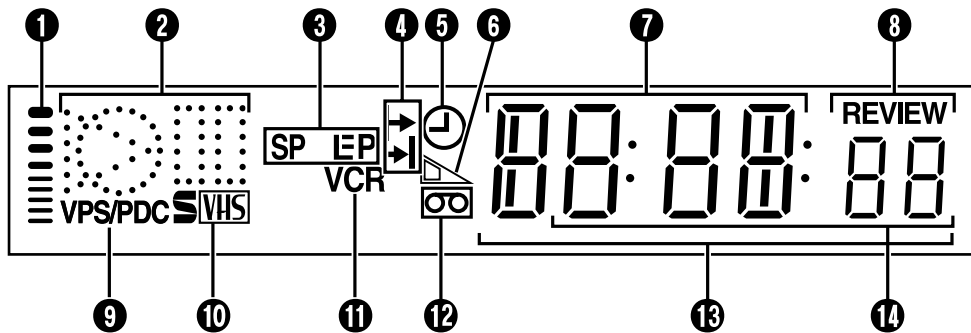

❶ B.E.S.T. Picture System Display (VHS deck only)  
☞ pg. 29

❷ Symbolic Mode Indicators

PLAY: FF/REW VARIABLE SEARCH:		STILL: SLOW:	
		RECORD:	
		RECORD PAUSE:	
AUDIO DUBBING:			
AUDIO DUBBING PAUSE:			
INSERT:			
INSERT PAUSE:			
AV INSERT:			
AV INSERT PAUSE:			

❸ Tape Speed Indicators ☞ pg. 21, 31

❹ Start Time Indicator (←) ☞ pg. 38, 40  
Stop Time Indicator (→) ☞ pg. 38, 40

❺ "Timer" Indicator ☞ pg. 37, 39, 40

❻ Tape Remaining Time Indicator (VHS deck only)  
☞ pg. 27

❼ Channel/Clock Display ☞ pg. 15

❽ Instant REVIEW Indicator (VHS deck only)  
☞ pg. 23

❾ VPS/PDC Indicator ☞ pg. 37, 39

❿ S-VHS Indicator (VHS deck only) ☞ pg. 71

⓫ VCR Indicator

⓬ "Cassette Loaded" Mark

⓭ Counter/Remain Display (VHS deck only)  
☞ pg. 27

⓮ Time Code Display (DV deck only) ☞ pg. 35

⓯ Mode Display (L-1, L-2, F-1 or SAT\*)

\* When "L-2 SELECT" is set to "SAT" (☞ pg. 53), "SAT" appears instead of "L-2".

## ON-SCREEN DISPLAY (for VHS deck)

When "O.S.D." is set to "ON" (☞ pg. 69), various operational indicators appear on the TV screen.

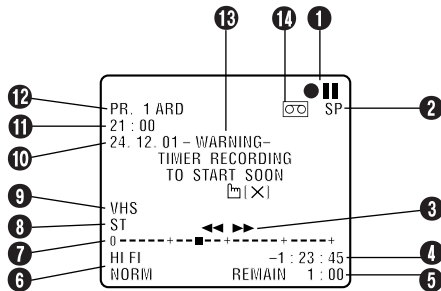

- 1 Operation Mode Indicators
- 2 Tape Speed SP/LP/EP  
\* EP is for NTSC playback only.
- 3 Tape Direction
- 4 Counter Display
- 5 Tape Remaining Time Indicator ☞ pg. 27
- 6 Audio Mode Display ☞ pg. 25

### 7 Tape Position Indicator

The tape position indicator appears on the TV screen when you press ◀◀ or ▶▶ from the Stop mode or perform an Index Search (☞ pg. 23). The position of "■" in relation to "0" (beginning) or "+" (end) shows you where you are on the tape.

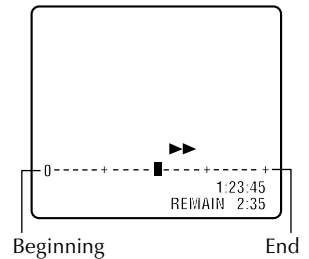

### NOTE:

Depending on the type of tape being used, the tape position indicator may not appear correctly.

- 8 Type of Broadcast ☞ pg. 28
- 9 VHS Indicator
- 10 Current Day/Month/Year
- 11 Clock Display
- 12 Channel Position Number and Station Name/  
Auxiliary Input Indicator (L-1, L-2, F-1 or SAT\*)  
\* When "L-2 SELECT" is set to "SAT" (☞ pg. 53), "SAT" appears instead of "L-2".

Dubbing Direction Indicators  
(DV → VHS) ☞ pg. 45

### 13 Timer Warning Display

A warning appears on the TV screen to tell you that the timer recording is to start in 5 minutes if you're not in the Timer mode at that time. The warning blinks for the entire 5 minutes leading up to the start of timer recording. To clear the display, press X on the remote control.

### 14 "Cassette Loaded" Mark

## ON-SCREEN DISPLAY (for DV deck)

When "O.S.D." is set to "ON" (☞ pg. 69), various operational indicators appear on the TV screen.

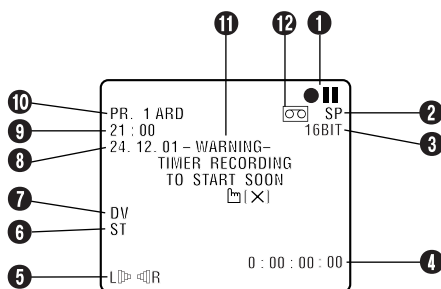

- 1 Operation Mode Indicators
- 2 Tape Speed SP/LP
- 3 Sound Mode Display ☞ pg. 73
- 4 Time Code Display ☞ pg. 35, 73

- 5 Audio Mode Display ☞ pg. 33
- 6 Type of Broadcast ☞ pg. 35
- 7 DV Indicator
- 8 Current Day/Month/Year
- 9 Clock Display
- 10 Channel Position Number and Station Name/  
Auxiliary Input Indicator (L-1, L-2, F-1 or SAT\*)  
\* When "L-2 SELECT" is set to "SAT" (☞ pg. 53), "SAT" appears instead of "L-2".

Dubbing Direction Indicators  
(VHS → DV) ☞ pg. 44

### 11 Timer Warning Display

A warning appears on the TV screen to tell you that the timer recording is to start in 5 minutes if you're not in the Timer mode at that time. The warning blinks for the entire 5 minutes leading up to the start of timer recording. To clear the display, press X on the remote control.

### ERROR Indicator\*

\* ERROR indicator appears when you start dubbing a tape with a copy protection signals or when Audio Dubbing or Insert Editing is not possible depending on the condition.

### 12 "Cassette Loaded" Mark

## REMOTE CONTROL

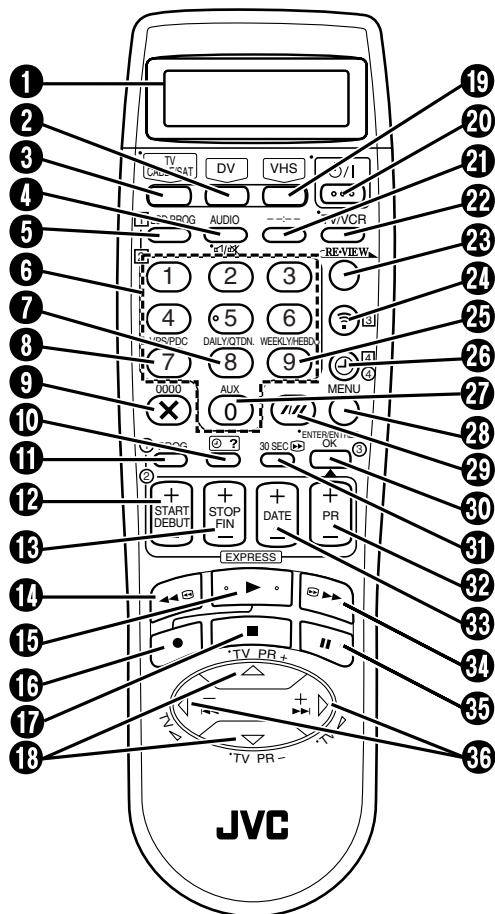

Buttons with a small dot on the left side of the name can also be used to operate your TV. (☞ pg. 61)

- ❶ LCD Panel ☞ pg. 36
- ❷ DV Button ☞ pg. 30, 31
- ❸ TV/CABLE/SAT Button ☞ pg. 61, 62
- ❹ AUDIO Button ☞ pg. 25, 33  
⏸ (TV Muting) Button ☞ pg. 61
- ❺ LCD PROG Button ☞ pg. 36
- ❻ Number Keys ☞ pg. 21, 31, 36
- ❼ DAILY Button ☞ pg. 37, 39
- ❽ VPS/PDC Button ☞ pg. 37, 39
- ❾ Counter Reset 0000 Button ☞ pg. 27  
Cancel X Button ☞ pg. 42
- ❿ Programme Check ⊕ ? Button ☞ pg. 42
- ⓫ PROG Button ☞ pg. 38
- ⓬ START +/- Button ☞ pg. 38
- ⓭ STOP +/- Button ☞ pg. 38
- ⓮ Rewind ◀◀ Button ☞ pg. 20, 30
- ⓯ Play ▶▶ Button ☞ pg. 20, 30
- ⓰ Record ● Button ☞ pg. 21, 31
- ⓱ Stop ■ Button ☞ pg. 20, 30
- ⓲ △ ▽ Button ☞ pg. 12  
TV PR +/- Button ☞ pg. 61
- ⓳ VHS Button ☞ pg. 20, 21
- ⓴ STANDBY/ON ⏻/⏿ Button ☞ pg. 12
- ⓵ Display --:-- Button ☞ pg. 27
- ⓶ TV/VCR Button ☞ pg. 61
- ⓷ REVIEW Button ☞ pg. 23
- ⓸ Transmit ☎ Button ☞ pg. 36
- ⓹ WEEKLY Button ☞ pg. 37, 39
- ⓺ Timer ⊖ Button ☞ pg. 37, 39
- ⓻ AUX Button ☞ pg. 48
- ⓼ MENU Button ☞ pg. 16
- ⓽ Auto Tracking ⚡ Button ☞ pg. 25  
SP/LP Button ☞ pg. 21, 31
- ⓿ OK Button ☞ pg. 13
- ⓾ 30 SEC Button ☞ pg. 23
- ⓿ PR +/- Button ☞ pg. 21, 31
- ⓿ DATE +/- Button ☞ pg. 39
- ⓿ Fast Forward ▶▶▶▶ Button ☞ pg. 20, 30
- ⓿ Pause || Button ☞ pg. 21, 31
- ⓿ ◀▶ Button ☞ pg. 22, 23  
TV ◀ +/- Button ☞ pg. 61



## How To Use

The remote control can operate most of your video recorder's functions, as well as basic functions of TV sets and satellite receivers of JVC and other brands. (☞ pg. 61, 62)

- Point the remote control toward the receiving window.
- The maximum operating distance of the remote control is about 8 m.

### NOTES:

- When inserting the batteries, be sure to insert in the correct directions as indicated under the battery cover.
- If the remote control doesn't work properly, remove its batteries, wait a short time, replace the batteries and then try again.

## Remote Control LCD

The remote control can operate not only the video recorder but also some of your TV and satellite receiver's functions. The LCD indicates which of these (VIDEO, TV or CABLE/SAT) the remote control can currently operate. When you first purchase the remote control, or after you have just replaced the batteries, VIDEO A (A code) is selected.

- 1 To operate your video recorder, first press the **VHS** or **DV**. To switch the remote control's A/B/C/D code, refer to page 60.



- 2 To operate your TV, first press **TV/CABLE/SAT** until "TV" appears on the LCD. (☞ pg. 61)



- 3 To operate your satellite receiver, first press **TV/CABLE/SAT** until "CABLE SAT" appears on the LCD. (☞ pg. 62)

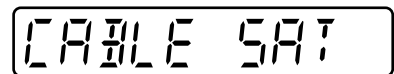

### NOTES:

Even if "TV" is displayed on the LCD, the following operations can be performed without switching the mode.

- Basic operations for the recorder  
After an operation is completed, "TV" reappears on the LCD.
- Express timer programming and SHOWVIEW timer programming operations  
To perform a TV operation again, switch to TV mode first.
- Accessing main menu  
To perform a TV operation again, switch to TV mode first.

# Basic Connections

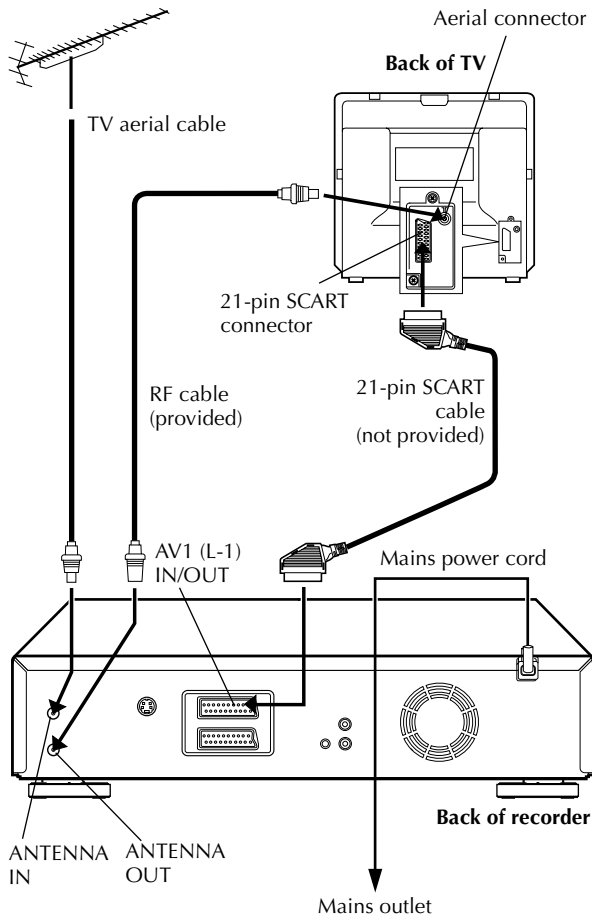

## ATTENTION:

Your TV must have a 21-pin AV input connector (SCART) for the connection to the recorder.

It's essential that your video recorder be properly connected.

THESE STEPS MUST BE COMPLETED BEFORE ANY VIDEO OPERATION CAN BE PERFORMED.

## 1 Check the contents.

Make sure the package contains all of the accessories listed in "SPECIFICATIONS" on page 88.

## 2 Situate the recorder.

Place the recorder on a stable, horizontal surface.

## 3 Connect the recorder to TV.

- 1 Disconnect the TV aerial cable from the TV.
  - 2 Connect the TV aerial cable to the ANTENNA IN connector on the rear panel of the recorder.
  - 3 Connect the provided RF cable between the ANTENNA OUT connector on the rear panel of the recorder and the TV's aerial connector.
  - 4 Connect the 21-pin SCART cable between the AV1 (L-1) IN/OUT connector on the rear panel of the recorder and the TV's 21-pin SCART connector.
- The AV1 (L-1) IN/OUT connector accepts and delivers either a composite signal (regular video signal) or a Y/C signal (a signal in which the luminance and chrominance signals are separated). If your TV's 21-pin AV input connector (SCART) is compatible with the Y/C signal, set "L-1 OUTPUT" to "S-VIDEO" after the connection and the initial settings are completed (pg. 52). You can obtain high-quality S-VHS pictures. (For connection, be sure to use a 21-pin SCART cable that is compatible with the Y/C signal.)
  - Set your TV to the VIDEO (or AV), Y/C, or RGB mode according to the type of your TV's SCART connector.
  - For switching the TV's mode, refer to the instruction manual of your television.
  - To obtain high-quality S-VHS pictures, you can also use the S-VIDEO connection described on page 11.

## 4 Connect the recorder to mains.

Plug the end of the mains power cord into a mains outlet.

After the connection is completed, perform "Auto Set Up" on page 12.

# S-VIDEO Connection

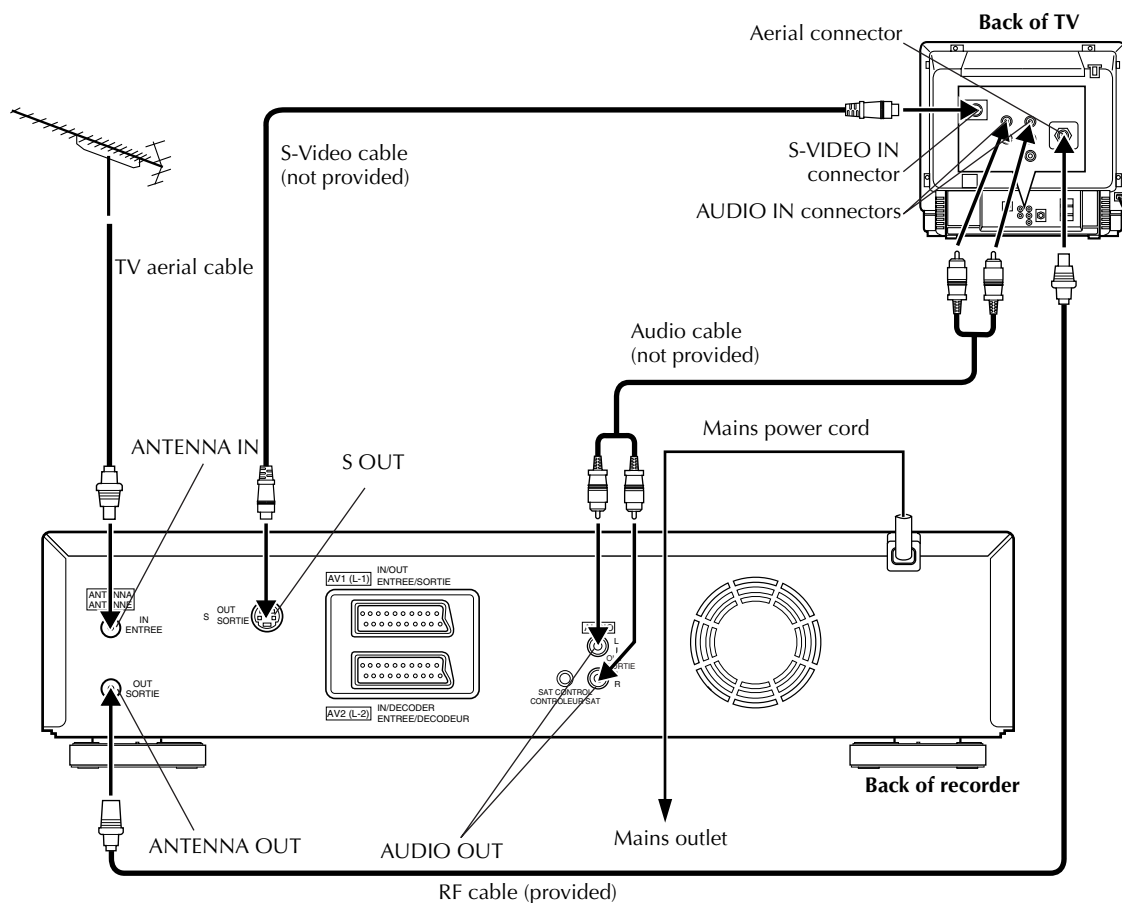

## ■ To connect to a TV with S-VIDEO/AUDIO IN connectors . . .

### 1 Connect the recorder to TV.

- 1 Connect the aerial, recorder and TV as per "Basic Connections" (☞ pg. 10).
- 2 Connect the recorder's S OUT connector to the TV's S-VIDEO IN connector.
- 3 Connect the recorder's AUDIO OUT connectors to the TV's AUDIO IN connectors.

### 2 Connect the recorder to mains.

Plug the end of the mains power cord into a mains outlet.

## NOTES:

- You can obtain high-quality S-VHS pictures.
- With S-VIDEO connection, you cannot use the Preset Download function (☞ pg. 14).
- If your TV is not stereo-capable, use the recorder's AUDIO OUT connectors to connect to an audio amplifier for Hi-Fi stereo sound reproduction. (☞ pg. 67)
- To operate the recorder with your TV using the S-VIDEO connection, set your TV to its AV mode.
- For switching the TV's mode, refer to the instruction manual of your television.

After the connection is completed, perform "Auto Set Up" on page 12.

# Auto Set Up

## Auto Channel Set/Auto Clock Set/ Auto Guide Program Number Set

After the  $\psi/1$  button on the recorder or remote control is pressed for the first time to power on the recorder, by simply selecting your country\*, the Auto Set Up function sets the tuner channels, clock\*\* and Guide Program numbers automatically.

\* If you live in Belgium (BELGIUM) or Switzerland (SUISSE), you also need to select your language.

\*\* If you live in Hungary (MAGYARORSZÁG), Czech Republic (ČESKÁ REPUBLIKA), Poland (POLSKA) or other countries in Eastern Europe (OTHER EASTERN EUROPE), set the clock manually.

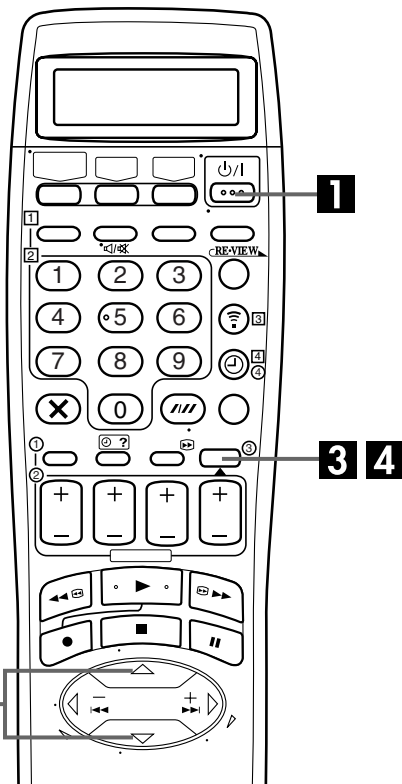

### Before starting, make sure of the following:

- The TV aerial cable should be connected to the recorder.
- The recorder's mains power cord should be connected to a mains outlet.
- If you want to use the on-screen display, the TV should be set to its AV mode.

## 1 Turn on the recorder.

Press  $\psi/1$  on the recorder or remote control. The Country Set display appears on the front display panel and/or on the TV screen.

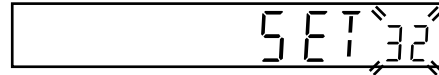

## 2 Select your country.

### On the front display panel

Press  $\Delta/\nabla$  to select your international telephone country code of your country referring to the chart in the left column.

(Example) DEUTSCHLAND (49) is selected.



### On the on-screen display

Press  $\Delta/\nabla$  to move the highlight bar (pointer) to your country's name.



## NOTES:

- If you have selected BELGIUM (32) or SUISSE (41), go to step 3.
- If you have selected MAGYARORSZÁG (36), ČESKÁ REPUBLIKA (42), POLSKA (48) or OTHER EASTERN EUROPE (EE), press **OK**. The Clock Set screen appears. Set the clock manually (pg. 80), then go to step 4.
- If you have selected any other country name (code), press **OK** and go to step 4.

### International Telephone Country Code

BELGIUM	: 32	NORGE	: 47
ČESKÁ REPUBLIKA	: 42	ÖSTERREICH	: 43
DANMARK	: 45	POLSKA	: 48
DEUTSCHLAND	: 49	PORTUGAL	: 351
ESPAÑA	: 34	SUISSE	: 41
GREECE	: 30	SUOMI	: 358
ITALIA	: 39	SVERIGE	: 46
MAGYARORSZÁG	: 36	OTHER WESTERN EUROPE	: --
NEDERLAND	: 31	OTHER EASTERN EUROPE	: EE

### 3 Select the language.

Press **OK**. The Language Set display appears on the front display panel and/or on the TV screen.

#### On the front display panel

Press  $\Delta$ / $\nabla$  to select your language code.

Language Code			
ENGLISH	: 01	NEDERLANDS	: 06
DEUTSCH	: 02	SVENSKA	: 07
FRANCAIS	: 03	NORSK	: 08
ITALIANO	: 04	SUOMI	: 09
CASTELLANO	: 05	DANSK	: 10

(Example) DEUTSCH (02) is selected for SUISSE (41).

International telephone  
country code                      Language code



#### On the on-screen display

Press  $\Delta$ / $\nabla$  to move the highlight bar (pointer) to the language of your choice.



### 4 Perform Auto Set Up.

Press **OK**. The AUTO SET/T-V LINK display appears on the front display panel and/or on the TV screen.

#### On the front display panel

Press  $\Delta$ / $\nabla$  to select "Auto" and press **OK** or  $\triangleright$ .

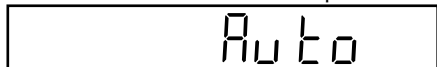

#### On the on-screen display

Press  $\Delta$ / $\nabla$  to move the highlight bar (pointer) to "AUTO SET" and press **OK** or  $\triangleright$ .



"Auto" blinks on the front display panel; do NOT press any button on the recorder or remote control until the front display panel shows clock time, "(CH) 1" or "--:--" as illustrated on page 15.

- If you are using the on-screen display, the AUTO SET screen will appear. As Auto Set Up progresses, the "■" mark on the TV screen moves from left to right. When the Auto Set Up is completed, "SCAN COMPLETED" appears for about 5 seconds, then the normal screen appears.

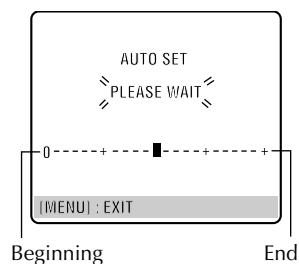

- When you have connected the video recorder to a TV offering T-V Link via a fully-wired 21-pin SCART cable (☞ pg. 10) and the TV is turned on, the recorder automatically performs the Preset Download (☞ pg. 14) even if you select "Auto" for Auto Set Up function.

### ATTENTION

Once you have performed Auto Set Up, even if the recorder's memory backup has expired, all the stored stations and their Guide Program numbers remain in the recorder's memory and the recorder will not perform Auto Set Up again. You only need to set the clock. (☞ pg. 80)

If you have moved to a different area, perform each setting as required.

- Tuner setting ☞ pg. 74
- Clock setting ☞ pg. 80

If a new station starts broadcasting in your area, perform tuner setting (☞ pg. 74).

### NOTES:

- In the area where no TV station transmits a PDC (Programme Delivery Control) signal, the recorder can perform neither Auto Clock Set nor Auto Guide Program Number Set.
- If there is a power cut, or if you press  $\Psi$ /1 or **MENU** while Auto Set Up is in progress, Auto Set Up will be interrupted; be sure to turn off the recorder power once and try again from step 1.
- Auto Clock Set may not function properly depending on the reception condition.
- If no sound accompanies the picture or the audio sounds unnatural on some channels that have been stored by Auto Set Up, the TV system setting for those channels may be incorrect. Select the appropriate TV system for those channels (☞ pg. 77, "INFORMATION").

# Preset Download

## Auto Channel Set by Downloading from TV/Auto Clock Set/Auto Guide Program Number Set

### ATTENTION

You can use this function only with a TV offering T-V Link, etc.\* Be sure to use a fully-wired 21-pin SCART cable.

\* Compatible with TVs offering T-V Link, EasyLink, Megalocic, SMARTLINK, Q-Link, DATA LOGIC or NexTVView Link via fully-wired 21-pin SCART cable. The degree of compatibility and available functions may differ by system.

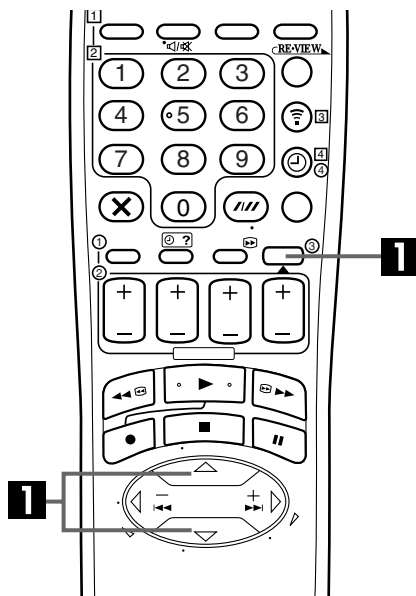

### NOTES:

- For details, refer to the instruction manual of your TV.
- In the area where no TV station transmits a PDC (Programme Delivery Control) signal, the recorder can perform neither Auto Clock Set nor Auto Guide Program Number Set.
- If there is a power cut, or if you press  $\psi$  or **MENU** while downloading or set up is in progress, it will be interrupted; be sure to turn off the recorder power once and try again from the beginning.
- Auto Clock Set may not function properly depending on the reception condition.
- On this recorder, the characters available for station names (ID) are A-Z, 0-9, -, \*, + and \_ (space). Some names of downloaded stations may differ from those of your TV (pg. 78).

If you have connected the recorder to your TV via a 21-pin SCART cable (pg. 10), the recorder will automatically perform Preset Download instead of the Auto Set Up in step 4 on page 13. After downloading, the recorder sets the clock and Guide Program numbers automatically.

Perform steps 1 to 3 of "Auto Set Up" on page 12 before continuing.

### 1 Perform Preset Download.

Press **OK**. The AUTO SET/T-V LINK display appears on the front display panel and/or on the TV screen.

#### On the front display panel

Press  $\triangle$ / $\nabla$  to select "CH --" and press **OK** or  $\triangleright$ .

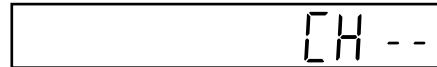

#### On the on-screen display

Press  $\triangle$ / $\nabla$  to move the highlight bar (pointer) to "T-V LINK" and press **OK** or  $\triangleright$ .

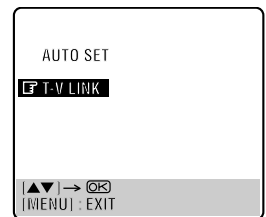

Preset positions on the front display panel increase from "CH1"; do NOT press any button on the recorder or remote control until the front display panel shows clock time, "(CH) 1" or "--:--" as illustrated on page 15.

- If you are using the on-screen display, the T-V LINK screen will appear. Then the GUIDE PROG SET screen will appear during Guide Program Number Set. When Preset Download is completed, "COMPLETED" appears for about 5 seconds, then the normal screen appears.
- If you press any button on the recorder or remote control while downloading is in progress, it will be interrupted.

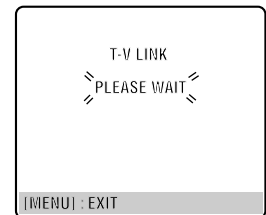

## Results of Auto Set Up/Preset Download appear on the front display panel

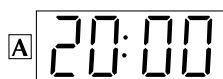

**If both Auto Channel Set and Auto Clock Set have been performed successfully, the correct current time is displayed.**

Turn on the TV and select its AV mode, then make sure that all necessary stations have been stored in the recorder's memory by using the **PR** button(s).

- If station names (ID –  pg. 79) have also been stored in the recorder's memory, the station name will be displayed at the top left corner of the TV screen for about 5 seconds when the recorder is tuned to a different station.
- If you want to set the tuner manually such as to add or skip channels, to change channel positions, or to set or change station names, see pages 76 – 79.



**If Auto Channel Set has succeeded but Auto Clock Set has not, “1” (channel position) is displayed.**

**1** Turn on the TV and select its AV mode, then make sure that all necessary stations have been stored in the recorder's memory by using the **PR** button(s).

- If station names (ID –  pg. 79) have also been stored in the recorder's memory, the station name will be displayed at the top left corner of the TV screen for about 5 seconds when the recorder is tuned to a different station.
- If you want to set the tuner manually such as to add or skip channels, to change channel positions, or to set or change station names, see pages 76 – 79.

**2** Perform “Clock Set” on page 80.

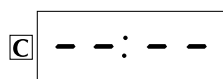



**If both Auto Channel Set and Auto Clock Set have failed, “- -: -” is displayed.**

Make sure the cables are connected properly and turn off the recorder's power once, then turn the recorder's power back on again.

The Country Set display appears on the front display panel and/or on the TV screen; perform “Auto Set Up” on page 12 or “Preset Download” on page 14 again.

### IMPORTANT

- To check if the Guide Program numbers have been set correctly, perform the SHOWVIEW Timer Programming ( pg. 36).
- In certain reception conditions, station names may not be stored correctly, and auto Guide Program Number Set may not work properly. If the Guide Program numbers are not set properly when you timer-record a TV programme using the SHOWVIEW system, the recorder will record a TV programme of a different station. When programming the timer using the SHOWVIEW system, be sure to check the desired channel is selected correctly ( pg. 36, “SHOWVIEW” Timer Programming”).
- Your video recorder memorizes all detected stations even if reception of some of them is poor. You can delete those stations with an unacceptable picture ( pg. 77, “Delete A Channel”).

### INFORMATION

#### Language for the on-screen display

Auto Set Up also selects the language automatically for the on-screen display depending on the Country setting you have made in step 2 on page 12 (unless you have selected BELGIUM or SUISSE), as shown below.

SUOMI	→ SUOMI	DANMARK	→ DANSK	NEDERLAND	→ NEDERLANDS
PORTUGAL	→ ENGLISH	ÖSTERREICH	→ DEUTSCH	GREECE	→ ENGLISH
DEUTSCHLAND	→ DEUTSCH	ČESKÁ REPUBLIKA	→ ENGLISH	OTHER WESTERN EUROPE	→ ENGLISH
POLSKA	→ ENGLISH	ITALIA	→ ITALIANO	OTHER EASTERN EUROPE	→ ENGLISH
NORGE	→ NORSK	MAGYARORSZÁG	→ ENGLISH		
SVERIGE	→ SVENSKA	ESPAÑA	→ CASTELLANO		

If you want to change the language setting manually, see “Language” on page 16.

#### Just Clock

Your recorder is equipped with the Just Clock function which provides accurate time keeping through automatic adjustments at regular intervals, by reading data from a PDC signal. If you want to take advantage of this function, simply set it to “ON” ( pg. 80, “Just Clock”).

# Language

Turn on the TV and select the AV mode.

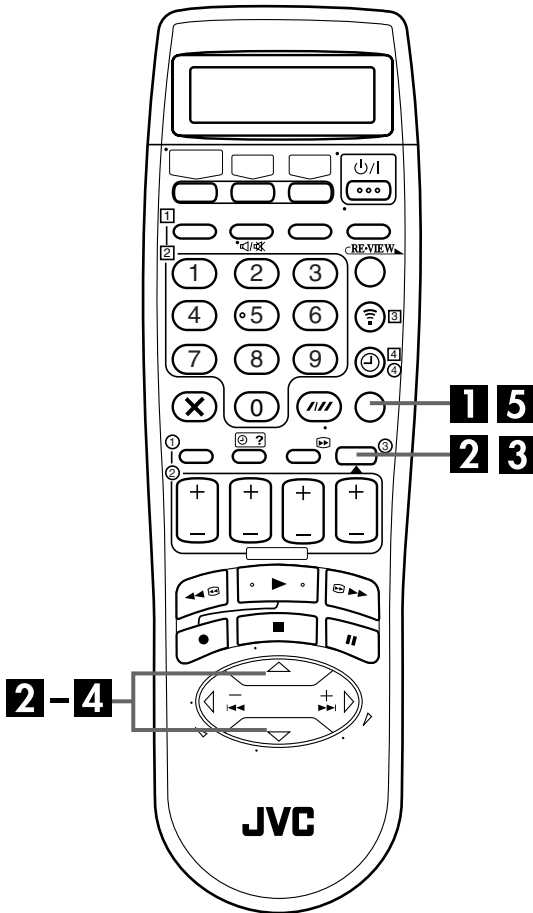

## 1 Access the Main Menu screen.

Press MENU.

## 2 Access the Country Set screen.

Press  $\Delta$ / $\nabla$  to move the highlight bar (pointer) to "AUTO CH SET", then press **OK** or  $\triangleright$ .

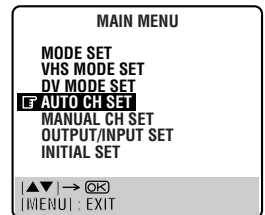

## 3 Select your country.

Press  $\Delta$ / $\nabla$  to move the highlight bar (pointer) to your country's name, then press **OK** or  $\triangleright$ .

## 4 Select the language.

Press  $\Delta$ / $\nabla$  to move the highlight bar (pointer) to the language of your choice.

- You do not have to press **OK**; pressing **OK** enters AUTO SET/T-V LINK screen.



## 5 Return to the normal screen.

Press MENU.



# Satellite Receiver Control Setting

The following procedure is required if you receive satellite channels through a satellite receiver. Approximately 20 seconds before the SHOWVIEW timer programming (☞ pg. 36) or Express timer programming (☞ pg. 38) starts, the recorder sets its input mode to "L-2" and automatically switches the satellite receiver's channels using the provided Satellite Controller.

## Installing Satellite Controller

### 1 Situate the Satellite Controller.

Place the Satellite Controller so that the path between its transmitter and the satellite receiver's remote sensor is unobstructed.

### 2 Attach the Satellite Controller.

Fix securely using the adhesive strip attached on the back of the Satellite Controller.

### 3 Make connections.

Be sure to connect the recorder's AV2 (L-2) IN/DECODER connector to the satellite receiver's 21-pin SCART connector.

#### NOTE:

When connecting your satellite receiver, refer to its instruction manual.

### 4 Connect the Satellite Controller to recorder.

Connect the Satellite Controller to the SAT CONTROL connector on the rear panel.

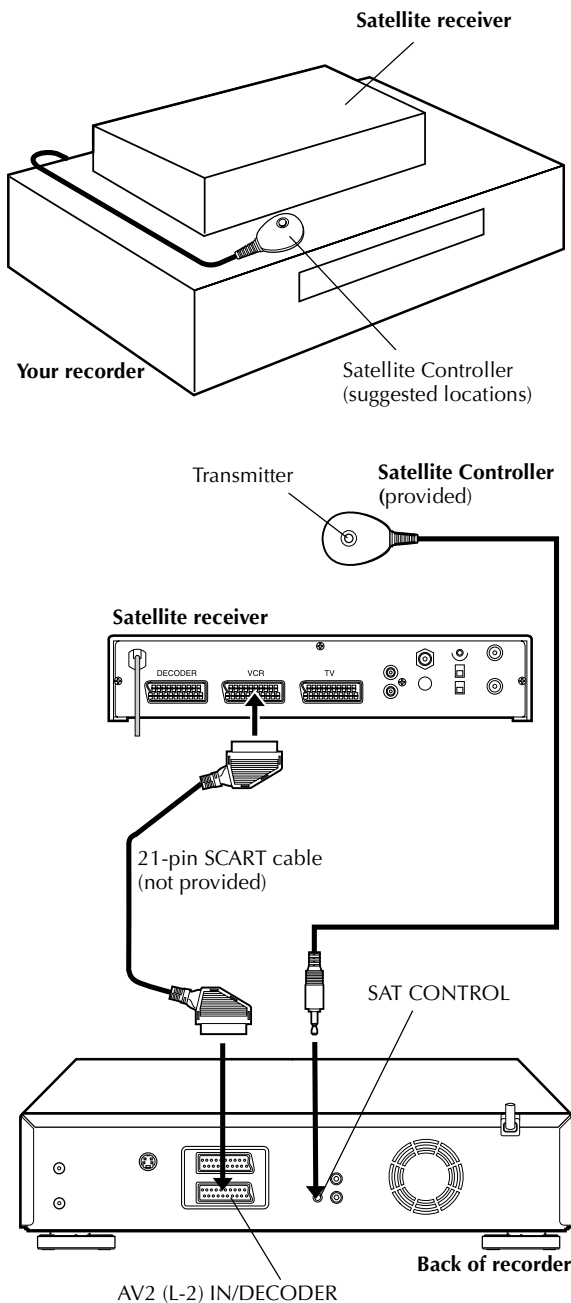

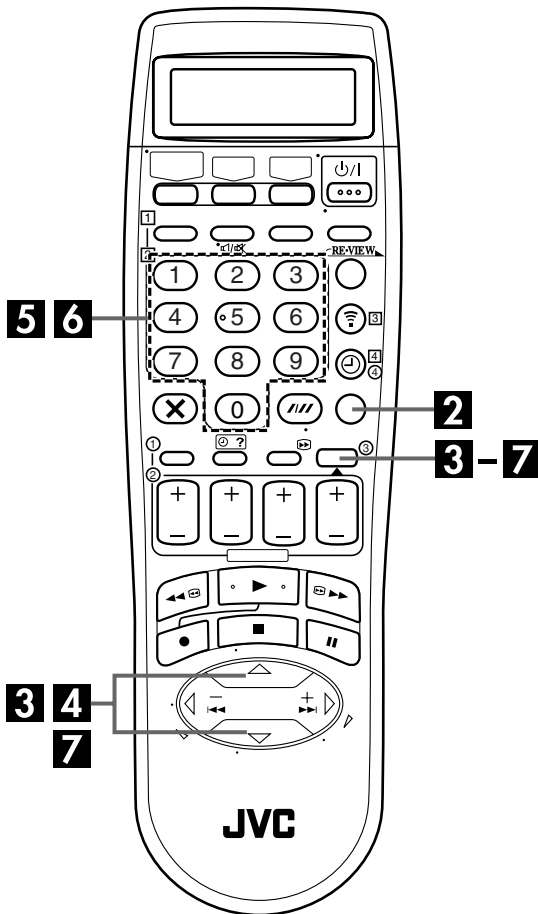

## Setting satellite receiver's brand and channel

After installation, set the satellite receiver's brand and channel correctly; otherwise, the Satellite Controller cannot work correctly.

Turn on the TV and select the AV mode.

### 1 Turn on the satellite receiver.

Turn on the satellite receiver's power.

### 2 Access the Main Menu screen on the recorder.

Press **MENU**.

### 3 Access the Initial Set screen.

Press  $\Delta$ / $\nabla$  to move the highlight bar (pointer) to "INITIAL SET", then press **OK** or  $\triangleright$ .

### 4 Access the Sat Control Set screen.

Press  $\Delta$ / $\nabla$  to move the highlight bar (pointer) to "SAT CONTROL SET", then press **OK** or  $\triangleright$ .

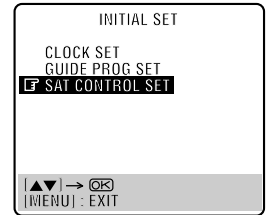

### 5 Enter the satellite receiver's brand.

Press the appropriate **number keys** to enter the brand code from the list on page 19, then press **OK**.

- If the brand code you entered is invalid, the code field will be reset. Enter the correct brand code again.
- If the recorder is in playback or recording mode, you cannot set the brand code.

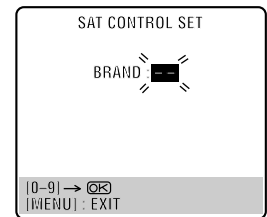

### 6 Select the satellite receiver's channel for testing.

Press the appropriate **number keys** to enter one of the channel positions on the satellite receiver, then press **OK**.

- You can select the channel position between 1 to 999.
- After pressing **OK**, the recorder enters the Test mode.

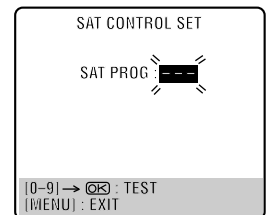

## 7 Check the result of the test.

If the satellite receiver's channel number has been changed to the same one as you set in step 6 ...

Press  $\Delta$ / $\nabla$  to move the highlight bar (pointer) to "CHANGED TO ...", then press **OK** or  $\triangleright$  to finish the Sat Control Set mode.

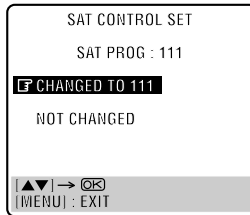

If the satellite receiver's channel number has not been changed correctly ...

Press  $\Delta$ / $\nabla$  to move the highlight bar (pointer) to "NOT CHANGED", then press **OK** or  $\triangleright$ . Then perform the procedure again from step 5.

BRAND NAME	CODE
JVC	73
AMSTRAD	60, 61, 62, 63, 92
CANAL SATELLITE	81
CANAL +	81
D-BOX	85
ECHOSTAR	78, 79, 80
ECHOSTAR (VIA DIGITAL)	82
FINLUX	68
FORCE	89
GALAXIS	88
GRUNDIG	64, 65
HIRSCHMANN	64, 78, 99
ITT NOKIA	68
JERROLD	75
KATHREIN	70, 71, 96
LUXOR	68
MASCOM	93
MASPRO	70
NOKIA	87, 94
PACE	65, 67, 74, 86, 92
PANASONIC	74, 92
PHILIPS	66, 84
RFT	69
SABA	97
SAGEM	83, 90
SALORA	68
SIEMENS	64
SKYMASTER	69, 98
THOMSON	97
TPS	83
TRIAx	91
WISI	64

### NOTES:

- The Satellite Controller may not work with all types of satellite receiver.
- For some satellite receivers, you need to set its channel input mode to 2-digit.
- If your satellite receiver has more than two channel modes, be sure to set to "All Channel Mode". For details, refer to the instruction manual of the satellite receiver.
- When selecting the satellite receiver's channel (☞ step 6), signals from the remote control may interfere with signals transmitted from the Satellite Controller. In this case, move the remote control as close to the recorder's infrared beam receiving window as possible.

# T-V Link Functions

When you connect the recorder to your TV via a fully-wired 21-pin SCART cable (☞ pg. 10), the following functions are available. You can use these functions only with a TV offering T-V Link, etc.\*

For details, refer to the instruction manual of your TV.

\* Compatible with TVs offering T-V Link, EasyLink, Megalogic, SMARTLINK, Q-Link, DATA LOGIC or NexTVView Link via fully-wired 21-pin SCART cable. The degree of compatibility and available functions may differ by system.

## NexTVView Link

You can download the EPG (Electronic Programme Guide) information from your TV for timer-programming on the recorder.

For details, refer to the instruction manual of your TV.

## TV Auto Power On

The TV will turn on and be set to its AV mode automatically whenever you play a tape.

For details, refer to the instruction manual of your TV.

## VCR Auto Standby

You can use your TV's remote control to turn off the recorder. For details, refer to the instruction manual of your TV.

## Direct Rec

You can easily start recording the programme that you are watching on your TV. When you use this function, set "DIRECT REC" to "ON" (☞ pg. 69).

# Basic Playback

(VHS deck)

Turn on the TV and select the AV mode.

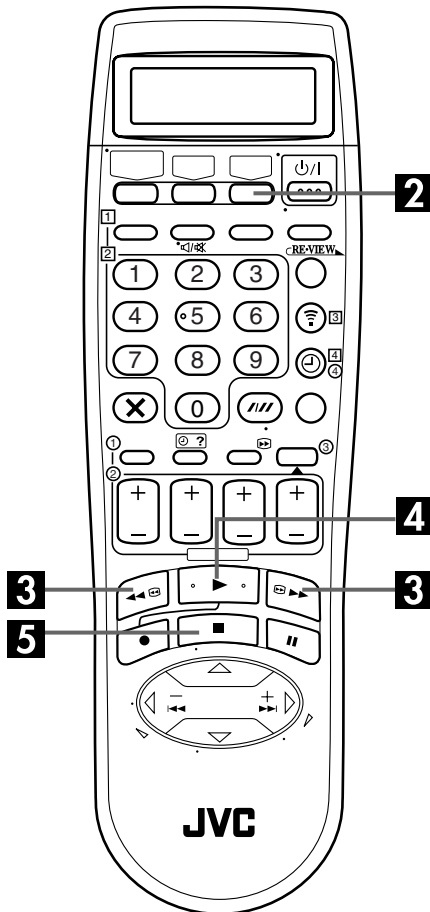
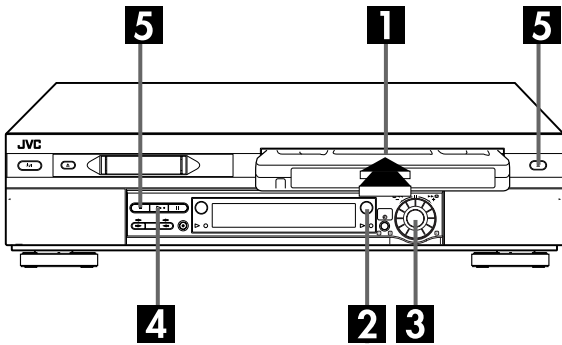

## 1 Load a cassette.

Make sure the window side is up, the rear label side is facing you and the arrow on the front of the cassette is pointed toward the recorder.

- Do not apply too much pressure when inserting.
- The recorder's power comes on automatically.
- If the record safety tab has been removed, playback begins automatically.
- Make sure the VCR indicator appears on the front display panel. If not, press **TV/VCR** on the remote control to turn on the VCR indicator.

## 2 Select the VHS deck.

Press **VHS**.

- The VHS button lights on the recorder.

## 3 Find the programme start point.

If the tape is advanced past the start point, press ◀◀ or turn the **JOG** dial to the left. To go forward, press ▶▶ or turn the **JOG** dial to the right.

## 4 Start playback.

Press ▶. "BEST" appears blinking in the recorder's front display panel during automatic tracking. (pg. 29)

- The VHS playback indicator lights on the recorder.

## 5 Stop playback.

Press ■. Then press ▲ to remove the cassette.

- The VHS playback indicator turns off.

### NOTE:

*It is impossible to play back a tape on the VHS deck while the recording is in progress on the DV deck. When you start recording on the DV deck during playback on the VHS deck, playback stops on the VHS deck and recording continues on the DV deck.*

### Usable cassettes

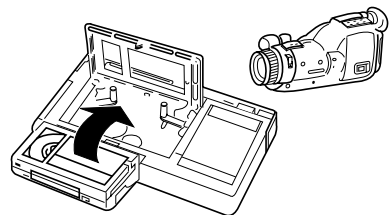

- Compact VHS camcorder recordings can be played on this video recorder. Simply place the recorded cassette into a VHS Cassette Adapter and it can be used just like any full-sized VHS cassette.
- This video recorder can record on regular VHS and Super VHS cassettes. While only VHS signals can be recorded on regular VHS cassettes\*, both VHS and Super VHS signals can be recorded and played back using Super VHS cassettes.

\* By using the S-VHS ET function, it is possible to record and play back with S-VHS picture quality on VHS cassettes with this recorder.

# Basic Recording

## (VHS deck)

Turn on the TV and select the AV mode.

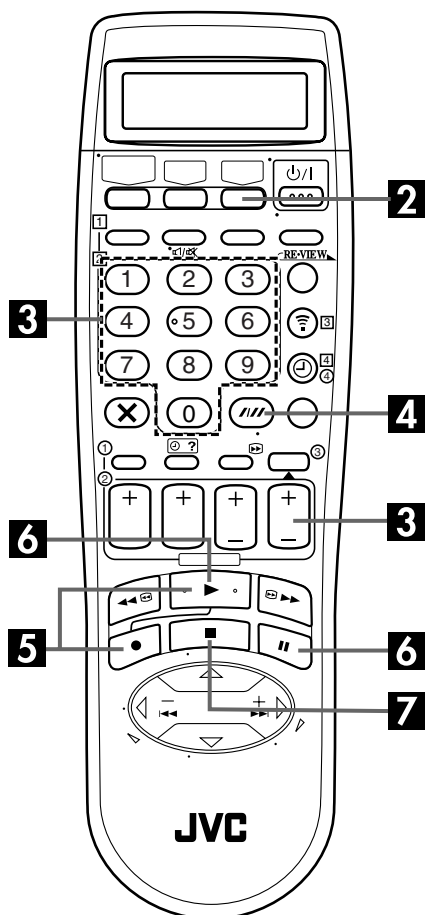
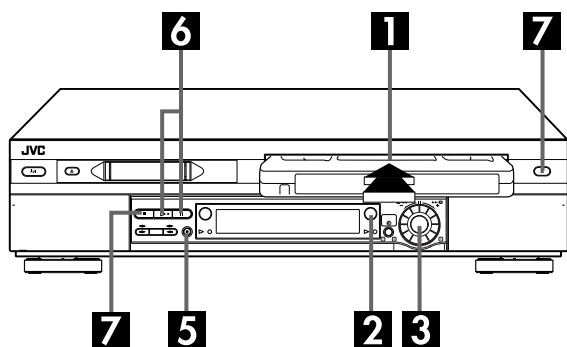

### 1 Load a cassette.

Insert a VHS (or S-VHS) cassette with the record safety tab intact.

- The recorder's power comes on automatically.

### 2 Select the VHS deck.

Press **VHS**.

- The VHS button lights on the recorder.

### 3 Choose a programme.

Press **PR +/-** or the **number keys**. Or push the **JOG** dial and turn it to the left or right to select the channel you wish to record.

### 4 Set the tape speed.

Press **SP/LP (//)**. Check the SP/LP indicator on the recorder's front display panel to confirm the selected tape speed.

### 5 Start recording.

Press and hold **●** and press **▶** on the remote control, or press **●** on the recorder.

- The VHS recording indicator lights on the recorder.

B.E.S.T. takes place at the beginning of both the first SP and the first LP recording after inserting the cassette. (☞ pg. 29)

If "DIRECT REC" is set to "ON", the programme that appears on the TV screen will be recorded. (☞ pg. 69).

### 6 Pause/Resume recording.

Press **II**. Press **▶** to resume recording.

- You can select channel during the Record Pause mode.

### 7 Stop recording.

Press **■**. Then press **▲** to remove the cassette.

- The VHS recording indicator turns off.

#### NOTE:

It is not possible to record a TV programme on both the VHS deck and the DV deck simultaneously. However, it is possible to record simultaneously from the same external input. Set the input mode to "L-1", "L-2" or "F-1" depending on the connectors being used. (☞ pg. 49, "Simultaneous Dubbing")

# Playback Features

(VHS deck)

## NOTE:

Refer to the illustrations below as you read the following procedures.

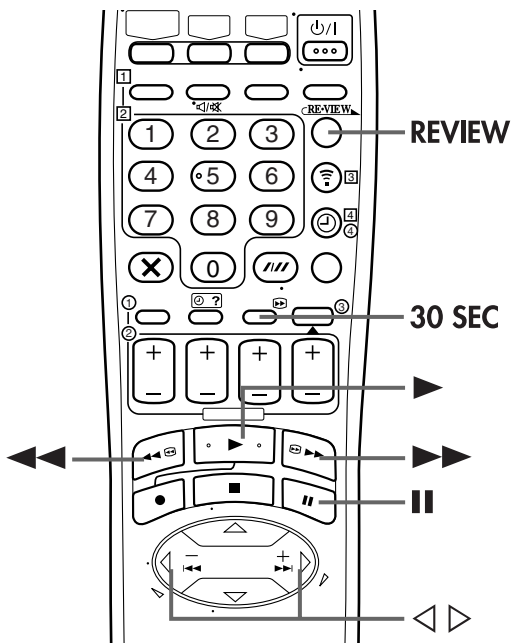
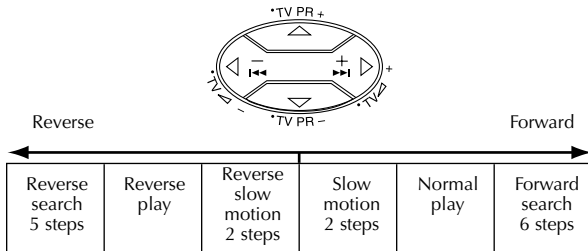

## ATTENTION

- Picture may not appear during high-speed search with an LP-recorded tape.
- In the high-speed search, still, slow motion or frame-by-frame playback mode, the picture will be distorted.
- When normal playback resumes from search, still, slow motion or frame-by-frame playback, the picture may jitter momentarily depending on the type of TV being used.

## Clean the video heads using a dry cleaning cassette — TCL-2 — when:

- Rough, poor picture appears while a tape is played back.
- The picture is unclear or no picture appears.
- "USE CLEANING CASSETTE" appears on the screen (only with "O.S.D." set to "ON" (pg. 69)).

## Still Picture/Frame-By-Frame Playback

### 1 Pause during playback.

Push the **JOG** dial.

**OR**

Press **||**.

### 2 Activate frame-by-frame playback.

Turn the **JOG** dial to the right for forward frame-by-frame playback, or to the left for reverse frame-by-frame playback.

**OR**

Press **||**.

**OR**

Press **◀** or **▶**.

## NOTE:

Still picture playback stops automatically after 5 minutes to protect the heads.

To resume normal playback, press **▶** or push the **JOG** dial.

## Slow Motion

During playback, turn the **JOG** dial one click to the left for forward slow motion. To play in reverse slow motion, continue to turn the **JOG** dial to the left after selecting all the forward direction slow motion modes.

**OR**

During still picture, press and hold **||** for 2 seconds, then release. Press **||** and release again to return to still picture.

**OR**

During still picture, press and hold **◀** or **▶**. Release to return to still picture.

## NOTES:

- During slow motion playback, some noise may appear on the TV screen. Press **PR+** or **-** on the remote control to eliminate the noises.
- Slow motion playback stops automatically after 5 minutes to protect the heads.

To resume normal playback, press **▶**.

## High-Speed (Turbo) Search

During playback, turn the **JOG** dial quickly to the left or right.

**OR**

During playback or still, press **▶▶** for forward high-speed search, or **◀◀** for reverse high-speed search.

### NOTE:

For short searches, press and hold **▶▶** or **◀◀** for over 2 seconds during playback or still picture. When released, normal playback resumes.

## Variable Speed Search

During playback, turn the **JOG** dial to the right for forward variable-speed search, or to the left for reverse variable-speed search.

**OR**

During playback, press **◀** or **▷**.

- The more times you press, the faster the playback picture moves.
- To decrease speed, press the button for the opposite direction.

To resume normal playback, press **▶**.

## Skip Search

During playback, press **30 SEC 1** to 4 times to skip over unwanted sections.

Each press initiates a 30-second period of fast-motion playback. Normal playback resumes automatically.

To resume normal playback during a Skip Search, press **▶**.

## Index Search

Your recorder automatically marks index codes at the beginning of each recording. This function gives you quick access to any one of 9 index codes in either direction.

### NOTE:

Before starting, make sure the recorder is in the **Stop** mode.



### Activate Index Search.

Press **◀** or **▷** (**◀◀** or **▶▶**). "**◀◀ 1**" or "**▶▶ 1**" is displayed on the TV screen and search begins in the corresponding direction.

- To access index codes 2 through 9, press **◀** or **▷** repeatedly until the correct index number is displayed.

#### Example:

To locate the beginning of B from the current position, press **◀** twice.

To locate the beginning of D from the current position, press **▷** once.

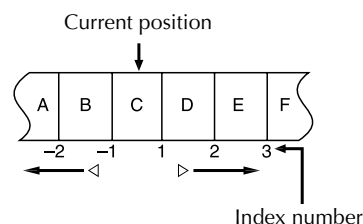

- When the specified index code is located, playback begins automatically.

## Instant ReView

Simply by pressing a single button, the recorder power comes on, rewinds, and begins playback of the last timer-recorded programme. If you have several programmes recorded, you can easily access any of them.

### NOTE:

Before starting, make sure that the recorder is off and that the **Timer mode** is disengaged.

### Activate Instant ReView.

Press **REVIEW**. The recorder power comes on and the recorder searches for the index code indicating the start of the last timer-recorded programme. Once it's found, playback begins automatically.

- The front display panel tells you how many programmes have been timer-recorded. If you have, for example, 3 programmes, "**REVIEW**" and "**3**" appear and blink. To watch the first of the 3 programmes, press **REVIEW** three times. The recorder searches and begins playback automatically. You can access a programme as far as 9 index codes away from the current tape position.

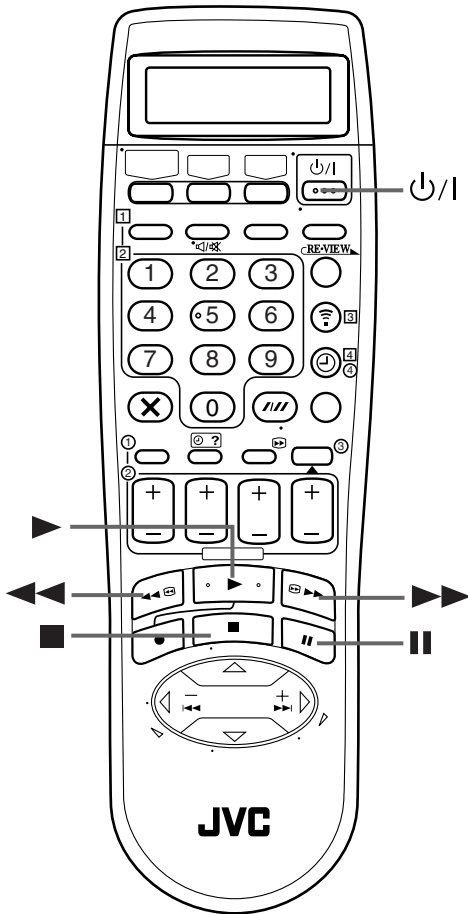

## Next Function Memory

The Next Function Memory "tells" the recorder what to do after rewinding. Before continuing, make sure the recorder is in the Stop mode.

- a- For Automatic Start Of Playback  
Press ◀◀, then press ▶ within 2 seconds.
- b- For Automatic Power Off  
Press ◀◀, then press ⏻ within 2 seconds.
- c- For Automatic Cassette Ejection After Tape Rewind  
Press ◀◀, then press ▲ within 2 seconds.

### NOTE:

The Automatic Power Off does not work if "AUTO TIMER" is set to "ON" and if any timer programming has been made. If "AUTO TIMER" is set to "ON", the recorder directly goes into the Timer-Standby mode at the same time when the ⏻ is pressed for the Automatic Power Off.

## Repeat Playback

Your recorder can automatically play back the whole tape 100 times repeatedly.

### 1 Start playback.

Press ▶.

### 2 Activate Repeat Playback.

Press ▶ and hold for over 5 seconds, then release.

- The Play indicator (▶) on the front display panel blinks slowly.
- After playing back a tape 100 times, the recorder stops automatically.

### 3 Stop Repeat Playback.

Press ■ at any time.

- Pressing ▶, ◀◀, ▶▶ or || also stops Repeat Playback.



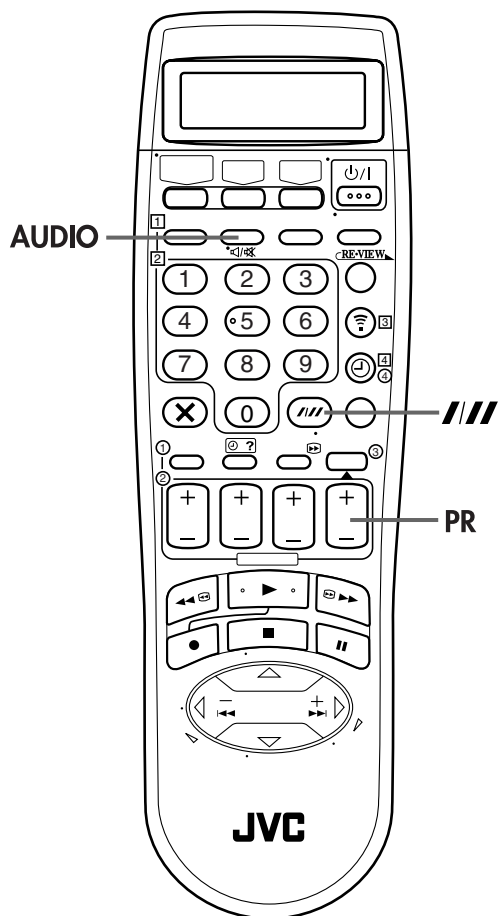

## Manual Tracking

Your recorder is equipped with automatic tracking control. During playback, you can override this and adjust the tracking manually by pressing the **PR** buttons.

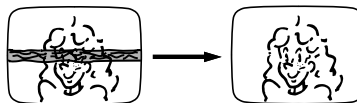

### 1 Override automatic tracking.

Press **///** on the remote control.

### 2 Adjust the tracking manually.

Press **PR +** or **-**.

- Press **///** again to return to automatic tracking.

### NOTE:

When a new tape is inserted, the recorder enters the automatic tracking mode automatically.

## Soundtrack Selection

Your recorder is capable of recording three soundtracks (HI-FI L, HI-FI R and NORM) and will play back the one you select.

### During Playback

Pressing **AUDIO** changes the soundtrack as follows:

TRACK	USE
On-Screen Display	
HI F I L R	For Hi-Fi stereo tapes
HI F I L	For main audio of Bilingual tapes
HI F I R	For sub audio of Bilingual tapes
NORM	For audio-dubbed tapes
HI F I NORM	For audio-dubbed tapes

### NOTES:

- "HI F I L R" should normally be selected. In this mode, Hi-Fi stereo tapes are played back in stereo, and the normal audio track is played back automatically for tapes with only normal audio.
- For instructions on recording stereo and bilingual programmes, refer to page 28.
- "O.S.D." must be set to "ON" or the on-screen displays will not appear (pg. 69).

# Recording Features

(VHS deck)

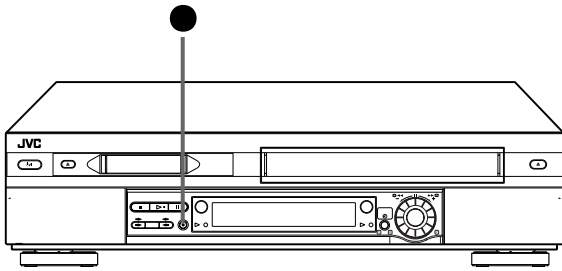

## Recording Resume Function

If there is a power outage during recording, Instant Timer Recording (in the right column) or timer recording (pg. 36, 38, 40), the recording will resume automatically when power is restored to the recorder unless the recorder's memory backup has expired.

## Accidental erasure prevention

To prevent accidental recording on a recorded cassette, remove its safety tab. To record on it later, cover the hole with adhesive tape.

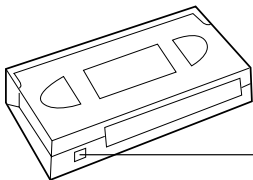

Record safety tab

## Record One Programme While Watching Another

Once recording is in progress, all you need to do is to set the channel controls on the TV for the station you wish to view.

- The programme selected with the TV's channel controls appears on the TV screen, while the one selected with the recorder's **PR** buttons is recorded on the tape.
- If a decoder is connected to the recorder (pg. 66), you can select a scrambled channel as well with the TV channel controls.

## Instant Timer Recording (ITR)

This easy method lets you record for from 30 minutes to 6 hours (selectable in 30-min. increments), and shuts the recorder off after recording is finished.

### 1 Start recording.

Press ● on the recorder.

### 2 Engage the ITR mode.

Press ● again. "○" blinks and "0:30" appears on the front display panel.

### 3 Set the recording duration.

If you want to record for more than 30 minutes, press ● to extend the time. Each press extends recording time by 30 minutes.

## NOTES:

- You can only perform ITR using the ● button on the recorder's front panel.
- You can play back a tape on DV deck while using the VHS deck for Instant Timer Recording. However, remember that the recorder will turn itself off when the Instant Timer Recording ends.

## Elapsed Recording Time Indication

### 1 Set the counter display.

Press **--:--** until a counter reading appears on the front display panel.

### 2 Reset the counter.

Press **0000** before starting recording or playback.

- The counter is reset to "0:00:00" and shows the exact elapsed time as the tape runs. You can check the exact time of a recording or playback.

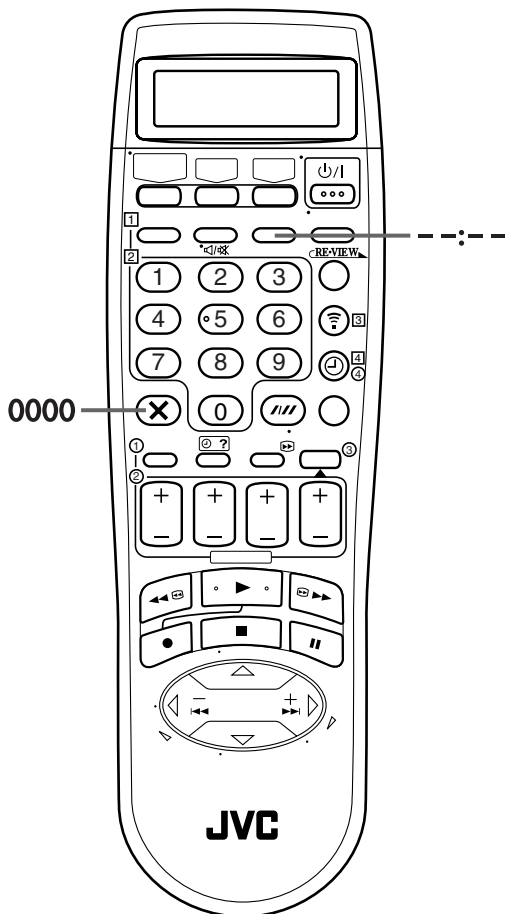

## Tape Remaining Time

Press **--:--** until the time remaining on the tape appears on the front display panel.

- The front display panel shows the tape remaining time with "▴" displayed.
- By pressing the **--:--** button, you can change the display to show the counter reading, channel position\*, clock time or tape remaining time.

\* Channel position is not displayed during playback.

### NOTE:

Depending on the type of tape being used, the tape remaining time reading may not appear right away, or is not correct. "--:--" may sometimes appear, or the display may blink on occasion.

## Retake

You can cut out unnecessary parts of a TV programme while you are recording it.

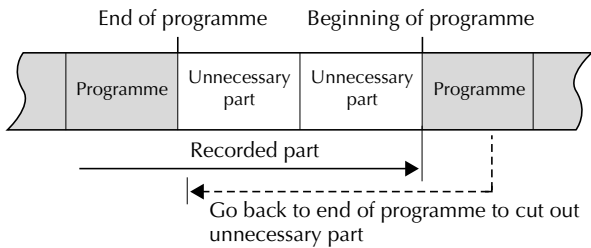

### 1 Engage the Record-Pause mode.

Press **II** during recording.

### 2 Locate the start point.

Turn the **JOG** dial to the left or right (or hold down **◀◀** or **▶▶**) and release it when you reach the point where you want to resume recording.

- Your recorder returns to the Record-Pause mode.

### 3 Resume recording.

Press **▶** when you wish to resume recording.

#### NOTE:

Retake function does not work during Direct Rec (☞ pg. 19, 69).

## Receiving Stereo and Bilingual Programmes

Your recorder is equipped with a Sound-Multiplex decoder (A2) and a Digital stereo sound decoder (NICAM) making reception of stereo and bilingual broadcasts possible.

When the channel is changed, the type of broadcast being received will be displayed on the TV screen for a few seconds.

Type of Broadcast Being Received	On-screen Display
A2 Stereo	ST
A2 Bilingual	BIL.
Regular Monaural	(none)
NICAM Stereo	ST NICAM
NICAM Bilingual	BIL. NICAM
NICAM Monaural	NICAM

- To listen to a stereo programme, press **AUDIO** until "HIFI L **▶▶** R" appears on the TV screen.
- To listen to a bilingual programme, press **AUDIO** until "HIFI L **▶▶**" or "HIFI **▶▶** R" appears on the TV screen.
- To listen to the standard (Regular Monaural) audio while receiving a NICAM broadcast, press **AUDIO** until "NORM" appears on the front display panel or the TV screen.

#### NOTE:

"O.S.D." must be set to "ON" or the on-screen displays will not appear (☞ pg. 69).

### To Record Stereo and Bilingual Programmes (A2)

Stereo programmes are automatically recorded in stereo on the Hi-Fi audio track (with the normal audio track recording mixed L and R channel sound).

- Bilingual programmes are automatically recorded in bilingual on the Hi-Fi audio track. The main soundtrack will be recorded on the normal audio track.

### To Record NICAM Stereo and Bilingual Programmes

The NICAM audio programme will be recorded on the Hi-Fi audio track, and the standard audio programme will be recorded on the normal audio track.

#### NOTES:

- If the quality of stereo sound being received is poor, the broadcast will be received in monaural with better quality.
- Before playing back a programme recorded in stereo, or a bilingual programme, refer to "Soundtrack Selection" on page 25.

# B.E.S.T. Picture System

## (VHS deck)

The B.E.S.T. (Biconditional Equalised Signal Tracking) system checks the condition of the tape in use during playback and recording, and compensates to provide the highest-possible playback and recording pictures. You can set "B.E.S.T." to "ON" or "OFF" to your preference (☞ pg. 70).

## Playback

The recorder assesses the quality of the tape once you initiate playback.

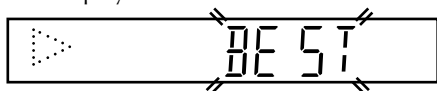

- The recorder adjusts the playback picture quality based on the quality of the tape in use.
- B.E.S.T. is active during automatic tracking. "BEST" appears blinking on the recorder's front display panel.

### NOTES:

- When watching a tape recorded with "B.E.S.T." set to "ON", it is recommended that you leave B.E.S.T. on during playback as well.
- When watching a rental tape or one recorded on another video recorder, or when using this recorder as the player for editing, set B.E.S.T. to your preference (☞ pg. 70).
- "BEST" only appears at the beginning of automatic tracking. Even though it doesn't appear after that, the B.E.S.T. function is operative.

## Recording

The recorder assesses the quality of the tape once you initiate recording.

### DURING B.E.S.T.

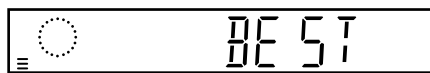

### B.E.S.T. COMPLETE

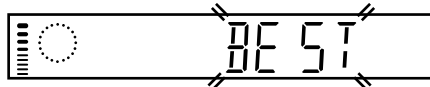

- The recorder spends approximately 7 seconds assessing the condition of the tape, then begins recording.

### NOTES:

- The B.E.S.T. system works for both SP and LP modes only after a tape has been inserted and the Record mode is first initiated. It does not work during recording.
- In the case of timer recordings, the B.E.S.T. system works before recording is initiated.
- Once the cassette is ejected, the B.E.S.T. data is cancelled. The next time the cassette is used for recording, B.E.S.T. is re-performed.
- Pressing the recorder's ● button while "BEST" is displayed does not start Instant Timer Recording (☞ pg. 26).

### ATTENTION

Since the B.E.S.T. system works before recording actually starts, there is a delay of approximately 7 seconds after ● and ► on the remote control are pressed, or ● on the recorder is pressed. To make sure you record the desired scene or programme in its entirety, first perform the following steps:

- 1 Press and hold ■ and press ● to engage the Record Pause mode.
  - The recorder then automatically checks the condition of the tape and, after approximately 7 seconds, re-enters Record Pause mode.
  - 2 Press ► to start recording.
- If you want to bypass the B.E.S.T. system and begin recording immediately, set "B.E.S.T." to "OFF" (☞ pg. 70).

# Basic Playback

(DV deck)

Turn on the TV and select the AV mode.

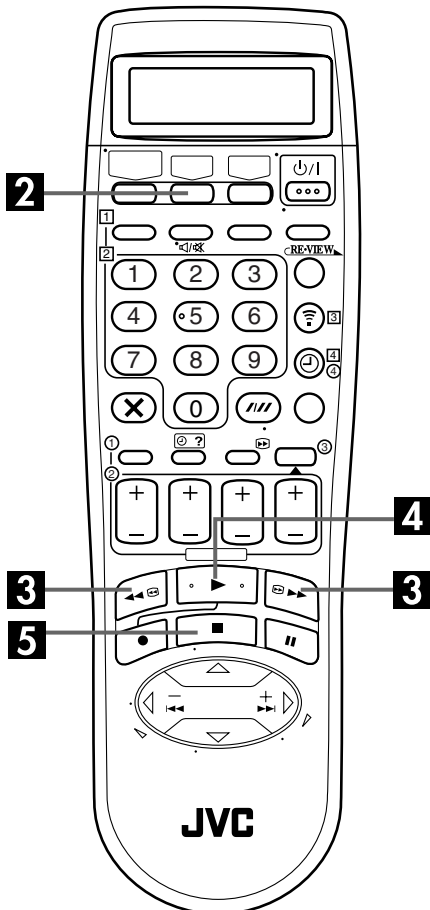
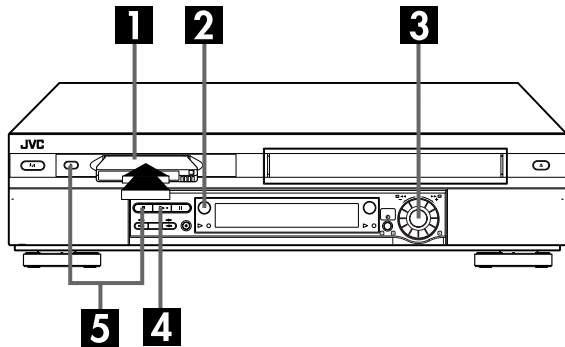

## 1 Load a cassette.

Make sure the window side is up, the rear label side is facing you and the arrow on the front of the cassette is pointed toward the recorder.

- Do not apply too much pressure when inserting.
- The recorder's power comes on automatically.
- If the erase protection switch is set to "SAVE", playback begins automatically. It takes about 15 seconds until the playback picture appears.
- Make sure the VCR indicator appears on the front display panel. If not, press **TV/VCR** on the remote control to turn on the VCR indicator.

## 2 Select the DV deck.

Press **DV**.

- The DV button lights on the recorder.

## 3 Find the programme start point.

If the tape is advanced past the start point, press ◀◀ or turn the **JOG** dial to the left. To go forward, press ▶▶ or turn the **JOG** dial to the right.

## 4 Start playback.

Press ▶.

- The DV playback indicator lights on the recorder.

## 5 Stop playback.

Press ■. Then press ▲ to remove the cassette.

- The DV playback indicator turns off.

### Usable cassettes

Only cassettes marked <sup>Mini</sup>DV can be used with the DV deck.

### NOTE:

When you record a tape on the DV deck with the recording speed set to "LP", it is recommended to play back that tape back on this DV deck. Digital video recorder from other manufacturers may not be able to play back the tape properly.

# Basic Recording

## (DV deck)

Turn on the TV and select the AV mode.

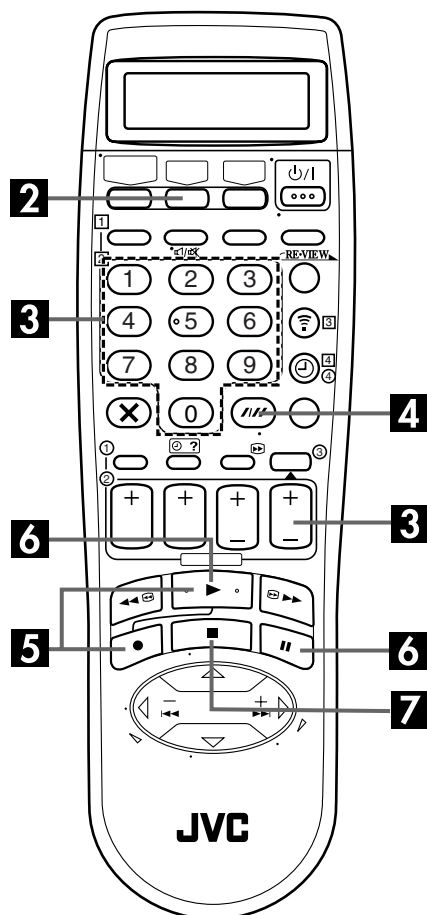
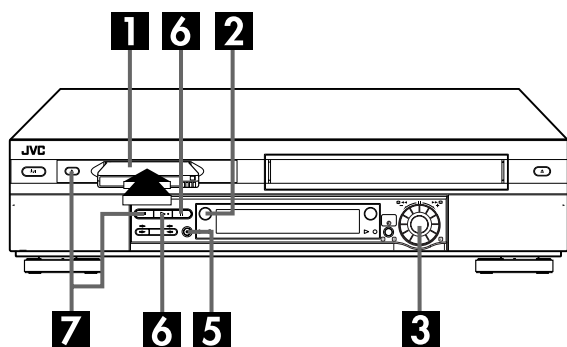

### 1 Load a cassette.

Insert a Mini DV cassette with the erase protection switch set to "REC".

- The recorder's power comes on automatically.

### 2 Select the DV deck.

Press **DV**.

- The DV button lights on the recorder.

### 3 Choose a programme.

Press **PR +/-** or the **number keys**. Or push the **JOG** dial and turn it to the left or right to select the channel you wish to record.

### 4 Set the tape speed.

Press **SP/LP (//)**. Check the SP/LP indicator on the recorder's front display panel to confirm the selected tape speed.

### 5 Start recording.

Press and hold **●** and press **▶** on the remote control, or press **●** on the recorder.

- The DV recording indicator lights on the recorder.

If "DIRECT REC" is set to "ON", the programme that appears on the TV screen will be recorded (☞ pg. 69).

### 6 Pause/Resume recording.

Press **⏸**. Press **▶** to resume recording.

- You can select channel during the Record Pause mode.

### 7 Stop recording.

Press **■**. Then press **▲** to remove the cassette.

- The DV recording indicator turns off.

### NOTES:

- It is not possible to record a TV programme on both the VHS deck and the DV deck simultaneously. However, it is possible to record simultaneously from the same external input. Set the input mode to "L-1", "L-2" or "F-1" depending on the connectors being used. (☞ pg. 49, "Simultaneous Dubbing")
- When you record a tape on the DV deck with the recording speed set to "LP", it is recommended to play back that tape back on this DV deck. Digital video recorder from other manufacturers may not be able to play back the tape properly.

# Playback Features

(DV deck)

## NOTE:

Refer to the illustrations below as you read the following procedures.

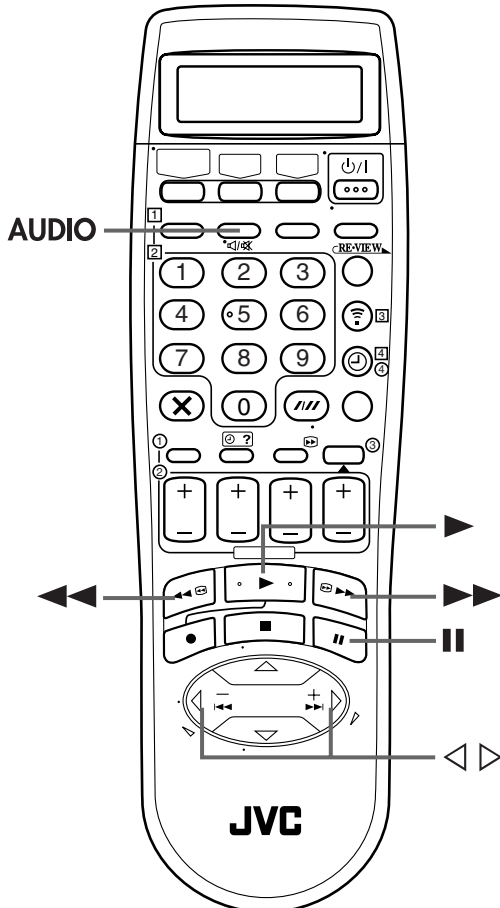
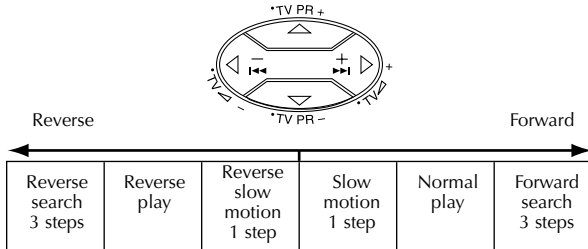

## ATTENTION

Picture may appear distorted during variable speed search.

**Clean the video heads using a dry cleaning cassette — M-DV12CL — when:**

- No picture during playback.
- Blocks of noise appear during playback.
- "USE CLEANING CASSETTE" appears on the screen (only with "O.S.D." set to "ON" (pg. 69)).

## Still Picture/Frame-By-Frame Playback

### 1 Pause during playback.

Push the **JOG** dial.

**OR**

Press **II**.

### 2 Activate frame-by-frame playback.

Turn the **JOG** dial to the right for forward frame-by-frame playback, or to the left for reverse frame-by-frame playback.

**OR**

Press **II**.

**OR**

Press **<** or **>**.

## NOTE:

Still picture playback stops automatically after 3 minutes to protect the heads.

To resume normal playback, press **>** or push the **JOG** dial.

## Slow Motion

During playback, turn the **JOG** dial one click to the left for forward slow motion. To play in reverse slow motion, continue to turn the **JOG** dial to the left.

**OR**

During still picture, press and hold **II** for 2 seconds, then release. Press **II** and release again to return to still picture.

**OR**

During still picture, press and hold **<** or **>**. Release to return to still picture.

## NOTE:

Forward slow motion playback stops automatically after 1 minute, reverse slow motion playback after 30 seconds to protect the heads.

To resume normal playback, press **>**.



## High-Speed (Turbo) Search

### For forward high-speed search

During playback, turn the **JOG** dial quickly to the right.

### For reverse high-speed search (refer to the JOG dial illustration)

During playback, turn the **JOG** dial one or two click to the right (①), and then turn it quickly to the left (②).

- Reverse high-speed search may not be activated when turning the **JOG** dial directly to the left during normal playback.

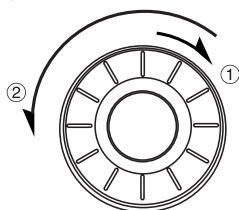

JOG dial

### OR

During playback or still, press

▶▶ for forward high-speed search, or ◀◀ for reverse high-speed search.

### NOTE:

For short searches, press and hold ▶▶ or ◀◀ for over 2 seconds during playback or still picture. When released, normal playback resumes.

## Variable Speed Search

During playback, turn the **JOG** dial to the right for forward variable-speed search, or to the left for reverse variable-speed search.

### OR

During playback, press ◀ or ▷.

- The more times you press, the faster the playback picture moves.
- To decrease speed, press the button for the opposite direction.

To resume normal playback, press ▶.

## Next Function Memory

The Next Function Memory “tells” the recorder what to do after rewinding. Before continuing, make sure the recorder is in the Stop mode.

- For Automatic Start Of Playback  
Press ◀◀, then press ▶ within 2 seconds.
- For Automatic Power Off  
Press ◀◀, then press ⏻ within 2 seconds.
- For Automatic Cassette Ejection After Tape Rewind  
Press ◀◀, then press ▲ within 2 seconds.

### NOTE:

The Automatic Power Off does not work if “AUTO TIMER” is set to “ON” and if any timer programming has been made. If “AUTO TIMER” is set to “ON”, the recorder directly goes into the Timer-Standby mode at the same time when the ⏻ is pressed for the Automatic Power Off.

## Soundtrack Selection

Your recorder is capable of recording two soundtracks (L and R) and will play back the one you select.

### During Playback

Pressing **AUDIO** changes the soundtrack as follows:

TRACK	USE
On-Screen Display	
L▶▶R	For stereo or Bilingual tapes
L▶▶	For main audio of Bilingual tapes
◀▶R	For sub audio of Bilingual tapes

### NOTES:

- For instructions on recording stereo and bilingual programmes, refer to page 35.
- “O.S.D.” must be set to “ON” or the on-screen displays will not appear (ⓘ pg. 69).

# Recording Features

(DV deck)

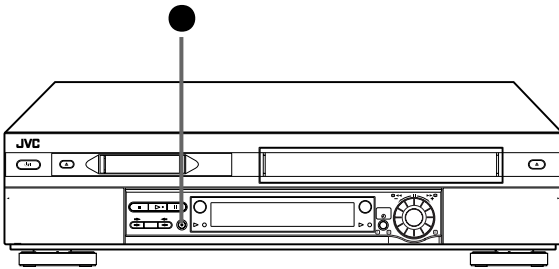

## Recording Resume Function

If there is a power outage during recording, Instant Timer Recording (in the right column) or timer recording (pg. 36, 38, 40), the recording will resume automatically when power is restored to the recorder unless the recorder's memory backup has expired.

## Accidental erasure prevention

To prevent accidental recording on a recorded cassette, set its erase protection switch to "SAVE". To record on it later, set the switch to "REC".

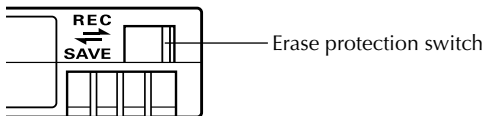

## Record One Programme While Watching Another

Once recording is in progress, all you need to do is to set the channel controls on the TV for the station you wish to view.

- The programme selected with the TV's channel controls appears on the TV screen, while the one selected with the recorder's **PR** buttons is recorded on the tape.
- If a decoder is connected to the recorder (pg. 66), you can select a scrambled channel as well with the TV channel controls.

## Instant Timer Recording (ITR)

This easy method lets you record for from 30 minutes to 2 hours (selectable in 30-min. increments), and shuts the recorder off after recording is finished.

### 1 Start recording.

Press ● on the recorder.

### 2 Engage the ITR mode.

Press ● again. "0" blinks and "0:30" appears on the front display panel.

### 3 Set the recording duration.

If you want to record for more than 30 minutes, press ● to extend the time. Each press extends recording time by 30 minutes.

### NOTE:

*You can only perform ITR using the ● button on the recorder's front panel.*

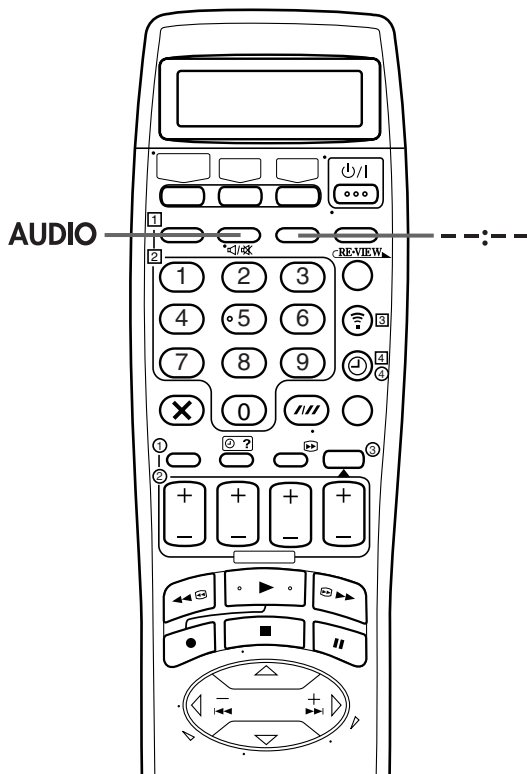

## Receiving Stereo and Bilingual Programmes

Your recorder is equipped with a Sound-Multiplex decoder (A2) and a Digital stereo sound decoder (NICAM) making reception of stereo and bilingual broadcasts possible.

When the channel is changed, the type of broadcast being received will be displayed on the TV screen for a few seconds.

Type of Broadcast Being Received	On-screen Display
A2 Stereo	ST
A2 Bilingual	BIL.
Regular Monaural	(none)
NICAM Stereo	ST NICAM
NICAM Bilingual	BIL. NICAM
NICAM Monaural	NICAM

- To listen to a stereo programme, press **AUDIO** until “L R” appears on the TV screen.
- To listen to a bilingual programme, press **AUDIO** until “L R” or “R” appears on the TV screen.
- To listen to the standard (Regular Monaural) audio while receiving a NICAM BIL broadcast, set “AUDIO REC” to “MONO” (pg. 73).

### NOTE:

“O.S.D.” must be set to “ON” or the on-screen displays will not appear (pg. 69).

### To Record Stereo and Bilingual Programmes (A2)

Stereo programmes are automatically recorded in stereo on the audio track.

- Bilingual programmes are automatically recorded in bilingual on the audio track.

### To Record NICAM Bilingual Programmes

See “AUDIO REC” on page 73.

### NOTE:

Before playing back a bilingual programme, refer to “Soundtrack Selection” on page 33.

## Time Code

During recording, a time code is recorded on the tape. This time code is used to confirm the position on the tape when playing back or editing a tape. To perform Random Assemble Editing (pg. 58), time code is necessary.

Press --:-- until the time code on the tape appears on the front display panel.

- By pressing the --:-- button, you can change the display to show the time code, channel position\*, clock time.

\* Channel position is not displayed during playback.

- If “TIME CODE” is set to “ON” (pg. 73), the time code always appears on the TV screen while the DV deck is being selected. (pg. 7)

### NOTES:

**The presence of a blank (unrecorded) portion in the middle of a tape can result in misoperation.**

A “blank portion” of a tape is a section where nothing is recorded on the tape. If you start recording in a blank portion of a tape, the time codes will start from “0:00:00:00” again. If identical time codes are recorded in two different places on a tape, Random Assemble Editing and other similar functions might not operate properly.

In the following cases, you should play back the tape and confirm where a scene ends, and then begin recording from there:

- When starting recording in the middle of a tape on which a recording has already been made.
- When you finish recording on a tape, then played back that recording in order to check it, and now wish to continue recording.
- When you lost power or the batteries died while you were recording with a camcorder.

# SHOWVIEW® Timer Programming

With the SHOWVIEW system, timer programming is greatly simplified because each TV programme has a corresponding code number which your recorder is able to recognize. You can use the remote control with LCD panel to enter the SHOWVIEW number.

## Before performing the SHOWVIEW Timer Programming:

- Make sure that the recorder's built-in clock is set properly.
- Turn on the TV and select the AV mode.

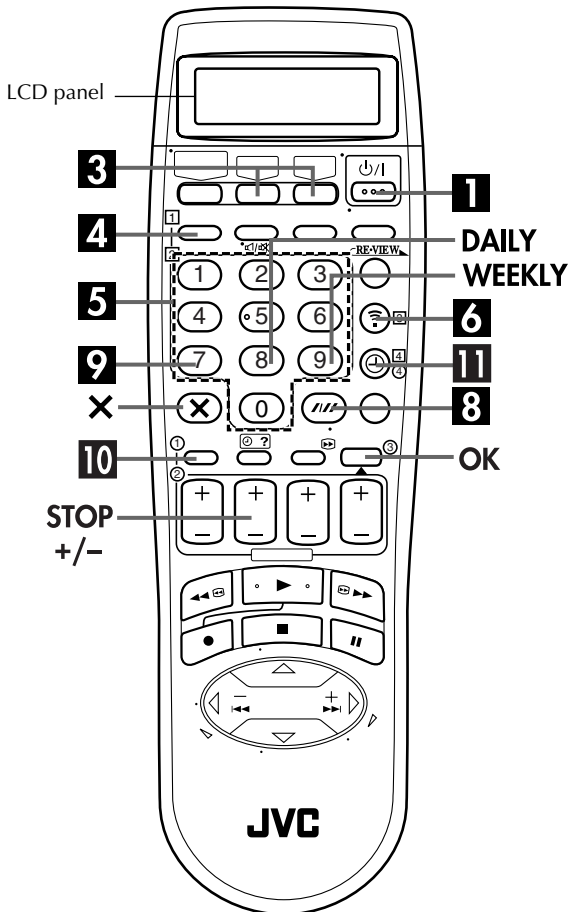

## 1 Turn on the recorder.

Press  $\phi/1$ .

## 2 Load a cassette.

Insert a VHS (or S-VHS) cassette with the record safety tab intact.

**OR**

Insert a Mini DV cassette with the erase protection switch set to "REC".

## 3 Select the deck.

Press **VHS** or **DV**.

## 4 Access the SHOWVIEW display.

Press **LCD PROG.**

The LCD panel looks like this:

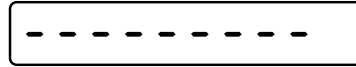

## 5 Enter the SHOWVIEW number.

Press the **number keys** to enter the SHOWVIEW number of a programme you wish to record.

- If you make a mistake, press **X** and input the correct number.

The SHOWVIEW number you enter appears on the LCD panel:



## 6 Transmit the SHOWVIEW number.

Press  $\text{⏏}$  to transmit the SHOWVIEW number from the remote control to the recorder.

- If the number you entered is invalid, "ERROR" appears on the TV screen and "Err" appears on the front display panel. Input a valid SHOWVIEW number.

## 7 Check the programme data.

The SHOWVIEW number you entered and the matching timer-recording information are displayed on the TV screen. Check they are correct.

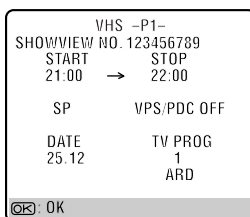

The front display panel shows the programme start time. Pressing  $\odot$  ? changes the display to the programme stop time, then the date and channel position.

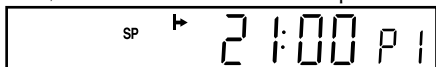

### IMPORTANT

Make sure the channel position number you wish to record is displayed; if not, see "SHOWVIEW System Setup" on page 82 and set the Guide Program number correctly.

## 8 Set the tape speed.

Press **SP/LP** (//).

## 9 Set the VPS/PDC mode.

Press **VPS/PDC** to select "ON" or "OFF".

- If "VPS/PDC ON" is displayed on the TV screen or "VPS/PDC" is lit on the front display panel, VPS/PDC is set to ON.
- If "VPS/PDC OFF" is displayed on the TV screen or "VPS/PDC" is not lit on the front display panel, VPS/PDC is set to OFF.  $\square$  "VPS/PDC Recording" on page 39.

## 10 Return to the normal screen.

Press **PROG** or **OK**. "PROGRAM COMPLETED" appears on the TV screen for about 5 seconds, then the normal screen appears. If "PROGRAM OVERLAPPED" appears on the TV screen and "Err" on the front display panel, see page 43.

- Repeat steps 3 – 10 for each additional programme.

## 11 Engage the recorder's timer mode.

Press  $\odot$  (**TIMER**). The recorder turns off automatically and "O" appears on the front display panel.

- To disengage the timer mode, press  $\odot$  (**TIMER**) again.

### Satellite Receiver Users

To timer-record a satellite broadcast using the SHOWVIEW system:

- 1 Perform "Satellite Receiver Control Setting" on page 17.
- 2 Perform steps 1 – 11. In step 7, the front display panel shows "L2" for the channel position. In step 9, you cannot set "VPS/PDC" to "ON".
- 3 Leave the satellite receiver's power on.

## NOTES:

- To Change The Stop Time . . . . . press **STOP +/-** in step 7. You can compensate for anticipated programme schedule delays.
- To Timer-Record Weekly Or Daily Serials . . . . . in step 7, press **WEEKLY** (number key "9") for weekly serials or **DAILY** (number key "8") for daily serials (Monday – Friday). Either "WEEKLY" or "DAILY" appears on the TV screen. Pressing the button again makes the corresponding indication disappear.
- You can programme each deck to timer-record as many as 6 programmes. If you try to programme the recorder to record a seventh, "PROGRAM FULL" appears on the TV screen and "FULL" appears on the front display panel. To record the extra programme, you must first cancel any unnecessary programmes ( $\square$  pg. 42).
- It is not possible to timer-record a TV programme with a SHOWVIEW number which starts with "0".
- It is not possible to timer-record a satellite broadcast received on the channel position "0" by the satellite receiver.
- It is not possible to timer-record the same programme on both the VHS deck and the DV deck simultaneously.
- During timer recording, it is not possible to change the recording deck (VHS or DV).
- If the times that are programmed for recording on the DV deck and on the VHS deck overlap, the earlier start time takes precedence. If the start times are the same, the VHS deck takes precedence.

## INFORMATION

Instead of the steps 4 – 6, you can enter the SHOWVIEW number using the on-screen menu.

- 1 Press **PROG** to access the SHOWVIEW screen.

- 2 Press the **number keys** to enter the SHOWVIEW number of a programme you wish to record.

- If you make a mistake, press **X** and input the correct number.

- 3 Press **OK**, then go to step 7 in the left column.

- If the number you entered is invalid, "ERROR" appears on the TV screen and "Err" appears on the front display panel. Input a valid SHOWVIEW number.
- If the "GUIDE PROG SET" screen appears, see "ATTENTION" below.

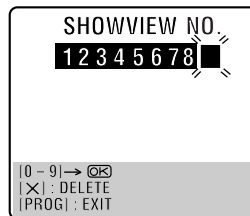

## ATTENTION

### Guide Program Number Set

"GUIDE PROG SET" appears after performing step 3 above if the Guide Program number for the SHOWVIEW number you entered has not been set.

If you want to set the Guide Program number for the satellite broadcast station, press the **number key "0"** to change "TV PROG" to "SAT". Press  $\Delta$   $\nabla$  to input the channel position number on which your recorder or satellite receiver receives that station, then press **OK** or  $\triangleright$  to set the Guide Program number. The SHOWVIEW Program screen appears.

(Example)

To timer-record a ZDF programme with the SHOWVIEW system.

\* If your recorder receives ZDF on the channel position 2, press **OK** or  $\triangleright$  after entering "2".

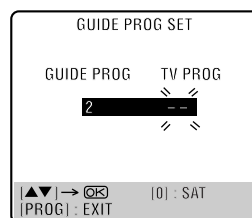

# Express Timer Programming

If you do not know the SHOWVIEW number for the programme you wish to record, use the following procedure to set your recorder to timer-record the programme.

## Before performing Express Timer Programming:

- Make sure that the recorder's built-in clock is set properly.
- Turn on the TV and select the AV mode.

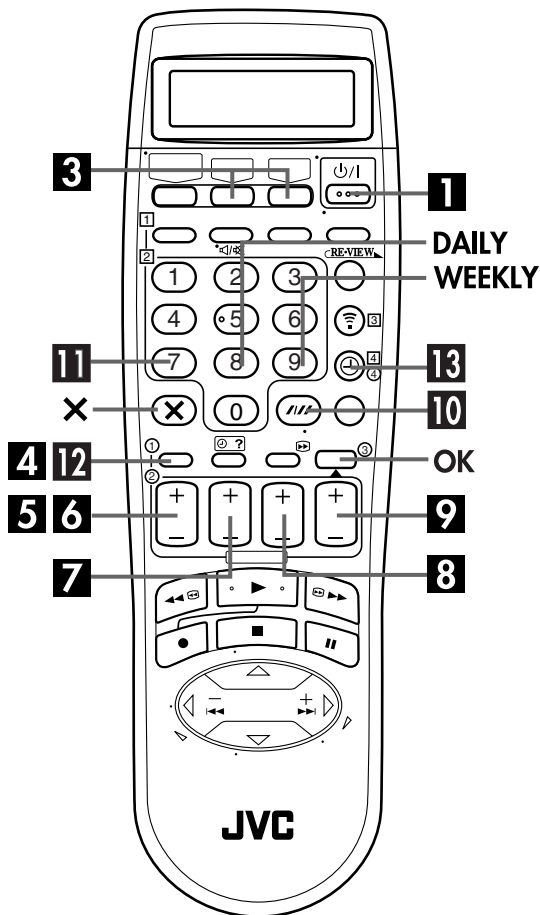

## 1 Turn on the recorder.

Press  $\phi$ /I.

## 2 Load a cassette.

Insert a VHS (or S-VHS) cassette with the record safety tab intact.

**OR**

Insert a Mini DV cassette with the erase protection switch set to "REC".

## 3 Select the deck.

Press VHS or DV.

## 4 Access the SHOWVIEW screen.

Press PROG.

## 5 Access the Programme screen.

Press **START+/-**. (If you're just starting out, "P1" appears.)

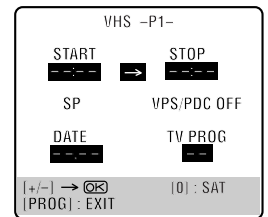

The front display panel looks like this:

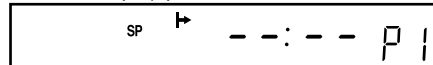

## 6 Enter the programme start time.

Press **START+/-** to enter the time you want recording to start.

- Press and hold **START+/-** to move in 30-minute increments, or press and release repeatedly to move 1 minute at a time.

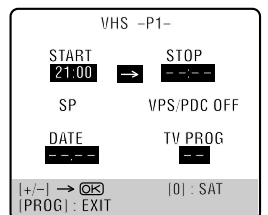

The front display panel looks like this:

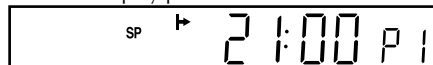

## 7 Enter the programme stop time.

Press **STOP+/-** to enter the time you want recording to stop.

- Press and hold **STOP+/-** to move in 30-minute increments, or press and release repeatedly to move 1 minute at a time.

## 8 Enter the programme date.

Press **DATE+/-**.

- The current date appears on the TV screen. The date you enter appears in its place.

## 9 Enter the channel position.

Press **PR+/-**.

- If you want to set a satellite programme, press the **number key "0"** to change "TV PROG" to "SAT", then press **PR+/-**.

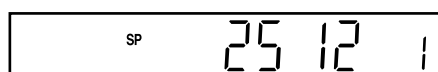
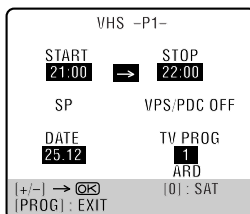

## 10 Set the tape speed.

Press **SP/LP (//)**.

## 11 Set the VPS/PDC mode.

Press **VPS/PDC** to select "ON" or "OFF".

- If "VPS/PDC ON" is displayed on the TV screen or "VPS/PDC" is lit on the front display panel, VPS/PDC is set to ON.
  - If "VPS/PDC OFF" is displayed on the TV screen or "VPS/PDC" is not lit on the front display panel, VPS/PDC is set to OFF.
- ☑ VPS/PDC Recording" in the right column

## 12 Return to the normal screen.

Press **PROG** or **OK**. "PROGRAM COMPLETED" appears on the TV screen for about 5 seconds, then the normal screen appears. If "PROGRAM OVERLAPPED" appears on the TV screen and "Err" on the front display panel, see page 43.

- Repeat steps 3 – 12 for each additional programme.

## 13 Engage the recorder's timer mode.

Press **⊖ (TIMER)**. The recorder turns off automatically and "⊖" appears on the front display panel.

- To disengage the timer mode, press **⊖ (TIMER)** again.

### To Timer-Record Weekly Or Daily Serials . . .

. . . anytime during steps 5 through 11, press **WEEKLY (number key "9")** for weekly serials or **DAILY (number key "8")** for daily serials (Monday – Friday). Either "WEEKLY" or "DAILY" appears on the TV screen. Pressing the button again makes the corresponding indication disappear.

## NOTES:

- You can programme each deck to timer-record as many as 6 programmes. If you try to programme the recorder to record a seventh, "PROGRAM FULL" appears on the TV screen and "FULL" appears on the front display panel. To record the extra programme, you must first cancel any unnecessary programmes (☑ pg. 42).
- It is not possible to timer-record a satellite broadcast received on the channel position "0" by the satellite receiver.
- It is not possible to timer-record the same programme on both the VHS deck and the DV deck simultaneously.
- During timer recording, it is not possible to change the recording deck (VHS or DV).
- If the times that are programmed for recording on the DV deck and on the VHS deck overlap, the earlier start time takes precedence. If the start times are the same, the VHS deck takes precedence.

### Satellite Receiver Users

To timer-record a satellite broadcast using Express Timer Programming:

- 1 Perform "Satellite Receiver Control Setting" on page 17.
- 2 Perform steps 1 – 13. In step 9, press the **number key "0"** to change "TV PROG" to "SAT". The front display panel shows "L2" for the channel position. Then press **PR+/-** to enter the channel position for the satellite broadcast. In step 11, you cannot set "VPS/PDC" to "ON".
- 3 Leave the satellite receiver's power on.

## VPS/PDC Recording

Now available from some TV stations, PDC (Programme Delivery Control) and VPS (Video Programme System) are service designed to assure safe, accurate timer recording. With this system, special code signals are transmitted together with the audio/video signals. These code signals control your video recorder and have precedence over the advertised times you may have preset into the timer. This means that your recorder will start and stop recording when the preset TV programmes actually start and end — even if the broadcast time of a preset TV programme is changed.

## NOTES:

- When you use Express Timer Programming, set the start time (VPS or PDC time) exactly as advertised in the TV listing. A different time than advertised will result in no recording.
- VPS/PDC recording is also possible when a satellite receiver or a cable system is connected to AV2 (L-2) IN/DECODER connector on your recorder.
- VPS/PDC recording is also possible via the AV1 (L-1) IN/OUT connector.

### How to check if the station being received transmits a VPS/PDC signal (VHS deck only)

- 1 Press **--:--** until the channel position appears on the front display panel.
- 2 Hold down **START+** for about 5 seconds. "VPS/PDC" appears blinking on the front display panel. If a VPS/PDC signal is detected from the station, "VPS/PDC" will stop blinking. If no VPS/PDC signal is detected from the station, "VPS/PDC" will blink at a slower rate.
- 3 Press **--:--** or **START+** again to return to normal display.

# 24 Hour Express Timer Programming

## Before performing the 24 Hour Express Timer Programming:

- Make sure that the recorder's built-in clock is set properly.
- Select the deck.
- Set the tape speed.
- **For the VHS deck:**  
Insert a VHS (or S-VHS) cassette with the record safety tab intact.
- **For the DV deck:**  
Insert a Mini DV cassette with the erase protection switch set to "REC".

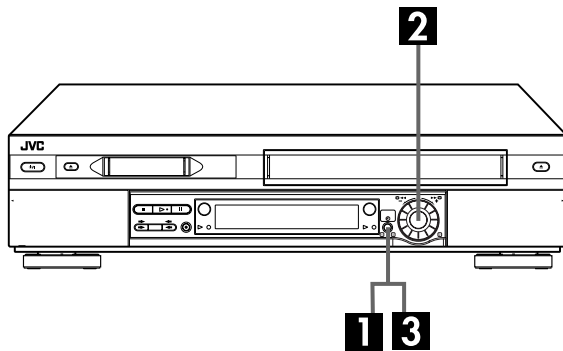

You can programme a timer recording that starts within 24 hours using the JOG dial on the recorder.

## 1 Enter the programme mode.

Press **24H EXPRESS**  $\ominus$  on the recorder. The start time indicator ( $\rightarrow$ ) starts blinking on the front display panel.

- The current tape speed and VPS/PDC setting appear on the front display panel, but it is impossible to change the setting. You can only change the setting after programming (☞ pg. 42).

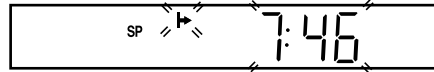

## 2 Set the programme start/stop time and channel.

Turn the **JOG** dial to the left or right to set the time you want recording to start.

- One click stop of the **JOG** dial changes the time in 5-minute intervals.



Push the **JOG** dial. The stop time indicator ( $\rightarrow$ ) starts blinking on the front display panel. Turn the **JOG** dial to the left or right to set the time you want recording to stop.

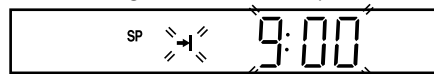

Push the **JOG** dial. Turn the **JOG** dial to the left or right to select the channel you wish to record.

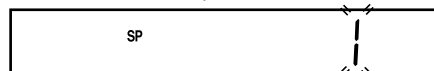

- You can cancel the setting at any time by pressing and holding the **JOG** dial for more than 3 seconds or pressing  $\times$  on the remote control. Repeat the step 2.

## 3 Engage the recorder's timer mode.

Press **24H EXPRESS**  $\ominus$ . The recorder turns off automatically and "⊖" appears on the front display panel.

- To disengage the timer mode, press  $\ominus$  (**TIMER**) or **24H EXPRESS**  $\ominus$  again.



**NOTES:**

- You can programme each deck to timer-record as many as 6 programmes. If you try to programme the recorder to record a seventh, "PROGRAM FULL" appears on the TV screen and "FULL" appears on the front display panel. To record the extra programme, you must first cancel any unnecessary programmes (☞ pg. 42).
- It is not possible to timer-record a satellite broadcast received on the channel position "0" by the satellite receiver.
- If "Err" appears on the front display panel, repeat the steps on page 40 again.
- When a menu screen is shown, you cannot use 24 Hour Express Timer Programming function. Press **MENU** to return to normal screen, and try again.
- You can use 24 Hour Express Timer Programming function also when the recorder is turned off.
- For 24 Hour Express Timer Programming function, the programme overlap warning display does not appear even if some programmes overlap each other. The programme with the lower programme number will be recorded and the other one will not be recorded correctly.
- It is not possible to timer-record the same programme on both the VHS deck and the DV deck simultaneously.
- During timer recording, it is not possible to change the recording deck (VHS or DV).
- If the times that are programmed for recording on the DV deck and on the VHS deck overlap, the earlier start time takes precedence. If the start times are the same, the VHS deck takes precedence.
- You cannot use 24 Hour Express Timer Programming function if you select the DV deck and set the channel to "F-1".

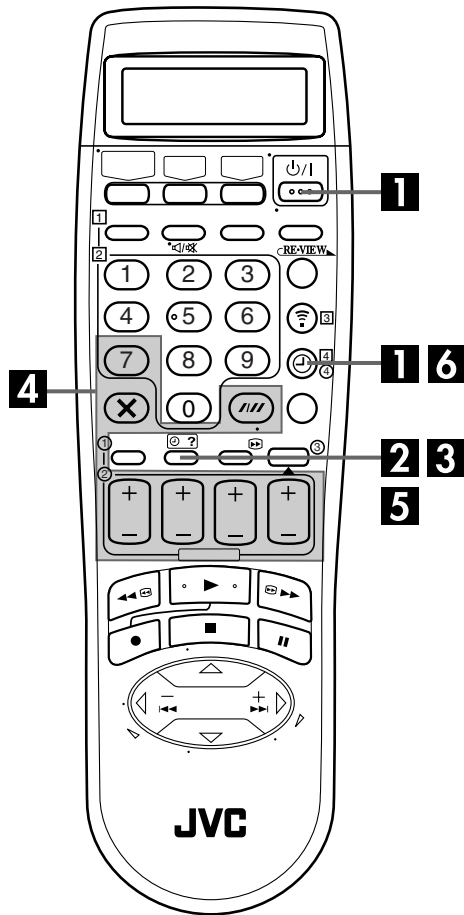

## Check, cancel and change programmes

### 1 Disengage the timer mode.

Press **⊖** (TIMER), then press **⏻**.

### 2 Access the Programme Check screen/display.

Press **⊖** ?.

- The Programme Check screen or display appears for the deck (VHS or DV) being selected.

VHS				
	START	STOP	CH	DATE
1	8:00	10:00	3	24.12
2	10:00	10:45	2	25.12
3	11:30	13:00	1	25.12
4				
5				
6				

⊖ ? | : NEXT

P 1 P 6

### 3 Access the Programme screen/display.

Press **⊖** ? again to check more information. Each time you press **⊖** ?, the next programme's information appears.

VHS -P1-	
START	STOP
8:00	10:00
SP	VPS/PDC OFF
DATE	TV PROG
24.12	3
	WDR

⊖ ? | : NEXT

The front display panel shows the programme start time. Pressing **OK** changes the display to the programme stop time, then the date and the channel position.

SP 8:00 P 1

## To cancel or change a programme...

### 4 Cancel or change a programme.

Press **X** to cancel a programme. To change programme settings, press the appropriate button: **START**+/-, **STOP**+/-, **DATE**+/-, **PR**+/-, **VPS/PDC** and/or **SP/PR** (///).

- You can change "TV PROG" to "SAT" for the channel position by pressing the **number key "0"**.

### 5 Return to the normal screen/display.

Press **⊖** ? as many times as necessary. If there are still some programmes remaining, go to step 6.

### 6 Return to the timer mode.

Press **⊖** (TIMER).

#### NOTE:

You can also check the programmes on the front display panel even if the recorder's power is off (unless the recorder is in the Power Save mode pg. 69) or the recorder is in the Timer mode; however, it is not possible to cancel or change the programmes.

## When programmes overlap each other

If "PROGRAM OVERLAPPED" appears, you have another programme overlapping the programme you have just made. The Programme Check screen appears and conflicting programmes will start blinking.

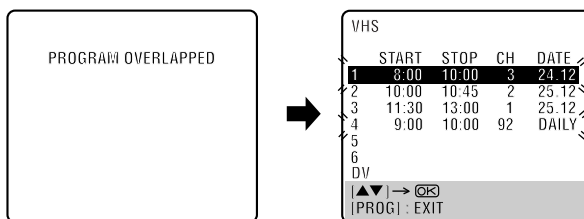

**Example:** Programme 1 (you have just made) and Programme 4 overlap each other on the VHS deck.

### 1 Confirm the overlapping programmes.

Overlapping programmes blink on the TV screen.

### 2 Select the programme to modify.

Press  $\Delta/\nabla$ , then press **OK** or  $\triangleright$ .

- You can only select one of the overlapping programmes.

### NOTE:

If you do not mind this overlap, press **PROG** to finish the timer programme setting. The programme with the lower programme number will be recorded and the other one will not be recorded correctly. If no changes are made for approximately 1 minute, the recorder will return to the normal screen.

### 3 Cancel or change programme setting.

**To cancel a programme**, press **X** when the Programme screen you do not want is shown. "PROGRAM COMPLETED" appears on the TV screen for about 5 seconds, then the normal screen appears.

**To change a programme**, press the appropriate button: **START+/-**, **STOP+/-**, **DATE+/-**, **PR+/-**, **VPS/PDC** and/or **SP/LP (///)** when the Programme screen on which you want to make changes is shown, then press **OK**. "PROGRAM COMPLETED" appears on the TV screen for about 5 seconds, then the normal screen appears.

### NOTE:

If the overlap is not yet solved, or another overlap occurs with the timer programme setting after making the last correction on a programme, the conflicting programmes will be shown on the Programme Check screen again. Repeat the above steps again until the overlap is solved.

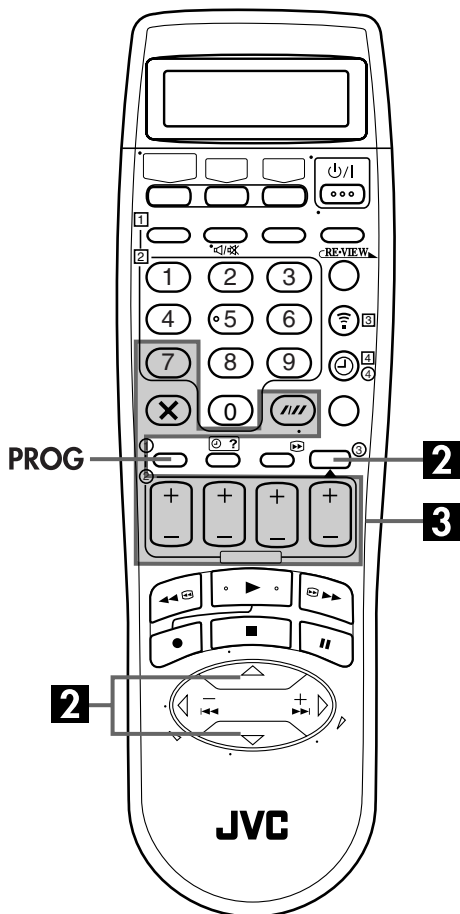

### ATTENTION

If the programme you have just made and "DV" are blinking, there is a conflicting programme on the DV deck.

- Press  $\Delta/\nabla$  to move the highlight bar to "DV", then press **OK** or  $\triangleright$ . DV Programme Check screen appears.
- Cancel or change programme setting as described in step 2 and 3 in the right column.

	START	STOP	CH	DATE
1	8:00	10:00	3	24.12
2	10:00	10:45	2	25.12
3	11:30	13:00	1	25.12
4	9:00	10:00	92	DAILY
5				
6				

	START	STOP	CH	DATE
1	9:00	10:00	20	24.12
2				
3				
4				
5				
6				

# Tape Dubbing

(from DV to VHS)

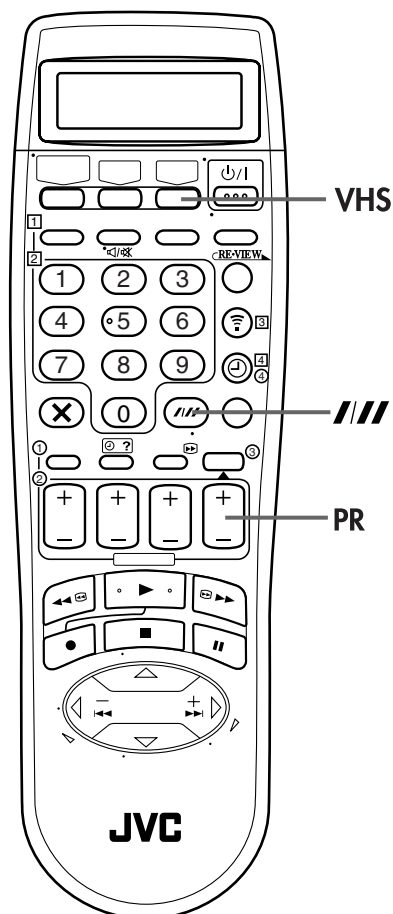
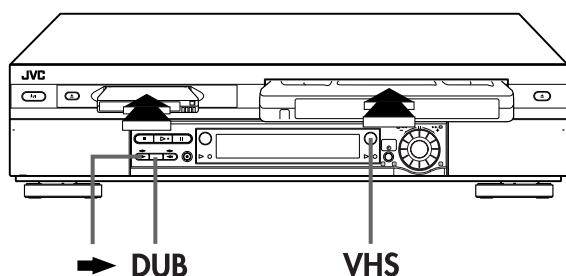

## Dubbing An Entire Cassette

Because this recorder includes both VHS deck and DV deck, you can easily use it for dubbing without connecting any other equipment.

### 1 Load cassettes.

#### For the VHS deck

Insert a VHS (or S-VHS) cassette with the record safety tab intact, or cover the hole using adhesive tape.

#### For the DV deck

Insert a Mini DV cassette with the erase protection switch set to "SAVE".

### 2 Select the dubbing direction.

Press **DUB**.

- The dubbing direction indicator (DV ⇌) lights.

### 3 Set the tape speed.

Press **VHS**, then press **SP/LP (///)**.

- "DV → VHS" appears on the TV screen if "O.S.D." is set to "ON". (pg. 69)

### 4 Start dubbing.

Press **DUB** for more than 2 seconds.

- DV playback indicator and VHS recording indicator light.
- If the tapes have not been rewound, both decks rewind automatically. The VHS deck goes into Record Pause mode, and the DV deck goes into Pause mode. When both decks have finished rewinding, dubbing begins automatically. After dubbing is completed, the decks rewind both tapes automatically and eject them. The recorder then shuts off.

### NOTES:

- If you set the dubbing direction incorrectly, you could erase an important recording that you wanted to copy. It is recommended to conduct a test with unimportant cassettes first.
- If you start dubbing a tape from a tape with a copy protection signal, the tapes will be automatically ejected, and the recorder will turn off.
- To cancel the dubbing mode, press **PR +/-** so that the dubbing direction indicator (DV ⇌) goes off.

# Tape Dubbing

(from VHS to DV)

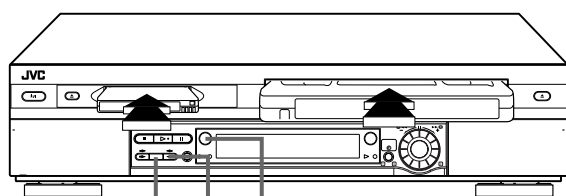

DUB ← DV

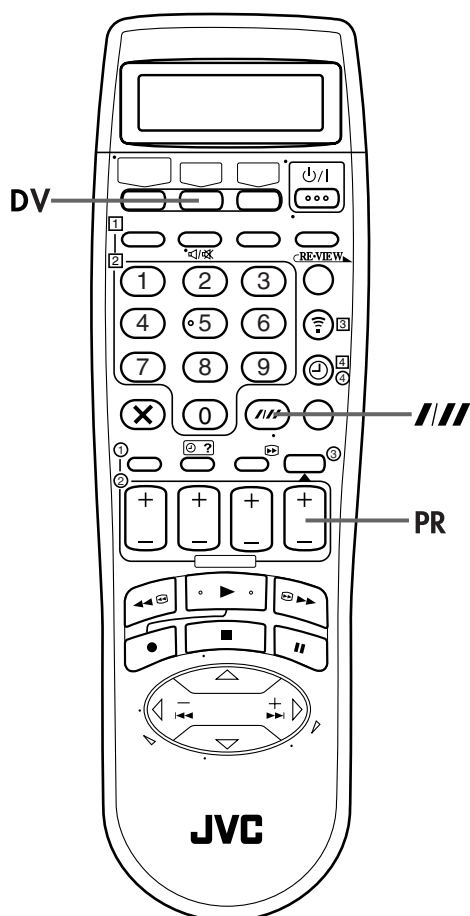

## Dubbing An Entire Cassette

Because this recorder includes both VHS deck and DV deck, you can easily use it for dubbing without connecting any other equipment.

### 1 Load cassettes.

#### For the VHS deck

Insert a VHS (or S-VHS) cassette with the record safety tab removed.

#### For the DV deck

Insert a Mini DV cassette with the erase protection switch set to "REC".

### 2 Select the dubbing direction.

Press ←.

- The dubbing direction indicator (⇔ VHS) lights.

### 3 Set the tape speed.

Press DV, then press SP/LP (///).

- "DV ← VHS" appears on the TV screen if "O.S.D." is set to "ON". (pg. 69)

### 4 Start dubbing.

Press DUB for more than 2 seconds.

- VHS playback indicator and DV recording indicator light.
- If the tapes have not been rewound, both decks rewind automatically. The DV deck goes into Record Pause mode, and the VHS deck goes into Pause mode. When both decks have finished rewinding, dubbing begins automatically. After dubbing is completed, the decks rewind both tapes automatically and eject them. The recorder then shuts off.

### NOTES:

- If you set the dubbing direction incorrectly, you could erase an important recording that you wanted to copy. It is recommended to conduct a test with unimportant cassettes first.
- If you start dubbing a tape from a tape with a copy protection signal, the tapes will be automatically ejected, and the recorder will turn off.
- To cancel the dubbing mode, press PR +/- so that the dubbing direction indicator (⇔ VHS) goes off.

# Normal Dubbing

(from DV to VHS)

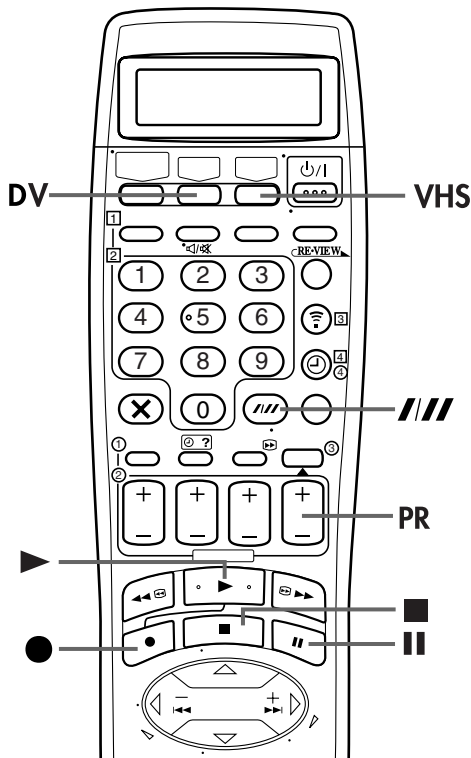
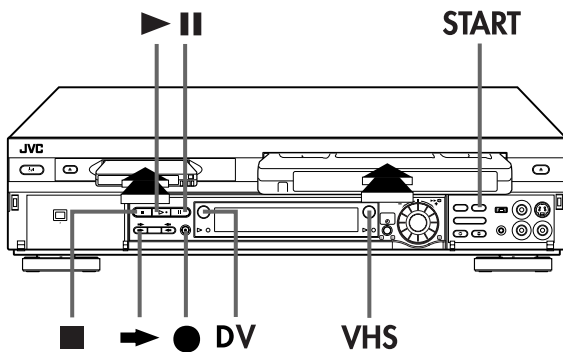

## NOTES:

- If you set the dubbing direction incorrectly, you could erase an important recording that you wanted to copy. It is recommended to conduct a test with unimportant cassettes first.
- There may be a discrepancy of several seconds between where you intend editing to start, and where it actually starts.
- The superimposed indication during the operation or dubbing is not recorded.
- To cancel the dubbing mode, press **PR +/-** so that the dubbing direction indicator (DV ⇌) goes off.
- When dubbing a Mini DV tape that was produced by audio dubbing, you need to set "12BIT MODE" to the appropriate mode before playing back the tape. (☞ pg. 73)

You can dub selected scenes on a tape, starting and stopping wherever you wish.

## 1 Load cassettes.

### For the VHS deck

Insert a VHS (or S-VHS) cassette with the record safety tab intact, or cover the hole using adhesive tape.

### For the DV deck

Insert a Mini DV cassette with the erase protection switch set to "SAVE".

## 2 Select the dubbing direction.

Press **▶**.

- The dubbing direction indicator (DV ⇌) lights.

## 3 Set the tape speed.

Press **VHS**, then press **SP/LP (///)**.

- "DV → VHS" appears on the TV screen if "O.S.D." is set to "ON". (☞ pg. 69)

## 4 Locate the start point on the DV deck.

- 1 Press **DV**.
- 2 Press **▶** to start playback.
- 3 Press **II** to pause playback a little before the start point.

## 5 Prepare the VHS deck for dubbing.

- 1 Press **VHS**.
  - 2 Press and hold **II** and press **●** so that the VHS deck enters the Record Pause mode.
- DV playback indicator and VHS recording indicator light.

## 6 Start dubbing.

Press **START**.

## 7 Pause dubbing.

Press **START**.

- The VHS deck enters the Recording Pause mode, then the DV deck enters the Dubbing Pause mode.

## 8 End dubbing.

Press **■** to stop recording on the VHS deck. Then press **DV** and press **■** to stop playback on the DV deck.

# Normal Dubbing

(from VHS to DV)

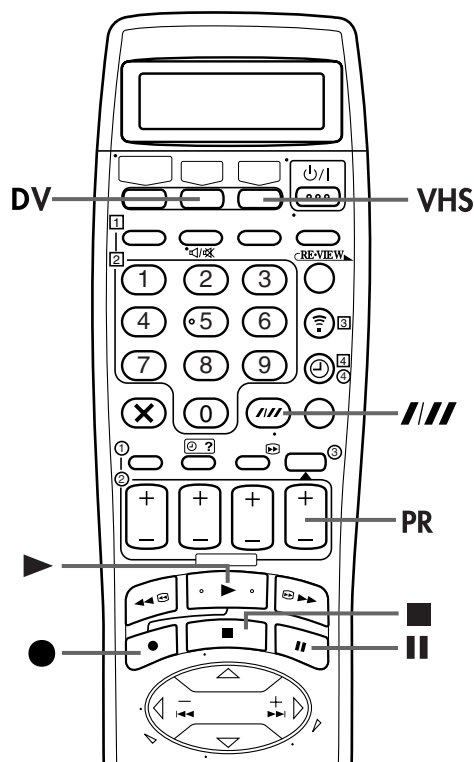
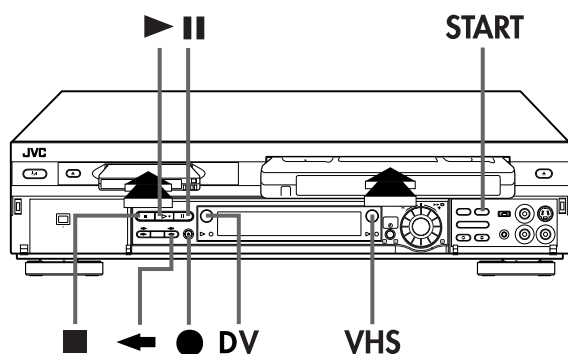

## NOTES:

- If you set the dubbing direction incorrectly, you could erase an important recording that you wanted to copy. It is recommended to conduct a test with unimportant cassettes first.
- There may be a discrepancy of several seconds between where you intend editing to start, and where it actually starts.
- The superimposed indication during the operation or dubbing is not recorded.
- To cancel the dubbing mode, press **PR +/-** so that the dubbing direction indicator (↔VHS) goes off.
- Before you start dubbing, set "SOUND MODE" to the appropriate mode. (☞ pg. 73)

You can dub selected scenes on a tape, starting and stopping wherever you wish.

## 1 Load cassettes.

### For the VHS deck

Insert a VHS (or S-VHS) cassette with the record safety tab removed.

### For the DV deck

Insert a Mini DV cassette with the erase protection switch set to "REC".

## 2 Select the dubbing direction.

Press ←.

- The dubbing direction indicator (↔VHS) lights.

## 3 Set the tape speed.

Press **DV**, then press **SP/LP (///)**.

- "DV ← VHS" appears on the TV screen if "O.S.D." is set to "ON". (☞ pg. 69)

## 4 Locate the start point on the VHS deck.

- 1 Press **VHS**.
- 2 Press ▶ to start playback.
- 3 Press **||** to pause playback a little before the start point.

## 5 Prepare the DV deck for dubbing.

- 1 Press **DV**.
  - 2 Press and hold **||** and press ● so that the DV deck enters the Record Pause mode.
- VHS playback indicator and DV recording indicator light.

## 6 Start dubbing.

Press **START**.

## 7 Pause dubbing.

Press **START**.

- The DV deck enters the Recording Pause mode, then the VHS deck enters the Dubbing Pause mode.

## 8 End dubbing.

Press ■ to stop recording on the DV deck. Then press **VHS** and press ■ to stop playback on the VHS deck.

# Edit From A Camcorder

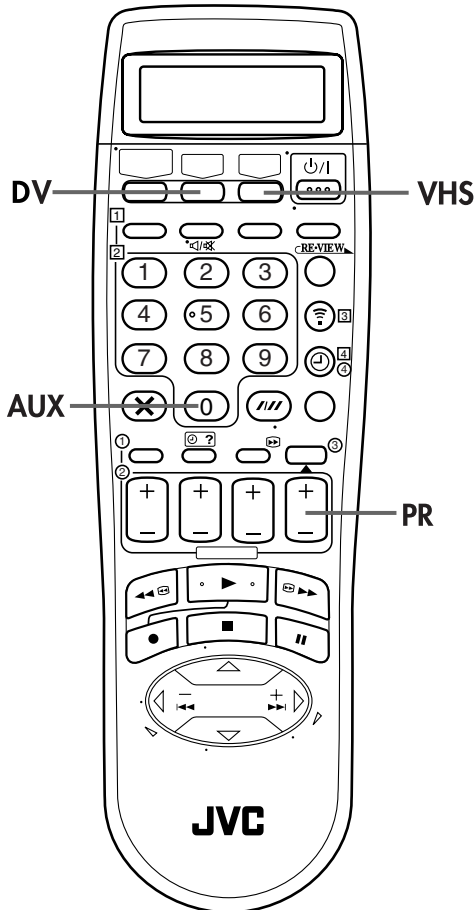

You can use a camcorder as the source player and your recorder as the recording deck. You can perform digital dubbing if you connect a device such as a camcorder which has a DV IN/OUT connector. Because the signals are digital, there is no loss of video or audio quality as a result of editing.

## 1 Make connections.

- 1 If the camcorder has no S-VIDEO output connector ... connect the camcorder's AUDIO OUT and VIDEO OUT connectors to the recorder's front panel AUDIO and VIDEO input connectors.
  - 2 If the camcorder has an S-VIDEO output connector ... connect the camcorder's AUDIO OUT and S-VIDEO OUT connectors to the recorder's front panel AUDIO and S-VIDEO input connectors.
  - 3 If the camcorder has a DV IN/OUT connector ... connect the camcorder's DV IN/OUT connector to the recorder's DV IN/OUT connector.
- When using a monaural camcorder, connect its AUDIO OUT connector to the AUDIO L input connector on your recorder.
  - When a Master Edit Control-equipped JVC camcorder is used, the camcorder is capable of controlling the recorder. Refer to the camcorder's instruction manual for operating procedure.

## 2 Set the recorder's input mode.

- Press **AUX** (number key "0") and/or **PR** to select "F-1".
- When using the VHS deck as the recording deck, set "VHS F-1 INPUT" to "VIDEO" for the AUDIO/VIDEO input connectors, or "S-VIDEO" for the AUDIO/S-VIDEO input connectors, depending on the connectors being used (☞ pg. 53).

## 3 Select the recording deck.

- Press **VHS** or **DV**.
- To edit from a camcorder to the VHS deck through the DV IN/OUT connector, press ➡.
  - To edit from a camcorder to the DV deck through the S-VIDEO (VIDEO)/AUDIO input connectors, press ←.

## 4 Set the edit mode. (VHS deck only)

See "PICTURE CONTROL" on page 70.

## 5 Start the camcorder.

Engage the Play mode of the camcorder.

## 6 Start the recorder.

Engage the Record mode of the recorder.



1 If the camcorder has no S-VIDEO output connector ...

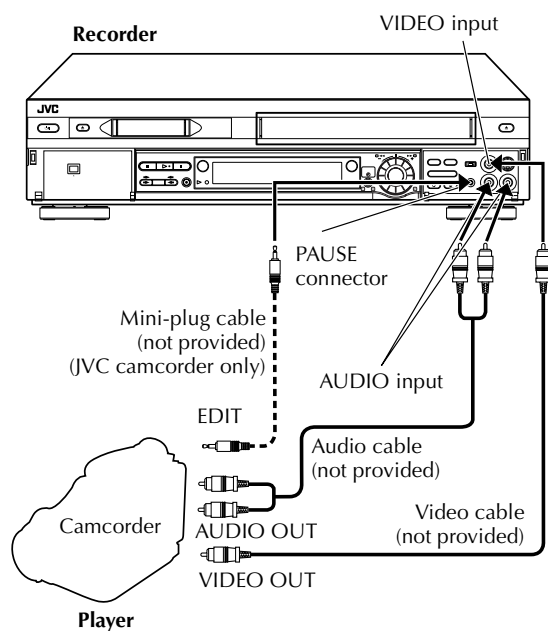

2 If the camcorder has an S-VIDEO output connector ...

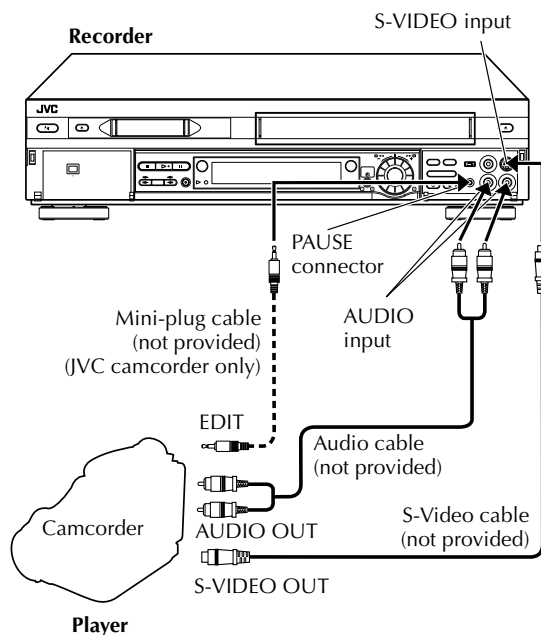

3 If the camcorder has a DV IN/OUT connector ...

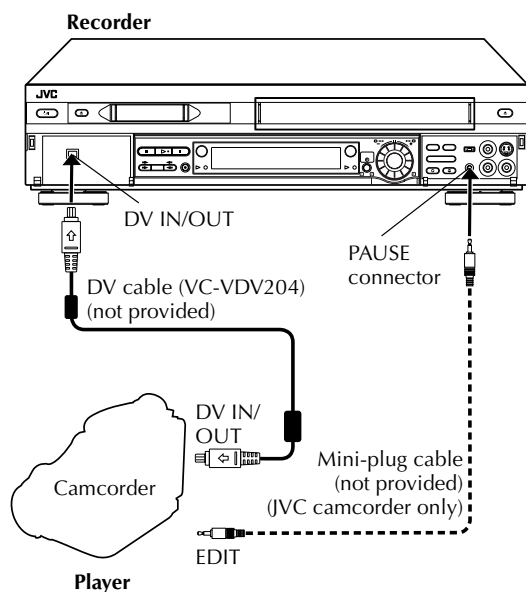

## NOTES:

### About DV IN/OUT connector

- To output digital signal when dubbing from the VHS deck to other device through the DV IN/OUT connector, press ◀, and then press ▶ to start playback on the VHS deck.
- To input digital signal when dubbing from other device to the VHS deck through the DV IN/OUT connector, press ▶ then **VHS**, and then press ● to start recording on the VHS deck.
- It is possible to control the DV deck from the AVC protocol-equipped device that is connected to the DV IN/OUT connector. To control the VHS deck, use the buttons on this recorder and the remote control.
- All necessary cables can be obtained from your dealer.
- When you select "EDIT" to dub tapes in step 4, be sure to select "AUTO" (or "NORM" when "B.E.S.T." is set to "OFF") after you finish dubbing the tapes.
- When you are editing through the DV IN/OUT connector, the recorder will stop if the signal is interrupted.
- When connecting this recorder to a device equipped with a DV input connector, be sure to use the optional DV cable (VC-VDV204).

## Simultaneous Dubbing

It is possible to perform recording simultaneously on both the VHS deck and the DV deck from the same external input.

- 1 Press **AUX** (number key "0") and/or **PR** to select the appropriate input mode depending on the connectors being used.
- 2 Press **DV** to select the DV deck. Press and hold **II** and press ● so that the DV deck enters the Record Pause mode.
- 3 Press **VHS** to select the VHS deck. Press and hold **II** and press ● so that the VHS deck enters the Record Pause mode.
- 4 Engage the Play mode of the connected device.
- 5 Press ▶ to start recording on both the VHS deck and DV deck.
- 6 Press ■ to stop recording on the VHS deck.
- 7 Press **DV** to select the DV deck, then press ■ to stop recording on the DV deck.

### NOTE:

It is not possible to record a TV programme on both the VHS deck and the DV deck simultaneously.

# Edit To Or From Another Video Recorder

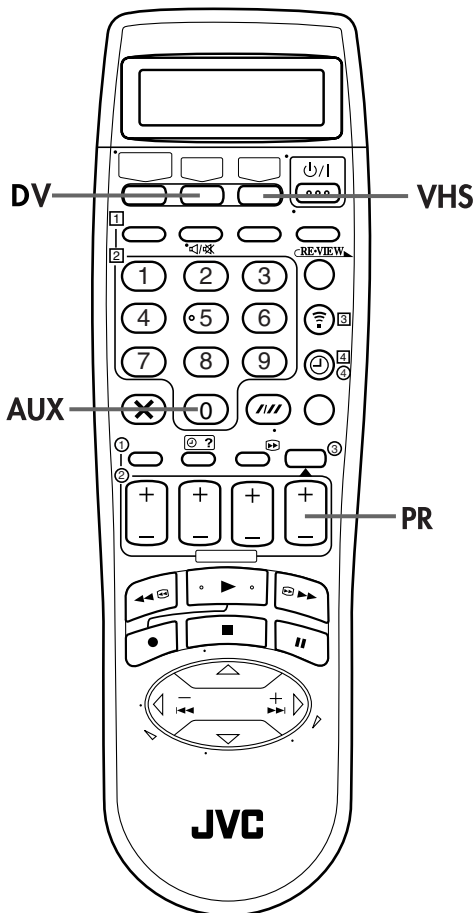

## Advantages of S-VHS video recorders

You can edit from VHS to S-VHS, S-VHS to VHS, or from S-VHS to S-VHS.

- From VHS to S-VHS: Record VHS playback signals in the S-VHS mode. Although the picture quality is inherently limited by that of the original, the edited tape has better picture quality than those made by VHS-to-VHS editing.
- From S-VHS to VHS: Because the picture quality of the source material is very high, the edited tape has better picture quality than those made by VHS-to-VHS editing.
- From S-VHS to S-VHS: All signals will be transferred with minimum degradation.

You can use your recorder as the source player or as the recording deck.

## 1 Make connections.

Connect the player's 21-pin SCART connector to the recorder's 21-pin SCART connector as illustrated on page 51.

- 1 When using your recorder as the source player ...  
... connect its AV1 (L-1) IN/OUT connector to the recording deck.
- 2 When using your recorder as the recording deck ...  
... connect its AV2 (L-2) IN/DECODER connector to the source player.
- 3 If another recorder is compatible with the Y/C signal ...  
... connect your recorder's AV1 (L-1) IN/OUT connector to another recorder.

### With 3 connection ...

- When using your recorder as the recording deck (3-a), set "L-1 INPUT" to "S-VIDEO" and "L-2 SELECT" to "A/V" (☞ pg. 52, 53).
- When using your recorder as the source player (3-b), set "L-1 OUTPUT" to "S-VIDEO" (☞ pg. 52).

## 2 Set the input mode of recording deck.

With this video recorder, press **AUX** (number key "0") and/or **PR** to select "L-1" for the AV1 (L-1) IN/OUT connector, or "L-2" for the AV2 (L-2) IN/DECODER connector, depending on the connector being used.

- When using another recorder as the recording deck, refer to its instruction manual.
- When using the AV2 (L-2) IN/DECODER connector, set "L-2 SELECT" to "A/V" (☞ pg. 53).

## 3 Select the recording deck.

Press **VHS** or **DV**.

## 4 Set the edit mode. (VHS deck only)

See "PICTURE CONTROL" on page 70.

## 5 Start the source player.

Engage the Play mode of the source player.

## 6 Start the recording deck.

Engage the Record mode of the recording deck.

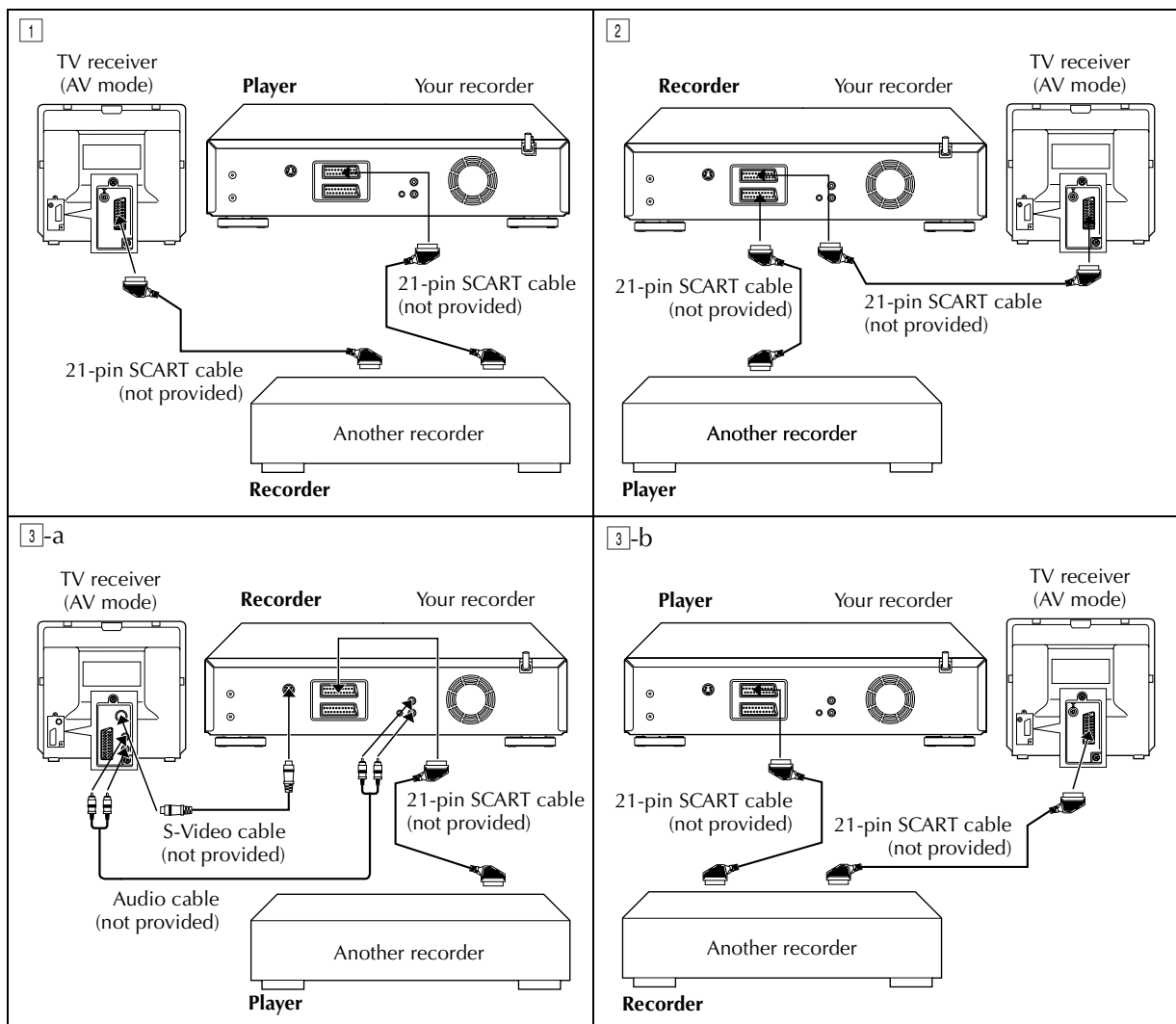

## NOTES:

- All necessary cables can be obtained from your dealer.
- For Y/C signal input/output, be sure to use a 21-pin SCART cable that is compatible with the Y/C signal.
- When you select "EDIT" to dub tapes in step 4, be sure to select "AUTO" (or "NORM" when "B.E.S.T." is set to "OFF") after you finish dubbing the tapes.
- When you use this recorder as the source player for editing, be sure to set "O.S.D." to "OFF" before starting (☞ pg. 69).
- If you are using another recorder with S-Video and Audio input/output connectors, you can connect those connectors to this recorder's S-VIDEO and AUDIO input/output connectors.  
 When using your recorder as the source player ...  
 ... connect its rear panel S OUT and AUDIO OUT connectors to the recording deck's S-Video and Audio input connectors.  
 When using your recorder as the recording deck ...  
 ... connect its front panel S-VIDEO and AUDIO input connectors to the source player's S-Video and Audio output connectors. Then, set the recorder's input mode to "F-1", and set "VHS F-1 INPUT" to "S-VIDEO" (☞ pg. 53).

# Output/Input Set

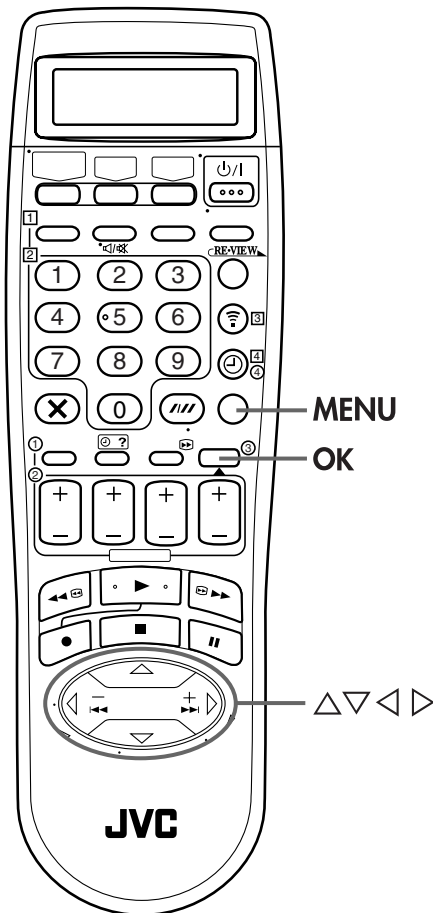

## L-1 OUTPUT and L-1 INPUT Setting

The AV1 (L-1) IN/OUT connector accepts and delivers either a composite signal (regular video signal) or a Y/C signal (a signal in which the luminance and chrominance signals are separated). Set "L-1 OUTPUT" and "L-1 INPUT" to the appropriate mode depending on the type of appliance connected to the recorder's AV1 (L-1) IN/OUT connector.

### 1 Access the Main Menu screen.

Press MENU.

### 2 Access the Output/Input Set screen.

Press  $\Delta$ / $\nabla$  to move the highlight bar (pointer) to "OUTPUT/INPUT SET", then press OK or  $\triangleright$ .

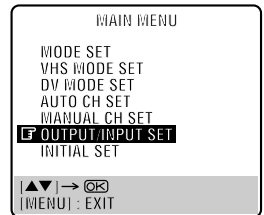

### 3 Select the output or input mode for the AV1 (L-1) IN/OUT connector.

Press  $\Delta$ / $\nabla$  to move the highlight bar (pointer) to "L-1 OUTPUT" or "L-1 INPUT". Then, press OK or  $\triangleright$  to select the appropriate setting.

\* The default setting is **bold** in the table below.

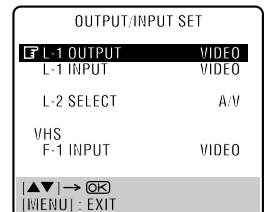

#### ■ L-1 OUTPUT

**VIDEO:** If a connected appliance's input is compatible only with regular video signals, set to "VIDEO".

**S-VIDEO:** If a connected appliance's input is compatible with Y/C signals, set to "S-VIDEO". You can obtain high-quality S-VHS picture. (For connection, be sure to use a 21-pin SCART cable that is compatible with the Y/C signal.)

#### ■ L-1 INPUT

**VIDEO:** If a connected appliance's output is compatible only with regular video signals, set to "VIDEO".

**S-VIDEO:** If a connected appliance's output is compatible with Y/C signals, set to "S-VIDEO". You can obtain high-quality S-VHS picture. (For connection, be sure to use a 21-pin SCART cable that is compatible with the Y/C signal.)

### 4 Return to the normal screen.

Press MENU.

#### NOTES:

- If "L-1 OUTPUT" is set to "S-VIDEO", it is impossible to set "L-1 INPUT" to "S-VIDEO".
- If "L-2 SELECT" is set to "DECODER", it is impossible to set "L-1 INPUT" to "S-VIDEO".

## L-2 SELECT Setting

Set "L-2 SELECT" to the appropriate mode depending on the type of appliance connected to the recorder's AV2 (L-2) IN/DECODER connector.

Perform steps 1 and 2 of "L-1 OUTPUT and L-1 INPUT Setting" on page 52.

### 1 Select the input mode for the AV2 (L-2) IN/DECODER connector.

Press  $\Delta$ / $\nabla$  to move the highlight bar (pointer) to "L-2 SELECT". Then, press **OK** or  $\triangleright$  to select the appropriate setting.

\* The default setting is **bold** in the table below.

OUTPUT/INPUT SET	
L-1 OUTPUT	VIDEO
L-1 INPUT	VIDEO
<b>L-2 SELECT</b>	<b>A/V</b>
VHS F-1 INPUT	VIDEO
▲▼ → ⊞	
[MENU]: EXIT	

#### ■ L-2 SELECT

**A/V:** To use this recorder as the recording deck with the player connected to the AV2 (L-2) IN/DECODER connector, or to use the satellite receiver connected to the AV2 (L-2) IN/DECODER connector.

**DECODER:** To use a decoder connected to the AV2 (L-2) IN/DECODER connector.

**SAT:** To view a satellite programme with the TV set while the recorder is turned off. (ⓘ pg. 64)

### 2 Return to the normal screen.

Press **MENU**.

#### NOTES:

- If you have a satellite receiver or a decoder connected to the AV2 (L-2) IN/DECODER connector, be sure to set "L-2 SELECT" back to appropriate mode after editing.
- If you are not connecting a satellite receiver or a decoder to the AV2 (L-2) IN/DECODER connector, leave "L-2 SELECT" set to "A/V".
- The default setting is "A/V"; if the recorder's memory backup has expired due to a power cut or because the AC was removed from the recorder, "A/V" will be automatically selected when the power is restored to the recorder. If you are using a satellite receiver or a decoder, be sure to set "L-2 SELECT" back to appropriate mode.
- When "L-2 SELECT" is set to "SAT", "SAT" appears on TV screen or front display panel instead of "L-2" or "L2".
- If "L-1 OUTPUT" is set to "S-VIDEO", it is impossible to set "L-2 SELECT" to "DECODER".

## VHS F-1 INPUT Setting

Set "VHS F-1 INPUT" to the appropriate mode depending on the connector (VIDEO or S-VIDEO input connector) being used on the front panel.

Perform steps 1 and 2 of "L-1 OUTPUT and L-1 INPUT Setting" on page 52.

### 1 Select the input mode for the VIDEO/S-VIDEO connector.

Press  $\Delta$ / $\nabla$  to move the highlight bar (pointer) to "VHS F-1 INPUT". Then, press **OK** or  $\triangleright$  to select the appropriate setting.

\* The default setting is **bold** in the table below.

OUTPUT/INPUT SET	
L-1 OUTPUT	VIDEO
L-1 INPUT	VIDEO
L-2 SELECT	A/V
<b>VHS F-1 INPUT</b>	<b>VIDEO</b>
▲▼ → ⊞	
[MENU]: EXIT	

#### ■ VHS F-1 INPUT

**VIDEO:** If a connected appliance's output is compatible only with regular video signals, set to "VIDEO".

**S-VIDEO:** If a connected appliance's output is compatible with Y/C signals, set to "S-VIDEO". You can obtain high-quality S-VHS picture. (For connection, be sure to use a 21-pin SCART cable that is compatible with the Y/C signal.)

### 2 Return to the normal screen.

Press **MENU**.

# Audio Dubbing

## VHS Audio Dubbing

Audio Dubbing replaces the normal audio sound of a previously recorded tape with a new soundtrack.

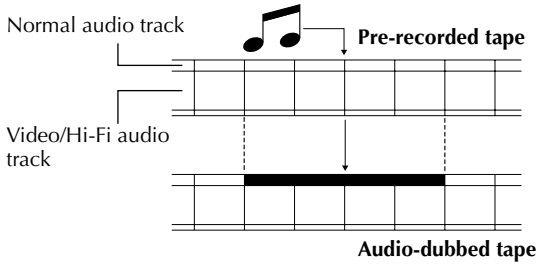

## DV Audio Dubbing

This function lets you record new audio, without erasing the original audio, on a DV tape that was recorded with "SOUND MODE" set to "12BIT" (☞ pg. 73).

### ATTENTION:

You cannot perform Audio Dubbing on a tape that was recorded with "SOUND MODE" set to "16BIT" (☞ pg. 73), on a tape that was recorded at the "LP" speed, or on a blank tape.

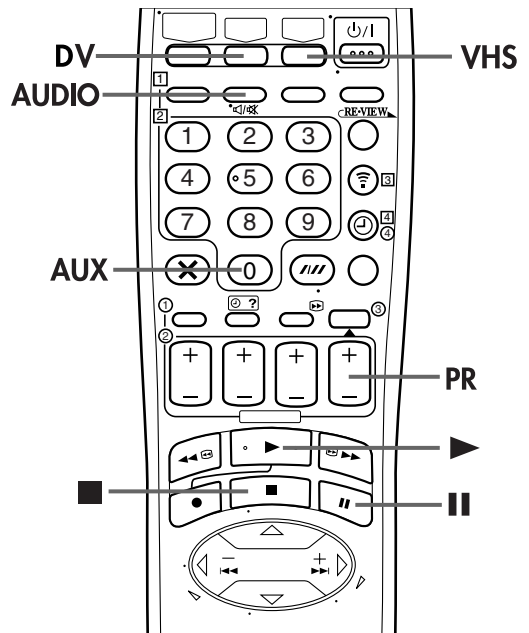
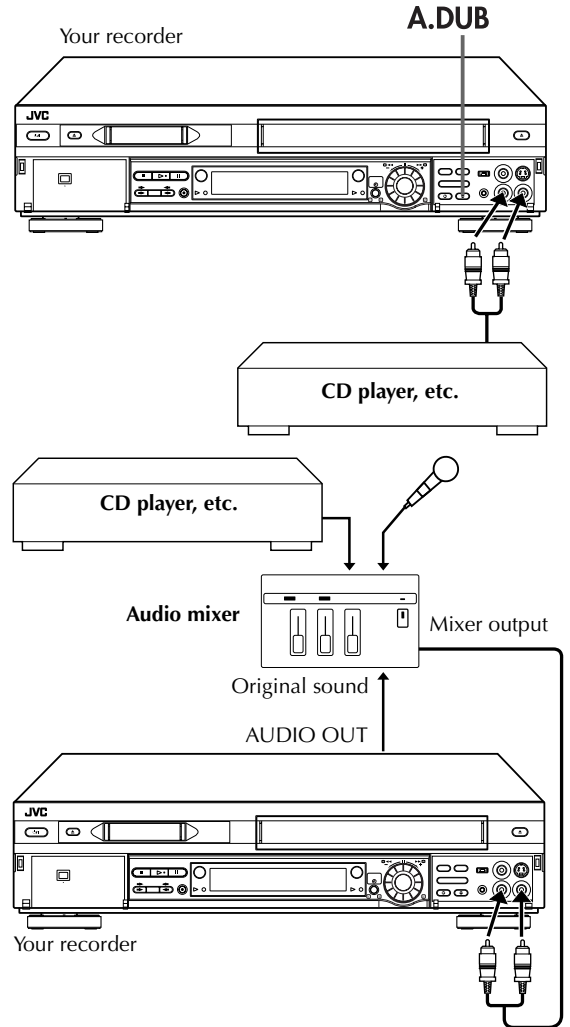

## 1 Make connections.

Connect an audio component to the AUDIO L + R input connectors on the recorder's front panel.

- When connecting a monaural audio component, use only the recorder's AUDIO L input connector.

## 2 Load a cassette.

**For the VHS deck**

Insert a VHS (or S-VHS) cassette with the record safety tab intact, or cover the hole using adhesive tape.

**For the DV deck**

Insert a Mini DV cassette with the erase protection switch set to "REC".

## 3 Select the recording deck.

Press **VHS** or **DV**.

- When using the DV deck as the recording deck, press ◀ so that the audio signals from the AUDIO L + R input connectors can be recorded. The dubbing direction indicator (↔ VHS) lights.

## 4 Set the recorder's input mode.

Press **AUX** (number key "0") and/or **PR** to select "F-1".

## 5 Locate the start point.

Press ▶ to start playback of the tape in your recorder, and press II when you reach the point where you want to start dubbing.

## 6 Engage the Audio Dubbing mode.

Press **A.DUB**.

- Your recorder enters the Audio Dubbing Pause mode. ("○" blinks, "▶" and "■" light up on the front display panel.)
- To perform Audio Dubbing with audio mixing, press **AUDIO** to select "HI FI L [L] R" or "L [L] R" at this point. When using the DV deck as the recording deck, also make sure that "12BIT MODE" is set to "SOUND1" (☞ pg. 73).

\* Audio Dubbing with audio mixing is not possible if you are using a monaural audio component, or if you don't have an audio mixer.

## 7 Start dubbing.

Engage the audio component's Play mode, then press ▶ to start the tape in your recorder; Audio Dubbing begins at this point.

- "○" blinks and "▶" is displayed on the front display panel.
- To stop dubbing temporarily, press II. Press ▶ to resume dubbing.

## 8 End Audio Dubbing.

Press ■ to stop the tape in your recorder, and engage the audio component's Stop mode.

### NOTES:

- Once the Audio Dubbing starts, you can not use the other deck.
- When monitoring the audio-dubbed sound on the DV deck, set "12BIT MODE" to "SOUND2" (☞ pg. 73).
- When monitoring the sound during Audio Dubbing, the normal soundtrack is automatically selected. If you wish to hear the mixed sound (Hi-Fi + Normal soundtracks), press **AUDIO** to select "HI FI NORM" (☞ pg. 25). (VHS deck only)
- Audio Dubbing stops automatically when the counter reaches "0:00:00", and the recorder enters the Play mode. Check the counter reading before dubbing. (VHS deck only)
- Audio Dubbing is also possible using the rear panel AV1 (L-1) IN/OUT or AV2 (L-2) IN/DECODER connector. When using these 21-pin SCART connectors, be sure to select the correct input mode ("L-1" or "L-2") in step 4.
- When playing back an audio-dubbed tape on the VHS deck, press **AUDIO** on the remote control to select the soundtrack you wish to hear (☞ pg. 25). When playing back an audio-dubbed Mini DV tape on the DV deck, set "12BIT MODE" to "SOUND2" (☞ pg. 73).
- Audio dubbing is not possible using the DV IN/OUT connector.
- Audio dubbing is not possible on a blank portion of the tape.

# Insert Editing

## VHS Insert Editing

Insert Editing replaces part of the recorded scene with new material. Both the picture and Hi-Fi audio soundtrack are replaced with new ones, while the normal audio soundtrack remains unchanged. If you wish to change the normal audio track as well, use the Audio Dubbing function simultaneously. For Insert Editing, use your recorder as the recording deck.

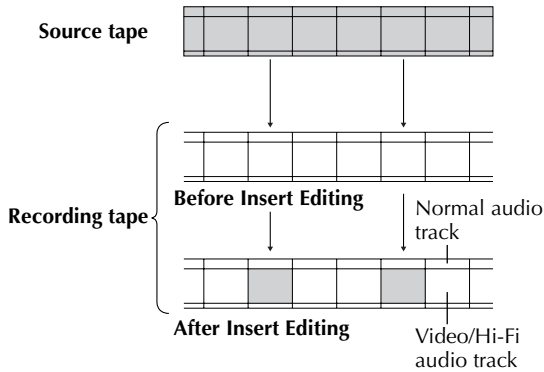

## DV Insert Editing (SP mode only)

The picture is replaced with new one, while the audio soundtrack remains unchanged. For Insert Editing, use your recorder as the recording deck.

### ATTENTION:

Insert Editing is not possible with a Mini DV cassette recorded in LP mode or a blank tape.

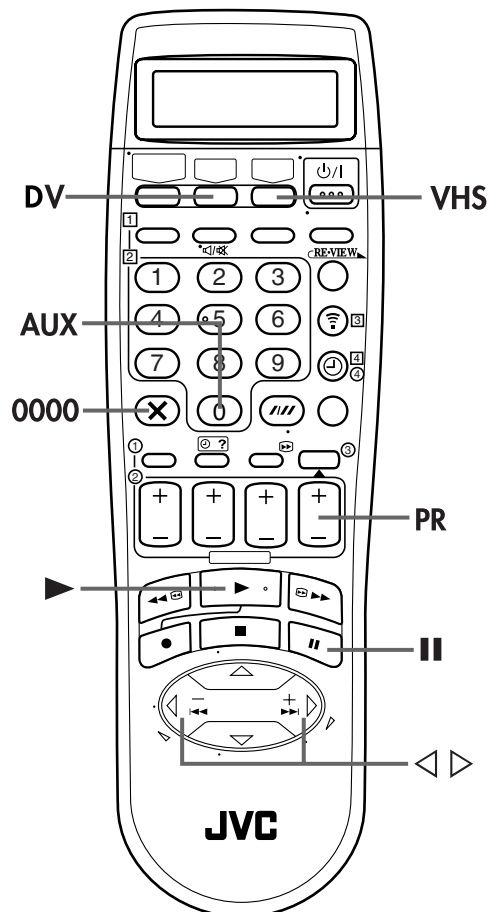
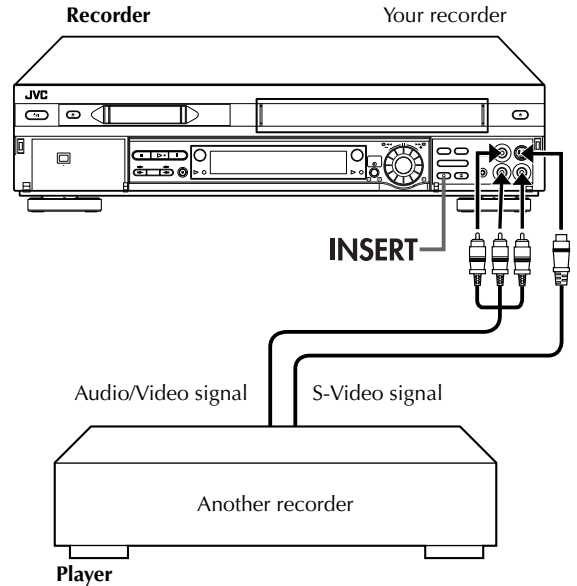



## 1 Make connections.

Connect the player's VIDEO OUT or S-VIDEO OUT and AUDIO OUT connectors to your recorder's VIDEO or S-VIDEO and AUDIO input connectors on the front panel.

## 2 Set the recorder's input mode.

Press **AUX** (number key "0") and/or **PR** to select "F-1".

- When using the VHS deck as the recording deck, set "VHS F-1 INPUT" to "VIDEO" for the AUDIO/VIDEO input connectors, or "S-VIDEO" for the AUDIO/S-VIDEO input connectors, depending on the connectors being used. (☞ pg. 53)

## 3 Select the recording deck.

Press **VHS** or **DV**.

- When using the DV deck as the recording deck, press ◀ so that the video and audio signals from the VIDEO/S-VIDEO and AUDIO L + R input connectors can be recorded. The dubbing direction indicator (↔ VHS) lights.

## 4 Prepare the recording cassette.

**For the VHS deck**

Load the recording cassette into the VHS deck, and play it back to determine the edit-out point (the end of the segment to be replaced) using the **JOG** dial, or pressing ◀ ▷ and **II**.

Then press **0000** to reset the counter.

**For the DV deck**

Load the recording cassette into the DV deck.

## 5 Locate the start point.

Determine the edit-in point (the beginning of the segment to be replaced) using the **JOG** dial, or pressing ◀ ▷ and **II**.

- Be sure to engage the Still mode at the edit-in point.

## 6 Engage the Insert Editing mode.

Press **INSERT**.

- Your recorder enters the Insert Pause mode. ("○", "▶" and "⏏" light up on the front display panel.)
- The TV screen changes from the still picture to the input source you are going to record.

## 7 Start Editing.

Load the source cassette and play back the segment that is to be inserted. When you reach the start of the section of the source tape that you wish to insert, press ▶ to start the tape in your recorder; Insert Editing begins at this point.

- "○" and "▶" are displayed on the front display panel.

## 8 End Insert Editing.

**For the VHS deck**

At counter "0:00:00", Insert Editing will stop automatically while the tape continues running in the Play mode. If you wish to stop Insert Editing before the specified edit-out point, press **0000**.

**For the DV deck**

Press ■ to stop recording on the DV deck.

## AV Insert Editing (VHS deck only)

If you want to replace the picture, Hi-Fi audio soundtrack and normal audio soundtrack all at the same time ...

... In step 6, after you press **INSERT**, press **A.DUB** also.

("○" and "▶" blink and "⏏" lights up on the front display panel.)

### NOTES:

- Once the Insert Editing starts, you can not use the other deck.
- All necessary cables can be obtained from your dealer.
- Insert Editing cannot be performed on a VHS (or S-VHS) cassette that has had its record safety tab removed, or on a Mini DV cassette that has had its erase protection switch set to "SAVE".
- When Insert Editing is performed on a tape that has been recorded on another video recorder, the inserted portion may appear distorted.
- In Insert Editing, the recording speed (SP/LP) is determined by the previous recording to be replaced. If the previous recording's speed changes within a single edit, the inserted picture will be distorted at the switching point. (VHS deck only)
- A small portion of the recording which precedes an insert edit may become erased.
- Insert Editing is also possible using the rear panel AV1 (L-1) IN/OUT or AV2 (L-2) IN/DECODER connector. When using these 21-pin SCART connectors, be sure to select the correct input mode ("L-1" or "L-2") in step 3.
- Insert Editing is not possible using the DV IN/OUT connector.
- Insert Editing is not possible on a blank portion of the tape.

# Random Assemble Editing

## 64-programme Editing Memory (8 programmes x 8 scenes)

By using the Random Assemble Editing function, you can select up to 8 scenes from a previously recorded Mini DV cassette and automatically dub them onto a VHS cassette. Random Assemble Editing is possible only when dubbing from the DV deck to the VHS deck.

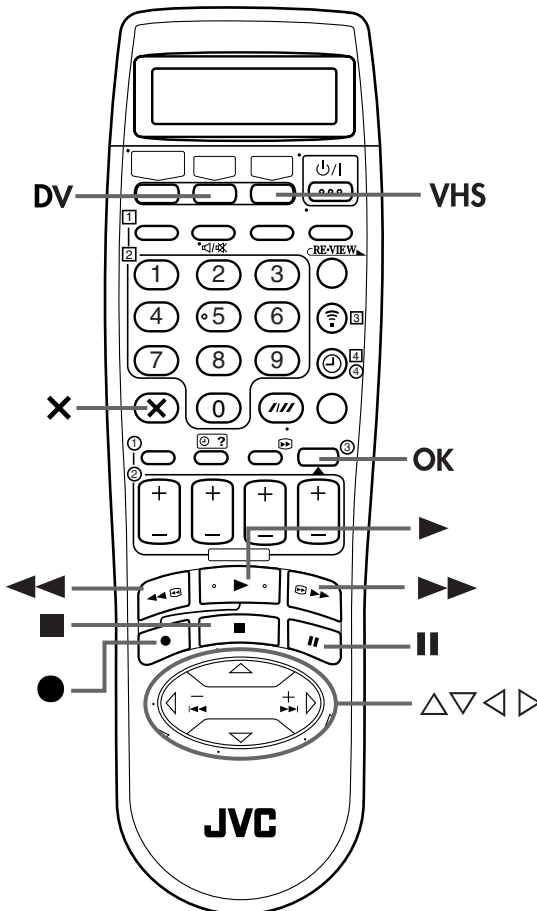
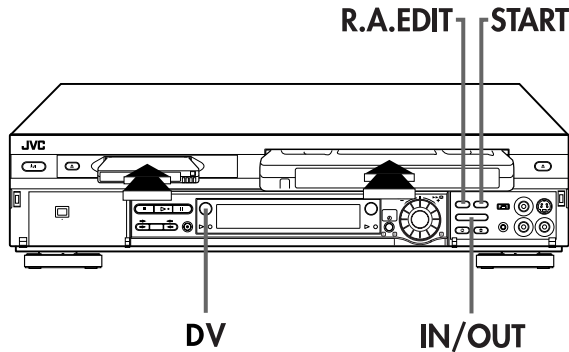

### 1 Load cassettes.

Insert a VHS (or S-VHS) cassette and a Mini DV cassette.

### 2 Select the DV deck.

Press DV.

### 3 Access the R.A.Edit screen.

Press R.A.EDIT. The R.A.Edit screen appears.

### 4 Select the programme.

Press  $\Delta$ / $\nabla$  to move the pointer to select one programme you want to edit, then press OK or  $\triangleright$ .

- If you want to remove a programme from the R.A.EDIT screen, press X in step 5 and 6 to delete all the edit-in and edit-out points.

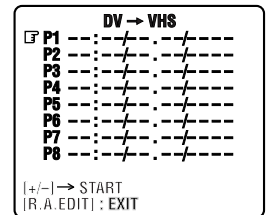

### 5 Locate the start point.

Press  $\blacktriangleright$  to start playback. Find the edit-in point on the source tape from where you want the edited scene to begin by pressing  $\mathbb{I}$ , then press IN/OUT.

- The edit-in point is registered in memory and appears on the screen.

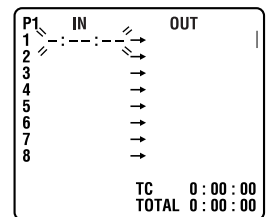

## 6 Locate the end point.

Press ► to start playback. Find the edit-out point where you want the edited scene to end by pressing ■, then press IN/OUT.

- The edit-out point is registered in memory and appears on the screen.
- The total time of the edited scenes is displayed to the right of "TOTAL".
- Repeat steps 5 and 6 for each additional scene.

P1	IN	OUT
1	0 : 02 : 23	→ -- : -- : --
2		→
3		→
4		→
5		→
6		→
7		→
8		→
TC		0 : 02 : 23
TOTAL		0 : 00 : 00

P1	IN	OUT
1	0 : 02 : 23	→ 0 : 02 : 51
2		→
3		→
4		→
5		→
6		→
7		→
8		→
TC		0 : 02 : 51
TOTAL		0 : 00 : 28

## To Make Corrections ...

... in step 5 or 6, you can cancel registered in and out points by pressing X. Each time you press, the preceding point is erased.

- If, for example, you have registered 5 sets of in and out points and want to reset the first set, you have to press X until all points after the first set have been erased. Reenter them after you have repaired the first set of points.

## NOTES:

- When Random Assemble Editing does not work, press ➡, then perform Random Assemble Editing again.
- To cancel the registered scene, press X. Each time X is pressed, the latest registered scene is erased.
- When the source tape has more than 2 identical time codes (ⓘ pg. 35), the recorder may not find the edit-in point you set and a malfunction may occur.
- When choosing a scene, set edit-in and edit-out points so that there's a relatively large difference between them.
- If the search time for an in-point exceeds 5 minutes, the VHS deck's Record-Pause mode will be cancelled and editing will not take place.
- If there are blank portions before or after the edit-in and edit-out points, a blue-backed screen may be included in the edited version.
- Since time codes register time only as accurately as seconds, the time code total time may not match the total programme time exactly.
- To use Random Assemble Editing consecutively for two or more programmes, press **START** for each programme. When dubbing from another Mini DV cassette, change the Mini DV cassette first, and then press **START**.

## 7 Prepare the source tape.

Rewind the tape in the DV deck to the beginning of the scene you want to edit.

## 8 Prepare the VHS deck for dubbing.

- 1 Press **VHS**.
- 2 Search for the point where you want to start dubbing by pressing ►, ►► or ◀◀ then press ■.
- 3 Press ●, then the VHS deck enters the Record Pause mode.

## 9 Start Random Assemble Editing.

Press **START** (or **OK**).

- Automatic editing begins; all the specified scenes are copied to the VHS deck in the order they were registered.
- The on-screen display remains while your recorder searches for each scene (blinking cursor indicates scene currently being searched for), but disappears during actual editing.
- During scene search, the VHS deck automatically enters its Record-Standby mode.
- When all registered scenes have been edited, the DV deck enters the Pause mode, the VHS deck enters its Record Pause mode, and the arrow blinks at the next available number.

## 10 End Random Assemble Editing.

Press **R.A.EDIT** twice to return to the normal screen. Press ■ to stop the VHS deck's Record Pause mode. Press **DV**, then press ■ to stop the DV deck's Pause mode.

# Remote Control Functions

## Remote A/B/C/D Code Switching

The remote control is capable of controlling four JVC video recorders independently. Each of recorders can respond to one of four codes (A, B, C or D). The remote control is preset to send A code signals because your video recorder is initially set to respond to A code signals. You can easily modify your video recorder to respond to B, C or D code signals.

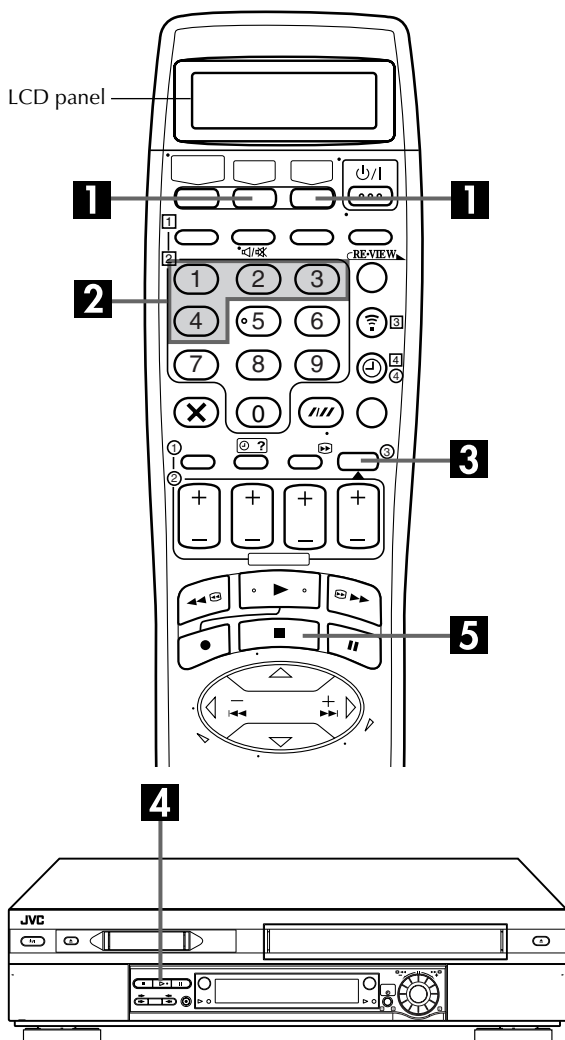

### On the remote control

#### 1 Display the code.

Press and hold **VHS** or **DV** on the remote control for over 2 seconds. The code currently set blinks on the LCD panel.

#### 2 Change the remote control code.

Press the **number key "1"** for A, **"2"** for B, **"3"** for C or **"4"** for D.

#### 3 Set the remote control code.

Press **OK** to set the code.

### On the recorder

#### 4 Display the code.

Press **▶** on the recorder for over 5 seconds while the recorder is turned off. The code currently set appears on the front display panel.

- If the code displayed on the front display panel is different from the code set on the remote control, go to step 5.

#### 5 Change the recorder's code.

Press **■** on the remote control. The code currently set on the remote control will be applied to the recorder.

#### NOTE:

When "POWER SAVE" is set to "ON" (pg. 69), it is impossible to change the remote code.

## TV Multi-Brand Remote Control

Your remote control can operate the basic functions of your TV set. In addition to JVC TVs, other manufacturer's TVs can also be controlled.

### Before performing the following steps:

Turn off the TV using its remote control.

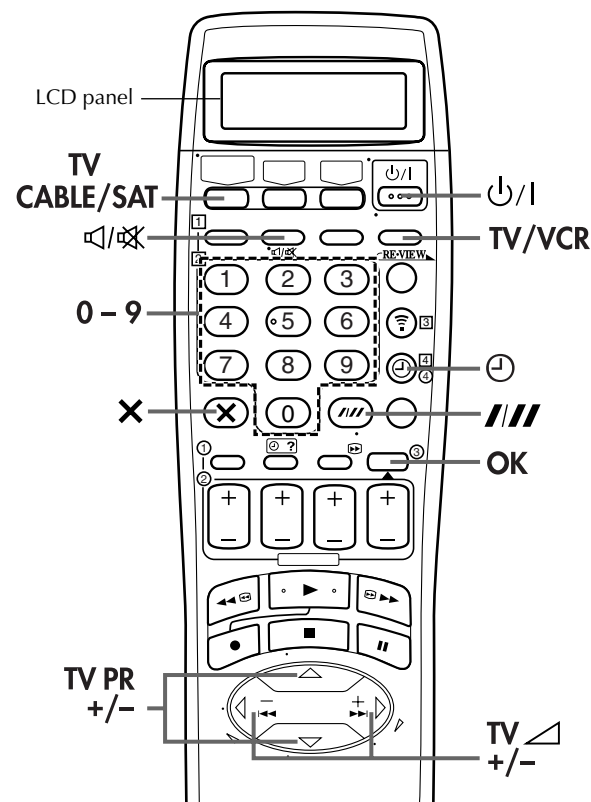

### IMPORTANT

Although the provided remote control unit is compatible with JVC televisions, as well as many other models, it may not work with your TV, or in some instances, may have limited function capability.

### Control Your TV Using Additional Buttons

Use the **number keys**, and the **///** button, **X** button or **⊖** button to select the TV's channel.

- With televisions under Code 01, 02, 07, 10, 11, 14, 20, 23, 24, 25, 27, 33 or 35, the **///** button corresponds to the 1-digit/2-digit entry switching button (often labelled -/-) of your TV's remote control.
- With televisions under Code 01, 28, 29 or 34, the **X** button corresponds to the 10 + button, and the **⊖** button corresponds to the 20 + button of your TV's remote control.

### NOTE:

The way these buttons are used is determined by your TV. Use these buttons as instructed for your TV's remote control.

## 1 Set the TV brand code.

Press **TV/CABLE/SAT** to switch the display to "TV" and keep pressing the button down until "TV-\_" appears. Enter your TV's brand code using the **number keys**, then press **OK**.

Press **⏻** on the recorder's remote control to turn on the TV and try operations (see step 2).

- Once you have set the remote control to operate the TV, you do not have to repeat this step until you replace your remote control's batteries.
- Some brands of TV have more than one code. If the TV does not function with one code, try entering another.

## 2 Operate the TV.

First, press **TV/CABLE/SAT** to switch the display to "TV". Then press the corresponding button: **⏻**, **TV/VCR**, **TV PR +/-**, **TV** **⏪**+/- (Volume), **⏸** (TV Muting), **number keys**.

- For some brands of TV, you must press **OK** after having pressed the **number keys**.
- To return the remote control to video recorder control, press **VHS** or **DV**.

BRAND NAME	CODE
JVC	01, 23, 24, 25
BLAUPUNKT	19
BRANDT	26
FERGUSON	27
FINLUX	30
FUNAI	32
LG/GOLDSTAR	18
GRAETZ	28
GRUNDIG	19
HITACHI	10
ITT	28
LUXOR	28
MITSUBISHI	03
MIVAR	29
NEC	20
NOKIA	31
NORDMENDE	26
PANASONIC	11
PHILIPS	02
SABA	26
SALORA	28
SAMSUNG	02, 12, 33, 34, 35
SELECO	28
SHARP	06
SONY	07
TELEAVIA	26
TELEFUNKEN	26
THOMSON	26
TOSHIBA	14

## Satellite Receiver Multi-Brand Remote Control

Your remote control can operate the basic functions of your satellite receiver set. In addition to JVC satellite receivers, other manufacturer's satellite receivers can also be controlled.

### Before performing the following steps:

Turn off the satellite receiver using its remote control.

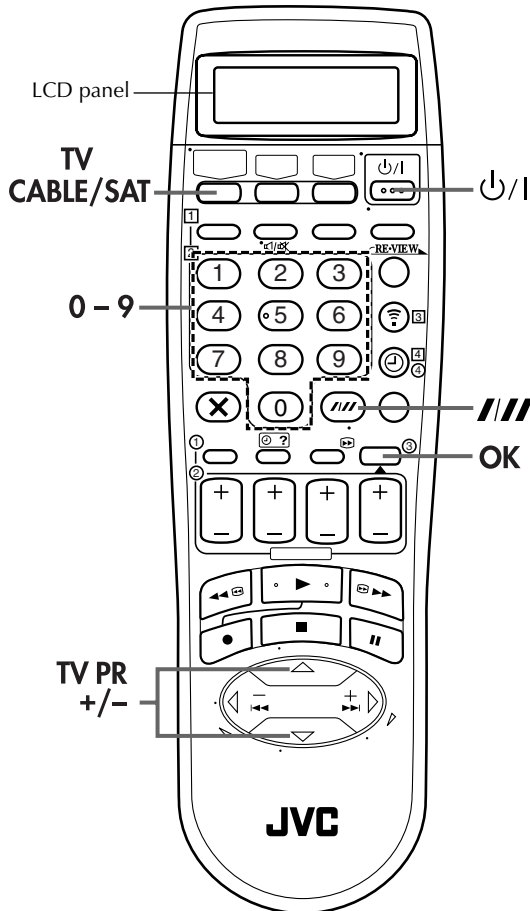

### IMPORTANT

Although the provided remote control unit is compatible with JVC satellite receivers, as well as many other models, it may not work with your satellite receiver, or in some instances, may have limited function capability.

## 1 Set the satellite receiver brand code.

Press **TV/CABLE/SAT** to switch the display to "CABLE SAT" and keep pressing the button down until "SATCBL-\_\_" appears.

Enter your satellite receiver's brand code using the **number keys**, then press **OK**.

Press **1/1** on the recorder's remote control to turn on the satellite receiver and try operations (see step 2).

- Once you have set the remote control to operate the satellite receiver, you do not have to repeat this step until you replace your remote control's batteries.
- Some brands of satellite receiver have more than one code. If the satellite receiver does not function with one code, try entering another.

## 2 Operate the satellite receiver.

First, press **TV/CABLE/SAT** to switch the display to "CABLE SAT".

Then press the corresponding button: **1/1**, **TV PR +/-**, **number keys**.

- For some brands of satellite receiver, you must press **///** after having pressed the **number keys**.
- The **number keys** may not function with some satellite receivers.
- To return the remote control to video recorder control, press **VHS** or **DV**.

BRAND NAME	CODE
JVC	73
AMSTRAD	60, 61, 62, 63, 92
CANAL SATELLITE	81
CANAL +	81
D-BOX	85
ECHOSTAR (VIA DIGITAL)	82
FINLUX	68
FORCE	89
GALAXIS	88
GRUNDIG	64, 65
HIRSCHMANN	64, 78
ITT NOKIA	68
JERROLD	75
KATHREIN	70, 71
LUXOR	68
MASCOM	93
MASPRO	70
NOKIA	87
PACE	65, 67, 74, 86, 92
PANASONIC	74
PHILIPS	66, 84
RFT	69
SAGEM	83
SALORA	68
SIEMENS	64
SKYMASTER	69
TPS	83
TRIAx	91
WISI	64

# Connecting To A Printer

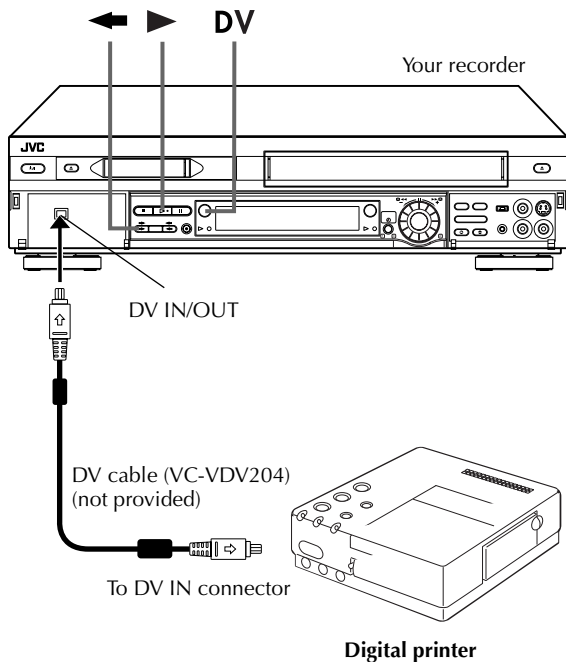

You can make printouts of video images by connecting the GV-DT1/GV-DT3 Digital Printer (sold separately) to the DV IN/OUT connector.

## 1 Make connections.

Connect the printer's DV IN connector to the recorder's DV IN/OUT connector.

## 2 Select the deck.

Press **DV**.

- When you use the VHS deck ...  
... Press **←**. The dubbing direction indicator (↔ VHS) lights.

## 3 Start playback.

Press **▶**.

- The image being displayed on the TV screen is output to the digital printer. Any on-screen displays are not output.

### NOTES:

#### About DV IN/OUT connector

- To output digital signal when dubbing from the VHS deck to other device through the DV IN/OUT connector, press **←**, and then pressing **▶** to start playback on the VHS deck.
- When connecting this recorder to a device equipped with a DV input connector, be sure to use the optional DV cable (VC-VDV204).

# Connecting To A Satellite Receiver

## Simple Connections

This is an example of simple connection if your TV has one 21-pin AV input (SCART) connector.

Connect the satellite receiver to the AV2 (L-2) IN/DECODER connector, then connect the AV1 (L-1) IN/OUT connector to the TV's connector.

## NOTES:

- Set "L-2 SELECT" to "AV" (☞ pg. 53).
- To record a programme via the satellite receiver, select L-2 mode by pressing **AUX** (number key "0") and/or **PR** so that "L-2" appears on the front display panel.
- For details, refer to the instruction manual of the satellite receiver.

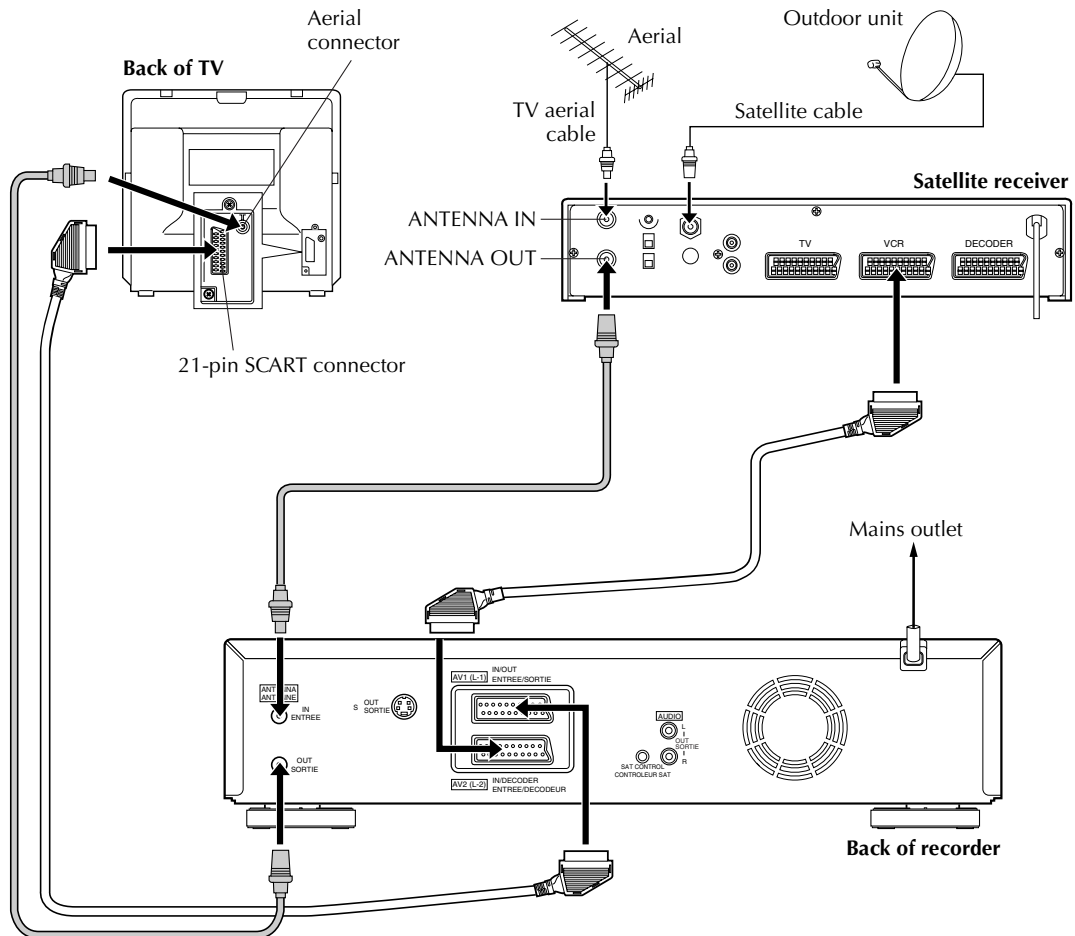

## IMPORTANT

When you set "L-2 SELECT" to "SAT" (☞ pg. 53), it is possible to view a satellite broadcast with the TV set to its AV mode even if the recorder is in timer mode, in stop mode, in recording mode or turned off. When the recorder is in Stop mode or recording, press **TV/VCR** on the remote control to turn off the VCR indicator on the front display panel.

- Set "L-1 OUTPUT" to "VIDEO" and set the satellite receiver's output and the TV's input to the composite mode.
- When the recorder is turned off, only a composite signal is output from the recorder to TV.
- If you turn on the recorder when the satellite receiver's power is off, nothing appears on the TV screen. In this case, turn on the satellite receiver, or set the TV to its TV mode, or press **TV/VCR** on the remote control to set the recorder to the video mode.



## Perfect Connections

This is an example of recommended connection if your TV has two 21-pin AV input (SCART) connectors. Connect the decoder to the satellite receiver's connector if you have a decoder, AV1 (L-1) IN/OUT connector to TV's connector, and AV2 (L-2) IN/DECODER connector to the satellite receiver's connector. Then connect the satellite receiver and TV.

### NOTES:

- Set "L-2 SELECT" to "AV" (pg. 53).
- To record a programme via the satellite receiver, select L-2 mode by pressing **AUX** (number key "0") and/or **PR** so that "L-2" appears on the front display panel.
- To receive a scrambled broadcast, descramble the signal with the satellite receiver.
- For details, refer to the instruction manual of the satellite receiver and decoder.

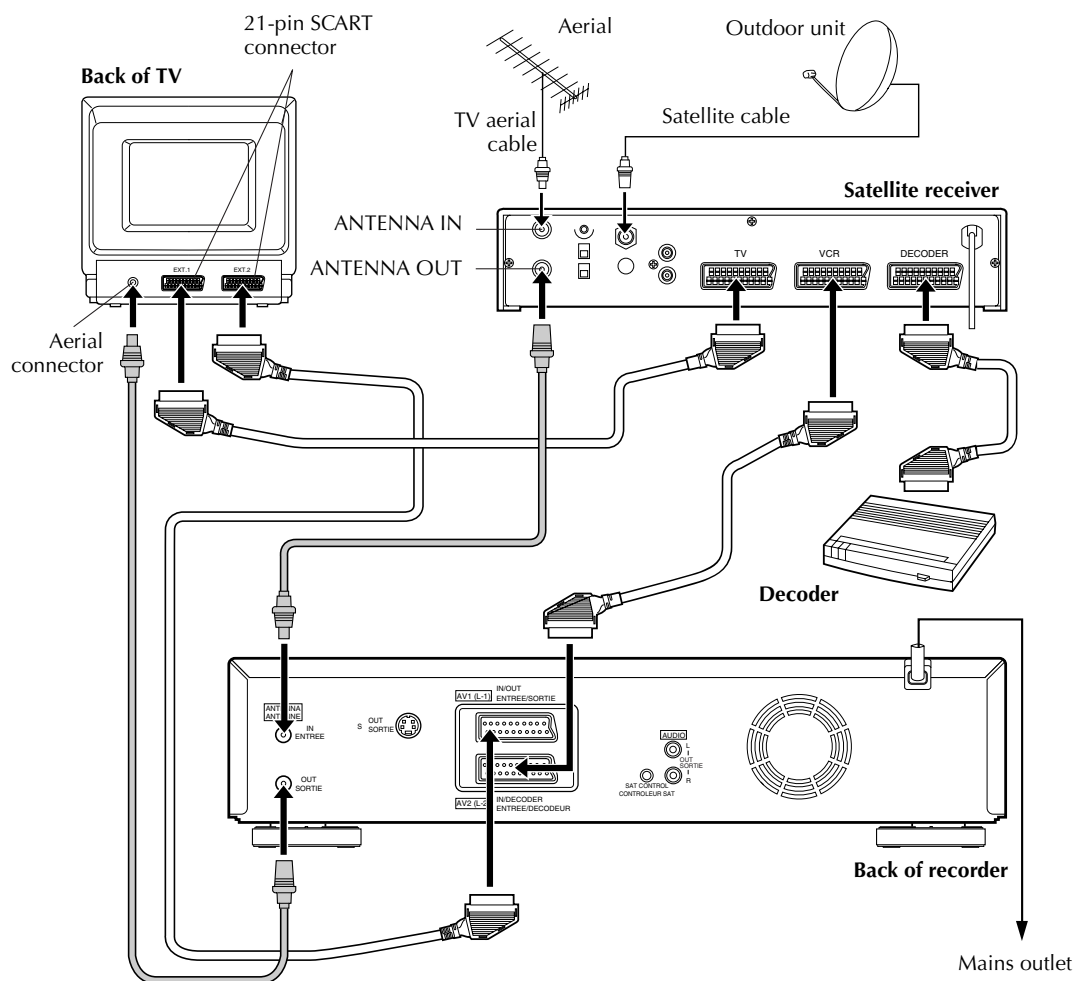

# Connecting/Using A Decoder

The AV2 (L-2) IN/DECODER connector can be used as an input connector for an external decoder (descrambler). Simply connect a decoder and you can enjoy the variety of programming that is available through scrambled channels.

## 1 Select the input mode.

Set "L-2 SELECT" to "DECODER". (☞ pg. 53)

## 2 Connect the decoder.

Connect your recorder's AV2 (L-2) IN/DECODER connector to the decoder's 21-pin SCART connector using a 21-pin SCART cable.

## 3 Set the tuner.

Perform the procedure as described in "When Receiving A Scrambled Broadcast" on page 77.

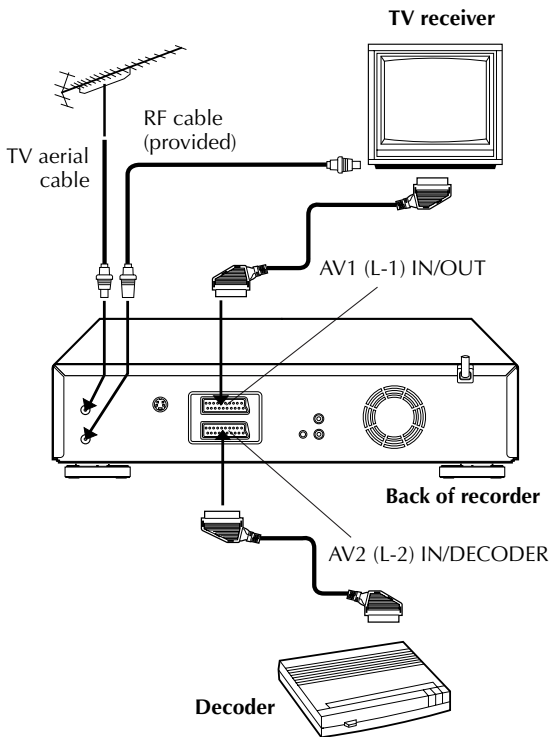

# Connecting/Using A Stereo System

These instructions enable you to connect your video recorder to your Hi-Fi stereo system (if you have one) and listen to the soundtrack through the stereo.

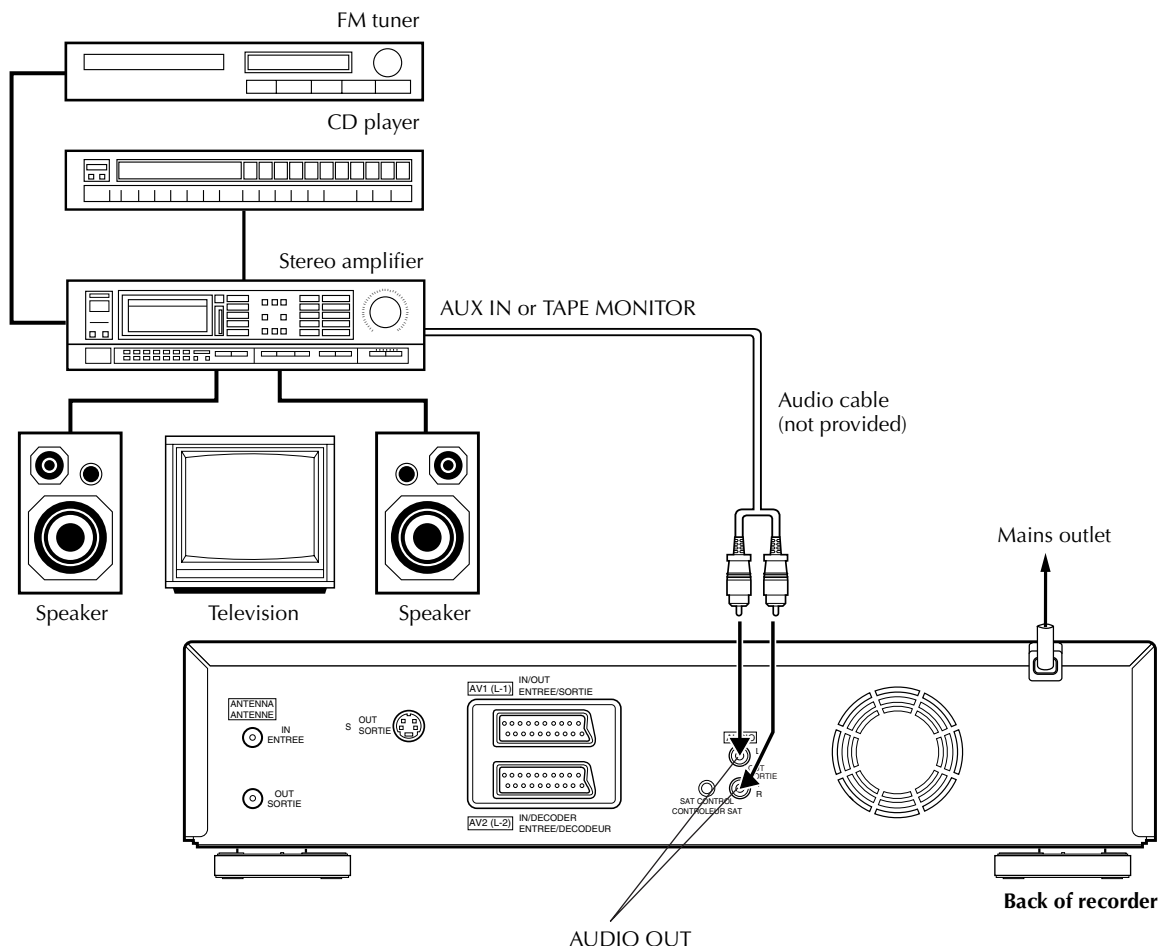

## Make connections.

Connect the AUDIO OUT L and R connectors on your video recorder to the AUX IN or TAPE MONITOR connectors on your stereo system's receiver or amplifier.

### NOTE:

When listening to sound through the connected stereo system, turn the TV's volume down completely.

## CAUTIONS:

- This recorder has a dynamic range of more than 80 dB with regards to its Hi-Fi audio capability. It is recommended that you check the maximum level if you are going to listen to the Hi-Fi audio signals through a stereo amplifier. A sudden surge in the input level to the speakers may damage them.
- Some speakers and televisions are specially shielded to prevent television interference. If both are of the non-shielded type, do not place the speakers adjacent to the TV set as this can adversely affect the video playback picture.

# Mode Set

Turn on the TV and select the AV mode.

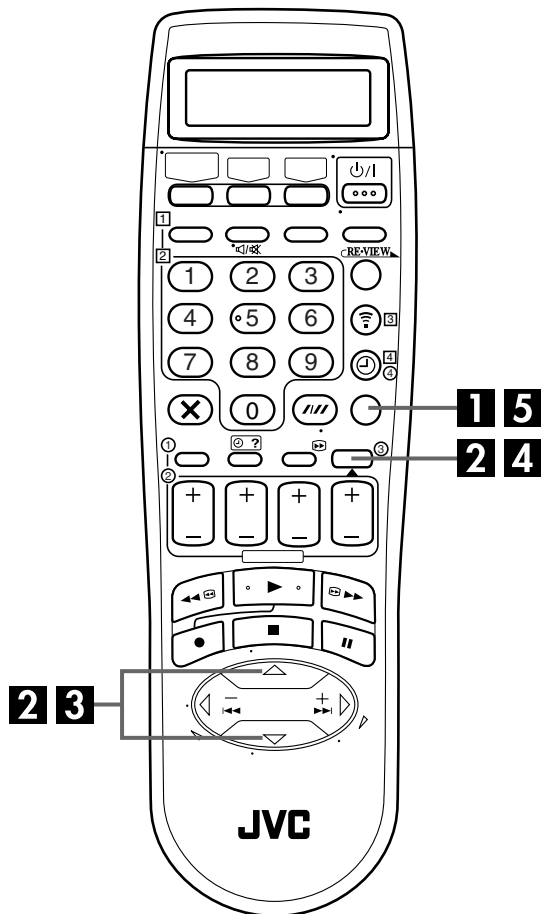

You can change various mode settings on TV screen by following the procedure described below. For each mode setting, see pages 69 to 73.

<b>MODE SET</b>	☞ pg. 69
<b>VHS MODE SET</b>	☞ pg. 70
<b>DV MODE SET</b>	☞ pg. 73

- The procedure shows how to set "O.S.D." to "ON" on the "MODE SET" screen as an example.

## 1 Access the Main Menu screen.

Press MENU.

## 2 Access the Mode Set screen.

Press  $\Delta$ / $\nabla$  to move the highlight bar (pointer) to "MODE SET", then press OK or  $\triangleright$ .

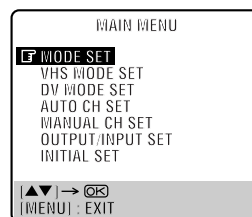

## 3 Select the mode.

Press  $\Delta$ / $\nabla$  to move the highlight bar (pointer) to "O.S.D.".

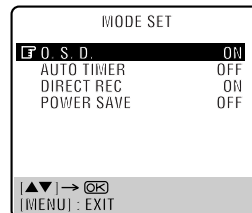

## 4 Select the mode setting.

Press OK or  $\triangleright$ .

## 5 Return to the normal screen.

Press MENU.

## MODE SET

\* The default setting is **bold** in the table below.

<p>■ <b>O.S.D.</b> ON OFF</p>	<p>When this function is set to "ON", various operational indicators appear on the TV screen. Messages appear in the selected language (☞ pg. 15, 16).</p> <p><b>NOTES:</b></p> <ul style="list-style-type: none"> <li>• When you use this recorder as the source player for editing, be sure to set "O.S.D." to "OFF" before starting.</li> <li>• During playback, the operation mode indicators may be disturbed depending on the type of tape being used.</li> </ul>
<p>■ <b>AUTO TIMER</b> ON OFF</p>	<p>When this function is set to "ON", the timer is automatically engaged when the recorder power is turned off, and automatically disengaged when the recorder is powered back on.</p> <p><b>NOTE:</b></p> <p>For safety, when "AUTO TIMER" is set to "OFF", all other recorder functions are disabled while the Timer mode is engaged. To disengage the timer, press ⊖ (TIMER).</p>
<p>■ <b>DIRECT REC</b> ON OFF</p>	<p>When this function is set to "ON", you can easily start recording the programme that you are watching on your TV. Press and hold ● and press ► on the remote control, or press ● on the recorder.</p> <p><b>NOTES:</b></p> <ul style="list-style-type: none"> <li>• When you use the Direct Rec function, be sure to use a TV offering T-V LINK, etc. and connect a fully-wired 21-pin SCART cable between the recorder and the TV (☞ pg. 10).</li> <li>• If "DIRECT REC" is set to "OFF", the ● button functions as described in "Basic Recording" (☞ pg. 21, 31).</li> <li>• During the Direct Rec, "--" appears on the front display panel.</li> <li>• Retake function (☞ pg. 28) does not work during Direct Rec. (VHS deck only)</li> </ul>
<p>■ <b>POWER SAVE</b> ON OFF</p>	<p>When this function is set to "ON", you can reduce the power consumption while the recorder is turned off.</p> <p><b>NOTES:</b></p> <ul style="list-style-type: none"> <li>• During Power Save mode ... <ul style="list-style-type: none"> <li>... the front display panel will be turned off.</li> <li>... the Just Clock function (☞ pg. 80) does not work.</li> <li>... the picture may be distorted momentarily when you turn on/off the recorder.</li> </ul> </li> <li>• Power Save does not work when ... <ul style="list-style-type: none"> <li>... the recorder is in the Timer mode.</li> <li>... the recorder's power is turned off after timer-recording or Instant Timer Recording.</li> <li>... "L-2 SELECT" is set to "DECODER" or "SAT" (☞ pg. 53).</li> </ul> </li> </ul>

## VHS MODE SET

\* The default setting is **bold** in the table below.

<p>■ <b>B.E.S.T.</b> ON OFF</p>	<p>You can set the B.E.S.T. (Biconditional Equalised Signal Tracking) system to "ON" or "OFF" (☞ pg. 29).</p>				
<p>■ <b>PICTURE CONTROL</b> AUTO EDIT SOFT SHARP</p>	<p>This feature helps you to adjust the playback picture quality according to your preference. Normally select "AUTO".</p> <p><b>AUTO:</b> Provides the optimised picture benefits of the B.E.S.T. Picture System.</p> <p><b>EDIT:</b> Minimizes picture degradation during editing (recording and playback).</p> <p><b>SOFT:</b> Reduces image coarseness when viewing overlapped tapes containing a lot of noise.</p> <p><b>SHARP:</b> Clearer, sharper-edged picture when viewing images with lots of flat, same-coloured surfaces such as cartoons.</p> <p><b>NOTES:</b></p> <ul style="list-style-type: none"> <li>• When you select "EDIT", "SOFT" or "SHARP", the selected mode will not change until you select another mode.</li> <li>• When you select "EDIT" to dub tapes, be sure to select "AUTO" after you finish dubbing the tapes.</li> <li>• When "B.E.S.T." is "OFF", "PICTURE CONTROL" switches automatically from "AUTO" to "NORM".</li> </ul>				
<p>■ <b>AUTO SP→LP TIMER</b> ON OFF</p>	<p>When this function is set to "ON", the recorder automatically switches to LP mode to allow complete recording if there is not enough tape to record the entire programme while timer-recording in SP mode.</p> <p><b>For Example . . .</b></p> <p>Recording a programme of 210 minutes in length onto a 180-minute tape</p> <table border="1" data-bbox="429 967 1019 1029"> <tr> <td style="text-align: center;">Approximately 150 minutes</td> <td style="text-align: center;">Approximately 60 minutes</td> </tr> <tr> <td style="text-align: center;">SP mode</td> <td style="text-align: center;">LP mode</td> </tr> </table> <p style="text-align: center;">Total 210 minutes</p> <p>Make sure you set this function to "ON", before the timer-recording starts.</p> <p><b>NOTES:</b></p> <ul style="list-style-type: none"> <li>• If you have programmed the recorder to timer-record 2 or more programmes, the second programme and those thereafter may not fit on the tape if you set "AUTO SP→LP TIMER" to "ON". In this case, make sure the mode is not engaged, then set the tape speed manually during timer programming.</li> <li>• In order to ensure that the recording fits on the tape, this feature may leave a slight non-recorded section at the end of the tape.</li> <li>• There may be some noise and sound disturbance at the point on the tape where the recorder switches from SP to LP mode.</li> <li>• The Auto SP→LP Timer feature is not available during ITR (Instant Timer Recording), and the feature will not work properly with any tapes longer than E-180, or with some tapes of shorter lengths.</li> <li>• If you perform timer recording with both VPS/PDC and the Auto SP→LP Timer activated, and the programme goes beyond its originally scheduled length, there may be times when the programme cannot be recorded in its entirety.</li> </ul>	Approximately 150 minutes	Approximately 60 minutes	SP mode	LP mode
Approximately 150 minutes	Approximately 60 minutes				
SP mode	LP mode				

## VHS MODE SET (cont.)

\* The default setting is **bold** in the table below.

<p>■ <b>DIGITAL 3R</b> ON OFF</p>	<p>When this function is set to "ON", the Digital 3R picture system applies edge correction to the luminance signal to enhance detail.</p> <p><b>NOTES:</b></p> <ul style="list-style-type: none"> <li>• Normally it is recommended to keep "DIGITAL 3R" set to "ON".</li> <li>• Depending on the type of tape being used, picture quality may be better with "DIGITAL 3R" set to "OFF".</li> <li>• If you use the recorder as the source player for editing, be sure to set "DIGITAL 3R" to "OFF" before starting.</li> </ul>
<p>■ <b>S-VHS</b> ON OFF</p>	<p>Your recorder can record in S-VHS (Super VHS), S-VHS ET or VHS.</p> <p>● <b>To record in S-VHS:</b> Set "S-VHS" to "ON". Then, insert a cassette marked "S-VHS". The S-VHS indicator lights up on the front display panel. The S-VHS recording mode is selected.</p> <p>● <b>To record in S-VHS ET on a VHS cassette:</b> Set "S-VHS ET" to "ON". (☞ See below.) Then, insert a cassette marked "VHS". The S-VHS indicator lights up on the front display panel.</p> <p>● <b>To record in VHS:</b> Insert a cassette marked "VHS". Set "S-VHS ET" to "OFF". (☞ See below.)</p> <p>● <b>To record in VHS on an S-VHS cassette:</b> Insert a cassette marked "S-VHS". The S-VHS indicator lights up on the front display panel. Then, set "S-VHS" to "OFF". The S-VHS indicator goes off. The VHS recording mode is selected.</p> <p><b>NOTE:</b> <i>When playing back a tape that has been recorded in S-VHS or S-VHS ET, the S-VHS indicator lights up on the front display panel regardless of the "S-VHS" mode setting.</i></p>
<p>■ <b>S-VHS ET</b> ON OFF</p>	<p>You can record in SP mode on VHS cassettes with S-VHS picture quality. Tapes recorded using this function can be played back on a recorder equipped with the S-VHS ET function.</p> <p>When this function is set to "ON", the S-VHS indicator lights up on the front display panel.</p> <p><b>NOTES:</b></p> <ul style="list-style-type: none"> <li>• You can activate the S-VHS ET function only before you start recording on a VHS cassette.</li> <li>• Before recording, make sure that "B.E.S.T." is set to "ON". (☞ pg. 70)</li> <li>• You cannot activate the S-VHS ET function ... <ul style="list-style-type: none"> <li>... while recording is in progress.</li> <li>... while timer-recording or Instant Timer Recording (☞ pg. 26, 34) is in progress.</li> <li>... while B.E.S.T. (☞ pg. 29) is in progress.</li> </ul> </li> <li>• The S-VHS ET function does not work ... <ul style="list-style-type: none"> <li>... with S-VHS cassettes.</li> <li>... with recordings in LP mode.</li> </ul> </li> <li>• To keep the highest quality recording and playback pictures over a long period of time, S-VHS recording on S-VHS cassettes is recommended.</li> <li>• Use of high grade tapes is recommended for S-VHS ET recordings. On some tapes, picture quality will not improve even if the S-VHS ET function is used. Check the recording quality before you start important recordings.</li> <li>• You can play back a tape recorded using the S-VHS ET function on most of S-VHS recorders and of VHS recorders equipped with SQPB (S-VHS QUASI PLAYBACK) function. (Notice some recorders are not compatible with the S-VHS ET function.)</li> <li>• While playing back a tape recorded using the S-VHS ET function on some recorders, noise may appear. (If playback picture becomes blurred or interrupted, use a cleaning cassette.)</li> <li>• In the high-speed search, still, slow-motion or frame-by-frame playback modes (☞ pg. 22), noise may appear. If these modes are performed frequently on a tape recorded using the S-VHS ET function, the tape may be damaged and the picture may be deteriorated.</li> </ul>

## VHS MODE SET (cont.)

\* The default setting is **bold** in the table below.

<p>■ <b>COLOUR SYSTEM</b> PAL/NTSC MESECAM</p>	<p>You can play back PAL, NTSC and MESECAM tapes, or record PAL and SECAM* signals on this recorder. Select the appropriate colour system.</p> <p>* SECAM signals will be recorded as MESECAM on this recorder; MESECAM is the designation for tapes with SECAM signals that have been recorded on a MESECAM-compatible PAL video cassette recorder.</p> <p><b>PAL/NTSC:</b> To record PAL signals, or play back a PAL or NTSC tape. <b>MESECAM:</b> To record SECAM signals, or play back a MESECAM tape.</p> <p><b>NOTES:</b></p> <ul style="list-style-type: none"> <li>● It is not possible to record in S-VHS if "MESECAM" is selected. The recording mode is forced to change to VHS.</li> </ul> <p><b>About NTSC Playback</b></p> <ul style="list-style-type: none"> <li>● Some TVs shrink the picture vertically and place black bars at the top and bottom of the TV screen. This is not a malfunction on the part of either the video recorder or the TV.</li> <li>● The picture may roll up and down. This can be corrected using the V-HOLD control found on some TVs. (This cannot be corrected if the TV does not have a V-HOLD control.)</li> <li>● The counter and tape remaining time readings will be incorrect.</li> <li>● During search, still, or frame-by-frame playback, the picture will be distorted, and there may be a loss of colour.</li> <li>● Depending on the type of TV, the top and bottom portions of superimposed displays may be cut off during NTSC playback.</li> </ul>
<p>■ <b>DIGITAL TBC/NR</b> ON OFF</p>	<p>Your recorder is equipped with the Digital TBC (Time Base Corrector) that removes jitter from fluctuating video signals to deliver a stable picture even with old tapes and rental cassettes.</p> <p>The on/off of Digital 3-DNR (Noise Reduction) which cuts noise and enables clear picture reproduction is also linked to this function.</p> <p>We recommend that you set "DIGITAL TBC/NR" to "ON" when ...</p> <ul style="list-style-type: none"> <li>... playing back a tape recorded on a camcorder.</li> <li>... playing back a tape repeatedly used.</li> <li>... using this video recorder as the source player for editing.</li> </ul> <p><b>NOTES:</b></p> <ul style="list-style-type: none"> <li>● If you play back a tape recorded under poor TV reception condition, the picture may become more stable with Digital TBC/NR set to off.</li> <li>● When "DIGITAL TBC/NR" is set to "ON", if you play back a tape where certain types of signals are recorded (using a PC or some character generators), the playback picture may be distorted. If this is the case, set "DIGITAL TBC/NR" to "OFF".</li> <li>● When playing back a MESECAM tape, Digital TBC/NR does not function even though "DIGITAL TBC/NR" is set to "ON".</li> </ul>
<p>■ <b>VIDEO STABILIZER</b> ON OFF</p>	<p>When this function is set to "ON", you can automatically correct vertical vibration in the picture when playing back unstable recordings made on another recorder.</p> <p><b>NOTES:</b></p> <ul style="list-style-type: none"> <li>● When you finish viewing a tape, be sure to set this function to "OFF".</li> <li>● Regardless of the setting, this function has no effect during recording and during special effects playback.</li> <li>● The on-screen display may jitter vertically when this function is set to "ON".</li> <li>● To watch recordings with close-caption, set this function to "OFF".</li> <li>● Video Stabilizer and Digital TBC/NR cannot be used at the same time. If you activate Digital TBC/NR when "VIDEO STABILIZER" is set to "ON", Video Stabilizer will be automatically turned "OFF".</li> </ul>



## DV MODE SET

\* The default setting is **bold** in the table below.

<p>■ <b>SOUND MODE</b> 12BIT 16BIT</p>	<p>Select the appropriate mode before recording on a Mini DV tape.</p> <p><b>12BIT:</b> Enables Audio Dubbing later. <b>16BIT:</b> Audio Dubbing is impossible but the recorded sound quality is higher than "12BIT".</p>
<p>■ <b>12BIT MODE</b> <b>SOUND1</b> SOUND2 FULL SOUND</p>	<p>Select the appropriate mode when playing back an audio-dubbed Mini DV tape.</p> <p><b>SOUND1:</b> Original recorded sound <b>SOUND2:</b> Audio-dubbed sound <b>FULL SOUND:</b> Original recorded sound and Audio-dubbed sound</p> <p><b>NOTES:</b></p> <ul style="list-style-type: none"> <li>• When "12BIT MODE" is set to "FULL SOUND", both the main and sub audio will be audible for bilingual tapes.</li> <li>• To select only the main audio or only the sub audio of bilingual tapes, set "12BIT MODE" to "SOUND1".</li> </ul>
<p>■ <b>AUDIO REC</b> <b>NICAM</b> MONO</p>	<p>Select the appropriate mode when recording the NICAM bilingual programmes.</p> <p><b>NICAM:</b> The NICAM audio programme will be recorded on the audio track. <b>MONO:</b> The Standard (monaural) audio programme will be recorded on the audio track.</p>
<p>■ <b>TIME CODE</b> <b>ON</b> OFF</p>	<p>When this function is set to "ON", the time code always appears on the TV screen while the DV deck is being selected. When this function is set to "OFF", the time code appears on the TV screen only by pressing --:--. (ⓘ pg. 7, 35)</p>

# Tuner Set

Turn on the TV and select the AV mode.

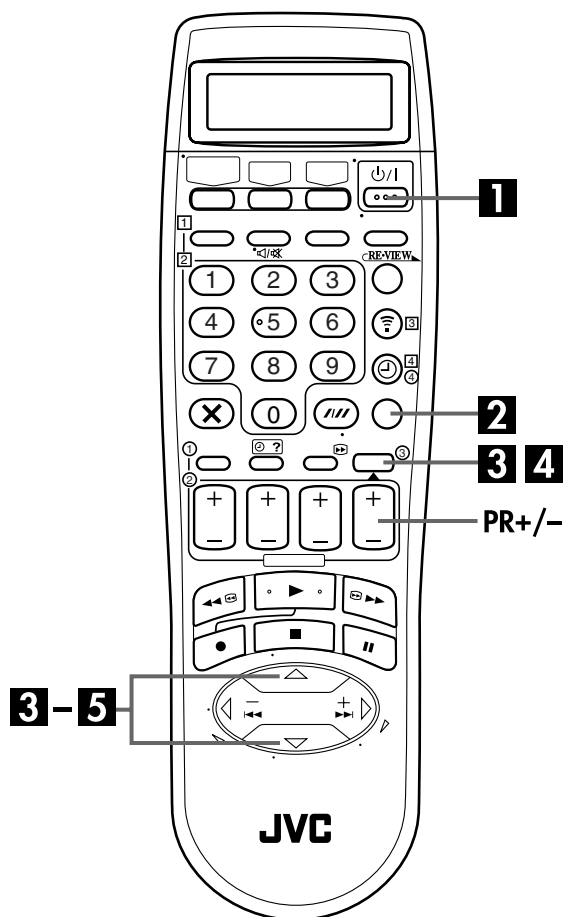

## IMPORTANT

Perform the following steps only if —  
 — Auto Channel Set has not been set correctly by Auto Set Up or by Preset Download (pg. 12, 14).  
 — you have moved to a different area or if a new station starts broadcasting in your area.

Your recorder needs to memorize all necessary stations in channel positions in order to record TV programmes. Auto Channel Set automatically assigns all receivable stations in your area to call them up by using the **PR** buttons without going through any vacant channels.

## Auto Channel Set

### 1 Turn on the recorder.

Press **power**.

### 2 Access the Main Menu screen.

Press **MENU**.

### 3 Access the Auto Channel Set screen.

Press **left arrow** to move the highlight bar (pointer) to "AUTO CH SET", then press **OK** or **right arrow**.

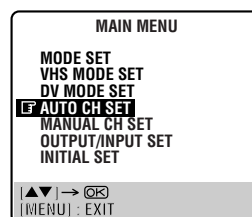

### 4 Select your country.

Press **up arrow** to move the highlight bar (pointer) to your country's name, then press **OK** or **right arrow**.

### 5 Select the language.

Press **up arrow** to move the highlight bar (pointer) to the language of your choice.

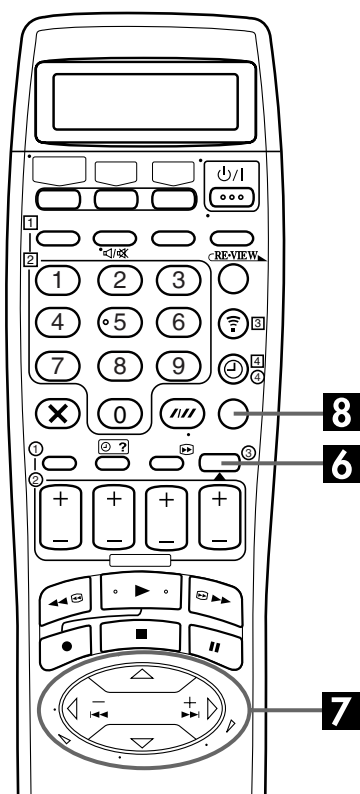

## IMPORTANT

- In certain reception conditions, station names may not be stored correctly, and Auto Guide Program Number Set may not work properly. If the Guide Program numbers are not set properly when you timer-record a TV programme using the SHOWVIEW system, the recorder will record a TV programme of a different station. When programming the timer using the SHOWVIEW system, be sure to check the desired channel is selected correctly (pg. 36, "SHOWVIEW Timer Programming").
- Your video recorder memorizes all detected stations even if reception of some of them is poor. You can delete those stations with an unacceptable picture (pg. 77, "Delete A Channel").

## NOTES:

- Fine tuning is performed automatically during Auto Channel Set. If you want to perform tuning manually, refer to page 78.
- If you perform Auto Channel Set when the aerial cable is not connected properly, "SCAN COMPLETED -NO SIGNAL-" appears on the TV screen in step 7. When this happens, make sure of the aerial connection and press **OK**; Auto Channel Set will take place again.
- If no sound accompanies the picture or the audio sounds unnatural on some channels that have been stored by Auto Set Up, the TV system setting for those channels may be incorrect. Select the appropriate TV system for those channels (pg. 77, "INFORMATION").

## 6 Perform Auto Channel Set.

Press **OK** twice.

- You can set up the recorder's tuner also by Preset Download (pg. 14).
- The Auto Set screen appears, and remains on screen while the recorder searches for receivable stations. As Auto Channel Set progresses, the "█" mark on the TV screen moves from left to right. Wait until the TV screen as shown in step 7 appears.

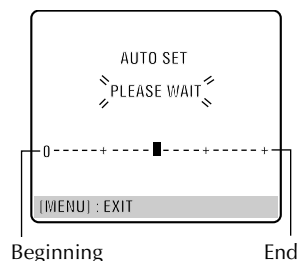

## 7 View the Confirmation screen.

After "SCAN COMPLETED" is displayed on the TV screen for about 5 seconds, the Confirmation screen looking like the one to the right appears. The stations your recorder located appear on a Confirmation screen — channel positions (PR), channels (CH) and station names (ID — pg. 79). The blueback screen and the programme currently being broadcast by the blinking station appear alternately for 8 seconds each. To view the next page, use the  $\Delta \nabla \triangleleft \triangleright$  button on the remote control.

PR	CH	ID	PR	CH	ID
01	25	ARD	08	C26	E-SP
02	C08	SKY1	09	55	WEST
03	10	ZDF	10	C24	SAT1
04	C65	RAI1	11	C23	OSF
05	C31	BBC1	12		----
06	C32	BBC2	13		----
07	C33	3SAT	14		----

$\Delta \nabla \triangleleft \triangleright$  : EDIT  
 $\rightarrow [X]$  : DELETE  
 |MENU| : EXIT

- The stations located in the selected country appear at the top of the list.
- The Guide Program numbers will also be set automatically during Auto Channel Set.

## 8 Return to the normal screen.

Press **MENU**.

- Using the Confirmation screen, you can skip or add channel positions, enter station names and perform other operations. Refer to pages 76 – 78 for the procedures.
- Depending on reception conditions, the stations may not be stored in order, and the station names may not be stored correctly.
- For information on scrambled broadcasts, refer to page 77.

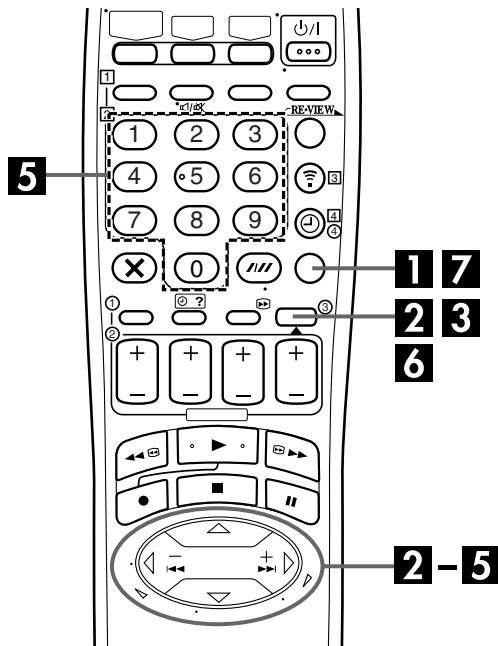

## Manual Channel Set

Store channels that were not stored during Auto Set Up (☞ pg. 12), Preset Download (☞ pg. 14) or Auto Channel Set (☞ pg. 74).

### 1 Access the Main Menu screen.

Press **MENU**.

### 2 Access the Confirmation screen.

Press  $\Delta\nabla$  to move the highlight bar (pointer) to "MANUAL CH SET", then press **OK** or  $\triangleright$ . The Confirmation screen appears.

### 3 Select the channel position.

Press  $\Delta\nabla\triangleleft\rangle$  until an open position in which you want to store a channel begins blinking, then press **OK**. The Manual Channel Set screen appears.

(Example) To store in position 12.

PR	CH	ID	PR	CH	ID
01	25	ARD	08	C26	E-SP
02	C08	SKY1	09	55	WEST
03	10	ZDF	10	C24	SAT1
04	C65	RAI1	11	C23	OSF
05	C31	BBC1	12	---	---
06	C32	BBC2	13	---	---
07	C33	3SAT	14	---	---

$\blacktriangle$   $\blacktriangledown$  : SELECT  
 $\triangleleft$   $\triangleright$  : CURSOR  $\leftarrow$   $\rightarrow$   
 $\text{OK}$  : OK  
 $\text{[MENU]}$  : EXIT

The blueback screen and the programme currently being broadcast by the selected channel appear alternately for 8 seconds each.

### 4 Select the band.

Press  $\Delta\nabla$  to change the band between CH (regular) and CC (cable), then press  $\triangleright$ .

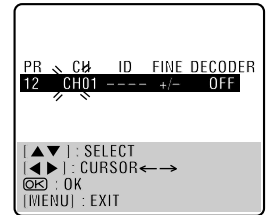

### 5 Input the channel.

Press the **number keys** to input the channel number you want to store.

- Input "0" before any single number entries.
- To input the registered station name (ID – ☞ pg. 79), press  $\Delta\nabla$  until "----" (ID setting) begins blinking, then press  $\Delta\nabla$ .
- For fine tuning adjustment, press  $\triangleright$  until "+/-" begins blinking, then press  $\Delta\nabla$ . While tuning, "+" or "-" appears.
- When storing a channel that sends scrambled broadcasts, press  $\triangleright$  until "OFF" (Decoder setting) blinks, then press  $\Delta\nabla$  to set "DECODER" to "ON" ("OFF" is the default setting).
- When "L-2 SELECT" is set to "AV" or "SAT", the "DECODER" setting cannot be changed (☞ pg. 53).

### 6 Enter new channel information.

Press **OK** and the Confirmation screen appears.

- Repeat steps 3 – 6 as necessary.

### 7 Close the Confirmation screen.

Press **MENU**.

- To change positions, see "Change Station Channel Position" (☞ pg. 77).
- If you wish to set station names other than the ones registered in your recorder, see "Set Stations (B)" (☞ pg. 78).

## ATTENTION

Guide Program numbers are not set when channels are stored manually. If an attempt is made at timer programming with the SHOWVIEW system in this state, the "GUIDE PROG SET" screen appears; set the Guide Program numbers on this screen. (☞ pg. 37, "ATTENTION — Guide Program Number Set") Or perform "Guide Program Number Set" (☞ pg. 82).

## Delete A Channel

Perform steps 1 and 2 of "Manual Channel Set" on page 76 to access the Confirmation screen before continuing.

### 1 Select the item.

Press  $\Delta \nabla \triangleleft \triangleright$  until the item you want to delete begins blinking.

### 2 Delete a channel.

Press X.

- The item directly beneath the cancelled one moves up one line.
- Repeat steps 1 and 2 as necessary.

### 3 Close the Confirmation screen.

Press MENU.

## Change Station Channel Position

Perform steps 1 and 2 of "Manual Channel Set" on page 76 to access the Confirmation screen before continuing.

### 1 Select the item.

Press  $\Delta \nabla \triangleleft \triangleright$  until the item you want to move begins blinking. Then press **OK** and the station name (ID) and its channel (CH) number begin blinking.

### 2 Select the new position.

Press  $\Delta \nabla \triangleleft \triangleright$  to move the station to the new channel position, then press **OK**.

Example: If you moved the station in position 4 to position 2, the stations originally in positions 2 and 3 each move down one space.

PR	CH	ID	PR	CH	ID
01	25	ARD	08	C26	E-SP
02	C08	SKY1	09	55	WEST
03	10	ZDF	10	C24	SAT1
04	C65	RAI1	11	C23	OSF
05	C31	BBC1	12	C25	ESPN
06	C32	BBC2	13	----	----
07	C33	3SAT	14	----	----

➔

PR	CH	ID	PR	CH	ID
01	25	ARD	08	C26	E-SP
02	C65	RAI1	09	55	WEST
03	C08	SKY1	10	C24	SAT1
04	10	ZDF	11	C23	OSF
05	C31	BBC1	12	C25	ESPN
06	C32	BBC2	13	----	----
07	C33	3SAT	14	----	----

- Repeat steps 1 and 2 as necessary.

### 3 Close the Confirmation screen.

Press MENU.

## When Receiving A Scrambled Broadcast

### 1 Select the decoder mode.

Set "L-2 SELECT" to "DECODER" (pg. 53).

### 2 Access the Confirmation screen.

Perform steps 1 and 2 of "Manual Channel Set" on page 76.

### 3 Select the position.

Press  $\Delta \nabla \triangleleft \triangleright$  to select the channel position broadcasting scrambled programmes, then press **OK** twice.

### 4 Change the decoder setting.

Press  $\triangleright$  until "OFF" (decoder setting) begins blinking, and set it to "ON" by pressing  $\Delta \nabla$ .

### 5 Return to the Confirmation screen.

Press **OK**.

- Repeat steps 3 – 5 as necessary.

### 6 Close the Confirmation screen.

Press MENU.

## INFORMATION

If you live in Eastern Europe, "TV SYSTEM" setting appears instead of "DECODER" setting on the Manual Channel Set screen. When you can see the picture but can hear no audio, select appropriate TV system (D/K or B/G). Normally, TV programmes are broadcasted as follows.

For Eastern Europe : D/K

For Western Europe : B/G

- 1 Select a country in Eastern Europe in step 4 on page 74.
- 2 Press  $\triangleright$  until the TV system (D/K or B/G) blinking on the Manual Channel Set screen in step 4 on page 76.
- 3 Press  $\Delta \nabla$  to select appropriate TV System (D/K or B/G).

## Set Stations (A)

Set station names that are registered in your recorder.

Perform steps 1 and 2 of "Manual Channel Set" on page 76 to access the Confirmation screen before continuing.

### 1 Select the item.

Press  $\Delta \nabla \triangleleft \triangleright$  until the item you want begins blinking.

### 2 Access the Manual Channel Set screen.

Press **OK** twice.

### 3 Select the new station.

Press  $\triangleright$  until the station name (ID) begins blinking, then press  $\Delta \nabla$  until the new station's name (ID) you want to store begins blinking. Registered station names (pg. 79) appear as you press  $\Delta \nabla$ .

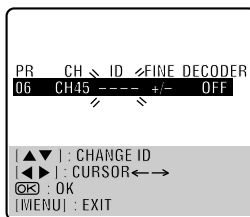

### 4 Switch the stations.

Press **OK**.

- The Confirmation screen appears.
- Repeat steps 1 – 4 as necessary.

### 5 Close the Confirmation screen.

Press **MENU**.

## Set Stations (B)

Set station names other than the ones registered in your recorder.

Perform steps 1 and 2 of "Manual Channel Set" on page 76 to access the Confirmation screen and then perform steps 1 and 2 of "Set Stations (A)" above before continuing.

### 1 Select the character for station name.

Press  $\triangleright$  until the first letter of the station name begins blinking.

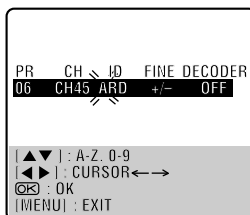

### 2 Enter the new character.

Press  $\Delta \nabla$  to cycle through the characters (A–Z, 0–9, –, \*, +, \_ (space) ) and stop when the desired character is indicated, then press  $\triangleright$  to enter. Enter the remaining characters the same way (maximum of 4). After entering all characters, press **OK**.

- The Confirmation screen appears.
- If you make a mistake, press  $\triangleleft$  until the incorrect character begins blinking. Then enter the correct character by pressing  $\Delta \nabla$ .

### 3 Close the Confirmation screen.

Press **MENU**.

#### NOTE:

The characters available for the station name (ID) are A–Z, 0–9, –, \*, +, \_ (space) (maximum of 4).

## Fine-Tuning Channels Already Stored

Perform steps 1 and 2 of "Manual Channel Set" on page 76 to access the Confirmation screen before continuing.

### 1 Select the channel to fine-tune.

Press  $\Delta \nabla \triangleleft \triangleright$  until the channel you want to tune begins blinking.

### 2 Access the Manual Channel Set screen.

Press **OK** twice. The Manual Channel Set screen appears.

### 3 Perform tuning.

Press  $\triangleright$  until "+/-" begins blinking, then press  $\Delta \nabla$  until the picture is its clearest. Then press **OK**.

- The Confirmation screen appears.
- Repeat steps 1 – 3 as necessary.

### 4 Close the Confirmation screen.

Press **MENU**.

## TV Station And ID List

ID*	STATION NAME
1000	TV1000
3SAT	3SAT
ADLT	ADULT
ANT3	ANTENA3
ARD	ARD
ARTE	ARTE
B1	BERLIN1
BBC	BBC GROUP
BBC1	BBC1
BBC2	BBC2
BR3	BAYERN3
C+	CANAL PLUS
C1	PORTUGUSES
CAN5	CANALE5
CANV	KETNET CANVAS
CH4	CHANNEL4
CH5	CHANNEL5
CHLD	CHILD
CINE	CINEMA
CLUB	TELECLUB
CMT	CMT
CNN	CNN
CSUR	ANDALUCIA
DISC	DISCOVERY
DR	DR TV
DR2	DR2
DRS	DRS
DSF	DSF
ETB1	ETB1
ETB2	ETB2
EURO	EURONEWS
EUSP	EUROSPORTS
FEMM	FEMMAN
FILM	FILM
FNET	FILMNET
FR2	France2
FR3	France3
GALA	GALAVISION
HR3	HESSEN3
INFO	INFO-KANAL
ITA1	ITALIA1
ITA7	ITALIA7
ITV	ITV
JSTV	JSTV
KA2	KA2
KAB1	KABEL1
KAN2	KANAL2
LOCA	LOCAL
M6	M6
MBC	MBR
MCM	MCM
MDR	MDR
MOVE	MOVIE
MTV	MTV
MTV3	MTV3
N3	NORD3
N-TV	N-TV
NBC	NBC SUPER
NDR3	NDR3
NED1	NED1
NED2	NED2
NED3	NED3
NEWS	
NICK	NICKELODEON
NRK	NRK
NRK2	NRK2
ODE	ODEON
ORF1	ORF1
ORF2	ORF2

ID*	STATION NAME
ORF3	ORF3
OWL3	OWL3
PREM	PREMIERE
PRO7	PRO7
RAI1	RAI1
RAI2	RAI2
RAI3	RAI3
RET4	RETE4
21	TELE21
RTBF	RTBF1 or 2
RTL	RTL
RTL2	RTL2
RTL4	RTL4
RTL5	RTL5
RTP	RTP
S4	SCHWEIZ4
SAT1	SAT1
SBS	SBS
SF1	SF1
SF2	SF2
SHOW	SHOW
SIC	SOCIEDADE
SKY	SKY CHANNEL
SKYN	SKY NEWS
SPRT	SPORT
SRTL	SUPER RTL
STAR	STAR-TV
SVT1	SVT1
SVT2	SVT2
SWR	SUEDWEST3
TCC	TCC
TELE	TELE
TEL5	TELE5
TF1	TF1
TM3	TM3
TMC	TELEMONTECARLO
TNT	TNT INT
TRT	TRT INT
TSI	TSI
TSR	TSR
TV1	BRTN TV1
TV2	TV2
TV3	TV3
TV4	TV4
TV5	TV5
TV6	TV6
TVE1	TVE1
TVE2	TVE2
TVG	TV GALICIA
TVI	TV INDEPENDENT
TVN	TV NORGE
VCR	VIDEO
VERO	VERONICA
VH-1	VH-1
VIVA	VIVA
VIV2	VIVA2
VMTV	VIDEO MUSIC
VOX	VOX
VT4	VT4
VTM	VTM
WDR1	West1
WDR3	West3
YLE1	YLE1
YLE2	YLE2
ZDF	ZDF
ZTV	ZTV

\* The "ID" abbreviation is what is shown on-screen in lieu of the station name. The "ID" abbreviation is listed in the Confirmation screen and is displayed on the TV screen when the recorder is tuned to a different station.

# Clock Set

Turn on the TV and select the AV mode.

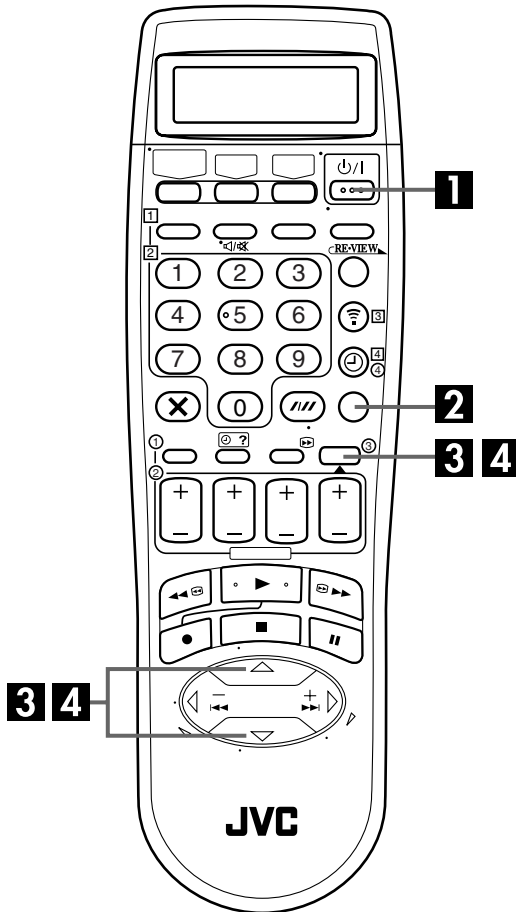

## Just Clock

The Just Clock function provides accurate time keeping through automatic adjustments at regular intervals, by reading data from a PDC signal.

The Just Clock option can be set "ON" or "OFF" at the Clock Set screen (the default setting is "OFF"). Press **OK** until the Just Clock setting begins blinking, then press  $\Delta/\nabla$  to change the setting.

**IMPORTANT:** If you turn off Just Clock, the accuracy of your recorder's built-in clock may be reduced, which could adversely effect timer recording. We recommend you to keep Just Clock on. In cases where the clock setting data from a PDC signal is incorrect, however, you are advised to keep Just Clock set to "OFF".

## IMPORTANT

If you performed Auto Set Up (pg. 12), Preset Download (pg. 14) or Auto Channel Set (pg. 74), without ever having set the clock previously, the recorder's built-in clock is also set automatically.

Perform the following steps only if —

—Auto Clock Set has not been performed correctly by Auto Set Up, Preset Download or Auto Channel Set.

**OR**

—the recorder's memory backup has expired.

**OR**

—you want to change Just Clock setting (pg. "Just Clock" in the left column).

## 1 Turn on the recorder.

Press  $\text{P}/\text{I}$ .

## 2 Access the Main Menu screen.

Press **MENU**.

## 3 Access the Initial Set screen.

Press  $\Delta/\nabla$  to move the highlight bar (pointer) to "INITIAL SET", then press **OK** or  $\triangleright$ .

## 4 Access the Clock Set screen.

Press  $\Delta/\nabla$  to move the highlight bar (pointer) to "CLOCK SET", then press **OK** or  $\triangleright$ . The Clock Set screen appears.

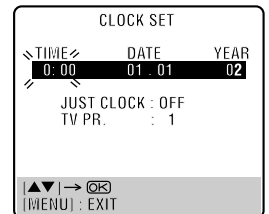
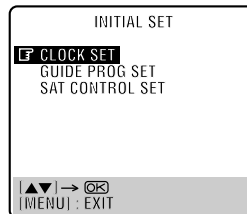

## NOTE:

When you have selected *MAGYARORSZÁG (36)*, *ČESKÁ REPUBLIKA (42)*, *POLSKA (48)* or *OTHER EASTERN EUROPE (EE)* for the country setting (pg. 12, 16), you cannot use Just Clock function. Skip steps 6 and 7 on page 81.



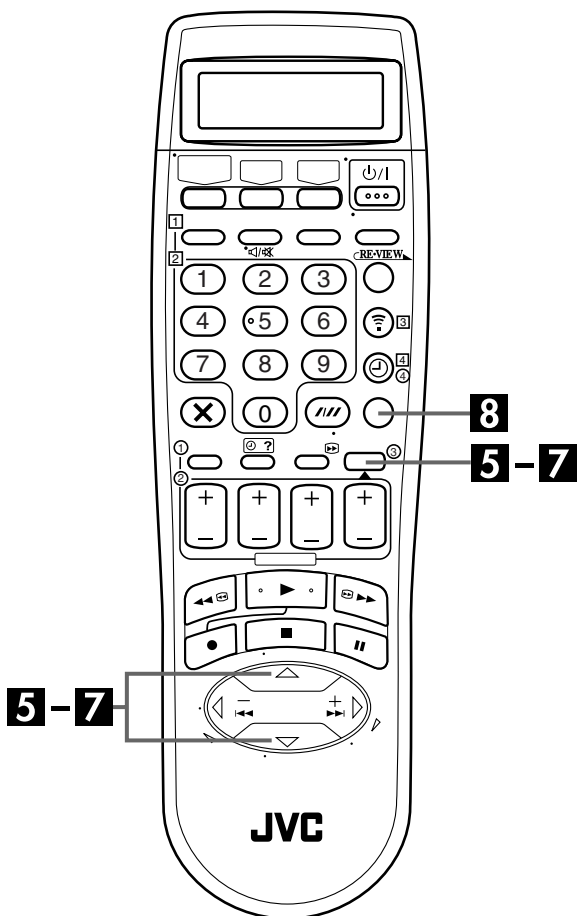

## 5 Set the date and time.

Press  $\Delta\nabla$  to set the time, then press **OK** or  $\triangleright$ . The "DATE" display begins blinking. Repeat the same procedure to set the date and year.

- When you set the time, press and hold  $\Delta\nabla$  to change the time by 30 minutes.
- When you set the date, press and hold  $\Delta\nabla$  to change the date by 15 days.

## 6 Set Just Clock.

The default setting is "OFF". Set as desired by pressing  $\Delta\nabla$ , then press **OK** or  $\triangleright$ .

- For the Just clock function, refer to "Just Clock" on page 80.
- If you set to "OFF", you can disregard the next step as you won't be able to receive regular clock adjustments.

## 7 Set the source channel position for clock data.

The recorder is preset to receive clock setting and adjustment data from channel position 1. Press  $\Delta\nabla$  to set the channel position to the number representing the station transmitting clock setting data, then press **OK** or  $\triangleright$ .

## 8 Start the clock operation.

Press **MENU**.

### NOTES:

- *Just Clock* (when set to "ON") adjusts the recorder's built-in clock every hour, except for 23:00, 0:00, 1:00 and 2:00.
- *Just Clock* is not effective when ...
  - ... the recorder's power is on.
  - ... the recorder is in the Timer mode.
  - ... a difference of more than 3 minutes exists between the built-in clock's time and the actual time.
  - ... the recorder is in the Power Save mode (☞ pg. 69).
  - ... "L-2 SELECT" is set to "SAT" (☞ pg. 53).
- If *Just Clock* is set to "ON", the recorder's clock is automatically adjusted at the start/end of Summer Time.
- *Just Clock* may not function properly depending on the reception condition.

# SHOWVIEW® System Setup

## IMPORTANT

Normally, Auto Set Up (☞ pg. 12), Preset Download (☞ pg. 14) or Auto Channel Set (☞ pg. 74) sets the Guide Program numbers automatically. You need to set the Guide Program numbers manually only in the following cases.

- When timer-programming with the SHOWVIEW system, the channel position, where the station you wish to record is received on your recorder, is not selected,  
**OR**  
when you add a channel after Auto Set Up, Preset Download or Auto Channel Set has taken place,  
—Set the Guide Program number for that station manually.
- When you wish to timer-record a satellite programme with the SHOWVIEW system,  
—Set the Guide Program numbers for all satellite broadcasts received on your satellite receiver.

Turn on the TV and select the AV mode.

## Guide Program Number Set

### 1 Access the Main Menu screen.

Press **MENU**.

### 2 Access the Initial Set screen.

Press  $\Delta$ / $\nabla$  to move the highlight bar (pointer) to "INITIAL SET", then press **OK** or  $\triangleright$ .

### 3 Access the Guide Program Set screen.

Press  $\Delta$ / $\nabla$  to move the highlight bar (pointer) to "GUIDE PROG SET", then press **OK** or  $\triangleright$ .

### 4 Enter the Guide Program number.

Press  $\Delta$ / $\nabla$  to enter the Guide Program number for the desired station as shown in the TV listings. Then press **OK** or  $\triangleright$ .

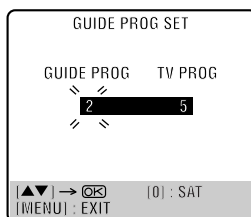

(Example) When inputting the Guide Program number 2 for ZDF.

### 5 Enter the receiving channel position number.

Press the **number key "0"** to select "TV PROG" or "SAT". Then press  $\Delta$ / $\nabla$  to input the number of the recorder's channel position on which the Guide Program number's broadcast is received by the recorder or the satellite receiver. Then press **OK** or  $\triangleright$ .

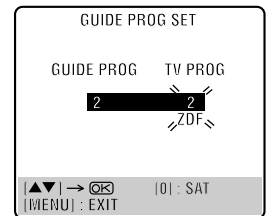

(Example) If ZDF is received on channel position 2.

- To timer-record a satellite programme with the SHOWVIEW system, you need to install the provided Satellite Controller and perform the procedure described in "Satellite Receiver Control Setting" (☞ pg. 17).
- Repeat steps 4 and 5 as necessary.

### 6 Return to the normal screen.

Press **MENU**.

## Guide Program Number

"Guide Program (GUIDE PROG) number" refers to the assigned TV station numbers, according to broadcast area, for the SHOWVIEW timer recording. The Guide Program numbers can be found in most TV listings.

Before requesting service for a problem, use this chart and see if you can repair the trouble yourself. Small problems are often easily corrected, and this can save you the trouble of sending your video recorder off for repair.

## POWER

SYMPTOM	POSSIBLE CAUSE	CORRECTIVE ACTION
1. No power is supplied to the recorder.	• The mains power cord is disconnected.	Connect the mains power cord.
2. The clock is functioning properly, but the recorder cannot be powered.	• "⊖" is displayed on the front display panel with "AUTO TIMER" set to "OFF".	Press the ⊖ button to turn the "⊖" indicator off.
3. The remote control won't function.	• The batteries are discharged.	Replace the dead batteries with new ones.

## TAPE TRANSPORT

SYMPTOM	POSSIBLE CAUSE	CORRECTIVE ACTION
1. The tape does not run during recording.	• "⏏" is displayed on the front display panel.	Press ▶ to turn the "⏏" indicator off.
2. The tape will not rewind or fast-forward.	• The tape is already fully rewound or fast-forwarded.	Check the cassette.









## PLAYBACK

SYMPTOM	POSSIBLE CAUSE	CORRECTIVE ACTION
1. The playback picture does not appear while the tape is running.	• The TV receiver is not set to the AV mode.	Set the TV to its AV mode.
2. Noise appears during visual search.	• This is normal.	
3. Noise appears during normal playback. (VHS deck only)	• The automatic tracking mode is engaged.	Try manual tracking. (📄 pg. 25)
4. The playback picture is blurred or interrupted while TV broadcasts are clear or "USE CLEANING CASSETTE" message appears on the screen.	• The video heads may be dirty.	<b>For the VHS deck</b> Use a dry cleaning cassette TCL-2, or consult your JVC dealer. <b>For the DV deck</b> Use a dry cleaning cassette M-DV12CL, or consult your JVC dealer.
5. Breaks are noticeable in Hi-Fi soundtrack. (VHS deck only)	• The automatic tracking mode is engaged.	Try manual tracking. (📄 pg. 25)

## RECORDING

SYMPTOM	POSSIBLE CAUSE	CORRECTIVE ACTION
1. Recording cannot be started.	<ul style="list-style-type: none"> <li>● <b>For the VHS deck</b> There is no cassette loaded, or the cassette loaded has had its record safety tab removed.</li> <li>● <b>For the DV deck</b> There is no cassette loaded, or the cassette loaded has had its erase protection switch set to "SAVE".</li> </ul>	<p>Insert a VHS (or S-VHS) cassette, or using adhesive tape, cover the hole where the tab was removed.</p> <p>Insert a Mini DV cassette, or set the erase protection switch set to "REC".</p>
2. TV broadcasts cannot be recorded.	<ul style="list-style-type: none"> <li>● "L-1", "L-2", "F-1" or "SAT" has been selected as the input mode.</li> </ul>	Set to the desired channel.
3. Tape-to-tape editing is not possible.	<ul style="list-style-type: none"> <li>● The source (another video recorder, camcorder) has not been properly connected.</li> <li>● All necessary power switches have not been turned on.</li> <li>● The input mode is not correct.</li> </ul>	<p>Confirm that the source is properly connected.</p> <p>Confirm that all units' power switches are turned on.</p> <p>Set the input mode to "L-1", "L-2" or "F-1".</p>
4. Camcorder recording is not possible.	<ul style="list-style-type: none"> <li>● The camcorder has not been properly connected.</li> <li>● The input mode is not correct.</li> </ul>	<p>Confirm that the camcorder is properly connected.</p> <p>Set the input mode to "L-1", "L-2" or "F-1".</p>
5. "⏏" on the front display panel won't stop blinking.	<ul style="list-style-type: none"> <li>● The end of the tape was reached during recording.</li> </ul>	The programme may not have been recorded in its entirety. Next time make sure you have enough time on the tape to record the entire programme.
6. Audio dubbing is not possible.	<p><b>For the DV deck</b></p> <ul style="list-style-type: none"> <li>● "SOUND MODE" had been set to "16BIT" at the original recording.</li> <li>● The tape speed had been set to LP at the original recording.</li> </ul>	<p>Set "SOUND MODE" to "12BIT" at the original recording. (ⓘ pg. 73)</p> <p>Set the tape speed to SP at the original recording.</p>
7. Monitoring the audio-dubbed sound is not possible during audio dubbing using the DV deck.	<ul style="list-style-type: none"> <li>● This is normal.</li> </ul>	Set "12BIT MODE" to "SOUND 2" or monitor the sound using the connected devices.
8. The programmed memory of Random Assemble Editing is disappeared.	<ul style="list-style-type: none"> <li>● The memory backup time has expired.</li> </ul>	Perform Random Assemble Editing again. (ⓘ pg. 58)
9. When performing Normal Dubbing, the beginning of the dubbing start point is not dubbed.	<ul style="list-style-type: none"> <li>● This is normal.</li> </ul>	Locate the start point a little before the point where you want to start dubbing. (ⓘ pg. 46, 47)

## TIMER RECORDING

SYMPTOM	POSSIBLE CAUSE	CORRECTIVE ACTION
1. Timer recording won't work.	<ul style="list-style-type: none"> <li>• The clock and/or the timer have been set incorrectly.</li> <li>• The timer is not engaged.</li> <li>• Timer recording may not work when the recorder's input mode is set to "F-1" for recording on the DV deck.</li> </ul>	<p>Re-perform the clock and/or timer settings.</p> <p>Press  and confirm that "" is displayed on the front display panel.</p> <p>Set the channel position other than "F-1" before engaging to Timer-Standby mode.</p>
2. Timer programming is not possible.	<ul style="list-style-type: none"> <li>• Timer recording is in progress.</li> </ul>	<p>Timer programming can't be performed while a timer recording is in progress. Wait until it finishes.</p>
3. "  " and "  " on the front display panel won't stop blinking.	<ul style="list-style-type: none"> <li>• The timer is engaged but there's no cassette loaded.</li> <li>• The end of the tape was reached during timer recording.</li> <li>• <b>VHS deck</b> The loaded cassette has had its record safety tab removed.</li> <li>• <b>DV deck</b> The loaded cassette has had its erase protection switch set to "SAVE".</li> </ul>	<p><b>For the VHS deck</b> Insert a VHS (or S-VHS) cassette with the record safety tab intact, or cover the hole using adhesive tape.</p> <p><b>For the DV deck</b> Insert a Mini DV cassette with the erase protection switch set to "REC".</p> <p>The programme may not have been recorded in its entirety. Next time make sure you have enough time on the tape to record the entire programme.</p> <p>Remove the cassette and cover the hole with adhesive tape, or insert a cassette with the record safety tab intact.</p> <p>Remove the cassette and set the erase protection switch to "REC".</p>
4. "  " blinks for 10 seconds and the Timer mode is disengaged.	<ul style="list-style-type: none"> <li>•  has been pressed when there are no programs in memory, or the timer record information has been programmed incorrectly.</li> </ul>	<p>Check the programmed data and re-program as necessary, then press  again.</p>
5. The SHOWVIEW system does not timer-record properly.	<ul style="list-style-type: none"> <li>• The recorder's channel positions have been set incorrectly.</li> </ul>	<p>Refer to "Guide Program Number Set" ( pg. 82) and re-perform the procedure.</p>
6. The power shuts off and "  " won't stop blinking.	<ul style="list-style-type: none"> <li>• The end of the tape was reached during Instant Timer Recording.</li> </ul>	<p>The programme may not have been recorded in its entirety. Next time make sure you have enough time on the tape to record the entire programme.</p>

**OTHER PROBLEMS**

SYMPTOM	POSSIBLE CAUSE	CORRECTIVE ACTION
1. Whistling or howling is heard from the TV during camcorder recording.	<ul style="list-style-type: none"> <li>• The camcorder's microphone is too close to the TV.</li> <li>• The TV's volume is too high.</li> </ul>	<p>Position the camcorder so its microphone is away from the TV.</p> <p>Turn the TV's volume down.</p>
2. When scanning channels, some of them are skipped over.	<ul style="list-style-type: none"> <li>• Those channels have been designated to be skipped.</li> </ul>	<p>If you need the skipped channels, restore them (☞ pg. 76).</p>
3. The channel cannot be changed.	<ul style="list-style-type: none"> <li>• Recording is in progress.</li> </ul>	<p>Press <b>  </b> to pause the recording, change channels, then press <b>▶</b> to resume recording.</p>
4. Channel settings that were made manually seem to have changed or disappeared.	<ul style="list-style-type: none"> <li>• After the manual settings were made, Auto Channel Set was performed.</li> </ul>	<p>Perform manual setting again.</p>
5. No channels are stored in the recorder's memory.	<ul style="list-style-type: none"> <li>• The TV aerial cable was not connected to the recorder when Auto Set Up was performed.</li> <li>• The fully-wired 21-pin SCART cable was not connected between TV and the recorder when Preset Download was performed.</li> </ul>	<p>Turn off the recorder once and connect the TV aerial cable to the recorder properly, then turn on the recorder again. The recorder will try Auto Set Up again (☞ pg. 12).</p> <p>Turn off the recorder once and connect the fully-wired 21-pin SCART cable to the recorder properly, then turn on the recorder again. Then perform Preset Download again (☞ pg. 14).</p>
6. The remote control won't operate the TV or satellite receiver.	<ul style="list-style-type: none"> <li>• The remote control brand setting is incorrect.</li> </ul>	<p>Re-set the remote control to the correct brand. (☞ pg. 61, 62)</p>
7. No picture appears when you connect a device to DV IN/OUT connector.		<p>Turn off the recorder or the connected appliance once, then turn it on again.</p>

**ATTENTION**

This recorder contains microcomputers. External electronic noise or interference could cause malfunctioning. In such cases, switch the recorder off and unplug the mains power cord. Then plug it in again and turn the recorder on. Take out the cassette. After checking the cassette, operate the unit as usual.

## PLAYBACK

**Q. What happens if the end of the tape is reached during playback or search?**

A. The tape is automatically rewound to the beginning.

**Q. Can the video recorder indefinitely remain in the pause mode?**

A. No. It stops automatically after 5 minutes on the VHS deck, 3 minutes on the DV deck to protect the heads.

**Q. When returning from variable-speed search to normal playback, the picture is disturbed. Should I be concerned about this?**

A. No, it is normal.

**Q. Noise bar appear during variable-speed search. What's the problem?**

A. This is normal.

**Q. Sometimes, during Index Search, the video recorder can't find the programme I want to see. Why not?**

A. There may be index codes too close together.

## RECORDING

**Q. When I pause and then resume a recording, the end of the recording before the pause is overlapped by the beginning of the continuation of recording. Why does this happen?**

A. This is normal. It reduces distortion at the pause and resume points.

**Q. Can the video recorder indefinitely remain in the Record-Pause mode?**

A. No. The video recorder goes to its Stop mode automatically after 5 minutes to protect the heads.

**Q. What happens if the tape runs out during recording?**

A. The video recorder stops recording, and "⏏" on the front display panel won't stop blinking.

## TIMER RECORDING

**Q. "○" and "⊖" remain lit on the front display panel. Is there a problem?**

A. No. This is a normal condition for a timer recording in progress.

**Q. Can I programme the timer while I'm watching a tape or a TV broadcast?**

A. You won't see the picture as it is replaced by the on-screen menu, but the audio from the programme or tape you're viewing can be heard.

**GENERAL**

Power requirement : AC 220 V – 240 V~, 50 Hz/60 Hz  
 Power consumption  
   Power on : 31 W  
   Power off : 6.5 W  
 Temperature  
   Operating : 5°C to 40°C  
   Storage : –20°C to 60°C  
 Operating position : Horizontal only  
 Dimensions (WxHxD)  
   : 435 mm x 106 mm x 380 mm  
 Weight : 5.1 kg  
 Input/Output : 21-pin SCART connectors:  
   IN/OUT x 1, IN/DECODER x 1  
   RCA connectors:  
   VIDEO IN x 1, AUDIO IN x 1,  
   AUDIO OUT x 1  
   S-Video connectors:  
   IN x 1, OUT x 1  
   DV connector:  
   IN/OUT x 1 (4-pin, IEEE1394  
   conformity, digital input/output)

**VHS DECK VIDEO/AUDIO**

Signal system : PAL-type colour signal and CCIR  
 monochrome signal, 625 lines  
 50 fields  
 Recording system : DA4 (Double Azimuth) head helical  
 scan system  
 Format : S-VHS/VHS PAL standard  
 Signal-to-noise ratio: 45 dB  
 Horizontal resolution  
   (SP/LP) : 250 lines (VHS)  
           400 lines (S-VHS)  
 Frequency range : 70 Hz to 10,000 Hz (Normal audio)  
                   20 Hz to 20,000 Hz (Hi-Fi audio)  
 Maximum recording time  
   (SP) : 240 min. with E-240 video cassette  
   (LP) : 480 min. with E-240 video cassette

**DV DECK VIDEO/AUDIO**

Signal system : PAL-type colour signal, 625 lines  
 50 fields  
 Recording system : Digital Component Recording  
 Format : DV format (SD mode)  
 Cassette : Mini DV Cassette  
 Maximum recording time  
   (SP) : 80 min. with M-DV80ME cassette  
   (LP) : 120 min. with M-DV80ME cassette  
 Audio recording system  
   : PCM 48 kHz, 16 bit (2 ch)/  
   32 kHz, 12 bit (4 ch)

**TUNER/TIMER**

TV channel storage capacity  
   : 99 positions (+AUX position)  
 Tuning system : Frequency synthesized tuner  
 Channel coverage : VHF 47 MHz – 89 MHz/  
                   104 MHz – 300 MHz/  
                   302 MHz – 470 MHz  
                   UHF 470 MHz – 862 MHz  
 Memory backup time  
   : Approx. 10 min.

**ACCESSORIES**

Provided accessories  
   : RF cable,  
   21-pin SCART/RCA cable,  
   BNC/RCA adapter x 2,  
   Satellite Controller,  
   Infrared remote control unit,  
   “R6” battery x 2

*Specifications shown are for SP mode unless otherwise specified.  
 E. & O.E. Design and specifications subject to change without  
 notice.*



<b>A</b>		<b>O</b>	
Audio Dubbing .....	54	O.S.D. ....	69
AUDIO REC .....	73	ON-SCREEN DISPLAY .....	7
Auto Channel Set .....	74	Output/Input Set .....	52
Auto Set Up .....	12	<b>P</b>	
AUTO SP→LP TIMER .....	70	PICTURE CONTROL .....	70
AUTO TIMER .....	69	PLAYBACK/RECORDING ON DV DECK .....	30
AV Insert Editing .....	57	PLAYBACK/RECORDING ON VHS DECK .....	20
<b>B</b>		POWER SAVE .....	69
B.E.S.T. ....	29, 70	Preset Download .....	14
<b>C</b>		<b>R</b>	
Change Station Channel Position .....	77	Random Assemble Editing .....	58
Check, cancel and change programmes .....	42	Record One Programme While Watching Another .....	26, 34
Clock Set .....	80	Recording Resume Function .....	26, 34
COLOUR SYSTEM .....	72	Remote Control Functions .....	60
Connecting To A Printer .....	63	Repeat Playback .....	24
Connecting To A Satellite Receiver .....	64	Retake .....	28
<b>D</b>		<b>S</b>	
Delete A Channel .....	77	Satellite Controller .....	17
DIGITAL 3R .....	71	Satellite Receiver Control Setting .....	17
DIGITAL TBC/NR .....	72	Set Stations (A) .....	78
DIRECT REC .....	19, 69	Set Stations (B) .....	78
<b>E</b>		SHOWVIEW® System Setup .....	82
EDITING .....	44	SHOWVIEW® Timer Programming .....	36
Elapsed Recording Time Indication .....	27	Skip Search .....	23
Express Timer Programming .....	38	Slow Motion .....	22, 32
<b>F</b>		SOUND MODE .....	73
Fine-Tuning Channels Already Stored .....	78	Soundtrack Selection .....	25, 33
<b>G</b>		Still Picture/Frame-By-Frame Playback .....	22, 32
Guide Program Number Set .....	37, 82	S-VHS .....	50, 71
<b>H</b>		S-VHS ET .....	71
High-Speed (Turbo) Search .....	23, 33	<b>T</b>	
<b>I</b>		Tape Dubbing (from DV to VHS) .....	44
Index Search .....	23	Tape Dubbing (from VHS to DV) .....	45
Insert Editing .....	56	Tape Position Indicator .....	7
Instant ReView .....	23	Tape Remaining Time .....	27
Instant Timer Recording (ITR) .....	26, 34	Time Code .....	35
<b>J</b>		TIMER RECORDING .....	36
Just Clock .....	80	Timer Warning Display .....	7
<b>L</b>		Tuner Set .....	74
L-1 INPUT .....	52	T-V LINK .....	19
L-1 OUTPUT .....	52	TV Station And ID List .....	79
L-2 SELECT .....	53	<b>V</b>	
Language .....	16	Variable Speed Search .....	23, 33
<b>M</b>		VHS F-1 INPUT .....	53
Manual Channel Set .....	76	VIDEO STABILIZER .....	72
Manual Tracking .....	25	VPS/PDC Recording .....	39
Mode Set .....	68	<b>W</b>	
<b>N</b>		When programmes overlap each other .....	43
Next Function Memory .....	24, 33	When Receiving A Scrambled Broadcast .....	77
Normal Dubbing (from DV to VHS) .....	46		
Normal Dubbing (from VHS to DV) .....	47	12BIT MODE .....	73
		24 Hour Express Timer Programming .....	40





## Auto Set Up — referring to the front display panel

The Auto Set Up function sets the tuner channels, clock and Guide Program numbers automatically.

### BEFORE YOU START PLEASE MAKE SURE THAT:

- The TV aerial cable is connected to the ANTENNA IN connector on the rear panel of the video recorder.
- The video recorder's mains power cord is connected to a mains outlet.
- The video recorder is turned off.
- Load batteries into the remote control.

1 Press  $\text{O/I}$  (recorder/remote).

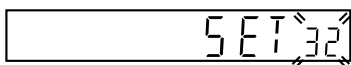

2 Press  $\Delta/\nabla$  (remote) to select the international telephone country code.

(Example) DEUTSCHLAND (49) is selected.

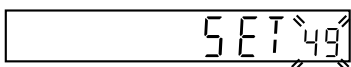

#### International Telephone Country Code

BELGIUM	: 32	NORGE	: 47
ČESKÁ REPUBLIKA	: 42	ÖSTERREICH	: 43
DANMARK	: 45	POLSKA	: 48
DEUTSCHLAND	: 49	PORTUGAL	: 351
ESPAÑA	: 34	SUISSE	: 41
GREECE	: 30	SUOMI	: 358
ITALIA	: 39	SVERIGE	: 46
MAGYARORSZÁG	: 36	OTHER WESTERN EUROPE	: --
NEDERLAND	: 31	OTHER EASTERN EUROPE	: EE

- If you have selected 32 (BELGIUM) or 41 (SUISSE), press **OK** (remote) and select the language code by pressing  $\Delta/\nabla$  (remote), then go to step 3.

(Example) FRANCAIS (03) is selected for BELGIUM (32).

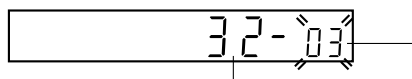

International telephone country code      Language code

#### Language Code

ENGLISH	: 01	NEDERLANDS	: 06
DEUTSCH	: 02	SVENSKA	: 07
FRANCAIS	: 03	NORSK	: 08
ITALIANO	: 04	SUOMI	: 09
CASTELLANO	: 05	DANSK	: 10

- If you have selected 36 (MAGYARORSZÁG), 42 (ČESKÁ REPUBLIKA), 48 (POLSKA) or EE (OTHER EASTERN EUROPE), press **OK**. The Clock Set screen appears. Set the clock manually (pg. 80), then go to step 3.
- If you have selected any other country name (code), press **OK** and go to step 3.

3 Press **OK** (remote). "Auto" appears on the front display panel.

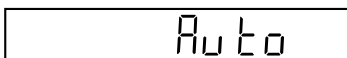

4 Press **OK** (remote) to start Auto Set Up. DO NOT press any button on the video recorder or remote control during "Auto" is blinking.

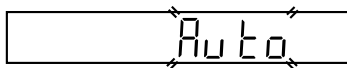

- If you have connected the recorder to a TV offering T-V Link via a 21-pin SCART cable (pg. 10) and the TV is turned on, the recorder automatically performs "Preset Download" (pg. 14) even if you select "Auto" in step 4.
  - If "--:--" appears on the front display panel, see page 15 of the instructions.
- \* Once you have performed Auto Set Up, even if the recorder's memory backup has expired, the recorder will not perform Auto Set Up again. Perform tuner setting (pg. 74) and/or clock setting (pg. 80) as required.

FOR MORE INFORMATION SEE INSTRUCTIONS ON PAGE 12

# JVC

VICTOR COMPANY OF JAPAN, LIMITED

## Free Manuals Download Website

<http://myh66.com>

<http://usermanuals.us>

<http://www.somanuals.com>

<http://www.4manuals.cc>

<http://www.manual-lib.com>

<http://www.404manual.com>

<http://www.luxmanual.com>

<http://aubethermostatmanual.com>

Golf course search by state

<http://golfingnear.com>

Email search by domain

<http://emailbydomain.com>

Auto manuals search

<http://auto.somanuals.com>

TV manuals search

<http://tv.somanuals.com>