

Please read this manual thoroughly before operating your new CD player

jWIN

CD/CD-R/CD-RW Compactible Super Anti Shock Anti Roll System **JOGGABLE**

**MODEL # JX-CD 650J (without Car Kit)
JX-CD 540J (with Car Kit)**

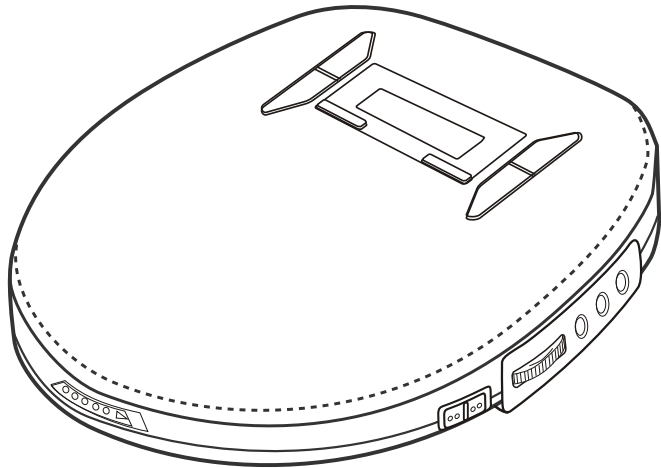

OPERATING INSTRUCTIONS

IMPORTANT NOTES

Avoid installing the unit in locations described below.
Places exposed to direct sunlight or close to heat radiating appliances such as electric heaters.
On top of other stereo equipment that radiates too much heat.
Places lacking ventilation or dusty places.
Places subject to constant vibration.
Humid or moist places.

This product utilizes a laser.

Danger - Invisible laser radiation is present when unit is opened and interlock failed or defeated.

Caution - Use of controls or adjustments of procedures other than those specified herein may result in hazardous radiation.

THIS LASER COMPACT DISC PLAYER FUNCTIONS BY HELP OF INVISIBLE LASER LIGHT AND IS EQUIPPED WITH SAFETY SWITCHES TO AVOID EXPOSURE WHEN DOOR IS OPEN AND SAFETY INTERLOCKS ARE DEFEATED. IT IS DANGEROUS TO DEFEAT OR BYPASS SAFETY SWITCHES.

	DANGER INVISIBLE LASER RADIATION WHEN OPEN AND INTERLOCK FAILED OR DEFEATED AVOID DIRECT EXPOSURE TO BEAM
	CAUTION HAZARDOUS LASER RADIATION WHEN OPEN AND INTERLOCK DEFEATED ATTENTION RAYONNEMENT LASER DANGEREUX SI OUVERT AVEC L'ENCLÈCHEMENT DE SÉCURITÉ ANNULÉ

	CAUTION RISK OF ELECTRIC SHOCK DO NOT OPEN	
CAUTION TO REDUCE THE RISK OF ELECTRIC SHOCK, DO NOT REMOVE COVER (OR BACK). NO USER-SERVICEABLE PARTS INSIDE. REFER SERVICING TO QUALIFIED SERVICE PERSONNEL.		

DANGEROUS VOLTAGE
Uninsulated Dangerous Voltage, that may be of sufficient magnitude to constitute a risk of electric shock to persons is present within this product's enclosure.

ATTENTION
The Owner's Manual contains important operating and maintenance instructions.
For your safety, it is necessary to refer to the manual.

WARNING: TO PREVENT FIRE OR SHOCK HAZARD. DO NOT EXPOSE THIS UNIT TO RAIN OR MOISTURE.

Dear Customer:

Selecting fine audio equipment such as the unit you've just purchased is only the start of your musical enjoyment. Now it's time to consider how you can maximize the fun and excitement your equipment offers. This manufacturer and the Electronic Industries Association's Consumer Electronics Group want you to get the most out of your equipment by playing it at a safe level. One that lets the sound come through loud and clear without annoying blaring or distortion and, most importantly, without affecting your sensitive hearing. Sound can be deceiving. Over time your hearing "comfort level" adapts to higher volumes of sound. So that sounds "normal" can actually be loud and harmful to your hearing. Guard against this by setting your equipment at a safe level BEFORE your hearing adapts.

To establish a safe level:

Start your volume control at a low setting.
Slowly increase the sound until you can hear it comfortably and clearly, and without distortion.

Once you have established a comfortable sound level:

Set the dial and leave it there.

Taking a minute to do this now will help to prevent hearing damage or loss in the future. After all, we want you listening for a lifetime.

We Want You Listening For A Lifetime

Used wisely, your new sound equipment will provide a lifetime of fun and enjoyment. Since hearing damage from loud noise is often undetectable until it is too late, this manufacturer and the Electronic Industries Association's Consumer Electronics Group recommend you avoid prolonged exposure to exposure to excessive noise. This list of sound levels is included for your protection.

Decibel Level	Example
30	Quiet Library, soft whispers
40	Living room, refrigerator, bedroom away from traffic
50	Light traffic, normal conversation, quiet office
60	Air conditioner at 20 feet, sewing machine
70	Vacuum cleaner, hair dryer, noisy restaurant
80	Average city traffic, garbage disposals, alarm clock at two feet



THE FOLLOWING NOISES CAN BE DANGEROUS UNDER CONSTANT EXPOSURE:

90	Subway, motorcycle, truck traffic, lawn mower
100	Garbage truck, chain saw, pneumatic drill
120	Rock band concert in front of speakers, thunderclap
140	Gunshot blast, jet engine
180	Rocket launching pad



Information courtesy of the Deafness Research Foundation.

INDUSTRY CANADA NOTICE

Operation is subject to the following two conditions: (1) this device may not cause interference, and (2) this device must accept any interference, including interference that may cause undesired operation of the device.

LOCATION OF CONTROLS

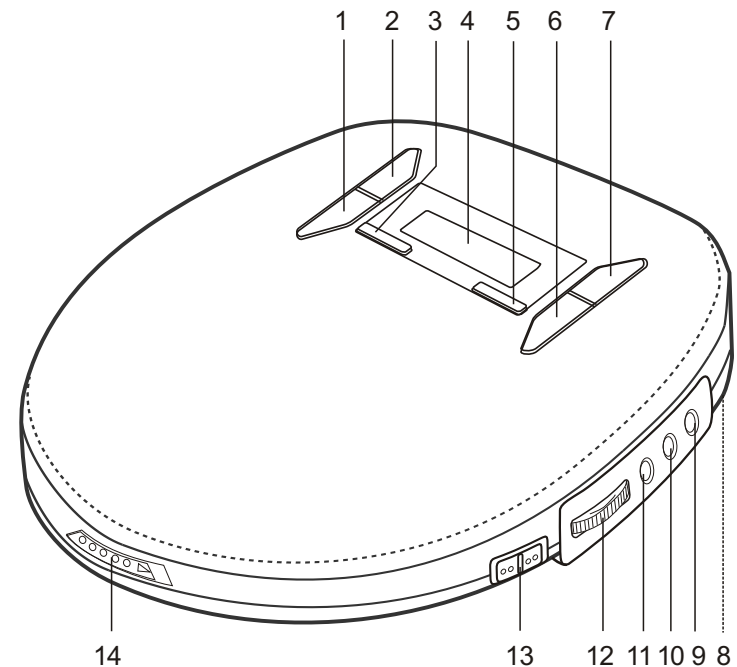

1. SEARCH/SKIP-
2. SEARCH/SKIP+
3. PROG. BUTTON
4. DISPLAY LENS
5. MODE BUTTON
6. PLAY/PAUSE BUTTON
7. STOP BUTTON
8. RECHARGE SWITCH
9. DC 6V INPUT SOCKET
10. LINE OUT SOCKET
11. HEADPHONE SOCKET
12. VOLUME CONTROL
13. DBBS SWITCH
14. DOOR OPEN SWITCH

POWER SOURCES BATTERIES/AC ADAPTOR

Battery Power Operation

1. Open the battery compartment cover and insert two 'AA' alkaline batteries inside the battery compartment. Follow the polarity as indicated on the bottom of the cabinet.
2. Close the battery compartment cover.

Battery Type (using 2 batteries)	Average Playing Time (Normal Play Mode)	Anti Shock Mode Only
Alkaline MN 1500, LR 6 or Equivalent	13 Hours	
Ni-CAD rechargeable (min. Specification recommended 1.2V-650mA)	5 Hours	

Note: Zinc/Carbon, or Zinc/Chloride type batteries are not recommended for this unit as their use will result in extremely short playing times. Wherever possible and for economy it is recommended that the AC adaptor supplied with this unit is used.

AC Operation (optional)

1. Insert the DC plug, at the end of the AC adaptor cord into the DC input socket, at the side of the unit.
2. Plug the AC adaptor(not included) into a 120V AC power outlet socket.

Note If the AC plug does not fit in your AC outlet, a plug adaptor (not included) should be used. Consult your local dealer on the type of plug adaptor required.

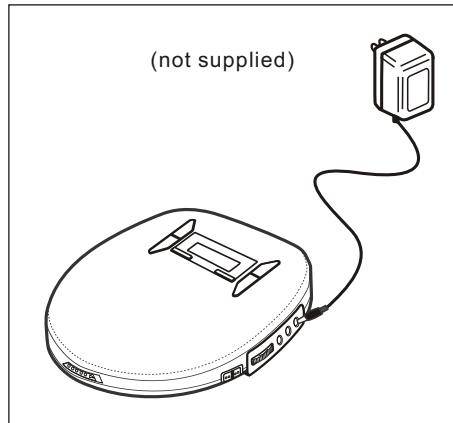

HEADPHONE AND HI-FI CONNECTION

■ Listening with the Hearphones

Connect the plug of the stereo earphones (not included) or headphones (included) into the PHONES (Green) socket.

Caution: Avoid excessive volume levels and listening to sound for a long period of time when using headphones.

■ Connecting to component audio systems

Connect the stereo connection cable (not included) into the LINE OUT (BLACK) socket of the unit and the CD/AUX inputs of an audio system.

Note: Always switch the power off before making any connections between the player and another unit.

BASIC DISC PLAY

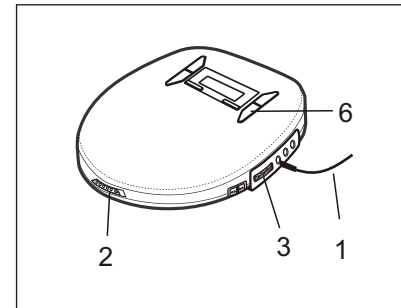

1. Connect the headphones to the PHONES (GREEN) socket.
2. Slide the OPEN switch to open the CD compartment lid.
3. Adjust the VOLUME to minimum.
4. Insert the disc with the label side Facing up. Push down in the center until disc is locked in place.
5. Close the lid securely until a click is heard.
6. Press the PLAY button to start playing.

Note: FSP function will automatically engage (Pg11)

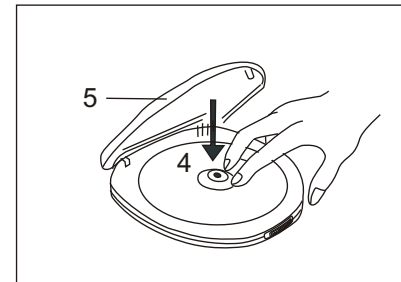

To remove the disc

Hold the edge and gently press the center pivot as illustrated, then pick up the disc.

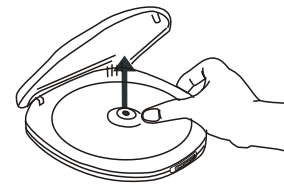

CAUTION:

Wait for the disc to stop rotating before sliding the OPEN switch.

NOTE:

Only compact disc marked with the  are guaranteed to work on this player. Home recorded disc's (CDR) recorded on home PC's may not play or operate correctly. CDRW disc cannot be played. This unit can play 3" (8cm) single CD's without an adaptor. Do not use a CD single adaptor for these discs.

Turning Power on and off

This unit has no ON/OFF switch.
To turn on: Press **▶||** PLAY/PAUSE (playback Starts)

To turn off: Press **■** STOP button once to enter standby mode. Press **■** STOP button twice, to turn off the power immediately.

Auto power - off function

When the unit is stopped (standby mode) for approximately 1 minute, the power is automatically turned off.

LCD DISPLAY INFORMATION

When the ► is pressed at initial start up

The display will briefly show as diagram then proceed to start playback.

To review the total number of tracks on the disc and total disc time, press the ■ STOP button once.

Note: The JOGGA buffer will fill automatically. If JOGGA function is not required, press FSP button to switch if off.



During PLAY mode

The track number and the elapsed playing Time are displayed.

Track no.

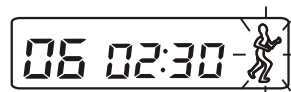

Elapsed time

This sixth track has elapsed 2 min 30sec.

During PAUSE mode

The track playback is paused, the elapsed time flashes.

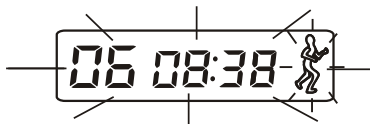

Note

When the lid is opened during play mode "----" shows in the display indicating that the door still open.

Note

A flashing □ indication appears on the display when the batteries need to be changed.



REPEAT / PLAY MODES

Every time the CD MODE button is pressed.

The corresponding mode appears in the display window.

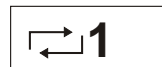
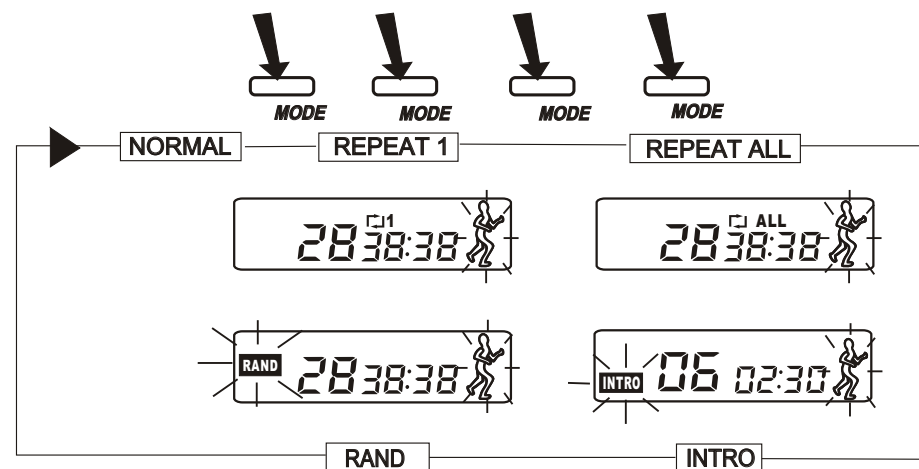

When shown on the LCD display; the current track on the disc will be repeated.



When shown on the LCD display; all tracks on the disc will be repeated.

During playback



MODE

During playback



MODE

NOTE: In normal mode none of the above symbols show in the display.

NORMAL PLAYBACK

Plays the whole disc.



Press once to play

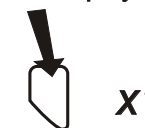

PLAY/PAUSE

INTRO SCAN AND PROGRAMMED TRACK PLAY

INTRO

Plays the first 10 seconds of each track on the disc.



During playback

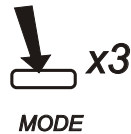

When in the STOP mode, press the MODE button three times and then press the PLAY/PAUSE button to start INTRO playback. During disc playback press the MODE button three times and then press the back skip button to start INTRO playback. Alternatively INTRO will start at the end of the current playing track.

PROGRAM

This allows selected tracks on the disc to be played in any desired order.

To program tracks

- * Program can only be set in the STOP mode.
- 1. Press the PROG button when the unit is in the stop mode.
 - * The track number and PROG indicator appear in the display.
- 2. Press or to select the desired track.
- 3. Press the PROG button to enter the track into memory.
- 4. Repeat step 2 and 3 to program up to 24 tracks into memory.
- 5. Press to start the programmed play.
- 6. To erase the program, simply press the STOP button twice.



Track no. of the first desired selection

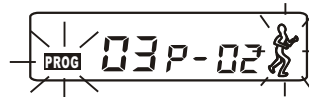

The second selection



RANDOM PLAY

RAND

Enables all the tracks on a disc to be played in a Random (Shuffle) sequence.

For example : If "RAND" is selected while playing track 8, the random function will commence once track 8 has ended. When all tracks on a disc have been played the player will automatically stop and power down in approx. 1 minutes to preserve battery life.

During playback

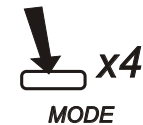

Press MODE button again to return to the NORMAL play mode.

SKIP AND SEARCH FUNCTIONS

Locating a Particular track

To skip back to the beginning of the current or a previous track

Press lightly and repeatedly.

To skip to the beginning of following tracks

Press lightly and repeatedly.

Locating a Particular Point in a track

To search back at a high speed

Keep depressed

To search forward at a high speed

Keep depressed

Low level audio will be heard during the search process to assist in locating correct point in the track.

CHARGING AND USE OF RECHARGEABLE BATTERIES

Rechargeable Battery Operation



This unit can fully recharge the specified rechargeable battery, in approximately 15 hours. The rechargeable batteries (NOT supplied) should be recharged before they are used for the first time because they are low in power or if they have not been used for a long period (over 60 days)

1. Open the battery compartment cover and insert two of the recommended rechargeable batteries, matching polarity. (1.2V 650mA)
BOTH BATTERIES MUST BE OF RECHARGEABLE NICKEL-CADMIUM TYPE, OTHERWISE THE BATTERIES MAY EXPLODE OR LEAK.
2. Plug in the AC adaptor and set the Recharge switch to ON position to start charging.
3. After 15 hours. Please unplug the AC adaptor and switch the Recharge switch to the OFF position.
DO NOT CHARGE CONTINUOUSLY FOR 24 HOURS OR MORE. DOING SO CAN CAUSE THE PERFORMANCE OF THE RECHARGEABLE BATTERIES TO DETERIORATE.

Note You may play DISC'S whilst charging the batteries.

4. If the operating time decreases drastically even when the rechargeable nickel-cadmium batteries are properly recharged, purchase a new set of rechargeable nickel-cadmium batteries.
5. When charging for the first time or after a long time, playing time may be reduced. In this case, charge and discharge the batteries several times.

FULL SHOCK PROTECTION

This player incorporates the latest digital anti shock circuit, which prevents interruption of the sound output if the unit is subjected to shock or vibration during disc playback. The anti shock system will automatically start when a disc is played,  is shown in the display during start up then  is flashes slowly when the data buffer is full and the JOGGABLE system is most effective.

Notes:

1. While the FULL SHOCK function provides continuous sound output when the unit is subjected to shock or vibration; it will not correct errors arising from the use of defective scratched or dirty discs.

PRODUCT SPECIFICATIONS

PICK-UP

System	Compact disc digital audio system
Laser diode	Material: GaAlAs
Properties	Wavelength : $\lambda = 780\text{nm}$ Emission duration : continuous Laser output : $<44.6\mu\text{W}$
Error correction	Cross-interleave Reed-solomon code

AUDIO

D/A conversion	1-bit DAC 8 times oversampling
Frequency response	20-20,000Hz (+1/-3 dB)
Wow and flutter	Below measurable limits
No. of channels	2 channels (stereo)
Output level	Line output : 0.6 Vrms (47K Ω) Heaphone: 15 mW (32 Ω)

GENERAL

Power requirements	- 2 x LR6 " AA " size alkaline battery - DC in 4.5V jack accepts AC power adaptor (center positive)
Power consumption	0.8W (DC 3V) UNDER NORMAL CONDITION
Weight	Approx.200g not including batteries (Main Unit)

ACCESSORIES AND ADDITIONAL FEATURES

(ONLY FOR JXCD 540J)

Compact Disc Cassette Adaptor

The cassette adaptor allows you to use your portable CD player with your car stereo cassette system or portable audio cassette system.

1. Insert the cassette adaptor in the same direction as you would insert an audio cassette tape.
2. Position the cord so that it feeds through the front of the cassette deck.
3. Insert the cassette adaptor stereo plug into the HEADPHONE JACK on the left side of the CD player.
4. Turn on the cassette player. Press PLAY on the cassette player.
5. Press PLAY on the CD player.
6. Set the volume of the CD player to a mid-level. Adjust the volume of the cassette player.

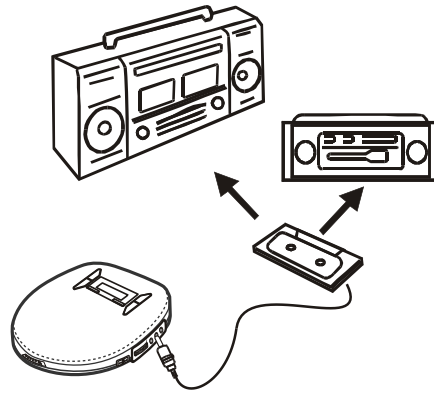

Note:

The cassette adaptor has the play head on one side only. If you insert the cassette and no sound is heard, try turning the cassette over or pressing the reverse button of the cassette player to change direction.

The car cassette adaptor may not be compatible with all makes and models of cassette players.

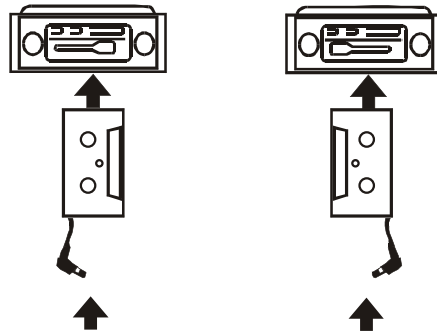

DC Cigarette Lighter Power Adaptor

Use the DC cigarette Lighter Adaptor to conserve battery life when using the CD player in a car.

1. Plug the adaptor into the car cigarette lighter.
2. Plug the pin into the 4.5V DC Jack on the left Side of the unit.

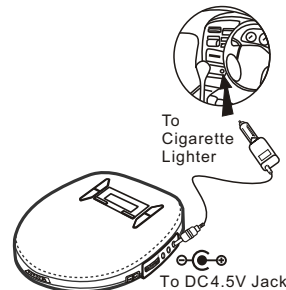

PLAYER MAINTENANCE

Cleaning the Cabinet

Wipe with a soft cloth. If the cabinet is very dirty, dampen the cloth with a weak solution of neutral detergent and water, and then wipe clean.

Cleaning the Lens

A dirty lens will cause sound skipping and, if the lens is very dirty, the CD may not work. Open the disc cover and clean the lens as follows:

Dust or Dry Particles

Using a camera lens brush/blower, blow on the lens a couple of times, then wipe it lightly with the brush to remove dust. Then, blow on the lens once more.

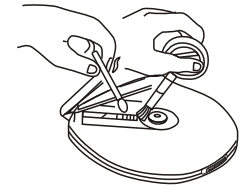

Finger prints

If the lens cannot be cleaned by using a brush / blower, use a dry cotton swab starting in the middle and working to the outside edge.

DISC CLEANING AND TROUBLESHOOTING GUIDE

Cleaning the Disc

When a disc becomes dirty, clean it with a cleaning cloth. Wipe the disc from the center out.

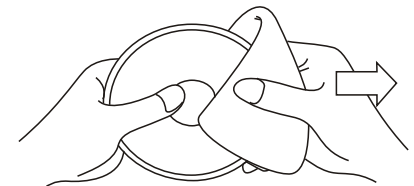

Note

Do not use solvents such as benzine petrol, thinner, commercially available cleaners or anti-static spray intended for analogue discs.

Should you experience difficulties in the use of this player please refer to the following chart before contacting your dealer or the place of purchase.

TROUBLE SHOOTING GUIDE

Troubleshooting Guide	
Problem	Points to Check
Player fails to function	<ul style="list-style-type: none"> Disc may be inserted upside down Disc not mounted correctly on chuck Dirty or defective disc Dirty pick up lens Player lid not closed Moisture/Condensation, allow player to warm up to room temperature for 60 minutes AC power to adaptor switched off Weak batteries Auto switch off has occurred
No sound from Headphones	<ul style="list-style-type: none"> Headphone plug is not firmly inserted into the Green Phones socket. Headphone have been inserted into the Black line output socket.
No sound when played through an external amplifier	<ul style="list-style-type: none"> Connection is incorrect Power to external amplifier not switched on
Intermittent sound	<ul style="list-style-type: none"> Dirty or defective disc Dirty pick up lens Player is subject to excessive vibration or shock Low battery power Poor Headphone connection

Free Manuals Download Website

<http://myh66.com>

<http://usermanuals.us>

<http://www.somanuals.com>

<http://www.4manuals.cc>

<http://www.manual-lib.com>

<http://www.404manual.com>

<http://www.luxmanual.com>

<http://aubethermostatmanual.com>

Golf course search by state

<http://golfingnear.com>

Email search by domain

<http://emailbydomain.com>

Auto manuals search

<http://auto.somanuals.com>

TV manuals search

<http://tv.somanuals.com>