

jWIN JD-TV108

PORTABLE DVD PLAYER ***User Guide***



- *Before attempting to connect, operate or adjust this product, please save and read the User Guide completely.*
- *The style of the product shown in the User Guide may be different from the actual unit due to various models.*

Playable Format:

DVD/DVD±R/DVD±RW/Audio CD/Kodak Picture CD/JPEG Picture CD/MPEG 4/DviX

Manufactured under license from Dolby Laboratories. "Dolby" and the double-D symbol are trademarks of Dolby Laboratories.



| | | | |
|--|-----------|--|-----------|
| FCC and Safety Information | 1 | Frame Advance (Step) | 12 |
| Important Safety Instruction | 2 | Muting the Player | 12 |
| Precautions | 3 | Using Volume Function | 12 |
| Selecting the Type of Disc for the Type of TV Connected | 4 | Fast Forward and Backward | 13 |
| About This User Guide | 5 | Skipping a Chapter Ahead or Back | 13 |
| 1-1 Getting Started | 6 | Repeating Viewing | 13 |
| Front View | 6 | Repeating Sections Between Two Specific Points (A-B Repeats) | 13 |
| Top View | 6 | Displaying Scene Information | 13 |
| Right Side View | 6 | Changing Audio Soundtrack Language | 14 |
| Battery Installation for the Remote Control | 6 | 3D Audio Output Adjustment | 14 |
| Remote Control | 7 | Changing Subtitle Languages | 15 |
| Connect to External Equipment | 8 | Viewing from Different Angles | 15 |
| Input from External Equipment | 9 | Zooming a Scene During Playback | 15 |
| USB Flash Drive and SD/MMC Card Operation ... | 9 | Using a DVD Menu | 15 |
| Receiving Antenna TV Signal | 10 | Searching Scenes During Playback | 16 |
| Receiving TV Signal from Cable | 10 | Programming DVD Playback | 16 |
| How to Use TV Tuner | 10 | 2-2 Audio CD Operation | 17 |
| To Select Preferred Available Channels | 11 | Basic Playback | 17 |
| To Select a Specific Channel | 11 | Stopping Playback | 18 |
| To Recall Between the Current Channel and the Previous Channel | 11 | Pausing Playback | 18 |
| 2-1 DVD Operation | 12 | Muting the Player | 18 |
| Basic Playback | 12 | Using Volume Function | 18 |
| Returning to the Menu Screen | 12 | Displaying Track Information | 18 |
| Stopping Playback | 12 | Fast Forward and Backward | 18 |
| Pausing Playback | 12 | Skipping a Track Ahead or Back | 18 |
| | | Repeating Playback | 18 |

| | | | |
|--|-----------|--|-----------|
| Repeating Sections Between Two Specific Times (A-B Repeat) | 19 | 3-2 Audio Setup | 27 |
| 2 Channel Audio Output Adjustment | 19 | Digital Out | 27 |
| 3D Audio Output Adjustment | 19 | Downmix | 27 |
| Searching Music During Playback | 20 | Night Mode | 28 |
| Programming Music Playback | 20 | 3-3 Video Setup | 29 |
| 2-3 Kodak and JPEG Picture CDs Operation | 21 | Video Output | 29 |
| Basic Playback | 21 | TV Aspect | 29 |
| Stopping Playback | 22 | Brightness | 30 |
| Pausing Playback | 22 | Contrast | 31 |
| Zooming Pictures | 22 | Hue | 31 |
| Displaying Picture Information | 22 | Saturation | 32 |
| Skipping a Picture Ahead or Back | 22 | TV System | 32 |
| Repeating Playback | 22 | 3-4 System Setup | 33 |
| Programming Pictures in Title Menu | 22 | Screen Saver | 33 |
| Changing Slideshow Display | 23 | Angle Mark | 33 |
| 3 Initial OSD Setting | 24 | Default | 34 |
| Major OSD Settings | 24 | 4-1 LCD Setting | 35 |
| 3-1 Language Setup | 25 | Panel Setting | 35 |
| OSD Language | 25 | Invert Setting | 35 |
| Audio Language | 25 | Color Setting | 36 |
| Subtitle Language | 26 | Bright Setting | 36 |
| Menu Language | 26 | 5-1 Troubleshooting | 37 |
| | | 5-2 Disc Handling and Maintenance | 39 |



CAUTION:

This unit employs a laser. Due to possible eye injury, only qualified service personnel should remove the cover or attempt to service this device. Use of controls, adjustments, or the performance of procedures other than those specified herein may result in hazardous radiation exposure.

NOTE:

This equipment has been tested and found to comply with the limits for a Class B digital device pursuant to part 15 of the FCC Rules. These limits are designed to provide reasonable protection against harmful interference in a residential installation. This equipment generates, uses and can radiate radio frequency energy and, if not installed and used in accordance with the instructions, may cause harmful interference to radio communications. However, there is no guarantee that interference will not occur in a particular installation. If this equipment does cause harmful interference to radio or television reception, which can be determined by turning the equipment off and on, the user is encouraged to try to correct the interference by one or more of the following measures:

- Reorient or relocate the receiving antenna.
- Increase the separation between the equipment and receiver.
- Connect the equipment into an outlet on a circuit different from that to which the receiver is connected.
- Consult the dealer or an experienced radio/TV technician for help.

This product incorporates copyright protection technology that is protected by method claims of certain U.S. patents and other intellectual property rights owned by Macrovision Corporation and other rights owners. Use of this copyright protection technology must be authorized by Macrovision Corporation, and is intended for home and other limited viewing uses only unless otherwise authorized by Macrovision Corporation. Reverse engineering or disassembly is prohibited.

For the DVD Player with Progressive scan output: 'Consumers should note that not all high definition television sets are fully compatible with this product and may cause artifacts to be displayed in the picture. In case of Progressive scan picture problems, it is recommended that the user switch the connection to the "Standard Definition" output. If there are questions regarding our TV set compatibility with this model DVD Player, Please contact our customer service center.'

Since it is usual for DVD movies to be released at different times in different regions of the world, all players have region codes and disc can have an optional region code. If you load a disc of a different region code to your player, you will see the region code notice on the screen. The disc will not play, and should be unloaded.

(Possible region codes:)



There are 6 regions (also called "locals"). Each DVD player and disc will be played in one region ONLY.

- 1: Canada, U.S., U.S. Territories
- 2: Japan, Europe, South Africa, Middle East (including Egypt)
- 3: Southeast Asia, East Asia (including Hong Kong)
- 4: Australia, New Zealand, Pacific Islands, Central America, Mexico, South America, Caribbean
- 5: Former Soviet Union, Indian Subcontinent, Africa (also North Korea, Mongolia)
- 6: China

Never make or change connections with the power switched on.

CAUTION

VISIBLE AND INVISIBLE LASER RADIATION WHEN OPEN AVOID EXPOSURE TO BEAM (WARNING LOCATION: INSIDE ON LASER COVER SHIELD)

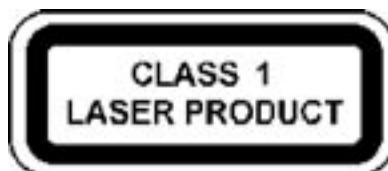



Important Safety Instruction

1. Read and keep these instructions.
2. Pay attention to all warnings.
3. Follow all instructions.
4. Do not use this apparatus near water.
5. Clean only with a damp cloth.
6. Do not block any of the ventilation openings. Install in accordance with the manufacturer's instructions.
7. Do not install near any heat sources such as radiators, heat registers, stoves, or other apparatus (including amplifiers) that produce heat.
8. Do not defeat the safety purpose of the polarized-type plug. A polarized plug has two blades with one wider than the other. The wide blade is provided for your safety. When the provided plug does not fit into your outlet, consult an electrician for replacement of the obsolete outlet.
9. Protect the power cord from being walked on or pinched particularly at plug, convenience receptacles, and the point where they exit from the apparatus.
10. Only use attachments/accessories specified by the manufacturer.
11. Unplug this apparatus during lightning storms or when unused for long periods of time.
12. Refer all servicing to qualified service personnel. Servicing is required when the apparatus has been damaged in any way; such as when the power-supply cord or plug is damaged, liquid has been spilled or objects have fallen into the apparatus, the apparatus has been exposed to rain or moisture, does not operate normally, or has been dropped.
13. Ambient Temperature 0~40°C.



WARNING: To reduce the risk of fire or electric shock, do not expose this apparatus to rain or moisture. The apparatus shall not be exposed to dripping or splashing and that not objects filled with liquids, such as vases, shall be placed on the apparatus.



Please read these precautions before operating the unit.

■ Power cord protection

To avoid any malfunctions of the unit, and to protect against electric shock, fire or personal injury, please observe the following.

- Hold the plug firmly when connecting or disconnecting the AC power cord.
- Keep the AC power cord away from heating appliances.
- Never put any heavy object on the AC power cord.
- Do not attempt to repair or modify the AC power cord in any way.

■ Placement

Avoid placing the unit in areas of:

- Direct sunlight or heating radiators, or closed automobiles
- High temperature (over 35°C) or high humidity (over 90%)
- Excessive dust, as the internal parts may be seriously damaged.

■ Non-use periods

When the unit is not being used, turn it off. When left unused for a long period of time, the unit should be unplugged from the household AC outlet.

■ No fingers or other objects inside

- Touching internal parts of the unit is dangerous, and may cause serious damage to the unit. Do not attempt to disassemble the unit.
- Do not put any foreign object on the disc tray.

■ Keep away from water/magnet

- Keep the unit away from vases, tubs, sinks, etc. If liquids are spilled into the unit, serious damage could occur.
- Never bring a magnet or magnetized object near the unit.

■ Stacking

- Place the unit in a horizontal position, and do not place anything heavy on it.

■ Condensation

Moisture may form on the internal lens under the following conditions:





- Immediately after a heater has been turned on
- In a steamy or very humid room
- When the unit is suddenly moved from a cold environment to a warm one. If moisture forms inside the unit, it may not operate properly. In this case, turn on the power and wait about one hour for the moisture to evaporate.

■ If there is noise or interference on the TV while a broadcast is being received

Depending on the reception condition of your TV (not the JD-TV108), interference may appear on the TV monitor while watching a TV broadcast when the JD-TV108 is left on. This is not a malfunction of the unit or the TV. To watch a TV broadcast without such interference, turn off the unit.

Your JD-TV108 is capable of playing DVD discs and having their content viewed on the unit's LCD display, as well as on an external TV. While your JD-TV108 is primarily intended to play NTSC DVDs, it can also play PAL DVDs (NTSC and PAL are video formats); refer to the Quick Guide and to the following information:

■ Connecting to a Multi-TV System (external) monitor (capable of viewing NTSC and PAL)

| DISC | TV MONITOR |
|---|--|
|  PAL |  Played in the PAL system. |
|  NTSC |  Played in the NTSC system. |





To View NTSC DVDs on a Multi-TV System Monitor:

1. In the VIDEO SETUP menu (see page 32), be sure the "TV SYSTEM" entry is set for *NTSC* (the default).
2. Be sure the Multi-TV System (external) Monitor is set to receive NTSC video signals.
3. The video content being played will appear on both the JD-TV108's LCD and on the external monitor.

To View PAL DVDs on a Multi-TV System Monitor:

1. In the VIDEO SETUP menu (see page 32), be sure the "TV SYSTEM" entry is set for *PAL*.
2. Be sure the Multi-TV System (external) Monitor is set to receive PAL video signals.
3. The video content being played will appear on both the JD-TV108's LCD and on the external monitor, but because the unit's LCD cannot display PAL video directly, it will appear without color content. The external monitor will display the PAL content in color. See the NOTE below.

■ Connecting to an NTSC TV

| DISC | TV MONITOR |
|---|--|
|  PAL |  No clear images are shown on the screen. |
|  NTSC |  Played in the NTSC system. |





To View NTSC DVDs on an NTSC TV Monitor:

1. In the VIDEO SETUP menu (see page 32), be sure the "TV SYSTEM" entry is set for *NTSC* (the default).
2. Be sure the *NTSC* Monitor is *ready* to receive NTSC video signals.
3. The video content being played will appear on both the JD-TV108's LCD and on the external monitor.

To View PAL DVDs on a PAL TV Monitor:

1. In the VIDEO SETUP menu (see page 32), be sure the "TV SYSTEM" entry is set for *PAL*.
2. Be sure the *PAL* Monitor is set to receive PAL video signals.
3. The video content being played will appear *without color* on JD-TV108's LCD. The external monitor will display the PAL content in color. See the NOTE below.

■ Connecting to the PAL TV

| DISC | TV MONITOR |
|---|--|
|  PAL |  Played in the PAL system. |
|  NTSC |  No clear images are shown on the screen. |

NOTE:

When viewing a PAL DVD on the unit's LCD display (without an external monitor), you must set the VIDEO SETUP menu's "TV SYSTEM" entry to NTSC (not PAL; see page 32).









In order for PAL video content to appear in color on the unit's LCD display, it must first be converted to NTSC. As already stated, PAL signals can appear in color on a PAL external monitor when the "TV SYSTEM" is set to PAL, but the same content will then appear in "black and white" on the LCD.



Note: Before attempting to connect, operate or adjust this product, please read and save this *User Guide* completely.

Thank you for buying the Portable DVD Player. Instructions in this *User Guide* describe mainly the use of the remote control. Buttons with the same or similar marking on your Portable DVD Player itself, have the same functions as those of the remote control. For introduction to the display (Portable DVD Player), buttons (Remote Control), and various connections, please refer to the *Quick Guide*.

The section below covers significant information about the unit's general behavior. Please read carefully. If you wish, you can use the same functions on the remote control.

- To turn on the DVD player, press  **Power** on the top panel of the player.
- To switch the player to Stand-by mode, press  **Power**. To resume to Play mode, press  **Power** again.
- When turning on the DVD Player, the unit directly enters DVD mode.
- If a disc is already placed on the disc tray, the recorder will start to load the disc right after power is turned on.
- To switch to other modes, do the following:
 - 1.** If there is no disc placed in the recorder, press  **Mode** to toggle through different modes.
 - 2.** If there is a disc placed in the recorder, press  **Stop** twice to completely stop DVD playback. Press  **Mode** to toggle through different modes.
- When pressing  **Stop** once during DVD playback, the player turns to a pre-stop status and memorizes the position where the playback is stopped. To start play from where the playback has been stopped, press  **Play**.
- Press  **Stop** twice to completely stop playback.
- If an "INVALID KEY" appears on the left top corner of the screen, it indicates that the action is prohibited or not available.

1-1 Getting Started

Front View

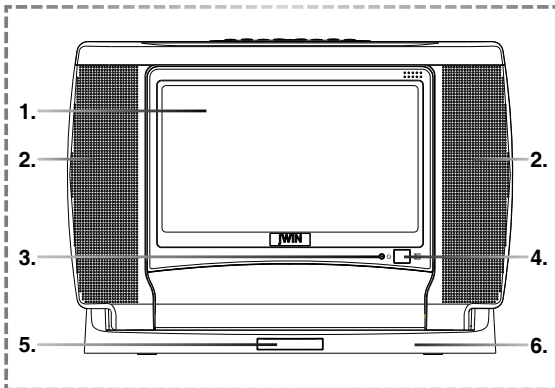

1. LCD Screen
2. Speakers
3. Power Indicator
4. Remote Sensor
5. Remote Control Carrier
6. Base

Right Side View

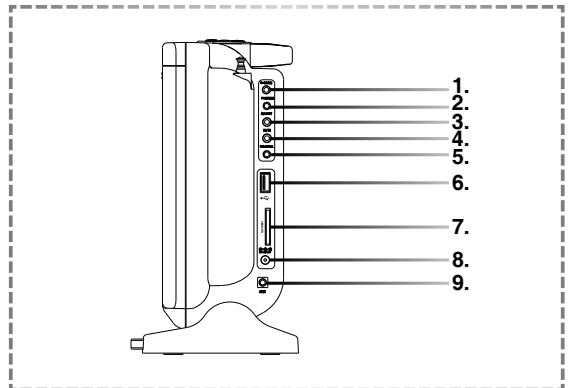

1. P-SCAN Output Jack
2. PHONES Jack
3. AV OUT Jack
4. AV IN Jack
5. COAXIAL Output Jack
6. USB Port
7. SD/MMC Card Slot
8. DC IN Jack
9. CABLE IN Jack

Top View

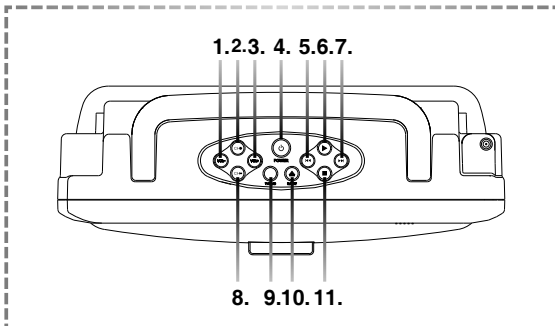

1. VOLUME(-) Button
2. CHANNEL(+) Button
3. VOLUME(+) Button
4. POWER Button
5. PREVIOUS Button
6. PLAY Button
7. NEXT Button
8. CHANNEL(-) Button
9. TV/DVD Button
10. EJECT Button
11. STOP Button

Battery Installation for the Remote Control

Insert the battery and match the (+) and (-) on battery to the marks inside the battery compartment.

First-time use:

Remember to remove the insulating mylar strip from the battery.

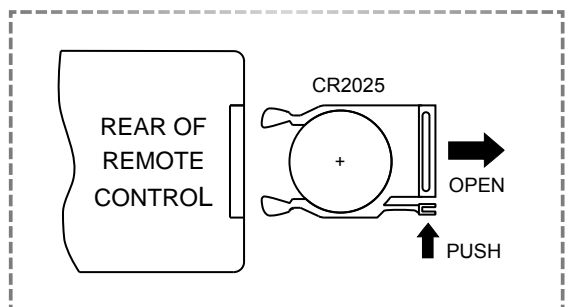



Service life of battery:

1. The battery normally lasts about one year although this depends on how often and for what operations the remote control is used.
2. If the remote control unit fails to work even when it is operated near the player, replace the battery.
3. Use a 3V lithium battery (No. CR2025).

11. Pause Button
12. Play Button
13. Fast Forward Button
14. Fast Backward Button
15. LCD Button
16. Mode Button
17. Angle Button
18. Audio Button
19. Title Button
20. Volume(+) Button
21. Cursor Button (▶)
22. Volume(-) Button
23. Search Button
24. Mute Button
25. Stop Button
26. TV Source/Info. Button
27. Channel(-)/Previous Button
28. Channel(+)/Next Button
29. Program Button
30. Repeat Button
31. Number Buttons

Remote Control

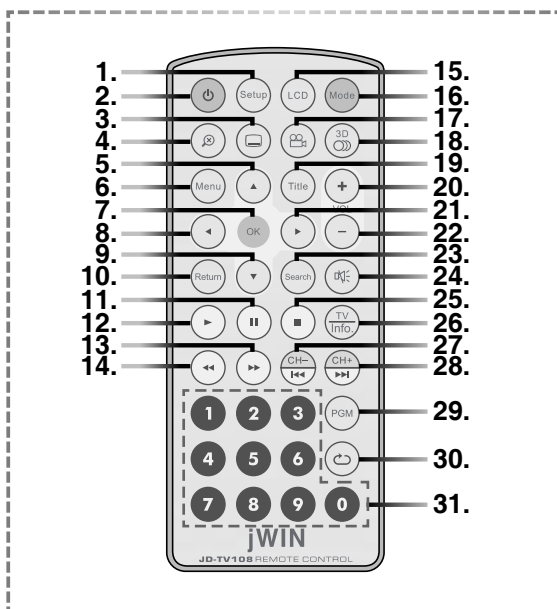

1. Setup Button
2. Power Button
3. Subtitle Button
4. Zoom Button
5. Cursor Button (▲)
6. Menu Button
7. OK Button
8. Cursor Button (◀)
9. Cursor Button (▼)
10. Return Button

Connect to External Equipment

- 1** Connect the Portable DVD Player to a source of power.

Connect the supplied AC adapter to the DC IN jack on the right side of the unit.

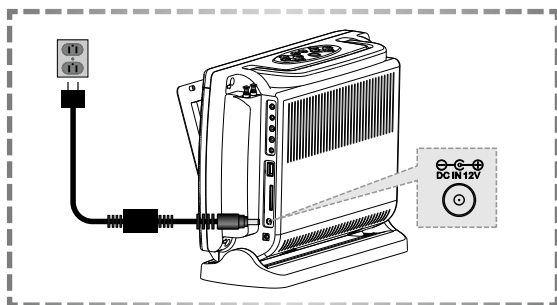

- 2** Connect the unit to external equipment and/or to earphones.

If you want to enjoy better listening and viewing quality, you can connect the Portable DVD Player to external equipment, such as a TV or an amplifier.

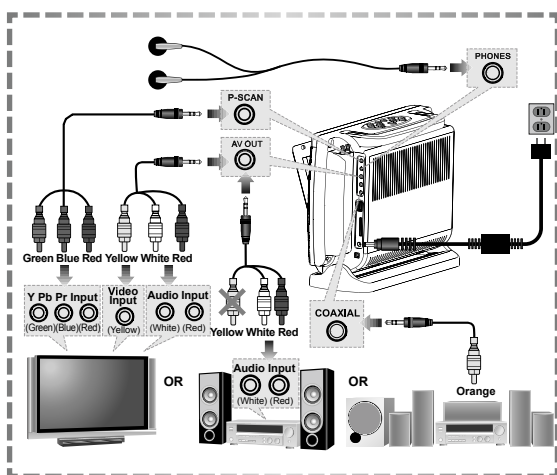

Note:

- Before connecting, make sure to turn off the power on the Portable DVD Player and the external equipment.
- Make sure the external equipment supports inputs from the JD-TV108. See the Quick Guide.

- 3** Press **Power** button on the top panel of the unit to turn on the DVD Player.

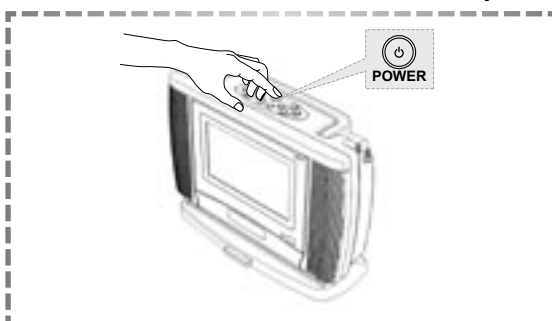

- 4** Press **Eject** button on the top panel of the unit to open the disc cover. Pull the cover forward, if necessary.

- 5** Gently hold the edge of the disc, then put it in the disc frame with the printed side down.

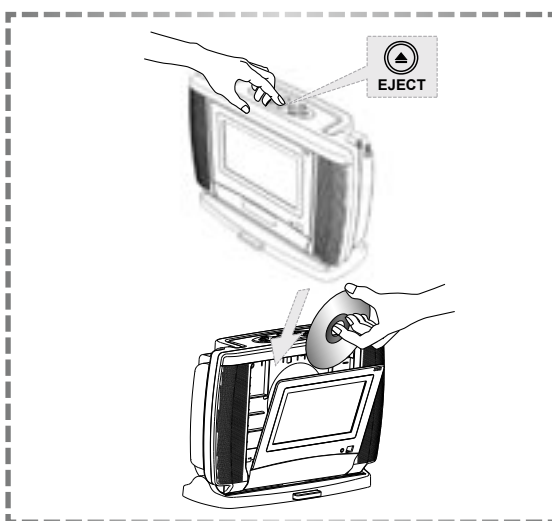

Note:

- This player doesn't support the 8cm (3.15 in.) disc playback.

- 6** Close the disc cover.

- 7** Press **Play** button on the top panel of the unit or **Play** on the remote control to play the disc.



Input from External Equipment

You could input images and sounds from external equipment by connecting the portable DVD player to external equipment with the audio or video cable.

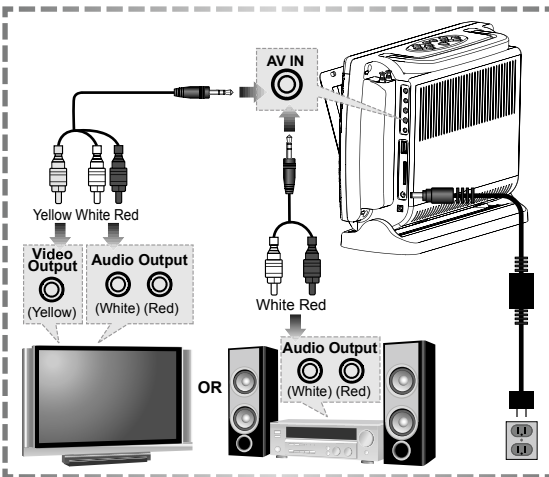

Note:

- Make sure the external equipment you wish to use has output connections available for the inputs in the JD-TV108.

USB Flash Drive and SD/MMC Card Operation

1 Insert a USB Flash Drive to the USB port or a SD/MMC card to the card slot on the right panel of the DVD player.

2 Press the **Mode** button on the remote control to select USB Mode or SD/MMC Card Mode.



Note:

- Press **Mode** a number of times. You can toggle through different modes, including "DVD Mode", "USB", "CARD", "AV IN" and "TV TUNER".

Insert a USB Flash Drive

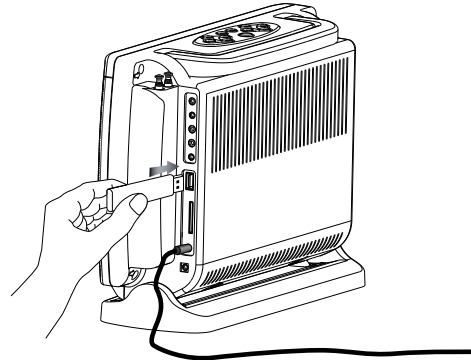

Insert a SD/MMC Card

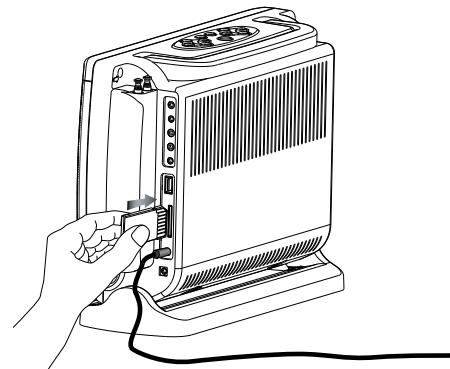

3 A file list appears on the screen, press **Up** / **Down** on the remote control to select a preferred JPEG or MP3 file.

4 Press **OK** or **Play** to play the selected file.

For Picture File Playback Only

- Press **Right** to rotate the picture clockwise by 90°.
- Press **Left** to rotate the picture anti-clockwise by 90°.



Note:

- Playable formats for the SD/MMC memory card operation include JPEG and MP3.
- If the JPEG file size is over 1.0MB, it may take more time to read.



1-1 Getting Started - continued

Receiving Antenna TV Signal

You could input images and sounds from external equipment by connecting the portable DVD player to external equipment with the audio or video cable.

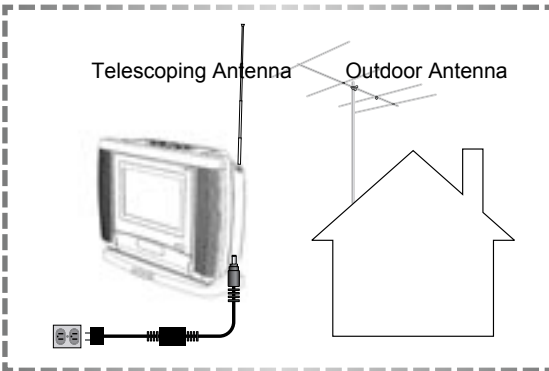

- 1 Raise the JD-TV108's telescoping antenna and position the unit so it is set to receive the best TV signals.

Receiving TV Signal from Cable

- 1 Connect the RF cable or antenna cable to the Antenna/Cable TV input jack (ANT.) on the lower right side of the DVD player.

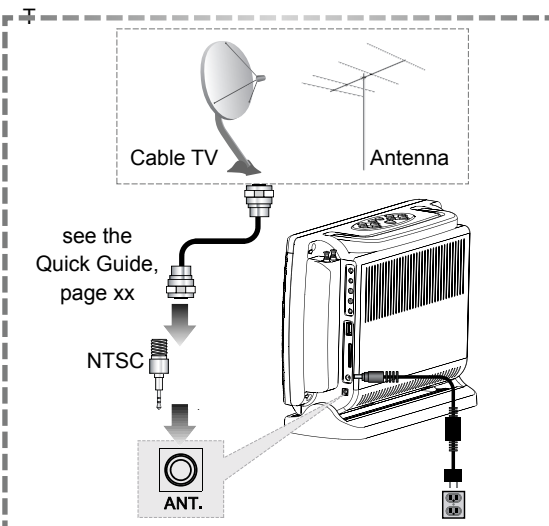

How to Use TV Tuner

- Make sure that the DVD Player is correctly connected.
- TV reception quality maybe different due to various areas.

- 1 Press **Power** button on the top panel of the unit to turn on the DVD Player.

- 2 Press **Mode** to select the "TV Tuner" mode.



Note:

- Press **Mode** a number of times. You can toggle through different modes, including "DVD Mode", "USB", "CARD", "AV IN" and "TV TUNER".

- 3 Press **TV** to select CABLE or ANTENNA as the TV source.

- 4 Press **Search**, a TV tuner window appears on the screen.

| | |
|-------------|--------------|
| Channel | ◀ 56 ▶ |
| Freq | ◀ 415.3MHz ▶ |
| Favorite | ◀ Yes ▶ |
| Auto search | ▶ |

- 5 Press **Up** / **Down** to highlight a preferred option.

- 6 Press **Left** / **Right** to select a setting for the highlighted option.

Channel

- Press **Right** to select the next channel or press **Left** to select the previous channel.



Freq:

- Press **Right** to increase the frequency or press **Left** to decrease the frequency for the best tuning.

Favorite:

- Press **Left** / **Right** to select “Yes” or “No”.

Auto search:

- Press **Right** and tuner search starts automatically and allows the channel to be confirmed.



Note:

- After proceeding with **Auto search**, the unit will store available TV channels. However, if more channels become available in your area, Auto search may need to be run again to update the available channels.
- Each time **Auto search** is run, all the previously stored channels will be erased and replaced.

7

To leave the TV tuner window, press **Search** again.

To Select Preferred Available Channels

1. Press **Channel-** / **Channel+** to choose a preferred channel for viewing.



Note:

- This function only works with available channels.
- If a channel is set to “No” in Favorite setting, the channel will be skipped while pressing **Channel-** / **Channel+** to toggle through channels.

To Select a Specific Channel

1. Press **Number Button(s)** specify the channel.



Note:

- This function can be applied to all the channels, including those that are set to “No” in the Favorite setting.

To Recall Between the Current Channel and the Previous Channel

1. Press **Repeat**, the previously selected channel can be recalled.



2-1 DVD Operation

Preparations:

Connect the Portable DVD Player to a source of Power and connect it to any external equipment if necessary. If external equipment is being used:

- Turn the external TV ON and select its video input that is connected to the DVD player's Video Out.
- Turn the stereo system on if the DVD recorder's audio output has been connected to it.

Basic Playback

- 1 Press **Power** on the top panel of the player to turn on the player.
- 2 Press **Eject** on the top panel of the player to open the disc tray and place a disc into the disc frame.
- 3 Close the tray. Playback of the disc starts automatically. If the disc contains a title menu, the menu will be displayed on the screen.
- 4 To play a title, press **Up** / **Down** to highlight it and then press **OK** or **Play**.

Returning to the Menu Screen

- 1 Press **Menu** or **Return** during playback to stop playback and display the title menu.



Note:

- This function only works when the disc contains a title menu.
- If the disc is placed in upside down (and it is a single sided disc), the player will display "NO DISC".

Stopping Playback

- 1 To prestop the disc playback, press **Stop** once.
- 2 To completely stop the disc playback, press **Stop** again.

Pausing Playback

- 1 Press **Pause** once to pause playback.
- 2 To return to normal playback, press **Play**.

Frame Advance (Step)

- 1 Press **Pause** to pause playback. Then for each press of the **Pause** button, the disc is advanced by one frame.
- 2 To return to normal playback, press **Play**.

Muting the Player

- 1 Press **Mute** once during playback to mute the audio output.
- 2 To resume the sound, press **Mute** again.

Using Volume Function

- 1 Press **Volume** during playback to adjust volume.



Fast Forward and Backward

- 1 Press **Fast Forward** or **Fast Backward** during playback.
The speed of advance (FORWARD \gg x2, FORWARD \gg x4, FORWARD \gg x8 and FORWARD \gg x20) or reverse (FORWARD \gg x2, FORWARD \gg x4, FORWARD \gg x8 and FORWARD \gg x20) changes for each press of **Fast Forward** or **Fast Backward**.

- 2 To return to normal playback, press **Play**.

Skipping a Chapter Ahead or Back

Skipping Ahead

- 1 Press **Next** during playback.
Press **Next** once midway through a chapter, and playback will start from the next chapter. A chapter is skipped each time the button is pressed.

Skipping Back

- 1 Press **Prev.** during playback.
Press **Prev.** once midway through a chapter, and playback will start from the previous chapter. A chapter is skipped each time the button is pressed.

Repeat Viewing

- 1 Press **Repeat** during playback, a repeat information box appears on the screen.

LEFT REP AB RIGHT REP DISC

- 2 Press **Right** repeatedly to select the following options:

REP: [CHAPTER] : Repeat Chapter

REP: [TITLE] : Repeat Title

REP: [OFF] : Repeat Off

Repeating Sections Between Two Specific Points (A-B Repeat)

- 1 Press **Repeat** during playback, and a repeat information box appears on the screen.

LEFT REP AB RIGHT REP DISC

- 2 Press **Left** during playback at the point where the repeating section will be started (A).

REPEAT A- appears on the screen.

- 3 Press **Left** again at the point where the repeating section will be ended (B).

REPEAT A-B appears on the screen.

- 4 To return to normal playback, press **Left** again during the repeat playback.

A-B CANCEL appears on the screen.

Displaying Scene Information

- 1 Press **Info.** during playback, an information display appears on the top of the screen and shows the information of Title, Chapter and Time.

- 2 Press **Info.** again. Information relating to Audio, Subtitles and Angle is shown.

- 3 To stop displaying scene information, press **Info.** again.

Changing Audio Soundtrack Language

- 1 Press **Audio** during playback. An audio display appears at the top of the screen.
- 2 To change audio soundtrack languages, press **Left** a number of times until a preferred language is selected. When no audio languages are recorded, "INVALID KEY" will be displayed instead of the language choices.



Note:

- This operation functions only with discs on which multiple audio soundtrack languages are recorded.
- When the preferred language is not selected even after pressing the button several times, it may indicate that language is not available on the disc.
- When you turn on or remove the disc, the Portable DVD player will playback the language selected at the initial setting. If you select a language which is not recorded on the disc, the Portable DVD player will playback a prior language programmed on the disc.

3D Audio Output Adjustment

- 1 Press **Audio** during playback. A audio display appears on the top of the screen.
- 2 To adjust the 3D sound effects of audio output, press **Right** to enter the 3D Audio Menu.
- 3 Press **Left** / **Right** to select a sound feature.

Note: Some or all of the following features may not be supported. If so, an "INVALID KEY" response will appear.

For Surround (SRND)

- Press **Up** / **Down** to select an option and press **OK** to confirm.

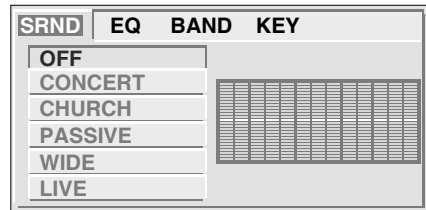

For EQ

- Press **Up** / **Down** to select an option and press **OK** to confirm.

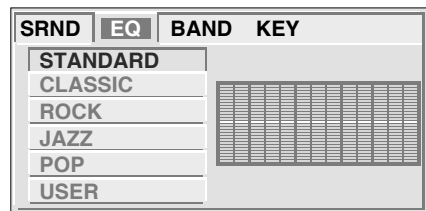

For BAND

- A frequency chart will be displayed as a musical file is played.

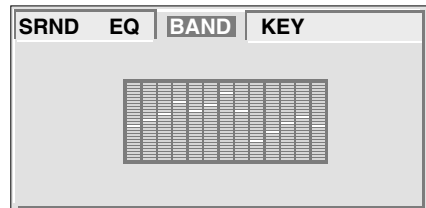



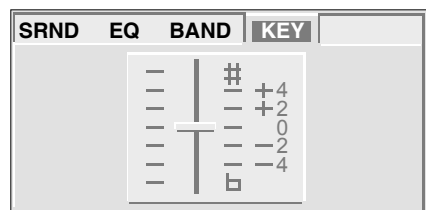

For KEY

- Press **Up** / **Down** to select an option and press **OK** to confirm.





Changing Subtitle Languages



- 1 Press  **Subtitle** during playback.
- 2 Press  **Subtitle** a number of times until the preferred language is selected.
When no subtitles are recorded, "INVALID KEY" will be displayed instead of the language number.
- 3 To clear the subtitle display, press  **Subtitle** until  : [OFF] appears on the screen.



Note:

- This operation works only with discs on which multiple subtitle languages are recorded.
- When the preferred subtitle language is not selected even after pressing the button several times, it may indicate that the language is not available on the disc.
- In some cases, the subtitle language may not change immediately to the selected one.
- When you turn on or remove the disc, Portable DVD player will playback the subtitle language which is selected as the initial setting. If you select a subtitle language which is not recorded on the disc, the Portable DVD player will playback a prior subtitle language programmed on the disc.

Viewing from Different Angles

- 1 Press  **Angle** during playback.
- 2 Press  **Angle** a number of times until the preferred viewing angle is selected.





Note:







- This operation works only with discs on which multiple viewing angles are recorded.

- The viewing angles are shown on the player's display and you can select one from them for viewing.

Zooming a Scene During Playback

- 1 Press  **Zoom** a number of times during playback to watch the scene with different enlargements of **Zoom 2, Zoom 3, Zoom 4, Zoom 1/2, Zoom 1/3 and Zoom 1/4**.
- 2 To return to normal playback, press  **Zoom** a number of times until **ZOOM: [OFF]** appears.

Using a DVD Menu

- 1 Press  **Title** in stop mode. The available DVD menu appears on the screen.
- 2 Press  **Up** /  **Down** /  **Left** /  **Right** to select a preferred option.
- 3 Press  **OK** to confirm and enter the menu screen of the selected option.
- 4 To return to the previous menu screen, press  **Title**.

Searching Scenes During Playback

- 1 Press **Search** during playback. A search display appears on the top of the screen.

TT 02/05 CH 002/006 ⌚ 00:52:06

- 2 Press **Left** / **Right** to highlight Title Number, Chapter Number or Time.
- 3 Press **Number Button(s)** to edit the Title Number, Chapter Number or Time.
- 4 New scene will be played according to the change.
- 5 To leave the search display, press **Search** again.

Programming DVD Playback

- 1 Press **Program** during playback. A programming list appears on the screen.

| T | C | T | C | T | C | T | C |
|------|-----|---|-----|-------|-----|----|-----|
| 1 | --- | 5 | --- | 9 | --- | 13 | --- |
| 2 | --- | 6 | --- | 10 | --- | 14 | --- |
| 3 | --- | 7 | --- | 11 | --- | 15 | --- |
| 4 | --- | 8 | --- | 12 | --- | 16 | --- |
| PLAY | | | | CLEAR | | | |

- 2 Press **Up** / **Down** **Left** / **Right** to highlight an item.

| T | C | T | C | T | C | T | C |
|------|-----|---|-----|-------|-----|----|-----|
| 1 | 02 | 5 | --- | 9 | --- | 13 | --- |
| 2 | --- | 6 | --- | 10 | --- | 14 | --- |
| 3 | --- | 7 | --- | 11 | --- | 15 | --- |
| 4 | --- | 8 | --- | 12 | --- | 16 | --- |
| PLAY | | | | CLEAR | | | |

- 3 Enter a preferred Title Number or Chapter Number by pressing **Number Button(s)**.

| T | C | T | C | T | C | T | C |
|------|-----|---|-----|-------|-----|----|-----|
| 1 | 02 | 5 | --- | 9 | --- | 13 | --- |
| 2 | --- | 6 | --- | 10 | --- | 14 | --- |
| 3 | --- | 7 | --- | 11 | --- | 15 | --- |
| 4 | --- | 8 | --- | 12 | --- | 16 | --- |
| PLAY | | | | CLEAR | | | |



Note:

- Please enter a Title Number before trying to enter a Chapter Number.
- 4 To play the programming list, press **Up** / **Down** **Left** / **Right** to highlight "PLAY" and then press **OK**.

| T | C | T | C | T | C | T | C |
|------|-------|---|-----|-------|-----|----|-----|
| 1 | 02:06 | 5 | --- | 9 | --- | 13 | --- |
| 2 | 07:11 | 6 | --- | 10 | --- | 14 | --- |
| 3 | 04:09 | 7 | --- | 11 | --- | 15 | --- |
| 4 | --- | 8 | --- | 12 | --- | 16 | --- |
| PLAY | | | | CLEAR | | | |

- 5 To clear the programming list, press **Up** / **Down** **Left** / **Right** to highlight "CLEAR" and then press **OK**.
- 6 To leave the programming list, press **Program** again.

2-2 Audio CD Operation



Preparations:

Connect your JD-TV108 to its source of power, and connect any external equipment to its outputs, if desired. If external equipment is connected:

- Turn the TV on and select its video input source that will receive the JD-TV108's video output.
- Turn the stereo system on if the JD-TV108 has been connected to one. Select the stereo system's input that will play the audio from the JD-TV108.

Basic Playback

- 1 Press **Power** on the top panel of the player to turn on the player.
- 2 Press **Eject** on the top panel of the player to open the disc tray and place an audio CD into the disc frame.
- 3 Close the tray. Disc playback starts automatically.

Playing an Audio CD without a Title Menu

- 4 If the disc contains no title menu, an information display appears on the top of the screen.

TRK 2/16 00:02:06

Playing an Audio CD with a Title Menu

- 4 If the disc contains a title menu, the menu will be displayed on the screen.

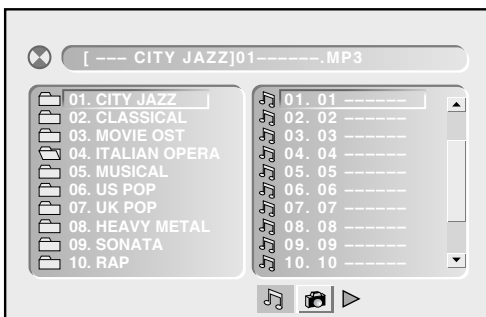

- 5 To select a file folder, press **Left** to enter the folder list on the left of the screen, press **Up / Down** to highlight a folder and then press **OK** or **Play**.

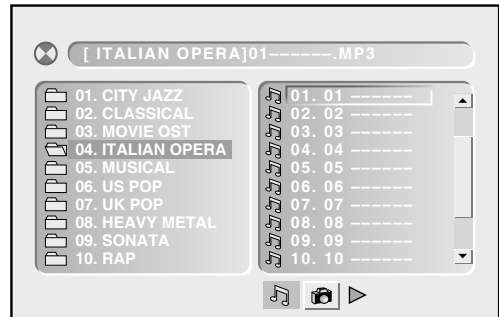

- 6 To play a track, press **Left** to enter the file list on the right of the screen, press **Up / Down** to highlight a track and then press **OK** or **Play**.

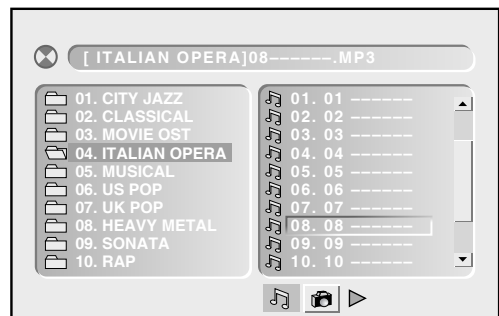



Note:

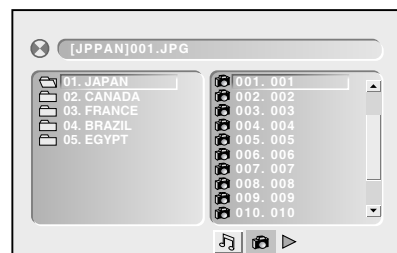

- Some discs may contain both music and picture file formats. When the player reads the disc, music files will be the priority to be played. To select Picture CD mode, press **Right** until the Picture CD symbol is selected. Press **OK** or **Play**.





Stopping Playback

- 1 To prestop the disc playback, press  **Stop** once.
- 2 To completely stop the disc playback, press  **Stop** again.

Pausing Playback

- 1 Press  **Pause** once to pause playback.
- 2 To return to normal playback, press  **Pause** again or  **Play**.



Muting the Player

- 1 Press  **Mute** once during playback to mute the audio output.
- 2 To resume the sound, press  **Mute** again.













Using Volume Function

- 1 Press   **Volume** during playback to adjust volume.

Displaying Track Information



- 1 Press  **Info.** during playback, an information display appears on the top of the screen.
- 2 To stop displaying scene information, press  **Info.** again.

Fast Forward and Backward



- 1 Press  **Fast Forward** or  **Fast Backward** during playback.
The speed of advance (**FORWARD**  x2, **FORWARD**  x4, **FORWARD**  x8 and **FORWARD**  x20) or reverse (**FORWARD**  x2, **FORWARD**  x4, **FORWARD**  x8 and **FORWARD**  x20) changes for each press of  **Fast Forward** or  **Fast Backward**.
- 2 To return to normal playback, press  **Play**.

Skipping a Track Ahead or Back

Skipping Ahead

- 1 Press  **Next** during playback.
Press  **Next** once midway through a track, and the playback will start from the next track. A track is skipped each time the button is pressed.

Skipping Back

- 1 Press  **Prev.** during playback.
Press  **Prev.** once midway through a track, and the playback will start from the previous track. A track is skipped each time the button is pressed.

Repeating Playback

- 1 Press  **Repeat** during playback, and a repeat information box appears.

LEFT REP AB RIGHT REP DISC

- 2 Press  **Right** repeatedly to select the following options:

REP: [REP 1] : Repeat Track

REP: [REP All] : Repeat Disc

REP: [REP DIR] : Repeat Directory (appears only when there are file directories saved in the CDs).

REP: [OFF] : Repeat Off



Repeating Sections Between Two Specific Times (A-B Repeat)

- 1 Press **Repeat** during playback, and a repeat information box appears on the screen.

LEFT REP AB RIGHT REP DISC

- 2 Press **Left** during playback at the time where repeating section will be started (A).

REPEAT A- appears on the screen.

- 3 Press **Left** again at the time where the repeating section will be ended (B).

REPEAT A-B appears on the screen.

- 4 To return to normal playback, press **Left** again during the repeat playback.

A-B CANCEL appears on the screen.

2 Channel Audio Output Adjustment

- 1 Press **Audio** during playback. A audio display appears on the top of the screen.

- 2 To change audio soundtrack languages, press **Left** a number of times until a preferred audio output is selected.

3D Audio Output Adjustment

- 1 Press **Audio** during playback. A audio display appears on the top of the screen.

- 2 To adjust the 3D sound effect of audio output, press **Right** to enter the 3D Audio Menu.

- 3 Press **Left** / **Right** to select a feature.

For Surround (SRND)

- Press **Up** / **Down** to select an option and press **OK** to confirm.

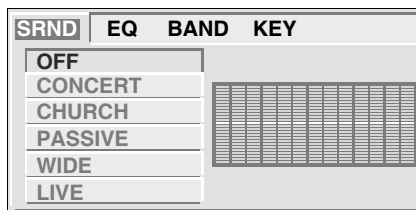

For EQ

- Press **Up** / **Down** to select an option and press **OK** to confirm.

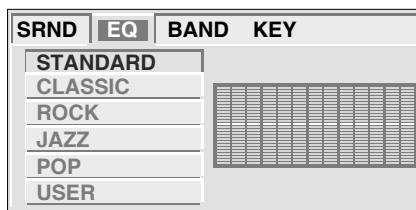

For BAND

- A frequency chart will be displayed as a musical file is played.

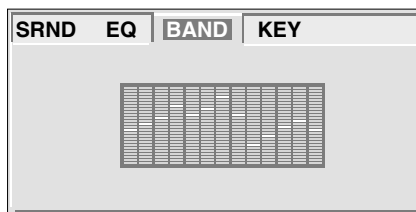

For KEY

- Press **Up** / **Down** to select an option and press **OK** to confirm.

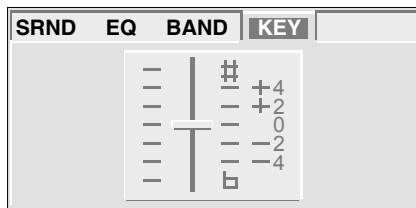

Searching Music During Playback

- 1 Press **Search** during playback. A search display appears on the top of the screen.

TRK 0002/11 00:02:06

- 2 Press to highlight Track Number or Time.
- 3 Press **Number Button(s)** to edit Track Number or Time.
- 4 Music will be played after editing according to the change of track or time.
- 5 To leave the search display, press **Search** again.

Programming Music Playback

- 1 Press **Program** during playback. A programming list appears on the screen.

| | | | |
|-------|-------|--------|--------|
| 1 --- | 5 --- | 9 --- | 13 --- |
| 2 --- | 6 --- | 10 --- | 14 --- |
| 3 --- | 7 --- | 11 --- | 15 --- |
| 4 --- | 8 --- | 12 --- | 16 --- |
| PLAY | | CLEAR | |

- 2 Press **Up** / **Down** **Left** / **Right** to highlight an item.

| | | | |
|-------|-------|--------|--------|
| 1 | 5 --- | 9 --- | 13 --- |
| 2 --- | 6 --- | 10 --- | 14 --- |
| 3 --- | 7 --- | 11 --- | 15 --- |
| 4 --- | 8 --- | 12 --- | 16 --- |
| PLAY | | CLEAR | |

- 3 Enter a preferred Track Number by pressing **Number Button(s)**.

| | | | |
|---------|-------|--------|--------|
| 1 0 2 6 | 5 --- | 9 --- | 13 --- |
| 2 --- | 6 --- | 10 --- | 14 --- |
| 3 --- | 7 --- | 11 --- | 15 --- |
| 4 --- | 8 --- | 12 --- | 16 --- |
| PLAY | | CLEAR | |

- 4 To play the programming list, press **Up** / **Down** **Left** / **Right** to highlight "PLAY" and then press **OK**.

| | | | |
|---------|---------|--------|--------|
| 1 0 2 6 | 5 0 1 2 | 9 --- | 13 --- |
| 2 1 4 5 | 6 0 0 5 | 10 --- | 14 --- |
| 3 0 9 7 | 7 --- | 11 --- | 15 --- |
| 4 3 1 1 | 8 --- | 12 --- | 16 --- |
| PLAY | | CLEAR | |

- 5 To clear the programming list, press **Up** / **Down** **Left** / **Right** to highlight "CLEAR" and then press **OK**.
- 6 To leave the programming list, press **Program** again.

2-3 Kodak and JPEG Picture CDs Operation



Preparations:

Please connect the Portable DVD Player to its source of power and connect it to external equipment if desired. If external equipment is connected:

Basic Playback

- 1 Press **Power** on the top panel of the player to turn on the unit.
- 2 Press **Eject** on the player's top panel to open the disc tray and place a Picture CD into the disc frame.
- 3 Close the tray. Playback of the disc starts automatically.

Playing a Kodak Picture CD

- 4 The slideshow begins in full screen mode.

Playing a JPEG Picture CD with a Title Menu

- 4 If the disc contains a title menu, the menu will be displayed on the screen.

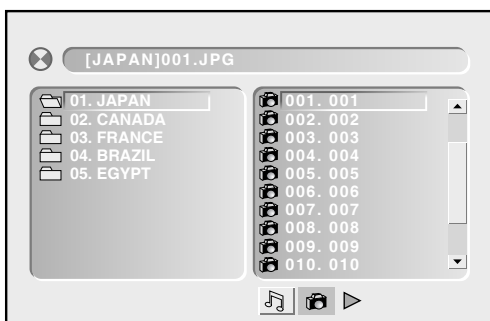

- 5 To select a file folder, press **Left** to enter the folder list on the left of the screen, press **Up** / **Down** to highlight a folder and then press **OK** or **Play**.

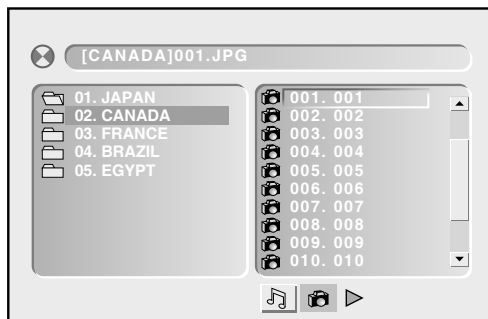

- 6 To review a picture file, press **Right** to enter the file list on the right of the screen, press **Up** / **Down** to highlight a file. Picture review is shown on the left of the screen.



- 7 To display the selected picture in full screen, press **OK**. To start the slideshow from the selected picture, press **Play**.
- 8 To return to the title menu from the slideshow, press **Return**.





Note:

- Some discs may contain both music and picture file formats. When the player reads the disc, music files will be played first. To select Picture CD mode, press **Play** until the Picture CD symbol is selected. Press **OK** or **Play**.



Stopping Playback

- 1 To stop the disc playback, press  **Stop**.



Pausing Playback

- 1 Press  **Pause** once to pause playback.
- 2 To return to normal playback, press  **Pause** again or  **Play**.

Rotating Pictures

- 1 Press  **Right** during playback to rotate the picture clockwise by 90° or press  **Left** to rotate the picture anti-clockwise by 90°.

Zooming Pictures

- 1 Press  **Zoom** a number of times during playback to watch the picture with different enlargements of **Zoom 2**, **Zoom 3**, **Zoom 4**, **Zoom 1/2**, **Zoom 1/3** and **Zoom 1/4**.
- 2 To return to normal playback, press  **Zoom** as required, until **ZOOM: [OFF]** appears.



Displaying Picture Information

- 1 Press **Info.**  during playback, and an information display appears on the top of the screen.



- 2 To stop displaying scene information, press **Info.**  again.

Skipping a Picture Ahead or Back

Skipping Ahead

- 1 Press  **Next** during playback.
Press  **Next**. The playback will start from the next picture. A picture is skipped each time the button is pressed.

Skipping Back

- 1 Press  **Prev.** during playback.
Press  **Prev.** The playback will start from the previous picture. A picture is skipped each time the button is pressed.

Repeating Playback

- 1 Press **Repeat**  during playback, a repeat information box appears on the screen.

LEFT REP AB RIGHT REP DISC

- 2 Press  **Right** repeatedly to select the following options:

REP: [REP 1] :Repeat Picture

REP: [REP DIR] : Repeat Directory (appears only when there are file directories saved in the CDs).

REP: [REP ALL] : Repeat Disc

REP: [OFF] : Repeat Off

Programming Picture in Title Menu

- 1 Press **Repeat**  during playback, a repeat information box appears on the screen.



| | | | |
|-------|-------|--------|--------|
| 1 --- | 5 --- | 9 --- | 13 --- |
| 2 --- | 6 --- | 10 --- | 14 --- |
| 3 --- | 7 --- | 11 --- | 15 --- |
| 4 --- | 8 --- | 12 --- | 16 --- |
| PLAY | | CLEAR | |

- 2** Press **Up** / **Down** / **Left** / **Right** to highlight an item.

| | | | |
|----------------|-------|--------|--------|
| 1 █ --- | 5 --- | 9 --- | 13 --- |
| 2 --- | 6 --- | 10 --- | 14 --- |
| 3 --- | 7 --- | 11 --- | 15 --- |
| 4 --- | 8 --- | 12 --- | 16 --- |
| PLAY | | CLEAR | |

- 3** Enter a preferred Track Number by pressing **Number Button(s)**.

| | | | |
|---------|-------|--------|--------|
| 1 0 2 6 | 5 --- | 9 --- | 13 --- |
| 2 --- | 6 --- | 10 --- | 14 --- |
| 3 --- | 7 --- | 11 --- | 15 --- |
| 4 --- | 8 --- | 12 --- | 16 --- |
| PLAY | | CLEAR | |

- 4** To play the programming list, press **Up** / **Down** / **Left** / **Right** to highlight "PLAY" and then press **OK**.

| | | | |
|---------|---------|--------|--------|
| 1 0 2 6 | 5 0 1 2 | 9 --- | 13 --- |
| 2 1 4 5 | 6 0 0 5 | 10 --- | 14 --- |
| 3 0 9 7 | 7 --- | 11 --- | 15 --- |
| 4 3 1 1 | 8 --- | 12 --- | 16 --- |
| PLAY | | CLEAR | |

- 5** To clear the programming list, press **Up** / **Down** / **Left** / **Right** to highlight "CLEAR" and then press **OK**.

- 6** To leave the programming list, press **PGM Program** again.

Changing Slideshow Display

- 1** Press **PGM Program** a number of times during playback to toggle through various slideshow selections.



The selections include: WIPE TOP, WIPE BOTTOM, WIPE LEFT, WIPE RIGHT, DIAGONAL WIPE LEFT TOP, DIAGONAL WIPE LEFT BOTTOM, DIAGONAL WIPE RIGHT TOP, DIAGONAL WIPE RIGHT BOTTOM, EXTEND FROM CENTER H, EXTEND FROM CENTER V, COMPRESS TO CENTER H, COMPRESS TO CENTER V, WINDOW H, WINDOW V, WIPE FROM EDGE TO CENTER, RANDOM and NONE.

3 Initial OSD Setting

Major OSD Settings

Press  **Setup** to enter SETUP MENU.



Press  **Up** /  **Down** to highlight an option and then press  **OK** to enter its setup menu.

OR

Press  **Left** /  **Right** to highlight an icon to enter its setup menu.

1 LANGUAGE SETUP



2 AUDIO SETUP





3 VIDEO SETUP



4 SYSTEM SETUP



To return to the main page, press  **Play** to highlight MAIN PAGE and press  **OK**.

OR

Press  **Up** and  **Left** /  **Right** to highlight MAIN PAGE icon.

To leave SETUP MENU, press  **Setup** or  **Return**.

3-1 Language Setup



OSD Language

(OSD means On Screen Display)

OSD Language is a function for setting an OSD Language according to the user's needs.

- 1 Press **Setup** to display the Setup Menu. Press **Left** / **Right** to highlight **LANGUAGE SETUP** icon.



- 2 Press **Down** to highlight **OSD LANGUAGE**.



- 3 Press **Right** and then **Up** / **Down** to highlight a preferred language. Press **OK**.



- To leave SETUP MENU, press **Setup**.

Audio Language

Audio Language is a function for selecting audio language outputs of DVD discs.

- 1 Press **Setup** to display the Setup Menu. Press **Left** / **Right** to highlight **LANGUAGE SETUP** icon.



- 2 Press **Down** to highlight **AUDIO LANGUAGE**.



- 3 Press **Right** and then **Up** / **Down** to highlight a preferred language. Press **OK**.



- To leave SETUP MENU, press **Setup**.

Subtitle Language

Subtitle Language is a function for selecting subtitle language outputs of DVD discs.

- 1 Press **Setup** to display the Setup Menu. Press **Left** / **Right** to highlight **LANGUAGE SETUP** icon.



- 2 Press **Down** to highlight **Subtitle LANGUAGE**.



- 3 Press **Right** and then **Up** / **Down** to highlight a preferred language. Press **OK**.

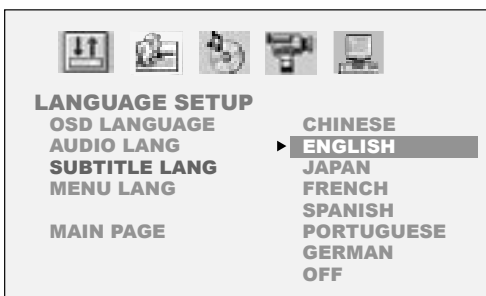

- To leave SETUP MENU, press **Setup**.

Menu Language

Menu Language is a function for selecting menu language displays of DVD discs.

- 1 Press **Setup** to display the Setup Menu. Press **Left** / **Right** to highlight **LANGUAGE SETUP** icon.



- 2 Press **Down** to highlight **Menu LANGUAGE**.



- 3 Press **Right** and then **Up** / **Down** to highlight a preferred language. Press **OK**.

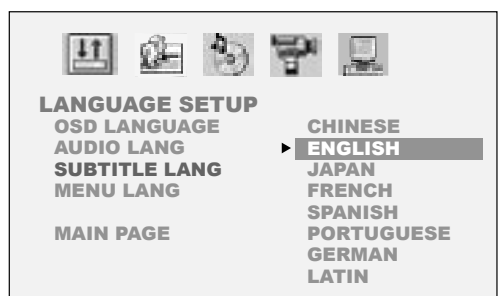

- To leave SETUP MENU, press **Setup**.



Digital Out

Digital Out is a function for selecting a proper audio output system to the applied amplifiers.

- 1 Press **Setup** to display the Setup Menu. Press **Left** / **Right** to highlight **AUDIO SETUP** icon.



- 2 Press **Down** to highlight **DIGITAL OUT**.

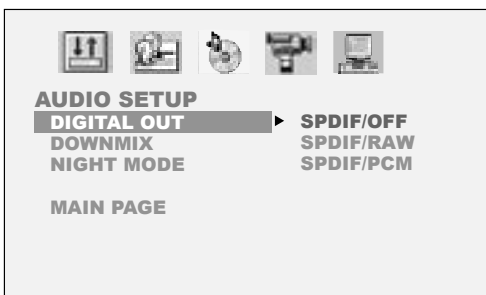

- 3 Press **Right** and then **Up** / **Down** to highlight a preferred option. Press **OK**.



- To leave SETUP MENU, press **Setup**.



Note:

- Select **RAW** when connecting the player's Digital Out (Coaxial) jack to a Dolby Digital decoder or an equipment with a Dolby Digital decoder.
- Select **PCM** when connecting the player's Digital Out (Coaxial) jack to a 2-channel digital stereo amplifier.

Downmix

Downmix is a function for mixing down to two channels when playing a DVD which has rear sound elements (channels) or is recorded in Dolby Digital format.

- 1 Press **Setup** to display the main Setup Menu. Press **Left** / **Right** to highlight **AUDIO SETUP** icon.



- 2 Press **Down** to highlight **DOWNMIX**.



- To leave SETUP MENU, press **Setup**.

- 3 Press **Right** and then **Up / Down** to highlight a preferred option. Press **OK**.



- To leave SETUP MENU, press **Setup**.



Note:

- If it's preferred to downmix multi-channel audio signals into two channels for use with your stereo, select **STEREO**.
- If it's preferred to send the multi-channel audio output signals to two channels to enjoy surround sound, select **VSS**.

Night Mode

The **Night Mode** function compresses the dynamic range of the audio output. See Note.

- 1 Press **Setup** to display the Setup Menu. Press **Left / Right** to highlight **AUDIO SETUP** icon.



- 2 Press **Down** to highlight **NIGHT MODE**.



- 3 Press **Right** and then **Up / Down** to highlight a preferred option. Press **OK**.



- To leave SETUP MENU, press **Setup**.



Note:

- With the DVD format, a program's soundtrack is an accurate and realistic audio presentation of the programs' content. However, in some cases, a compressed dynamic range of the audio output (the difference between the loudest sounds and the quietest sounds) might be desirable, for example, to view programs at night without disturbing other people. The **Night Mode** setting can help to achieve the effect.

3-3 Video Setup



Video Output

Video Output is a function for selecting a type of video output according to the output format.

- 1 Press **Setup** to display the main Setup Menu. Press **Left** / **Right** to highlight **VIDEO SETUP** icon.



- 2 Press **Down** to highlight **VIDEO OUTPUT**.

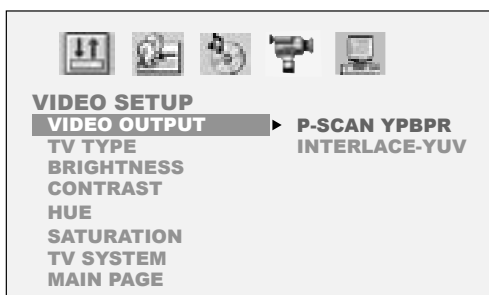

- 3 Press **Right** and then **Up** / **Down** to highlight a preferred option. Press **OK**.

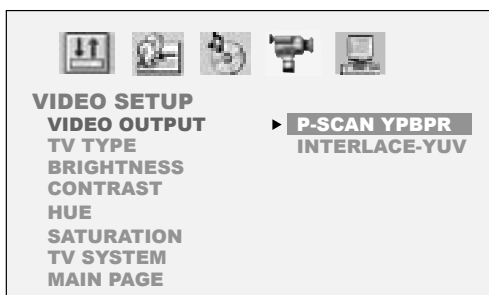

- To leave SETUP MENU, press **Setup**.



Note:

- Select **P-Scan YPbPr** when the PAL TV system is to be used.
- Select **INTERLACE-YUV** when NTSC TV system is to be used.

TV Aspect

TV Aspect provides the selection of either the (4:3) or (16:9) aspect ratio for viewing programs through the JD-TV108 or an external TV set.

- 1 Press **Setup** to display the main Setup Menu. Press **Left** / **Right** to highlight **VIDEO SETUP** icon.



- 2 Press **Down** to highlight **TV ASPECT**.

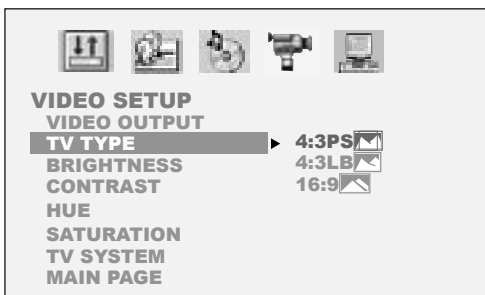

- 3 Press **Right** and then **Up** / **Down** to highlight a preferred option. Press **OK**.

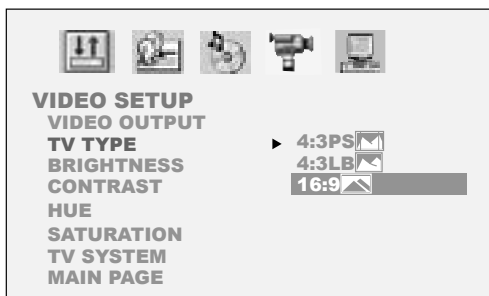

- To leave SETUP MENU, press **Setup**.

a 4:3 Pan Scan

Select "4:3 PanScan" for a conventional size TV set.

- Video material formatted in the pan & scan style is played in that style (the left and right edges are cut off).



b 4:3 Letter Box

Select "4:3 LetterBox" for a conventional size TV set. Black bands appear at top and bottom of screen (letter-box style).

- Video material not formatted in the pan & scan style is played in the letter-box style.

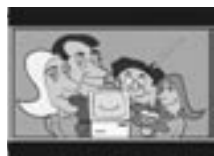

c 16:9 Wide

Select "16:9 Wide" for a wide-screen TV set to played in "FULL" size.

- Setting wide-screen TV to "FULL" mode is necessary.
- Each screen shows an example when the video material for a wide-screen is played.



Brightness

Brightness provides a function for adjusting the brightness of the player's LCD screen.

- 1 Press **Setup** to display the main Setup Menu. Press **Left** / **Right** to highlight **VIDEO SETUP** icon.



- 2 Press **Down** to highlight **BRIGHTNESS**.

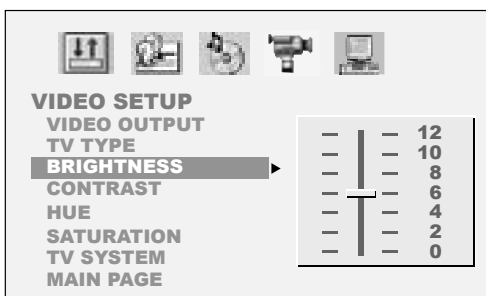

- 3 Press **Right** and then **Up** / **Down** to highlight a preferred brightness value.

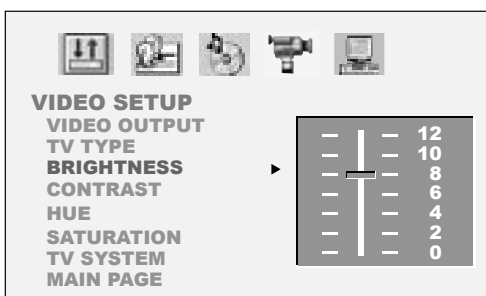

- To leave SETUP MENU, press **Setup**.



Contrast

Contrast provides a function for adjusting the color contrast of the player's LCD screen.

- 1 Press **Setup** to display the main Setup Menu. Press **Left** / **Right** to highlight **VIDEO SETUP** icon.



- 2 Press **Down** to highlight **CONTRAST**.

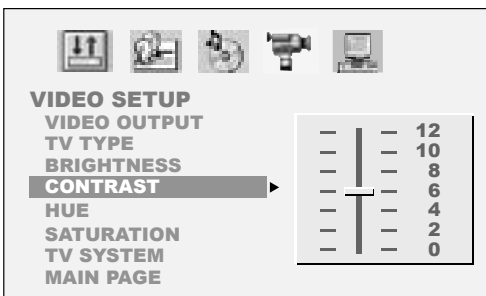

- 3 Press **Right** and then **Up** / **Down** to highlight a preferred contrast value.

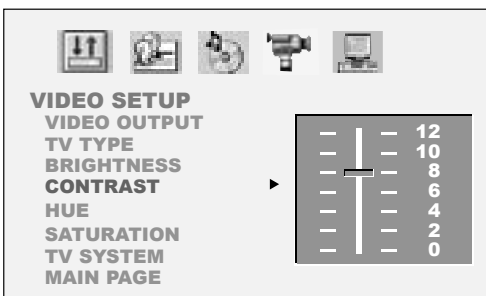

- To leave SETUP MENU, press **Setup**.

Hue

Hue provides a function for adjusting the color of the player's LCD screen.

- 1 Press **Setup** to display the main Setup Menu. Press **Left** / **Right** to highlight **VIDEO SETUP** icon.



- 2 Press **Down** to highlight **HUE**.

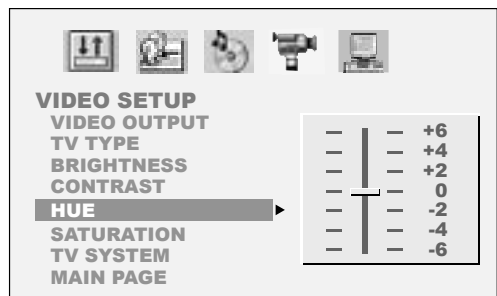

- 3 Press **Right** and then **Up** / **Down** to highlight a preferred hue value.

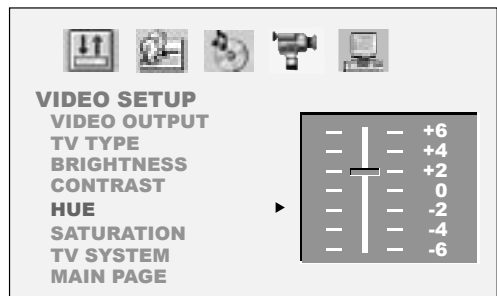

- To leave SETUP MENU, press **Setup**.

Saturation

Saturation provides a function for adjusting the saturation of the player's LCD screen.

- 1 Press **Setup** to display the main Setup Menu. Press **Left** / **Right** to highlight **VIDEO SETUP** icon.



- 2 Press **Down** to highlight **SATURATION**.

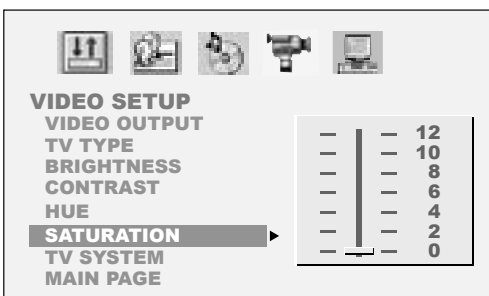

- 3 Press **Right** and then **Up** / **Down** to highlight a preferred saturation value.

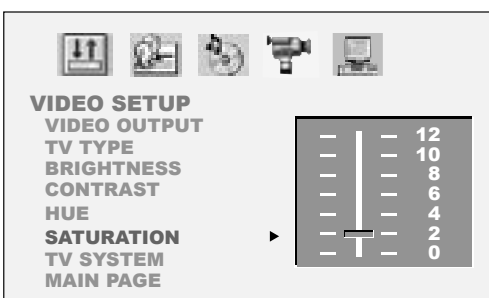

- To leave SETUP MENU, press **Setup**.

TV System

TV System is a function for setting the "TV SYSTEM" from the on-screen display to the format that is compatible with your TV's system when connecting the DVD player to your TV. Set to "AUTO" if your system is a multi-TV system that supports both PAL and NTSC.

- 1 Press **Setup** to display the main Setup Menu. Press **Left** / **Right** to highlight **VIDEO SETUP** icon.

- 2 Press **Down** to highlight **TV SYSTEM**.

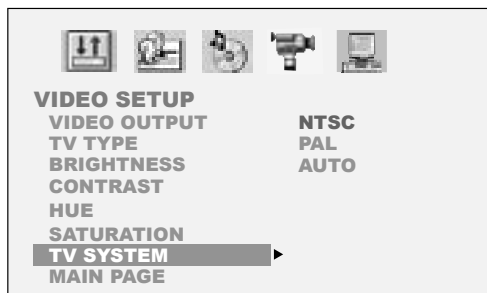

- 3 Press **Right** and then **Up** / **Down** to highlight a preferred option. Press **OK**.



Note:

- The following message will be shown on the screen while PAL is selected: *CHANGING TO PAL WILL CAUSE THE SCREEN OF THIS UNIT TO LACK COLOR. SELECT 'OK' TO CONFIRM. SELECT 'NO' TO CANCEL.*

- To leave SETUP MENU, press **Setup**.



Screen Saver

The **Screen Saver** will function only when the player is ON and stopped.

- 1 Press **Setup** to display the main Setup Menu. Press **Left** / **Right** to highlight **SYSTEM SETUP** icon.



- 2 Press **Down** to highlight **SCREEN SAVER**.

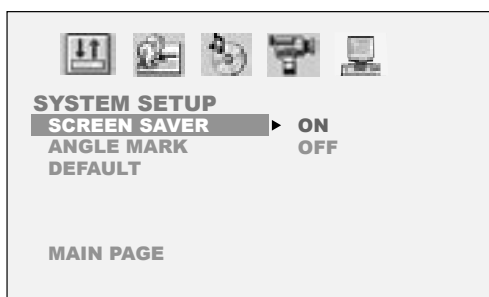

- 3 Press **Right** and then **Up** / **Down** to highlight a preferred option. Press **OK**.

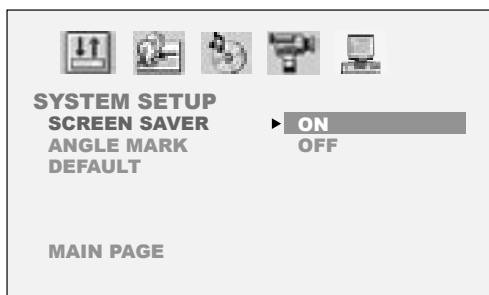

- To leave SETUP MENU, press **Setup**.

Angle Mark

Angle Mark is a function for displaying or hiding the angle mark on the screen.

- 1 Press **Setup** to display the main Setup Menu. Press **Left** / **Right** to highlight **SYSTEM SETUP** icon.



- 2 Press **Down** to highlight **ANGLE MARK**.



- 3 Press **Right** and then **Up** / **Down** to highlight a preferred option. Press **OK**.



- To leave SETUP MENU, press **Setup**.



3-4 System Setup - continued



Note:

- This operation works only with discs on which multiple viewing angles are recorded.
- Pressing the **Angle** button will change camera angles for movies that support this feature regardless of whether the ANGLE MARK feature is "On" or "Off".

Default

Default is a function for restoring the player to the default setting.

- 1 Press **Setup** to display the main Setup Menu. Press **Left** / **Right** to highlight **SYSTEM SETUP** icon.



- 2 Press **Down** to highlight **DEFAULT**.



- 3 Press **Right** and then **OK**.



- To leave SETUP MENU, press **Setup**.



Panel Setting

The player provides five options for panel adjustments, including “Normal”, “16:9”, “4:3”, “Zoom”, or “Close”.

- 1 Press **LCD**. The LCD setting box appears on the screen.



- 2 Press **Right** to enter Panel Setting when **Panel** is highlighted.



- 3 Press **Up** / **Down** to highlight a preferred option.

- 4 To return to the LCD setting box, press **Left**. To leave the LCD setting box, press **LCD**.



Note:

- When “Zoom” is selected, the up and down edges will be cut off.
- When “Close” is selected, the LCD will be turned off. To turn on the LCD, press **LCD**.

Invert Setting

This option provides the function for inverting the LCD screen.

- 1 Press **LCD**, the LCD setting box appears on the screen.

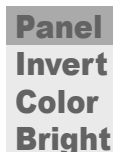

- 2 Press **Down** to highlight **Invert**.

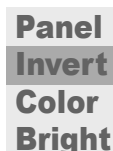

- 3 Press **Right** to enter Invert Setting

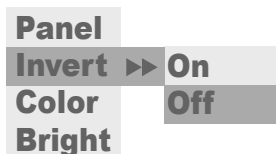

- 4 To invert the LCD screen, press **Up** / **Down** to highlight “On”.

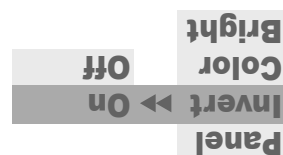

- 5 To return to the LCD setting box, press **Left**. To leave the LCD setting box, press **LCD**.



4-1 LCD Setup - continued

Color Setting

You can adjust the color of video with this setting to a soothing view for your eyes.

- 1 Press **LCD**. The LCD setting box appears on the screen.

Panel
Invert
Color
Bright

- 2 Press **Down** to highlight **Color**.

Panel
Invert
Color
Bright

- 3 Press **Right** to enter Color Setting.

| | |
|----------|----|
| Panel | +3 |
| Invert | +2 |
| Invert | +1 |
| Color >> | 0 |
| Bright | -1 |
| | -2 |
| | -3 |

- 4 To adjust color, press **Up** / **Down** to highlight a preferred value.

- 5 To return to the LCD setting box, press **Left**. To leave the LCD setting box, press **LCD**.

Bright Setting

You can increase or decrease the brightness of video.

- 1 Press **LCD**, the LCD setting box appears on the screen.

Panel
Invert
Color
Bright

- 2 Press **Down** to highlight **Color**.

Panel
Invert
Color
Bright

- 3 Press **Right** to enter Bright Setting.

| | |
|-----------|----|
| Panel | +3 |
| Invert | +2 |
| Color | +1 |
| Bright >> | 0 |
| | -1 |
| | -2 |
| | -3 |

- 4 To adjust brightness, press **Up** / **Down** to highlight a preferred value.

- 5 To return to the LCD setting box, press **Left**. To leave the LCD setting box, press **LCD**.



Before requesting service for the DVD Player, check the chart below for a possible cause of the problem you are experiencing. Some simple checkups or a minor adjustment on your part may eliminate the problem and restore proper operation.

| SYMPTOM (COMMON) | REMEDY |
|---|---|
| No power. | <ul style="list-style-type: none"> • Insert the power plug securely into the power outlet. • Check if the ON/OFF button on the front of the recorder is set to on. • Check if no power at the AC outlet by plugging in another appliance for a test. |
| The recorder does not start playback when PLAY is pressed. | <ul style="list-style-type: none"> • Condensation has formed; wait about 1 to 2 hours to allow the recorder to dry out. • The recorder cannot play discs other than DVDs and audio CDs. • Check if the disc is defective by trying another disc. • Check the region (local) code. |
| The recorder starts playback but stops immediately. | <ul style="list-style-type: none"> • The disc may be dirty and may require cleaning. • Ensure that the disc is installed with the label side up. |
| No picture. | <ul style="list-style-type: none"> • Ensure that the equipment is connected properly. • Ensure that the input setting for the TV is "Video". • Check if the TV is on. • Select the same channel and source on the TV as on the recorder. |
| No sound. | <ul style="list-style-type: none"> • Ensure that the equipment is connected properly. • If using a HiFi amplifier, try another sound source. • Check the Audio Output Setting menu to make sure that Analog Output is selected. |
| Distorted sound. | <ul style="list-style-type: none"> • Ensure that the input settings for the TV and stereo system are proper. • No sound is heard during still picture (pause) or slow-motion playback. |
| No audio at the Digital Output. | <ul style="list-style-type: none"> • Check the digital connections. • Check the settings menu to make sure that the digital output is set to on. • Check if the audio format of the selected audio language matches your receiver capabilities. |
| Distorted picture. | <ul style="list-style-type: none"> • Check the disc for fingerprints and clean with a soft cloth, wiping from center to edge. • Sometimes a small amount of picture distortion may appear. This is not a malfunction. |
| Completely distorted picture or no color in picture. | <ul style="list-style-type: none"> • The disc format is not according to the TV-set used (PAL/NTSC). |
| Picture is distorted during rapid advance or rapid reverse. | <ul style="list-style-type: none"> • The picture will be somewhat distorted at times: this is normal. |
| No rapid advance (or rapid reverse) playback. | <ul style="list-style-type: none"> • Some discs may have sections which prohibit rapid advance (or rapid reverse). |
| No 4:3 (16:9) picture. | <ul style="list-style-type: none"> • Choose the correct setup "Aspect Ratio" item which matches the TV set used. |
| No operations perform with the remote control. | <ul style="list-style-type: none"> • Check the batteries are installed with the correct polarities (+ and -). • The batteries are depleted: replace them with new ones. • Point the remote control unit at the remote control signal sensor and operate. • Operate the remote control unit at a distance of not more than 7 meters from the remote control signal sensor. • Remove the obstacles between the remote control unit and remote control signal sensor. |



5-1 Troubleshooting - continued

| SYMPTOM (COMMON) | REMEDY |
|---|---|
| Audio soundtrack and/or subtitle language is not the one selected at the initial settings. No subtitles. | <ul style="list-style-type: none">• If the audio soundtrack and/or subtitle language does not exist on the disc, the language selected at the initial settings will not be seen/heard.• Subtitles appear only with discs that contain them.• Subtitles are hidden from the TV screen. Press SUBTITLE to display the subtitles. |
| Alternative audio soundtrack (or subtitle) language available. Angle cannot change. | <ul style="list-style-type: none">• If an alternative language can not be selected, it may be because there are no other languages available.• This function depends on software availability. Even if a disc has a number of angles recorded, these angles may be recorded for specific scenes only. |
| No sound when connecting to 5.1 channel speakers | <ul style="list-style-type: none">• Check if the disc supports 5.1 channel sound.• Check if the speaker is properly connected.• Check if the audio output setting is correct. |
| No key operation (by the DVD Recorder and/or the remote control) is effective. | <ul style="list-style-type: none">• Turn the unit off and then back to on. Alternatively, turn off the unit, disconnect the AC power cord and then re-connect it. (The recorder may not be operating properly due to lightning, static electricity or some other external factor.) |
| No picture and sound (for recorded disc) | <ul style="list-style-type: none">• Check if the DVD Player and external equipment are properly connected.• Check if the scheduled recording setting is correct.• Check if the correct recordable disc is being used. (DVD+RW/DVD+R)• Check if power set to stand-by mode while using schedule recording.• Check if the disc has been closed. (only for DVD+R disc) |
| Distorted picture or no image | <ul style="list-style-type: none">• Check if the TV system settings are correct.• Check if the output format is in "Progressive Scan". If so, you have to set "Component" in the video output setting. The actual output format must match the output format setting. |
| OSD setting doesn't get executed | <ul style="list-style-type: none">• Some settings must be stored by pressing left button. Re-check it. |



Handling Precautions

- Hold the disc by the edges so the surface will not be soiled with fingerprints. (A)
Fingerprints, dirt and scratches can cause skipping and distortion.
- Do not write on the label side with a ball-point pen or other writing utensils.
- Do not use record cleaning sprays, benzene, thinner, static electricity prevention liquids or any other solvent.
- Be careful not to drop or bend the disc.
- Do not install more than 1 disc on the disc tray.
- Do not try to close the disc tray when the disc is not installed properly.
- Be sure to store the disc in its exclusive case when not in use.

If the surface is soiled (B)

Wipe gently with a soft, damp (water only) cloth.

When wiping discs, always move the cloth from the center hole toward the outer edge.

(If you wipe the discs using a circular motion, circular scratches are likely to occur, which will cause noise.)

If the disc is brought from a cold to a warm environment, moisture may form on the disc

Wipe the moisture off with a soft, dry, lint-free cloth before using the disc.

Improper disc storage

You can damage discs if you store them in the following places:

- Areas exposed to direct sunlight
- Humid or dusty areas
- Areas directly exposed to a heat outlet or heating appliance

Playable disc format

- MPEG4, DVD, DVD+RW, DVD+R, DVD-RW, DVD-R, CD-DA, Mixed CD-DA, JPEG file disc and Kodak Picture Disc.

Disc which cannot be played with this player

- CD-ROM
- CVD
- CD-G

Maintenance

- Be sure to turn the unit off and disconnect the AC power cord before maintaining the unit.
- Wipe this unit with a dry soft cloth.
If the surfaces are extremely dirty, wipe clean with a cloth which has been dipped in a weak soap-and-water solution and wrung out thoroughly, and then wipe again with a dry cloth.
- Never use alcohol, benzene, thinner, cleaning fluid or other chemicals. Do not use compressed air to remove dust.

(A)



(B)



KITCHEN DVD PLAYER

Free Manuals Download Website

<http://myh66.com>

<http://usermanuals.us>

<http://www.somanuals.com>

<http://www.4manuals.cc>

<http://www.manual-lib.com>

<http://www.404manual.com>

<http://www.luxmanual.com>

<http://aubethermostatmanual.com>

Golf course search by state

<http://golfingnear.com>

Email search by domain

<http://emailbydomain.com>

Auto manuals search

<http://auto.somanuals.com>

TV manuals search

<http://tv.somanuals.com>