

KAIDAN

KiWi™ 2000/2020 User's Guide



Photographic VR Panoramic Tripod Head

*Designed expressly for the Olympus C-2000
and the C-2020 Digital Cameras*

Copyright Information

Copyright © 2000 Kaidan, Inc. All Rights Reserved. First Edition, September 2000. KiWi is a trademark of Kaidan, Inc. Other products mentioned herein may be trademarks of their respective companies. Patents Pending.

Information in this manual is subject to change without notice and does not represent a commitment on the part of Kaidan. No part of this manual may be reproduced or transmitted in any form or by any means, electronic or mechanical, including photocopying, recording, or information storage and retrieval systems, or translated to another language, for any purpose other than the licensee's personal use and as specifically allowed in the licensing agreement, without the express written permission of Kaidan.

Kaidan Warranty and Return Policy

A • Limited Warranty

In the event of a defect in materials or workmanship, Kaidan will repair the product with new or rebuilt parts for a period of three-hundred and sixty five (365) days from the date of original purchase. Such work will be performed free of charge. Follow the Product Return Procedure (Section D following).

Likewise, any software purchased from Kaidan also comes with a one year warranty if your disc or media is defective or damaged. This warranty is extended only to the original purchaser and is not transferable. A purchase receipt or other proof of original purchase will be required before warranty performance is rendered.

This warranty only covers failures due to defects in materials or workmanship which occur during normal use. It does not cover damages or failures which are caused from accident, misuse, abuse, neglect, mishandling, misapplication, alteration, faulty installation, modification, service by anyone other than an authorized representative of Kaidan, Acts of God, or by products not supplied by Kaidan.

This warranty covers any damage incurred during original shipment of product to customer. Any item resold, or distributed by, and not explicitly manufactured by Kaidan will be covered by their respective company's product warranty.

B • Warranty Exclusions

There are no express warranties except as listed above.

Kaidan shall not be liable for special, incidental, consequential or punitive damages, including, without limitation, loss of goodwill, profits or revenue, loss of the use of this product or any associated equipment, cost of substitute equipment, downtime costs, or claims of any party dealing with buyer for such damages, resulting from use of this product or arising from breach of warranty or contract, negligence, or any other legal theory.

All express and implied warranties, including the warranties of merchantability and fitness for a particular purpose, are limited to the applicable warranty period set forth above. Some states do not allow the exclusion or limitation of consequential damages, or limitations on how long an implied warranty lasts, so the above exclusions or limitations may not apply to you.

This warranty and any claims which arise with the Kaidan product(s) are governed by the laws of the state of Pennsylvania. By purchasing this product, customer acknowledges and agrees to these Limits and Exclusions. If a problem with your Kaidan product develops during the warranty period, immediately contact Kaidan for assistance.

C • Product Return Policy

All Kaidan products come with a 30-day return policy (a minimum 10 percent re-stocking fees will apply) from date of purchase, with the exception of software or videotapes.

Both of the aforementioned items are copyrighted and subject to the laws concerning intellectual property. Kaidan will replace defective software/videotapes free of charge upon return receipt of defective item(s). Products returned under this policy, excluding replacement of defective items, must be shipped at purchaser's expense. Purchaser must ship product with an approved traceable service, such as FedEx, and with appropriate levels of shipping insurance for the item being returned. Kaidan will not be held responsible for returned items lost or damaged in transit.

Kaidan will issue a refund to customer's account if the following conditions are satisfied:

1) Receipt of item(s) in a restockable condition.

Criteria for Restockable Condition is as follows:

- All parts are included in box; hardware, manuals, discs, nuts/bolts, tools.
- No signs of damage; scratches, bent parts, missing pieces, markings, alterations, or additions to the product.
- All packaging materials are intact; foam, peanuts, cardboard, bubble bags.
- No signs of excess usage or wear to the product.

Items of Non-restockable condition are subject to the following:

- Restocking Fee/s - a minimum of 10 percent and possible additional fees based on the condition of the product (how the product best meets the criteria

above), at Kaidan's discretion.

Non-Restockable Condition - constitutes the following:

- Missing parts; hardware, manuals, discs, nuts/bolts, tools, and packaging materials; foam, peanuts, cardboard, bubble bags.
- Signs of damage; scratches, bent parts, missing pieces, markings, alterations, additions to the product.
- Signs of excess usage or wear to the product.
- Damage or loss incurred during uninsured shipping to Kaidan. In this case, Kaidan cannot issue any type of refund. Customer will be responsible to submit claim with their shipping company.
- If damages occur in shipping, customer must submit claim with shipping company prior to any action by Kaidan.

Items Part of Special Bundle

If item(s) are part of a special bundle offer, return of part of the bundle will void any special pricing and the item(s) remaining in the possession of the customer will revert to their regular Suggested Retail Price (SRP). The credit, to customer, will reflect the difference of the actual product SRP from the amount of credit due customer.

Shipping Costs

All shipping costs, VAT, duties and return costs are sole responsibility of customer. If customer purchases thru Kaidan distributor or reseller, customer is responsible for all shipping and VAT costs incurred by that distributor or reseller. These charges are non-refundable.

For instructions on the return of your product, follow the Product Return Procedure below

D • Product Return Procedure

When returning a product, customer must first contact Kaidan (or the distributor/reseller) and obtain a Return Material Authorization Number (RMA#). After receiving the RMA#, customer will be instructed to return product directly to Kaidan. Returned goods must be shipped with an approved traceable service, such as FedEx, and with appropriate levels of shipping insurance for the item being returned. Kaidan will not be held responsible for returned items lost or damaged in transit. RMA numbers are valid for 15 days, and the product(s) must be received by Kaidan before the RMA expires. We are unable to accept for return any product(s) received after the expiration of the RMA.

Return Packaging

The product packaging must reflect customer name, address, RMA# as well as Kaidan information:

Kaidan Incorporated
703 E. Pennsylvania Blvd • Feasterville, PA 19053 • U.S.A.
Attention: Return Department per RMA# _____

Contact Information: Voice: 215-364-1778 • Fax: 215-322-4186
http://www.kaidan.com • E-mail: info@kaidan.com

1

Setting Up Your KiWi 2000/2020™

Warranty Registration

Please take a brief moment and fill out the warranty registration card included with your package. Please print clearly in capital letters and remember to affix postage. You can also register after filling out the card by faxing it to **215-322-4186** or register on-line at: <http://www.kaidan.com/register.html>.

UNPACKING THE BOX

The KiWi 2000/2020 is shipped in a single box and consists of the components detailed below. Please make sure that all parts are included. Examine the parts for any signs of shipping damage. In the event of shipping damage, immediately contact Kaidan to process claims. If any item is missing or you notice any damage, call Kaidan at 215-364-1778 between the hours of 9:00 AM and 6:00 PM EST, Mon-Fri.

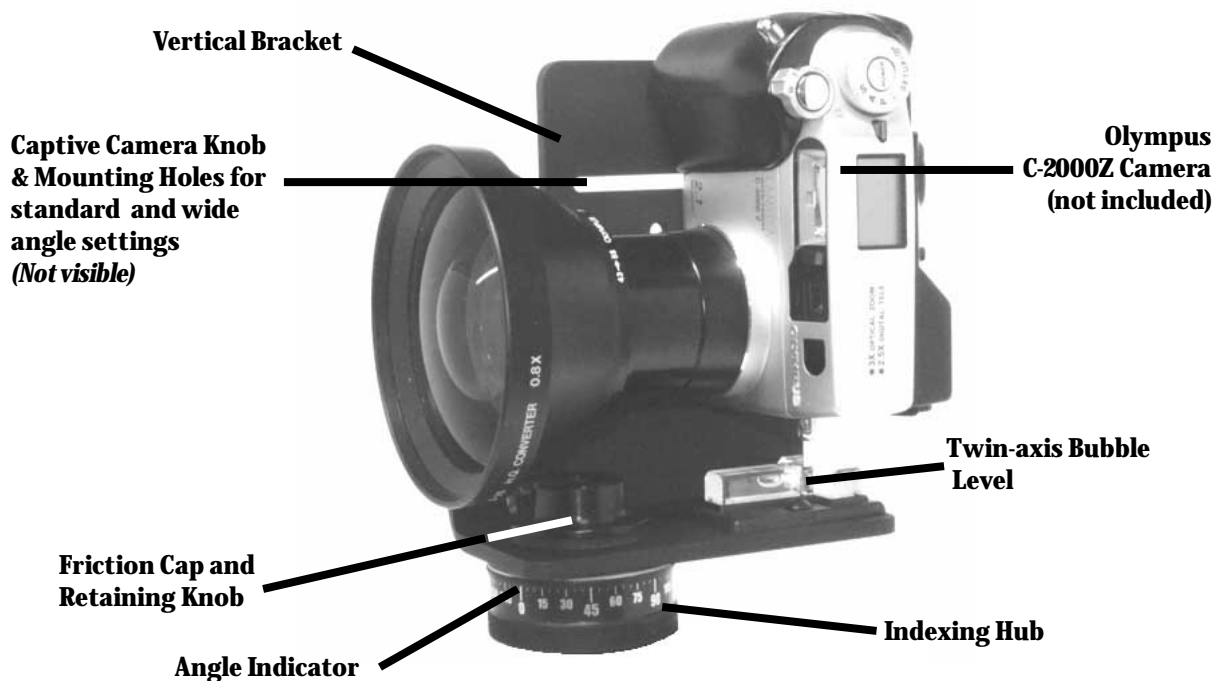

The KiWi 2000 also comes with two detent discs (14 and 18 positions, not shown) and a Camera Adjustment Shoe (attached to the Vertical Bracket).

REMOVING THE FRICTION CAP

The Friction Cap needs to be removed in order to change detent discs. The discs provide the means for establishing and changing the number and spacing of the angular increments of the tripod head. The two discs that come standard with the KiWi 2000/2020 provide for 14 and 18 shots per revolution. Use the 18 position detent disc when capturing images with the normal wide-angle setting of the camera. Use the 14 position detent disc when using the optional Olympus Wide Conversion Lens WCON-08 for the Olympus C-2000Z and C-2020Z camera.

To remove the Friction Cap, loosen the silver colored Retaining Knob which is located on the side of the Friction Cap. It does not have to be removed from the Cap, but only backed out far enough to allow the Cap to be unscrewed from the axle. You can look into the opening in the center of the cap to see when the Retaining Knob is clear of the hexagonal-shaped axle. Rotate the cap counterclockwise and remove it from the unit.

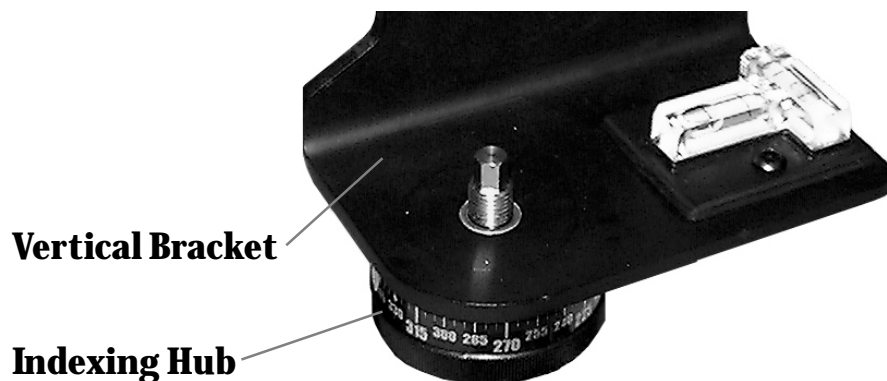
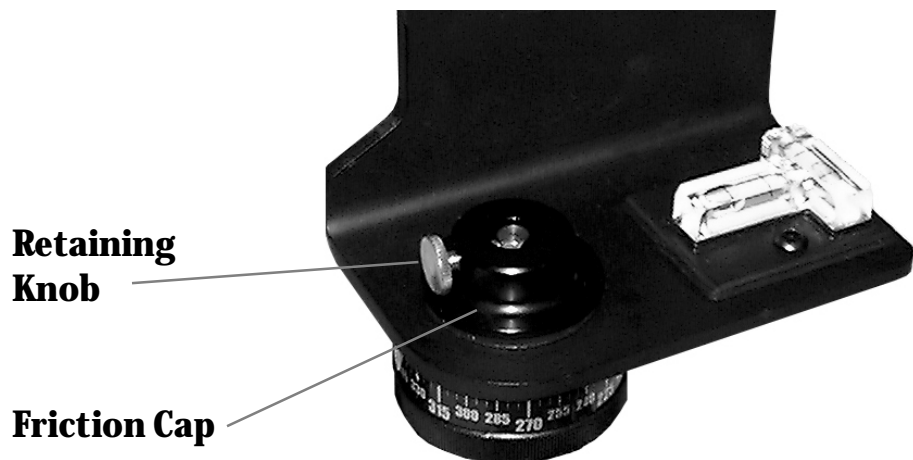

Once the Friction Cap has been removed, separate the Vertical Bracket from the Indexing Hub. You might need to wiggle the pieces as you pull them apart.

REMOVING & REPLACING THE DETENT DISC

Once the Indexing Hub is removed, the detent disc can be removed from its recess in the bottom of the Vertical Bracket. The disc may slip out once the Indexing Hub is removed. If it sticks inside the recess, simply insert the tip of a ballpoint pen or a pin small enough to fit into the detent disc ejection hole on the top of the bracket and push the detent disc out of the detent disc recess.

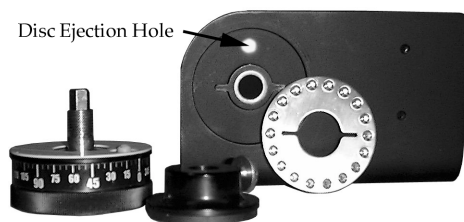

With the disc removed, a different disc can be inserted to change the angular spacing. The 14 position detent disc (included with your bracket) is for use with the optional Olympus Wide Conversion Lens WCON-08.

To install a different disc, simply align the keyed slot and push the disc into the recess. Make sure the disc is properly seated and flush to the bottom surface of the Vertical Bracket. With the new disc inserted, reassemble by inserting the Indexing Hub back through the bearing in the Vertical Bracket.

REPLACING THE FRICTION CAP

Replace the Friction Cap by threading the Cap back onto the axle. Continue to thread the cap so that there is no free play between the Vertical Bracket and the Indexing Hub. The rubber washer on the bottom of the Friction Cap should be slightly compressed. When the drag feels adequate, turn the Friction Cap so that the threaded shaft of the Retaining Knob is aligned with the closest flat on the axle. Tighten the Retaining Knob to lock the Cap in place.

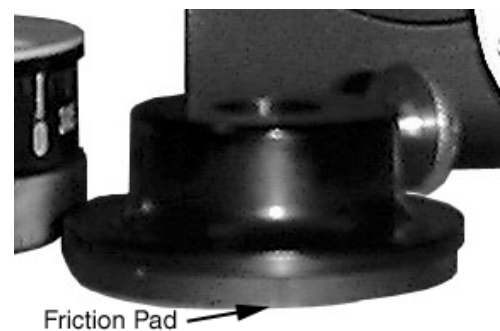

ADJUSTING THE DETENT FORCE

The spring plunger that provides the detent action can also be adjusted to vary the force. Use a flat blade screw driver to move the plunger in and out as desired. A convenient way to adjust the plunger is to screw the plunger all the way in until it gently bottoms out. Then unscrew the plunger about one complete turn.



2

Shooting Panoramas

HOW MANY SHOTS?

The KiWi 2000/2020 is designed to be used with:

- The normal wide-angle setting of the camera lens
- The optional Olympus Wide Conversion Lens WCON-08 (screw on)
- Other third party lenses usable with the Olympus C-2000Z and C-2020Z camera

The normal wide-angle setting of the camera will require the 18 position detent disc. The Olympus Wide Conversion Lens WCON-08 requires the use of the 14 position detent disc.

MOUNTING THE CAMERA?

The KiWi 2000/2020 also comes with a Camera Adjustment Shoe to help keep your camera mounted vertically. It also makes it easy to remove and replace your camera in the same position. Before the camera is attached, loosen the knob on the Camera Adjustment Shoe. Once the knob is loosened, the shoe can slide forward or backwards to help position the camera. You may need to remove the shoe and reposition it against either the front or the back of the camera, depending which configuration is selected.

**Camera
Adjustment Shoe
(Knob is on the
other side)**

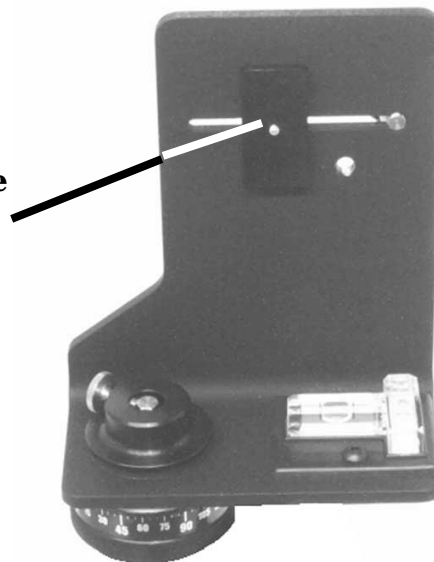

MOUNTING THE CAMERA? (CONTINUED)

The KiWi 2000/2020 is designed to be used with either the standard wide-angle camera setting or with the add-on Olympus Wide Conversion Lens WCON-08. The two threaded mounting holes below the slot on the Camera Bracket will position the camera at its proper nodal point setting for either configuration. The diagram below shows the proper mounting holes for the camera.

Note: The slot above the camera mounting holes will accept the Camera Knob and can be used to locate the camera in accordance with the nodal points of other 3rd party lenses (see Chapter 3 for instructions).

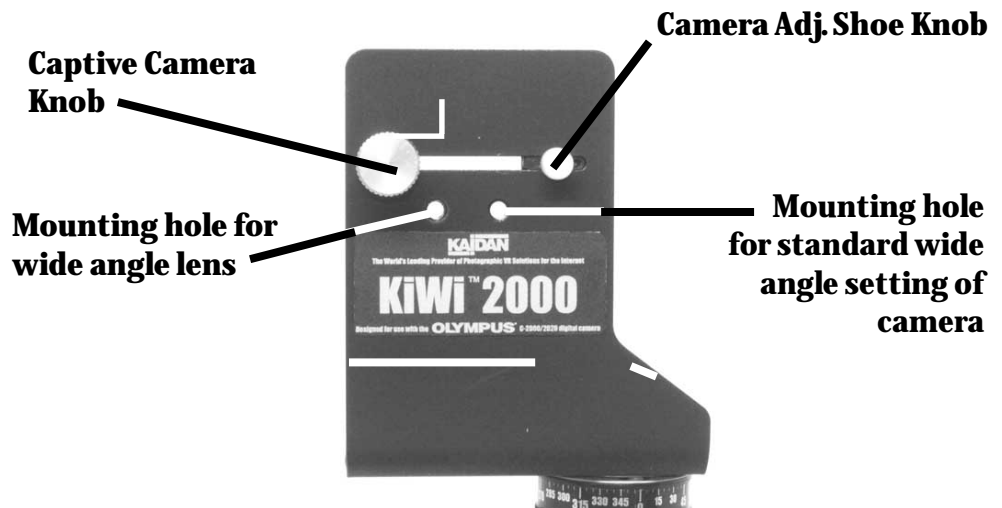

TAKING THE PHOTO

The KiWi 2000/2020 has a female 1/4-20 thread on the bottom of the Indexing Hub for mounting to most standard tripods. When ready to shoot, make sure that the KiWi 2000/2020 is securely attached to the tripod. Use a tripod that is sturdy, ideally one that has a center support system of braces to help keep the camera and KiWi 2000/2020 from excessive flexing. It may be possible that your tripod uses a larger 3/8 inch thread. If this is the case, you can purchase a 3/8 to 1/4 adapter at a camera store or photographer equipment supplier.

When ready to shoot, it is important that the unit is level. Observe the twin-axis bubble level on the KiWi 2000/2020 while leveling the tripod. Of course, this task is much easier if the tripod is equipped with a tilt head. If the tripod does not have a tilt head, a QuickTilt™ leveler can be purchased from Kaidan for use with the KiWi 2000/2020. Once the KiWi 2000/2020 is level, double check to see if the camera is mounted level in elevation. Use the Camera Adjustment Shoe and place it against the camera. By placing the shoe snugly against the camera, it will help to vertically align and position the camera.

You are now ready to begin capturing your first panorama. You should also, at this time, review the documentation of the panoramic stitching software that is being used in order to get recommendations for exposure settings and other camera settings.

TAKING THE PHOTOS

The KiWi 2000/2020 has a female 1/4-20 thread on the bottom of the Indexing Hub for mounting to most standard tripods. When ready to shoot, make sure that the KiWi 2000/2020 is securely attached to the tripod. Use a tripod that is sturdy, ideally one that has a center support system of braces to help keep the camera and KiWi 2000/2020 from excessive flexing.

It may be possible that your tripod uses a larger 3/8 inch thread. If this is the case, you can purchase a 3/8 to 1/4 adapter at a camera store or photographer equipment supplier.

When ready to shoot, it is important that the unit is level. Observe the twin-axis bubble level on the KiWi 2000/2020 while leveling the tripod. Of course, this task is much easier if the tripod is equipped with a tilt head. If the tripod does not have a tilt head, a QuickTilt™ leveler can be purchased from Kaidan for use with the KiWi 2000/2020.

Once the KiWi 2000/2020 is level, double check to see if the camera is mounted level in elevation. Use the Camera Adjustment Shoe and place it against the camera. By placing the shoe snugly against the camera, it will help to vertically align and position the camera.

You're now ready to begin capturing your first panorama. You should also, at this time review the documentation of the panoramic stitching software that is being used in order to get recommendations for exposure settings and other camera settings.

3

Finding the Nodal Point When using 3rd Party Lenses

HOW DO I LOCATE MY CAMERA'S NODAL POINT?

Follow these steps and you will be able to easily locate the nodal point for any camera and lens combination.

Simply put, the nodal point is the point inside your camera where the light rays converge and flip over. When shooting an immersive panorama, it is necessary to rotate about this point to eliminate the image mismatch caused by parallax error.

Parallax error can be easily demonstrated by this simple experiment. Close one eye and hold your index finger upright about six inches away from your open eye. Rock your head from side to side. Notice how your finger moves with respect to the background. This relative movement is due to the fact that you are not rotating your head around your eye's nodal point, which is somewhere in the center of your eyeball. Instead, you're rotating about your spine which is several inches to the rear and off to one side. It is this relative side-to-side motion that we will strive to eliminate when setting up a camera for VR panoramas.

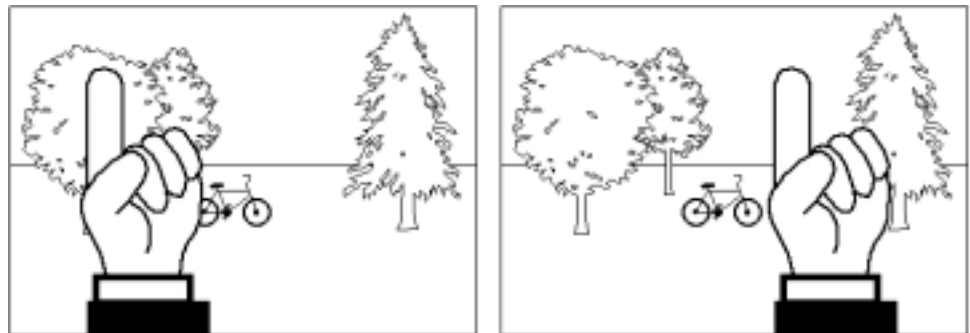

STEP 1: THE EASY PART - THE SIDE-TO-SIDE ADJUSTMENT

Once the camera is fastened to the KiWi 2000 /2020Pan Head, the center of the lens will be directly over the pivot axis. No side-to-side adjustment will be needed.

STEP 2 THE SLIGHTLY HARDER PART - FORE-AFT ADJUSTMENT

Put the Captive Camera Knob in the long slot of the Vertical Bracket. This will allow you to slide the camera (along with the Camera Adjustment Shoe) as required. Note: This step is most easily accomplished outside. Find a vertical edge or line, such as a doorway or edge of a building. Position the unit and tripod about four feet away, or as close as possible with the edge still in focus when looking through the view displayed on the LCD screen of the camera.

Looking at the camera's LCD, find another vertical edge or object that is far away, such as another building or telephone pole. Align the two objects and rotate the Vertical Bracket so they are in the left hand side of the viewfinder.

Rotate the pan head so the two objects move over to the right hand side of the viewfinder. Unless you've managed to unwittingly locate the right nodal point position, you should notice the two objects will move with respect to each other as the Vertical Bracket is rotated from left to right. Slide the camera to the front or rear as required to eliminate this relative movement.

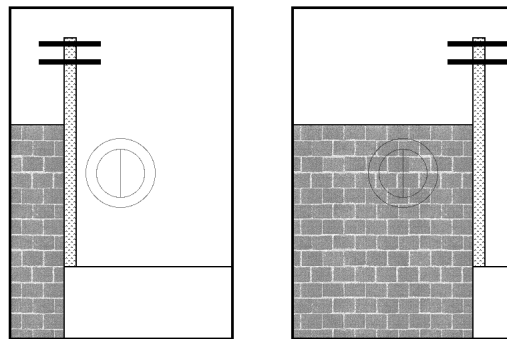

Good.
No relative movement
between object when
rotating camera from
side to side.

Looking through the viewfinder, align a close object (brick wall) with a faraway object (telephone pole). As the camera is rotated from side-to-side, there should be no relative movement between the two objects.

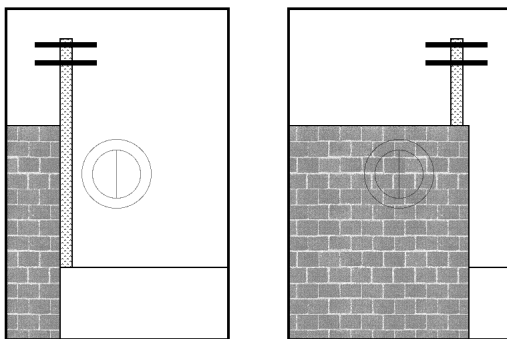

Bad.
Relative movement
between object when
rotating camera from
side to side.

If, as shown to the right, the two objects move with respect to one another in the viewfinder, slide the camera fore or aft in order to eliminate this movement. Here, the telephone pole has moved behind the brick wall.

Free Manuals Download Website

<http://myh66.com>

<http://usermanuals.us>

<http://www.somanuals.com>

<http://www.4manuals.cc>

<http://www.manual-lib.com>

<http://www.404manual.com>

<http://www.luxmanual.com>

<http://aubethermostatmanual.com>

Golf course search by state

<http://golfingnear.com>

Email search by domain

<http://emailbydomain.com>

Auto manuals search

<http://auto.somanuals.com>

TV manuals search

<http://tv.somanuals.com>