

KAMBROOK

THE SMARTER CHOICE



Micathermic Heater

KMH100

Instruction Booklet

Important

Please retain your instruction book for future use.

In the event that you need some assistance with your Kambrook appliance, please contact our Customer Service Department on 1300 139 798 (Australia) or 0800 273 845 (New Zealand). Alternatively, visit us on our website at www.kambrook.com.au or www.kambrook.co.nz

Contents

Kambrook Recommends Safety First	p4
Your Kambrook Micathermic Heater	p6
Quick Start Guide	p7
Using Your Micathermic Heater	p8
Care, Cleaning and Storage	p13

Kambrook Recommends Safety First

IMPORTANT: Please retain your instruction book for future use.

At Kambrook, we believe that safe performance is the first priority in any consumer product, so that you, our valued customer can confidently use and trust our products. We ask that any electrical appliance that you use be operated in a sensible fashion with due care and attention placed on the following important operating instructions.

Important Safeguards For Your Kambrook Micathermic Heater

- Carefully read all instructions before operating the Heater and save for future reference.
- Remove any packaging material and promotional stickers before using the Heater for the first time.
- Connect only to a 230V or 240V power point.
- Avoid touching the heater body while it is on, as some parts of the heater are hot. When moving the unit switch off and hold the heater by the handles where provided.
- Do not operate any heater with a damaged cord or plug, or if the heater has been dropped or damaged in any manner. Return the heater to your nearest Kambrook Service Centre for examination, electrical or mechanical adjustment or repair.
- Do not use outdoors. This heater is not intended for commercial use, such as construction sites.
- Do not locate the heater immediately below and in front of a socket outlet when in use.
- Do not use this heater with an external programmer, timer or any other device that switches the heater on automatically. Since a fire risk may exist if the heater is covered or positioned incorrectly.



WARNING: In order to avoid overheating, do not cover the heater.

- Extreme caution and supervision is necessary when this heater is used by or near children or invalids.
- Extreme caution and supervision is necessary when this heater is used near animals.
- Do not mount on ceiling.
- Do not leave the heater unattended. Always switch off the heater at the controls and at the power outlet then unplug from the power outlet when not in use.
- Do not use heater to dry your laundry.
- Do not operate heater whilst asleep.
- This heater is not intended for use in wet or moist locations. Do not immerse or allow liquids to be spilt on the heater.
- Do not use this heater in the immediate surroundings of a bath, a shower or a swimming pool.
- This heater has hot and arcing or sparking parts inside. Do not use in areas where petrol, paints, aerosols, or other inflammable substances are used or stored.
- Do not operate the heater with the power cord damaged, frayed or split, wound around any part of the heater, or in contact with heated surfaces of the heater.

- Do not allow materials that have been in contact with oil, petroleum based products or drying fluids to come in contact with the heater.
- Do not run the cord under carpeting or cover the cord with rugs, runners or the like. Arrange the cord away from traffic areas and where it will not be tripped over.
- To disconnect the heater, switch control to off, turn off at the power outlet then remove the plug from the outlet.
- Do not insert or allow foreign objects to pass through the inlet or outlet openings. This may cause an electric shock, fire or damage the heater.
- Do not touch hot surfaces.
- Switch off at the control switch and power outlet, then unplug and allow the heater to cool down before cleaning or storing.
- Use this heater only as described in this instruction manual. Any other use not recommended by the manufacturer may cause fire electric shock or injury and voids all warranties.
- Keep combustible materials such as drapes and other furnishings at least 2.0 metres from the front and 0.5m from the sides and rear (when it is intended for floor use) and 1.0m from the top of the heater.
- To prevent a possible fire or heat damage, allow ample space around the heater (at least 2.0m at front, 1.0m at the top and 0.5m at the rear and sides when it is intended for floor use), (at least 2.0m at the front, 1.0m at the top and 0.5m at the sides when it is wall mounted) and do not totally or partially block the air inlet or outlets in any manner. Check the openings from time to time for accumulated dust.

Important Safeguards For All Electrical Appliances

- Carefully read all instructions before operating the appliance and save for future reference.
- Remove and safely discard all packaging material and promotional labels before using the appliance for the first time.
- Fully unwind the power cord before use.
- Do not let the power cord hang over the edge of a bench or table, touch hot surfaces or become knotted.
- To protect against electric shock, do not immerse the power cord, power plug or appliance in water or any other liquid, unless it is recommended in the cleaning instructions.
- The appliance is not intended for use by persons (including children) with reduced physical, sensory or mental capabilities, or lack of experience and knowledge, unless they have been given supervision or instruction concerning use of the appliance, by a person responsible for their safety.
- Children should be supervised to ensure that they do not play with the appliance.
- It is recommended to inspect the appliance regularly. Do not use the appliance if the power supply cord, plug, connector or appliance becomes damaged in anyway. Return the entire appliance to the nearest authorised Kambrook Service Centre for examination and/or repair.
- Any maintenance other than cleaning should be performed at an authorised Kambrook Service Centre.
- This appliance is for household use only. Do not use this appliance for other than its intended use. Do not use in moving vehicles or boats. Do not use outdoors. **Misuse may cause injury.**
- The installation of a residual current device (safety switch) is recommended to provide additional safety protection when using electrical appliances. It is advisable that a safety switch with a rated residual operating current not exceeding 30mA be installed in the electrical circuit supplying the appliance. See your electrician for professional advice
- Always turn the appliance to the OFF position, switch off at the power outlet and unplug at the power outlet when the appliance is not in use.
- Before cleaning, always turn the appliance to the OFF position, switch off at the power outlet, unplug at the power outlet and remove the power cord, if detachable, from the appliance and allow all parts to cool.
- Do not place this appliance on or near a heat source, such as hot plate, oven or heaters.
- Position the appliance at a minimum distance of 20cm away from walls, curtains and other heat or steam sensitive materials and provide adequate space above and on all sides for air circulation.

Your Kambrook Micathermic Heater

1. 1500 watts of power for fast and even heat
 2. Heat setting dial for OFF, LOW or HI
 3. Variable THERMOSTAT control to maintain your desired temperature
 4. Micathermic element produces both radiant and convection heat
 5. Wheels for easy movement
 6. Carry handle
- NOT SHOWN**
- Wall mountable bracket
 - Safety tip-over switch
 - ThermoGuard safety protection for peace of mind



THERMO GUARD
PROTECTED

Quick Start Guide

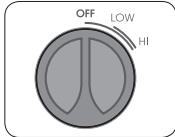
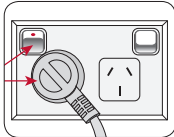
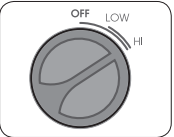
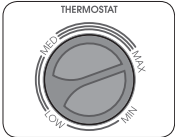
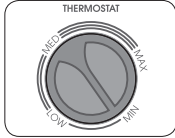
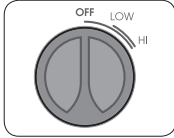
Turning the heater on after assembly		Setting the heating mode	Setting the variable temperature
			
<p>Turn the heat setting dial to the off position. Make sure that the switch on the THERMOSTAT dial is set to MIN.</p>	<p>Plug the cord into a 230V or 240V power point and switch on.</p>	<p>Turn the heat setting dial in a clockwise position to the LOW or HI heat setting.</p>	<p>Turn the variable THERMOSTAT dial in an anti-clockwise position to the MAX setting.</p>
Turning the heater off			
			
<p>When a comfortable room temperature has been reached, turn the variable THERMOSTAT in an anti-clockwise direction until a click sound is heard, then stop.</p>	<p>Return the heat setting dial to the OFF position to turn off the heater.</p>		

Hints/Tips to Retain Heat in Your Home

- Don't overheat your home. The temperature of a heated room in winter should be 18-21°C
- Your heater will work more efficiently if you stick to Kambrook's recommended clearance spaces
- Choose the right size heater for the room type you want to heat
- Zone off unoccupied rooms by closing doors and only heat the main living areas
- Fit window coverings like curtains to limit winter heat loss
- Put draft stoppers, such as a rolled up towel, at the bottom of outside doorways to keep out cold air
- Keep the heat in and the cold out by installing wall and ceiling insulation
- Avoid placing items too close to the heater at the front (and back if it is for floor use) for optimal air flow

Using Your Micathermic Heater

Before First Use

Remove any promotional material or packaging from the heater.

When unpacking the heater, check to see you have received the wheels and wall mounting packs, before discarding the packaging.

Unwind the cord to its full length and place the heater on a firm, level surface in a stable upright position. Visually inspect the air inlet and outlets to ensure there are no blockages.

Securing the Heater Wheels

The heater has four wheels and two wheel brackets that come with a set of screws. The wheel screws are located in the wheel pack.

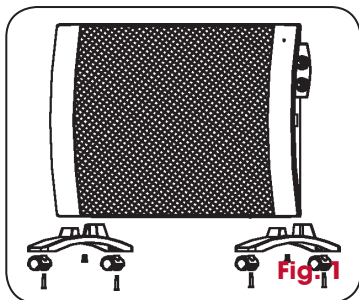

1. Insert the screw into the wheel, ensuring the flat end of the screw sits between the wheels.

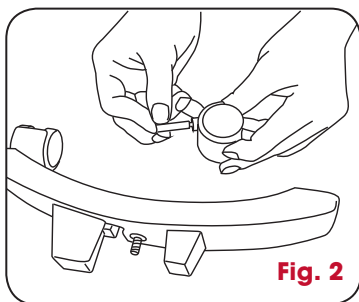

2. Line up the screw in the wheels with those in the base of the brackets, and secure.

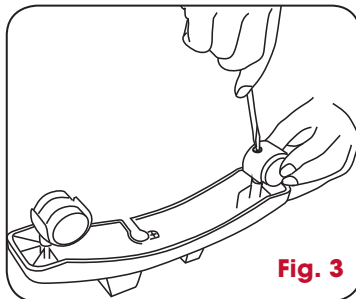

3. Turn the heater upside down. Place the plastic wheel brackets onto the two perforations, located at the base of the heater. Ensure the bracket with the centre hole (near the centre screw) is placed on the right hand side of the heater.

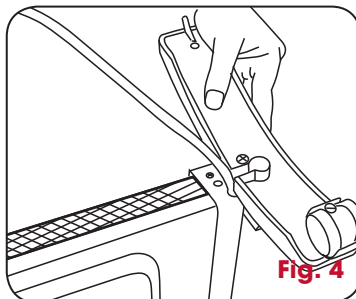

- Line up the bracket screw with the screw hole in the base of the heater, and secure.

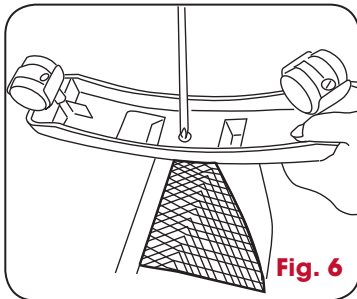
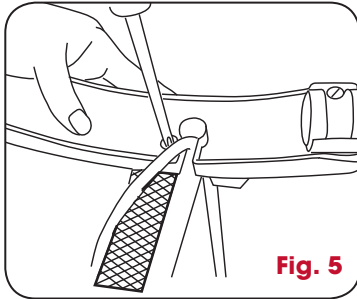

- Turn the heater upright so that the wheels are holding up the heating unit.

Wall Mounting Instructions

Please ensure your wall is capable of holding the weight of this heater and that the right screws are used for your wall.

This unit can be mounted on any wall in most rooms of the home (except in the immediate surroundings of a bath, a shower or a swimming pool). When selecting a location, decide upon a position that takes advantage of the maximum volume of air flow.



CAUTION: Before mounting the heater to the wall, please ensure that both attachment points are secure in either timber or concrete. Do NOT secure directly into plaster. Please contact a tradesman if you are unsure. Please see Fig. 7, which illustrates the points of contact. Ensure that the heater is at least 0.5 metres from the floor and corners of the wall.

NOTE: Ensure the feet are removed from the unit before wall mounting the heater.

NOTE: The heater comes with two sets of screws and wall mounting brackets which can be found in the bracket pack and on the back of the heater.

- Locate the brackets at the back of the heater. The bracket is located at the top of the heater in the centre as per fig 7.

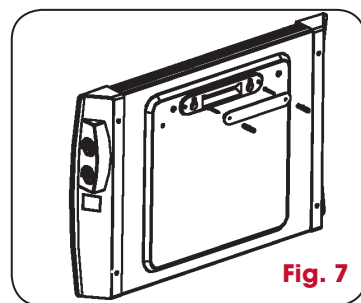

Using Your Micathermic Heater continued

- As a general safety guide select a suitable location to wall mount the heater, approximately 0.5m from any furniture/furnishing either side of the unit and 2m from any furniture/furnishing placed in front of the heater. The heater must be mounted horizontally as per Fig 8.

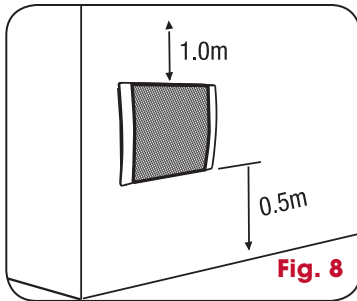

- When selecting a location, make sure the base of the heater is at least 0.5m from the floor and at least 1.0m from the ceiling.
- Measure out and mark the screw locations. Once you are confident that the screw locations are correct, drill suitable size holes.

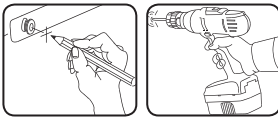

- Take care with inserting the screws into the holes you have made, and then mount the heater onto the wall bracket.

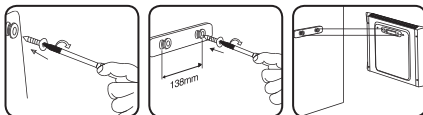

- Once the heater is mounted on the wall, lodge the heater to the mounting bracket to prevent the heater from being accidentally dislodged from the mounting bracket.
- Visually inspect the front panel to ensure no foreign material is blocking this area.



CAUTION: Do not mount the heater below curtains and/or other flammable items.

Turning Your Heater On

Turn the heat setting dial to the OFF position. Make sure that the switch on the THERMOSTAT dial is set to MIN.

Plug the cord into a 230V or 240V power point and switch on.

NOTE: To avoid an electrical circuit overload, it is recommended that no other appliances are plugged into the same circuit as your heater, when it is in use.

Setting The Heating Mode

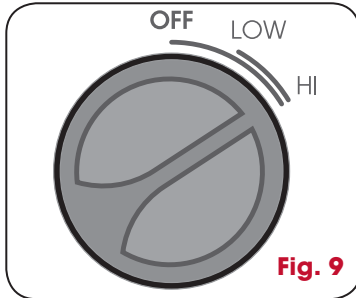

Fig. 9

To activate the heater, turn the heat setting dial clockwise to the LOW or HI setting. The heater will start operating on the selected heat setting and the red power indicator light will illuminate. Use the heat setting dial to select the desired heat setting.

LOW – Low heat setting (1000 watts)
HI – High heat setting (1500 watts)

Turn the heat setting dial to the OFF position to stop the heater operating.

NOTE: This heater features a tip-over switch. If the heater tips over, it will automatically switch off. Once placed back into the upright position, the heater will resume operation.

NOTE: You may notice a faint smell and light crackle sound when using the mica heater for the first time. This is normal and nothing to worry about. Continue running the mica heater, the smell will dissipates.

Setting The Variable Thermostat

The variable THERMOSTAT can be used to maintain your desired temperature.

Turn the variable THERMOSTAT dial to the MAX setting. Once a comfortable room temperature has been reached, slowly turn the variable THERMOSTAT dial anti-clockwise until a click sound is heard.

At this setting your heater will automatically cycle on and off to maintain the desired room temperature.

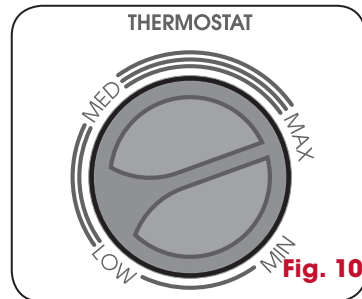

Fig. 10

To adjust the set temperature turn the variable THERMOSTAT dial clockwise to increase the desired temperature and anti-clockwise to decrease the desired temperature.

Using Your Micathermic Heater continued

ThermoGuard Overheating Safety Device

THERMO  GUARD
PROTECTED

Your heater is fitted with a safety device that switches off the heater in the event of overheating. Should this heater stop working, turn off the heater and inspect the air inlet and outlet for blockages. Wait at least five minutes for the protection system to reset before attempting to restart the heater.

If the heater fails to operate or the safety device switches off again, return the heater to your nearest Kambrook service centre for examination or repair.

Care, Cleaning and Storage

Ensure that the heater is switched off and disconnected from the power point before cleaning.

Use a clean, dry cloth to clean the external surfaces of the heater. If the heater has collected dust or dirt inside the unit, have the unit cleaned by a qualified service agent. Do not operate the heater in this condition.

Do not attempt to open up any parts of the heater as there are no customer serviceable parts inside.

When not in use, store the heater (preferably in its original box) in a cool, clean and dry location.

Notes

Kambook - Australia

Building 2, Port Air Industrial Estate
1A Hale Street
Botany NSW 2019
Australia
Customer Service Line 1300 139 798
Customer Service Fax 1800 621 337

www.kambook.com.au

Kambook - New Zealand

Private Bag 94411
Botany, Manukau
Auckland 2163
New Zealand
Customer Service Line/
Spare Parts 0800 273 845
Customer Service Fax 0800 288 513

www.kambook.co.nz

KAMBROOK
THE SMARTER CHOICE

Due to continual improvement in design or otherwise, the product you purchase may differ slightly from the illustration in this book. Issue A11

Free Manuals Download Website

<http://myh66.com>

<http://usermanuals.us>

<http://www.somanuals.com>

<http://www.4manuals.cc>

<http://www.manual-lib.com>

<http://www.404manual.com>

<http://www.luxmanual.com>

<http://aubethermostatmanual.com>

Golf course search by state

<http://golfingnear.com>

Email search by domain

<http://emailbydomain.com>

Auto manuals search

<http://auto.somanuals.com>

TV manuals search

<http://tv.somanuals.com>