

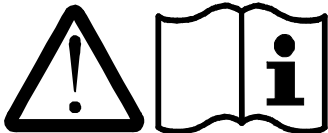

Puzzi 300 / 300 S / 400

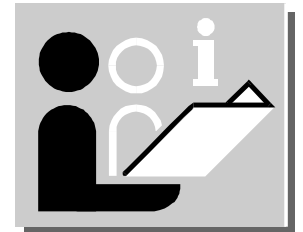

www.kaercher.com



5.959-361 2005-05-13



Inhaltsverzeichnis	Seite
Inbetriebnahme	5
Betriebsanleitung	7
Kärcher-Niederlassungen	100
Technische Daten / Ersatzteilliste	101/102
Zubehör	103

Vor erster Inbetriebnahme Betriebsanleitung und Sicherheitshinweise

Nr. 5.956-251 unbedingt lesen!

Dieses Gerät ist für den gewerblichen Gebrauch geeignet, z.B. in Hotels, Schulen, Krankenhäusern, Fabriken, Läden, Büros und Vermietergeschäften.

Lists of contents	Page
Commissioning	5
Operating Instructions	11
Kärcher branches	100
Technical Data / Spare Parts List	101/102
Accessories	103

Prior to initial startup, operating manual and safety instructions

no. 5.956-251 must be consulted! This machine is suitable for industrial use, for instance in hotels, schools, hospitals, factories, shops, offices and on hire.

Tables des matières	Page
Mise en service	5
Notice d'instructions	15
Filiales Kärcher	100
Caractéristiques techniques / Liste des pièces de rechange	101/102
Accessoires	103

Avant la première mise en service, lire absolument le mode d'emploi et les 5.956-251 remarques de sécurité! Cet appareil est adapté à l'usage professionnel, p. ex. dans les hôtels, les écoles, les hôpitaux, les usines, les magasins, les bureaux et les locations.

Indici	Pagina
Messa in funzione	5
Istruzioni per l'uso	19
Filiali Kärcher	100
Dati tecnici / Elenco pezzi di ricambio	101/102
Accessori	103

Prima della prima messa in funzione leggere assolutamente. le istruzioni per l'uso e le avvertenze per la sicurezza n. 5.956-251! Questo apparecchio è adatto per settori commerciali, per es. hotel, scuole, ospedali, fabbriche, negozi, uffici e noleggi

Inhoudsopgave	Pagina
Inbedrijfstelling	5
Gebruiksaanwijzing	23
Kärcher – filialen	100
Technische gegevens / Reserveonderdelenlijst	101/102
Accessoires	103

Vóór de eerste ingebruikneming de gebruiksaanwijzing en de veiligheidsinstructies nr.: 5.956-251 beslist lezen!

Dit apparaat is geschikt voor professioneel gebruik, bijv. in hotels, scholen, ziekenhuizen, winkels, kantoren en verhuurbedrijven.

Índices	Paginación
Puesta en servicio	5
Instrucciones de servicio	27
Filiales de Kärcher	100
Datos técnicos / Lista de piezas de repuesto	101/102
Accesorios	103

¡Las instrucciones de servicio y las indicaciones de seguridad núm. 5.956-251 se deben leer imprescindiblemente antes de la primera puesta en servicio!

Este aparato es apropiado para el uso a escala industrial, p. ej. en hoteles, centros escolares, hospitales, fábricas, tiendas comerciales, oficinas y empresas dedicadas al alquiler.

Índices	Página
Colocação em funcionamento	5
Manual de instruções	31
Filiais da Kärcher	100
Dados técnicos / Lista de peças sobressalentes	101/102
Accessórios	103

Antes da primeira colocação em funcionamento, ler atentamente o manual de instruções e as indicações de segurança de nº5.956-251!

Este aparelho destina-se ao uso industrial, nomeadamente em hotéis, escolas, hospitais, fábricas, lojas, escritórios e empresas de aluguer.

Πίνακες περιεχομένων	σελίδα
Θέση σε λειτουργία	5
Οδηγίες λειτουργίας	35
Αντιπροσωπείες Kärcher	100
Τεχνικά χαρακτηριστικά/Ανταλλακτικά	101/102
Εξαρτήματα	103

Πριν από την πρώτη θέση λειτουργίας διαβάστε οπωσδήποτε

τις Οδηγίες χρήσης και Υποδείξεις ασφαλείας. αρ. 5.956-251!
Αυτή η συσκευή είναι κατάλληλη για την επαγγελματική χρήση, π.χ. σε ξενοδοχεία, οικεία, νοσοκομεία, εργοστάσια, καταστήματα, γραφεία και εταιρείες δανεισμού συσκευών.



Indholdfortegnelser	Side
Idrifttagning	5
Driftsvejledning	40
Kärcher agenturer	100
Tekniske data / Reservodelsliste	101/102
Tilbehør	103

Inden første idrifttagning skal driftsvejledningen og sikkerhedshenvisningerne nr. 5.956-251 læses!

Dette apparat er beregnet til erhvervsmæssig brug, f.eks. i hoteller, skoler, sygehuse, fabrikker, forretninger, kontorer og udlejningsforretninger.

Innholdsfortegnelser	Side
Igangsetting	5
Bruksanvisning	44
Kärcher filialer	100
Tekniske data / Reservodelsliste	101/102
Tilbehør	103

Før første gangs bruk må bruksanvisning og sikkerhetsanvisning nr. 5.956-251 ubetinget leses!

Denne maskinen er egnet til bruk i næringslivet, f.eks. i hoteller, skoler, sykehus, fabrikker, butikker, kontorer og utleiebutikker.

Innehållsförteckningar	Sid
Idrifttagning	5
Driftinstruktion	48
Kärcher filialer	100
Tekniska data / Reservodelslista	101/102
Tillbehör	103

Läs noga instruktionsboken och säkerhetsanvisningarna nr.: 5.956-251 innan aggregatet tas i bruk!

Denna apparat är lämplig för användning inom näringslivet, t.ex. hotell, skolor, sjukhus, fabriker, butiker, kontor och uthyrningsaffärer.

Sisällysluettelo	Sivu
Käyttöönotto	5
Käyttöohje	52
Kärcher-toimipisteet	100
Tekniset tiedot / Varaosallista	101/102
Lisävarusteet	103

Ennen ensimmäistä käyttöönottoa on käyttöohje ja turvallisuusohjeet numero. 5.956-251 ehdottomasti luettava!

Tämä laite soveltuu ammattimaiseen käyttöön esim. hotelleissa, kouluissa, sairaaloissa, tehtaissa, myymälätiloissa, toimistoissa ja vuokrausliikkeissä.

Tartalomjegyzék	Oldal
Üzembevetel	5
Üzemeltetési utasítás	56
Kärcher telephelyek	100
Műszaki adatok / Cserealkatrészlista	101/102
Kellékek	103

Az első üzembevetel előtt az Üzemeltetési utasítást és az 5.956-251.sz-u biztonsági utalást feltétlenül elolvasni!

E készülék ipari célra készült, például szállodákban, iskolákban, kórházakban, gyárakban, raktárakban, irodákban és üzletekben használható

Obsah	Strana
Uvedení do provozu	5
Návod k obsluze	60
Zastoupení Kärcher	100
Technické údaje / Seznam náhradních dílů	101/102
Příslušenství	103

Před prvním uvedením do provozu si bezpodmínečně přečtěte návod k obsluze. a bezpečnostní upozornění č. 5.956-251!

Tento přístroj je vhodný pro komerční použití, např. v hotelech, školách, nemocnicích, továrnách, obchodech, kancelářích a půjčovnách.

Kazalo	Stran
Zagon	5
Navodila za obratovanje	64
Kärcher-poslovalnice	100
Tehnični podatki / Seznam nadomestnih delov	101/102
Oprema	103

Pred prvim zagonom je potrebno prebrati navodila za obratovanje in varnostne napotke št. 5.956-251!

Ta naprava je primerna za gospodarsko rabo, npr. v hotelih, šolah, bolnišnicah, tovarnah, trgovinah, pisarnah in najemnih prostorih.

Spis treści	Strona
Uruchomienie	5
Instrukcja obsługi	68
Filie firmy Kärcher	100
Dane techniczne / Lista części zamiennych	101/102
Wposażenie dodatkowe	103

Przed pierwszym uruchomieniem należy koniecznie przeczytać. 5.956-251 instrukcję obsługi i wskazówki dotyczące bezpieczeństwa nr do zasysania substancji płynnych.

Urządzenie to przeznaczone jest do użytku przemysłowego, np. w hotelach, szkołach, szpitalach, fabrykach, sklepach, biurach i wypożyczalniach.



Cuprins	Pagina
Punerea în funcțiune	5
Instrucțiuni de folosire	72
Sucursale Kärcher	100
Date tehnice / Listă de piese de schimb	101/102
Accesoriiile	103

Înainte de prima punere în funcțiune, instrucțiunile de folosire și indicațiile de siguranță nr. 5.956-251 trebuie citite neapărat!

Acest aparat este adecvat folosirii profesionale, de ex. în hoteluri, școli, spitale, fabrici, magazine, birouri și magazinele care închiriază aparate.

içindekiler	Sayfa
Servise koyma	5
Kullanma Kılavuzu	76
Kärcher Şubeleri	100
Teknik özelliğler / Yedek parça listesi	101/102
Aksesuar	103

Cihazı ilk kez çalıştırmadan önce kullanım kılavuzu güvenlik bilgilerini No. 5.956-251 mutlaka okuyun! Bu cihaz ticari kullanım için uygundur; örn. otellerde, okullarda, hastanelerde, fabrikalarda, dükkanlarda, satış merkezlerinde, bürolarda ve kiralama işletmelerinde kullanılabilir.

Cihazın kullanım ömrü 10 yıldır.

Содержание	Страница
Подготовка к работе	5
Руководство по эксплуатации	80
Филиалы фирмы Kärcher	100
Технические характеристики / Список запасных частей	101/102
Принадлежности	103

Перед началом эксплуатации обязательно ознакомьтесь с руководством по эксплуатации и изучите указания мер безопасности № 5.956-251! Этот прибор предназначен для применения в промышленных целях, например, в гостиницах, школах, больницах, на фабриках, в магазинах, бюро, арендных торговых точках.

Zoznam	Strana
Uvedenie do prevádzky	5
Návod k prevádzke	84
Zastúpenie Kärcher	100
Technické údaje / Zoznam náhradných dielov	101/102
Príslušenstvo	103

Pred prvým zapojením do prevádzky je bezpodmienečne nutné prečítať si Návod k prevádzke a Bezpečnostné pokyny č. 5.956-251. Tento prístroj je určený na použitie v nebytových priestoroch, napr. v hoteloch, školách, nemocniciach, továrňach, obchodoch, kanceláriách a je možné ho za týmto účelom prenajímať.

Sadržaj	Stranica
Puštanje u rad	5
Upute za upotrebu	88
Kärcher-podružnice	100
Tehnički podaci / Popis rezervnih dijelova	101/102
Pribor	103

Prije prvog puštanja u rad obavezno pročitati Upute za upotrebu i sigurnost pri radu br. 5.956-251! Ovaj uređaj je namijenjen za upotrebu u gospodarstvu, npr. u hotelima, školama, bolnicama, tvornicama, trgovinama, uredima i poslovima iznajmljivanja.

Sadržaj	Strana
Puštanje u pogon	5
Uputstvo za rukovanje	92
Kärcher-predstavništva	100
Tehnički podaci / Spisak rezervnih delova	101/102
Dodatna oprema	103

Pre prvog puštanja u pogon obavezno pročitati uputstvo za rukovanje i sigurnosne napomene br. 5.956-251! Ovaj uređaj je prikladan za službenu upotrebu, na primer u hotelima, školama, bolnicama, fabrikama, prodavnicama, kancelarijama i iznajmljivanje.

Съдържание	Страница
Пускане в експлоатация	5
Упътване за работа	96
Kärcher –Филиал	100
Технически данни / Списък на резервни части	101/102
Спомагателни принадлежности	103

Преди първото пускане в експлоатация прочетете непременно Упътването за работа и указание за безопасност № 5.956-251! Този уред е подходящ за промишлена употреба, напр. в хотели, училища, болници, предприятия, магазини, офиси и дейности с даване под наем.

Puzzi 300 / 300 S

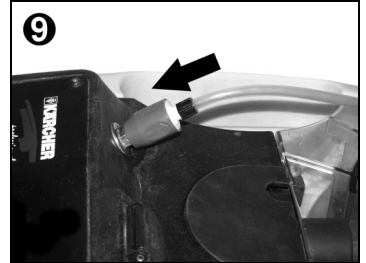
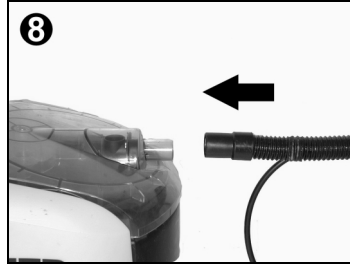
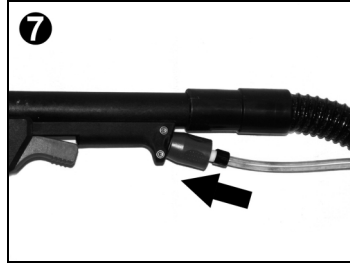
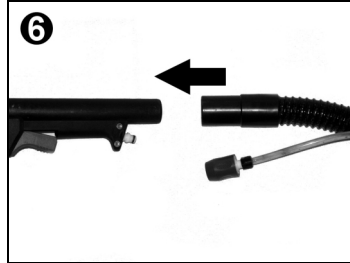
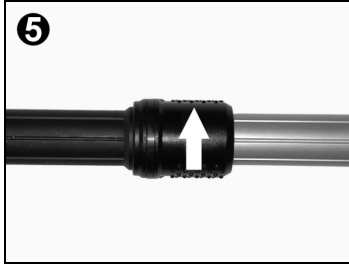
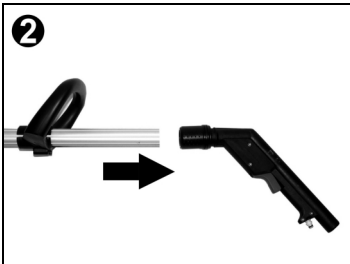
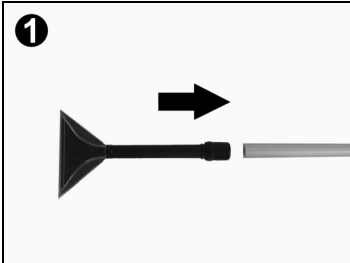

Puzzi 400

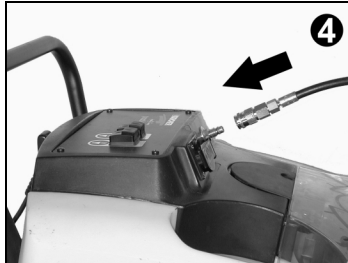
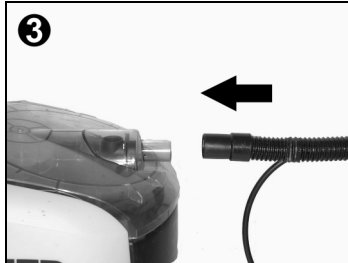
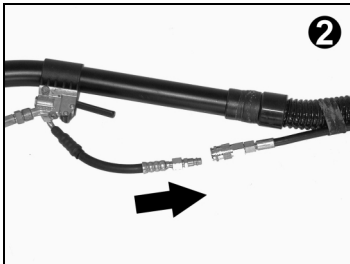
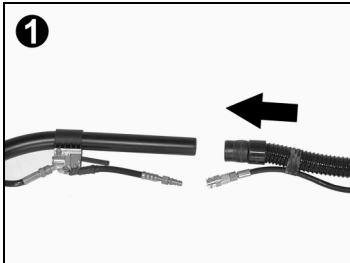

FOR OUR ENVIRONMENT

Packaging waste disposal



When unpacking, do not throw away packaging in the garbage, instead, take it to collecting stations.

Intended use

- Wet cleaning unit for carpets and home textiles
- Corresponding to the descriptions and safety instructions given in these operating instructions.
- ◆ Any other use is considered inappropriate. The manufacturer is not liable for damages resulting from this, the risk is the user's only.

Apply the cleaning agent

- Never fill with solvent (petrol, acetone, thinner etc.)!
- Avoid contact with eyes and skin
- Observe safety and handling instructions of the cleaning agent manufacturer

Kärcher offers a tested, individual cleaning agent program.

Your dealer will be pleased to advise you.

OPERATING INSTRUCTIONS

- Thoroughly mix fresh water and cleaning agent in a clean container
- Pour in pulverised cleaning agent in water and stir
- ◆ Observe safety and handling instructions of the cleaning agent manufacturer



Fill unit with a maximum of 40 l cleaning agent solution



Connecting to the mains

- ◆ Only work with dry hands
- ◆ Supply voltage must coincide with voltage on rating plate
- ◆ Always completely unwind extension cable
- ◆ Only connect splash-proof extension cables
- ◆ Extension cable must not be in water

For the connected load, see "Technical Data"



- Set switch 1 and 2 to "0"
- Insert power plug

Switch on switch 1 (suction)
Switch on switch 2 (spray)



An additional plug-socket is available for connecting additional electrical devices (only Puzzi 300 S / 400)

Cleaning

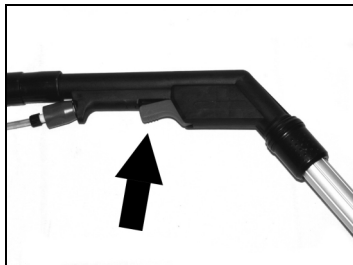

Activate valve handle
(Puzzi 300 / 300 S)

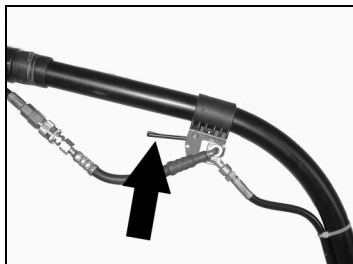

Activate valve handle (Puzzi 400)
The cleaning agent solution is
sprayed and simultaneously sucked
in.



Drive on the surface to be cleaned in
overlapping paths. Repeat as
necessary.

Note:

When the dirty-water tank is full, the
suction air is interrupted by the
mechanical floating switch.



- Switch off spray and suction
switch
- Remove the cover

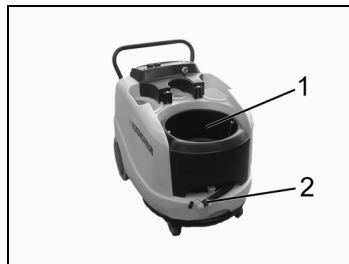

- Remove dirty-water tank (1) and
empty, or empty using a drain
hose (2)

CLEANING METHODS

Normal dirty carpets

- Spray cleaning solution and use
suction immediately
- Using suction again shortens the
drying time

Very dirty carpets

- Only spray cleaning solution
- Wait 10-15 min.
- Use suction to remove cleaning
solution

Cleaning upholstery

- Attach the hand nozzle (special
attachment) instead of floor nozzle
for cleaning upholstery
- Use the appropriate attachments
for cleaning steps, wall carpets, or
motor vehicle-interiors
- For sensitive materials use lower
amounts of the cleaning agent,
spray the surface from
approx. 200 mm away. Use
suction afterwards to remove
solution

Rinsing

- One obtains a better result when
the surface to be cleaned is rinsed
again with clear water
- Remains of the cleaning agent
and loosened dirt are then rinsed
out

Working tips

- The more sensitive the carpet, the smaller the amount of cleaning agent
- Carpets with jute backings can shrink and the colours can bleed if the treatment is too wet
- High pile carpets should be brushed off first
- Cleaning with warm water (up to max. 50°C) is more effective
- Spray very dirty areas beforehand
- Work from light to dark areas (from window to doors)
- Work from clean areas to dirty ones
- Treat carpet with Care Tex RM 762 after cleaning (accessory).
- Wait until cleaned surface is dry before walking on it
- Use de-foaming agent RM 761 (accessory) for shampooed carpets.

AFTER OPERATION**Storage**

- Remove unused cleaning fluids from the housing with suction hose
- Remove the floor nozzle and hold suction hose in a fresh-water tank. Turn "Suction" switch on. The cleaning fluid removed by suction is collected in the dirty-water tank
- Empty the dirty-water tank
- Fill fresh-water tank with 5l clean water
- Switch on spray switch
- Activate valve handle and rinse out unit for approx. 2 min.
- Switch off unit and pull the power plug.

CARE AND MAINTENANCE**Service agreement:**

A maintenance contract for this unit can be signed with a Kärcher authorised dealer.

- Remove the cover

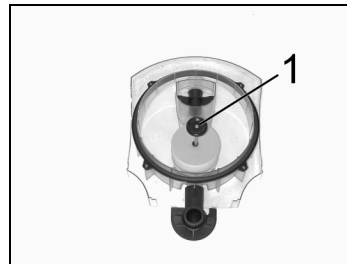

Unscrew the (1) float

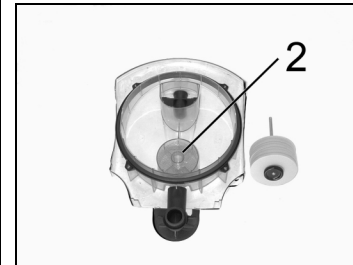

Clean the (2) fluff strainer

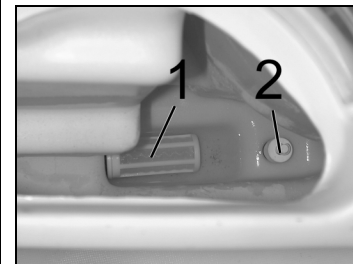

Clean the (1) fresh water strainer
Clean the float switch (2)
(only Puzzi 400)

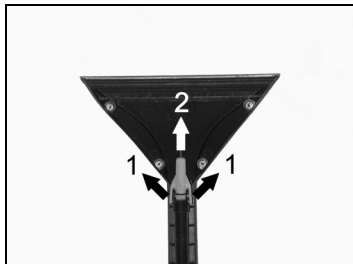

Clean nozzle mouth piece
(Puzzi 300 / 300 S)

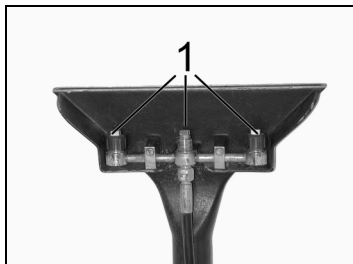

Unscrew the union nut
Clean nozzle mouth piece (1)
(Puzzi 400)

FAULT INSTRUCTIONS

Unit does not suck cleaning agent

- Clean strainer in the water tank
- Check the spraying hose

Insufficient operating pressure

- Screw in new nozzle mouth piece and align

Spray pump does not function (only PuZZi 400)

- Fill reservoirs



- Remove cover.
- Use a screwdriver to make the pump rotate a few times.

Warning:

Turn the appliance off and pull the mains plug out of the socket.

Sprays only on one side

- Cleaning

Insufficient vacuum

- Place the cover on correctly.
- Remove the cover, check the float
- Replace the suction turbine

Float closes suction supports

- Empty dirty-water tank
- Use de-foaming agent RM 761 (accessory) and thus prevent foam formation

CLEANING AGENT

Cleaning carpet and upholstery

RM 760, 10 kg

D,A,GB,I,E,FIN,S,N,
DK,F,NL/B 6.291-388
P 6.290-104

RM 760, 16 Tabs

D,A,CH,GB,F,I,NL,B, 6.290-828
E,P,GR,DK,N,S,FIN,
H,CZ,PL,SL,TR,RS,
SK,SR,HR,BG

RM 760, 200 Tabs

D,GB,A,H,CZ,I,P,E,GR 6.290-500
F,NL/B,FIN,S,N,DK 6.290-529

RM 764, 10 l

D,GB,A,I,E,GR 6.291-386
FIN,S,N,DK,F,NL/B 6.291-387

De-foamer

RM 761, 10 x 200 ml

D,A,GB,I,E,GR 6.291-397
FIN,S,DK,F,NL/B 6.291-398

Carpet impregnator

RM 762, 6 x 1 l

D,A,CH,I,F,NL/B 6.290-001
GB,E,P,GR 6.290-496
FIN,S,N,DK 6.290-497

RM 762, 5 l

D,A,CH,I,F,NL/B 6.290-002
GB,E,P,GR 6.290-494
FIN,S,N,DK 6.290-495

Mite remover

RM 765, 10 l

D,A,GB,I,F,NL/B 6.290-442
FIN,S,DK,N,GR,P,E 6.290-451

A Alfred Kärcher Ges.m.b.H. LichtblaustraÙe 7 1220 Wien ☎ (01) 25 06 00	DK Kärcher Rengöringsssystemer A/S Gejlhøvegård 5 6000 Kolding ☎ 70 20 66 67	GR Kärcher Cleaning Systems A.E. 31-33, Nikitara str. & Konstantinoupoleos str. 136 71 Acharnes ☎ 210 - 23 16 153	J Kärcher Co., Ltd. No.2, Matsusaka-Daira 3-chome Taiwa-cho, Kurokawa-gun Miyagi, 981-3408 ☎ 022 / 344 3140	PRC BKC Equipment Co., Ltd. No 16, Honda Beilu Beijing Economic & Technological Area Beijing 100176 ☎ 010 / 67 88 16 53
AUS Kärcher Pty Ltd 40 Koornang Road Scoresby Vic 3179 Victoria, Australia ☎ (03) 9765 - 2300	E Kärcher S.A. Pol. Industrial Font del Radium Dr. Trueta, 6-7 08400 Granollers (Barcelona) ☎ (93) 846 44 47	H Kärcher Hungária KFT Tormásrét ut 2, 2501 Biatorbagy ☎ 23 / 530-640	MAL Kärcher Cleaning Systems Sdn. Bhd. 8 Jalan Serindit2 Bandar Puchong Jaya 47100 Puchong, Selangor ☎ 5882 1148	S Kärcher AB Tagenevägen 31 42502 Hisings-Kärä ☎ 031 - 57 73 00
B / LUX Kärcher NV Industrierweg 12 2320 Hoogstraten ☎ (03) 340 07 11	 <p style="text-align: center;">http://www.kaercher.com</p>		MEX Kärcher México, SA de CV Av. Gustavo Baz Sur No. 29-C Col. Naucalpan Centro C.P. 53000, Municipio de Naucalpan ☎ 01-800-024-13-13	SGP Kärcher Asia Pacific Pte Ltd 30 Toh Guan Road Singapore #07-05 ODC Building Singapore 608840 ☎ 6897 1811
BR Kärcher Ind. e Com. Ltda. Prof. Benedicto Montenegro, 419 CEP 13.140-000 Paulinia - SP ☎ 0800 17 61 11			N Kärcher AS Stanseveien 31 0976 Oslo ☎ 24 / 177 700	TR Kärcher Servis Ticaret A.S. 9 Eylül Mahallesi 307 Sokak No. 6 Gaziemir / Izmir ☎ 0232 / 252 07 08
CDN Kärcher Canada Inc. 6975 Creditview Road, Unit 2 Mississauga, Ontario L5N 8E9 ☎ (905) 672 98 23	F Kärcher S.A. 5, avenue des Coquelicots Z.A. des Petits Carreaux 94865 Bonneuil Marne Cedex ☎ 01 / 43 99 67 70	HK Kärcher Ltd. Unit 10, 17/F., APEC Plaza 49 Hoi Yuen Road, Kwun Tong, Kowloon ☎ 2357 5863	NL Kärcher BV Postbus 474 4870 AL Etten-Leur ☎ 0499 / 37 54 45	TWN Kärcher Taiwan Limited 5F/6, No.7 Wu-Chuan 1st Rd Taipei County, Taiwan R.O.C ☎ 2 2299 9626
CH Kärcher AG IndustriestraÙe 16 8108 Dällikon ☎ 0844 850 863	FIN Kärcher Oy Yrittäjätie 17 01800 Klaukkala ☎ (09) 879 191	I Kärcher S.p.A. Via Elvezia 4 21050 Cantello (VA) ☎ 03 32 / 848 - 99 88 77	NZ Kärcher Limited 12 Ron Driver Place East Tamaki, Auckland ☎ 09 / 274 46 03	UAE Kärcher FZE Jebel Ali Free Zone RA 8, XB 1, Jebel Ali, Dubai ☎ 04 / 8836 776
CZ Kärcher spol.s.r.o. Za Mototechnou 1114/4 155 00 Praha 5 - Stodůlky ☎ 0235 521 665	GB Kärcher (UK) Ltd. Kärcher Centre Gissigheim Beaumont Road Banbury, Oxon, OX16 1TB ☎ 01295 / 752000; 09066 / 800632	IRL Kärcher Limited 12 Willow Business Park Nanigor Road Clondalkin Dublin 12 ☎ 01 / 409 77 77	P Neoparts Com. e Ind. Automóvel, Lda. Largo Vitorino Damásio. 10 1200 Lisboa ☎ 21 / 395 0040	USA Alfred Kärcher, Inc 2170 Satellite Blvd, Suite 350 Duluth, GA 30097 ☎ 678-935-4545; 877-527-2437
D Alfred Kärcher GmbH & Co. KG Service-Center Gissigheim Im Gewerbegebiet 2 97953 Königheim-Gissigheim ☎ 07195 / 903 20 65			PL Kärcher Poland Ltd. Sp. z o.o. Ul. Stawowa 140 31-346 Kraków ☎ 012 / 639 72 22	ZA Kärcher (Pty) Ltd. P.O. Box 11818 Vorna Valley 1686 ☎ 011 / 466 24 34

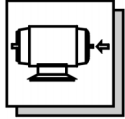

Puzzi 300 / 300 S
 P max : 2 x 40 W
 Puzzi 400
 P max : 230 W



15 m
 H05W-F3x1,0
 EUR: 6.648-588
 CH: 6.648-589
 AUS: 6.648-590
 GB: 6.648-591
 RA: 6.648-600

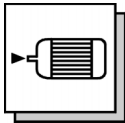

Puzzi 300 / 300 S
 P : 1100 W
 Puzzi 400
 P : 1200 W



Puzzi 300 / 300 S :
 max. 0,3 MPa (3,0 bar)
 Puzzi 400 : max. 0,4 MPa (4,0 bar)

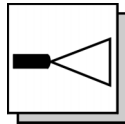

Puzzi 300 / 300 S : 2,0 l/min
 Puzzi 400 : 3,0 l/min



Puzzi 300 / 300 S : 53 l/s
 Puzzi 400 : 43 l/s

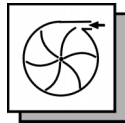

Puzzi 300 / 300 S :
 22 kPa (220 mbar)
 Puzzi 400 : 27,5 kPa (275 mbar)

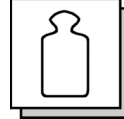

Puzzi 300 / 300 S : 31 kg
 Puzzi 400 : 35 kg

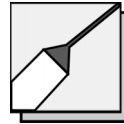

Puzzi 300 / 300 S : 230 mm
 Puzzi 400 : 350 mm



EN 60704-2-1
 Puzzi 300 / 300 S : 69 dB(A)
 Puzzi 400 : 71 dB(A)

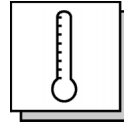

50 °C



45 l

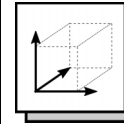

820 mm x 530 mm x 690 mm

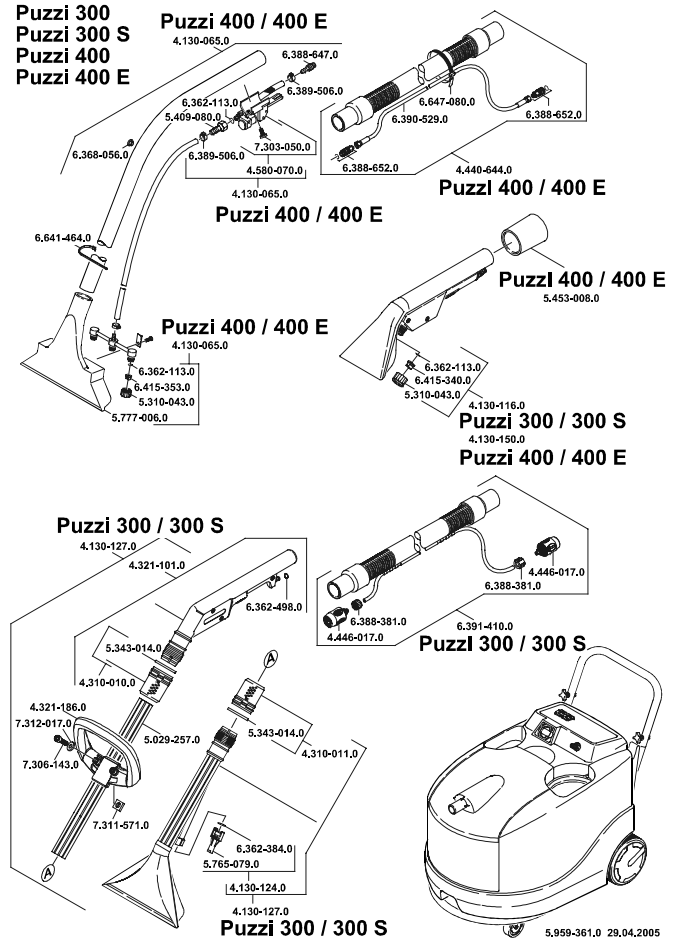
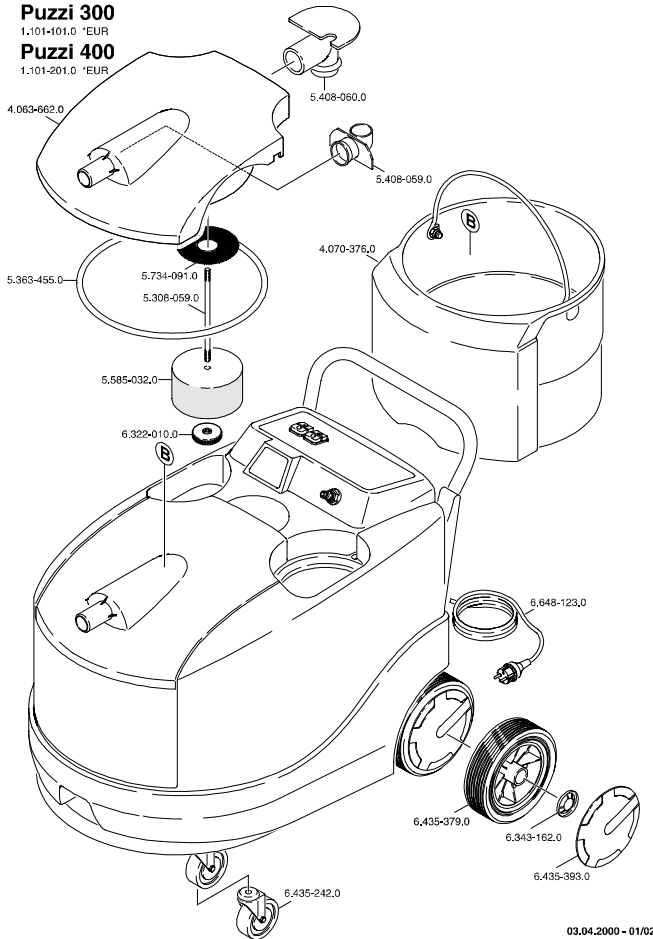

Puzzi 300 / 300 S

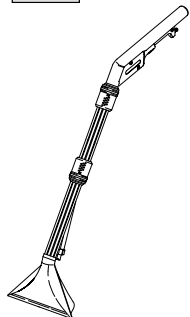

4.130-127.0

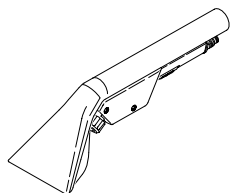

4.130-116.0



4.762-220.0

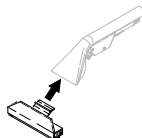

4.762-219.0



4.130-117.0

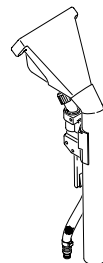

4.130-083.0

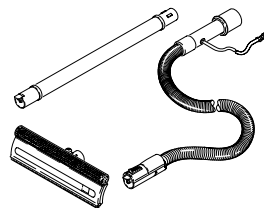

2.638-778.0

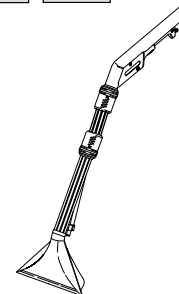
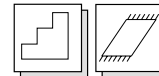

4.130-128.0

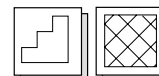

4.762-220.0

Puzzi 400

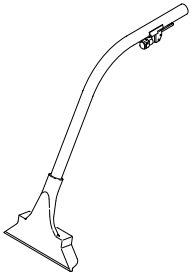

4.130-065

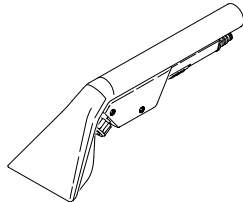

4.130-163

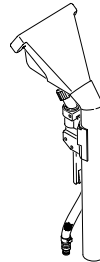

4.130-067

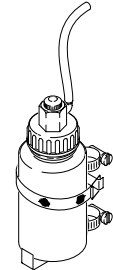

3. 637-002

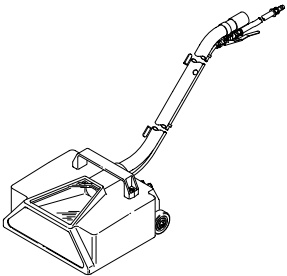

1.735-121

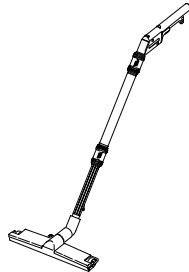
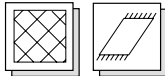

4.130-074

Free Manuals Download Website

<http://myh66.com>

<http://usermanuals.us>

<http://www.somanuals.com>

<http://www.4manuals.cc>

<http://www.manual-lib.com>

<http://www.404manual.com>

<http://www.luxmanual.com>

<http://aubethermostatmanual.com>

Golf course search by state

<http://golfingnear.com>

Email search by domain

<http://emailbydomain.com>

Auto manuals search

<http://auto.somanuals.com>

TV manuals search

<http://tv.somanuals.com>