

# Model K 2301

Part No. 1.133-213.0

## High Pressure Washer Operator Manual

Overview .....	1
Precautions .....	1-2
Assembly Instructions .....	3
Operating Instructions .....	4
Using the Accessories .....	5
Working with Detergents .....	6
Shut Down and Clean-Up .....	7
Taking a Break .....	7
Winterizing and Long-Term Storage ..	7
Cleaning Tips .....	8-9
Optional Cleaning Accessories .....	9
Trouble Shooting .....	10-11

**In USA Call:  
1-800-537-4129  
or visit our website:  
[www.karcher-usa.com](http://www.karcher-usa.com)**

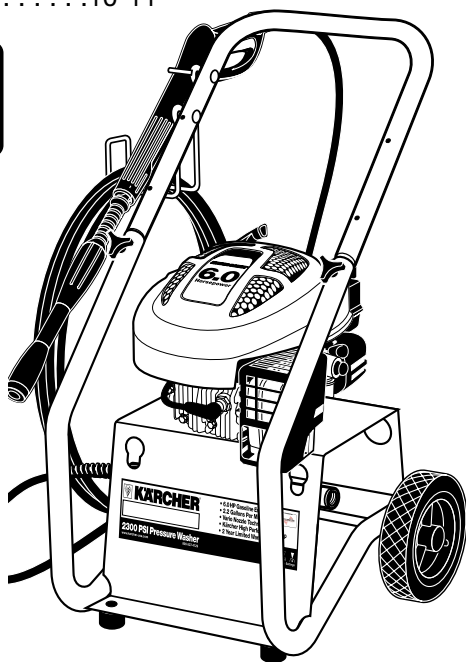

### Specification

Engine	6.0 HP Tecumseh
Operating pressure	2300 PSI
Water volume	2.2 GPM
Maximum water inlet temperature	104° Fahrenheit

## MODEL K 2301 OVERVIEW

NOTE: Engines controls shown may appear different.

### Item Description

1. Water inlet with filter and garden hose connector
2. Detergent suction tube (not pictured)
3. Oil fill cap
4. Knob Assembly (two each):  
Hex Head Screw  
Serrated Washer Knob
5. High pressure hose
6. Detergent filter (not pictured)
7. Handle
8. Trigger gun safety lock
9. Trigger gun
10. Pull start
11. Gas tank
12. Vario spray wand
13. High pressure outlet (not pictured)
14. Manual
15. Detergent tray
16. Hose reel mounting holes

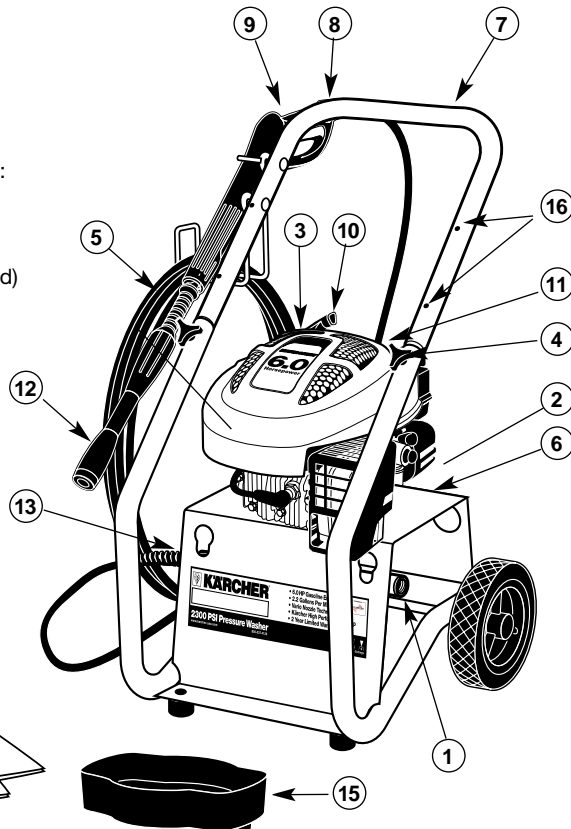

### Features:

- Thermal release valve

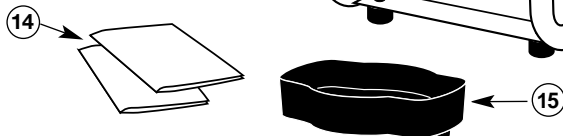

## NEVER!

- Never** point nozzle at people or animals.
- Never** drink alcohol or use drugs while operating this equipment.
- Never** spray electrical connections, electrical outlets or fixtures.
- Never** add fuel with the engine running or operate where fuel has been spilled.
- Never** touch hot surfaces or allow accessories to contact hot surfaces.
- Never** operate in an enclosed space, exhaust fumes are dangerous.
- Never** operate near utilities with open flames.
- Never** operate without the water turned on and never use hot water.

## IMPORTANT PRECAUTIONS – Read First!



### Safety Warnings

When using this product basic precautions should always be followed:

- Read all the instructions before using the product.
- FIRE HAZARD! Do not add fuel with the engine running. Do not operate if fuel has been spilled. Instead move the machine to a different location and avoid creating sparks.
- Operate and fuel machine in a well ventilated area, free of devices featuring an open pilot or flame such as boilers, water heaters, etc.
- High pressure jets can be dangerous if subject to misuse. The jet must not be directed at persons, animals, electrical devices, or the machine itself.
- Wear safety goggles.
- Do not use acids, solvents, or any other flammable material in this product. These products can cause physical injuries to the operator and irreversible damage to the machine.
- The machine has hot surfaces which can cause burns. Operate the unit in a safe environment and away from children.
- Do not allow the high pressure hose to come into contact with the muffler guard.
- Do not leave the machine running unattended.
- Learn how to stop the machine and release pressure quickly. Be thoroughly familiar with the controls.
- Stay alert — watch what you are doing.
- Do not operate the product when fatigued or under the influence of alcohol or drugs.
- Do not stand on unstable surfaces. Stand with both feet balanced at all times.
- The Gun Safety Lock PREVENTS the trigger from accidentally being engaged. This safety feature DOES NOT lock trigger in the “on” position.

### Water Supply (Cold Water Only)

- Water hose must be at least 3/4 inch in diameter.
- Flow rate of water supply must not fall below 2.5 GPM (gallons per minute).
- Flow rate can be determined by running the water for one minute into an empty 5-gallon container.
- The water supply temperature must not exceed 104°F/40°C.
- Never use the pressure washer to draw in water contaminated with solvents, e.g. paint thinners, gasoline, oil, etc.
- Always prevent debris from being drawn into the unit by using a clean water source.

We strongly recommend that this high pressure washer not be left running for periods of 5 minutes or longer without the trigger gun being engaged.

This Kärcher high pressure washer is equipped with thermal protection to extend the life of your pressure washer. The thermal protector will automatically activate at a pre-determined high temperature ejecting hot water before resetting. This ensures that the pump does not become damaged.



### Caution

- Follow the maintenance instructions specified in the manual.
- This machine has been designed for use with cleaning detergent supplied or recommended by the manufacturer. The use of other cleaning detergents may affect the operation of the machine and void the warranty.

## ASSEMBLY INSTRUCTIONS

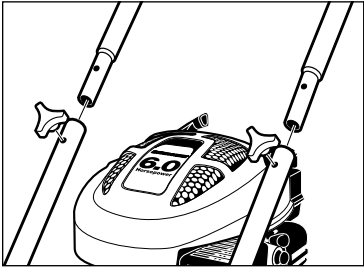

**Step 1** Slide the handle through the accessory rack.

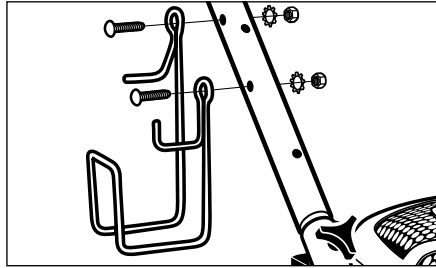

**Step 2** Attach the gun/hose storage handle.

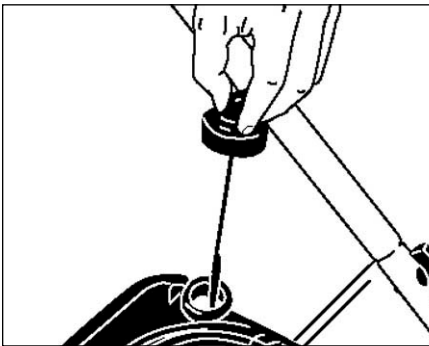

**Step 3** Check oil level. Oil level should always be between the "FULL" and "ADD" marks on the dipstick. Be sure the machine is level when checking the oil level. (Refer to the engine's operating manual for seasonal grades).

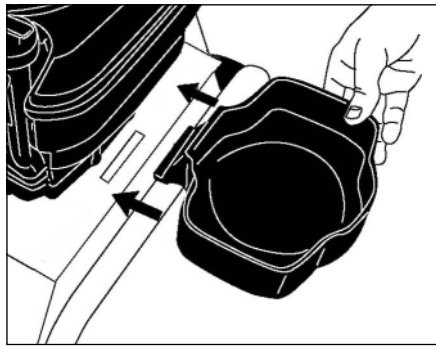

**Step 4** Insert the detergent tray into the tray slot and screw in the fastener. Fill the detergent container with the proper detergent for your cleaning project. Note: Place the container on the tray.

**Important!** Do not run the engine with a high or low oil level as this can cause engine damage. If you have further questions regarding the engine, please refer to the engine's operating manual included with the unit.

**You are now ready to operate your Kärcher Pressure Washer**

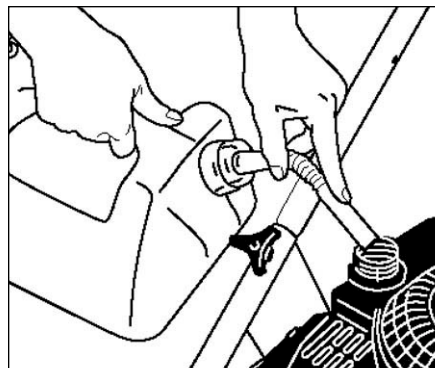

**Step 5** Fill gas tank with unleaded gasoline. Do not use leaded gasoline.

## OPERATING INSTRUCTIONS

NOTE: Engines controls shown may appear different.

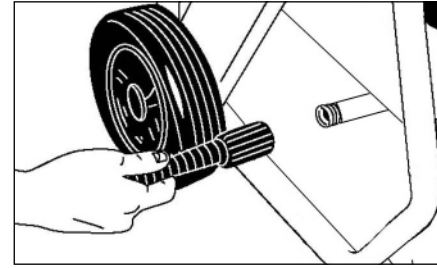

**Step 1** Connect the high pressure hose to the unit's high pressure outlet.

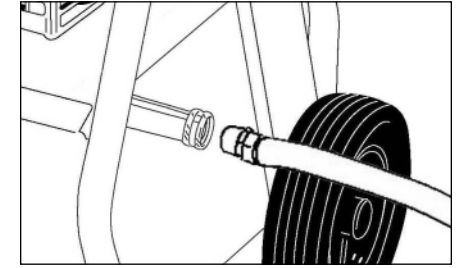

**Step 2** Connect garden hose to unit's water inlet.

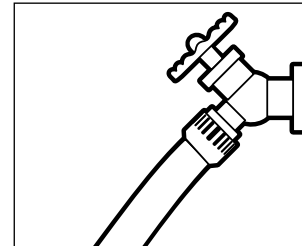

**Step 3** Connect garden hose to the cold water source and turn water on completely.

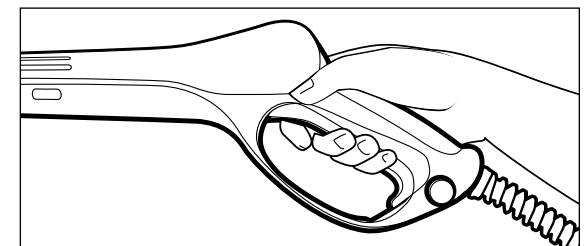

**Step 4** Trigger the gun to eliminate trapped air, wait for a steady flow of water to emerge from the spray nozzle.

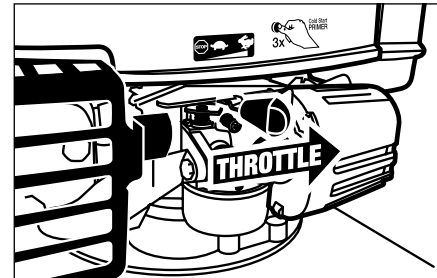

**Step 5** Slide the throttle control to the fast position.

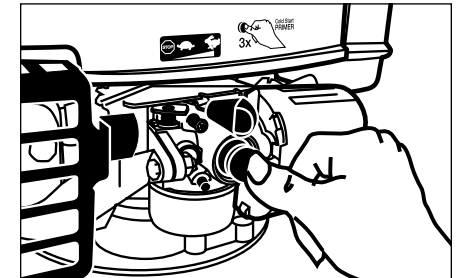

**Step 6** Push primer ball three times. Wait 3 seconds between each push.

**Note:** in cold weather push 5 times.

**Step 7** Pull the starter handle. If the engine fails to start after 3 pulls squeeze the trigger gun to release pressure, and repeat step 7.

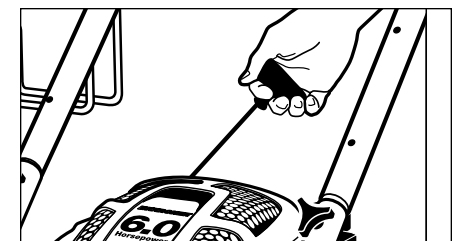

## USING THE ACCESSORIES

**Step 1** Insert the Vario spray wand into the gun. Push in and turn clockwise to lock spray wand in place.

**Step 2** Attach high pressure hose to trigger gun.

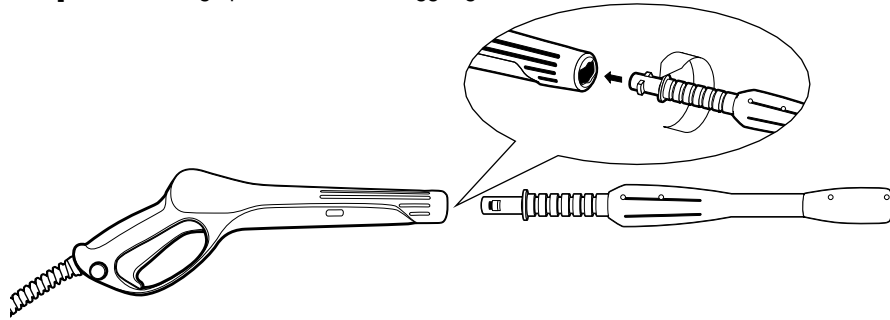

### Vario spray wand

The Vario spray wand allows you to adjust the cleaning pressure. To clean at maximum pressure, the Vario wand must be positioned to the high pressure setting (+). To apply detergent, the wand must be positioned to the low pressure setting (-).

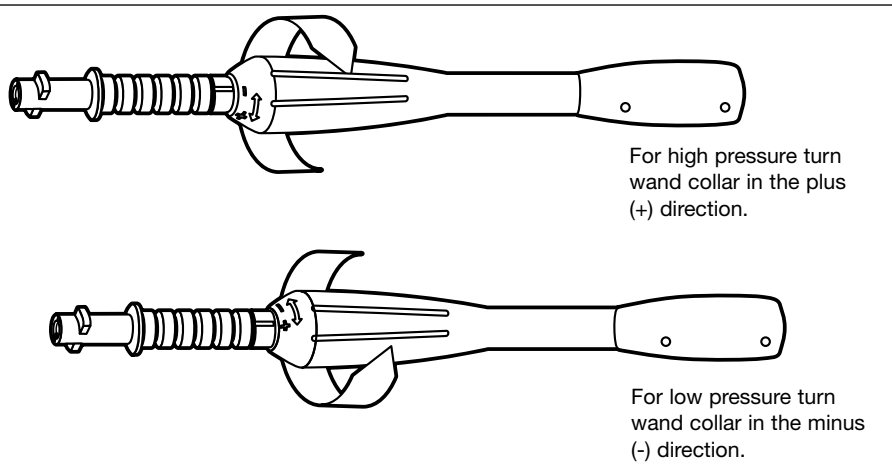

**WARNING TO AVOID SERIOUS INJURY, NEVER POINT SPRAY NOZZLE AT YOURSELF, OTHER PERSONS OR ANIMALS**

## WORKING WITH DETERGENT

Detergents can only be applied at low pressure (-).

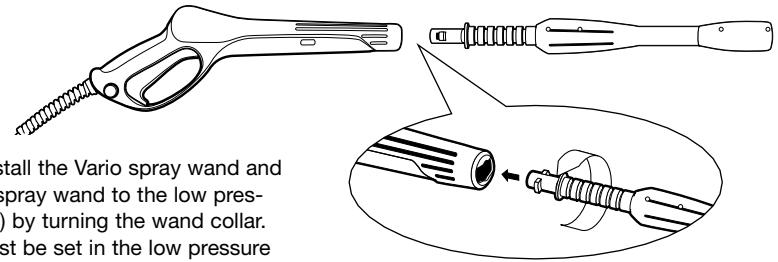

**Step 1** Install the Vario spray wand and set the Vario spray wand to the low pressure setting (-) by turning the wand collar. The wand must be set in the low pressure (-) position to apply detergents.

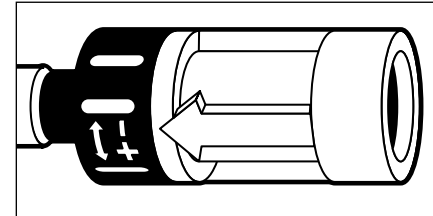

**Step 2** Adjust the filter end of the detergent tube for light (-), or maximum (+) detergent coverage.

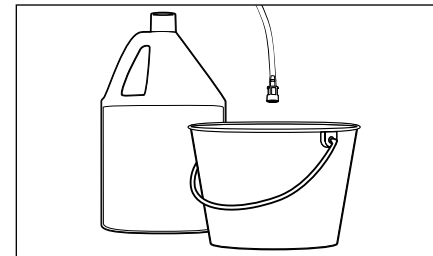

**Step 3** Fill a container with Kärcher detergent. Place the filter end of detergent suction tube into the container.

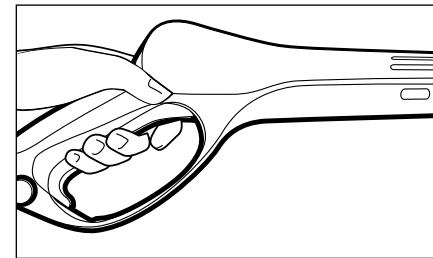

**Step 4** With the engine running, pull trigger to operate unit: Liquid detergent is drawn into the unit and mixed with water. Apply detergent to work area. Do not allow detergent to dry on surface.

**For best results see *Cleaning Tips* on pages 8 & 9 or included cleaning guide for specific information on how to clean different surfaces.**

**Always Use Kärcher Detergents for Best Results.**

Kärcher biodegradable detergents are specially formulated to protect the environment and your pressure washer. The special formula won't clog the suction tube filter and will protect the internal parts of the pressure washer for a longer life. For Kärcher Detergents, check your retailer or call:

**In USA Call:  
1-800-537-4129  
or visit our website:  
[www.karcher-usa.com](http://www.karcher-usa.com)**

**The following Kärcher detergents are available:**

LIQUIDS (ready to use)	TABLETS (concentrated)
Vehicle Wash	All Purpose
House Wash	Degreaser
Degreaser	Deck and Patio
Deck Wash	Windows and Siding
All Purpose Cleaner	
Vehicle Wax	



### Caution

**Never use:**

- Bleach, Chlorine products and other corrosive chemicals
- Liquids containing solvents (i.e., paint thinners, gasoline, oils)
- Tri-sodium phosphate products
- Ammonia products
- Acid-based products

**These chemicals will harm the unit and will damage the surface being cleaned.**

## SHUTTING DOWN & CLEAN-UP

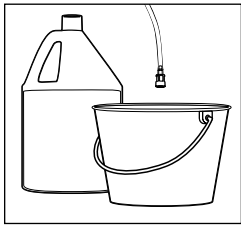

**Step 1** Remove detergent suction tube from container and insert into one gallon of fresh water. Siphon water at low pressure for one minute.

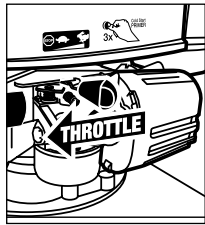

**Step 2** Turn off the engine.

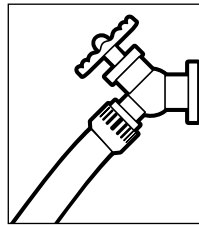

**Step 3** Turn off the water source.

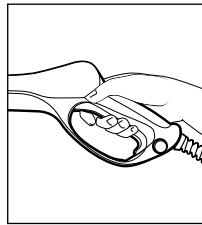

**Step 4** Press trigger to release water pressure.

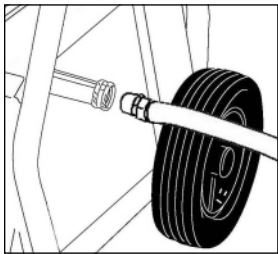

**Step 5** Disconnect the garden hose from the water inlet on the unit.

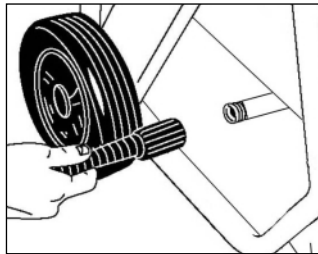

**Step 6** Disconnect the high pressure hose from the high pressure outlet and engage the gun safety lock.



## TAKING A BREAK... five minutes or more

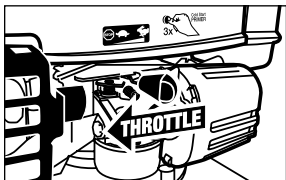

**Step 1** Turn off the engine.

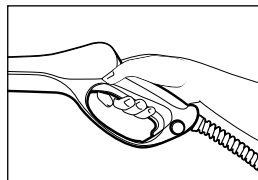

**Step 2** Press trigger to release water pressure.

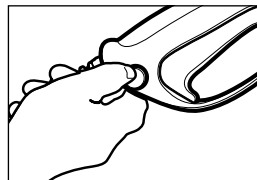

**Step 3** Engage gun safety lock.

## WINTERIZING AND LONG-TERM STORAGE

1. Disconnect all water connections.
  2. Start the machine for a **few seconds**, until the water which had remained in the pump exits. Turn off immediately.
  3. Drain the gas and oil from the engine.
  4. Do not allow high pressure hose to become kinked.
  5. Store the machine and accessories in a room which does not reach freezing temperatures. The machine should not be placed near an open flame i.e. furnace, hot water heater etc.
- Caution: Failure to follow the above directions will result in damage to the pump assembly and accessories.**

## CLEANING TIPS

### Deck Cleaning

(with or without detergent)

Pre-rinse deck and surrounding area with fresh water. If using Kärcher Deck and Patio Cleaner, place detergent suction tube directly into cleaning solution and apply to surface at low pressure. For best results, limit your work area to smaller sections of approximately 25 square feet. Allow Kärcher Deck and Patio Cleaner to remain on surface 1-3 minutes. Do not allow detergent to dry on surface. Rinse at high pressure in a long sweeping motion keeping the spray nozzle approximately 3-6 inches from the cleaning surface. Always clean from top to bottom and from left to right. When moving on to a new section of the cleaning surface, be sure to overlap the previous section to eliminate stop marks and ensure a more even cleaning result.

### House Siding

(with or without detergent)

Pre-rinse cleaning surface with fresh water. If using Kärcher House or Window and Siding Cleaner, place detergent suction tube directly into cleaning solution and apply to surface at low pressure (for best results, limit your work area to sections of approximately 6 feet and always apply detergent from bottom to top). Allow Kärcher House or Window and Siding Cleaner to remain on surface 1-3 minutes. Do not allow detergent to dry on surface, if surface appears to be drying, simply wet down surface with fresh water. If needed, use special Wash Brush Attachment to remove stubborn dirt. Rinse at high pressure from top to bottom in an even sweeping motion keeping the spray nozzle approximately 6 inches from the cleaning surface.

### Cement Patios, Brick and Stone

(with or without detergent)

Pre-rinse cleaning surface with fresh water. If using Kärcher Deck and Patio or All Purpose Cleaner, place detergent suction tube directly into cleaning solution and apply to surface at low pressure. For best results, limit your work area to smaller sections of approximately 25 square feet. Allow Kärcher Deck and Patio or All Purpose Cleaner to remain on surface 1-3 minutes. Do not allow detergent to dry on surface. Rinse at high pressure in a sweeping motion keeping the spray nozzle approximately 3-6 inches from the cleaning surface. Always clean from top to bottom and from left to right.

### Cars, Boats & Motorcycles

(with or without detergent)

Pre-rinse vehicle with fresh water. If using Kärcher Vehicle or All Purpose Cleaner, place detergent suction tube directly into cleaning solution and apply to surface at low pressure. For best results, clean one side of vehicle at a time and always apply detergent from bottom to top, do not allow detergent to dry on surface. If needed, use special Wash Brush Attachment to remove stubborn dirt. Rinse at high pressure in a sweeping motion keeping the spray nozzle approximately 6-8 inches from the cleaning surface (distance should increase when rinsing pin-stripping or other sensitive surfaces). Always clean from top to bottom and from left to right. For best results, wipe surface dry with a chamois or soft dry cloth.

## CLEANING TIPS - continued

### Barbecue Grills, Outdoor Power Equipment & Gardening Tools (with or without detergent)

Pre-rinse cleaning surface with fresh water. If using Kärcher All Purpose Cleaner or Degreaser, place detergent suction tube directly into cleaning solution and apply detergent at low pressure. Allow Kärcher detergent to remain on surface 1-3 minutes. Do not allow detergent to dry on surface. Rinse at high pressure keeping the spray nozzle approximately 3-6 inches from the cleaning surface. For removing extremely stubborn dirt, it may be necessary to move the spray nozzle even closer to the surface for greater dirt cutting action. To remove caked on mud from garbage cans, lawn mower blades, wheel barrels or other non-sensitive metal surfaces, you may want to use the Kärcher Rotating Nozzle Spray Wand.

**Caution: Do not use rotating nozzle spray wand on cloth, plastic or other sensitive surfaces as it may cause damage.**

### Patio & Lawn Furniture (with or without detergent)

Pre-rinse furniture and surrounding area with fresh water. If using Kärcher All Purpose Cleaner, place detergent suction tube directly into cleaning solution and apply to surface at low pressure. Allow Kärcher All Purpose Cleaner to remain on surface 1-3 minutes. Do not allow detergent to dry on surface. If needed use special Wash Brush Attachment to remove stubborn dirt. Rinse at high pressure in a sweeping motion keeping the spray nozzle approximately 3-6 inches from the cleaning surface. For best results, clean from top to bottom and from left to right.

**Caution: Do not use rotating nozzle spray wand on patio or lawn furniture as it may cause damage.**

### Recommendations

- Before cleaning any surface an inconspicuous area should be cleaned to test spray pattern and distance for maximum cleaning results.
- If painted surfaces are peeling or chipping, use extreme caution as pressure washer may remove the loose paint from the surface.

## OPTIONAL CLEANING ACCESSORIES

Optional cleaning accessories are available to further enhance your cleaning capabilities: See accessories order form for product descriptions and ordering instructions.

- Vario Spray Wand
- House Washing Wand
- Extension Wand
- Flexible Spray Wand
- Underbody Spray Wand
- 4 Piece Extension Wand
- Wet Sandblasting Attachment
- Pipe Drain Cleaner
- Water Suction Hose With Filter
- Extension Hose 25'
- Rotating Wash Brush
- K12 Surface Cleaner

## TROUBLE SHOOTING

Symptom	Cause	Solution
<b>Engine will not start</b>  <i>For additional engine problems refer to the engine owners manual.</i>	No gasoline.	Fill gas tank.
	Low oil level.	Add oil.
	Engine throttle is not in correct position.	Position the throttle to "FAST".
	Pressure built up in the high pressure washer.	Squeeze the trigger to release the pressure.
<b>Unit does not reach high pressure.</b>	Diameter of garden hose is too small.	Replace with a 3/4 inch garden hose.
	Water supply is restricted.	Check garden hose for kinks, leaks and blockage.
	Not enough inlet water supply.	Open water source full force.
	Water inlet filter is clogged.	Remove filter and rinse out in warm water.
	Spray wand is in low pressure position.	Turn spray wand tip to high pressure position.
<b>Output pressure varies high and low.</b>	Not enough inlet water supply.	Turn water on full force. Check garden hose for kinks, leaks or blockage.
	Pump is sucking air.	Check that hoses and fittings are air tight. Turn off machine and purge pump by squeezing trigger gun until a steady flow of water emerges through the nozzle.
	Water inlet filter is clogged.	Remove filter and rinse out in warm water.
	Discharge nozzle is obstructed.	Blow out or remove debris with a fine needle.
	Calcified gun, hose or spray wand.	Run distilled vinegar through detergent suction tube.

**In USA Call:  
1-800-537-4129  
or visit our website: [www.karcher-usa.com](http://www.karcher-usa.com)**

## TROUBLE SHOOTING - *continued*

Symptom	Cause	Solution
<b>No detergent.</b>	Detergent suction tube not properly connected to the machine.	Check connection.
	Detergent is too thick.	Dilute detergent, for best results use Kärcher detergent.
	Filter on detergent suction tube is clogged.	Run warm water through filter to remove debris.
	Damaged or clogged detergent suction tube.	Remove obstruction or replace detergent suction tube.
	Spray wand is in high pressure position.	Turn spray wand tip to low pressure position.
	Discharge nozzle is obstructed.	Blow out or remove debris with a fine needle.
<b>Garden hose connection leaks.</b>	Loose fitting.	Tighten fittings.
	Missing/worn rubber washer.	Insert new washer.
<b>Spray wand leaks.</b>	Spray wand not properly attached.	Insert the spray wand into the trigger gun. Carefully press in against the spring tension and twist into the locked position.
	Broken o-ring or plastic insert.	Call Kärcher customer service hotline and order repair kit (part no. 2.883-111.0).
<b>Pump is noisy.</b>	Pump is sucking air.	Check that hoses and fittings are air tight. Turn off machine and purge pump by squeezing trigger gun until a steady flow of water emerges through the nozzle.
<b>Water leaks from pump (up to 10 drops per minute is permissible).</b>	Loose fittings.	Check that all fittings are tight.
	Thermal protection device has been activated.	Thermal protection device will automatically reset.
	Water seals are damaged or worn.	Call service center.
<b>Oil Drip.</b>	Oil seals are damaged or worn.	Call service center.

11

**In USA Call:**  
**1-800-537-4129**  
 or visit our website: [www.karcher-usa.com](http://www.karcher-usa.com)

If you encounter any additional difficulties not listed, please call our service center for help.

## Free Manuals Download Website

<http://myh66.com>

<http://usermanuals.us>

<http://www.somanuals.com>

<http://www.4manuals.cc>

<http://www.manual-lib.com>

<http://www.404manual.com>

<http://www.luxmanual.com>

<http://aubethermostatmanual.com>

Golf course search by state

<http://golfingnear.com>

Email search by domain

<http://emailbydomain.com>

Auto manuals search

<http://auto.somanuals.com>

TV manuals search

<http://tv.somanuals.com>