

English

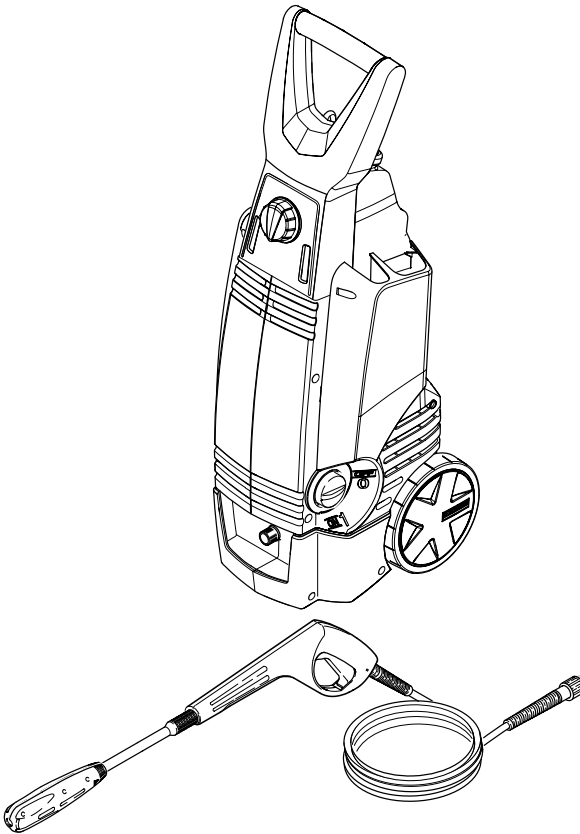

Please keep the original box, packaging and receipt. Before operating this unit, please read this manual thoroughly and retain it for future reference.

HIGH PRESSURE WASHER OPERATOR MANUAL

Overview	3
Important Safety Instructions	4-5
Assembly Instructions	6
Operating Instructions	7
Using the Accessories	8
Working with Detergents	9
Shut Down	10
Taking a Break	10
Winterizing and Long-Term Storage	11
Care and Maintenance Instructions	11
Cleaning Tips	12-13
Optional Cleaning Accessories	13
Troubleshooting	14-15

Specifications

Operating pressure	10500 kPa
Water volume	1.4 GPM
Amp draw	13 AMPS
Voltage	120 V
Part No.	1.630-202.0
Serial no.	

Kärcher Customer Service CDN

Call: 1-800-465-4980 for help or visit our website: www.karcher.ca

KÄRCHER 2 YEAR WARRANTY

KÄRCHER CANADA INC. warrants to the original owner that this product shall be free from defects in material and workmanship for **two years** from the date of its original purchase. If such a defect appears during the warranty period, upon presentation of proof of purchase, KÄRCHER CANADA INC.

will repair or replace (at its option) your product without charge.

This warranty does not cover accidental damage, unreasonable use, normal wear and tear, loss of use or other consequential damages, nor does it cover repairs made or attempted by unauthorized persons.

Trigger gun, hose, spray wands and other accessories are warranted for **3 months**.

Please note that no returns will be accepted without prior authorization from our customer service department.

It is the owner's responsibility to file claims for damage caused by public transportation carriers directly with the carrier concerned.

Safety Alert Symbols

DANGER

indifies "an imminently hazardous situation which, if not avoided, will result in death or serious injury."

WARNING

indifies "a potentially hazardous situation which, if not avoided, could result in death or injury."

CAUTION

indifies "a potentially hazardous situation which, if not avoided, may result in minor or moderate injury" or in property damage incidents.

MODEL OVERVIEW

Description of Items

- 1 Power cord
- 2 High pressure outlet
- 3 ON/OFF switch
- 4 Water inlet and filter inlet with garden hose connector (not shown)
- 5 Detergent tank (removable)
- 6 Detergent suction tube with cap
- 7 Transport handle
- 8 Accessory compartment
- 9 High pressure hose
- 10 Trigger gun

- 11 Trigger gun safety lock
- 12 Quattro nozzle
- 13 Detergent dosing valve

⚠ CAUTION

Follow the maintenance instructions specified in the manual

This machine has been designed for use with cleaning detergents by the manufacturer. The use of other cleaning detergents may affect the operation of the machine and void the warranty.

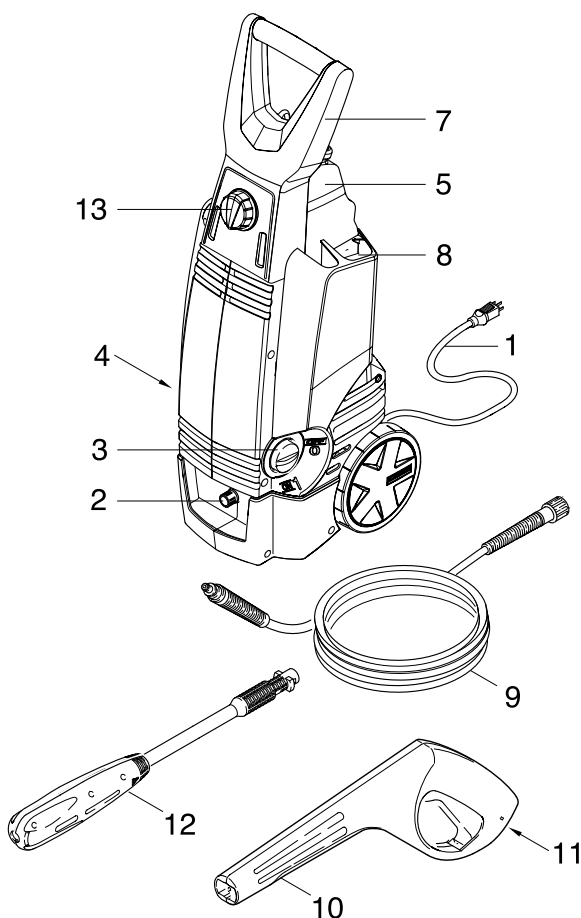

For household use only !

IMPORTANT SAFETY INSTRUCTIONS



WARNING!

When using this product basic precautions should always be followed, including the following:

- Read all the instructions before using the product.
- To reduce the risk of injury, close supervision is necessary when a product is used near children.
- Know how to stop the product and bleed pressures quickly. Be thoroughly familiar with the controls.
- Stay alert — watch what you are doing.
- Do not operate the product when fatigued or under the influence of alcohol or drugs.
- Keep operating area clear of all persons.
- Do not overreach or stand on unstable support. Keep good footing and balance at all times.
- Follow the maintenance instructions specified in the manual.
- Risk of Injection or Injury to persons - Do not direct discharge stream at persons.
- High pressure jets can be dangerous if subject to misuse. The jet must not be directed at persons, animals, electrical devices, or the machine itself.
- Wear safety goggles.
- Do not use acids and solvents in this product. These products can cause physical injuries to the operator and irreversible damage to the machine.
- To reduce the risk of electrocution, keep all connections dry and off the ground.
- Do not touch plug with wet hands.

- The Trigger Gun Safety Lock PREVENTS the trigger from accidentally being engaged. This safety feature DOES NOT lock trigger in the ON position.

WARNING

Do not spray electrical apparatus and wiring.

Do not use with flammable liquids and toxic chemicals.

Injection hazard: equipment can cause serious injury if the spray penetrates the skin. do not point the gun at anyone or any part of the body. In case of penetration seek medical aid immediately.

This system is capable of producing 10500 kPa to avoid rupture and injury, do not operate this pump with components rated less than 10500 kPa working pressure (including but not limited to spray guns, hose and hose connections).

Before servicing, cleaning or removing any parts, shut off power and relieve pressure.

Grounding Instructions

This product must be grounded. If it should malfunction or breakdown, grounding provides a path of least resistance for electric current to reduce the risk of electric shock. This product is equipped with a cord having an equipment-grounding conductor and a grounding plug. The plug must be plugged into an appropriate outlet that is properly installed and grounded in accordance with all local codes and ordinances.

DANGER

Improper connection of the equipment-grounding conductor can result in a risk

of electrocution. Check with a qualified electrician or service personnel if you are in doubt as to whether the outlet is properly grounded. Do not modify the plug provided with the product - if it will not fit the outlet, have a proper outlet installed by a qualified electrician. Do not use any type of adapter with this product.

Extension Cords

- Use only 3-wire extension cords that have 3-prong grounding-type plugs and 3-pole cord connectors that accept the plug from the product.
Up to 25 ft = 12/3 AWG;
25 to 50 ft = 10/3 AWG.
- Use only extension cords that are intended for outdoor use. These extension cords are identified by the marking "Acceptable for use with outdoor appliances; store indoors while not in use."
- Use only extension cords having an electrical rating not less than the rating of the product.
- Do not use damaged extension cords.
- Examine extension cord before using and replace if damaged.
- Do not abuse extension cord and do not yank on any cord to disconnect.
- Keep cord away from heat and sharp edges.
- Always disconnect the extension cord from the receptacle before disconnecting the product from the extension cord.
- If you are using an extension cord, it should always be completely unwound from the cable drum.

⚠ WARNING

To reduce the risk of electrocution, keep all connections dry and off the ground. Do not touch plug with wet hands.

WATER SUPPLY (Cold Water Only)

⚠ CAUTION

Dirt in the feed water will damage the unit. To avoid this risk, we recommend fitting a water filter.

- Water hose must be at least 1/2 inch or 5/8 inch in diameter.
- Flow rate of water supply must not fall below 2 GPM (gallons per minute).
- Flow rate can be determined by running the water for one minute into an empty 5-gallon container.
- The water supply temperature must not exceed 104°F/40°C.
- Never use the pressure washer to draw in water contaminated with solvents, e.g. paint thinners, gasoline, oil, etc.
- Always prevent debris from being drawn into the unit by using a clean water source.

SAVE THESE INSTRUCTIONS !

ASSEMBLY INSTRUCTIONS

→ **STEP 1:** Mount cover and secure with 2 screws.

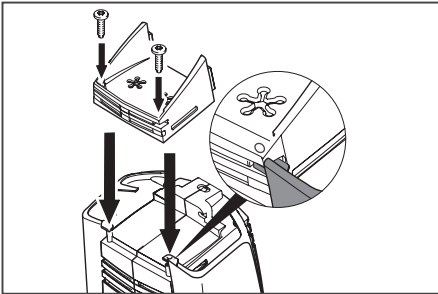

→ **STEP 2:** Attach the handle and secure with 4 screws.

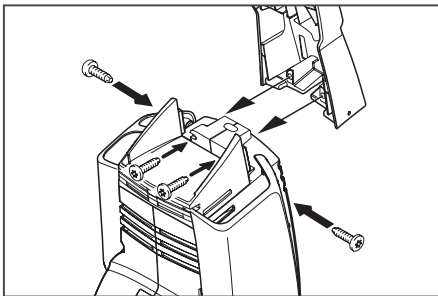

→ **STEP 3:** Attach detergent suction tube to the detergent dosing valve.

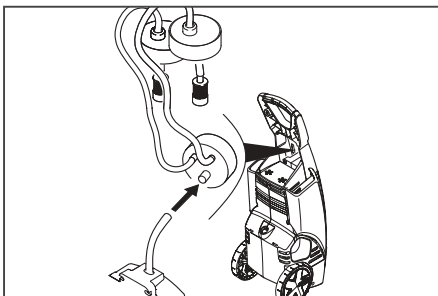

→ **STEP 4:** Place detergent tank into compartment.

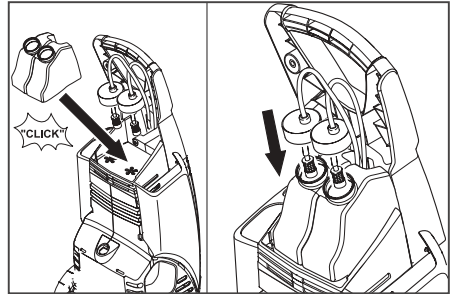

→ **STEP 5:** Attach the high pressure hose to the trigger gun. Pull out the locking slide from the right side of the trigger gun handle (A), and insert the small end of the high pressure hose into place (B). Push the locking slide back into the trigger gun (C) to lock the hose in position (D).

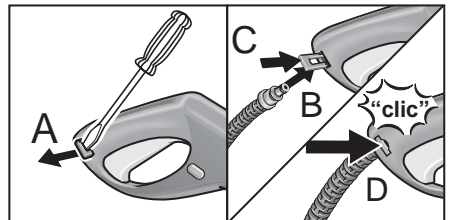

OPERATING INSTRUCTIONS

→ **STEP 1:** Connect the high pressure hose to the unit's high pressure outlet.

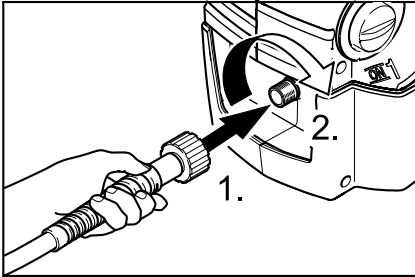

→ **STEP 2:** Insert the spray wand to the trigger gun. Press in against the spring tension and twist into locked position.

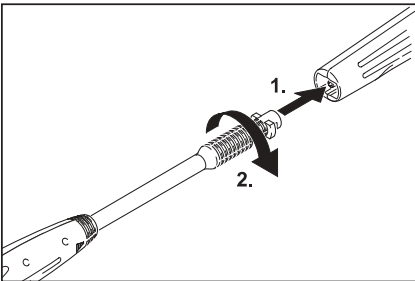

→ **STEP 3:** Connect garden hose to unit's water inlet.

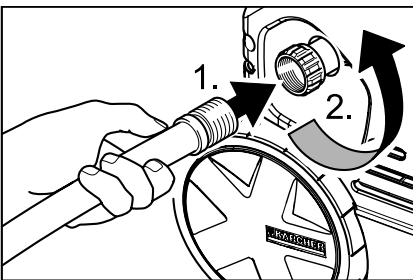

→ **STEP 4:** Connect garden hose to the cold water source and turn water on completely. Plug the power cord into the power outlet.

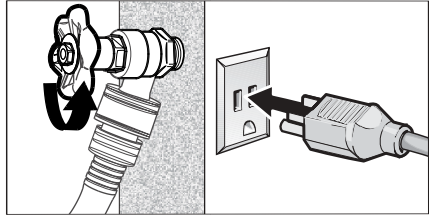

→ **STEP 5:** Unlock the Safety lock (A). Trigger the gun (B) to eliminate trapped air, wait for a steady flow of water to emerge from the spray nozzle.

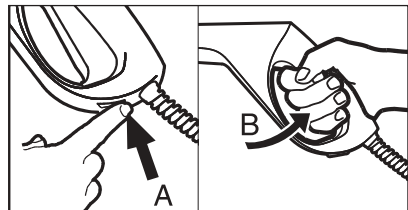

→ **STEP 6:** Turn on the high pressure washer (I).

The motor starts only if the trigger of the gun is pulled and shuts off when the trigger is released.

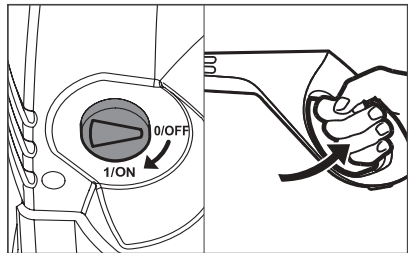

USING THE ACCESSORIES

⚠ WARNING

To avoid serious injury never point spray nozzle at yourself, other persons or animals.



Quattro Nozzle

Selecting the jet

- Release the trigger of the handgun.
- Rotate the nozzle head until the symbol is aligned with the marking on the spray lance.

Note: The marking on the spray lance must be up during operation.



High pressure pencil jet cleaning



High pressure fan jet cleaning



Rotating jet for maximum dirt cutting action



Low pressure fan jet for detergent injection

WORKING WITH DETERGENTS

Detergents can only be applied at low pressure (Min).

- Turn Quattro Nozzle to Low pressure position .
- **STEP 2:** Fill the Detergent Tank with the selected Ready To Use detergent.

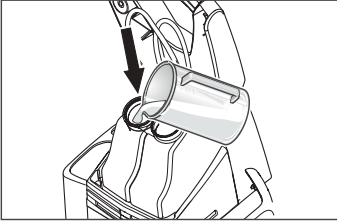

- **STEP 3:** Adjust the detergent dosing valve.

Turn to the left:

Meter detergent from container 1

Turn to the right:

Meter detergent from container 2

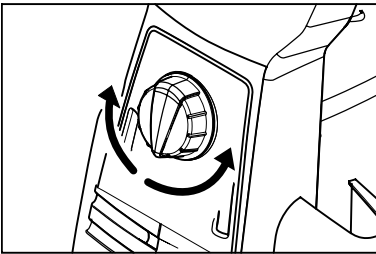

- **STEP 4:** Turn on the pressure washer (1). Pull trigger to operate unit: Liquid detergent is drawn into the unit and mixed with water. Apply detergent to work area. Do not allow detergent to dry on surface.

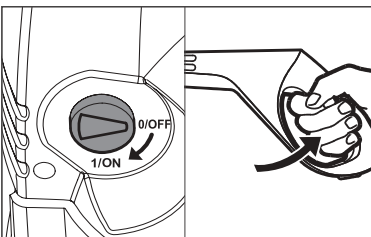

For best results see Cleaning Tips on pages 12 & 13 for specific information on how to clean different surfaces.

Always Use Kärcher Detergent for Best Results

Kärcher biodegradable detergents are specially formulated to protect the environment and your pressure washer. Special formula won't clog the suction tube filter and will protect the internal parts of the pressure washer for a longer life. For Kärcher Detergents, check your retailer or call our service center for help.

The following Kärcher detergents are available:

- Pressure wash
- Deck + Fence wash
- Degreaser
- Vehicle wash

⚠ CAUTION

Never use:

- Bleach, Chlorine products and other corrosive chemicals
- Liquids containing solvents (i.e., paint thinners, gasoline, oils)
- Tri-sodium phosphate products
- Ammonia products
- Acid-based products

These chemicals will harm the unit and will damage the surface being cleaned.

SHUTTING DOWN

STEP 1: Turn the switch to OFF (0) position and unplug cord from outlet.

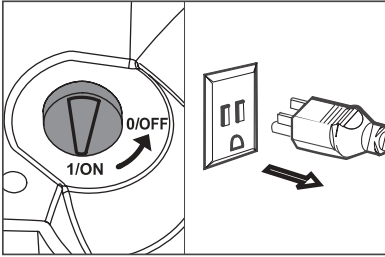

STEP 5: Disconnect the high pressure hose from the high pressure outlet.

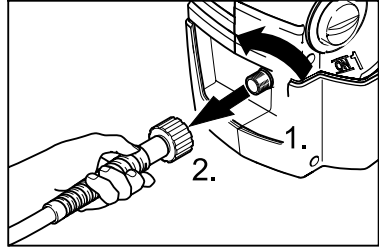

STEP 2: Turn off the water source.

STEP 3: Press trigger to release water pressure.

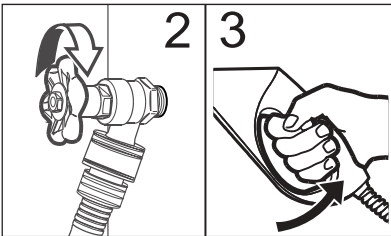

STEP 6: Release trigger (A) and engage gun safety lock (B).

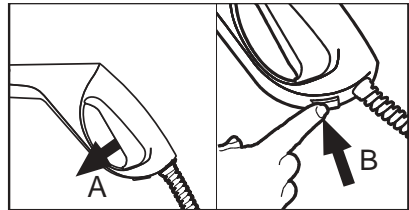

STEP 4: Disconnect the garden hose from the water inlet on the unit..

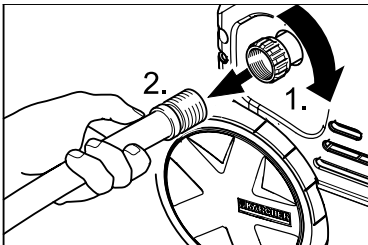

TAKING A BREAK ..five minutes or more

STEP 1: Release trigger (A) and engage gun safety lock (B).

STEP 2: Turn pressure washer to off (O) position.

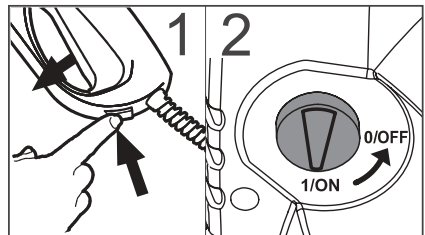

WINTERIZING AND LONG-TERM STORAGE

- **1:** Disconnect all water connections.
- **2:** Turn on the machine for a few seconds, until the water which had remained in the pump exits, turn off immediately.
- **3:** Do not allow high pressure hose to become kinked.
- **4:** Store the machine and accessories in a room which does not reach

freezing temperatures. DO NOT store near furnace or other sources of heat as it may dry out the pump seals.

⚠ CAUTION

Failure to follow the above directions will result in damage to the pump assembly and accessories.

CARE AND MAINTENANCE INSTRUCTIONS

Cleaning the water inlet filter

Pull out the water inlet filter with flat-nose pliers and rinse out in warm water.

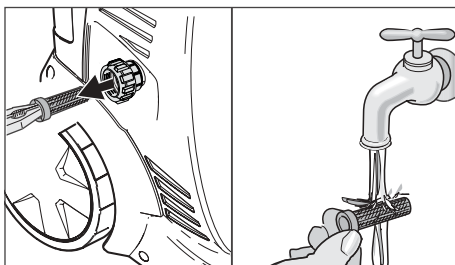

Maintenance

The unit is maintenance-free.

Cleaning the detergent inlet filter

Pull it out and rinse out in warm water.

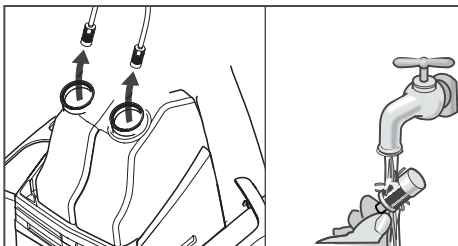

CLEANING TIPS

Deck Cleaning

(with or without detergent). Pre-rinse deck and surrounding area with fresh water. If using Kärcher Deck Wash, apply to surface at low pressure. For best results, limit your work area to smaller sections of approximately 25 square feet. Allow Deck Wash to remain on surface 1-3 minutes. Do not allow detergent to dry on surface. Rinse at high pressure in a long sweeping motion keeping the spray nozzle approximately 3-6 inches from the cleaning surface. Always clean from top to bottom and from left to right. When moving on to a new section of the cleaning surface, be sure to overlap the previous section to eliminate stop marks and ensure a more even cleaning result.

⚠ CAUTION

Do not use rotating jet on wood surfaces as it may cause damage.

House Siding

(with or without detergent). Pre-rinse cleaning surface with fresh water. If using Kärcher Pressure Wash, apply to surface at low pressure (for best results, limit your work area to sections of approximately 6 feet and always apply detergent from bottom to top). Allow Pressure Wash to remain on surface 1-3 minutes. Do not allow detergent to dry on surface, if surface appears to be drying, simply wet down surface with fresh water. If needed, use special wash brush attachment to remove stubborn dirt. Rinse at high pressure from top to bottom in an even sweeping motion

keeping the spray nozzle approximately 6 inches from the cleaning surface.

⚠ CAUTION

Do not use rotating jet on siding as it may cause damage.

Cement Patios, Brick and Stone

(with or without detergent). Pre-rinse cleaning surface with fresh water. If using Kärcher Pressure Wash or Degreaser, apply to surface at low pressure. For best results, limit your work area to smaller sections of approximately 25 square feet. Allow Pressure Wash or Degreaser to remain on surface 1-3 minutes. Do not allow detergent to dry on surface. Rinse at high pressure in a sweeping motion keeping the spray nozzle approximately 3-6 inches from the cleaning surface. Always clean from top to bottom and from left to right. For removing extremely stubborn stains, use the rotating jet.

Cars, Boats & Motorcycles

(with or without detergent). Pre-rinse vehicle with fresh water. If using Kärcher Vehicle Wash, apply to surface at low pressure. For best results, clean one side of vehicle at a time and always apply detergent from bottom to top, do not allow detergent to dry on surface. If needed, use special wash brush attachment to remove stubborn dirt. Rinse at high pressure in a sweeping motion keeping the spray nozzle approximately 6-8 inches from the cleaning surface (distance should increase when rinsing pin-striping or other sensitive surfaces). Always clean from top to bottom and

from left to right. For best results, wipe surface dry with a chamois or soft dry cloth.

⚠ CAUTION

Do not use rotating jet on vehicles as it may cause damage.

Barbecue Grills, Outdoor Power Equipment & Gardening Tools

(with or without detergent). Pre-rinse cleaning surface with fresh water. If using Kärcher Pressure Wash or Degreaser, apply detergent at low pressure. Allow Pressure Wash to remain on surface 1-3 minutes. Do not allow detergent to dry on surface. Rinse at high pressure keeping the spray nozzle approximately 3-6 inches from the cleaning surface. For removing extremely stubborn dirt, it may be necessary to move the spray nozzle even closer to the surface for greater dirt cutting action.

⚠ CAUTION

Do not use rotating jet on cloth, plastic or other sensitive surfaces as it may cause damage.

Patio & Lawn Furniture

(with or without detergent). Pre-rinse furniture and surrounding area with fresh water. If using Pressure Wash, apply to surface at low pressure. Allow Pressure Wash to remain on surface 1-3 minutes. Do not allow detergent to dry on surface. If needed use special Wash Brush Attachment to remove stubborn dirt. Rinse at high pressure in a sweeping motion keeping the spray nozzle approximately 3-6 inches from the cleaning surface. For best results, clean from top to bottom and from left to right.

⚠ CAUTION

Do not use rotating jet on patio or lawn furniture as it may cause damage.

Recommendations

- Before cleaning any surface an inconspicuous area should be cleaned to test spray pattern and distance for maximum cleaning results.
- If painted surfaces are peeling or chipping, use extreme caution as pressure washer may remove the loose paint from the surface.
- When using on surfaces which might come in contact with food, flush surfaces with plenty of drinking water.

OPTIONAL CLEANING ACCESSORIES

Optional cleaning accessories are available to further enhance your cleaning capabilities: For details call 1-800-465-4980 or visit www.karcher.ca.

- Rotating Wash Brush
- Wash Brush
- Underbody Wand
- Pipe Drain Cleaner

- Sandblasting Attachment
- Extension Wand
- Water Siphon Kit
- 25 Ft. Extension Hose
- T-Racer

TROUBLESHOOTING

⚠ CAUTION

Disconnect the machine from the power source before making any repair.

Symptom	Cause	Solution
Motor will not start	On/Off switch is in the "OFF" (O) position.	Turn switch to the "ON" (I) position
	Power cord is not plugged in.	Plug in power cord.
	Extension cord is too long.	Replace extension cord with either a 25 ft. 12/3 gauge cord or a 50 ft. 10/3 gauge cord.
	Extension cord is not proper gauge.	
	Extension cord is damaged.	
Electrical outlet does not supply adequate power.	Try a different outlet.	
Unit does not reach high pressure.	Diameter of garden hose is too small.	Replace with a 1/2 inch or 5/8 inch garden hose.
	Water supply is restricted.	Check garden hose for kinks, leaks and blockage.
	Not enough inlet water supply.	Open water source full force.
	Water inlet filter is clogged.	Remove filter and rinse out in warm water.
	Spray wand is in low pressure position.	Turn spray wand to high pressure position.
Output pressure varies high and low.	Not enough inlet water supply.	Turn water on full force. Check garden hose for kinks, leaks or blockage.
	Pump is sucking air.	Check that hoses and fittings are air tight. Turn off machine and purge pump by squeezing trigger gun until a steady flow of water emerges through the nozzle.
	Water inlet filter is clogged.	Remove filter and rinse out in warm water.
	Discharge nozzle is obstructed.	Blow out or remove debris with a fine needle.
	Calcified gun, hose or spray wand.	Run distilled vinegar through detergent suction tube.

Symptom	Cause	Solution
No detergent.	Detergent suction tube not properly connected to the machine.	Check connection.
	Detergent is too thick.	Dilute detergent, for best results use Kärcher detergent.
	Filter on detergent suction tube is clogged.	Run warm water through filter to remove debris.
	Damaged or clogged detergent suction tube.	Remove obstruction or replace detergent suction tube.
	Spray wand is in high pressure position.	Turn spray wand tip to low pressure position.
	Discharge nozzle is obstructed.	Blow out or remove debris with fine needle.
Garden hose connection leaks.	Loose fittings.	Tighten fittings.
	Missing/worn rubber washer.	Insert new washer.
Spray wand leaks.	Spray wand not properly attached.	Insert the spray wand into the trigger gun. Carefully press in against the spring tension and twist into the locked position.
	Broken o-ring or plastic insert.	Call Customer Service.
Pump is noisy.	Pump is sucking air.	Check that hoses and fittings are air tight. Turn off machine and purge pump by squeezing trigger gun until a steady flow of water emerges through the nozzle.
Water leaks from pump (up to 10 drops per minute is permissible).	Loose fittings.	Check that all fittings are tight.
	Water seals are damaged or worn.	Call Customer Service.
Oil Drip.	Oil seals are damaged or worn.	Call Customer Service.

Kärcher Customer Service CDN

Call: 1-800-465-4980 for help or visit our website: www.karcher.ca

If you encounter any additional difficulties not listed, please call for help.

Kärcher Customer Service CDN

Call: 1-800-465-4980 for help or visit
our website: **www.karcher.ca**

Free Manuals Download Website

<http://myh66.com>

<http://usermanuals.us>

<http://www.somanuals.com>

<http://www.4manuals.cc>

<http://www.manual-lib.com>

<http://www.404manual.com>

<http://www.luxmanual.com>

<http://aubethermostatmanual.com>

Golf course search by state

<http://golfingnear.com>

Email search by domain

<http://emailbydomain.com>

Auto manuals search

<http://auto.somanuals.com>

TV manuals search

<http://tv.somanuals.com>