



Model K 7000 G

Part No. 1.187-104.0

High Pressure Washer Operator Manual

- Overview1
- Precautions1-2
- Assembly Instructions3
- Operating Instructions4-5
- Using the Accessories5
- Working with Detergents6
- Shut Down and Clean-Up7
- Taking a Break7
- Winterizing and Long-Term Storage7
- Cleaning Tips8-9
- Optional Cleaning Accessories9
- Troubleshooting10-11

Specifications

Operating pressure	2500 PSI
Water volume	2.7 GPM
Engine	6.5 HP Briggs & Stratton Intek

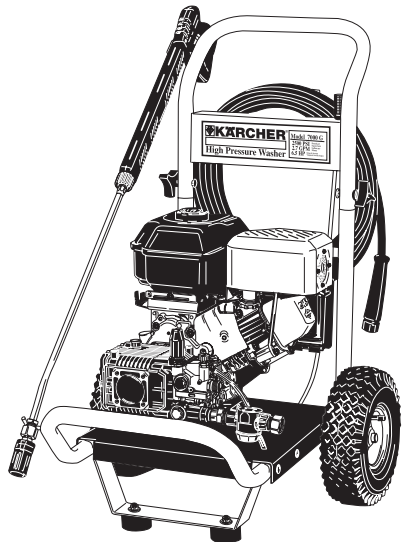

MODEL K 7000 G OVERVIEW

Item Description

1. High pressure outlet
2. Water inlet
3. Oil fill cap
4. Pull start (not pictured)
5. Detergent suction tube
6. Knob Assembly (two each):
Bolt
Knob
7. High pressure hose
8. Detergent filter
9. Handle
10. Trigger gun safety lock
11. Trigger gun
12. Gas tank
13. Pressure control
14. Detergent dosage control
15. Triple jet nozzle

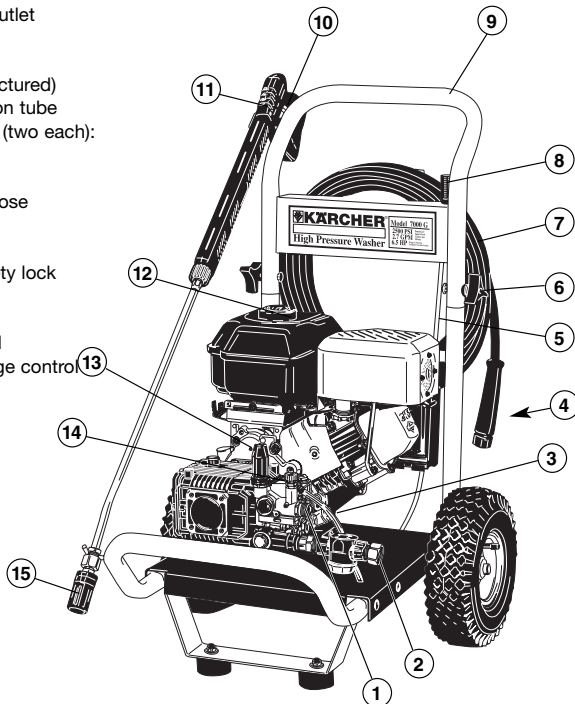

NEVER!

- Never** point nozzle at people or animals.
- Never** drink alcohol or use drugs while operating this equipment.
- Never** spray electrical connections, electrical outlets or fixtures.
- Never** add fuel with the engine running or operate where fuel has been spilled.
- Never** touch hot surfaces or allow accessories to contact hot surfaces.
- Never** operate in an enclosed space, exhaust fumes are dangerous.
- Never** operate near utilities with open flames.
- Never** operate without the water turned on and never use hot water.

IMPORTANT PRECAUTIONS – Read First!

! Safety Warnings

When using this product basic precautions should always be followed:

- Read all the instructions before using the product.
- **FIRE HAZARD!** Do not add fuel with the engine running. Do not operate if fuel has been spilled. Instead move the machine to a different location and avoid creating sparks.
- Operate and fuel machine in a well ventilated area, free of devices featuring an open pilot or flame such as boilers, water heaters, etc.
- High pressure jets can be dangerous if subject to misuse. The jet must not be directed at persons, animals, electrical devices, or the machine itself.
- Wear safety goggles.
- Do not use acids, solvents, or any other flammable material in this product. These products can cause physical injuries to the operator and irreversible damage to the machine.
- The machine has hot surfaces which can cause burns. Operate the unit in a safe environment and away from children.
- Do not allow the high pressure hose to come into contact with the muffler guard.
- Do not leave the machine running unattended.
- Learn how to stop the machine and release pressure quickly. Be thoroughly familiar with the controls.
- Stay alert — watch what you are doing.
- Do not operate the product when fatigued or under the influence of alcohol or drugs.
- Do not stand on unstable surfaces. Stand with both feet balanced at all times.
- The Gun Safety Lock PREVENTS the trigger from accidentally being engaged. This safety feature DOES NOT lock trigger in the on position.

Water Supply (Cold Water Only)

- Water hose must be at least 3/4 inch in diameter.
- Flow rate of water supply must not fall below 2.5 GPM (gallons per minute).
- Flow rate can be determined by running the water for one minute into an empty 5-gallon container.
- The water supply temperature must not exceed 104°F/40°C.
- Never use the pressure washer to draw in water contaminated with solvents, e.g. paint thinners, gasoline, oil, etc.
- Always prevent debris from being drawn into the unit by using a clean water source.

We strongly recommend that this high pressure washer not be left running for periods of 5 minutes or longer without the trigger gun being engaged.

This Kärcher high pressure washer is equipped with thermal protection to extend the life of your pressure washer. The thermal protector will automatically activate at a predetermined high temperature ejecting hot water before resetting. This ensures that the pump does not become damaged.

! Caution

- Follow the maintenance instructions specified in the manual.
- This machine has been designed for use with cleaning detergent supplied or recommended by the manufacturer. The use of other cleaning detergents may affect the operation of the machine and void the warranty.

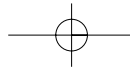

ASSEMBLY INSTRUCTIONS

Tools required. adjustable pliers.

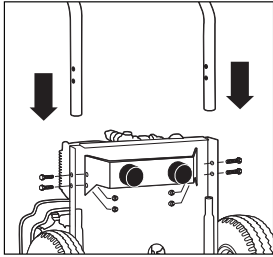

Step 1 Tilt machine backwards slightly (**caution:** oil may leak if tilted too far). Attach the front guard to the frame. Align holes, insert bolt and tighten with lock nut.

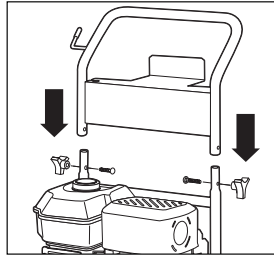

Step 2 Attach the handle to the frame of the pressure washer. Align holes, insert bolt, and tighten with knob.

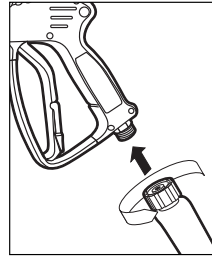

Step 3 Attach high pressure hose to trigger gun.

3

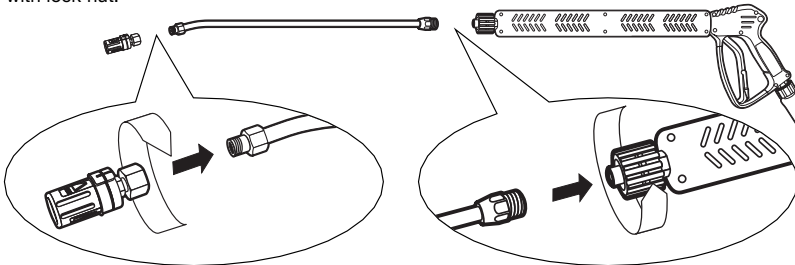

Step 4 Attach the triple jet nozzle to the spray wand.

Step 5 Attach the spray wand to the trigger gun.

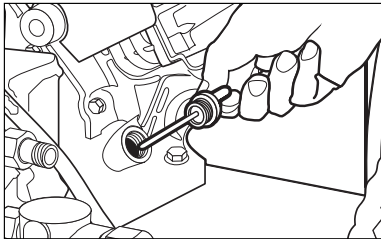

Step 6 Check oil level. Oil level should be to the oil filler neck. Be sure the machine is level when checking the oil level. (Refer to the engine's operating manual for seasonal grades.)

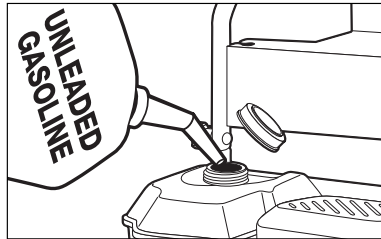

Step 7 Fill gas tank with unleaded gasoline. Do not use leaded gasoline.

Important! Do not run the engine with a high or low oil level as this can cause engine damage. If you have further questions regarding the engine, please refer to the engine's operating manual included with the unit.

OPERATING INSTRUCTIONS

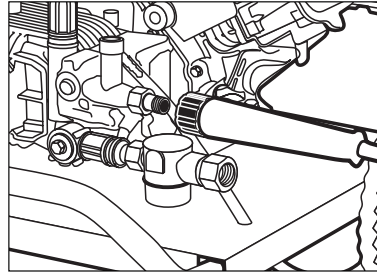

Step 1 Connect the high pressure hose to the unit's high pressure outlet.

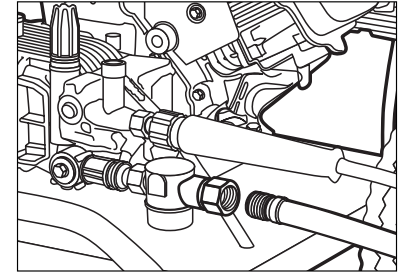

Step 2 Connect garden hose to unit's water inlet.

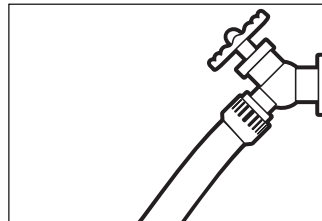

Step 3 Connect garden hose to the cold water source and turn water on completely.

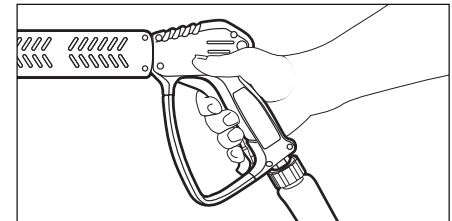

Step 4 Trigger the gun to eliminate trapped air, wait for a steady flow of water to emerge from the spray nozzle.

4

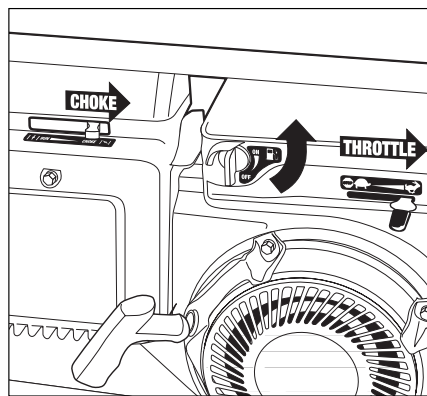

Step 5 Slide the throttle control to the fast position. Move the choke lever to the "CHOKE" position (only if the engine is cool). After starting, move the choke to "RUN". Turn fuel valve to "ON".

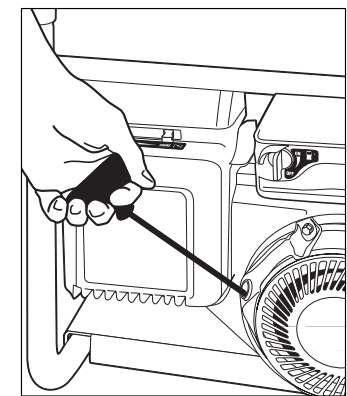

Step 6 Pull the starter handle. If the engine fails to start after 3 pulls squeeze the trigger gun to release pressure, and repeat step 6.



OPERATING INSTRUCTIONS - continued

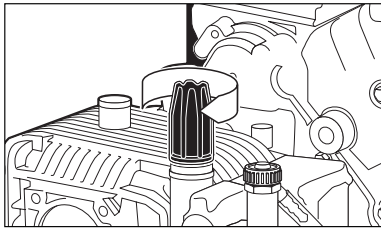

Step 7 Adjust pressure control to desired setting.

USING THE ACCESSORIES

The triple jet nozzle must be positioned to one of the two settings for high pressure cleaning by turning the nozzle tip. The pencil jet spray (0°) should be used for stubborn dirt. The High pressure flat spray (25°) should be used for cleaning over a large surface area. The third setting on the triple jet nozzle is used for the application of detergents.

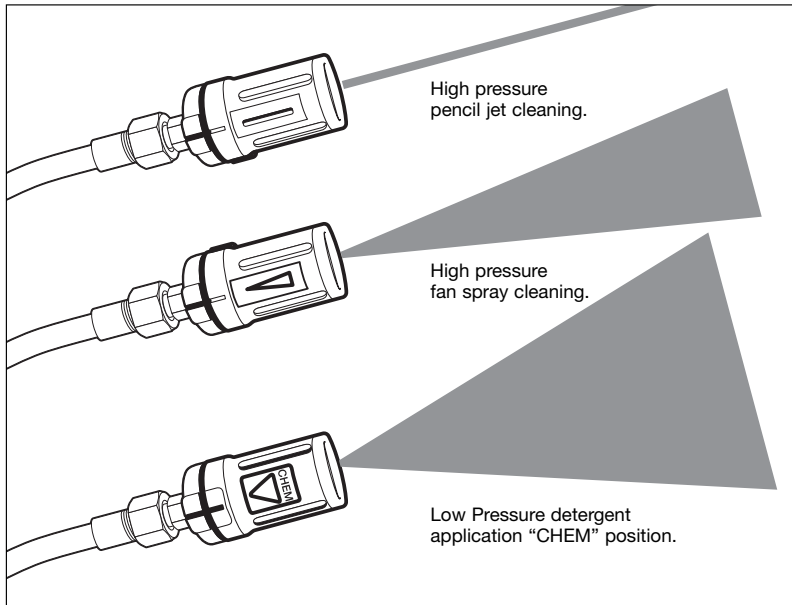

5

! WARNING TO AVOID SERIOUS INJURY, NEVER POINT SPRAY NOZZLE AT YOURSELF, OTHER PERSONS OR ANIMALS

WORKING WITH DETERGENT

Detergents can only be applied in the "CHEM" setting.

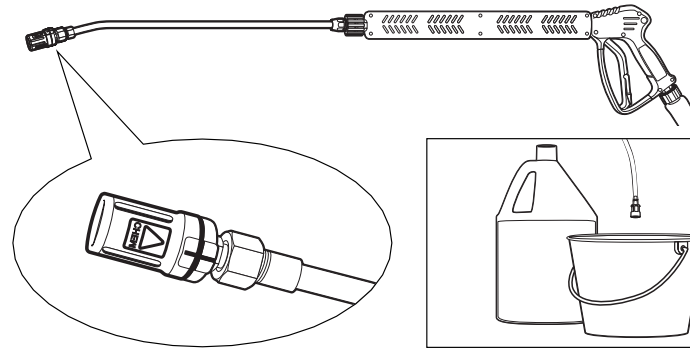

Step 1 To apply detergents the triple jet nozzle must be set to the "CHEM" position.

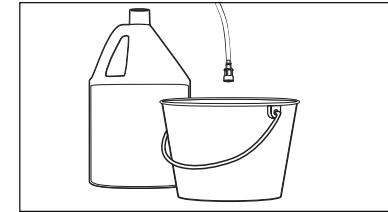

Step 2 Fill a container with Karcher detergent. Place the filter end of detergent suction tube into the container.

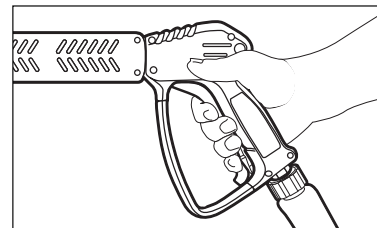

Step 3 With the engine running, pull trigger to operate unit: Liquid detergent is drawn into the unit and mixed with water. Apply detergent to work area. Do not allow detergent to dry on surface.

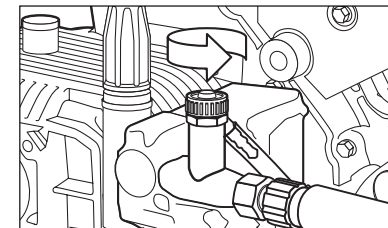

6

Step 4 Adjust detergent level.

For best results see Cleaning Tips on pages 8 & 9 for specific information on how to clean different surfaces.



Caution Never use:

- Bleach, Chlorine products and other corrosive chemicals
- Liquids containing solvents (i.e., paint thinners, gasoline, oils)
- Tri-sodium phosphate products
- Ammonia products
- Acid-based products

These chemicals will harm the unit and will damage the surface being cleaned.

Always Use Karcher Detergents for Best Results.

Karcher biodegradable detergents are specially formulated to protect the environment and your pressure washer. Special formula won't clog the suction tube filter and will protect the internal parts of the pressure washer for a longer life. For Karcher Detergents, check your retailer or call:

1-800-537-4129

The following Karcher detergents are available:

- Vehicle Wash
- House Wash
- Degreaser
- Deck Wash
- All Purpose Cleaner

SHUTTING DOWN & CLEAN-UP

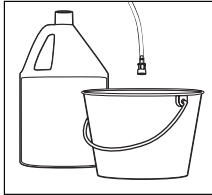

Step 1 Remove detergent suction tube from container and insert into one gallon of fresh water. Siphon water at low pressure for one minute.

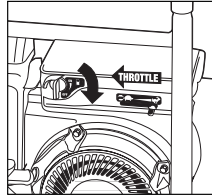

Step 2 Turn off the engine.

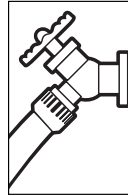

Step 3 Turn off the water source.

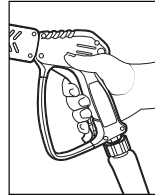

Step 4 Press trigger to release water pressure.

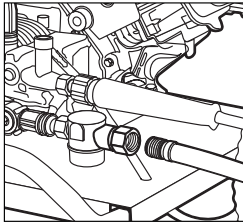

Step 5 Disconnect the garden hose from the water inlet on the unit.

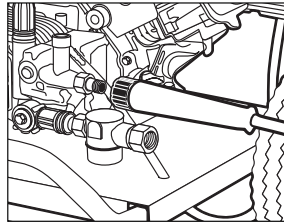

Step 6 Disconnect the high pressure hose from the high pressure outlet and engage the gun safety lock.

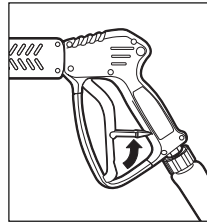

TAKING A BREAK... five minutes or more

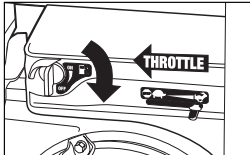

Step 1 Turn off the engine.

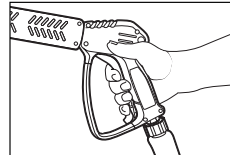

Step 2 Press trigger to release water pressure.

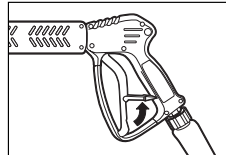

Step 3 Engage gun safety lock.

WINTERIZING AND LONG-TERM STORAGE

1. Disconnect all water connections.
2. Start the machine for a **few seconds**, until the water which had remained in the pump exits. Turn off immediately.
3. Drain the gas and oil from the engine.
4. Do not allow high pressure hose to become kinked.

5. Store the machine and accessories in a room which does not reach freezing temperatures. The machine should not be placed near an open flame i.e. furnace, hot water heater etc.

Caution: Failure to follow the above directions will result in damage to the pump assembly and accessories.

CLEANING TIPS

Deck Cleaning (with or without detergent)

Pre-rinse deck and surrounding area with fresh water. If using Kärcher Deck Wash, place detergent suction tube directly into cleaning solution and apply to surface at low pressure. For best results, limit your work area to smaller sections of approximately 25 square feet. Allow Kärcher Deck Wash to remain on surface 1-3 minutes. Do not allow detergent to dry on surface. Rinse at high pressure in a long sweeping motion keeping the spray nozzle approximately 6 inches from the cleaning surface. Always clean from top to bottom and from left to right. When moving on to a new section of the cleaning surface, be sure to overlap the previous section to eliminate stop marks and ensure a more even cleaning result.

House Siding (with or without detergent)

Pre-rinse cleaning surface with fresh water. If using Kärcher House Wash, place detergent suction tube directly into cleaning solution and apply to surface at low pressure (for best results, limit your work area to sections of approximately 6 feet and always apply detergent from bottom to top). Allow Kärcher House Wash to remain on surface 1-3 minutes. Do not allow detergent to dry on surface, if surface appears to be drying, simply wet down surface with fresh water. Rinse at high pressure from top to bottom in an even sweeping motion keeping the spray nozzle approximately 6 inches from the cleaning surface.

Cement Patios, Brick and Stone (with or without detergent)

Pre-rinse cleaning surface with fresh water. If using Kärcher All Purpose Cleaner, place detergent suction tube directly into cleaning solution and apply to surface at low pressure. For best results, limit your work area to smaller sections of approximately 25 square feet. Allow Kärcher All Purpose Cleaner to remain on surface 1-3 minutes. Do not allow detergent to dry on surface. Rinse at high pressure in a sweeping motion keeping the spray nozzle approximately 3-6 inches from the cleaning surface. Always clean from top to bottom and from left to right.

Cars, Boats & Motorcycles (with or without detergent)

Pre-rinse vehicle with fresh water. If using Kärcher Vehicle Wash, place detergent suction tube directly into cleaning solution and apply to surface at low pressure. For best results, clean one side of vehicle at a time and always apply detergent from bottom to top, do not allow detergent to dry on surface. Rinse at high pressure in a sweeping motion keeping the spray nozzle approximately 8 inches from the cleaning surface (distance should increase when rinsing pin-striping or other sensitive surfaces). Always clean from top to bottom and from left to right. For best results, wipe surface dry with a chamois or soft dry cloth.

CLEANING TIPS - continued**Barbecue Grills, Outdoor Power Equipment & Gardening Tools (with or without detergent)**

Pre-rinse cleaning surface with fresh water. If using Kärcher All Purpose Cleaner or Degreaser, place detergent suction tube directly into cleaning solution and apply detergent at low pressure. Allow Kärcher detergent to remain on surface 1-3 minutes. Do not allow detergent to dry on surface. Rinse at high pressure keeping the spray nozzle approximately 6 inches from the cleaning surface. For removing extremely stubborn dirt, it may be necessary to move the spray nozzle even closer to the surface for greater dirt cutting action.

Patio & Lawn Furniture (with or without detergent)

Pre-rinse furniture and surrounding area with fresh water. If using Kärcher All Purpose Cleaner, place detergent suction tube directly into cleaning solution and apply to surface at low pressure. Allow Kärcher All Purpose Cleaner to remain on surface 1-3 minutes. Do not allow detergent to dry on surface. Rinse at high pressure in a sweeping motion keeping the spray nozzle approximately 6 inches from the cleaning surface. For best results, clean from top to bottom and from left to right.

Recommendations

- Before cleaning any surface an inconspicuous area should be cleaned to test spray pattern and distance for maximum cleaning results.
- If painted surfaces are peeling or chipping, use extreme caution as pressure washer may remove the loose paint from the surface.

Use extreme caution when cleaning decks, siding, and other sensitive surfaces as the pencil jet may cause damage if not used correctly.

OPTIONAL CLEANING ACCESSORIES

Optional cleaning accessories are available to further enhance your cleaning capabilities. Call Kärcher customer service hotline (1-800-537-4129) for details.

TROUBLESHOOTING

Symptom	Cause	Solution
Engine will not start	No gasoline.	Fill gas tank.
	Low oil level.	Add oil.
	Choke is not in correct position.	Slide choke lever to "CHOKE" position.
	Engine throttle is not in correct position.	Position the throttle to "FAST".
<i>For additional engine problems refer to the engine owners manual.</i>	Pressure built up in the high pressure washer.	Squeeze the trigger to release the pressure.
Unit does not reach high pressure.	Diameter of garden hose is too small.	Replace with a 3/4 inch garden hose.
	Water supply is restricted.	Check garden hose for kinks, leaks and blockage.
	Not enough inlet water supply.	Open water source full force.
	Water inlet filter is clogged.	Remove filter and rinse out in warm water.
	Nozzle is in "CHEM" position	Turn nozzle to high pressure position.
Output pressure varies high and low.	Not enough inlet water supply.	Turn water on full force. Check garden hose for kinks, leaks or blockage.
	Pump is sucking air.	Check that hoses and fittings are air tight. Turn off machine and purge pump by squeezing trigger gun until a steady flow of water emerges through the nozzle.
	Water inlet filter is clogged.	Remove filter and rinse out in warm water.
	Discharge nozzle is obstructed.	Blow out or remove debris with a fine needle.
	Calcified gun, hose or spray wand.	Run distilled vinegar through detergent suction tube.

TROUBLESHOOTING - continued

Symptom	Cause	Solution
No detergent.	Detergent suction tube not properly connected to the machine.	Check connection.
	Detergent is too thick.	Dilute detergent, for best results use Kärcher detergent.
	Filter on detergent suction tube is clogged.	Run warm water through filter to remove debris.
	Damaged or clogged detergent suction tube.	Remove obstruction or replace detergent suction tube.
	Spray nozzle is in high pressure position.	Turn spray nozzle tip to "CHEM" position.
	Discharge nozzle is obstructed.	Blow out or remove debris with a fine needle.
Garden hose connection leaks.	Loose fitting.	Tighten fittings.
	Missing/worn rubber washer.	Insert new washer.
Triple jet nozzle or Spray wand leaks.	Nozzle or spray wand not properly attached.	Tighten connections
	Broken "o"-ring.	Call Kärcher customer service hotline and order "o"-ring.
Pump is noisy.	Pump is sucking air.	Check that hoses and fittings are air tight. Turn off machine and purge pump by squeezing trigger gun until a steady flow of water emerges through the nozzle.
Water leaks from pump (up to 10 drops per minute is permissible).	Loose fittings.	Check that all fittings are tight.
	Thermal protection device has been activated.	Thermal protection device will automatically reset.
	Water seals are damaged or worn.	Call service center.
Oil Drip.	Oil seals are damaged or worn.	Call service center.

11

If you encounter any additional difficulties not listed, please call our service center for help.

Kärcher Customer Support USA
1-800-537-4129

Free Manuals Download Website

<http://myh66.com>

<http://usermanuals.us>

<http://www.somanuals.com>

<http://www.4manuals.cc>

<http://www.manual-lib.com>

<http://www.404manual.com>

<http://www.luxmanual.com>

<http://aubethermostatmanual.com>

Golf course search by state

<http://golfingnear.com>

Email search by domain

<http://emailbydomain.com>

Auto manuals search

<http://auto.somanuals.com>

TV manuals search

<http://tv.somanuals.com>