

Service Handbook



Waterclean 600 CD, LP/MP, PI

1.024-...

5.905-521
08.2004

Foreword

Good servicing and maintenance requires comprehensive, practical training and clearly organised documents.

This is why we offer all servicing engineers regular basic training and further qualification courses for the whole product range.

In addition, we compile service manuals for the main units which can be used as instructions to start with and as a reference work later on.

In addition, we issue regular Service Information about on-going developments of our products.

The texts and pictures can only be copied and duplicated or passed on to third parties after obtaining explicit permission from:

ALFRED KÄRCHER GmbH & Co.
CUSTOMER SERVICE TRAINING
P. O. Box 160
D-71349 Winnenden
www.kaercher.com

Contents

1	General	7 - 10
1.1	Introduction	7
1.2	Marking of Instructions	7
1.3	Intended Use	7
1.4	Safety Instructions	8
1.4.1	Quality of the Untreated Water	8
1.4.2	Chlorination of Drinking Water	8
1.4.3	Disposal of Chemicals	8
1.4.4	Handling Electricity / Protection Class	9
1.5	General installation notes	10
1.6	Units and Designations	11
2	Description	11 - 20
2.1	Overview	11
2.2	Flow Diagram	13
2.3	Description of the System	14
2.3.1	Modular Design	14
2.3.1.1	Pre-chlorination Module	14
2.3.1.2	Flocculation Module	14
2.3.1.3	Mediafilter- and Activated Carbon Filter	15
2.3.1.4	RO System, Pump and Fine Filter	15
2.3.1.5	Control Panel and Display	15
2.3.1.6	Anti Scalant and Post Chlorination	15
2.3.1.7	Pressure-increase Pump	16
2.3.2	Safety Installations	16
2.3.3	Operating Modes	17
2.3.3.1	Automatic Operation (Standard Operating Mode)	17
2.3.3.2	Manual Operation	17
2.4	Technical Data WTC 600 LP/MP	18
2.5	Consumption Materials	20
2.5.1	Chemicals for Metering Container	20
2.5.2	Cleaning Chemicals	20
2.5.3	Filter	20
3	Operation of the System	21 - 43
3.1	Assembly and Starting Operation	21
3.2	Mixing Chlorine, Flocculation Agent and Antiscalant	22
3.2.1	Initial Starting of Operation	22
3.2.2	Pre-chlorination	22
3.2.3	Antiscalant	24
3.2.4	Metering Amounts and Mixing of the Post Chlorination	25
3.2.5	Flocculation Agent	25
3.2.5.1	Mixing of the flocking test solution	25

Contents

3.2.5.2	Perform flocking test	26
3.2.5.3	Evaluate flocking test	26
3.3	Connecting the Equipment	27
3.3.1	Connections, Valves and Indicators	27
3.3.1.1	Pressure-increase Module	28
3.3.1.2	RO Module with Preliminary Filters	28
3.3.2	Electrical Connections	29
3.3.2.1	Pressure-increase Pump	29
3.3.2.2	Preliminary Filter	29
3.3.2.3	Metering Station	29
3.3.2.4	Float Switch	31
3.3.2.5	Reverse Osmosis System	31
3.4	Starting Operation	31
3.4.1	Metering Station	31
3.4.2	Media filter and activated carbon filter	32
3.4.2.1	Initial Filling	32
3.4.2.2	Starting Operation	32
3.4.2.3	Backwashing / Regeneration	32
3.4.2.4	Programming	33
3.4.3	Starting Operation of the RO System	35
3.4.3.1	Operating Levels and Passwords	35
3.4.3.2	Menu Selection	35
3.4.3.3	Selection of an Option	35
3.4.3.4	Selecting Several Arguments at the Same	36
3.4.3.5	Adjusting Operating Parameters and Balancing Values	36
3.4.3.6	Acknowledging Data Inputs	36
3.4.3.7	Operational Interruptions	36
3.4.3.8	Initial startup	38
3.4.4	Normal Operation	40
3.4.4.1	Operating Messages for Normal Operation	41
3.4.5	Putting Out of Operation	42
3.4.6	Disinfection	43
4	Maintenance	44 - 62
4.1	Fine Filter	44
4.2	Metering Station WTC 600 CD	44
4.3	Reverse Osmosis Module (RO Module)	45
4.3.1	RO Filter Replacement	45
4.4	Cleaning in Case of Malfunction	46
4.4.1	Design of the Flushing and Disinfection Equipment	47
4.4.2	Disinfection	49
4.4.3	Acidic and Alkaline Cleaning	50
4.4.3.1	Cleaning Solution for Acidic Cleaning	51

Contents

4.4.3.2	Cleaning Solution for Alkaline Cleaning	51
4.4.4	Conserving	51
4.4.4.1	Draining and rinse the metering stations	51
4.4.4.2	Conserve RO systems	51
4.4.4.3	Draining the pre-filter	53
4.4.5	Removing the Preservation After Longer Operational Interruptions	53
4.4.6	Rinsing the pre-filter	54
4.4.7	Replacing the activated carbon or filter sand	55
4.5	Malfunction, Cause and Corrective Action	57
4.5.1	Metering Station LED and Indicator LEDs at the Switch Cabinet	57
4.5.2	Malfunction Indication at the Operating Panel	58
4.5.3	Malfunctions of the RO Control and Metering Pump	59
4.5.4	Malfunctions – Sand and Activated Carbon Filter, Fine Filter and Flocculation	60
4.6	Maintenance Plan	61
4.6.1	Maintenance During Operation	61
4.6.2	Maintenance Plan Service	62
Appendix	63 - 84
	RO control manufacture settings	63
	RO control program structure	65
	RO 1000: User manual.....	67
	Operating Record for the WTC 600 LP/MP	84
List of key words	86 - 88

1 General

1.1 Introduction

This service manual contains basic instructions and information which are to be observed upon set-up, operation and maintenance.

Therefore, it is imperative that the service manual is read by the installer as well as by the responsible specialist staff prior to installation and starting of operation. Please observe not only the general safety instructions listed in the section "Safety Instructions", but also the special safety instructions included in the other sections.

1.2 Marking of Instructions



The safety instructions contained in these operating instructions, which in case of non-observance can cause dangerous situations for persons, are specially marked with the general symbol for danger.



The safety instructions contained in these operating instructions, which in case of non-observance can cause poisoning, cauterizing, etc. for persons, are specially marked with the death's-head symbol.

CAUTION Following this symbol are recommendations or tips which make working easier and provide for secure operation.

NOTE Following this symbol are recommendations or tips which make working easier and provide for secure operation.

Instructions that are attached directly to the equipment must be observed under all means and kept in completely readable condition.

1.3 Intended Use

The equipment is intended for the conditioning of untreated water into drinking water.

The retention degree of harmful chemical substances and biological pathogens or contaminants is very high.

The quality of the produced drinking water ultimately depends on the contamination degree and salt content of the untreated water.

- Prior to the initial starting of operation, we recommend carrying out an analysis of the untreated water.
- Continuous drinking-water quality can be ensured only when the equipment is controlled regularly.
- The respective national or international drinking water regulations are to be observed.

Under consideration of these rules of conduct, water produced from this system can quite safely be classified as drinking water.

1.4 Safety Instructionse

1.4.1 Quality of the Untreated Water



Sufficient quality of the untreated water must be ensured!

Faultless drinking water is achieved only when all filters of the equipment are maintained regularly.

1.4.2 Chlorination of Drinking Water



When applying post chlorination, the limit values set by national laws must be maintained. The chemicals used have a caustic and fire-promoting effect.

Dangers:

- Danger of fire in case of contact with combustible materials.
- Toxic gas develops when coming in contact with acids.
- Heat or direct sunlight decomposes the chemical: Chlorine and oxygen are released.
- Caustic effects to the eyes, skin and respiratory system result.

Safety Instructions:

- Wear acid-resistant protective equipment (goggles, gloves) and when dust is produced, breathing mask protection with a filter.
- Keep an eye wash bottle (small) readily available.
- Provide for adequate room ventilation and a washing facility.
- Store the chemicals in a cool, dry place, not below 5 °C.
- Store chemicals in a location out of the reach of children.

In Case of Accidents:

- In case of contact with the eyes, rinse immediately and thoroughly with fresh water and consult a doctor.
- Use water to extinguish; avoid impact and friction.
- If solutions are spilt, flush the area with a sufficient amount of fresh water.

1.4.3 Disposal of Chemicals

It is generally recommended to admit resulting disinfection solutions, preservation solutions, etc. into a neutralizing system.

If this should not be possible, the disinfection solution, after clarification with the relevant authority (mayor's office, district administration office, etc.) is to be neutralized and can afterwards be led into the public sewer system.

1.4.4 Handling Electricity / Protection Class



Be aware of dangerous electrical voltage!

For work on components/assemblies which are marked with this symbol, protective measures are to be taken:

- Switch off the power
- Secure against restarting
- Check and assess that no voltage is given.

The electrical connection of the equipment may be carried out only by a qualified electrician.

The power supply cable must be fitted with a protective conductor (protection class I).

1.5 General installation notes

- Only use food safe components and resources on the drinking water side
- Pay special attention to hygienic cleanliness when installing drinking water pipes.

1.6 Units and Designations

Unit	Designation
bar	bar (pressure)
di/da	Diameter, inside / diameter, outside
g/h	Gram per hour
Hz	Hz (frequency)
l	Liter
l/h	Liter per hou
mg/h	Milligram per hour
mg/l	Milligram per lite
ml	Milliliter
V AC	Volt (AC)
W	Watt (power)
°dH	Degree of hardness (water hardness)
µS/cm	Microsiemens per cm (spec. conductance value)
ETL	Spare parts list
LW	Conductance value
SLP	Circuit Diagram

Table 1 Units and their meaning

NOTE 1000 milliliter = 1 liter; 1000 mg = 1

2 Description

2.1 Overview

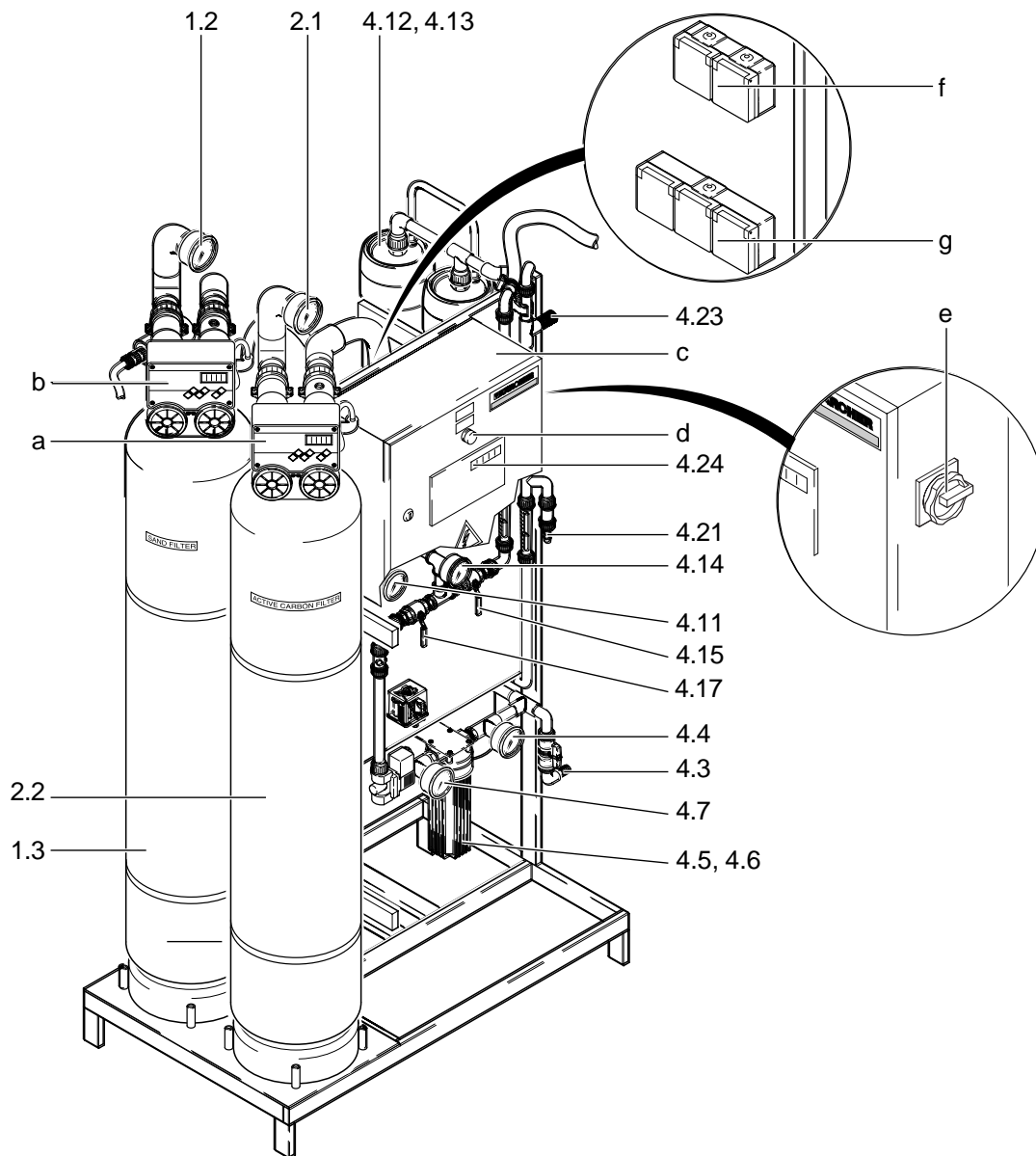

Figure 1 Overview of components

Legend for figure 1 and figure 2:

1.1	Pre-chlorination metering point	4.11	Manometer, pump pressure
1.2	Manometer - media filter inlet pressure	4.12	Membrane pressure pipe
1.3	Media filter	4.13	Membrane
1.4	Differential pressure switch	4.14	Manometer - concentrate pressure
1.5	Concussion restrictor	4.15	Concentrate control valve
1.6	Flocculation metering point	4.16	Concentrate flowmeter
2.1	Manometer - activated carbon filter inlet pressure	4.17	Pressure control valve
2.2	Activated carbon filter	4.18	High-pressure pump
4.1	Antiscalant metering point	4.19	Conductivity and temperature measuring cell - drinking water
4.2	Non-return valve	4.20	Drinking water flowmeter
4.3	Untreated water sampling tap	4.21	Drinking water sampling tap
4.4	Manometer - fine filter input pressure	4.22	Non-return valve
4.5	Fine filter housing	4.23	Post chlorination metering point
4.6	Fine filter candle	4.24	Reverse osmosis control
4.7	Manometer - fine filter output pressure	6.1	Pre-chlorination metering
4.8	Input solenoid valve	6.2	Antiscalant metering
4.9	Manostat	6.3	Post chlorination metering
4.10	High-pressure pump	6.4	Flocculation metering

Items 1.1 to 6.4 are attached to the components as reference numbers.

- a Media filter control
- b Control, activated carbon filter
- c Control cabinet
- d Manual / automatic rotary switch
- e Master switch
- f Media and activated charcoal plug sockets
- g Power outlets (3x) for metering stations

2.2 Flow Diagram

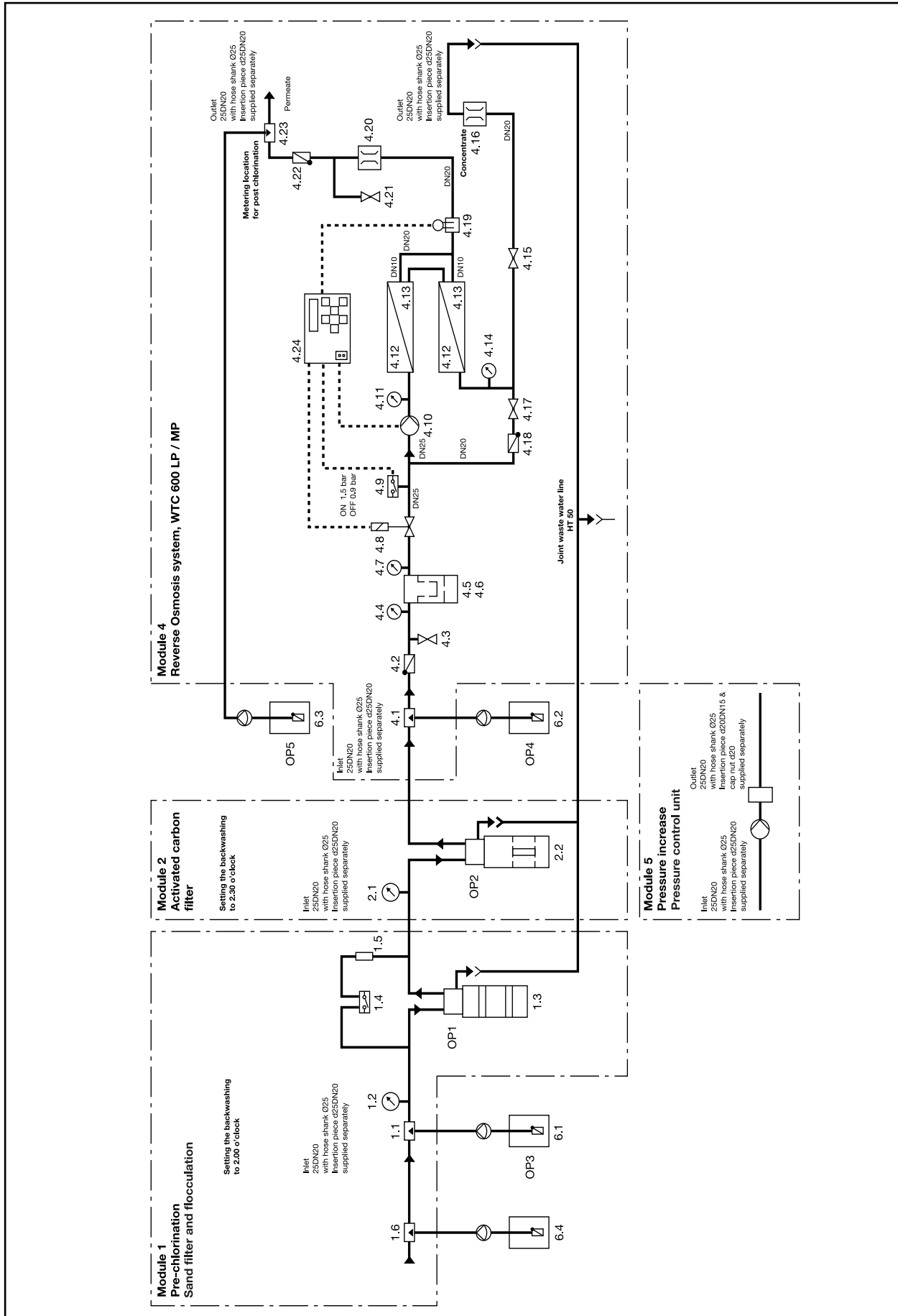

Figure 2 Flow diagram of the complete reverse osmosis system (RO system)

2.3 Description of the System

2.3.1 Modular Design

The installation is a drinking water conditioning system. Its core application is the eminalization of brackish water with a salt content up to 2000 ppm (WTC 600 LP), respectively up to 5000 ppm (WTC 600 MP).

The design of the system is modular, and can be adapted accordingly to the local conditions depending on the application conditions as well as the composition of the untreated water:

- Media filter and flocculation – module 1
- Activated carbon filter – module 2
- Reverse osmosis system – module 4
- Pressure-increase pump – module 5
- Metering stations

The RO system is designed for stationary use.

2.3.1.1 Pre-chlorination Module

The WTC 600 CD metering station, consisting of metering container (3/1) and pump (3/2), is connected to the sand filter module for pre-chlorination if required.



Figure 3 WTC 600 CD

2.3.1.2 Flocculation Module

The WTC 600 CD metering station (see figure 3) with injection adapter is connected to the sand filter module for pre-flocculation if required.

The exact requirement of flocculation agent is to be determined when starting operation (see Section 3.2.5).

2.3.1.3 Mediafilter- and Activated Carbon Filter

The pre-filter units of the RO system consist of the media filter and the activated carbon filter.

The filter fillings consist of support pebbles and filter sand according to DIN 19623, as well as activated carbon.

The filters are each controlled by means of a central control valve with microprocessor control and located at the top of the filter.

2.3.1.4 RO System, Pump and Fine Filter

The fine filter is located on the front side of the equipment. It is connected directly in front of the RO system.

The RO pump (4/2) pumps the pre-filtered water through two RO filters (4/1) which are connected in series.

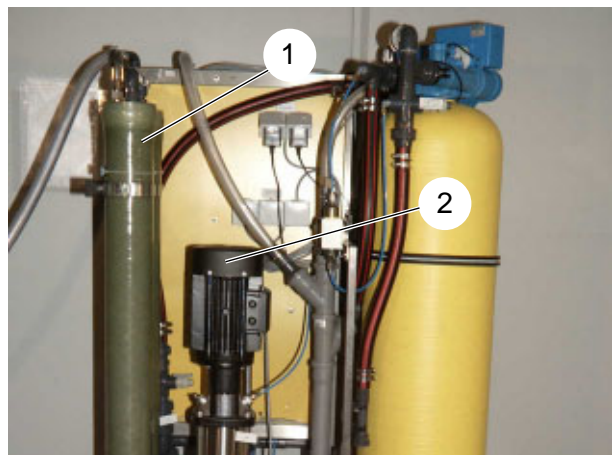

Figure 4 RO pump

2.3.1.5 Control Panel and Display

The control panel is used for data input in the control and as LED indicator for the operating modes and malfunction indications (5/1).

Parameters are entered with the arrow pushbuttons. Data input is acknowledged with the ENTER pushbutton (5/4) and cancelled with the ESC pushbutton (5/3).

Programming conditions, etc., are indicated in the display (5/2).



Figure 5 Control panel and display

2.3.1.6 Anti Scalant and Post Chlorination

For hardness stabilization of the untreated water and post chlorination of the drinking water a WTC 600 CD metering station is connected to the RO module in the same manner as for pre-chlorination.

2.3.1.7 Pressure-increase Pump

If required, the WTC 600 PI pressure-increase pump (6/1) is connected between untreated water supply and RO system. It is used for pressure increase of the untreated water.

NOTE A pressure-increase pump should be used for a water pressure (flow pressure) ≤ 2 bar.

CAUTION Observe mechanical protection as well as protection of the connection cable against water!

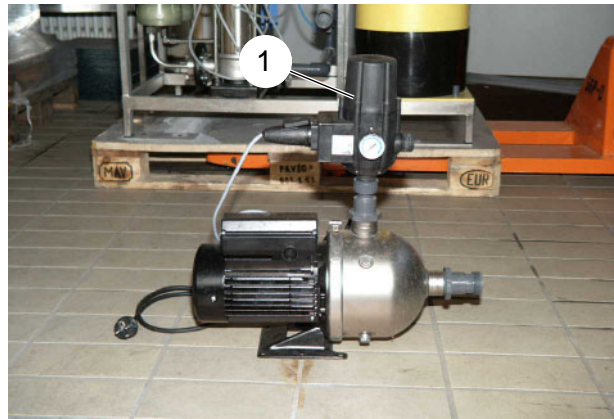

Figure 6 WTC 600 PI

2.3.2 Safety Installations

Emergency Stop

The emergency stop switch (7/4) (main switch) is located on the side of the switch box.

RC Protective Switch

RC protective switch (external): $i \leq 30$ mA

Circuit Breaker

Automatic circuit breaker (7/3) 10 A for power limitation of the power outlets, etc

Motor Protection Switch

The motor protection switch (7/2) is factory-set depending on the power consumption of the RO pump (compare circuit diagram (7/1)) and must be checked:

WTC 600	Nominal output RO pump	Actual power consumption	Motor protection switch setting
LP 400 V	2.2 kW	1.5 kW	4 A
MP 400 V	2.2 kW	2.2 kW	5.1 A
LP 230V	2.2 kW	1.5 kW	10 A
MP 230 V	2.2 kW	2.2 kW	14 A

Table 2 Setting of motor protection switch

Microfuses

Two microfuses (7/6) for protection of the control electronics (7/5) are located on the control board for the electronics:

- 5x20 6,3 A time-delay
- 5x20 0,1 A time-delay.

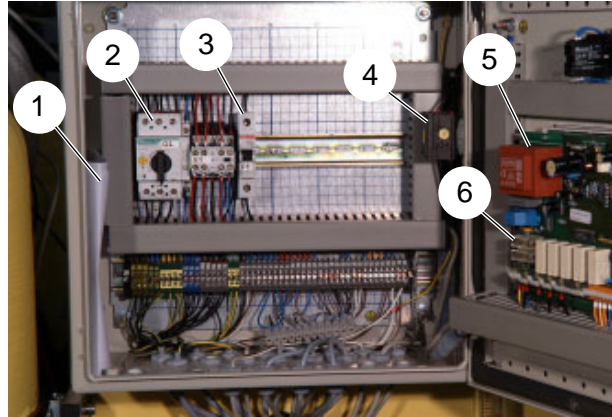

Figure 7 Switch cabinet and control electronic

2.3.3 Operating Modes

2.3.3.1 Automatic Operation (Standard Operating Mode)

After switching on the main switch, the system is fully automatic controlled through the electronic control system and the float switch in the drinking water tank. The mode selector switch is in the "Auto" position.

The control system usually operates in the normal plane in the operating mode **operation**.

With the exception of an error acknowledgement (only in case of pre-selection Vw-acknowledgement by actuating the ESC key button), no further operating by the operator is possible; this is to protect the control system against unintended / unauthorized manipulations.

NOTE By entering the respective password, the user level or the technician level for input of operating parameters, etc. is cleared (see section 3.4.3.1). The program structure is given in the appendix, Figure 21.

NOTE Operating parameters and setting values are listed on the data sheet by the manufacturer (cf. Tables 34 and 35).

2.3.3.2 Manual Operation

The float switch in the drinking water tank is deactivated by the manual / automatic rotary switch ("Manual" position), so that the plant can run continuously.

CAUTION Manual operation is not standard operating mode, as the system does not switch off automatically.

2.4 Technical Data WTC 600 LP/MP

Parameter	WTC 600 LP	WTC 600 MP
Ambient temperature	+1°C - +50°C	
Storage temperature (delivery)	to -10°C	
Humidity	<100% r.F.	
Supply voltage	3*400V 50 Hz ¹⁾ 1*230V 50 Hz ¹⁾	
Pre-filter controls: prim / sec.	230 V/12 V 50 Hz	
Metering pumps	230 V 50-60Hz	
Wiring	3 Ph, N, PE	
Electrical protection	16 A	
Connected electrical load	2.2 kW	2.2 kW
Effective electrical power consumption	1.5 kW	2.2 kW
Mechanical protection / protection against water		
Switch cabinet	IP44	
Pump and valves	IP44	
Metering pump	IP44	
Power outlets (plug inserted)	< IP44	
Minimum temperature of untreated water	+5°C	
Maximum temperature of untreated wate	+35°C	
Reference temperature	+15°C	
pH-value, untreated water	6-9.5	
pH-value during cleaning	3-11	
System input pressure and flow	2-6 bar at min. 2 m ³ /h	
Capacity range	15000 l/day (±10%)	
Maximum drinking water capacity	650 l/h	
Dimensions: H x W x D		
WTC 600 LP/MP	1800 x 660 x 720 mm	
WTC 600 LP/MP - A	1800 x 1120 x 720 mm	
WTC 600 LP/MP - AM	1800 x 1120 x 720 mm	
Weight in delivery condition (without filter container)		
WTC 600 LP/MP	135 kg	
WTC 600 LP/MP - A	155 kg	
WTC 600 LP/MP - AM	175 kg	

Table 3 Technical Data

¹⁾ depending on the system version

Filter Container	
Volume per container	103 l
Filling capacities, Mediafilter	
Support pebbles 2.0 - 3.15 mm	15 kg
Filter sand 0.4 - 0.8 mm	100 kg
Filter amounts, activated carbon filter	
Support pebbles 1 - 2 mm	15 kg
Activated carbon filter F100	32 kg
Water connections	
Inlet threaded connection hose nozzle	Outer diameter d25
Drinking water threaded connection hose nozzle	Outer diameter d25
Concentrate threaded connection hose nozzle	Outer diameter d25
Outlet for flushing water	HT pipe d50
Canal connection (supplied by customer)	> DN 50
Hydraulic Data	
Maximum allowable flow rate in filteroperation	1,3 m ³ /h
Amount of waste water produced during backwashing	2 m ³ /h, ca. 670 liter per backwashing
Allowable Operating Conditions	
Maximum pressure	6 bar
Metering Pump	
Feed capacity at max. counter-pressure (10 bar)	1 l/h
Metering Container:	
Weight with pump	10 kg
Connections	
Hose connections (PE) di/do	4/6
Hose connection, ventilation (PVC) di/do	4/6
Float Switch	
Minimum hysteresis	300 l

Table 4 Technical Data

2.5 Consumption Materials



Swear protective equipment and observe safety instructions!

2.5.1 Chemicals for Metering Container

For mixing of the metering solution, use the measuring cup with the handle (250 ml or 1000 ml).

NOTE Explanations of the units, see Chapter 1.6.

NOTE A metering container from the WTC 600 CD metering station has a volume of 75 liter.

Product	ItemNo.
Chlorinated lime	6.291-505.0
Sterilization agen RM 852	6.291-772.0
RM 5000 hardness stabilization	6.290-991.0
RM 5001 Flockulents, 10 l	6.294-703.0
RM 5001 Flockulents, 60 l	6.294-716.0

Table 5 Kärcher Original Products

2.5.2 Cleaning Chemicals

Product	Item No.
RM Kleen MCT 511	6.294-008.0
RM Kleen MCT 103	6.294-009.0
RM P3 Oxonia Active	6.294-010.0
RM 1,2 Propandiol, 5 l	6.290-910.0
Sulfite 5 kg	6.769-040.0
Soda	6.287-014.0
RM 511 Vaporapid bio-descaling acid	6.290-239.0*

Table 6 Cleaning Chemicals

* Attention! Note national variants!

2.5.3 Filter

Product	Item No.
Filter element 5 μ	6.414-466.0
Replacement set, metering pump	6.762-172.0

Table 7 Filter Elements

3 Operation of the System

3.1 Assembly and Starting Operation

Assembly	Chapter
Checking the scope of delivery (delivery note)	
Placing the equipment in the set-up location and positioning	
Connecting the untreated water to the WTC 600 LP/MP; connecting the WTC 600 PI in between, if required (depending on delivery scope)	2.2, 3.3.2.1, 3.3.1
Installing the piping for backwashing and drinking water	2.2
Installing the float switch	3.3.2.4
Filling and connecting the sand filter and the activated carbon filter	3.4.2
Connecting the electrical system	SLP, 3.3.2

Table 8 Assembly work to be carried out upon starting operation

Starting Operation	Chapter
Establishing the untreated water supply	2.2
Manually actuating the sand filter backwashing	3.4.2
Manually actuating the activated carbon filter backwashing	3.4.2
Flushing the reverse osmosis	3.4.3.7
Filling the chemicals container	3.2
Adjusting the flow rates	3.4.3.8
Filling out the metering table in the operating instructions	
Instructing the operator (operating instructions)	

Table 9 Overview of start-up work

A water analysis with the following values must exist for commissioning of the WTC 600:

- Total hardness GH in °dH
- Iron Fe in mg/l
- Manganese Mn in mg/l
- Ammonium NH₄ or NH₃ in mg/l
- System yield determined by the sales department (Normal case: 75%, in special cases 50%).

3.2 Mixing Chlorine, Flocculation Agent and Antiscalant

3.2.1 First fill of the metering tanks

The first time they are filled, the metering tanks are filled with 30 litres of chlorine-free water. This is taken from the reverse osmosis at the drinking water sampling tap (1/12).

For the first fill of the metering tank, the system is switched to **disinfection** mode and set to the following flow rates:

- Drinking water: 100 l/h
- Concentrate: 600 l/h

CAUTION During the **disinfection** operating mode, all confirmation queries are switched off! Observe the pressure downstream of the fine filter: as soon as it is less than 2 bar pressure, immediately switch off the system. The high-pressure pump is running dry!

Use the prescribed system yield (50% or 75%) and the water analysis to determine each of the chemical quantities for a 30 litre metering solution according to Chap. 3.2 to 3.5, add to the tanks and mix well.

Switch the system to **operation** mode.

3.2.2 Pre-chlorination

CAUTION Only use drinking water to dilute the original chlorine product upstream of the chlorination point. This water is taken from the drinking water tap (1/4.21).

1. Take the system yield (50% or 75%) from the evaluation of the untreated water analysis.
2. Take the analysis values for iron (Fe), manganese (Mn) and ammonium (NH₃ or NH₄) in mg/l from the untreated water analysis.

3. Iron content:	_____ x 0,4 = _____
Manganese content:	_____ x 0,6 = _____
Ammonium content:	_____ x 8,0 = _____
Basic requirement:	<u>1,2</u>
Total:	=====

4. For 50% yield:

Total x 192 = _____ ml RM 852 per 10 litre metering solution

OR

Total x 51 = _____ ml calcium hypochlorite (1ml corresponds to 1.05g) per 10 litres metering solution

5. For 75% yield:

Total x 128 = _____ ml RM 852 per 10 litre metering solution

OR

Total x 34 = _____ ml calcium hypochlorite (1 ml corresponds to 1.05g) per 10 litres metering solution

These values are entered in the customer's operating instructions.

Calculation example:

- Yield 75%
- Iron (Fe) 1.0 mg/l
- Manganese (Mn) 1.0 mg/l
- Ammonium (NH₄) 0.2 mg/l

Iron content:	1,0	x	0,4	=	<u>0,4</u>
Manganese content:	1,0	x	0,6	=	<u>0,6</u>
Ammonium content:	0,2	x	8,0	=	<u>1,6</u>
Basic requirement:					<u>1,2</u>
Total:					3,8

For 75% yield:

Total x 128 = 486 ml RM 852 per 10 litre metering solution

OR

Total x 34 = 129 ml calcium hypochlorite (1 ml corresponds to 1.05g) per 10 litres metering solution

3.2.3 Antiscalant

The drinking water for the metering solution is taken from the sampling tap for drinking water (1/4.21).

The antiscalant metering quantity can be set with a very good approximation using the following table. The optimum quantity can only be calculated using a calculation program after a precise water analysis has been carried out. The typical metering range lies between 2 and 5 mg/l.

Where water hardnesses are higher than 28°dH, special design is necessary. If this design is not possible, the following setting is recommended: 5 mg/l RM5000 and 50% yield, until the precise design is available.

Range of Water Hardness	Antiscalant [mg/l]	Metered amount of RM 5000 [ml] per 10 l Metering Solution	Run-down Tank Service Life [h]
1 (0°-7° dH)	2,5	58	214
2 (7°-14° dH)	3	69	214
3 (14°-21° dH)	4	92	214
4 (21°-28° dH)	5	115	214

Table 10 Metering of antiscalant at 75% yield

Range of Water Hardness	Antiscalant [mg/l]	Metered amount of RM 5000 [ml] per 10 l Metering Solution	Run-down Tank Service Life [h]
1 (0°-7° dH)	2,5	87	214
2 (7°-14° dH)	3	104	214
3 (14°-21° dH)	4	138	214
4 (21°-28° dH)	5	173	214

Table 11 Metering of antiscalant at 50% yield

1 °dH = 1,79 °frH

1 °dH = 17,9 mg CaCO₃/l

1 °frH = 10,0 mg CaCO₃/l

3.2.4 Metering Amounts and Mixing of the Post Chlorination

The chlorine quantity given matches a chlorine content of 0.3mg/l in the drinking water.

The following quantities of RM 852 or calcium hypochlorite are each required for 10 litres of metering solution:

- RM 852 Sterilization Agent: 32 ml
- Chlorinated Lime: 17 ml (= 18 g)

Example: 75 litres ready mixed metering solution (one metering tank) consists of $7.5 \times 32 = 240$ ml RM 852 or $7.5 \times 17 = 128$ ml (=136 g) calcium hypochlorite and chlorine-free drinking water (cf. Chapter 3.2.3 for extraction).

The quantities must be adjusted accordingly for higher or lower chlorine contents.

Example: Chlorine content: 1.2 mg/l

- RM 852: $4 \times 32 \text{ ml} = 128 \text{ ml}$
- Chlorinated Lime: $4 \times 17 = 68 \text{ ml}$

3.2.5 Flocculation Agent

The exact demand in flocculents can only be determined by test. Therefore a test solution is mixed first, then the raw water is flocced and finally the dosing quantity is evaluated.

3.2.5.1 Mixing of the flocking test solution

Auxiliaries:

- Measuring cup with 500-ml-scale 6.277-001.0 (within service kit)
- Desalinated water (refill water for car batteries)
- Flocculent RM 5001 6.294-716.0 resp. 6.294-703
- Measuring cup 25 ml 6.394-425.0 (within service kit)
- Dropping bottle 50 ml, PE 6.394-426.0 (within service kit)
- Plastic eating spoon.

Work Steps:

1. Give 25 ml flocculent RM 5001 into measuring cup
2. Fill up with desalinated water to 500 ml
3. Stir up thoroughly with plastic eating spoon
4. Give 50 ml of this into a clean dropping bottle, close bottle
5. Cast away the remainder.

3.2.5.2 Perform flocking test

Auxiliaries:

- Transparent cup, 1 litre with marking at 0.5 litre 6.277-001.0
- Dropping bottle with test solution 6.394-426.0
- Plastic eating spoon.

Work Steps:

1. Measure pH-value of water, has to be between 6 and 9
2. Pour 0.5 Liter raw water into cup
3. Give 10 drops of flocking test solution into spoon
4. Fill flocking test solution into cup, at this stir strongly for 5 seconds
5. Leave cup: flocking has to start within 1 minute and settle significantly.

NOTE If no flockung has start repeat test and change quantity of flocking test solution (first more test solution, if not successful repeat with less test solution).

If analysis is not possible on the spot, take out 2 litres of test solution and store in refrigerator at ca. 4°C until analysis. Cooling maintains cloudiness by suspended matter.

NOTE Shake well before measurement in laboratory.

3.2.5.3 Evaluate flocking test

Adjustment of dosing pump flocking means:

- Stroke: 40%
- Frequency: 70%.

The required amount of flocculation agent RM 5001 is then calculated as follows:

- For 50% yield: number of drops x 120 = ml RM 5001 per 10 litres metering solution
- For 75% yield: number of drops x 80 = ml RM 5001 per 10 litres metering solution

Calculation example:

The flocculation test gave 11 drops of flocculation test solution to 500ml up to ideal flocculation, the yield is 75%:

11 drops x 80 = 880 ml RM 5001 per 10 litres of metering solution

3.3 Connecting the Equipment

3.3.1 Connections, Valves and Indicators

Depending on the local untreated water supply, the WTC 600 LP/MP is connected directly to the off-site supply or supplemented through a WTC 600 PI pressure-increase module.

The following constructional measures must be observed:

- The off-site untreated water supply must be equipped with a shut-off device (supplied by user / customer).
- All pipes / lines (untreated water, backwashing, concentrate and drinking water) to be installed without mechanical tension.
- Drinking water line to be installed with free run-out and no further shut-off devices.
- Backwashing line to be installed with steady drop (under no circumstances inclined upward).

For easy and secure operation and maintenance of the system, minimum clearances from the walls are to be observed:

Page	Minimum clearances [cm]
A	50
B	10
C	70
D	50

Table 12 Minimum clearances

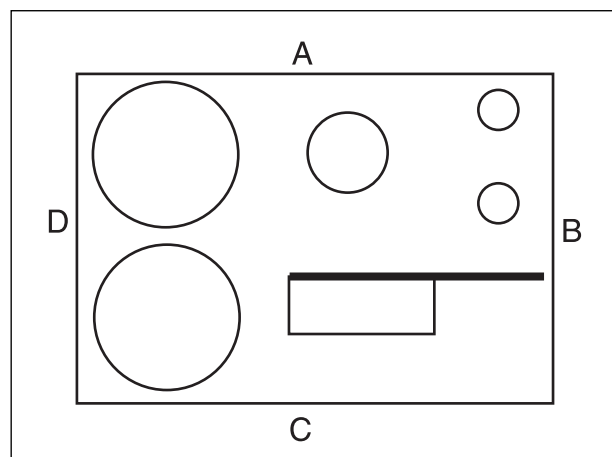

Figure 8 Minimum clearances WTC 600 LP/MP



Figure 9 Water connections, WTC 600 PI

Installation space (incl. working space for maintenance and operation, not including piping):

WTC 600 LP and MP: width x depth: 1300 x 1900mm

WTC 600 LP-A, LP-AM, MP-A, MP-AM: width x depth: 1700 x 1900 mm

WTC 600 CD: width x depth: 500 x 1100 mm

WTC 600 PI: width x depth: 600 x 200 mm

3.3.1.1 Pressure-increase Module

Connection to the RO system (9/2) Hose shank d25

Connection to the untreated water (9/3) Hose shank d25

CAUTION Observe mechanical protection of the electrical connection cable (9/1) as well as protection against water!

The fan wheel of the pump must be at least 20 cm away from the next wall.

CAUTION Otherwise damage to the motor caused by heat build-up must be considered.

3.3.1.2 RO Module with Preliminary Filters

In the delivery condition, blind discs are installed for means of preservation to the screwed connection above the Antiscalant (10/1) metering line as well as to the drinking water connection (11/4) and to the concentrate connection (11/3). These are to be removed before starting operation.

Metering line connection for pre-chlorination (10/2)

Untreated water connection (10/3) hose shank d25

Concentrate drain (10/4) HT-pipe d50

Drinking water connection (11/4) hose shank d25

Metering line connection for post chlorination (11/5)

Sampling valve for drinking water (11/6)

Sampling valve for untreated water (11/9)

Pressure control valve (11/1)

Flow meter, concentrate (11/2)

Flow meter, drinking water (11/7)

Concentrate control valve (11/8)

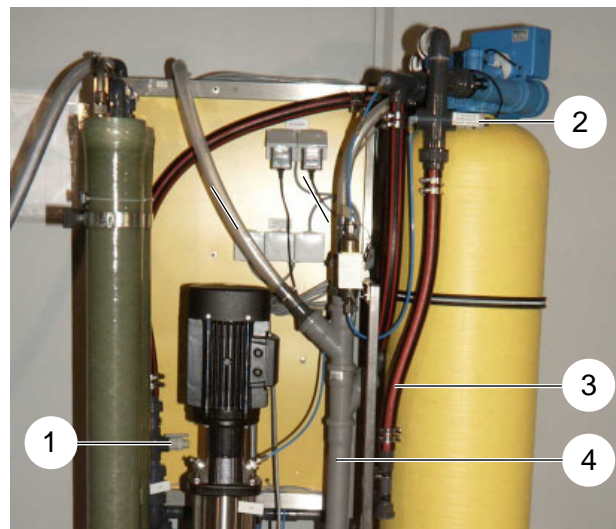

Figure 10 Connections, rear

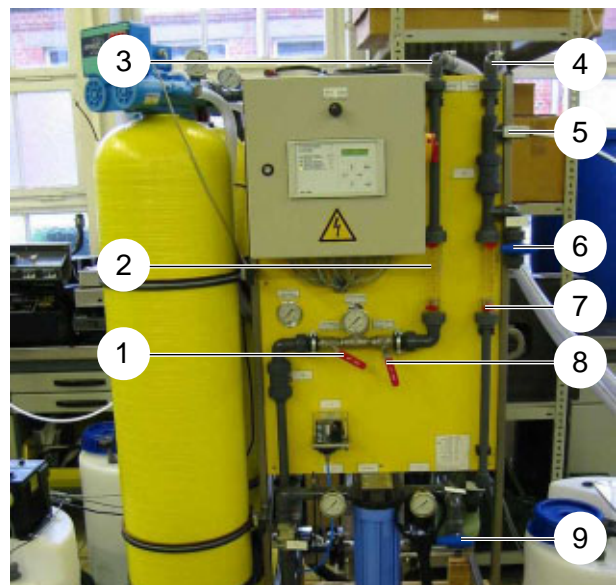

Figure 11 Connections, front

3.3.2 Electrical Connections

3.3.2.1 Pressure-increase Pump

230 V external, via connection cable.

3.3.2.2 Preliminary Filter

In delivery condition, the preliminary filters are connected to the power outlets (1/f) on the rear side of the RO equipment.

3.3.2.3 Metering Station

The pumps of the projected metering stations are connected to the power outlets (1/g).

NOTE The cable from the float switch must be inserted in the metering pump unit.

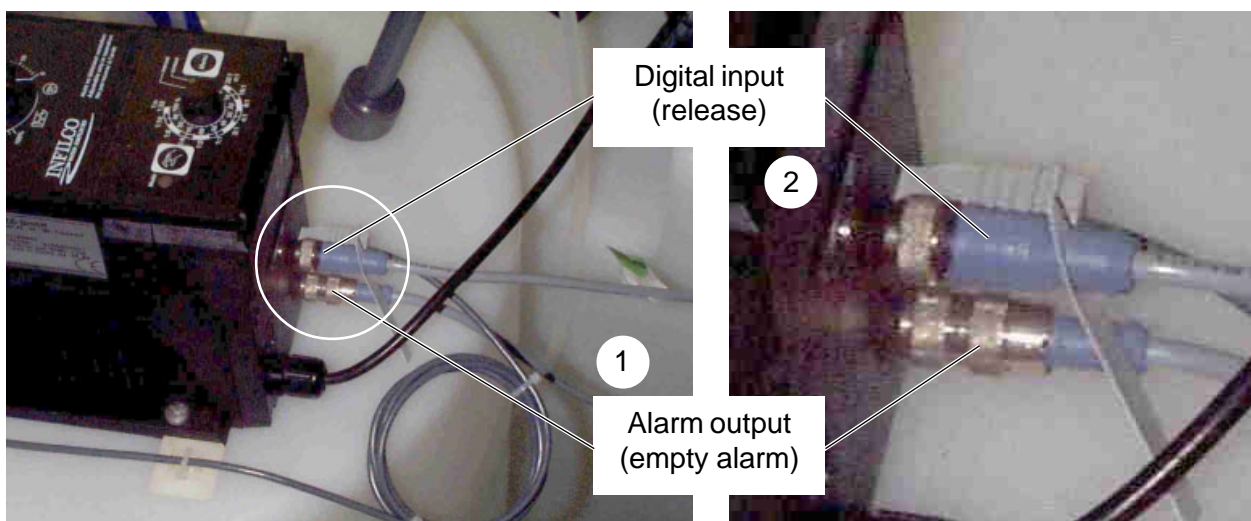

Figure 12 Alarm output and digital input of the metering pumps

For connection of the control cables in the electrical switching cabinet, the blind connections in the flange plate (13/4) are replaced by the enclosed cable screw fittings (13/3).

Connect the control cables in accordance with Table 13.

NOTE The complete connecting diagrams / plans (13/1) are located in the switch cabinet.

NOTE The connections for signal inputs that are not required are bridged at the connecting terminal (13/2).

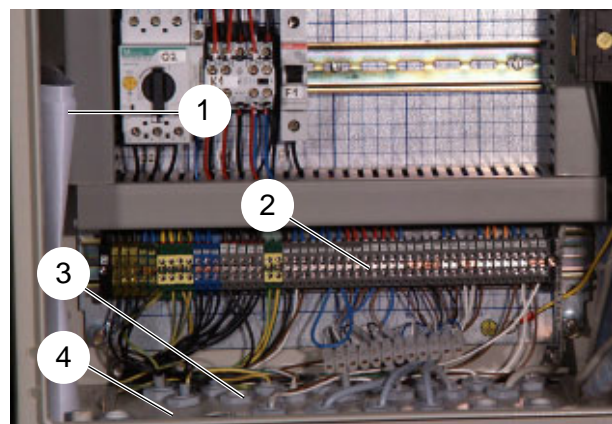

Figure 13 Connections, metering stations

Metering Container	Type	Function	Signal Line	Connecting Terminal, El. Cabinet	
Pre-chlorination	Alarm output (12/1)	not required	white	-----	
			blue	-----	
		Empty signal	brown	14	
			black	15	
	Digital input (12/2)	Release	brown	8	
			blue	9	
		not required	white	-----	
			black	-----	
Antiscalant	Alarm output (12/1)	not required	white	-----	
			blue	-----	
		Empty signal	brown	16	
			black	17	
		Digital input (12/2)	Release	brown	10
				blue	11
			not required	white	-----
				black	-----
Post chlorination	Alarm output (12/1)	not required	white	-----	
			blue	-----	
		Empty signal	brown	18	
			black	19	
	Digital input (12/2)	Release	brown	12	
			blue	13	
		not required	white	-----	
			black	-----	

Table 13 Connection assignment: Empty message and releasing of the metering containers at the RO control

CAUTION Electrically insulate cable ends that are not used with insulating terminals.

3.3.2.4 Float Switch

Connect the signal lines of the enclosed float switch to clamps 6/7 (8S3 option) of the connecting terminal – compare wiring diagram in the switching box. Upon installation, adjust a switching hysteresis of at least 300 liters between the switching-on and switching-off point.

3.3.2.5 Reverse Osmosis System

The WTC 600 LP/MP is connected to the following power supply:

- 400 V / 50Hz, 3Ph + N + PE or 230 V / 50Hz, 1Ph + N + PE (depending on type of system)
- Fuse protection 16 A
- RC protective switch 30 mA from source of power supply (check if in existence or have confirmed in writing).

3.4 Starting Operation

Operation of the individual equipment components is started in the following sequence:

- Fill the preliminary filter and start operation by backwashing (3.4.2)
- De-convert reverse osmosis (3.4.3.7)
- Fill metering container and start operation (3.4.1)
- Start the operation of the reverse osmosis (3.4.3.8)

3.4.1 Metering Station

NOTE Pushbutton for venting in “continuous operation” (14/3).

Operating mode on “Manual” (14/2)!
Change the operating mode by pressing the "Mode" key (14/2).

Modul	Lift (14/1)	Frequency (14/4)	Metering
Pre-chlorination	40%	70%	3.2.2
Antiscalant	40%	50%	3.2.3
Post chlorination	40%	70%	3.2.4
Flocculation	40%	70%	3.2.5

Table 14 Checking pump settings

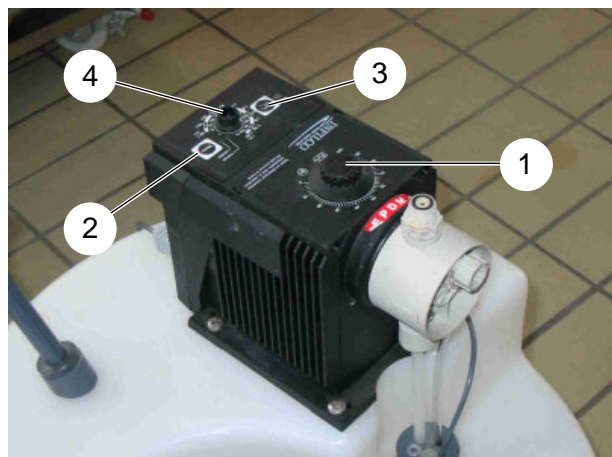

Figure 14 Metering station

NOTE Adjust the lift only when the pump is running. Danger of damaging!

3.4.2 Media and Activated Carbon Filter

3.4.2.1 Initial Filling

Remove the central control valve and position the central pipes with the lower nozzle in the middle of the tank floor. Fill the tank up to a third with water. Place the filling funnel (4.901-090.0) in the opening and fill the filter bed with a shovel (6.812-049.0) in accordance with Table 15:

Filter	Support pebbles		Filter sand / Activated carbon	
	Media filter	15 kg	Grain size 2,0-3,15 mm	100 kg
Activated carbon	15 kg	Grain size 1-2 mm	32 kg	Activated carbon grain F100

Table 15 Completely fill the tank with water

Align the central pipe in the middle of the container opening and reinsert the central control valve again after removing the cover. Connect the hydraulic connections again.

3.4.2.2 Starting Operation

After filling, the filters must be backwashed. For this the complete system is to be connected hydraulically and electrically, and to be switched on at the main switch. The reverse osmosis system must be in the **Switched Off** operating mode (compare 3.4.3 – 3.4.5). The backwashing is initiated manually with the MANUAL REGEN pushbutton (15/4) and takes approx. 15 minutes. The procedure can be followed on the display of the controller:

- Step 1C: Backwashing; duration approx. 10 min
- Step 2C and 3C: Without function
- Step 4C: Initial filtration; duration approx. 3 min

Afterwards the filter is ready for operation.

3.4.2.3 Backwashing / Regeneration

For cleaning of the filters, the flow direction of the water is reversed so that the settled debris particles are moved to the outlet of the flushing water.

The filters are equipped with different devices for actuation of backwashing:

Activated carbon filter:

- Time-controlled: 1 x per night Standard: 2:30 a.m.
- Manually: any time

Media filter:

- Pressure difference: upon contamination of the filter Standard: 1 bar difference
- Time-controlled: 1 x per night Standard: 2:00 a.m.
- Manually: any time

3.4.2.4 Programming

To start the programming, the covered pushbutton (15/1) to the left of the “TIME OF DAY” pushbutton (15/2) is to be pressed (a circular indentation can be felt under the front foil). The changing of the flashing positions is carried out with the “ADVANCE” pushbutton (15/3).

NOTE If a different adjustment than the factory-setting is required, enter and acknowledge by pressing “MANUAL REGEN” (15/4).

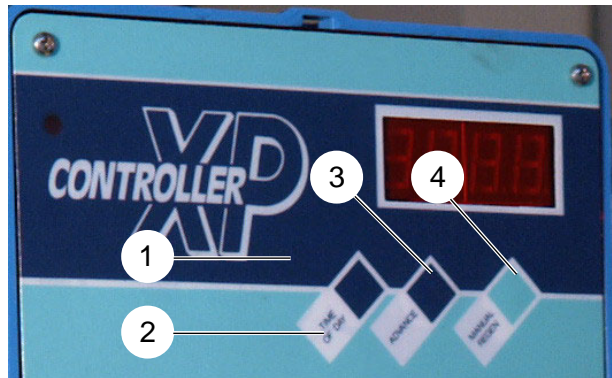

Figure 15 XP Controller

When pressed continuously, the number values run through in double digits from the current value to 99; by briefly pressing the pushbutton, the indication changes upward by the value 1. Moving on to the next enter position is done by pressing the pushbutton mentioned in the 2nd column in Table 17.

TIME OF DAY	1. Sets the time
	2. Starts the programming of time steps
ADVANCE	1. For changing of parameters during programming
	2. Calls up the diagnosis (see Table 24) - press for 10 sec
MANUAL REGEN	1. Activates a manual regeneration
	2. Runs step by step through the regeneration steps
Covered pushbutton	Left of the „TIME OF DAY“ pushbutton. Starts the programming.

Table 16 Input, preliminary filter control

Position		Indication	Description
At the media filter:			
1	Covered pushbutton	0. 2 00	Media filter back-washing at 02.00 (minutes)
2	Covered pushbutton	0. 2 00	Media filter back-washing at 02.00 (full hours)
At the activated carbon filter			
1	Covered pushbutton	0. 2 30	Backwashing of activated carbonfilter at 02.30 (minutes)
2	Covered pushbutton	0. 2 30	Backwashing of activated carbonfilter at 02.30 (full hours)
At both filters			
3	Covered pushbutton	FF01	Time interval (in days) between 2 backwashings; FF01 means one backwashing per day
4	Covered pushbutton	200.0	Without function
5	Covered pushbutton	200.0	Without function

Table 17 Programming table ¹⁾ for sand filter and activated carbon filter

Position		Indication	Description
6	Covered pushbutton	0000.	Without function
7	Covered pushbutton	0000.	Without function
8	Covered pushbutton	AA14	Without function
9	Covered pushbutton	AA02	
10	Covered pushbutton	AA02	
11	TIME OF DAY	1C10	Backwashing period 10 minutes
12	Covered pushbutton	2C00	0 minutes
13	Covered pushbutton	3C00	0 minutes
14	Covered pushbutton	4C03	Initial filtration 3 minutes
15	Covered pushbutton	4d10	Leave programming mode

Table 18 Programming table¹⁾ for media filter and activated carbon filter

¹⁾ For changing of any given value from the programming table, the complete menu must be run through. The enter position flashes and the value is changed with the "ADVANCE" pushbutton!

Indication	Description
02.30	Day time
F-00	Days since the last regeneration
0.0.0.0.	Number of regeneration

Table 19 Statistical indications – diagnosis

NOTE Briefly pressing the "ADVANCE" pushbutton after selecting runs you through the diagnosis indication.

3.4.3 Starting Operation of the RO System

3.4.3.1 Operating Levels and Passwords

Normal Level:

In this level, the operating mode, the operating condition as well as the current measuring and operating values are indicated on the display (5/2) with the help of changing (rotating) masks (see figure 16).

NOTE The user operates the equipment in normal level. Entering a password is not required.

User Level:

The user level enables operation as well as adjustment of the most important functions and operating settings/parameters as well as the calibration of the LF sensors.

User password: ↑ → ↓ ← ↑

Technician Level:

The technician level is an extended user level. Apart from the functions of the user level, it enables the manipulation of all operating settings/parameters as well as a hardware test with the help of a diagnosis function.

Technician password: ↑ ← → ESC ↓ ↵ ↑ ← → ESC ↓ ↵ ↑

NOTE To enter a password, the respective key sequence must be entered in the normal level within one minute.

NOTE For settings and menus of the RO 1000 control system, see figure 22.

NOTE Enter the settings of the projected system in the diagram on page 64!

3.4.3.2 Menu Selection

The menu consists of several lines which are arranged below each other in a list. Two menu lines each are depicted on the display of the control.

In order to call up the function of a menu point, first select the desired menu point with help of the ↑ pushbutton and the ↓ pushbutton.

By pressing the RETURN pushbutton, the function of this menu point is called up. A menu is ended by pressing the **ESC** pushbutton (returning you to the normal level). For nested menus, the **ESC** pushbutton brings you back to the previous menu.

3.4.3.3 Selection of an Option

Options are selected with the ↑ pushbutton and the ↓ pushbutton. By pressing the RETURN pushbutton, the current option is stored as the new operating setting. A selection can be cancelled by pressing the **ESC** pushbutton.

3.4.3.4 Selecting Several Arguments at the Same

For this a series of "0" (argument inactive) and "1" (argument active) appears on the bottom line of the display. With help of the ← pushbutton and the → pushbutton, a cursor can be moved between the individual characters. The activation / inactivation of an argument is carried out with the ↑ pushbutton and the ↓ pushbutton respectively. Storing is carried out through pressing the RETURN pushbutton (Example: See Chapter 3.4.3.7).

3.4.3.5 Adjusting Operating Parameters and Balancing Values

For adjustment of operating parameters (e. g. via a menu), the name of the operating parameter appears in the upper line and the current value is shown in the bottom line. A flashing cursor marks the respective changeable figure, which can be adjusted to the desired value by pressing the ↑ pushbutton and the ↓ pushbutton. With help of the ← pushbutton and the → pushbutton, the marking can be slid to the respective other figure. Storing is carried out through pressing the RETURN pushbutton; the input can be cancelled by pressing the ESC pushbutton.

3.4.3.6 Acknowledging Data Inputs

To avoid input errors, acknowledgments are required at various menu locations. They request the user again to acknowledge changes of operational settings / parameters and adjustments as correct.

For acknowledgment the → pushbutton and afterwards the RETURN pushbutton must be pressed.

3.4.3.7 De-conserving

The RO system leaves the factory conserved. Therefore, the conservation liquid must be flushed out before the initial startup.

Initial situation:

The pre-filters have been put into service. The filter insert has been inserted at the fine filter 5µ. After all the water pipes and float switch have been connected, the drinking water pipe to the tank must be undone and temporarily fed to the wastewater sewer.

Work steps:

- Master switch on: system is in **switched off operating mode**
- Temporarily lay the drinking water pipe in the sewer
- Flush / purge system:
 - Pressure regulating valve (4.17) fully open (lever horizontal)
 - Concentrate regulating valve (4.15) half open (45°).

The following message must be indicated on the display:

RO 1000 V 01.34
Stop

Otherwise press the ESC pushbutton 5 times.
Then enter user password (cf. Chap. 3.4.3.1).

Indication:

↓-Press the pushbutton.

> 1 Error ack. <
2 Operating mode

Indication:

Press the RETURN pushbutton.

1 Error ack.
> 2 Operating mode <

Indication:

↑-Press the pushbutton.

Operating mode
Operation

Indication:

Press the RETURN pushbutton.

Operating mode
Switched off

Indication:

→-Press the pushbutton.

Execute ?
> no < yes

Indication:

Press the RETURN pushbutton.

Execute ?
no > yes <

Indication:

Press the RETURN pushbutton.

1 Error ack.
> 2 Operating mode <

Indication:

↓-Press the pushbutton.

Operating mode
Switched off

Indication:

Operating mode
Disinfection

System in **disinfection operating mode**.

Set the concentrate flow to 600l/h at the concentrate regulating valve (4.15).

CAUTION During **disinfection** operating mode, all confirmation queries are switched off!

CAUTION Observe the pressure downstream of the fine filter (manometer 4.7): As soon as it is less than 2 bar pressure immediately switch off the system. High-pressure pump running dry!

Leave the system to run in this condition for 20 minutes, then switch to **switched off** operating mode (cf. 3.4.5).

3.4.3.8 Initial startup

- Set the equipment to the operation operating mode (see 3.4.4)
- Set the drinking water capacity to 600 l/h
- For very cold water, the drinking water capacity of 600 l/h is not achieved: Then adjust the maximum pump pressure of 21 bar (MP) or 14 bar (LP)
- Adjust the concentrate capacity to 200 l/h (for very cold water possibly somewhat more)

Closing the pressure control valve (11/1)	Closing the concentrate control valve (11/8)
Pump pressure and concentrate pressure increase	Pump pressure and concentrate pressure increase
Drinking water amount increases	Drinking water amount increases
Concentrate amount increases	Concentrate amount decreases
Conducting capacity increase	Conducting capacity increase

Table 20 Operating performance of the reverse osmosis when changing the pressure control and concentrate control valve

CAUTION For all changes of the settings to the system, the following values may not be exceeded under any circumstances:

- Maximum pump pressure 21 bar (MP) or 14 bar (LP)
- Drinking water amount, 650 liters per hour maximum.

Untreated water	Drinking water capacity	Concentrate capacity	Yield
1200 l/h	600 l/h	600 l/h	50%
800 l/h	600 l/h	200 l/h	75%

Table 21 Typical yields at maximum drinking water capacity and untreated water temperature of 15 °C

NOTE The drinking water capacity must never be set at more than 650 l/h, meaning that at higher / lower feed-water temperature, the pump pressure and concentrate pressure must be decreased / increased respectively by means of the ball valves (compare figure 11).

Check the conductance value according to the reading on the display.

Demineralization rate: 94 – 99 %.

- Switch off the system at the main switch.
- Connect drinking water line in tank.
- Switch on the system at the main switch: Drinking water is produced and fills the tank.
- Tank filled: The level float switches off the solenoid valve and the pump until the switch of the level float signals empty and the RO system switches on again.

Checking the pressure control device (shut the untreated water supply for this):

The RO system must switch off after a short time.

THE "Fault" LED must light at the operating panel – **Lack of pressure** is indicated on the display (5/2).

- Afterwards, open the untreated water supply again.
- Delete the malfunction indication with the **ESC** pushbutton (5/3)
- Enter operator password
- Use **↑↓** keys to call up menu item "6 LF limits"
- **↵**-Press pushbutton
- Use the **↑↓** keys to set the limiting value (upper limiting value of the drinking water conductivity): 20% of the untreated water conductivity value
- Use the **→** key to change to warn value
- Use **↑↓** keys to set the warn value (warning value of the drinking water conductivity): 15% of the untreated water conductivity value

CAUTION The upper limiting value must not exceed the statutorily permissible drinking water conductivity! In case of doubt, take the statutory limiting value as the limiting value and enter the warning as half the statutory limiting value!

- Press the **↵** key: Display jumps back to "6 LF limits"
- Press **ESC**, display is in initial condition
- System has been checked and is ready for use.

3.4.4 Normal Operation

Switch on the RO 1000 control; the following message appears on the display:

RO 1000 V 01.34
Switched off

NOTE The system has been switched off in the user or technician level. Switching on without password is not possible!

When the following rotating masks appear:

RO 1000 V 01.34 production on	W-Temp: 12.3°C perm: 12 µS/cm	hours meter 1111 h 11 min
----------------------------------	-------------------------------------	------------------------------

Figure 16 User indication in normal operation

The system is ready to start, meaning the equipment can produce. Otherwise enter the user password (compare with Chapter 3.4.3.1).

Indication:

Press the ↓ pushbutton one time.

> 1 ackn. failure <
2 operat. mode

Indication:

Press the RETURN pushbutton.

1 ackn. failure
> 2 operat. mode <

Indication:

Press the ↑ pushbutton.

operation mode
STOP

Indication:

Press the RETURN pushbutton.

operation mode
OPERATION

Indication:

Press the → pushbutton.

are you sure ?
>no< yes

Indication:

Press the RETURN pushbutton.

are you sure ?
no >yes <

Indication:

Press the **ESC** pushbutton.

1 ackn. failure
> 2 operat. mode <

Indication:

The equipment produces and starts with rejection. Operating conditions:

RO 1000 V 01.34 Disposal

- „Production“ LED lights.
- “Reject“ LED lights.

After the reject period has run off, normal production with rotating indication:

RO 1000 V 01.34 Production on	W-Temp: 12.3°C perm: 12 µS/cm	hours meter 1111 h 11 min
----------------------------------	-------------------------------------	------------------------------

When the RO equipment starts, the intake valve for untreated water is opened and the RO pump starts after the preset time and given pressure.

3.4.4.1 Operating Messages for Normal Operation

1. System does not produce because tank is full:
 - The “tank full” LED lights at the operating panel.
 - Indication: “K. Displacement” and afterwards “Production off” on the display.

Cause: The float switch in the drinking water tank has switched.
2. System does not produce during regeneration / flushing:
 - The “regeneration” LED lights at the operating panel.
 - Indication: “Forced stop” on the display.

Cause: One of the preliminary filters is being cleaned.
3. The system does not produce at malfunction indication: Metering station empty
 - The “fault” LED lights.
 - Indication: Hard water.

Cause: Empty sensor in the metering container delivers signal.

Corrective action: Refill metering container with chemical and acknowledge.

NOTE The malfunction indication can be acknowledged by pressing the **ESC** pushbutton; the rotating indications for normal operation appear again (see above).

3.4.5 Putting Out of Operation

CAUTION Normally, do not switch off with the main switch (a possibly active flushing program may be interrupted).

NOTE The RO system working in normal operation is switched off only via the float switch when the drinking water tank is full.

NOTE The current operating mode is also maintained in the switched off condition, meaning after switching on again, the control system is in the same operating mode as before switching off last with the main switch.

The system is switched off e. g., when putting out of operation for extended periods. For out-of-operation periods exceeding 14 days, the equipment must be conserved (see Chapter 4.4.4).

Enter user password for this (compare with Chapter 3.4.3.1):

Indication:

Press the ↓ pushbutton.

> 1 ackn. failure <
2 operat. mode

Indication:

Press the RETURN pushbutton.

1 ackn. failure
> 2 operat. mode <

Indication:

Press the ↑ pushbutton.

operation mode
OPERATION

Indication:

Press the RETURN pushbutton.

operation mode
Stop

Indication:

Press the → pushbutton.

are you sure ?
>no< yes

Indication:

Press the RETURN pushbutton.

are you sure ?
no > yes <

Indication:

Press the **ESC** pushbutton.

1 ackn. failure
> 2 operat. mode <

Indication:

RO 1000 V 01.34
Stop

The equipment is switched off now.

3.4.6 Desinfection

Enter user password (compare with Chapter 3.4.3.1):

Indication:

Press the ↓ pushbutton one time.

> 1 ackn. failure <
2 operat. mode

Indication:

Press the RETURN pushbutton.

1 ackn. failure
> 2 operat. mode <

Indication:

Press the ↑ pushbutton.

operation mode
OPERATION

Indication:

Press the RETURN pushbutton.

operation mode
STOP

Indication:

Press the → pushbutton.

are you sure ?
>no< yes

Indication:

Press the RETURN pushbutton.

are you sure ?
no > yes <

Indication:

Press the RETURN pushbutton.

1 ackn. failure
> 2 operat. mode <

Indication:

Press the ↓ pushbutton.

operation mode
STOP

Indication:

operation mode
Desinfection

System in disinfection operation mode.

CAUTION During the disinfection operation mode, all safety quest are switched off!

CAUTION Observe the pressure after the fine filter: If less than 2 bar, switch off the equipment immediately. High-pressure pump running dry!

4 Maintenance

4.1 Fine Filter

The manometers (17/1 and 17/3) are located in front of and behind the fine filter unit (17/2). If the differential pressure is more than 0.8 bar, the fine filter is to be cleaned or replaced:

- Stop the untreated water supply until the system is in the lack of pressure operating condition.
- Switch off the main switch.
- Release the pressure in the equipment (open the sampling valve for untreated water).
- Replace filter.



Figure 17 Replacing the fine filter

NOTE Replace the fine filter every 3 months.

NOTE Use the special filter wrench!

4.2 Metering Station WTC 600 CD

Every 4 weeks:

Clean the inside of the metering tank and thoroughly rinse with chlorine-free drinking water.



When working on the metering head or on the connections and lines, wear protective clothing (goggles, gloves)!

Before any maintenance, disconnect the pump from mains (pull mains plug)!

Every 12 months (or when malfunctions occur):

Cleaning the suction and pressure valves

- Unscrew valve and take out inner part of valve.
- With a thin wire pin (nail or similar), carefully remove the valve inner part in flow direction (see arrow mark on valve body).
- Disassemble the inner part (seat, O-ring, balls, ball cages) and clean; replace if necessary.
- Reassemble valve again and screw in.

CAUTION Observe direction of flow (arrow)!
Tighten valve by hand only (danger of damaging)!

¹⁾ Feinfilter 5µ: Art.-Nr. 6.414-466.0

Replacing the membrane

- Set the pump lift adjustment knob (8/1) to 100 %.
- Unscrew the 4 screws, size 6 mm, at the metering head and remove the metering head.
- Unscrew the membrane to the left.
- Reattach the sealing membrane¹⁾, intermediate ring and support disc again.
- Screw in new membrane.
- Bring the push rod to the “end of suction stroke” position by switching the mains voltage on/off.
- Reassemble metering head and tighten screws over cross (tightening torque 4 Nm).
- Bleed the pump (8/3) and put into operation again.
- After 48 hours of operation, retighten the metering head screws (tightening torque 4 Nm).

4.3 Reverse Osmosis Module (RO Module)

4.3.1 RO Filter Replacement

The RO filters are to be replaced when cleaning and disinfection as a measure to increase the capacity have been without success.

Filter replacement:

- Select the switching off operating mode and release the system pressure.
- Loosen the connections (concentrate connection (18/2), drinking water connection (18/1) and supply (18/5)) and unscrew pressure tube (18/4) with tube clamps (19/5) from the frame.

CAUTION Do not loosen the tube clamps because of height adjustment.

- Release securing rings (19/1).
- Unscrew connections (19/2).
- Screw extractor tool into thread of drinking water connection (19/3) and carefully lever out using pipe pliers.
- Remove adapter from lid, clean and insert.
- Take out filter and remove lower lid.

NOTE Do not interchange lids.

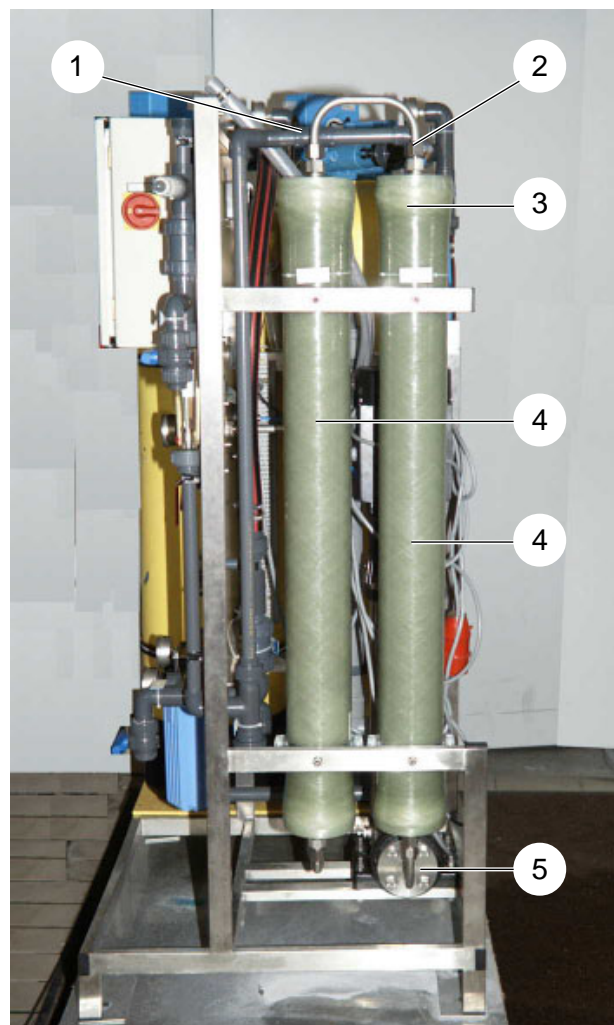

Figure 18 RO-Modul

¹⁾ Membrane replacement set: Item No. 6.762 172.0

- Apply Propandiol¹⁾ to the rubber seals.
- Insert a new filter (19/7) at the supply opening (end without seal first!).
- Attach all adapters.
- Insert lid (19/4) in such a manner that the threads of the openings are flush with the nuts of the clamp (19/5).
- Install securing rings and screw in connections.
- Fasten module to frame and connect pipe lines.
- Flush the equipment for 10 minutes (3.4.3.7).
- Switch to the operation operating mode:
- The equipment values must correspond with those of the initial start-up.

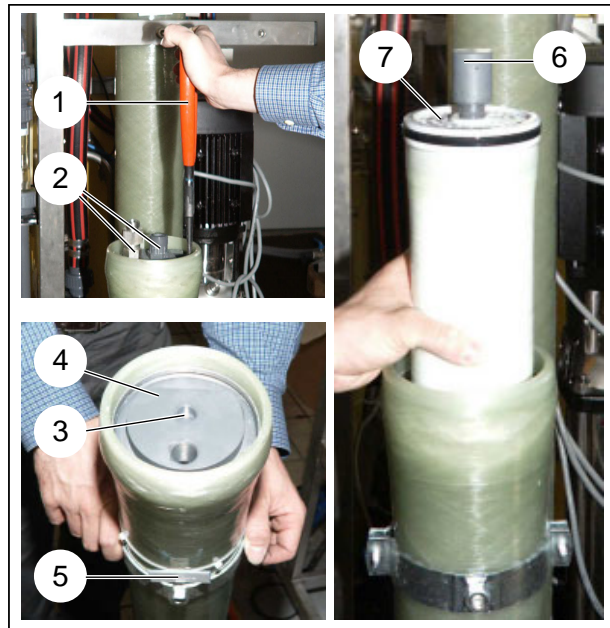

Figure 19 Assembly and disassembly of the RO filter

4.4 Cleaning in Case of Malfunction

The following measured variables or their change from the original values (cf. operating certificate) are indicators for the need for cleaning or disinfecting the system.

The WTC 600 service kit (2.901.044.0) is intended for cleaning the WTC 600. Apart from the cleaning chemicals and a wet-dry vacuum, it contains all the equipment needed for cleaning and conserving the WTC 600 LP and MP.

The cleaning chemicals must be ordered separately.

The system should be cleaned if the following differences occur compared to the initial startup

- The drinking water flow drops by 200l/h at the same pressure
- The conductivity doubles at the same pressure and temperature
- The differential pressure between the pump pressure and concentrate pressure increases by more than 2 bar.

NOTE Alkali cleaning with RM MCT 511 first, then acid cleaning with RM MCT 103.

NOTE Only disinfect if cleaning is unsuccessful.

¹⁾ Propandiol: Item No. 6.290-910.0

4.4.1 Design of the Flushing and Disinfection Equipment

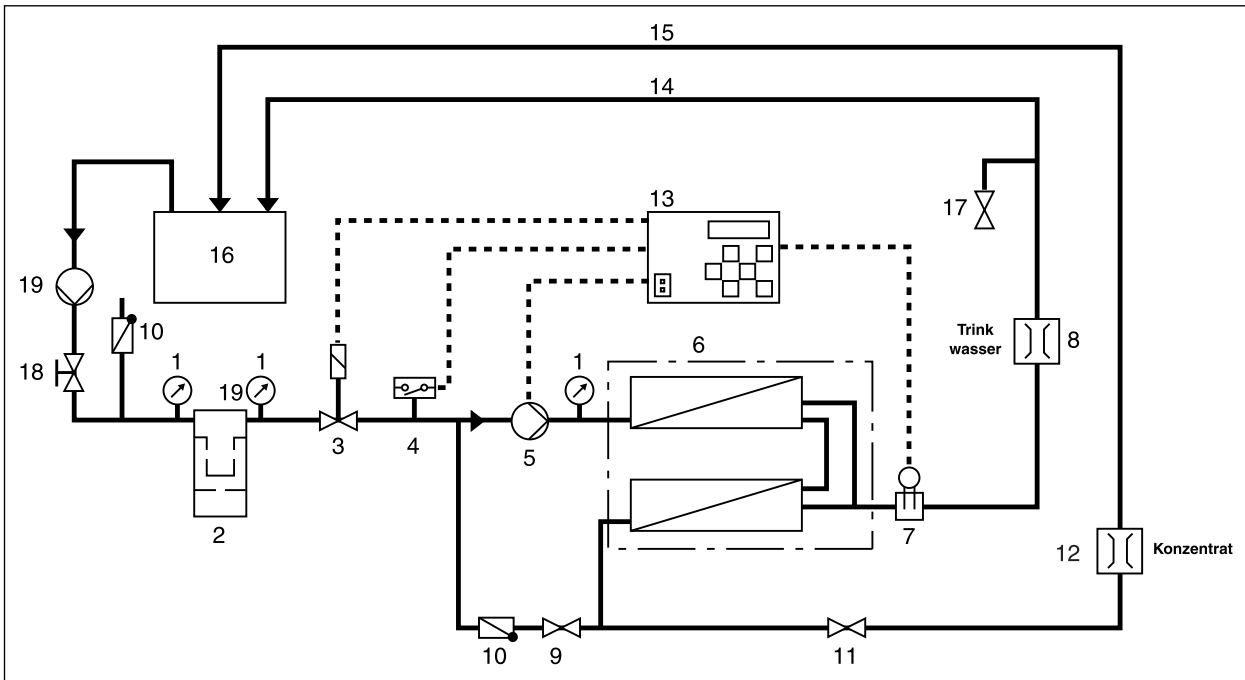

Figure 20 Diagram of connection principle for cleaning conserving and disinfection of the RO equipment

- | | | |
|---------------------------|---|--|
| 1. Manometer | 8. Flow meter (drinking water) | 15. Concentrate to the flushing tank |
| 2. Fine filter | 9. Pressure control valve | 16. Flushing tank |
| 3. Solenoid valve | 10. Check valve | 17. Sampling valve for drinking water |
| 4. Pressure switch | 11. Concentrate control valve | 18. Sampling valve for untreated water |
| 5. RO Pump | 12. Flow meter (concentrate) | 19. Flushing pump |
| 6. Pressure tube / module | 13. Electrical control system | |
| 7. Measuring cell | 14. Drinking water to the flushing tank | |

Aids:

- Cleaning tank
- Four connection hoses
- Conductive capacity measuring unit for measurement comparison after flushing
- Protective clothing (goggles, gloves, apron)
- External pump as flushing pump

Starting Position:

- RO equipment set to **switched off** operating mode and switched off with main switch.

Work Steps:

1. Fill 30 liters of chlorine-free drinking water into the flushing container (20/16).
2. Switch on master switch and set RO system to "**Switched off**" operating mode.
3. Close the untreated water inlet; depressurise system:
 - Use connection hoses and flushing pump (20/19) to connect the flushing tank with the untreated water sampling tap
 - Feed the drinking water adapter and connection hose from the drinking water outlet (20/8) to the flushing tank
 - Feed the concentrate adaptor and connection hose from the concentrate outlet (20/12) to the flushing tank
 - Unplug the earthing-contact plugs of the metering pumps.
 - Switch the flushing pump on.
4. Switch the system to **disinfection** operating mode and adjust the water pressure to 2 bar using the untreated water sampling tap.
5. Disconnect the metering pump earthing pin plug.
5. If none of the connections are leaking, switch off the flushing pump, set the RO system to "**switched off**" operating mode and make up the cleaning solution by addition to chemicals in accordance with Tables 22, 23 and 24 to the flushing tank.



**Carefully add chemicals while stirring continuously.
Definitely wear protective clothing for this!**

4.4.2 Disinfection

A disinfection of the RO equipment becomes necessary when acidic and alkaline cleaning was not successful.

NOTE The metering containers, supply lines, etc. should also be disinfected.

Aids:

- Per-acetic acid test stripes¹⁾
- Chemicals for disinfection and neutralization.

Work Steps:

1. The equipment is prepared for disinfection (compare with Chapter 4.4.1)
2. Switch the flushing pump on
3. RO equipment in the disinfection operating mode; allow disinfection solution to circulate for approx. 5 -10 minutes
4. RO equipment in the switched off operating mode; allow disinfection solution to react for approx. 15 minutes
5. After disinfecting, dispose of the solution according to the regulations
6. Connect the soft water supply to the RO equipment again; guide drinking water and concentrate outlet to the canal

CAUTION The drinking water and concentrate line must not have contact with the canal due to danger of germs (free fall as in pouring).

7. Plug in the earthing-contact plugs of the metering pumps
8. Open the untreated water valve and switch the RO equipment to the operation operating mode
9. Flush the RO system for approx. 30 minutes and use peracetic acid test strips (peracetic acid content 0 mg/l) to check the drinking water is free of disinfectant; adjust system and enter disinfection in the operating log book
10. Reinstate the original piping layout
11. Thoroughly flush the hoses and pump with drinking water! Danger of corrosion!

Volume of the disinfection solution [l]	RM P3-Oxonia-Active [ml]	Item No.
30	75 (= ½ bottle)	6.294-010.0

Table 22 Composition of the disinfection solution

¹⁾ Item No. 6.768-354.0

4.4.3 Acidic and Alkaline Cleaning

If the original drinking water capacity and quality can not be reached, an acidic cleaning or an alkaline cleaning of the equipment is to be carried out.

Aids:

- Universal indicator paper¹⁾ pH 0-14
- Chemicals for cleaning and for neutralization.

Work Steps:

1. The equipment is prepared for cleaning (compare with Chapter 4.4.1).
2. Switch the RO system to the **disinfection** operating mode and allow the cleaning solution to circulate for approx. 30 minutes.

CAUTION Maximum temperature of the cleaning solution during cleaning: 35 °C.
Minimum temperature of the cleaning solution during cleaning 15 °C.

CAUTION End the cleaning when a change of the pH-value can no longer be detected.

CAUTION If the cleaning solution is strongly soiled, it should be neutralized and rejected.
Continue the cleaning with new solution.

3. After finishing the cleaning, switch the RO equipment to the **switched off** operating mode,
4. Connect the untreated water supply to the RO equipment again; guide drinking water and concentrate outlet to the canal.
5. Plug in the earthing-contact plugs of the metering pumps
6. Switch the RO equipment to the **operating mode**
7. Leave the RO system to run for 30 minutes.
8. Reinststate the original piping layout
9. Regulate the RO equipment according to the type plate and draw up record
10. Dispose of the cleaning solution in accordance with the regulations.

¹⁾ Item No. 6.768-355.0

4.4.3.1 Cleaning Solution for Acidic Cleaning

Volume of the cleaning solution [l]	RM Kleen MCT 103 [l]	Item No.
30	1,0	6.294-009.0

Table 23 Composition of the cleaning solution for acidic cleaning

Neutralise by adding soda (6.287-014), until the pH value is approx. 7.

4.4.3.2 Cleaning Solution for Alkaline Cleaning

Volume of the cleaning solution [l]	RM Kleen MCT 511 [l]	Item No.
30	1,0	6.294-008.0

Table 24 Composition of the cleaning solutions for alkaline cleaning

Neutralise by adding RM Vaporapid bio descaling acid (6.290-239), until the pH value is approx. 7.

4.4.4 Conserving

4.4.4.1 Drain the metering station and flush

Initial situation:

- RO system switched off

Work steps:

1. Dispose of the contents of the metering stations according to the local regulations.
2. Flush the tank with drinking water.
3. Flush the metering pumps with drinking water.
4. Unscrew the metering hoses and drain.

4.4.4.2 Conserve the RO system

When the RO equipment should not be used for more than 14 days, then it must be conserved.

NOTE After a maximum of 6 months, the conservation means must be flushed and renewed, if required.

Aids:

- Conserving tank
- Four connection hoses
- Chemicals for conservation (compare with Table 25) and for neutralization
- Conductive capacity measuring unit, for measurement comparison after flushing
- Protective clothing (goggles, gloves, apron)
- External pump.

Starting Position:

- RO equipment set to switched off operating mode and **switched off** with main switch.

Work steps:

1. Fill 25 litres of chlorine-free drinking water into the flushing tank (20/16).
2. Connect the untreated water inlet; depressurise the system:
 - Use the connection hoses and flushing pump (20/19) to connect the flushing tank with the untreated water sampling tap
 - Feed the drinking water adapter and connection hose from the drinking water outlet (20/8) to the flushing tank
 - Feed the concentrate adapter and connection hose from the concentrate outlet (20/12) to the flushing tank
 - Switch on the flushing pump.
3. Switch system to **disinfection** operating mode and adjust water pressure to 2 bar (manometer 4.7) using the untreated water sampling tap.
4. Disconnect the earthing pin plug of the metering pumps.
5. Add sodium bisulphite to the flushing tank.
6. If the system is to be protected against frost, then slowly add the RM 1,2 propandiol.
7. Allow the conservation solution to circulate for 10 minutes.
8. The more RM 1,2 propandiol is added the lower the drinking water flow. Do not change the pressure regulating valve and concentrate regulating valve settings.
9. Set the system to **switched off** operating mode and switch off the master switch.
10. Disconnect the flushing tank and seal the untreated water inlet as well as the drinking water and concentrate outlet with sealing discs (5.005-260.0) (same places as for initial startup, cf. Chap. 3.3.1.2).

NOTE Dispose of the conservation solution according to the regulations.

Preservation solution [l]	Sulfite 5kg ¹⁾ [g]	RM 1,2 Propandiol 5l ²⁾ [l]
30	300	5,0

Table 25 Chemicals for conserving solutions

4.4.4.3 Drain the pre-filter

If the WTC 600 is shutdown for a lengthy period, the pre-filters have to be drained. this prevents bacterial growth and the filter material from caking as well as frost damage.

Work steps:

1. Back-wash both pre-filters to remove any air from the containers.
The first back-washing step can be aborted after one minute by pressing the "manual regeneration" key, the 4th step can be skipped by pressing the "manual regeneration" key.
2. Interrupt the untreated water supply, depressurise the filter.
3. Undo hose 6.390-962.0 from the hose nozzle at the outlet of the activated carbon filter.
4. Attach a connection hose to this hose nozzle and screw tight with a hose clamp.
5. Fix the other end of the connection hose to the filter control heads.
6. Keep the untreated water supply open until water comes out of the connection hose.
7. Interrupt the untreated water supply and undo the screw fitting at the media filter inlet (of the AM version) or the activated carbon filter inlet (A version).
8. Quickly place the end of the connection hose in a discharge which is lower than the WTC 600 system: the filters are levered out (if necessary, repeat steps 5-8).

4.4.5 Removing the Preservation After Longer Operational Interruptions

Carry out the following work steps to remove the preservation:

1. Remove the blind discs (see Section 3.3.1.2).
2. Provisionally connect the drinking water line to the waste water canal.
3. Completely fill the media and activated carbon filters with water (remove the control head first) and backwash each twice.
4. Flush the reverse osmosis (see Section 3.4.3.7).
5. Replace the fine filter, if required.

¹⁾ Sulfite 5 kg: Item No. 6.769-040.0

²⁾ RM 1,2 Propandiol, 5l: Item No. 6.290-910.0

4.4.6 Flushing the pre-filter

The WTC 600 LP/MP pre-filter must be flushed if the differential pressure of the pre-filter immediately after back-washing is more than 0.5 bar.

CAUTION Before flushing the filter, check the manometer for correct display values and exchange if necessary!

CAUTION Pre-filter blockages are caused above all by changed water constituents. A renewed water analysis must be carried out in order to remove the cause of blockages. Notify sales department! Additional treatment stages possibly required!

- Composition of the pre-filter flushing service kit

Auxiliaries:

- Flushing tank
- Four connection hoses
- Conductivity measuring device for comparative measurement after flushing
- (Goggles, gloves, apron)
- Flushing pump

Initial situation:

- RO system set to **switched off** operating mode and with master switch switched on.

Work steps:

1. Add 30 litres drinking water to the flushing tank and add 2.2 litres RM Kleen MCT 103
2. Dismantle the back-washing hoses at the pre-filters, connect the service kit hoses and feed to the flushing tank
3. Connect the flushing pump to the pre-filter untreated water inlet
4. Start back-washing
5. Switch on flushing pump
6. Leave the flushing solution to circulate until the back-washing is finished (approx. 10 min)
7. Leave the flushing solution to stand for 30 minutes
8. Repeat the procedure from item 4 once again
9. Reinststate the original piping and carry out a complete backwash.

If this cleaning is unsuccessful, the media filter must be disinfected. The service kit contents and the flushing sequence is the same as for flushing the pre-filter, however the chemicals used are those given in table 26.

System output [l/h]	Volume of disinfectant solution [l]	RMP3 Oxonia active 15% [l]	Art.-No.
600	30	0,75	6.294-010.0

Table 26 Composition of the disinfectant solution

10. Flush the service kit with drinking water
11. Switch the RO system to **run operating mode**.

4.4.7 Replace the activated carbon or filter sand

If the differential pressure at the pre-filters does not reduce despite flushing the filter medium (cf. Chap. 4), the filter material must be replaced.

Auxiliaries:

- Wet-dry vacuum NT 602 ECO 1.408-151.0
- 4 metal suction pipes, 0.5m 6.902-050.0
(Remove the plastic rings from the metal pipes)
- Filling funnel 4.901-090.0
- Shovel 6.812-049.0

Spare parts required:

- Activated carbon filter bed 6.414-721.0
- Sand filter bed 6.414-714.0

Spare parts possibly required:

- Filter pressure tank 6.414-710.0
- Set of O-rings 6.414-713.0

Initial situation:

- WTC 600 set to **switched off** operating mode and switched off at the master switch
- Untreated water pipe shut off

Work steps:

1. Unscrew the controller from the control head and place to the side
2. Unscrew the untreated water, filtrate and back-washing pipes from the control head
3. Unscrew the control head from the pressure tank and pull off the submerged pipe
4. Suck out the water and filter material

Tip: If the suction pipe blocks, loosen by sucking in air and shaking the pipe.

CAUTION Firmly push the metal pipes together or secure with thin adhesive tape!

5. Clean the pressure tank with clean water and check for internal damage
6. Fill with new filter material (cf. Chap. 3.4.2.1 Initial fill)
7. Screw on the control head, reinstate the connections, fit the controller
8. Reinstate untreated water inlet
9. Switch on the WTC 600 at the master switch and trigger two consecutive backwashes
10. Switch the WTC 600 to **Run operating mode**
11. Finished

Disposing of the replaced filter material:

The replaced filter material must be disposed of according to the local waste regulations.

4.5 Malfunction, Cause and Corrective Action

4.5.1 Metering Station LED and Indicator LEDs at the Switch Cabinet

Indication	Malfunction	Cause	Corrective Action	Chap./ Fig.
Red fault LED lights	Pump in metering station blocked	Metering container empty	Refill, check float switch	2.3.1.5, 3.2,3.3.2.4
		Sensor signal missing	Check sensors, check bridges in switch cabinet, check sensor wiring	2.3.1.5, ETL, 3.3.2
Red regeneration LED lights		Backwashing of the sand filter or activated carbon filter active	Not necessary, as the equipment automatically switches on again	2.3.1.5
Red tank full LED lights	Float switch in the drinking water tank has switched	Drinking water tank full	Not necessary, as the equipment automatically switches on again;	2.3.1.5, 3.3.2.4
		Switch defective	Check switch, replace if necessary	

Table 27 Malfunction indications at the switch cabinet and their causes

Indication	Malfunction	Cause	Corrective Action	Chap./ Fig.
Green LED at metering station pump does not flash	LED does not flash when high-pressure pump runs	No power supply	Have fuse Q2 checked from electrician	
		Operating mode contact	Set operating mode switch to manual	(1/10)
		Electrical defect	Replace pump	ETL
Red LED at metering station pump lights red	Pump blocked	Metering container empty	Refill, check float switch	3.2, 3.3.2.4
		Cable that indicates empty is broken	Have cable checked	3.3.2.3
		Auxiliary contactor in switch cabinet defective	Have auxiliary contactor replaced by electrician	ETL, SLP

Table 28 Metering station and metering pump LED

4.5.2 Malfunction Indication at the Operating Panel

The control system detects operational malfunctions only while in **operation** operating mode; these are indicated on the display. The occurrence of an error usually leads to the complete system being switched off (production is interrupted).

Indication	Malfunction	Cause	Corrective Action	Chap./ Fig.
Motor/ hard water	Metering containe empty		Fill up	3.2
Lack of pressure	PI station gene- rates no pressure	No water available	Establish the flow of untreated water again	
		Air in the pump	Bleed the pump; connect pump directly in canal, run for 30 sec.	
		Suction height too high, pump is not self-priming	Ensure supply pressure to the pump (mains supply, submerged pump, ...)	
	Supply pressure of the reverse osmosis too low	Flow rate through preliminary filter too low	see 4.5.4	
	Differential pressure of the preliminary filter >>1 bar	Filter soiled	Replace filter cartridge	4.1
	Pressure switch defective		Replace pressure switch (pay attention to setting)	2.2, Pos. 4.9
	Flow rate in sand filter too low	Filter clogged	Initiate backwashing	3.4.2
Conductance value exceeded	Permeate conductance value too high	Yield too high	Increase flow of concentrate	3.4.3.7
		Very high salt content in untreated water	Check cause; notify sales dept.	¹⁾
		Defective seal or membrane	Replace parts; switch off system, if required	ETL
	Conductance value probe defective		Calibrate again; replace if required	ETL, SLP

Table 29

¹⁾ See untreated water analysis, operational start-up record

4.5.3 Malfunctions of the RO Control and Metering Pump

Indication	Malfunction	Cause	Corrective Action	Chap./ Fig.
Indication of RO control dark	Fuse defective		Have replaced by electrician	ETL, diagram in switch cabinet
	Short circuit, general		Replace defective parts	
	Solenoid valve defective		Replace defective parts	ETL
	Motor winding defective		Replace defective parts	ETL
Water level in container is constant for days	Pump does not draw in	Suction line untight	Retighten screwed fittings. Replace suction line	ETL
		Suction line clogged	Flush or replace suction line	
		Crystals, debris in the valves (metering head)	Clean valves	4.2
		Membrane torn or membrane push-rod torn out	Replace membrane	4.2
	Pump does not meter	Air in the suction line and in the metering head	Bleed pump	
		Lift adjustment a zero	While the pump is running, turn in "+" direction (adjustment values, see 3.3.1)	
		Crystals, debris in the valves (metering head)	Clean valves	4.2
		Valves not mounted correctly	Check correct line-up of valves and correct, if required (direction of arrow!)	
		Injection fitting blocked	Check direction of flow and correct, if required, or eliminate plug (direction of arrow!)	

Table 30

4.5.4 Malfunctions – Media and Activated Carbon Filter, Fine Filter and Flocculation

Indication	Malfunction	Cause	Corrective Action	Chap./Fig.
More than one backwashing per day (diagnosis controller)	Backwashing is initiated too often	Load of debris too high	Install suitable preliminary treatment; consultation through sales	3.4.2.4 Tab. 24
	Backwashing no sufficient	Pump defective	Replace pump or repair	
		Intake side of pump clogged	Clean	
		Intake side of pump too long	Shorter line set-up; notify sales	
	Sand conglutinated	Heavily soiled water	Notify sales	
Differential pressure of fine filter quickly exceeds 1 bar	Filtrate of the sand filter turbid	Small particles come through	Install preliminary treatment	4.1
	Filtrate of the activated carbon filter turbid	Small particles come through	Check sand filter; install preliminary treatment as required	4.1
	Filter material conglutinated	No backwashing carried out for too long	Carry out backwashing; if without success, replace sand	3.4.2.1
		Too much flocculation agent added	Reduce metering amount of flocculation agent; carry out backwashing	
Indication of the controller remains dark		Power supply disconnected	Notify electrician	
Control wheel does not stand still		Control switch or switching mechanism defective	Replace controller	
No changes of the "back-washing" counter	Backwashing is not initiated	Controller incorrectly programmed	Change programming	3.4.2.4

Tabelle 31

4.6 Maintenance Plan

4.6.1 Maintenance During Operation

Module	Cycle / Time	Activity	Chap./Fig.
RO module: Flow meter	Daily	Check drinking water capacity	3.3.1.2, (11/6)
RO module: Differential pressure	Daily	Check pump and concentrate pressure	(1/13) (1/14)
RO control: Display	Daily	Check drinking water conductance value	(1/11)
Metering container	Weekly	Check filling and refill	3.2
Media filter/activated carbon filter	Weekly	Automatic backwashing (check operation meter)	3.4.2.4
Control sheet	Weekly	Fill out	Appendix
Metering stations	Every 4 weeks	Clean and flush metering container	4.2
Float switch, drinking water tank	Every 4 weeks	Visual check of switch	
Metering stations	Yearly or every 4000 hours	Clean intake and pressure valves	4.2
Metering stations	Yearly or every 4000 hours	Replace membrane	4.2
Fine filter	Every 3 months	Replace filter	4.1
RO module (when conserved)	Every 6 months	Renew conservation	4.4.4

Tabelle 32

4.6.2 Maintenance Plan – Service

NOTE Measured and read values are to be entered into the maintenance record.

Module	Work to be Carried Out
Media filter	Assess general condition
	Differential pressure after backwashing
	Read adjustment of the differential controller
	Read amount of backwashings
Activated carbon filter	Assess general condition
	Differential pressure after backwashing
	Chlorine measurement in filtrate (1/18
	Read amount of backwashings
Fein filter	Read differential pressure
	Amount of used up filters since last service
Reverse osmosis	Assess general condition
	Data input according to daily operating log and operational start-up record
	Leakage tightness of the complete equipment, in particular
	Changeovers PVC-metal Sliding sealing, high-pressure pump
	Question the operator about malfunction indications
Metering pump	Clean / replace valves
	Replace membrane
	Functional test of float switch
	Function of empty signal to reverse osmosi
	Leakage tightness, corrosion

Table 33 Maintenance work to be carried out during service

4.7 Other Maintenance

When the RO equipment should not be used for more than 14 days, then it must be conserved. After a maximum of 6 months, the conservation means must be flushed and renewed, if required.

Appendix:**RO control factory settings:****WTC 600 LP, LP-A, LP-AM in voltages 230 V and 400 V**

Operating mode	Switched off	
LF limits	GW:	600
	GWV:	160
Alarm option	Switch off	
Calibration	Permeate temperature	Executed
	Permeate conductivity	Executed
Settings	t-GW delay:	01 min
	t-GWV delay	05 min
	t-pressure deficit	1 s
	t-Press. start up delay	9.9 s
	t-pressure available	60 s
	t-discont. flushing	10 min, or longer depending on specifications
	t-flushing interval	24 h, or less depending on specifications
	t-Concentrate displacement	01 min
	t-min disposal	min. 005 s
	t-max disposal	max. 60 min
	t-maintenance	3500 h
	Vw fault acknowledgement	No password
	Vw concentrate	Displacement
	Vw tank type	With overflow
Inputs	Forced stop	Break contact
	Motor protection	Break contact
	Pressure switch	Break contact
	Tank min.	Break contact
	Tank max.	Break contact
Language	English	

Tabelle 34

WTC 600 MP, MP-A, MP-AM in voltages 230 V and 400 V

Operating mode	Switched off	
LF limits	GW:	1500
	GWV:	400
Alarm option	Switch off	
Calibration	Permeate temperature	Executed
	Permeate conductivity	Executed
Settings	t-GW delay:	01 min
	t-GWV delay	05 min
	t-pressure deficit	1 s
	t-Press. start up delay	9.9 s
	t-pressure available	60 s
	t-discont. flushing	10 min, or longer depending on specifications
	t-flushing interval	24 h, or less depending on specifications
	t-Concentrate displacement	01 min
	t-min disposal	min. 005 s
	t-max disposal	max. 60 min
	t-maintenance	3500 h
	Vw fault acknowledgement	No password
	Vw concentrate	Displacement
	Vw tank type	With overflow
	Inputs	Forced stop
Motor protection		Break contact
Pressure switch		Break contact
Tank min.		Break contact
Tank max.		Break contact
Language	English	

Tabelle 35

RO control program structure

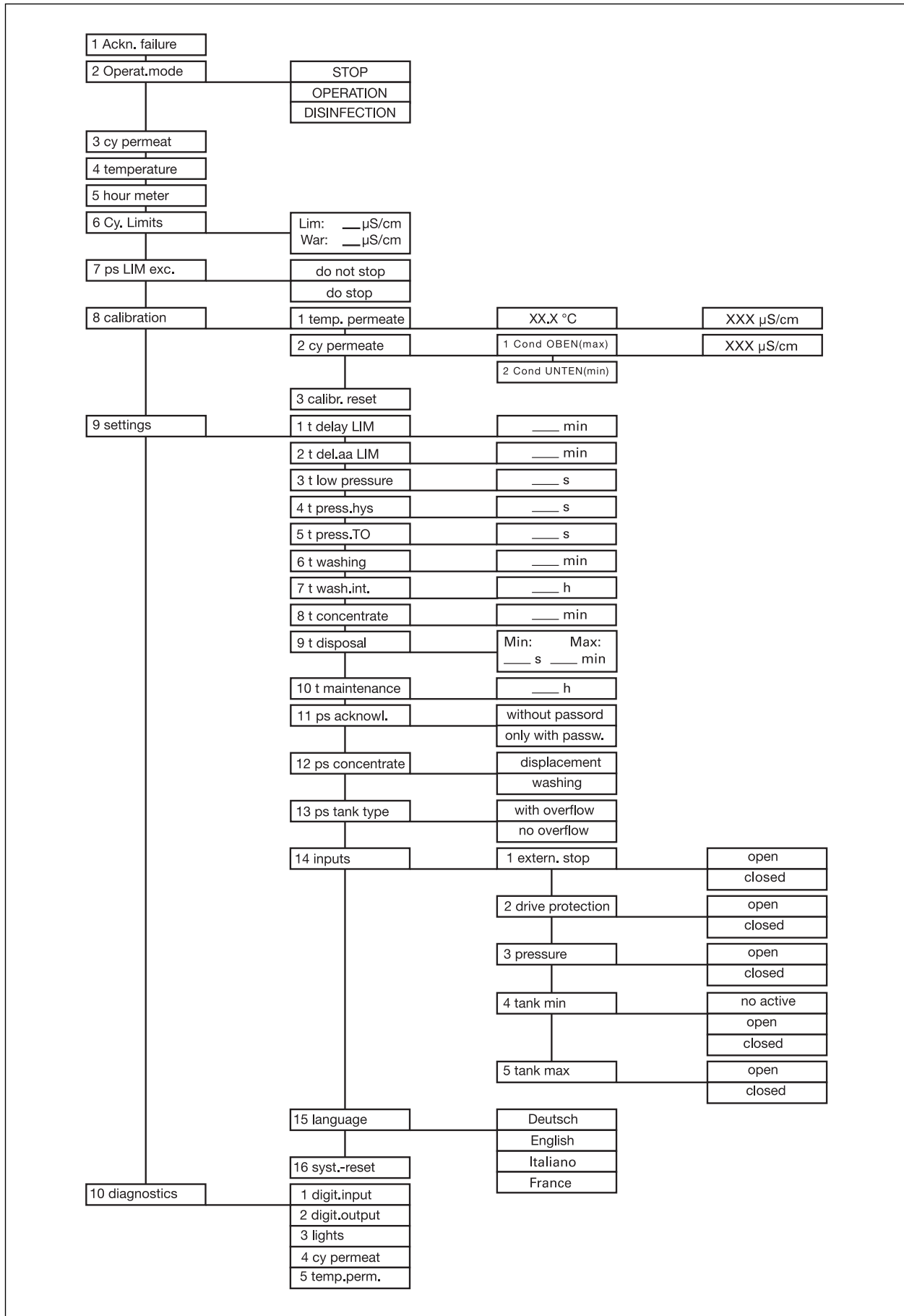

Figure 21

RO 1000: Manual

Control System

RO 1000

MANUAL

Contents

1	General	69 - 74
1.1	General remarks	69
1.2	Scope of Application	69
1.3	Instructions for Use	70
1.4	Safety Instructions	70
1.5	Terms and Definitions	71
1.6	Declaration of Conformity	71
2	Installation/Start-up	72 - 73
2.1	Basic Requirements	72
2.2	Start-up	72
2.3	Function of Terminals	73
3	Operational Scope	74 - 79
3.1	Operating Settings	74
3.2	Operating Parameters	75
3.3	Operating Modes	76 - 77
3.4	Operating Conditions	78
3.5	Operating Failures/Failure messages	79
4	Operation	80 - 88
4.1	User Interface	80
4.2	Basic Elements	81
4.2.1	Password Entry	81
4.2.2	Selection of menu	81
4.2.3	Selection	81
4.2.4	Multiselection	82
4.2.5	Numerical Editing	82
4.2.6	Alphanumerical Editing	82
4.2.7	Confirmations	82

Contents

4.3	Operating Levels	83
4.3.1	Normal Level	83
4.3.2	User Level	83
4.3.3	Technician's Level	83
4.4	Menu Structure	85
4.4.1	Main Menu	86
4.4.2	Calibration Menu	87
4.4.3	Setting Menu	88
4.4.4	Diagnosis Menu	88
5	Technical Data	89 - 90

1 General

1.1 General Remarks

The present Manual is the technical documentation of the RO 1000 control system for reverse osmosis units.

When studying this manual, it would be useful to have the control system ready for operation so that you can directly try to realize the explained items and functions. As some of the modules are directly related to other ones, it is recommended to follow the given order of the different chapters.

Should there arise any problems or questions during the operation of the control system, please ask for our advice and assistance. Please try to localize the problem as exactly as possible and to record any actions or conditions which caused the problem; this will enable us to help you as quickly as possible.

The supplier does not accept any liability with regard to any faults contained in this documentation. Under no circumstances whatsoever a liability for any damages related directly or indirectly to the delivery and use of this documentation is accepted.

1.2 Scope of Application

The RO 1000 system is a control system for reverse osmosis units of different sizes. Its technical features are:

- Microprocessor control with liquid crystal text display and keyboard covered with a protective film.
- LED displays for operation, malfunction, disinfection, disposal, regeneration and tank full
- Circuit inputs: regeneration, motor protection (available by Limitent contact), pressure switch, min. permeate level as well as max. permeate level
- Relay outputs: inlet valve, outlet valve, concentrate valve, system pump as well as alarm
- Conductivity sensor for permeate, optional 2 to 200 $\mu\text{S}/\text{cm}$, resolution: 0.2%, accuracy: 1%, temperature compensation with integrated sensor
- Self-explanatory menu-assisted operator environment
- All settings and adjustments via keyboard/text display, no mechanical adjustments (potentiometers, trimmers, switches, plug-in bridges)
- Any process time can be set
- Preselection for tank type (with/without overflow), hardwater production (admissible/not admissible), concentrate displacement/disposal
- Hour meter with maintenance interval message
- Protection against improper acknowledgement of failures
- Permanent display of measured values
- Two-point calibration
- Technical diagnostic function

1.3 Instructions for Use

The following instructions should be followed when operating the control system:

- Do not switch on/off the control system in quick succession. Wait at least 5 seconds between switching the main switch on and off.
- The control system should only be operated under the ambient conditions (temperature, humidity) mentioned in the technical data (see item 5). It is particularly important to protect the control system against water and humidity. It must not come into contact with splash water or condensed water.
- Manufacturer's seals (trimmer fixation, EPROM labels) must not be damaged. Otherwise the right to assert claims for defect shall lapse.
- Should the control system become defective, take note of the type of problem (consequences) before removing the system. The system can only be repaired if it is completely removed and the failure correctly described.
- The max. admissible load of the circuit outputs as well as the total admissible load of the unit (see item 5) must not be exceeded.

1.4 Safety Instructions

The following safety instructions are imperative:

- Diagnosis (see item 3.3) allows direct manipulation of all actuators (valves, pumps,.etc.) without interlocks or monitoring. Access to this function therefore requires a password and only should be used by the experts.
- Should the control system not react in the normal way, it has to be switched off immediately and the maintenance service has to be informed.
- Do not try to repair the control system yourself (loss of guarantee), always call the authorized maintenance staff. Only this will guarantee a reliable and safe function of the system.
- When a protection device was activated (fuse, motor circuit breaker) you should first try to clear the problem (e.g. clean the pump) before reactivating the protection device. Frequent actuation always is due to a sensor/actuator failure which also could damage the control system itself.

Non-observance of these instructions may cause damage to the control system and the unit which may result in a loss of warranty.

1.5 Terms and Definitions

The following scripts will be used for this manual:

Item	Script	Examples
keys LED's inlets/outlets	capital letters + bold capital letters + bold capital letters + bold	LEFT, UP, DOWN RINSE, DISPOSAL PUMP FAILURE, INLET VALVE
operating settings operating parameters	italics italics	<i>ps-hard water, ps-pumps</i> <i>LIM, t-rinse</i>
operating modes operating conditions operating failure	capitals + underlined capitals + underlined capitals + underlined	<u>STOP, ON</u> <u>PRODUCTION; DISPOSAL</u> <u>MOTOR FAILURE, FORCED STOP</u>

The following abbreviations will be used:

- Cy-perm permeate conductivity
- t-perm permeate temperature

Remark: The terms **on/off** as well as **STOP and OPERATION** could cause mix-ups; they are therefore defined as follows:

- **On/off** describes the existence/non-existence of the mains supply voltage
- **STOP and OPERATION** describe an operating condition which obviously only can exist when the system is switched on.

1.6 Declaration of Conformity

The Control Unit complies with the following standards and test regulations:
(to be fixed in the framework of the CE conformity standards)

2 Installation/Start-up

2.1 Basic Requirements for System Installation

The following remarks have to be observed during installation and connection of the RO 1000 unit:

- The connected consumers must not exceed the max. admissible loads of the circuit outputs as well as the total output of the unit (see item 5) (in case of inductive loads, the phase angles have to be taken into account).
- All inductive consumers (valves, motors, contactors, transformers) of the unit have to be provided with suitable interference suppressors (RC element, varistor, diode)
- Should other devices with a high mains-borne interference level be installed in the surroundings of the control system, suitable external interference suppressors (line filters) have to be installed at the supply voltage input.
- The clamps must not be actuated with too much force.
- The screw-less terminal clamps are suitable for single-core and fine core conductors (without sleeves) of up to 0.5mm² (for sensor and analog output terminals) and up to 2.5 mm² respectively (all further terminals). According to the manufacturer's instructions it is not necessary to use core sleeves.
- All assembly activities have to be done in accordance with the corresponding VDE regulations.

2.2 Start-up

For the first start-up of the unit after its installation, the below-mentioned steps have to be carried out **in the given order**. Should the control system not operate in the described manner or if other malfunctions are discovered, the **electric supply has to be interrupted immediately** (and repaired by the manufacturer).

1. Install control and fix all terminal clamps. It has to be taken into account that the softener output is not protected by fuses. A short-circuit at this output may therefore destroy the conductor lines.
2. Switch on mains supply voltage è after at most 5 sec a text has to be displayed on the LC display (otherwise switch off è repair).
3. Carry out diagnostic program (see item 3.3) and test all inputs and outputs of the control unit. Should the fuse on the pc-board become active, one of the valve outputs is short-circuited.
4. Set operating modes and parameters (see item 4).
5. Calibrate sensors (see item 4.4.2).

2.3 Function of Terminals

Terminal arrangement and functions are as follows:

No.	Code	Function	adm. max. load	terminal
1	PE	Mains supply - protective. conduct	1000 VA = max. total output performance	2,5 mm ²
2	N	Mains supply - neutral conductor		2,5 mm ²
3	L	Mains supply - phase		2,5 mm ²
4	ENT-PE	softener - protective conductor	1000 VA	2,5 mm ²
5	ENT-N	softener - neutral conductor		2,5 mm ²
6	ENT-L	softener - phase		2,5 mm ²
7	P1-PE	pump 1 - protective conductor	1000 VA	2,5 mm ²
8	P1-N	pump 1 - neutral conductor		2,5 mm ²
9	P1-Ls	pump 1 - phase		2,5 mm ²
10	MV1-PE	inlet valve - protective conduct	1000 VA	2,5 mm ²
11	MV1-N	inlet valve - neutral conductor		2,5 mm ²
12	MV1-Ls	inlet valve - closer		2,5 mm ²
13	MV2-PE	outlet valve - protective cond.	1000 VA	2,5 mm ²
14	MV2-N	outlet valve - neutral conductor		2,5 mm ²
15	MV2-Ls	outlet valve - closer		2,5 mm ²
16	MV2-Lo	outlet valve - opening contact		2,5 mm ²
17	MV3-PE	concentrate valve - protective cond.	1000 VA	2,5 mm ²
18	MV3-N	concentrate valve - neutral cond.		2,5 mm ²
19	MV3-Ls	concentrate valve - closer		2,5 mm ²
20	STO-W	trouble message - central contact	230 VAC / 4A resp. 24V DC /1 A	2,5 mm ²
21	STO-S	trouble message - closer		2,5 mm ²
22	STO-O	trouble message opening contact		2,5 mm ²
23	REG-M	mass - regeneration		2,5 mm ²
24	REG-E	input - regeneration		2,5 mm ²
25	MOTL-M	mass - motor protection/limitent		2,5 mm ²
26	MOTL-E	input - motor protection/limitent		2,5 mm ²
27	DRS-M	mass - pressure switch		2,5 mm ²
28	DRS-E	input - pressure switch		2,5 mm ²
29	NIVU-M	mass - min. top level		2,5 mm ²
30	NIVU-E	input - min. top level		2,5 mm ²
31	NIVO-M	mass - max. top level		2,5 mm ²
32	NIVO-E	input - max. top level		2,5 mm ²
33	SEN-S	sensor permeate screening		0,5 mm ²
34	SEN-A	sensor permeate A (white)		0,5 mm ²
35	SEN-B	sensor permeate B (brown)		0,5 mm ²
36	SEN-C	sensor permeate C (yellow)		0,5 mm ²
37	SEN-D	sensor permeate D (green))		0,5 mm ²

3 Operational Scope

3.1 Operating settings

The control system allows to preselect the following operating settings (realization see item 4). The resulting control behaviours are described in the chapter Operating Conditions. The standard values (setting after parameter reset) are marked by * in the appropriate field.

<i>ps LIM high</i>	function:	Preselect if unit is to be switched off if <i>LIM</i> is exceeded or if a failure message is sufficient
	right of access:	user/technician
	possible setting:	* <u>switch off do</u> <u>not switch off</u>
<i>ps acknowledgment</i>	function:	Preselect if acknowledgment of failures is possible in the normal level (=without password) or only in the user/technician level (=with password).
	right of access:	technician
	possible setting:	* <u>without password</u> <u>with password</u>
<i>ps concentrate mode</i>	function:	Preselect if <u>PRODUCTION</u> has to be followed by <u>CONCENTRATE FLUSH</u> (with pump) or <u>CONCENTRATE DISPLACEMENT</u> (without pump).
	right of access:	technician
	possible setting:	* <u>flush</u> <u>displacement</u>
<i>ps tank type</i>	function:	Preselect if tank is equipped with an overflow or not. Should the tank have an overflow, the produced water continues to flow into the tank during <u>CONCENTRATE DISPLACEMENT/ FLUSH</u> and <u>DISCONTINUOUS RINSE</u> .
	right of access:	technician
	possible setting:	* <u>with</u> <u>without overflow</u>

3.2 Operating parameters

The control system allows the following operating parameter settings (realization see item 4). The resulting behaviours are described in the chapter operating conditions. The values in brackets are the standard values after system reset (see item 4.4.4).

<i>LIM</i>	function: right of access: possible setting:	Permeate limit value used to switch the unit off in case limit is exceeded or if a DISPOSAL process is to be finished. If this value is exceeded during PRODUCTION, RINSE or CONCENTRATE DISPLACEMENT/FLUSH for the time defined for t-delay LIM, an ALARM MESSAGE will be activated. user/technician meas. range 0.5-50µS/cm (40 µS/cm) Attention: the set value must be above aaLIM
<i>aaLIM</i>	function: right of access: possible setting:	Permeate limit value activating an ALARM MESSAGE in the display and on/off of the malfunction LED if this value is exceeded for the time defined for t-delay aaLIM user/technician 0.5-50µS/cm (10 µS/cm) Attention: the set value must be lower than LIM
<i>t-delay LIM</i>	function: right of access: possible setting:	Time delay for wrong permeate limit value (see above) technician 0-99 min (1 min)
<i>t-delay aaLIM</i>	function: right of access: possible setting:	Time delay for advance alarm in case of wrong permeate limit value (see above) technician 0-99 min (5 min)
<i>t-delay lack of pressure</i>	function: right of access: possible setting:	Time delay to release <u>PRESSURE FAILURE</u> if PRESSURE SWITCH is inactive. technician 0-99s (1s)
<i>t-delay at start</i>	function: right of access: possible setting:	Period of time of permanent pressure at start of operation after opening of the inlet valve before the pumps begin to work. technician 0-9.9s (0.5s)
<i>t-pressure available</i>	function: right of access: possible setting:	Period of time until <u>PRESURE FAILURE</u> is released if pumps do not start after opening of inlet valve. technician 0-99s (5s)
<i>t rinse</i>	function: right of access: possible setting:	Duration of a <u>DISCONTINUOUS RINSE</u> . technician 0-99 min (5s)

<i>t rinse interval</i>	function: Time after which a <u>DISCONTINUOUS RINSE</u> process is started provided that the control system was during that time in the operating condition <u>RINSE INTERVAL</u> . right of access: technician possible setting: 0-99h (0h)
<i>t concentrate</i>	function: Duration of a <u>CONCENTRATE DISPLACEMENT/FLUSH</u> process at the end of a <u>PRODUCTION (TANK FULL active)</u> . right of access: technician possible setting: 0-99min (1 min)
<i>t min disposal</i>	function: Minimum duration of a <u>DISPOSAL</u> process at the beginning of a <u>PRODUCTION</u> . This is the minimum time after which the unit passes to <u>PRODUCTION</u> if the value drops below <i>LIM</i> . right of access: technician possible setting: 0-999s (5s) Attention: the set value must be less than t max disposal. (Pay attention to units)
<i>t max disposal</i>	function: Maximum duration of a <u>DISPOSAL</u> process. This is the maximum time after which the value has to be below <i>LIM</i> , otherwise a failure message will be given. right of access: technician possible setting: 1-99min (60 min) Attention: the set value must be greater than t min disposal (Pay attention to units!)
<i>t maintenance</i>	function: Operating time (hour meter) after which a signal is given that maintenance has to be carried out (flashing OPERATION). right of access: technician possible setting: 0-999999h (3500h) Attention: zero setting means that no maintenance message is given.

3.2 Operating parameters

When the control system is switched on, the following four operating modes exist:

STOP

The control system does not carry out any production process. All outputs remain inactive. Failures are not registered.

OPERATION

The control system fulfills the production in accordance with the respective operating conditions in the unit. As long as the unit status is DISPOSAL, PRODUCTION ON, CONCENTRATE DISPLACEMENT/FLUSH or DISCONTINUOUS RINSE, the current operating data (conductivity, temperature, etc.) are displayed one after the other (rolling). Failures are registered, processed and displayed.

DISINFECTION

The control system does not carry out any production process, but **INLET VALVE**, **OUTLET VALVE** as well as the **PUMP** are switched on so that a disinfection can be carried out. No failures are registered.

DIAGNOSIS

The DIAGNOSIS is called via the main menu (see item 4.4.1). For diagnosis purposes, all control outputs can be manipulated via the keyboard and the input status (analog/digital) can be displayed (see item 4.4.5).

Attention: Failures are **not** registered/displayed.

The current operating mode is maintained when the system is switched off, that means the control system will be in the same operating mode which was running when the system was switched off.

3.4 Operating conditions

When the unit is in OPERATION the control system performs one of the seven possible operating conditions. The following diagram shows the various conditions as well as the reasons for status changes. For that purpose an error-free sequence of operations is assumed.

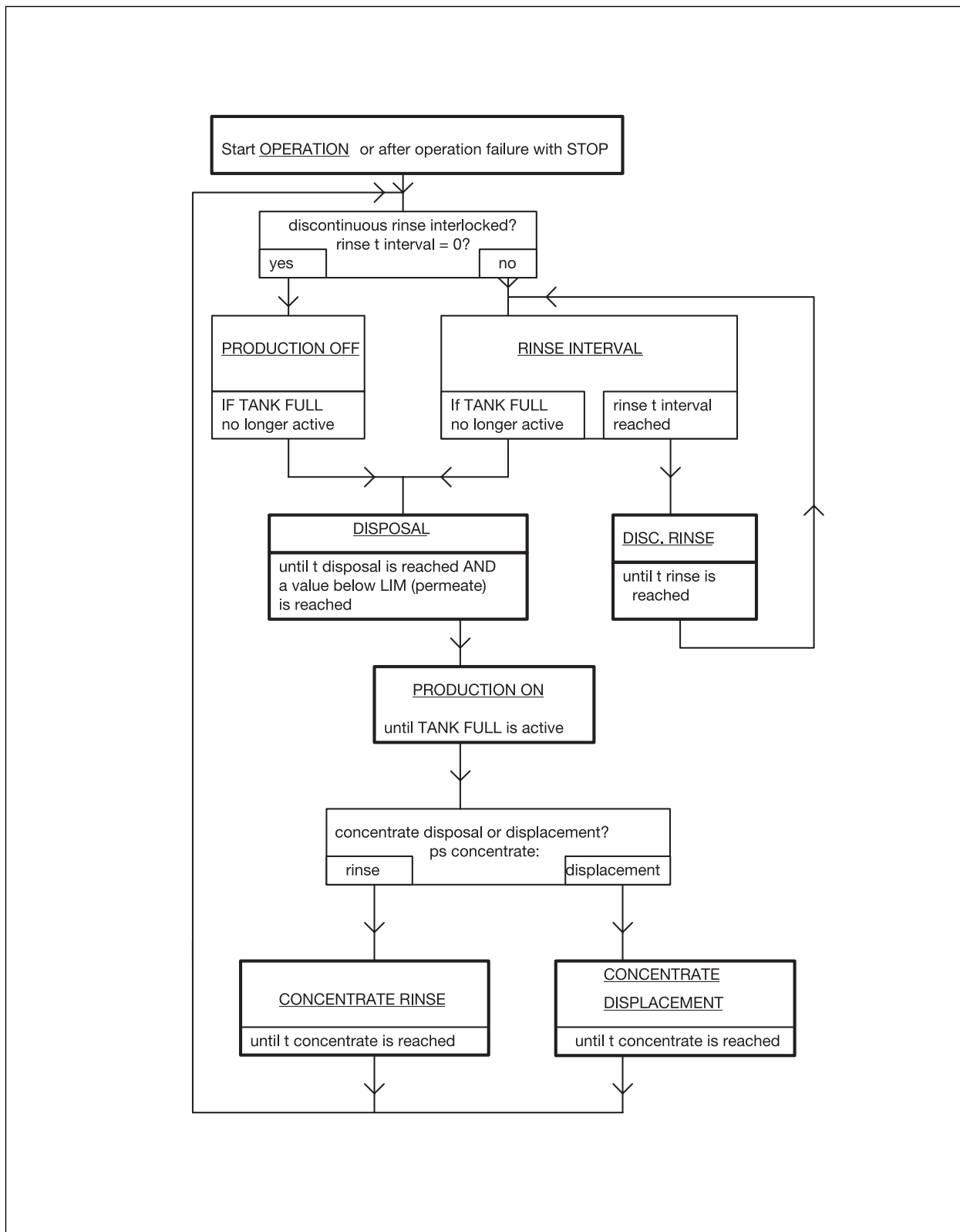

3.5 Operating failures/failure messages

The control system is able to detect operating failures during OPERATION and DISINFECTION and to display them. Usually, the unit will be stopped if a failure occurs. However, operating settings exist for the failures CY EXCEEDED and HARDWATER which make it possible that such a failure is only displayed without interruption of the production. During the operating mode DISINFECTION, only a MOTOR FAILURE can be detected.

The different operating failures/failure messages as well as their reasons and consequences are as follows:

Denomination	Reason	Consequence
<u>CY EXCEEDED</u>	Cy perm> LIM	Unit switches off if <i>ps LIM high</i> = switch-off
<u>FORCED STOP</u>	FORCED STOP active	Unit switches off
<u>MOTOR FAILURE/HARD WATER</u>	MOTOR FAILURE/ LIMIT CONTACT active	Unit switches off
<u>LACK OF PRESSURE</u>	PRESSURE SWITCH active	Unit switches off

MAINTENANCE

When the preset maintenance interval is over, the LED display **OPERATION** starts to flash (but only if control system is in the operating conditions DISPOSAL, PRODUCTION ON, CONCENTRATE DISPLACEMENT/FLUSH or DISCONTINUOUS RINSE. This alarm message can only be switched off by a technician who has then to enter a new maintenance interval (see item 4.4.4).

Besides the above mentioned failures also other types of failure exist. These are erroneous calibration ranges (failure message on text display), internal system failures (flashing **FAILURE** light) and initialization failures (EEPROM fail message in text display immediately after having switched the system on or during operation). As these failures correspond to malfunctions which the user cannot repair, the supplier has to be informed immediately if such failures occur.

ATTENTION !!! As an internal system failure will interrupt program run, failures will not be monitored. Such a control system **must not** be used any more.

4 Operation

4.1 User interface

The user interface of the RO 1000 consists of a text display (16x2 characters), a keyboard covered with a protective film (6 keys) and 7 indicator lights.

4.1.1 Indicator lights

The indicator lights correspond to the most important operating conditions of the unit. The control system has the following indicator lights:

OPERATION

Active, if the control system is in the operating mode OPERATION and if at least one pump is switched on. This indicator light will be a flashing light (instead of a continuous light) if the set maintenance interval has run out.

FAILURE

Active, if there is an operating trouble. In this case, the reason is displayed. In case of Cy alarm the failure LED flashes. Should the trouble light flash immediately after having the control system switched on, the reason is an internal system failure (see item 3.5).

DISINFECTION

Active, if the control system is in the operating mode DISINFECTION.

DISPOSAL

Active, if the control system is in the operating condition DISPOSAL.

FORCED STOP

Active, if the FORCED STOP input is activated and if the control system is in the operating mode OPERATION.

TANK FULL

Active, if the TANK FULL input is activated.

4.1.2 Keyboard

The control system has keys for the functions **UP** ↑, **DOWN** ↓, **LEFT** ←, **RIGHT** →, **ENTER** ↵ as well as ESC (on the equipment keyboard, symbols/arrows are used to identify some of them). They allow to call via the menu all functions and to modify the system settings/parameters.

4.1.3 Text display

The purpose of the LC text display is to indicate, besides the indicator lights, the current operating mode or the current unit condition respectively (normal level); it also serves for the (menu-assisted) user communication for control system settings (user/technician level).

4.2 Basic elements

The whole user surface of the control system is composed by basis functions such as password entry, menu selection, selection of settings, numerical entries etc. The description of the basic functions will be followed by the operating elements of the menus for users/ technicians.

4.2.1 Password entry

The entry of the password is the only way to gain access from the normal level to the user/ technician level. User and technician have different passwords.

For user's password entry, the following keys have to be actuated in the normal level, **within one minute**.

↑ → ↓ ← ↑

For technician's password entry, the following keys have to be actuated in the normal level, **within one minute**.

↑ ← → ESC ↓ ← ↑ ← → ESC ↓ ↵ ↑

For technician's password entry, the following keys have to be actuated in the normal level, **within one minute**.

4.2.2 Selection of menu

A menu is used to select or call specific functions. It consists of several numerical menu points (lines) listed one below the other. The text display of the control system always shows two of these menu lines, that means it always displays a two-line section (window) of the whole menu. If a function or a menu point has to be called in, the desired menu point has to be selected first using the ↑ / ↓ keys. If the menu consists of more than two lines, the displayed section is automatically displaced within the whole menu (scrolled), the selected menu point being marked with arrows at the left and right sides of the display (e.g. ">9 settings<").

This selected menu point is called-in with the . key.

A menu is finished with the **ESC** key (return to normal level). At certain program points (settings, calibrations, uncommitted input) nested menus appear. That means that the selection of a menu point starts a further menu (sub-menu). In that case, the **ESC** key causes return to the preceding menu.

4.2.3 Selection

The selection serves to chose one out of different options (usually operating settings). When a selection is called in (e.g. via a menu) the name of the selection appears in the upper display line (operating settings), the lower line displays the current status (value). With the ↑ / ↓ keys all further options can then be displayed. As soon as the ↵ key is pressed, the currently displayed option is then accepted (stored) as new operating setting.

A selection can be interrupted with the **ESC** key without having carried out any modification.

4.2.4 Multiselection

The multiselection allows to select various arguments simultaneously (for the purpose of this paper, argument means any type of setting).

In the lowest line of the text display appears for that purpose a chain of "0" and "1". Each one of these characters represents an argument. A "0" argument is inactive, a "1" argument is active. A curser (flashing block) can be moved with the ← / → keys between the different characters (arguments), and the corresponding description of the argument then appears in the upper display line (e.g. name of operating mode). An argument can be activated/inactivated with the ↑ / ↓ key.

The current setting of all arguments is accepted/stored with the ↵ key.

4.2.5 Numerical editing

The numerical editing is required to set the internal operating parameter and to enter the adjusted values.

The procedure is the same as used for decade switches.

When numerical editing is called-in (e.g. via a menu), the name of the operating parameter/adjusted value appears in the upper display line. The current value is displayed in the lower line. A flashing block (cursor) always marks the figure which can be modified; this modification (new setting) can be achieved with the ↑ / ↓ keys. Cursor displacement is achieved with the ← / → keys, so that other figures can be modified, too.

The displayed value is stored as new operating parameter when the ↵ key is actuated. The **ESC** key allows to interrupt the procedure without any storage even if a new figure was entered.

4.2.6 Alphanumerical editing

The alphanumerical editing is required to set the message text for the uncommitted input failure message. The procedure is the same as for numerical editing (see item 4.2.4), with the exception that the ↑ / ↓ keys do not only allow to select numbers but also letters (capital/small) and special characters.

4.2.7 Confirmations

Various menu activities require confirmations in order to avoid data entry errors. The user is asked to confirm that modifications of operating settings/parameters and adjustments are actually correct.

Confirmation is done with the → key (select "yes") followed by the ↵ key. Otherwise, the system will return to the level from which the function was called-in (e.g. menu) without any consequences (no modification will be stored).

4.3 Operating levels

Similar to the operating modes, the user surface has different operating levels:

Normal level:

In this level, the text display shows the operating mode, the operating condition, the current measured values and operating values as well as special messages (maintenance message) by means of different (scrolling) masks (see 4.3.1).

User level:

The user level (see 4.3.2) allows operation and setting of the most important functions and operating settings/parameters respectively as well as the calibration of the conductivity sensors.

Technician's level:

The technician's level is an extended user level: It allows to carry out the functions of the user level, to manipulate  all operating settings/parameters and to fulfil a hardware test by means of a specific diagnostic function.

The different operating levels and their functions as well as the operating options and the displayed texts (as far as possible) are described below.

4.3.1 Normal level

According to the operating mode, the sequence of displays in the normal level is as follows:

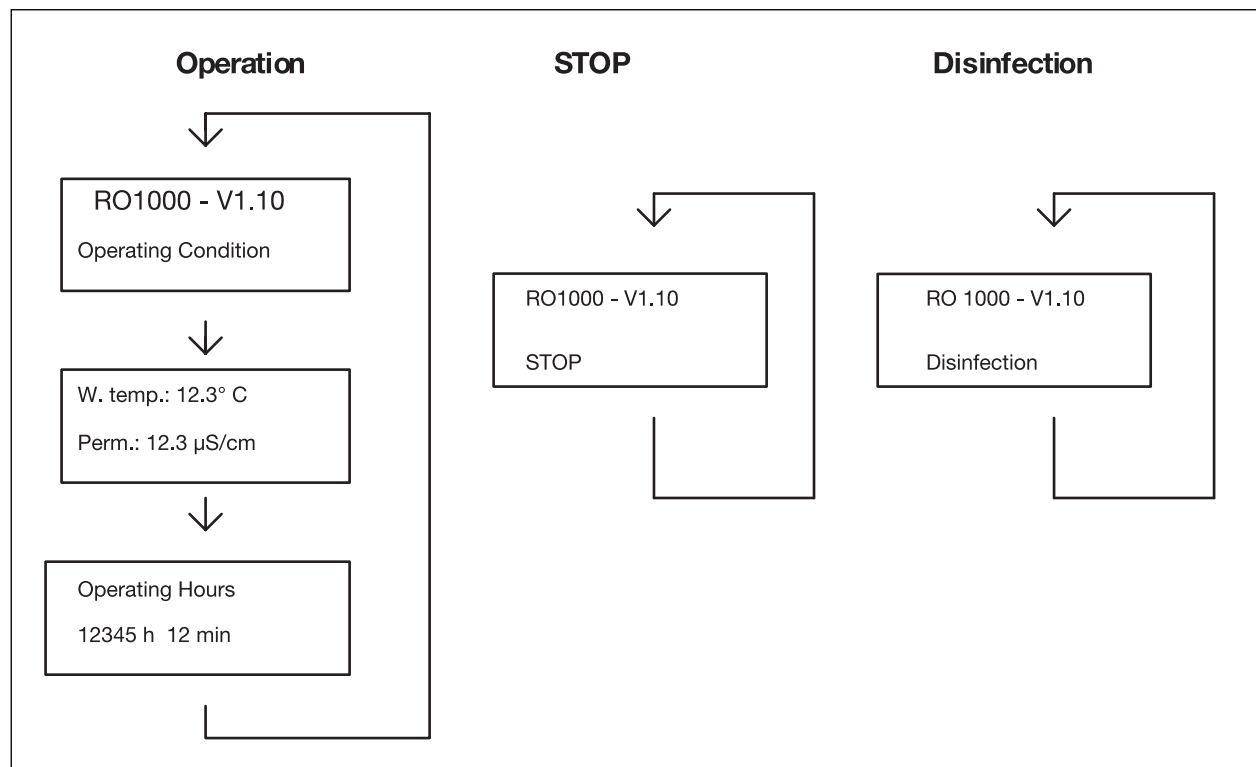

The only operation which is admitted is the acknowledgement of a failure (only for *ps acknowledgment* = without password); the purpose is to protect the control system against unintentional/unauthorized manipulations. When the system is switched on, it always is in the normal level, so that it also can be called the basic level.

4.3.2 User's Level

Access to the user level is achieved by entering a user's password (see 4.2.1). This level allows operation and setting of the most important functions and operating settings/parameters respectively. The operating status is not displayed because display is used to represent the menus to do selections and editing.

The functional scope corresponds to that of the main menu (see 4.4.1), but without the menu points Setting and Diagnosis.

If there is no key actuation for more than 10 min. and provided that the current function does not correspond to the display of measured values, the control system automatically returns to the normal level for safety reasons.

4.3.3 Technician's level

The technician's level is an expanded user level. It allows to fulfill the functions at user's level, to manipulate **all** operating settings/parameters and to fulfill a hardware test by means of a diagnostic function. The functional scope covers all menus and sub-menus (see 4.4.).

Access to the technician's level is similar to that to the user's level, that means a specific password has to be entered (see 4.2.1). If there is no key actuation for more than 10 min. and provided that current function does not correspond to the display of measured values or a diagnostic process, the control system returns to the normal level.

4.4 Menu structure

The menu structure of the user surface is shown below. Access to the main menu is achieved by entering a pass word (see item 4.2.1).

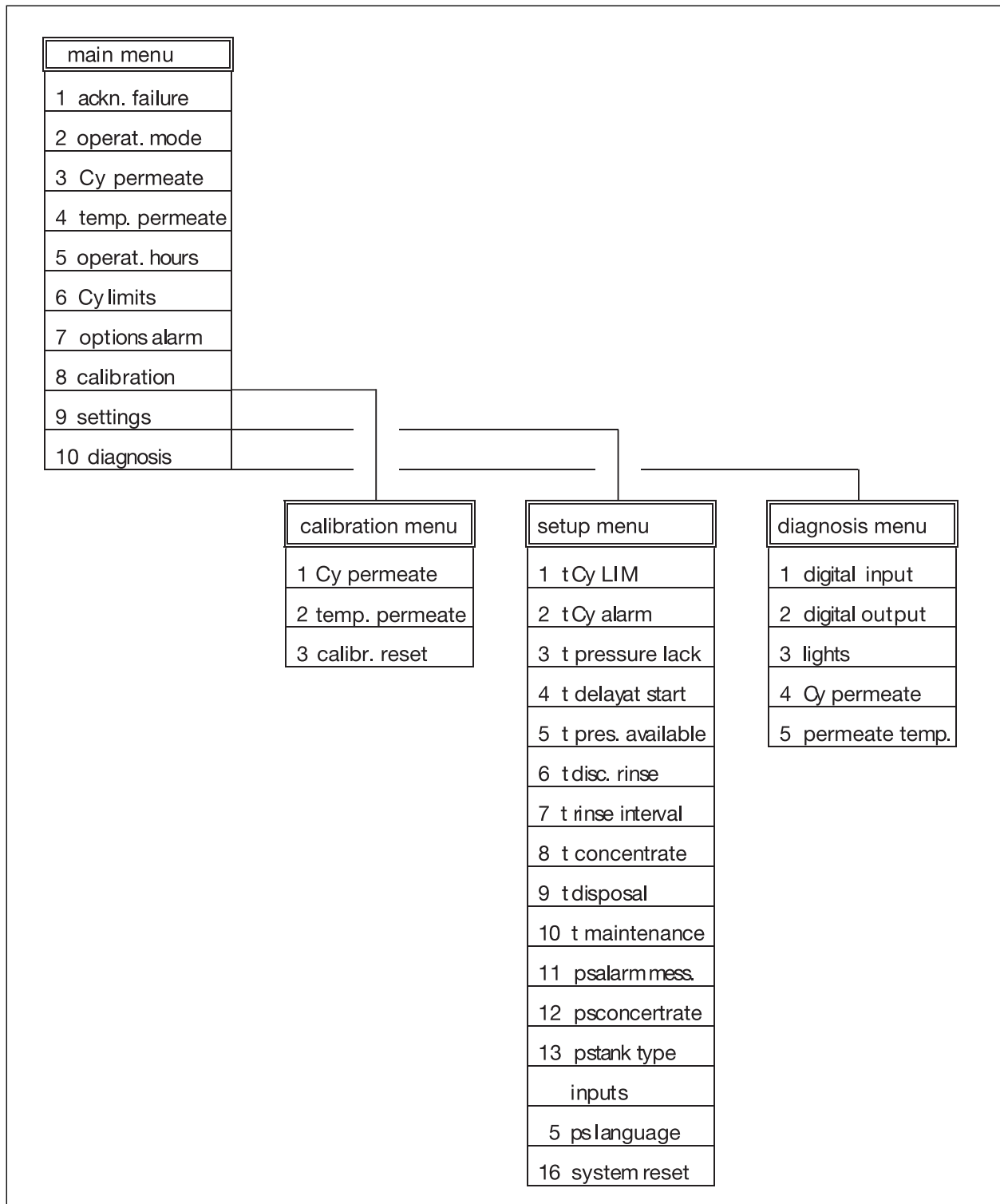



4.4.1 Main menu

The details of the different menu points of the main menu are described below.

Menu point:	Function:
1 Ackn. failure	This menu point allows to acknowledge an operating failure (the only possibility if ps acknowledgement = with password).
2 Operat. mode	This menu point allows to change the operating mode by means of a selection. For safety purposes, selection only can be made between STOP and OPERATION as well as STOP and DISINFECTION respectively (direct change-over from OPERATION to DISINFECTION is not possible).
2 Cy permeate	Permanent display of current permeate conductivity. To leave this menu point press one of the keys.
4 Temp. permeate	Permanent display of current permeate temperature. To leave this menu point press one of the keys.
5 Hour meter	Calling-in (display) of the operating hours meter.
6 Cy limits	Numerical entry of LIM and aaLIM.
7 Optional alarm	Setting (selection) of ps LIM high
8 Calibration	This menu point assures branching to the calibration menu (see item 4.4.3). The new calibration will be stored if the entered data are acknowledged before leaving the calibration menu.
9 Setting	This menu point assures branching to the setting menu (see item 4.4.4). The modification will be stored if the entered data are acknowledged before leaving the setting menu.
10 Diagnosis	This menu point assures branching to the diagnosis menu (see item 4.4.5). At the beginning of the diagnosis, all actuators of the unit are switched off. The system returns to the previous status if diagnosis is completed.

4.4.2 Calibration menu

The calibration menu is used to adjust the sensors. The following functions are available:

Menu point:	Function:
1 Cy permeate	<p>Calibration of permeate sensor. If the menu point '1 Cy permeate' is chosen, a submenu appears with two items: '1 min. Cy' and '2 max. Cy'. '1 min Cy': please remove the Cy sensor and press the . key. '2 max Cy'</p> <p>Important!!! The temperature must be calibrated before calibration of the conductivity.</p> <p>Connect the Cy sensor. Now the current permeate conductivity has to be determined by means of a standard meter, and this value has to be entered by numerical editing. The entered value is equated with the current conductivity after actuation of the  key.</p>
2 temp.permeate	<p>Calibration of permeate temperature sensor.</p> <p>For that purpose the current permeate temperature has to be defined with a standard meter, and this value has to be entered by means of numerical editing. The entered value is equated with the current temperature when the  key is then actuated.</p>
3 calibr. reset	<p>This menu point allows to reset adjustment of the two measuring inputs to the internal standard values.</p> <p>ATTENTION !! Internal calibration is not a correct adjustment.</p>

4.4.3 Setting menu

The calibration menu is used to adjust the sensors. The following functions are available:

Menu point:	Function:
1 t Cy LIM	Numerical editing of t delay LIM
2 t Cy alarm	Numerical editing of t delay aaLIM
3 t lack of pressure	Numerical editing of t delay lack of pressure
4 t delay at start	Numerical editing of t delay at start
5 t press. availabe	Numerical editing of t pressure failure
6 t disc. rinse	Numerical editing of t rinse
7 t rinse.interval	Numerical editing of t rinse interval
8 t concentrate	Numerical editing of t concentrate
9 t disposal	Numerical editing of t disposal
10 t maintenance	Numerical editing of t maintenance
11ps failure alarm	Selection of ps acknowledgment
12 ps concentrate	Selection of ps concentrate
13 ps type of tank	Selection of ps tank type
14 inputs	Setting of input types (valve with open rest pos./opener)
15 ps language	Selection of ps language
16 system reset	As soon as this function is called-in and acknowledged, the internal hours meter will be deleted (set to 0)

4.4.4 Diagnosis menu

The diagnosis allows direct display/manipulation of the input/output conditions for testing purposes.

ATTENTION!!! Under these conditions, failure detection is **not active**.

Menu point:	Function:
1 digital input	Display of the current conditions of the digital inputs (see item 2.3). Display is like a multiselection, but with the difference that the conditions of the arguments cannot be set - they depend on the input conditions.
2 digital output	Manipulation of the digital circuit outputs (see item 2.3) by means of a multiselection.
3 lights	Manipulation of the lights (item 4.1.1) by means of a multiselection.
4 Cy permeate	Permanent display of the current permeate conductivity. This display can be cancelled by actuating one of the keys.
5 temp. permeate	Permanent display of the current permeate temperature. This display can be cancelled by actuating one of the keys.

5 Technical Data

The following table contains all significant technical data of the RO 1000 control.

	min.	type	max.	unit
nominal service voltage	200	230	260	V
main frequenCy	47	–	63	Hz
nominal voltamps	5	–	10	VA
ambient temperature range (operation)	0	–	50	° C
ambient temperature range (storage)	-10	–	70	° C
relative air humidity	15	–	85	%
conductivity range	2	–	200	μS/cm
- accuracy of measurement (ref. to range end value without sensor)	–	0.5	1	%
- temperature range	0	–	40	° C
switching current of circuit inputs	0	–	30	mA
adm. relay load for 230 V AC	–	–	4	A
adm. relay load for 24 V DC	–	–	1	A
total installed load	–	–	1000	VA
total installed load - solenoid valves	–	–	250	VA
protection class	IP55			

Operating Record for the WTC 600 LP/MP

Equipment Data:													
Works/Plant No.:													
Page No.:													
Location of Installation:													
Date of Starting Operation:													
Type of Untreated Water Supply:													
Date	Operator	Untreated Water			Operating Data				Drinking Water			Malfunctions / Remarks	
		Hardness [j dH]	Temperature [j C]	Conducting capacity [μS/cm]	Operating hours [h]	Pressure ahead of fine filter [bar]	Pump pressure [bar]	Concentrate pressure [bar]	Counter Backwashings	Through-flow [l/h]	Conducting capacity [μS/cm]		

This control sheet is to be filled out consciously 1x per week. Please copy after entering the operational start-up values.

A

Acidic and Alkaline Cleaning	49
Acknowledging Data Inputs	35
Activated Carbon Filter	31
Activated carbon filter	11
Adjusting Operating Parameters and Balancing Value	35
Alphanumeric editing	82
Anti Scalant and Post Chlorination	14
Antiscalant	23
Antiscalant metering	11
Antiscalant metering point	11
Appendix	62
Assembly and Starting Operation	20
Automatic Operation (Standard Operating Mode)	16

B

Backwashing / Regeneration	31
Balancing Values	35
Basic elements	81
Basic Requirements for System Installation	72

C

Calibration menu	87
Check valve	46
Chemicals for Metering Containe	19
Chlorination of Drinking Water	8
Circuit Breaker	15
Cleaning Chemicals	19
Cleaning in Case of Malfunction	45
Cleaning Solution for Acidic Cleaning	50
Cleaning Solution for Alkaline Cleaning	50
Concentrate control valve	11, 46
Concentrate flowmeter	11
Concentrate to the flushing tank	46
Concussion restrictor	11
Conductivity and temperature measuring cell - dri	11
Confirmations	82
Connecting the Equipment	26
Connections, Valves and Indicators	26
Conserve the RO system	50
Conserving	50
Consumption Materials	19
Control, activated carbon filter	11
Control cabinet	11
Control Panel and Display	14
Control System	66

D

De-conserving	35
Declaration of Conformity	71
Description of the System	13
Design of the Flushing and Disinfection Equipment	46
Disinfection	42
Diagnosis menu	88
Differential pressure switch	11
Disinfection	48
Disposal of Chemicals	8
Drain the metering station and flush	50
Drain the pre-filter	52
Drinking water flowmeter	11
Drinking water sampling tap	11
Drinking water to the flushing tank	46

E

Electrical Connections	28
Electrical control system	46
Emergency Stop	15
Evaluate flocking test	25

F

Filter	19
Fine Filter	14, 43
Fine filter	46
Fine filter candle	11
Fine filter housing	11
First fill of the metering tanks	21
Float Switch	30
Flocculation Agent	24
Flocculation metering	11
Flocculation metering point	11
Flocculation Module	13
Flow Diagram	12
Flow meter (concentrate)	46
Flow meter (drinking water)	46
Flushing pump	46
Flushing tank	46
Flushing the pre-filter	53
Function of Terminals	73

G

General	69
General installation notes	9
General Remarks	69

H

Handling Electricity / Protection Class	9
High-pressure pump	11

I		Microfuses	16
Indicator lights	80	Mixing Chlorine, Flocculation Agent and Antiscalan	21
Initial Filling	31	Mixing of the flocking test solution	24
Initial startup	37	Modular Design	13
Input solenoid valve	11	Motor Protection Switch	15
Installation/Start-up	72	Multiselection	82
Instructions for Use	70		
K		N	
Keyboard	80	Non-return valve	11
M		Normal level	83
Main menu	86	Normal Operation	39
Maintenance	43	Numerical editing	82
Maintenance During Operation	60	O	
Maintenance Plan	60	Operating conditions	78
Maintenance Plan – Service	61	Operating failures / failure messages	79
Malfunction, Cause and Corrective Action ...	56	Operating levels	83
Malfunction Indication at the Operating Panel	57	Operating Levels and Passwords	34
Malfunctions –		Operating Messages for Normal Operation	40
Media and Activated Carbon Filter	59	Operating Modes	16
Malfunctions of the RO Control and Metering Pump	58	Operating parameters	75, 77
Manometer	46	Operating settings	74
Manometer - activated carbon filter inlet pressur	11	Operation	80
Manometer - concentrate pressure	11	Operation of the System	20
Manometer - fine filter input pressure	11	Operational Scope	74
Manometer - fine filter output pressure	11	Other Maintenance	61
Manometer - media filter inlet pressure	11	Overview of components	10
Manometer, pump pressure	11	P	
Manostat	11	Password entry	81
Manual / automatic rotary switch	11	Perform flocking test	25
Manual Operation	16	Post chlorination metering	11
Master switch	11	Post chlorination metering point	11
Measuring cell	46	Power outlets (3x) for metering stations	11
Media and Activated Carbon Filter	31	Pre-chlorination	21
Media and activated charcoal plug sockets	11	Pre-chlorination metering	11
Media filter	11	Pre-chlorination metering point	11
Media filter control	11	Pre-chlorination Module	13
Mediafilter- and Activated Carbon Filter	14	Preliminary Filter	28
Membrane	11	Pressure control valve	11, 46
Membrane pressure pipe	11	Pressure switch	46
Menu Selection	34	Pressure tube / module	46
Menu structure	85	Pressure-increase Module	27
Metering Amounts and Mixing of the Post Chlorinati	24	Pressure-increase Pump	15, 28
Metering Station	28, 30	Programming	32
Metering Station LED and Indicator LEDs at the Swi	56	Pump	14
Metering Station WTC 600 CD	43	Putting Out of Operation	41
		Q	
		Quality of the Untreated Water	8

R

RC Protective Switch	15
Regeneration	31
Removing the Preservation After Longer Operational	52
Replace the activated carbon or filter sand	54
Reverse osmosis control	11
Reverse Osmosis Module (RO Module)	44
Reverse Osmosis System	30
RO 1000: Manual	66
RO control factory settings	62
RO control program structure	64
RO Filter Replacement	44
RO Module with Preliminary Filters	27
RO Pump	46
RO System, Pump and Fine Filter	14

S

Safety Installations	15
Safety Instructions	70
Sampling valve for drinking water	46
Sampling valve for untreated water	46
Scope of Application	69
Selecting Several Arguments at the Same	35
Selection	81
Selection of an Option	34
Selection of menu	81
Setting menu	88
Solenoid valve	46
Start-up	72
Starting Operation	30, 31
Starting Operation of the RO System	34

T

Technical Data	89
Technical Data WTC 600 LP/MP	17
Technician's level	84
Terms and Definitions	71
Text display	80

U

Units and Designations	9
Untreated water sampling tap	11
User interface	80
User's Level	84

W

WTC 600 LP, LP-A, LP-AM in voltages 230 V and 400	62
WTC 600 MP, MP-A, MP-AM in voltages 230 V and 400	63

Free Manuals Download Website

<http://myh66.com>

<http://usermanuals.us>

<http://www.somanuals.com>

<http://www.4manuals.cc>

<http://www.manual-lib.com>

<http://www.404manual.com>

<http://www.luxmanual.com>

<http://aubethermostatmanual.com>

Golf course search by state

<http://golfingnear.com>

Email search by domain

<http://emailbydomain.com>

Auto manuals search

<http://auto.somanuals.com>

TV manuals search

<http://tv.somanuals.com>