



Ci200.2QT

Information Sheet



Sometimes custom installation needs something extra special and KEF's Ci200.2QT is just that. Easily configured for infrared remote control an integral DC motor allows you to position the speaker at the optimum angle with the press of a button. When fully retracted it can be operated as a conventional ceiling flush mounted speaker.

Providing the perfect sound stage is KEF's patented Uni-Q® driver array producing audiophile quality sound with an expansive soundscape and excellent bass extension. When partnering with others in the range such as the Ci130DS it is the perfect companion for creating a high performance built-in home theatre.

Features and Benefits:

The 2-way Ci200.2QT combines 100W power handling and 88dB sensitivity, for a maximum output of 108dB. A 200mm (8") polypropylene cone bass/mid unit with a coincident mounted 25mm (1") soft dome, ferrofluid cooled high-frequency unit gives superb off-axis dispersion characteristics. Five pre-set tilt positions with music sensing mode provides a unique touch of sophistication for the discerning client. The bezel and grill can be painted to match the interior décor.

Ci series
custom installation speakers



Ci200.2QT

Installation

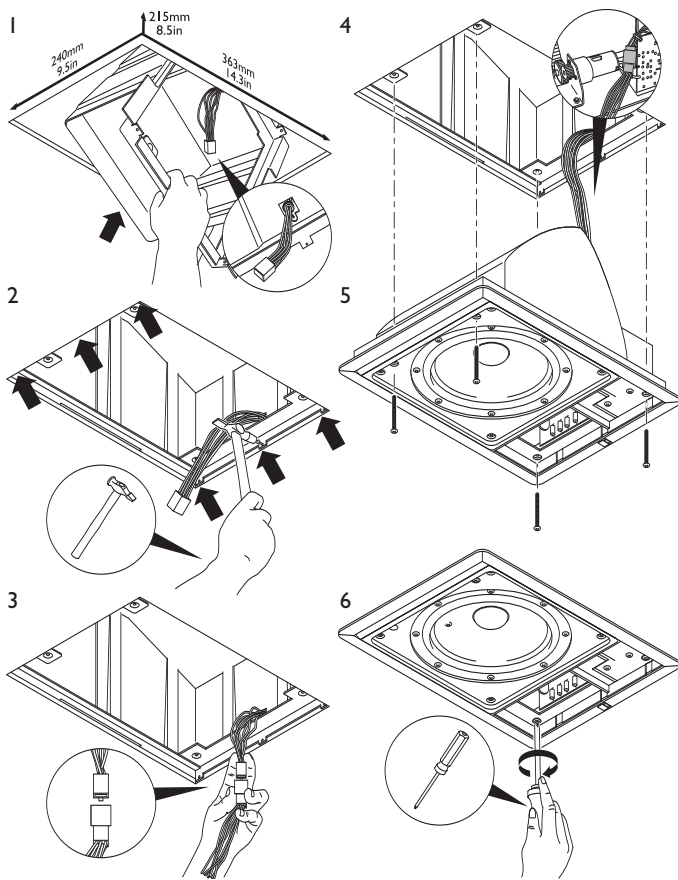

Polar graphs

500Hz

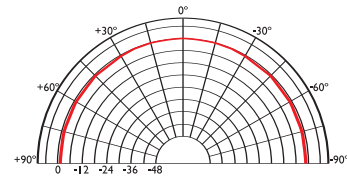

1kHz

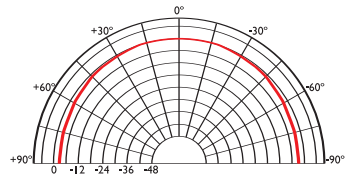

2kHz

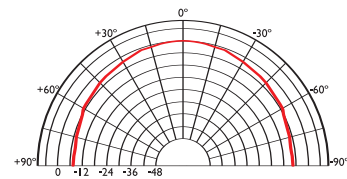

4kHz

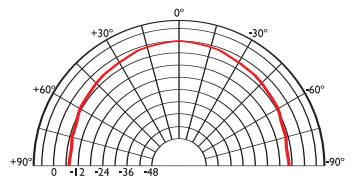

8kHz

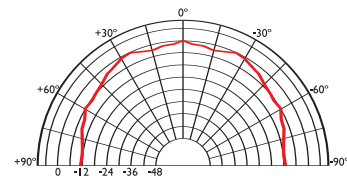

16kHz

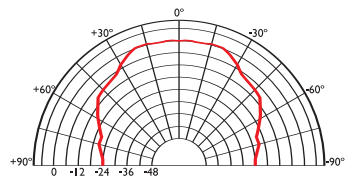

Architectural specifications:

The Ci Series Ci200.2QT comprise a coincident mounted 25mm soft dome ferrofluid cooled tweeter with a 200mm polypropylene cone bass/mid unit. Performance should meet or exceed the following criteria: frequency response 1 metre on-axis with swept sine wave

shall be 43Hz to 20 kHz, sensitivity shall be at least 88dB for 2.83V@1m. The impedance and maximum power shall be 100W at 8 ohms. The Ci Series Ci200.2QT is best suited where high quality music and speech reinforcement applications require hi-fi performance such as:

- Multi Room systems.
- Home Theatre systems.
- Lounges, Bars, Boutiques.
- Boardrooms & Offices.
- Airports, Convention Centres, Hotels.
- Live Theatre/Concert Hall fill-in.
- Houses of Worship.
- Sports Arenas.

Frequency / Power response, Input impedance

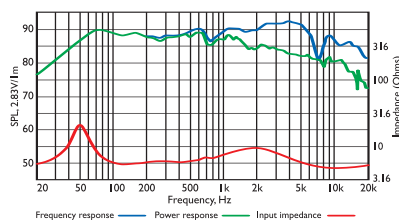

Directivity Index / Beamwidth

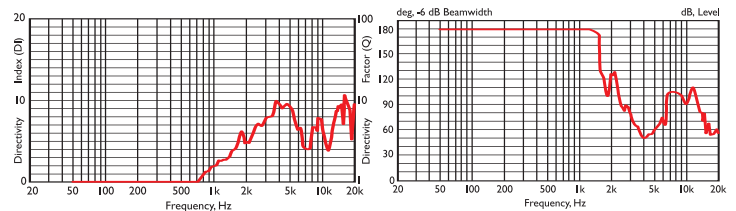

Specifications

Frequency range	43Hz - 20kHz
Sensitivity (2.83v @ 1m)	88dB
Rec. amplifier power	10 - 100W
Nominal Impedance	8Ω (min. 4.8Ω)
Crossover Frequency	2.5kHz

Enclosure material	N/A
Terminals	terminal blocks up to Ø2.5mm (0.1") conductor
Dimensions (H x W x D)	381 x 279 x 215 mm, 15 x 11 x 8.5 in.
Net weight	5.52kg (12.1lbs)

Free Manuals Download Website

<http://myh66.com>

<http://usermanuals.us>

<http://www.somanuals.com>

<http://www.4manuals.cc>

<http://www.manual-lib.com>

<http://www.404manual.com>

<http://www.luxmanual.com>

<http://aubethermostatmanual.com>

Golf course search by state

<http://golfingnear.com>

Email search by domain

<http://emailbydomain.com>

Auto manuals search

<http://auto.somanuals.com>

TV manuals search

<http://tv.somanuals.com>