

Q S E R I E S

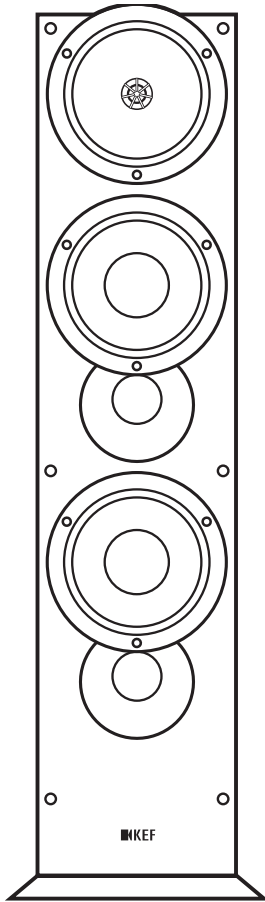

iQ90

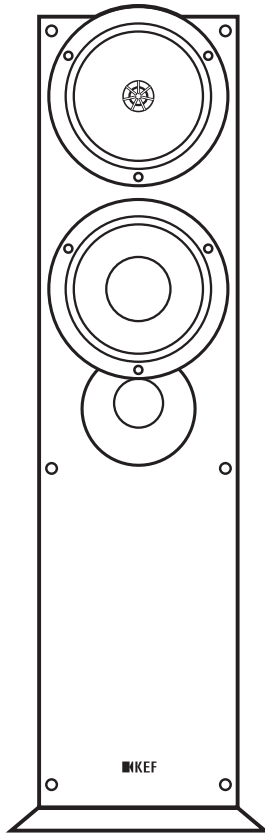

iQ70

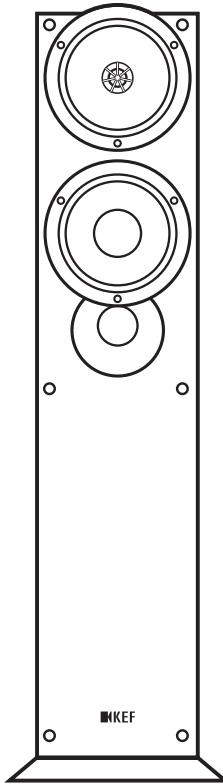

iQ50

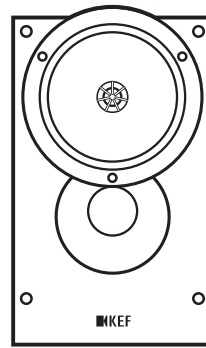

iQ30

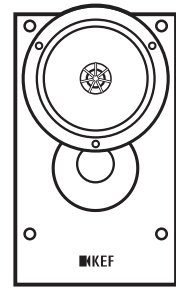

iQ10

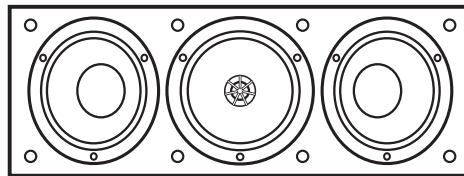

iQ60c

- GB** Installation Manual
- F** Manuel d'installation
- D** Installationshandbuch
- I** Manuale d'installazione
- ES** Manual de instalación
- P** Manual de instalação
- NL** Installatiehandleiding
- DK** Installationsanvisning

- PL** Podręcznik instalacji
- RU** Инструкция по установке
- GR** Εγχειρίδιο Εγκατάστασης
- JP** 取り扱い説明書
- CN** 安装手册
- TC** 安裝手冊
- K** 설치방법

KEF®
INNOVATORS IN SOUND

(GB) Plinth (iQ50, iQ70, iQ90)	(ES) Pedestal (iQ50, iQ70, iQ90)	(PL) Plinth (iQ50, iQ70, iQ90)	(CN) 底座 (iQ50, iQ70, iQ90)
(F) Socle (iQ50, iQ70, iQ90)	(P) Pedestal (iQ50, iQ70, iQ90)	(RU) основание (iQ50, iQ70, iQ90)	(TC) 底座 (iQ50, iQ70, iQ90)
(D) Sockel (iQ50, iQ70, iQ90)	(NL) Plint (iQ50, iQ70, iQ90)	(GR) Πλίνθος (iQ50, iQ70, iQ90)	(K) 주춧돌 (iQ50, iQ70, iQ90)
(I) Piedistallo (iQ50, iQ70, iQ90)	(DK) Sokkel (iQ50, iQ70, iQ90)	(JP) 台座 (iQ50, iQ70, iQ90)	

iQ50
iQ70
iQ90

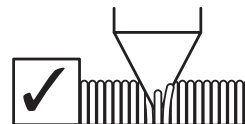
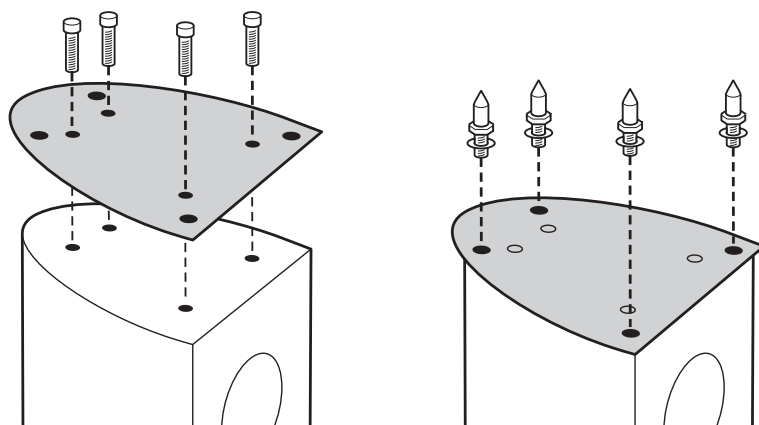

(GB) Important Points	(ES) Puntos importantes	(PL) Ważne	(CN) 注意事項
(F) Points importants	(P) Pontos importantes	(RU) Важные замечания	(TC) 注意事項
(D) Wichtige Punkte	(NL) Belangrijke aandachtspunten	(GR) Σημαντικές Επισημάνσεις	(K) 설치 시 주의 사항
(I) Punti importanti	(DK) Vigtige punkter	(JP) 重要なポイント	

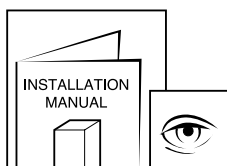

- (GB) Follow this manual carefully for best results from your speakers.
(F) Afin de tirer les meilleurs résultats des haut-parleurs, veuillez suivre scrupuleusement les instructions reprises dans le présent manuel.
(D) Für optimale Ergebnisse mit Ihrem Lautsprecher befolgen Sie diese Anleitung.
(I) Per ottenere le migliori prestazioni dai diffusori seguire le istruzioni contenute nel presente manuale.
(ES) Siga las instrucciones de este manual para obtener los mejores resultados de los altavoces.
(P) Siga este manual atentamente para obter o melhor resultado das colunas.
(NL) Volg terwille van een optimaal resultaat de instructies nauwkeurig op.
(DK) Følg denne manual omhyggeligt for at opnå det bedste resultat fra højttalerne.
(PL) Aby zapewnić optymalne działanie głośników, należy stosować się do tego podręcznika.
(RU) Для получения наилучших результатов от громкоговорителей, тщательно следуйте данной инструкции.
(GR) Ακολουθήστε προσεκτικά τις οδηγίες αυτού του εγχειριδίου για να εξασφαλίσετε την καλύτερη δυνατή απόδοση των ηχείων σας.
(JP) スピーカーの性能を出し切るためにこのマニュアルをよくお読みください。
(CN) 请仔细阅读和遵循本手册以取得最佳的效果。
(TC) 請仔細閱讀和遵循本手冊以取得最佳的效果。
(K) 설치 전 본 매뉴얼을 숙지 하세요

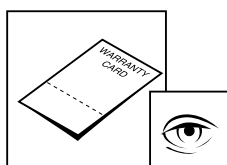

- (GB) Read and return warranty card.
(F) Veuillez lire et renvoyer la carte de garantie.
(D) Lesen Sie die Garantiekarte und senden Sie sie ausgefüllt zurück.
(I) Si prega di restituire la scheda di garanzia, previa attenta lettura.
(ES) Lea y envíenos la tarjeta de garantía.
(P) Leia e devolva o cartão de garantia.
(NL) U kunt na lezing en invulling de garantietaart aan de importeur sturen.
(DK) Gennemlæs og send garantibeviset tilbage.
(PL) Przeczytaj kartę gwarancyjną i odeślij ją.
(RU) Прочтите гарантийный талон
(GR) Διαβάστε και επιστρέψτε την κάρτα εγγύησης.
(JP) 日本国内では保証書の発行をいたしておりません。正規販売店の領収書が保証書に替わります。iQシリーズは自然故障においてお買い上げより2年間の無償修理です。
(CN) 请阅读和寄回质量保证卡。
(TC) 請閱讀和寄回質量保證卡。
(K) 품질보증서 확인

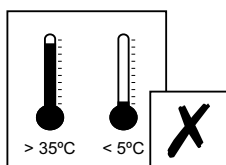

- (GB) Avoid temperature extremes.
(F) Eviter les températures extrêmes.
(D) Extreme Temperaturen vermeiden.
(I) Evitare temperature troppo alte o troppo basse.
(ES) Evite temperaturas extremas.
(P) Evite temperaturas extremas.
(NL) Vermijd extreme temperaturen.
(DK) Undgå ekstreme temperaturer.
(PL) Unikaj ekstremalnych temperatur.
(RU) Используйте при нормальной комнатной температуре
(GR) Αποφύγετε την έκθεση σε ακραίες θερμοκρασίες.
(JP) 極端な温度は避けてください。
(CN) 避免过高和过低的温度。
(TC) 避免過高和過低的溫度。
(K) 설치 온도



(GB) Important Points	(ES) Puntos importantes	(PL) Ważne	(CN) 注意事项
(F) Points importants	(P) Pontos importantes	(RU) Важные замечания	(TC) 注意事項
(D) Wichtige Punkte	(NL) Belangrijke aandachtspunten	(GR) Σημαντικές Επισημάνσεις	(K) 설치 시 주의 사항
(I) Punti importanti	(DK) Vigtige punkter	(JP) 重要なポイント	

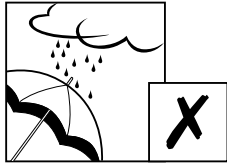

- (GB) Avoid damp.
- (F) Eviter l'humidité.
- (D) Feuchtigkeit vermeiden.
- (I) Evitare l'umidità.
- (ES) Evite la humedad.
- (P) Evite a humidade.
- (NL) Vermijd vocht.
- (DK) Undgå fugt.
- (PL) Unikaj wilgoci.
- (RU) Избегайте сырости
- (GR) Αποφύγετε την έκθεση σε μέρη με υγρασία.
- (JP) 湿気を避けてください。
- (CN) 避免潮湿。
- (TC) 避免潮濕。
- (K) 습기 찬 곳은 피하세요

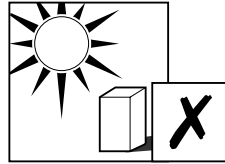

- (GB) Avoid direct sunlight.
- (F) Eviter l'exposition directe aux rayons du soleil.
- (D) Direktes Sonnenlicht vermeiden.
- (I) Evitare l'esposizione diretta ai raggi del sole.
- (ES) Evite la luz directa del sol.
- (P) Evite a exposição directa à luz do sol.
- (NL) Vermijd rechtstreeks zonlicht.
- (DK) Undgå direkte sollys.
- (PL) Unikaj bezpośredniego światła słonecznego.
- (RU) Избегайте прямых солнечных лучей
- (GR) Αποφύγετε την άμεση έκθεση στον ήλιο.
- (JP) 直射日光を避けてください。
- (CN) 避免阳光照射。
- (TC) 避免陽光照射。
- (K) 직사 광선을 피하세요

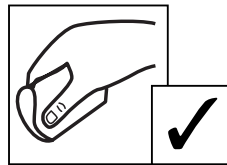

- (GB) Clean with a damp lint free cloth.
- (F) Nettoyer à l'aide d'un chiffon humide, non pelucheux.
- (D) Mit einem angefeuchteten, nicht fuselnden Tuch abwischen.
- (I) Pulire con un panno umido non sfilacciato.
- (ES) Limpie con un paño húmedo.
- (P) Limpe com um pano húmido sem pêlos.
- (NL) Reinigen met een vochtige niet pluizende doek.
- (DK) Rengør med en fugtig klud, der ikke fugger.
- (PL) Czyść wilgotną szmatką o zwartej strukturze.
- (RU) Очищайте влажной тканью, не содержащей волокон.
- (GR) Καθαρίστε με υγρό ύφασμα που δεν αφήνει χνούδια.
- (JP) 毛羽立ちのない柔らかい布に少量の水分を含ませて拭いてください。
- (CN) 用不含麻质的湿布清洁。
- (TC) 用不含麻质的濕布清潔。
- (K) 부드러운 천 등으로 닦으세요

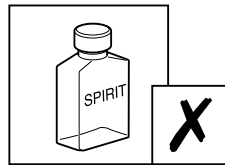

- (GB) Do not use spirit based cleaners.
- (F) Ne pas utiliser d'agents nettoyants à base d'alcool.
- (D) Keine alkoholhaltigen Reinigungsmittel verwenden.
- (I) Non utilizzare prodotti a base di alcool.
- (ES) No use limpiadores con base de alcohol.
- (P) Não utilize produtos de limpeza à base de álcool.
- (NL) Gebruik geen reinigingsproducten op basis van alcohol.
- (DK) Brug ikke rengøringsmidler med alkohol.
- (PL) Nie używaj środków czyszczących na bazie rozpuszczalników.
- (RU) Не используйте растворители для чистки
- (GR) Μην χρησιμοποιείτε υγρά καθαρισμού με βάση το οινόπνευμα.
- (JP) アルコールなど化学物質を一切使用しないでください。
- (CN) 不要使用含酒精的清洁剂。
- (TC) 不要使用含酒精的清潔劑。
- (K) 윤활유 등으로 닦지 마세요



- (GB) **SAFETY NOTICE!** trailing cables are dangerous, secure all cables.
- (F) **NOTE DE SECURITE !** Les câbles de haut-parleurs traînant sur le sol peuvent être source de danger. Fixer tous les câbles.
- (D) **SICHERHEITSHINWEIS !** Herumliegende Lautsprecherkabel sind eine Gefahrenquelle. Bitte alle Lautsprecherkabel sorgfältig verlegen.
- (I) **NOTA PER LA SICUREZZA:** i cavi di uscita dei diffusori possono essere pericolosi se non sistemati in un posto sicuro.
- (ES) ¡**ATENCIÓN!** los cables de conexión sueltos de los altavoces son peligrosos. Fíjelos.
- (P) **PRECAUÇÕES DE SEGURANÇA!** Os cabos das colunas espalhados são perigosos, fixe todos os cabos.
- (NL) **VOOR UW VEILIGHEID!** Loshangende luidsprekerkabels zijn gevaarlijk! De kabels steeds op een veilige plaats leggen.
- (DK) **BEMÆRK!** skarpe knæk og slid på højttalerledningerne er farlig, de skal fastgøres.
- (PL) **UWAGA DOTYCZĄCA BEZPIECZEŃSTWA!** Luźno leżące kable są niebezpieczne. Zabezpiecz wszystkie kable.
- (RU) **Замечание по безопасности!** Не допускайте образования петель из кабелей, закрепите все кабели
- (GR) **ΠΡΟΕΙΔΟΠΟΙΗΣΗ ΑΣΦΑΛΕΙΑΣ!** Τα εκτεθειμένα καλώδια σας εκθέτουν σε κίνδυνο, ασφαλίστε όλα τα καλώδια.
- (JP) **安全注意!** ケーブル類はきれいにまとめ足に引っ掛けることのないようにしてください。
- (CN) **注意安全!** 散乱曳尾的连接线和电线有潜在危险，必须固定所有连接线及电线。
- (TC) **注意安全!** 散亂曳尾的連接線和電線有潛在危險，必須固定所有連接線及電線。
- (K) 케이블은 이동이 없는 곳에 설치하세요



- (GB) Correct
- (F) Correct
- (D) Richtig
- (I) Corretto
- (ES) Correcto
- (P) Correcto
- (NL) Juist
- (DK) Korrekt
- (PL) Poprawny
- (RU) Правильно
- (GR) Σωστό
- (JP) 正しいです
- (CN) 正确
- (TC) 正確
- (K) 옳음



- (GB) Wrong
- (F) Incorrect
- (D) Falsch
- (I) Errato
- (ES) Incorrecto
- (P) Errado
- (NL) Fout
- (DK) Forkert
- (PL) Niepoprawny
- (RU) Неправильно
- (GR) Λάθος
- (JP) 誤りです
- (CN) 错误
- (TC) 錯誤
- (K) 틀림



- (GB) Caution/Warning
- (F) Attention/Avertissement
- (D) Achtung / Warnung
- (I) Attenzione/Avvertenza
- (ES) Precaución/Atención
- (P) Atenção/ Aviso
- (NL) Opgelet/Waarschuwing
- (DK) Forsigtigt / Advarsel
- (PL) Ostrzegawczy / Ostrzeżenie
- (RU) Внимание/Предупреждение
- (GR) Προσοχή/Προειδοποίηση
- (JP) 注意！警告！
- (CN) 注意/警告
- (TC) 注意/警告
- (K) 주의/경고



- (GB) Adjustment
- (F) Réglage
- (D) Einstellung
- (I) Regolazione
- (ES) Ajuste
- (P) Ajuste
- (NL) Instelling
- (DK) Justering
- (PL) Uregulowanie
- (RU) Настройка
- (GR) Προσαρμογή
- (JP) 調節
- (CN) 调整
- (TC) 調整
- (K) 조정



(GB) Positioning	(ES) Posicionamiento	(PL) Ustawienie położenia	(CN) 擺放定位
(F) Positionnement	(P) Posicionamento	(RU) Размещение	(TC) 擺放定位
(D) Aufstellung	(NL) Plaats en aansluiting	(GR) Ρύθμιση	(K) 설치 위치
(I) Posizionamento	(DK) Placering	(JP) 位置	

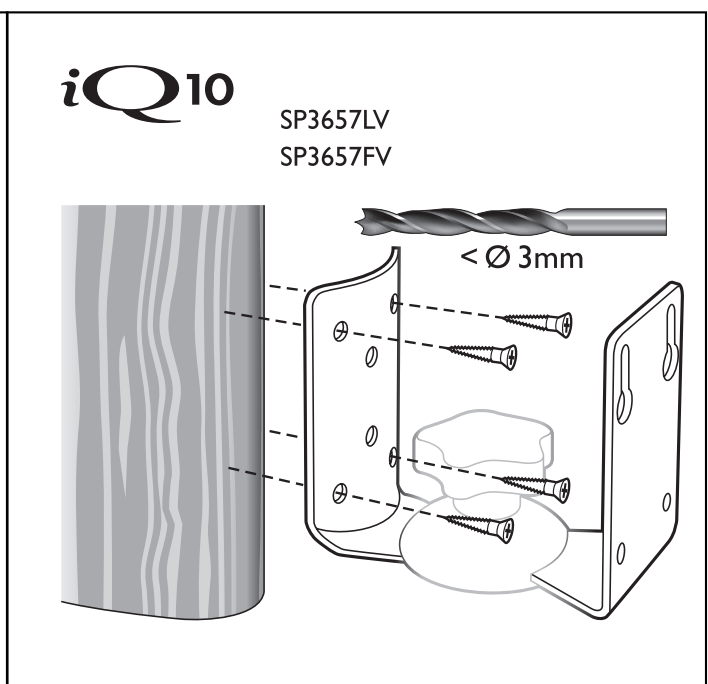
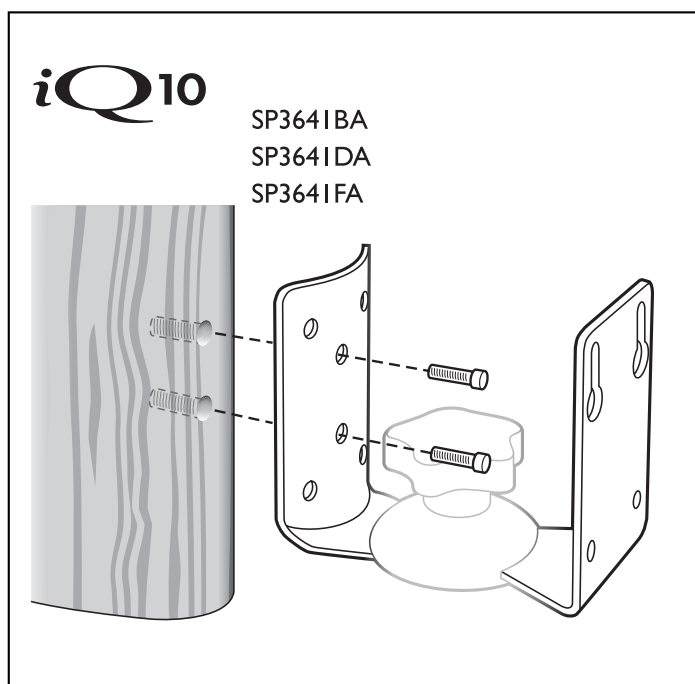
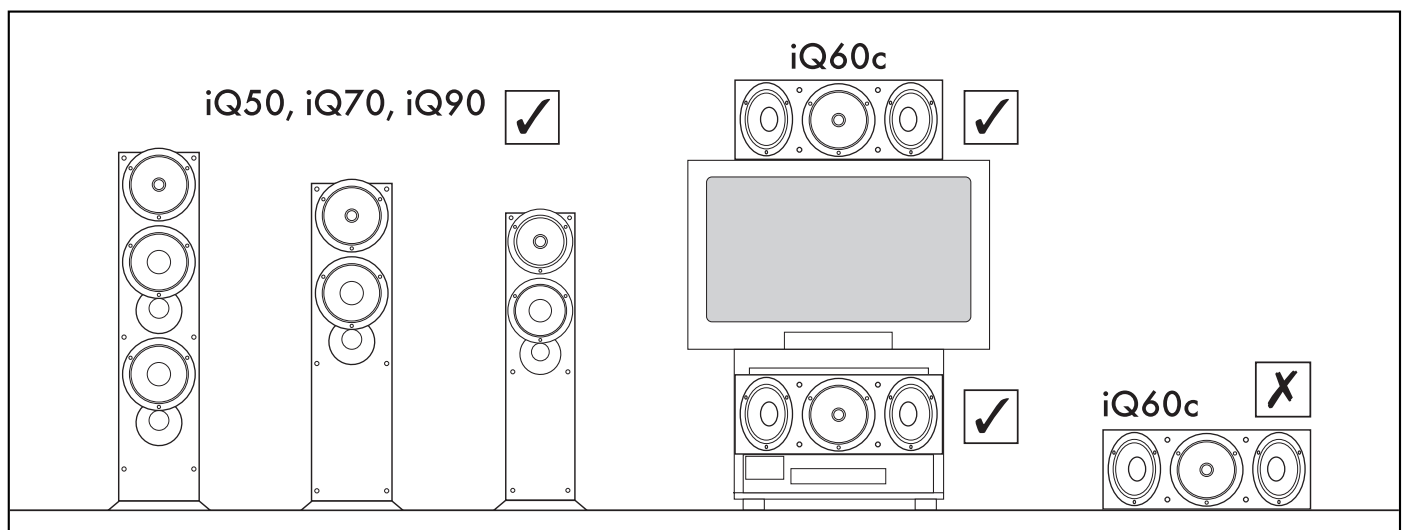
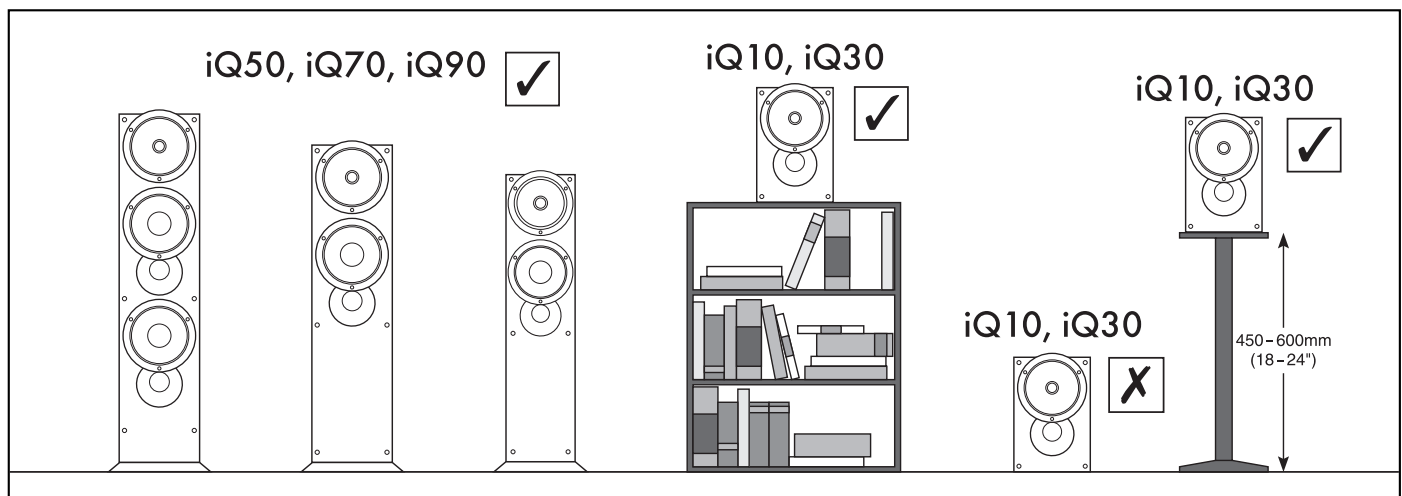

(GB) Positioning	(ES) Posicionamiento	(PL) Ustawienie położenia	(CN) 擺放定位
(F) Positionnement	(P) Posicionamento	(RU) Размещение	(TC) 擺放定位
(D) Aufstellung	(NL) Plaats en aansluiting	(GR) Ρύθμιση	(K) 설치 위치
(I) Posizionamento	(DK) Placering	(JP) 位置	

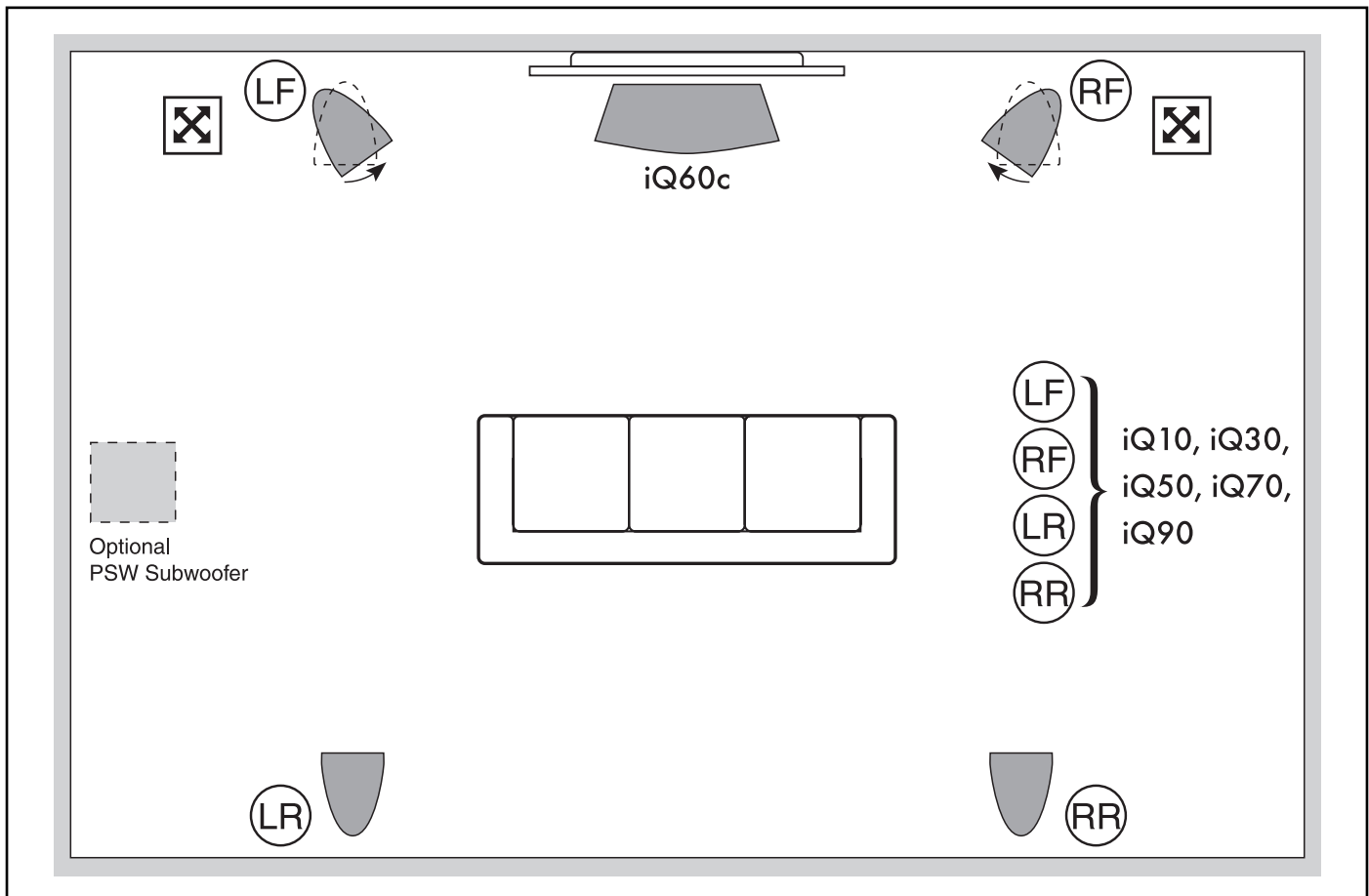
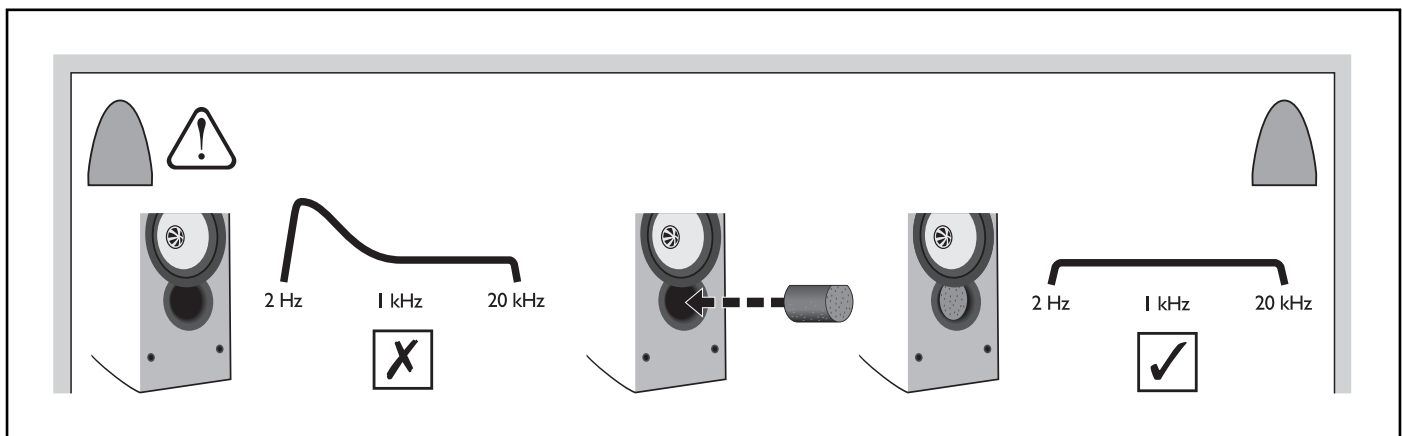
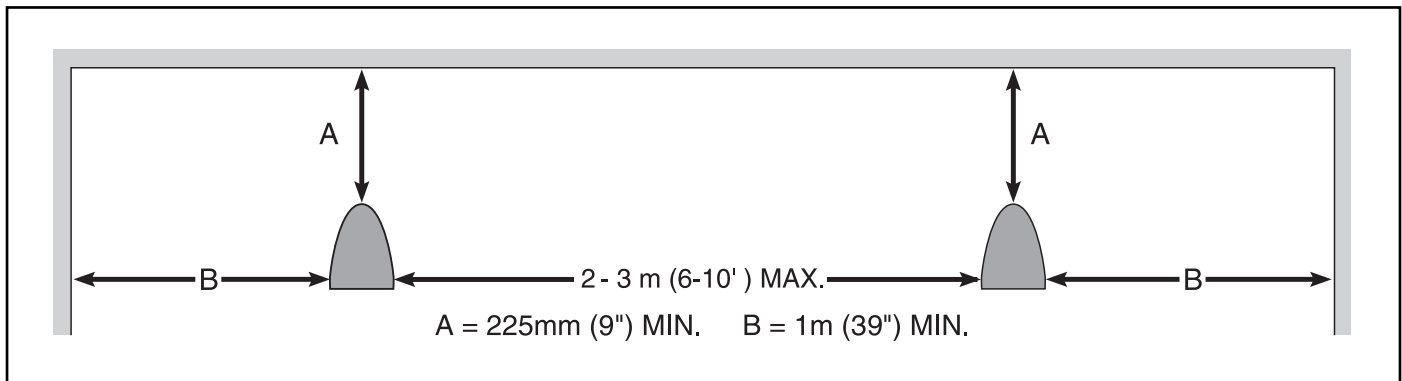

(GB) Connections
 (F) Connexions
 (D) Anschlüsse
 (I) Collegamenti

(ES) Conexiones
 (P) Ligações
 (NL) Aansluitingen
 (DK) Forbindelser

iQ10 iQ30 iQ50 iQ70 iQ90

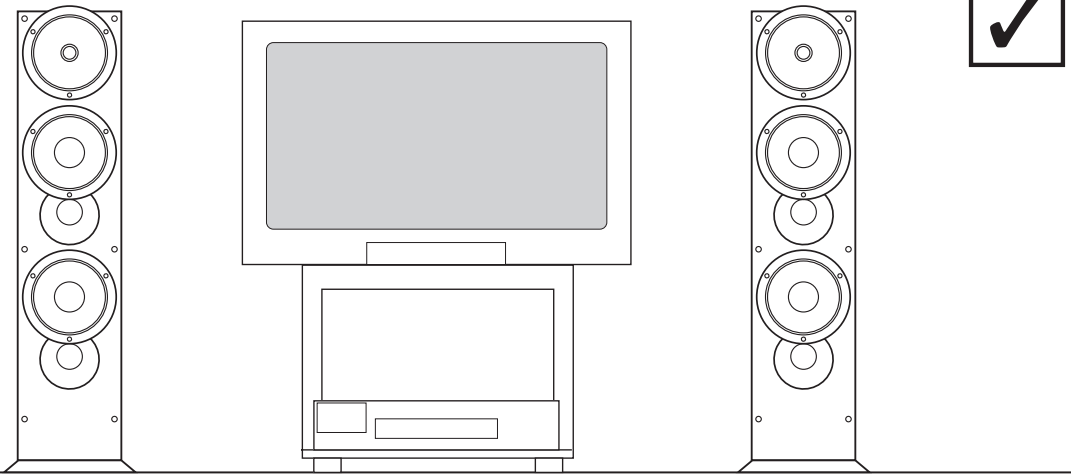

Single wire connections

- (F) Connexion à un fil.
- (D) Einzel-Kabelanschlüsse.
- (I) Conessioni "single wire".
- (ES) Conexiones de un solo hilo.
- (P) Ligações com um só cabo.
- (NL) Enkelvoudige draadverbindingen.
- (DK) Forbindelser til enkelt ledning.

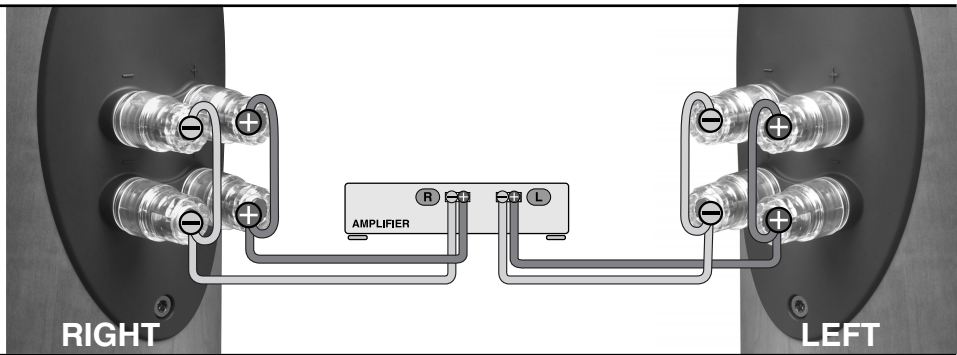

Bi-wired connections

- (F) Connexion à bi-câblage.
- (D) Bi-Wiring-Anschluss.
- (I) Conessioni "bi-wired".
- (ES) Conexiones de doble hilo.
- (P) Ligação em duplo cabo.
- (NL) Bi-Wire connectoren.
- (DK) Bi-wired forbindelser.

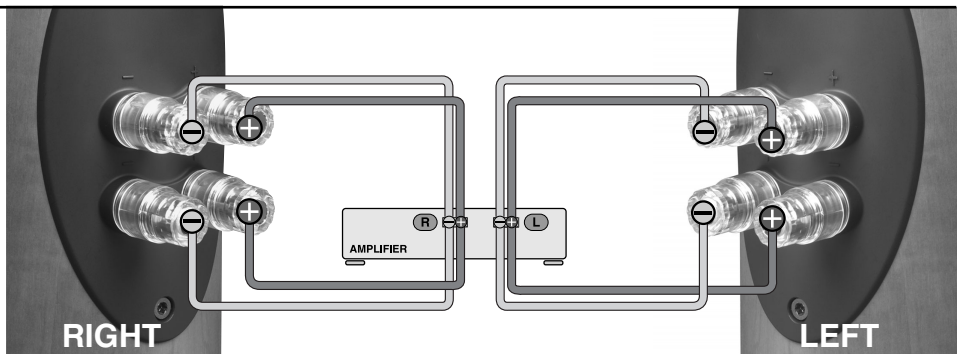

Bi-amplified connections

- (F) Connexion à bi-amplification.
- (D) Bi-Amping-Anschluss.
- (I) Conessioni "bi-amplification".
- (ES) Conexiones de biamplificación.
- (P) Ligações bi-amplificadas.
- (NL) Bi-Amp aansluitingen.
- (DK) Forbindelser til bi-amping.

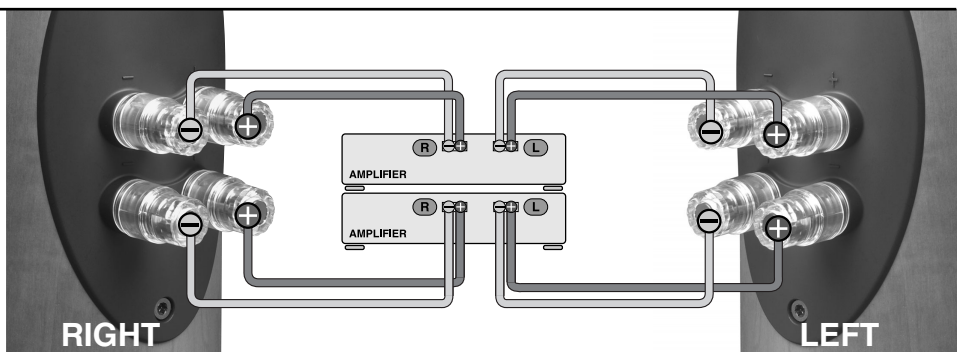

(GB) Connections
(F) Connexions
(D) Anschlüsse
(I) Collegamenti

(ES) Conexiones
(P) Ligações
(NL) Aansluitingen
(DK) Forbindelser

iQ60c

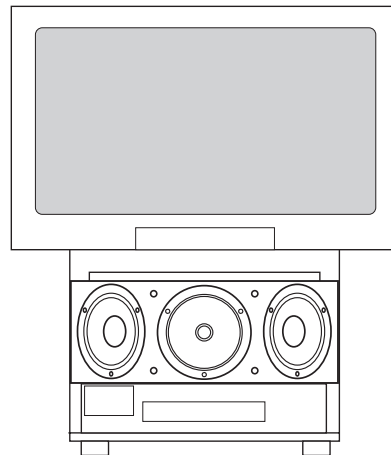

Single wire connections

- (F) Connexion à un fil.
- (D) Einzel-Kabelanschlüsse.
- (I) Conessioni "single wire".
- (ES) Conexiones de un solo hilo.
- (P) Ligações com um só cabo.
- (NL) Enkelvoudige draadverbindingen.
- (DK) Forbindelser til enkelt ledning.

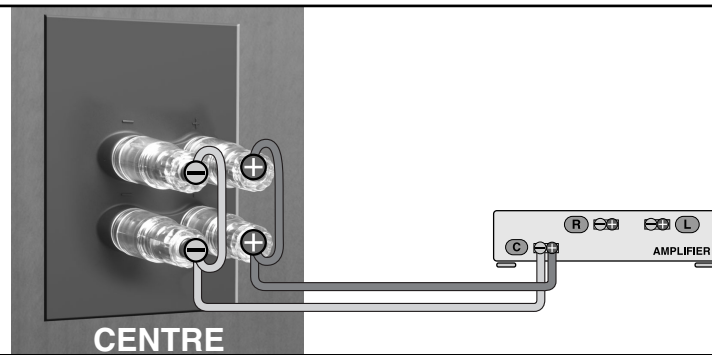

Bi-wired connections

- (F) Connexion à bi-câblage.
- (D) Bi-Wiring-Anschluss.
- (I) Conessioni "bi-wired".
- (ES) Conexiones de doble hilo.
- (P) Ligação em duplo cabo.
- (NL) Bi-Wire connectoren.
- (DK) Bi-wired forbindelser.

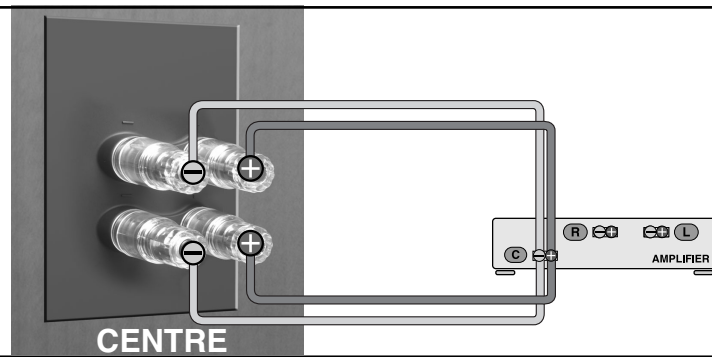

Bi-amplified connections

- (F) Connexion à bi-amplification.
- (D) Bi-Amping-Anschluss.
- (I) Conessioni "bi-amplification".
- (ES) Conexiones de biamplificación.
- (P) Ligações bi-amplificadas.
- (NL) Bi-Amp aansluitingen.
- (DK) Forbindelser til bi-amping.

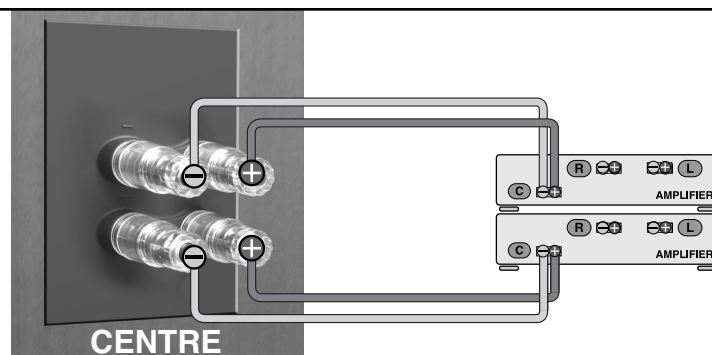

(GB) Connections
 (PL) Połączenia
 (RU) Соединения
 (GR) Συνδέσεις

(JP) 接続
 (CN) 箱体连接
 (TC) 箱體連接
 (K) 연결

iQ10 iQ30 iQ50 iQ70 iQ90

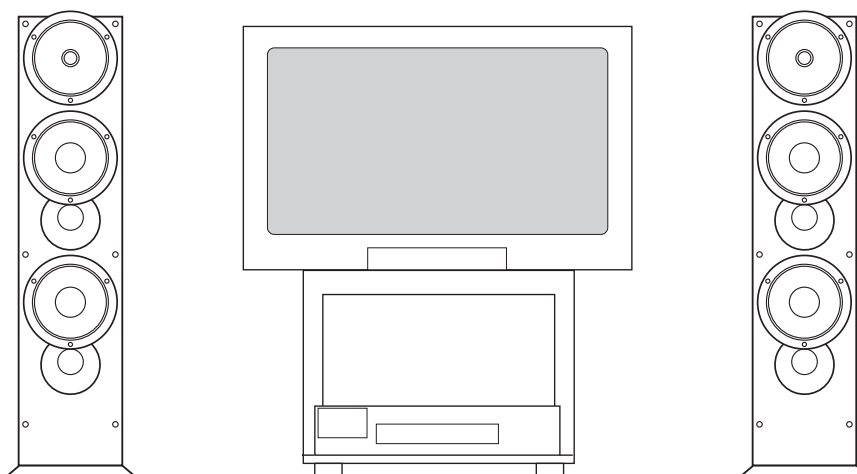

Single wire connections

- (PL) Połączenia kablami pojedynczymi
- (RU) Соединения одним кабелем
- (GR) Συνδέσεις μονού καλωδίου
- (JP) シングルワイヤー接続
- (CN) 单线连接
- (TC) 單線連接
- (K) 싱글 와이어 연결시

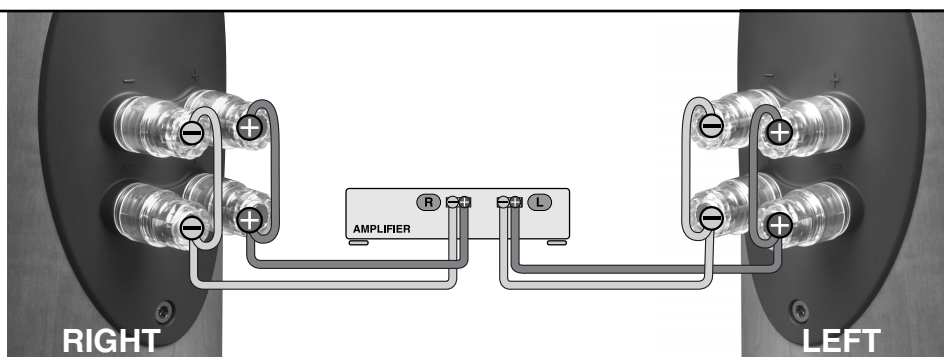

Bi-wired connections

- (PL) Połączenia kablami podwójnymi
- (RU) Соединения Bi-wire (парой кабелей)
- (GR) Συνδέσεις δύο καλωδίων
- (JP) バイワイヤー接続
- (CN) 双线分音连接
- (TC) 雙線分音連接
- (K) 바이 와이어 연결시

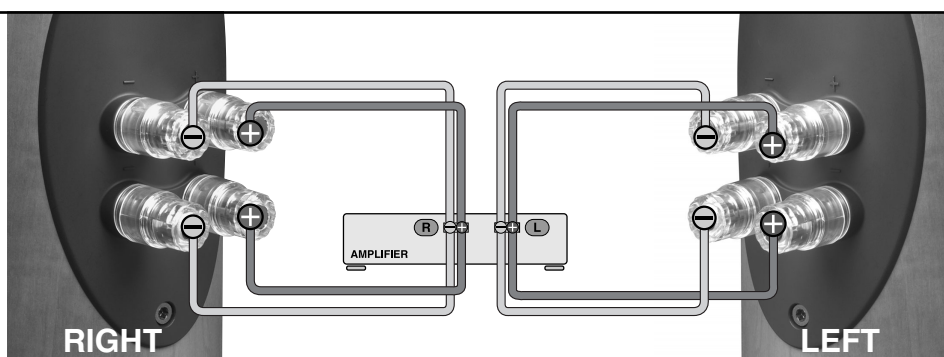

Bi-amplified connections

- (PL) Połączenia z podwójnym wzmacnieniem
- (RU) Соединения Bi-amr (парой усилителей)
- (GR) Συνδέσεις διπλής ενίσχυσης
- (JP) バイアンプ接続
- (CN) 双扩音连接
- (TC) 雙擴音連接
- (K) 바이 앰프 연결시

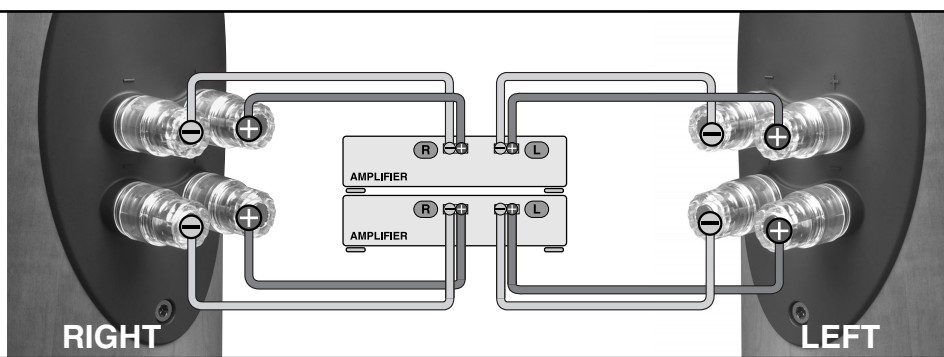

(GB) Connections
 (PL) Połączenia
 (RU) Соединения
 (GR) Συνδέσεις

(JP) 接続
 (CN) 箱体连接
 (TC) 箱體連接
 (K) 연결

iQ60c

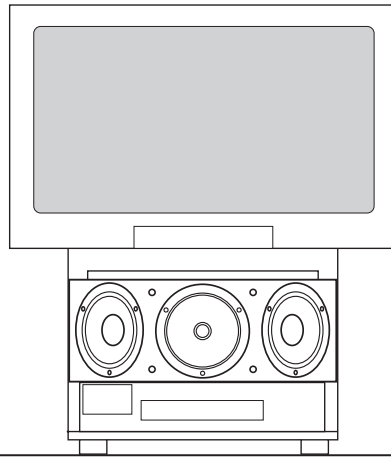

Single wire connections

- (PL) Połączenia kablami pojedynczymi
- (RU) Соединения одним кабелем
- (GR) Συνδέσεις μονού καλωδίου
- (JP) シングルワイヤー接続
- (CN) 单线连接
- (TC) 單線連接
- (K) 싱글 와이어 연결시

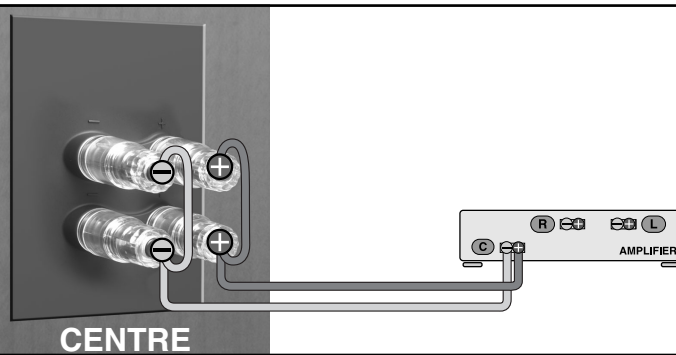

Bi-wired connections

- (PL) Połączenia kablami podwójnymi
- (RU) Соединения Bi-wire (парой кабелей)
- (GR) Συνδέσεις δύο καλωδίων
- (JP) バイワイヤー接続
- (CN) 双线分音连接
- (TC) 雙線分音連接
- (K) 바이 와이어 연결시

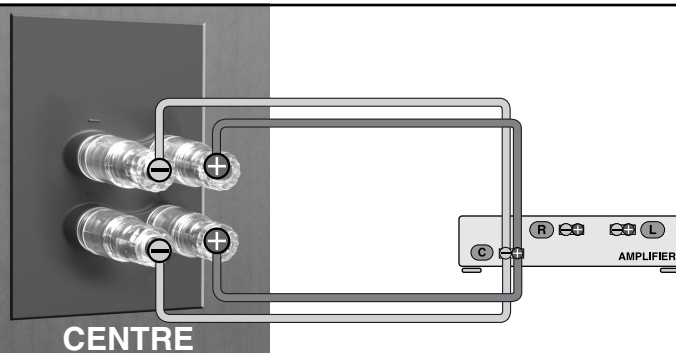





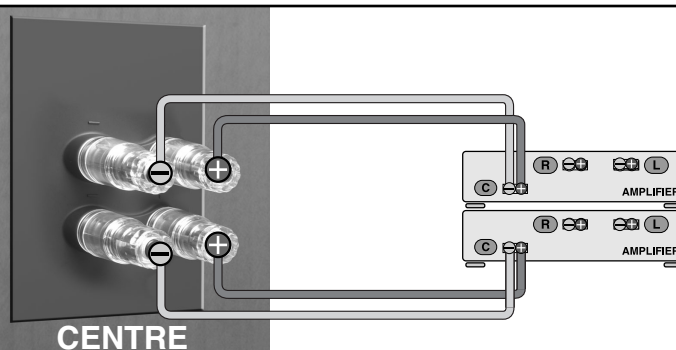



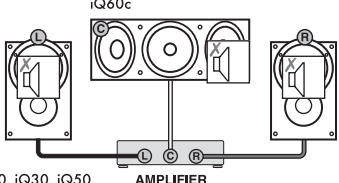
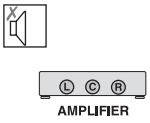

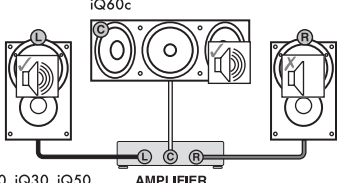
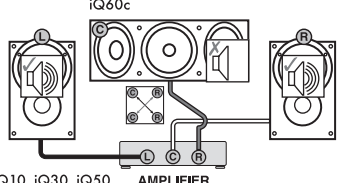
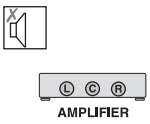

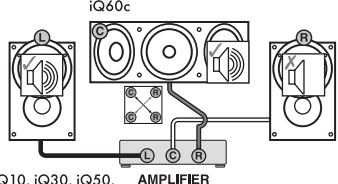
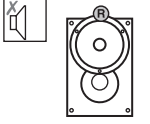

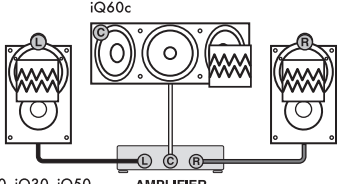
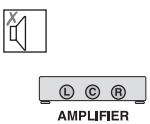

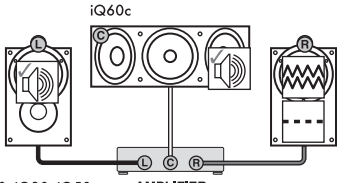
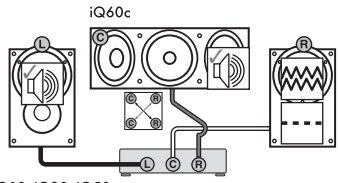
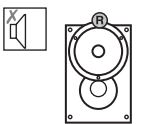
Bi-amplified connections

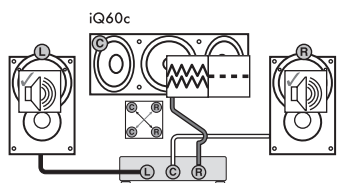
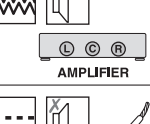

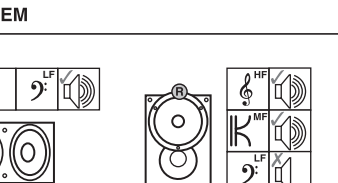
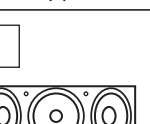
- (PL) Połączenia z podwójnym wzmacnieniem
- (RU) Соединения Bi-amp (парой усилителей)
- (GR) Συνδέσεις διπλής ενίσχυσης
- (JP) バイアンプ接続
- (CN) 双扩音连接
- (TC) 雙擴音連接
- (K) 바이 앰프 연결시

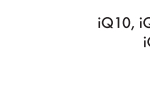

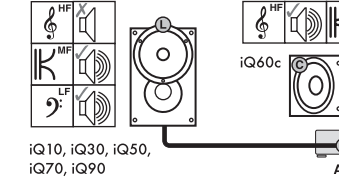
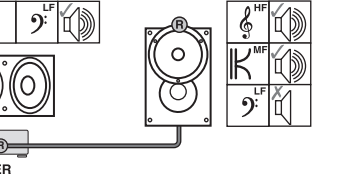
(GB) Fault Finding - (1) Problem / (2) Action / (3) Cause (NL) Opsporen van storingen - (1) Probleem / (2) Handeling / (3) Oorzaak
 (F) Dépannage - (1) Problème / (2) Action / (3) Cause (DK) Fejlfinding - (1) Problem / (2) Handling / (3) Årsag
 (D) Fehlersuche - (1) Problem / (2) Maßnahme / (3) Ursache (ES) Localización de averías - (1) Problema / (2) Acción / (3) Causa
 (I) Individuazione delle anomalie - (1) Problema / (2) Rimedio / (3) Causa (P) Localização de avarias - (1) Problema / (2) Solução / (3) Causa

(1) PROBLEM	(2) ACTION	(3) CAUSE	
 <p>iQ10, iQ30, iQ50, iQ70, iQ90</p>			 <p>(GB) Working (F) Fonctionne (D) Funktioniert (I) Funziona (ES) En funcionamiento (P) Está a funcionar (NL) Werkt (DK) Fungerer</p>
 <p>iQ10, iQ30, iQ50, iQ70, iQ90</p>	 <p>iQ10, iQ30, iQ50, iQ70, iQ90</p>		 <p>(GB) Not working (F) Ne fonctionne pas (D) Funktioniert nicht (I) Non funziona (ES) No funciona (P) Não está a funcionar (NL) Werkt niet (DK) Fungere ikke</p>
	 <p>iQ10, iQ30, iQ50, iQ70, iQ90</p>		 <p>(GB) Switch cables (F) Changer l'ordre de câblage (D) Kabel tauschen (I) Cavi dell'interruttore (ES) Cable de interruptores (P) Cabos de ligação (NL) Kabels verwisselen (DK) Byt kabler</p>
 <p>iQ10, iQ30, iQ50, iQ70, iQ90</p>			 <p>(GB) Treble / HF (F) Aigus / HF (D) Höhen (Hochfrequenzbereich)/HF (I) Alti / HF (ES) Agudos / HF (P) Agudos / HF (NL) Hoge tonen / HF (DK) Diskant / HF</p>
 <p>iQ10, iQ30, iQ50, iQ70, iQ90</p>	 <p>iQ10, iQ30, iQ50, iQ70, iQ90</p>		 <p>(GB) Mid-range / MF (F) Medium / MF (D) Mitteltonbereich (I) Medi / MF (ES) Gama de Medios / MF (P) Gama Média / MF (NL) midden tonen / MF (DK) Mellelton / MT</p>
 <p>iQ10, iQ30, iQ50, iQ70, iQ90</p>	 <p>iQ10, iQ30, iQ50, iQ70, iQ90</p>		 <p>(GB) Bass / LF (F) Basses / BF (D) Bässe (Bañfrequenzbereich)/LF (I) Bassi / LF (ES) Graves / LF (P) Graves /LF (NL) Lage tonen / LF (DK) Bas / LF</p>
	 <p>iQ10, iQ30, iQ50, iQ70, iQ90</p>		 <p>(GB) Intermittent sound (F) Son intermittent (D) Unterbrochene Wiedergabe (I) Suono intermittente (ES) Sonido intermitente (P) Som intermitente (NL) Onderbroken geluid (DK) Uregelmæssig lyd</p>
			 <p>(GB) Distorted sound (F) Son déformé (D) Verzerrter Klang (I) Distorsione del suono (ES) Sonido distorsionado (P) Som distorcido (NL) Vervormd geluid (DK) Lydforvrængning</p>
 <p>iQ10, iQ30, iQ50, iQ70, iQ90</p>		 <p>iQ10, iQ30, iQ50, iQ70, iQ90</p>	

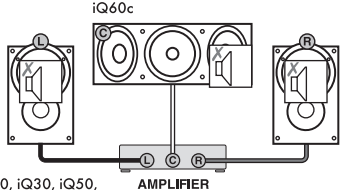
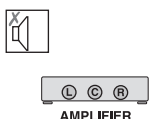
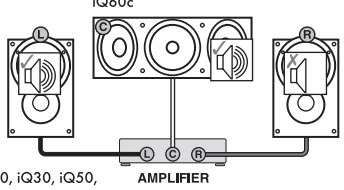
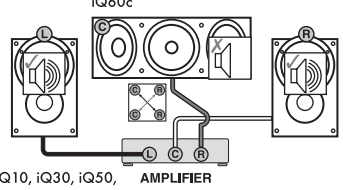
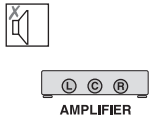
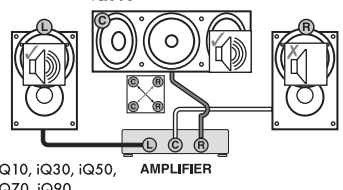
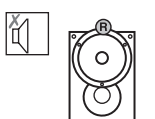
(GB) Fault Finding - (1) Problem / (2) Action / (3) Cause (JP) 問題の発見 - (1) 問題 / (2) 行動 / (3) 原因
 (PL) Rozwiązywanie problemów — (1) Problem / (2) Działanie / (3) Przyczyna (CN) 故障检修 — (1) 问题 / (2) 采取措施 / (3) 原因
 (RU) Поиск неисправности - (1) Проблема / (2) Действие / (3) Причина (TC) 故障检修 — (1) 問題 / (2) 採取措施 / (3) 原因
 (GR) Εντοπισμός δυσλειτουργίας - (1) Πρόβλημα / (2) Αντιμετώπιση / (3) Αιτία (K) 고장이라고 생각하시기 전에 - (1) 문제점 / (2) 해결책 / (3) 원인

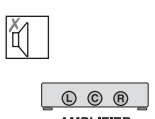
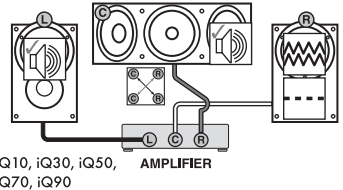
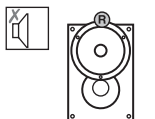
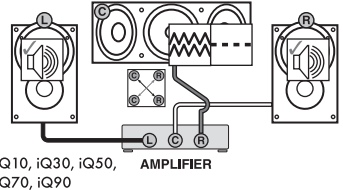
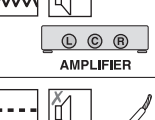
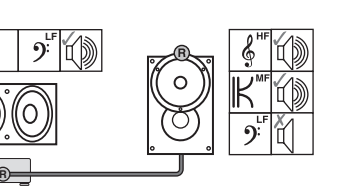
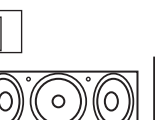
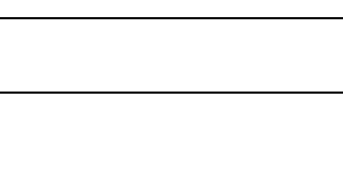
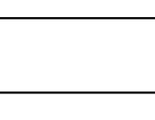
(1) PROBLEM	(2) ACTION	(3) CAUSE		
 <p>iQ10, iQ30, iQ50, iQ70, iQ90</p>			<p>(GB) Working (PL) Działa (RU) Работает (GR) Λειτουργεί (JP) 動作する (CN) 正常运作 (TC) 正常運作 (K) 작동함</p>	
 <p>iQ10, iQ30, iQ50, iQ70, iQ90</p>	 <p>iQ10, iQ30, iQ50, iQ70, iQ90</p>		<p>(GB) Not working (PL) Nie działa (RU) Не работает (GR) Δεν λειτουργεί (JP) 動作しない (CN) 不正常运作 (TC) 不正常運作 (K) 작동안함</p>	
		 <p>iQ10, iQ30, iQ50, iQ70, iQ90</p>		<p>(GB) Switch cables (PL) Zamień kable (RU) Переключите кабели (GR) Αλλαγή καλωδίων (JP) ケーブルを入れ替える (CN) 对换连接线 (TC) 對換連接線 (K) 케이블 연결 확인</p>
		 <p>iQ10, iQ30, iQ50, iQ70, iQ90</p>		<p>(GB) Treble / HF (PL) Tony wysokie / HF (RU) Высокие частоты / ВЧ (GR) Πρίμα / HF (JP) 高域 / HF (CN) 高音 / HF (TC) 高音 / HF (K) 고음 / HF</p>
		 <p>iQ10, iQ30, iQ50, iQ70, iQ90</p>		<p>(GB) Mid-range / MF (PL) Średni zakres tonów / MF (RU) Средние частоты / СЧ (GR) Μεσαία / MF (JP) 中域 / MF (CN) 中音 / MF (TC) 中音 / MF (K) 중음 / MF</p>
		 <p>iQ10, iQ30, iQ50, iQ70, iQ90</p>		<p>(GB) Bass / LF (PL) Tony niskie / LF (RU) Низкие частоты / НЧ (GR) Μπάσα / LF (JP) 低域 / LF (CN) 低音 / LF (TC) 低音 / LF (K) 저음 / LF</p>
		 <p>iQ10, iQ30, iQ50, iQ70, iQ90</p>		<p>(GB) Intermittent sound (PL) Przerwywany dźwięk (RU) Пропадающий звук (GR) Διαλείπων ήχος (JP) 音が途切れる (CN) 声音断断续续 (TC) 聲音斷斷續續 (K) 소리가 나왔다 안 나왔다 할 때</p>
		 <p>iQ10, iQ30, iQ50, iQ70, iQ90</p>		<p>(GB) Distorted sound (PL) Zniekształcony dźwięk (RU) Искаженный звук (GR) Παραμορφωμένος ήχος (JP) 音がひずむ (CN) 声音失真 (TC) 聲音失真 (K) 소리가 왜곡될 때</p>

(GB) Specifications (ES) Especificaciones (PL) Specyfikacja techniczna (CN) 规格特性
 (F) Spécifications (P) Especificações (RU) Технические характеристики (TC) 规格特性
 (D) Technische Merkmale (NL) Technische gegevens (GR) Προδιαγραφές (K) 주요사양
 (I) Specifiche (DK) Specifikationer (JP) スペック

Q SERIES

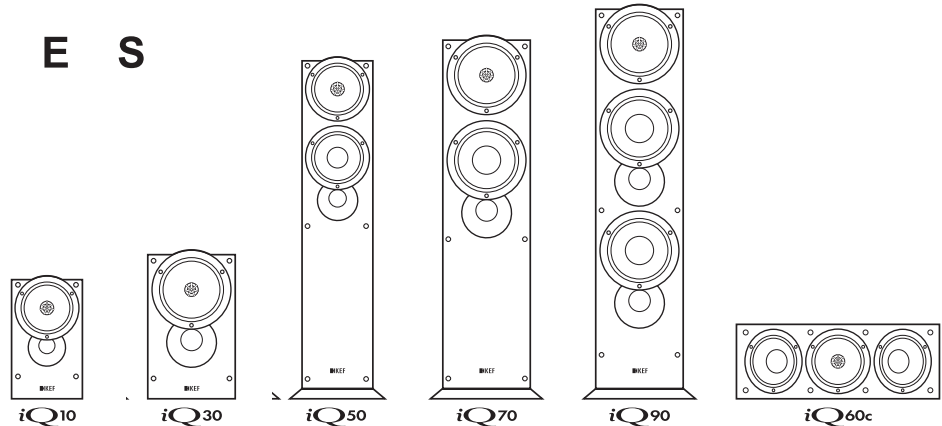

iQ10

iQ30

iQ50

iQ70

iQ90

Design	Two-way bass reflex	Two-way bass reflex	Two and a half-way bass reflex	Two and a half-way bass reflex	Three-way bass reflex
Drive units	130mm (5.25in.) Uni-Q 19mm (0.75in.) alu dome HF	165mm (6.5in.) Uni-Q 19mm (0.75in.) alu dome HF	130mm (5.25in.) LF 130mm (5.25in.) Uni-Q 19mm (0.75in.) alu dome HF	165mm (6.5in.) LF 165mm (6.5in.) Uni-Q 19mm (0.75in.) alu dome HF	2 x 165mm (6.5in.) LF 165mm (6.5in.) Uni-Q 19mm (0.75in.) alu dome HF
Frequency response	50Hz - 40kHz	45Hz - 40kHz	40Hz - 40kHz	36Hz - 40kHz	33Hz - 40kHz
Crossover frequency	2.5kHz	2.5kHz	2.5kHz	2.5kHz	180Hz - 2.5kHz
Amplifier requirements	10-100W	15-120W	15-130W	15-150W	15-200W
Sensitivity (2.83V/1m)	88dB	89dB	88dB	90dB	91dB
Maximum output	108dB	110dB	109dB	111dB	113dB
Nominal impedance	8Ω	8Ω	8Ω	8Ω	8Ω
Magnetic shielding	Yes	Yes	Yes	Yes	Yes
Weight	4.5kg (9.9lbs)	6.45kg (14.2lbs)	10.2kg (22.5lbs)	14kg (30.9lbs)	16.3kg (35.9lbs)
Dimensions H x W x D	301 x 175 x 261 mm 11.8 x 6.9 x 10.3 in.	365 x 220 x 327 mm 14.4 x 8.7 x 12.9 in.	815 x 175 x 261 mm 32 x 6.9 x 10.3 in.	865 x 220 x 327 mm 34 x 8.7 x 12.9 in.	942 x 220 x 327 mm 37 x 8.7 x 12.9 in.
Plinth Dimensions H x W x D	N/A	N/A	28 x 250 x 295 mm 1.1 x 9.8 x 11.6 in.	28 x 288 x 348 mm 1.1 x 11.3 x 13.7 in.	28 x 288 x 348 mm 1.1 x 11.3 x 13.7 in.

iQ60c

Design	Three-way bass reflex
Drive units	2 x 130mm (5.25in.) LF 130mm (5.25in.) Uni-Q 19mm (0.75in.) alu dome HF
Frequency response	65Hz - 40kHz
Crossover frequency	280Hz - 2.8kHz
Amplifier requirements	15-150W
Sensitivity (2.83V/1m)	90dB
Maximum output	111dB
Nominal impedance	8Ω
Magnetic shielding	Yes
Weight	8.8kg (19.4lbs)
Dimensions H x W x D	165 x 512 x 255 mm 6.5 x 20.1 x 10 in.

GP Acoustics (UK) Ltd., Eccleston Road, Tovil, Maidstone, Kent, ME15 6QP U.K.
 Tel: + 44 (0)1622 672261 Fax: + 44 (0)1622 750653

GP Acoustics (US) Inc., 10 Timber Lane, Marlboro, New Jersey 07746 U.S.A.
 Tel: +(1) 732 683 2356 Fax: +(1) 732 683 2358

GP Acoustics GmbH, Am Brambusch 22, D-44536 Lünen, Deutschland.
 Tel: +49 (0) 231 9860-320 Fax: +49 (0) 231 9860-330

GP Acoustics (France) SAS, 39 Rue des Granges Galand - BP60414,
 37554 Saint Avertin CEDEX, France.
 Tel : +33(0)2 47 80 49 01 Fax: +33(0)2 47 27 89 64

GP Acoustics (HK) Limited, 6F, Gold Peak Building, 30 Kwai Wing road,
 Kwai Chung, N.T., Hong Kong.
 Tel : +852 2410 8188 Fax: +852 2401 0754

KEF JAPAN I-11-17, Honcho, Koganei-City, Tokyo, JAPAN 184-0004
 Tel: +81 (0)42-388-2030 E-mail: info@kef.jp



KEF and Uni-Q are registered trademarks. Uni-Q is protected under GB patent 2 236929, U.S. Pat. No. 5,548,657 and other worldwide patents. KEF reserve the right, in line with continuing research and development, to amend or change specifications.

www.kef.com



Free Manuals Download Website

<http://myh66.com>

<http://usermanuals.us>

<http://www.somanuals.com>

<http://www.4manuals.cc>

<http://www.manual-lib.com>

<http://www.404manual.com>

<http://www.luxmanual.com>

<http://aubethermostatmanual.com>

Golf course search by state

<http://golfingnear.com>

Email search by domain

<http://emailbydomain.com>

Auto manuals search

<http://auto.somanuals.com>

TV manuals search

<http://tv.somanuals.com>