

Instructions for the KEF picoforte™ 3 Stereo System

picoforte™

designed for iPod

www.kef.com

GP Acoustics (UK) Ltd., Eccleston Road, Tovil, Maidstone, Kent, ME15 6QP U.K. Telephone + 44 (0) 1622 672261 Fax: + 44 (0) 1622 750653

GP Acoustics (US) Inc., 10 Timber Lane, Marlboro, New Jersey 07746 U.S.A. Telephone +(1) 732 683 2356 Fax: +(1) 732 683 2358

GP Acoustics GmbH, Heinrichstraße 51, D-44536 Lünen, Deutschland. Telephone + 49 (0) 231 9860-320 Fax: + 49 (0) 231 9860-330

GP Acoustics (France) SAS, 39 Rue des Granges Galand - BP414, 37554 Saint Avertin CEDEX, France. Téléphone +33(0)2 47 80 49 01 Fax: +33(0)2 47 27 89 64

GP Acoustics (HK) Ltd., 6F, Gold Peak Building, 30 Kwai Wing Road, Kwai Chung, N.T., Hong Kong. Telephone +85 (0) 2410 8188 Fax: +85 (0) 2401 0754

KEF JAPAN 1-1-17, Honcho, Koganei-City, Tokyo, JAPAN 184-0004 Telephone +81 (0)42-388-2030 E-mail: info@kef.jp

GP Acoustics (UK) Ltd., reserve the right, in line with continuous research and development, to amend or change specifications without prior notice. E. & O.E.

KEF and Uni-Q are registered trademarks. Uni-Q is protected under GB patent 2 236929, US Pat. No. 5,548,657 and other worldwide patents.

iPod is a trademark of Apple Inc., registered in the U.S. and other countries.



(GB) Care and Safety

(F) Précautions d'utilisation et sécurité (D) Pflege & Sicherheit (I) Manutenzione & sicurezza (ES) Cuidados y Seguridad (P) Cuidados & Segurança
(NL) Onderhoud en Veiligheid (RU) Меры безопасности и уход (CN)
(TC) (J) 注意事項と安全性



This device complies with part 15 of the FCC Rules. Operation is subject to the following conditions:
1) this device does not cause harmful interference.
2) this device will accept any interference received, including interference that may cause undesired operation.

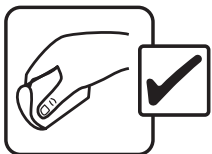

(GB) Clean with a dry lint free cloth
(F) Nettoyer à l'aide d'un chiffon humide, non pelucheux
(D) Mit einem angefeuchteten, nicht fuselnden Tuch abwischen
(I) Pulire con un panno umido non sfilacciato
(ES) Limpie con un paño húmedo
(P) Limpe com um pano húmido sem pêlos
(NL) Reinigen met een vochtige niet pluizende doek
(RU) Чистить сухой тряпкой не оставляющей ворсинок
(CN)
(TC)
(J) 乾いたけばのない柔らかい布でクリーニングする事。



(GB) Do not use spirit based cleaners
(F) Ne pas utiliser d'agents nettoyants à base d'alcool
(D) Keine alkoholhaltigen Reinigungsmittel verwenden
(I) Non utilizzare prodotti a base di alcol
(ES) No use limpiadores con base de alcohol
(P) Não utilize produtos de limpeza à base de álcool
(NL) Gebruik geen reinigingsprodukten op basis van alcohol
(RU) Не используйте чистящие средства на спиртовой основе
(CN)
(TC)
(J) 有機溶剤主成分の洗剤は使用してはならない。



(GB) Avoid damp
(F) Eviter l'humidité
(D) Feuchtigkeit vermeiden
(I) Evitare l'umidità
(ES) Evite la humedad
(P) Evite a humidade
(NL) Vermijd vocht
(RU) Избегайте влаги
(CN)
(TC)
(J) 湿気を避ける事。



(GB) SAFETY NOTICE! trailing cables are dangerous, secure all cables
(F) NOTE DE SECURITE ! Les câbles de haut-parleurs traînant sur le sol peuvent être source de danger. Fixer tous les câbles
(D) SICHERHEITSHINWEIS ! Herumliegende Lautsprecherkabel sind eine Gefahrenquelle. Bitte alle Lautsprecherkabel sorgfältig verlegen
(I) NOTA PER LA SICUREZZA: i cavi di uscita dei diffusori possono essere pericolosi se non sistemati in un posto sicuro
(ES) ¡ATENCIÓN! los cables de conexión sueltos de los altavoces son peligrosos
(P) PRECAUÇÕES DE SEGURANÇA! Os cabos das colunas espalhados são perigosos, fixe todos os cabos
(NL) VOOR UWVEILIGHEID! Loshangende luidsprekerkabels zijn gevaarlijk! De kabels steeds op een veilige plaats leggen
(RU) МЕРЫ БЕЗОПАСНОСТИ! Висящие кабели представляют собой опасность. Обеспечьте, чтобы кабели не висели и были надежно подсоединены
(CN)
(TC)
(J) 安全上の注意！後端ケーブル線は危険なので、それらのケーブル線は全部、安全に保つ事。

(GB) Contents

(F) Contenu (D) Inhalt (I) Contenuto (ES) Contenido (P) Conteúdo (NL) Inhoud (RU) Комплектация (CN)

(TC)

(J) 内容

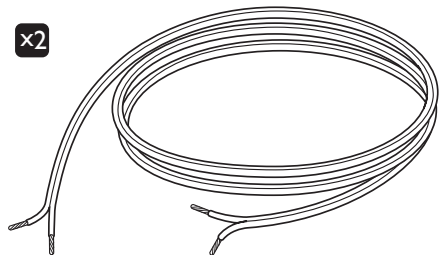
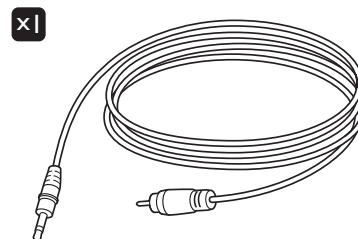
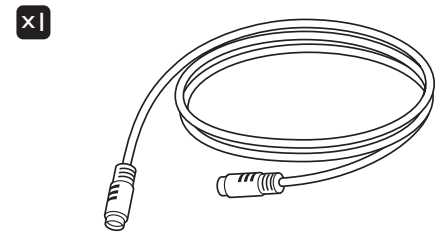
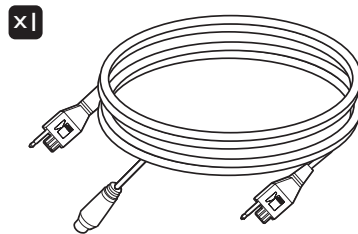
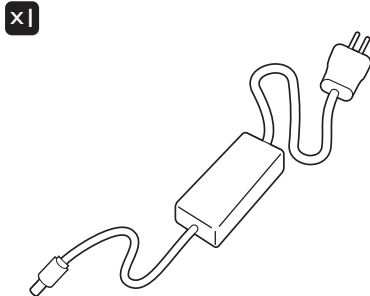
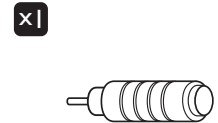
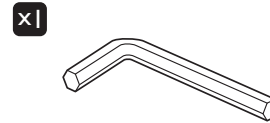
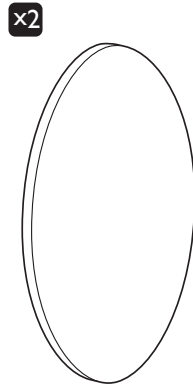
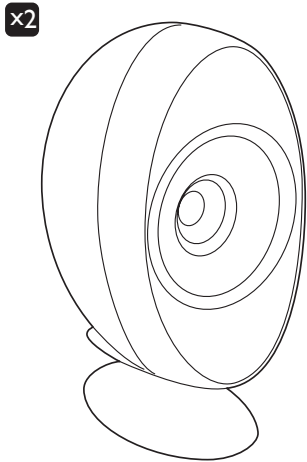
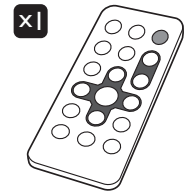
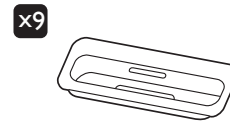
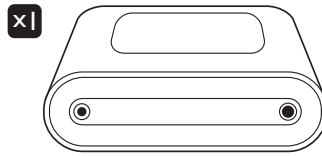
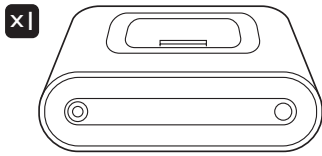

(GB) Connections to Speakers and Amplifier

(F) Connexions aux enceintes et à l'amplicateur (D) Verbindung zu den Lautsprechern und dem Verstärker (I) Connessioni ai diffusori e all'amplificatore

(ES) Conexiones de altavoces y amplificador (P) Ligações a Colunas e Amplificador (NL) Verbinding met luidsprekers en versterker

(RU) Подключение к акустическим системам и усилителю (CN)

(TC)

(J) スピーカーとアンプとの接続

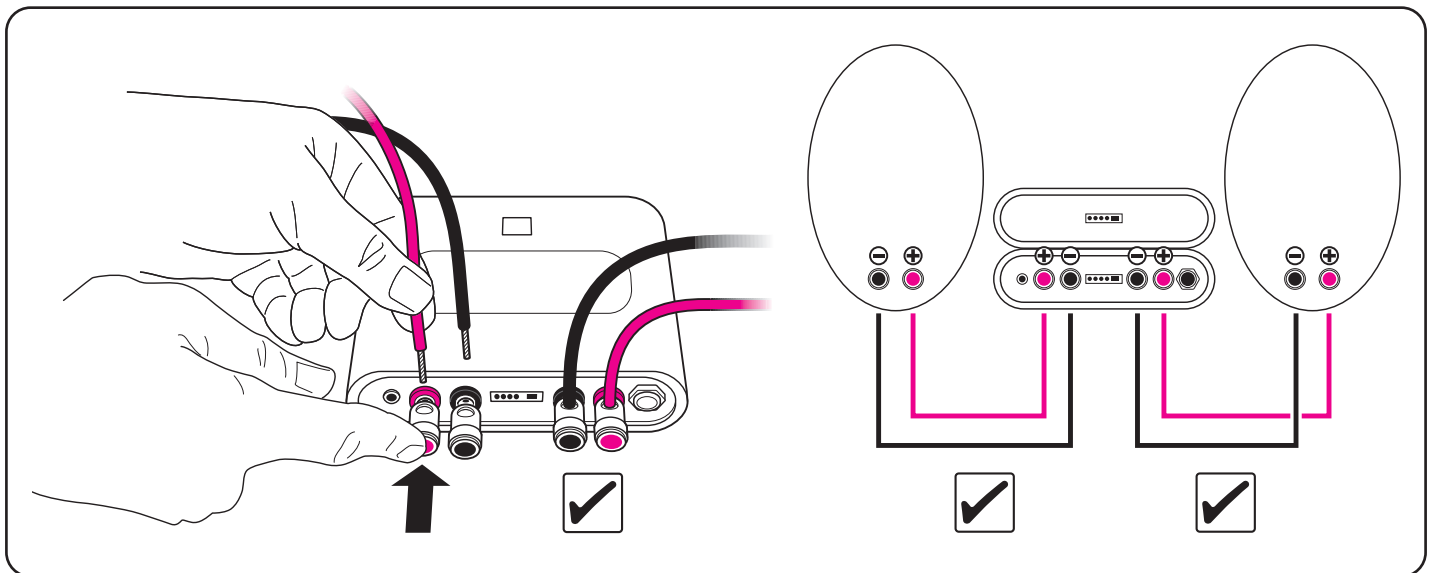
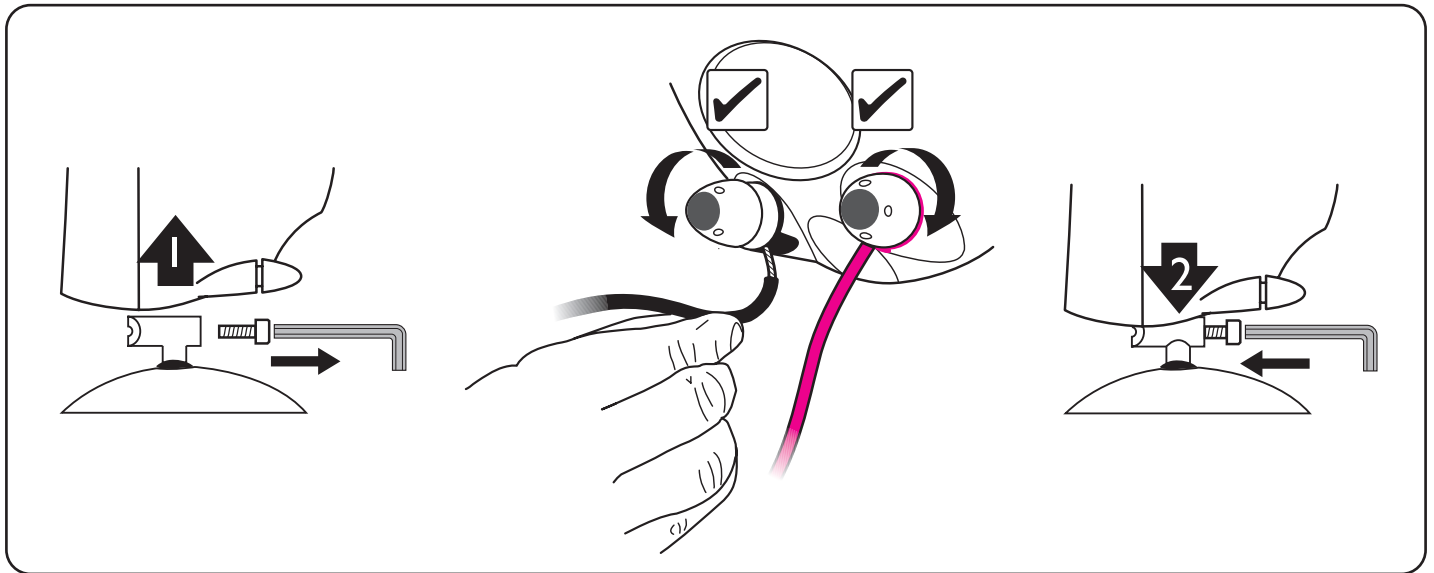





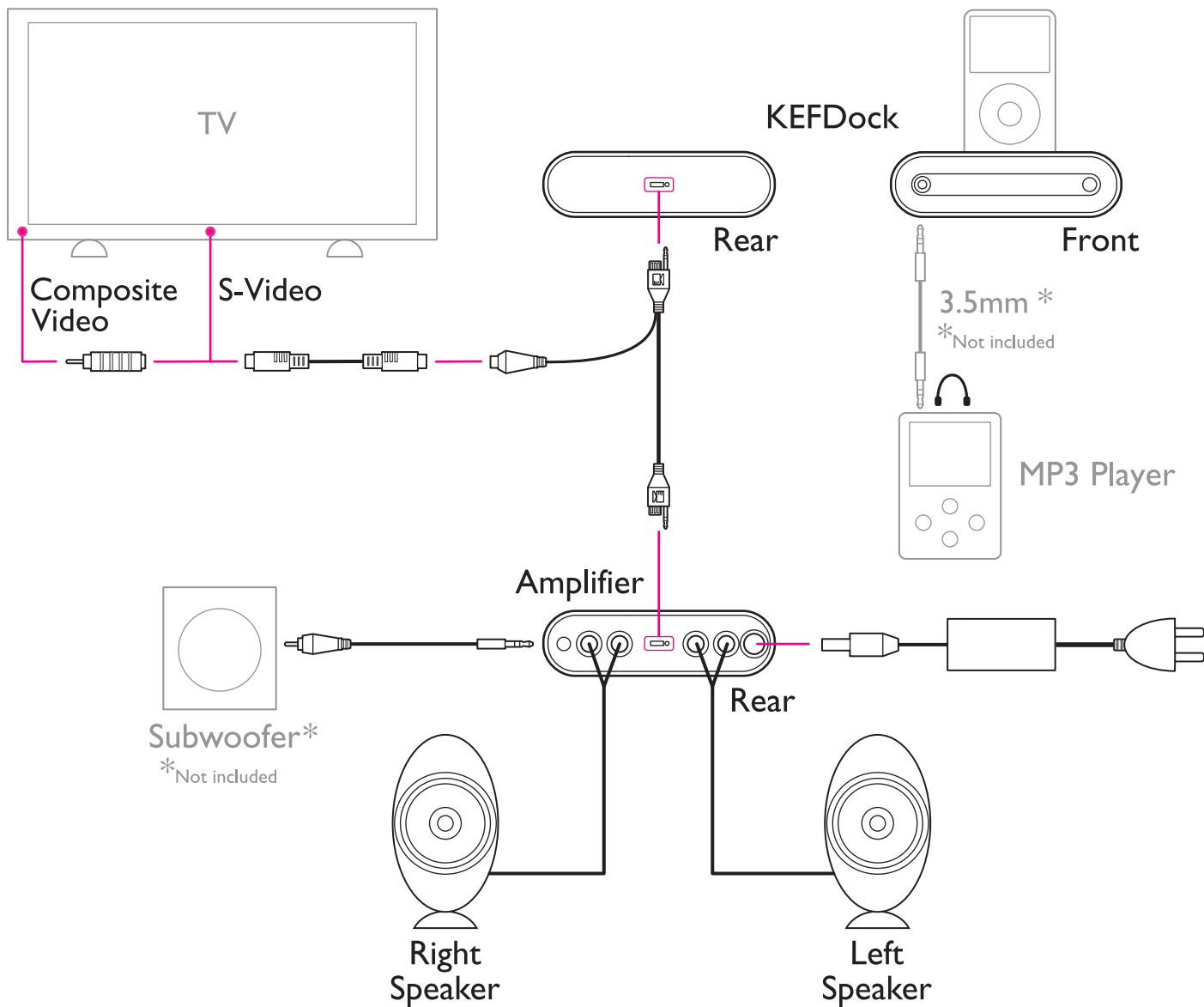





(GB) KEF picoforte™ Connections

(F) Connexions du système KEF picoforte™ (D) KEF picoforte™ Verbindungen (I) Connessioni del KEF picoforte™ (ES) Conexiones KEF picoforte™
(P) Ligações KEF picoforte™ (NL) KEF picoforte™ verbindingen (RU) Коммутация KEF picoforte™ (CN)
(TC) (J) KEFピコフォルテ™接続



(GB) Navigation

	display the menu on the iPod screen / display the menu on the TV screen
MUTE	mute and activate the volume
	turn the system on and off
	stop the current track playing
	play or pause the selected track
VOL 	increase or decrease the system volume
MENU	go to previous menu
	navigate the menu
	page skip up or down a menu screen
SELECT	play the iPod music track or select the highlighted menu item
	rewind or fast-forward through a track
	jump to previous track
	repeat-track / repeat-all / shuffle
	jump to the next track

Videos and Photos are only displayed on the TV screen if the PLAY button is pressed on the iPod and the iPod supports these features. - Also the iPod TV out settings must be set to ON in both the Slideshow and the Video Settings menus.

Connecting an MP3 player via an audio cable (not included) to KEFDock will switch off iPod connection. To switch back to the iPod playback, unplug the audio cable from the KEFDock.

(GB) Using the Credit Card Remote / Battery Replacement

(F) Utilisation de la télécommande extra plate / Changement de la batterie (D) Verwendung der Fernbedienung/ Austausch der Batterie (I) Utilizzo del telecomando e sostituzione delle batterie (ES) Uso del mando a distancia tipo tarjeta / Cambio de las pilas (P) Usando o cartão de controlo remoto / Substituição das pilhas (NL) Gebruik van creditcard afstandsbediening en vervanging van een batterij (RU) Использование пульта ДУ/Замена элементов питания (CN) (TC) (J) クレジットカード型リモコンの使用 / 乾電池交換

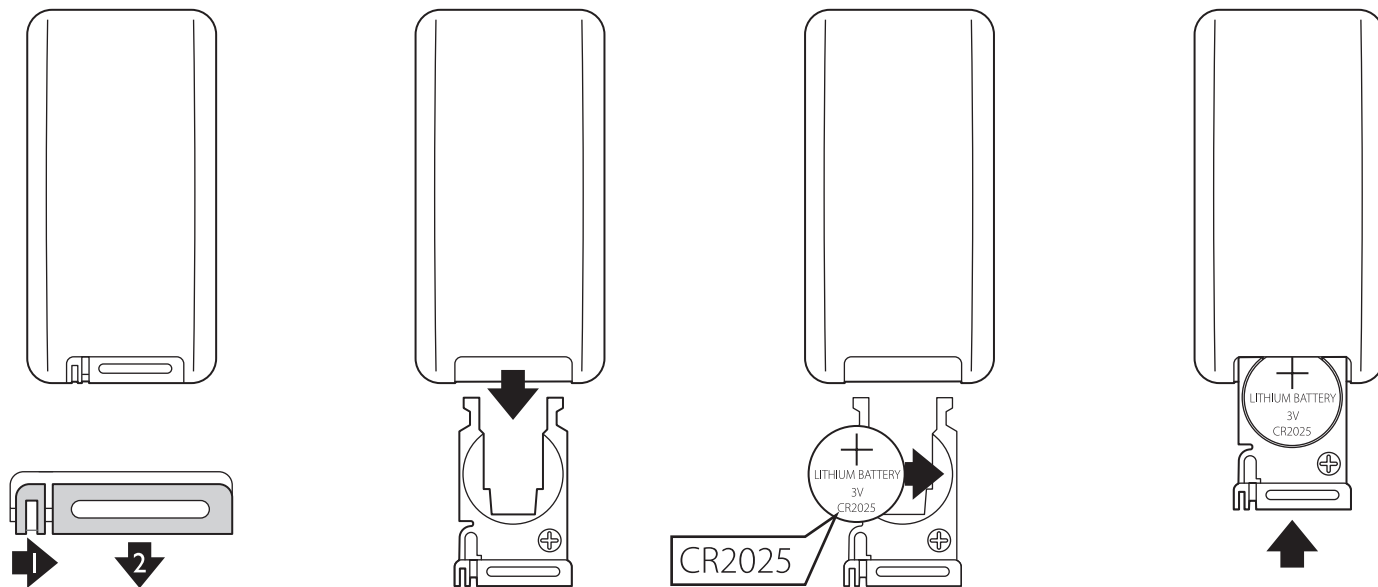

(GB) Specifications

(F) Spécifications (D) Technische Daten (I) Specifiche (ES) Especificaciones (P) Especificações (NL) Technische gegevens (RU) Характеристики
(CN) (TC) (J) スペック (規格)

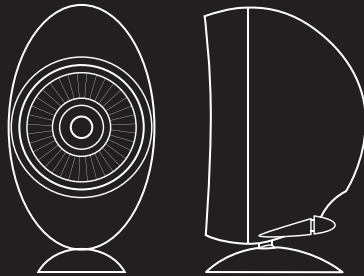

Model	picoforte™ 3
Design	Bass reflex two-way
Drive Unit Array	115mm (4.5in.) Uni-Q® 19mm (0.75in.) aluminium HF
Frequency Response*	60Hz - 55kHz
Sensitivity (2.83V/1m)	88dB
Maximum Output (SPL @ 1m)	100dB
Weight	2kg (4.5lbs)
Dimensions (H x W x D)	245 x 125 x 150 mm (9.6 x 4.9 x 5.9 in.)
Finish	High Gloss Black and High Gloss White

* without the optional subwoofer

(GB) Specifications

(F) Spécifications (D) Technische Daten (I) Specifiche (ES) Especificaciones (P) Especificações (NL) Technische gegevens (RU) Характеристики
(CN) (TC) (J) スペック (規格)

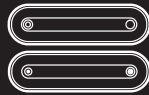











Supported iPod models

iPod video 30GB, 80GB.
iPod Nano 1GB to 8GB.
All iPods with colour display 20GB to 60GB.
All iPods 10GB to 40GB. iPod mini 4GB, 6GB.
iPod with click wheel 20GB, 40GB.

Inputs	iPod or stereo audio input through a 3.5mm jack plug from a MP3 player or computer
Video Output	S-video or Composite
Language Supported	English French German Italian Portuguese Spanish Traditional Chinese Simplified Chinese Korean Japanese And other uni-code based languages
Peak Audio Output	2 x 35W digital amplifiers
Subwoofer Output	Line level output for optional subwoofer
Cabinet Material	Die-cast zinc
Control	Through infra-red remote
Weight	0.75kg (1.65lbs)
Dimensions (H x W x D) (per unit)	29 x 101 x 85 mm (1.1 x 4.0 x 3.3 in.)











(F) Navigation

	sélectionner la station d'accueil KEF et afficher le menu sur l'écran TV / afficher les menus de l'iPod sur l'écran
MUTE	activer / désactiver le volume
	activer / désactiver le système
	arrêter le titre en cours
	activer ou mettre sur pause le titre sélectionné
VOL 	augmenter ou baisser le niveau du volume
MENU	retour au menu précédent
	navigation interne au menu
	passer ou revenir au menu précédent
SELECT	afficher le titre de votre choix où sélectionner l'article souligné dans le menu
	retour ou avance rapide à un titre
	revenir au titre précédent
	répéter le titre / répéter tout / aléatoire
	passer au titre suivant

Les vidéos et les photos ne sont affichées sur l'écran TV que si le bouton « PLAY » est pressé sur l'iPod et si l'iPod possède cette fonction. La fonctionnalité de l'écran doit également être en position « ON » à la fois dans le menu diaporama et dans les fonctionnalités du menu Vidéo.

La connexion d'un lecteur MP3 via un câble audio (non inclus) à la station d'accueil désactivera la connexion de l'iPod. Pour l'activer de nouveau, débrancher la câble audio de la station d'accueil KEF.











(D) Navigation

	wählt das KEFDock und zeigt das Menü auf dem TV-Bildschirm / zeigt die Menüs auf dem iPod-Bildschirm
MUTE	schaltet die Lautstärke stumm oder laut
	schaltet das System ein und aus
	beendet die Wiedergabe des aktuellen Titels
	spielt den ausgewählten Titel ab oder schaltet auf Pause
VOL 	erhöht oder verringert die Lautstärke des Systems
MENU	wählt das vorherige Menü
	navigiert durch das Menü
	springt innerhalb des Menüpunktes vor und zurück
SELECT	spielt den iPod-Musiktitel oder wählt den hervorgehobenen Menüpunkt
	schneller Vor- oder Rücklauf des Titels
	springt zum vorherigen Titel
	wiederholt den Titel / wiederholt alle Titel / Zufallsauswahl
	springt zum nächsten Titel

Videos und Fotos werden nur dann auf dem TV-Bildschirm dargestellt, wenn die "PLAY"-Taste des iPod gedrückt ist und der iPod diese Funktion unterstützt. Die iPod TV-Einstellungen müssen auf "On" geschaltet sein sowohl im Diavorschau-Menü als auch im Menü für die Video-Einstellungen.

Die iPod Verbindung wird unterbrochen, wenn ein MP3 Player über ein Audio-Kabel (nicht im Lieferumfang enthalten) mit dem KEFDock verbunden wird. Um zur iPod-Wiedergabe zurückzukehren, entfernen Sie bitte das Audio-Kabel vom KEFDock. Wenn Sie die "PLAY"-Taste betätigen, wird die DVD, CD oder das Multi Media Speichermedium, das sich im KIT100 und KIT200 befindet, gestartet und wiedergegeben. Um zum KEFDock zurückzukehren, betätigen Sie bitte die "VCR"-Taste.











(I) Navigazione

	seleziona il KEFDock e attiva il menù sul TV / e sull'iPOD
MUTE	attiva e disattiva il Muting del volume
	accende e spegne il sistema
	interrompe il suono della traccia in ascolto
	riproduce o mette in pausa la traccia selezionata
VOL 	aumenta o diminuisce il volume
MENU	mostra il menù precedente
	naviga nel menù
	scorre su o giù nel menù
SELECT	riproduce la traccia dell'iPod o seleziona la voce di menù
	avanti veloce o indietro veloce
	salta alla traccia precedente
	ripete la traccia / ripete tutto / casuale
	salta alla prossima traccia

Video e foto sono visibili sul TV solo se il tasto PLAY è premuto e se l'iPod supporta questa funzione.

Se si connette un lettore MP3 con un cavo audio (non compreso nella confezione) alla presa del KEFDock, la connessione dell'iPod verrà disattivata. Per attivarla nuovamente togliere il cavo audio dalla presa del KEFDock.











(ES) Navegación

	seleccionar el KEFDock y mostrar el menú en la pantalla de TV / mostrar los menús en la pantalla de iPod
MUTE	enmudece y activa el volumen
	enciende y apaga el sistema
	detiene la reproducción de la pista actual
	reproduce o pausa la pista seleccionada
VOL 	aumenta o reduce el volumen del sistema
MENU	ir al menú previo
	desplazarse por el menú
	avanza o retrocede por páginas de la pantalla del menú
SELECT	reproducir la canción de la iPod o seleccionar el elemento resaltado del menú
	rebobina o avanza rápido dentro de una pista
	saltar a la pista anterior
	repetir pista / repetir todas / mezcla
	saltar a la pista siguiente

Sólo se muestran los vídeos y fotos en la pantalla de TV si se pulsa PLAY (REPRODUCIR) en la iPod, y ésta admite estas funciones. Así mismo la configuración de salida de TV en la iPod debe estar activada en los dos menús Presentación de Diapositivas y Vídeo.

Al conectar al KEFDock un reproductor MP3 a través de un cable de audio (No incluido), se desconectará la conexión iPod. Para volver a reproducir desde la iPod, desenchufe el cable de audio del KEFDock. Al pulsar el botón PLAY (REPRODUCIR) comenzará la reproducción de DVD, CD o disco multimedia en el KIT100 y KI200. Para volver al KEFDock, pulse el botón VCR.











(P) Navegação

	selecione a KEFDock e veja o menu no ecrã do TV / indica os menus no mostrador do iPod
MUTE	corta e activa o volume
	liga e desliga o sistema
	pára a reprodução da pista actual
	reproduz ou interrompe a pista seleccionada
VOL 	aumenta ou diminui o volume do sistema
MENU	vá para o menu anterior
	menu de navegação
	salta para página do menu anterior ou seguinte
SELECT	reproduza a pista de música do iPod ou selecione o item de menu marcado
	retrocede ou avança rapidamente através duma pista
	salte para a pista anterior
	repetição da pista / repetição total / mistura
	salte para a pista seguinte

Os vídeos e Fotos só serão apresentados no ecrã do TV se o botão PLAY for pressionado no iPod e se o iPod suportar estas características. Também os ajuste de saída do TV para iPod deverão estar em ON em ambos os menus de ajuste de Slideshow e Vídeo.

Ao ligar um leitor MP3 à KEFDock através de um cabo de áudio (não incluído), irá desligar a ligação iPod. Para voltar à reprodução iPod, desligue o cabo de áudio da KEFDock.











(NL) Navigatie

	selecteert het KEFDock en doet het menu op het scherm verschijnen / doet de menu's op het iPod scherm verschijnen
MUTE	legt het volume het zwijgen op, of laat het weer terugkomen
	schakelt het systeem in of uit
	stopt weergave van het huidige nummer
	afspelen of pauzeren van het huidige nummer
VOL 	verhoogt of verlaagt het volume
MENU	ga naar voorgaande menu
	navigeer binnen het menu
	springt naar de volgende of de vorige menu pagina
SELECT	speel dit iPod nummer af of selecteer de aangegeven menuregel
	'spoelt' versneld vooruit of achteruit door een nummer
	Ga terug naar het vorige nummer
	herhaal nummer / herhaal alles / schuifel door elk nummer heen
	Spring naar het volgende nummer

Video's en foto's verschijnen alleen op het beeldscherm wanneer de PLAY toets op de iPod wordt ingedrukt, en alleen indien de iPod deze functies ondersteunt. Ook moeten de iPod TV OUT instellingen op stand ON worden gezet, voor zowel het Slideshow als het Video Settings menu.

Bij aansluiting van een MP3-speler via een (niet meegeleverde) audio kabel wordt de iPod verbinding verbroken. Verwijder de audio kabel uit het KEFDock om terug te keren naar iPod weergave.











(RU) Навигация

	выбор KEFDock как источника и отображение меню вашего iPod на экране ТВ / отображение меню на экране вашего iPod
MUTE	режим полного отключения и включения звука
	включение и выключение системы
	остановка проигрывания трека
	проигрывание или пауза выбранного трека
VOL 	увеличение и снижение уровня громкости
MENU	вернуться в предыдущее меню
	перемещение в меню вверх/вниз
	переход по страницам меню
SELECT	воспроизведение музыкального трека или выбор другой отображаемой функции в меню
	убрать трас перемотка или быстрое проигрывание трека
	перейти к предыдущему треку
	повтор трека/повтор всех треков/случайный выбор трека
	перейти к следующему треку

Видео материал и фотографии отображаются на экране телевизора если на iPod нажата клавиша PLAY и ваш iPod поддерживает эти функции

При подключении MP3 плеера аудиокабелем (не входит в комплект) связь с iPod прерывается, при отключении аудиокабеля связь с iPod восстановится

(J) ナビゲーション（操作方法）

	KEFドックを選択し、テレビの画面にメニューを表示する。 iPod画面にメニューを表示する。
MUTE	消音（ミュート）または解除する。
	システムをオンまたはオフする。
	ストップする。
	プレイまたはポーズする。
VOL 	音量を上げ下げする。
MENU	前メニューに戻る。
	検索メニュー。
	メニュースクリーンのページをアップダウンする。
SELECT	iPod音楽の曲を再生するか、ハイライトメニューの項目を選択する。
	早戻しまたは早送りする。
	前の曲に変わる。
	1曲を繰り返す。 / すべての曲を繰り返す。 / 順不同で曲を選ぶ。
	次の曲に変わる。

iPodの「再生」ボタンを押して、iPodが「ビデオ」と「写真」を機能させたら、これらはテレビ画面だけに表示される。
また、iPodテレビの外側の設定では、スライドショーとビデオ設定メニューの両方共、「オン」にセットしなければならない。

MP3プレーヤー（本製品には含まれていない）を、オーディオケーブル線を使ってKEFドックに接続すると、iPod接続が失われる。
iPodプレーバックを接続しなおすには、KEFドックからオーディオケーブル線を外す。

Free Manuals Download Website

<http://myh66.com>

<http://usermanuals.us>

<http://www.somanuals.com>

<http://www.4manuals.cc>

<http://www.manual-lib.com>

<http://www.404manual.com>

<http://www.luxmanual.com>

<http://aubethermostatmanual.com>

Golf course search by state

<http://golfingnear.com>

Email search by domain

<http://emailbydomain.com>

Auto manuals search

<http://auto.somanuals.com>

TV manuals search

<http://tv.somanuals.com>