

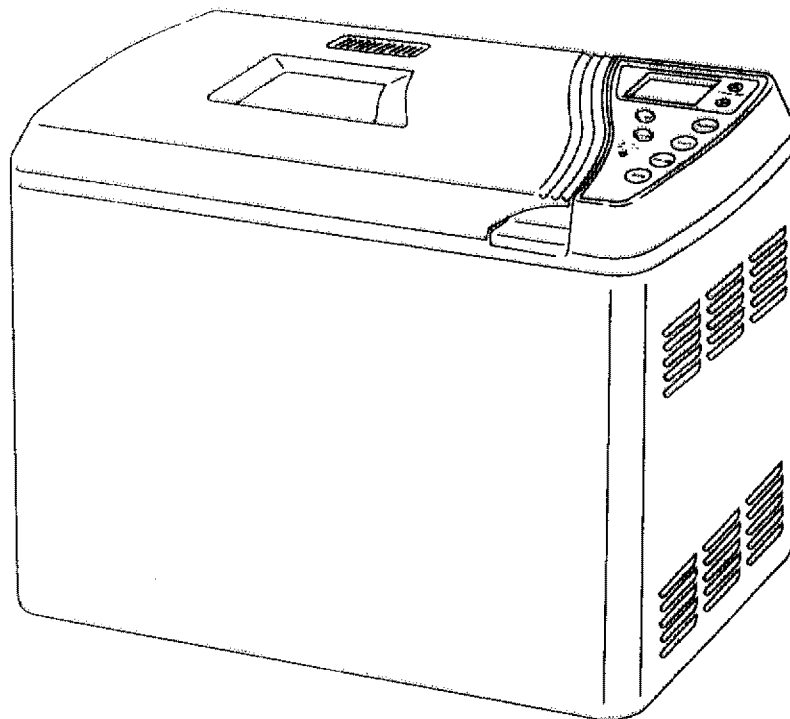

AUTOMATIC BREADMAKER

Model 48487



CAUTION:

Before using this Breadmaker, read this manual and follow all its Safety Rules and Operating Instructions.

- Safety
- Operation
- Cleaning
- Recipes

DPP60671

OWNER'S MANUAL (TR2206)

011/030/DPP60671

Sears, Roebuck and Co., Hoffman Estates, IL 60179 USA

TABLE OF CONTENTS

WARRANTY	2
IMPORTANT SAFETY INSTRUCTIONS	2
YOUR KENMORE AUTOMATIC BREADMAKER.....	3-4
OVERVIEW	5
OPERATING INSTRUCTIONS	6-12
Bread Pan Instructions	6
Operating Tips.....	6
Making Dough and Baking Bread	7-8
Super Rapid Breads	9-11
Using the Timer	12-13
Using the Pause Feature	13
Add-In Beeper	14
Convection Cool Down	14
Jam Cycle	14
For Best Baking Results	15
MAINTENANCE, CLEANING, AND STORAGE.....	16
STANDARD BREAD RECIPES	17
CAKE RECIPES	18-19
JAM RECIPES	20
KNEADING AND BAKING CYCLE CHARTS	21-23
Basic Bread Cycle Chart	21
Whole Wheat Bread Cycle Chart	21
French Bread Cycle Chart.....	22
Fruit & Nut Bread Cycle Chart.....	22
Cake, Jam, Pizza Dough and Dough Cycle Chart	23
TROUBLESHOOTING	24-25

SEARS WARRANTY

FULL ONE YEAR WARRANTY

If this product fails due to a defect in material or workmanship within one year from the date of purchase, Sears will replace it free of charge.

To obtain replacement under this warranty, return this product to place of purchase.

This warranty gives you specific legal rights, and you may also have other rights which vary from state to state.

Sears, Roebuck and Co., Dept. 817WA, Hoffman Estates, IL 60179

IMPORTANT SAFETY INSTRUCTIONS

When using electrical appliances, especially when children are present, basic safety precautions should always be followed, including the following:

READ ALL INSTRUCTIONS BEFORE USING.

1. Do not touch hot surfaces. Use handles or knobs. Always use oven mitts when handling hot materials and allow metal parts to cool before cleaning.
2. Unplug this product from wall outlet when not in use and before cleaning. Allow to cool thoroughly before putting on or taking off parts.
3. Do not immerse appliance in water or any other liquid.
4. Close supervision is necessary when any appliance is used by or near children.
5. Do not allow anything to rest on the power cord. Do not plug in cord where persons may walk or trip on it.
6. Do not operate this or any appliance with a frayed or damaged cord or plug or after the appliance malfunctions or has been dropped or damaged in any manner. Return appliance to the nearest authorized service facility for examination, repair, or adjustment.
7. Avoid contact with any moving parts.
8. The use of accessory attachments not recommended by the manufacturer may result in fire, electric shock, or injury to persons.
9. This appliance is intended for household use only. Do not use outdoors or for commercial purposes.
10. Do not let the cord hang over the edge of a table or counter, or touch hot surfaces. Do not place on an unsteady or cloth-covered surface.
11. Do not place the appliance near a hot gas or electric burner, or in a heated oven.
12. Do not use the appliance for other than its intended use.
13. Keep the appliance at least 2 inches away from walls or any other objects when in use.
14. To disconnect, grip the plug and pull the plug from the wall outlet. Never pull on the cord.

SAVE THESE INSTRUCTIONS

YOUR KENMORE AUTOMATIC BREADMAKER

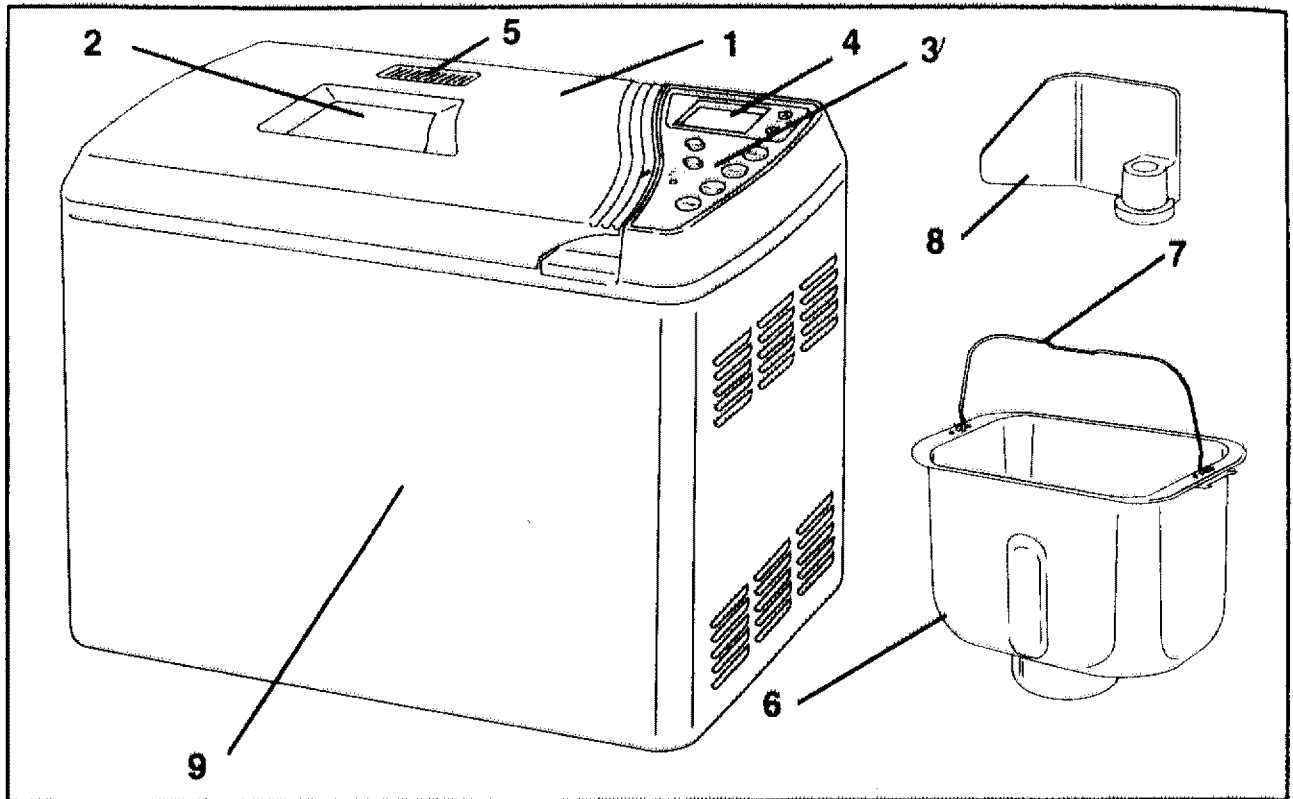

1. Lid
2. Viewing Window
3. Control Panel
4. Display Window
5. Steam Vent
6. Bread Pan
7. Bread Pan Handle
8. Kneading Paddle
9. Oven Case (Baking Chamber)

This appliance is for **HOUSEHOLD USE ONLY** and may be plugged into any 120V AC electrical outlet. Do not use any other type of outlet.

POLARIZED PLUG

This appliance has a polarized plug (one blade is wider than the other). To reduce the risk of electric shock, this plug is intended to fit into a polarized outlet only one way. If the plug does not fit fully into the outlet, reverse the plug. If it still does not fit, contact a qualified electrician. Do not attempt to modify the plug in any way.

SHORT POWER CORD

The Breadmaker's power cord is short to reduce your risk of becoming entangled in or tripping over a long cord. You can obtain a longer, detachable power-supply cord or extension cord, but be careful when using breadmaker equipped with extra cord length.

If you are using a longer detachable power-supply cord or extension cord, (1) the marked electrical rating of the extension cord should be at least as great as the electrical rating of the appliance, and (2) arrange the longer cord so that it will not drape over the counter top or table top where it can be pulled on by children or tripped over unintentionally.

IMPORTANT NOTICE

If any parts are missing or defective, **DO NOT** return this product. please call our Customer Service Department for assistance.

1-800-233-9054

Monday - Friday
9 a.m. - 5 p.m. CST

THE CONTROL PANEL

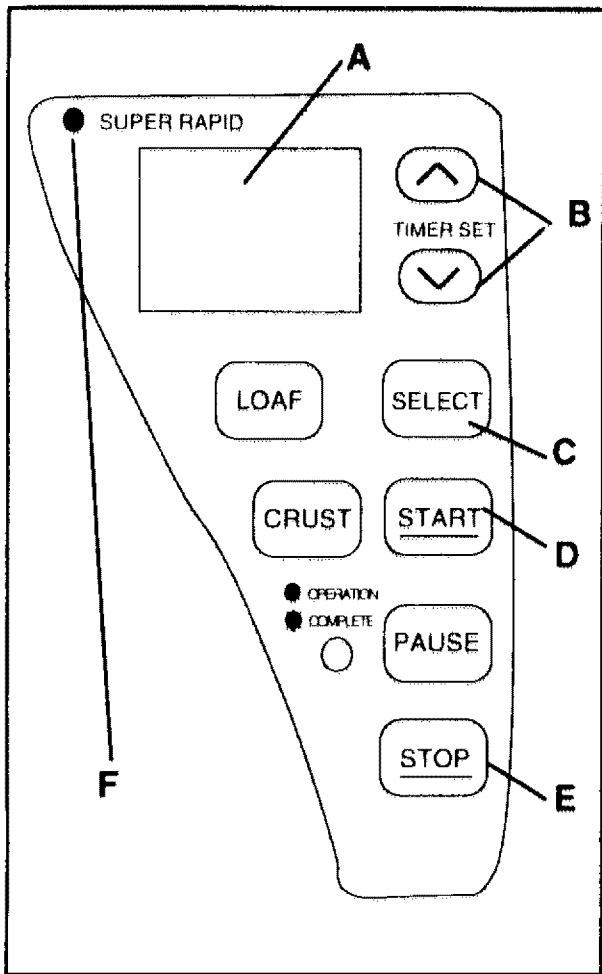

A. Display Window

Shows your selection and timer setting.

B. Timer

Use these buttons to change time shown in Display Window.

▲ Each time you press the ▲ button, the timer advances 10 minutes. Hold the ▲ button down for fast forward.

▼ Each time you press the ▼ button, the timer is set back 10 minutes. Hold the ▼ button down for fast reverse.

C. Select

Press this button to select the desired Baking cycle. Each time you press this button, the indicator arrow moves to the next selection. Press this button until your choice is indicated.

D. Start

Press this button to start the Baking cycle and the Timer. The **PAUSE** function can be activated only after the machine has started a program. For complete details, see "USING THE PAUSE FEATURE."

E. Stop

Press this button for a full second to stop Baking cycle, Timer setting, or program.

F. Super Rapid

The Super Rapid program is convenient for baking a hot fresh loaf of bread in under an hour.

Cycle Selection Options—select from the following bread choices:

Type	Crust	Loaf Size
Basic Bread	Light, Medium, or Dark	1.5 lb. or 2.0 lb.
Basic Bread <i>Rapid</i>	Light, Medium, or Dark	1.5 lb. or 2.0 lb.
Whole Wheat Bread	Light, Medium, or Dark	1.5 lb. or 2.0 lb.
Whole Wheat Bread <i>Rapid</i>	Light, Medium, or Dark	1.5 lb. or 2.0 lb.
French Bread	Light, Medium, or Dark	1.5 lb. or 2.0 lb.
French Bread <i>Rapid</i>	Light, Medium, or Dark	1.5 lb. or 2.0 lb.
Fruit & Nut Bread	Light, Medium, or Dark	1.5 lb. or 2.0 lb.
Fruit & Nut Bread <i>Rapid</i>	Light, Medium, or Dark	1.5 lb. or 2.0 lb.
Super Rapid Breads	Not Applicable	1, 1.5 or 2.0 lb.
Batter Bread™/Cake	Not Applicable	Not Applicable
Jam	Not Applicable	Not Applicable
Dough	Not Applicable	Not Applicable
Pizza Dough	Not Applicable	Not Applicable
Bake Only	Not Applicable	Not Applicable

OVERVIEW

With your new Kenmore Automatic Breadmaker, you can do the following:

- Create many types of breads—program by loaf size and crust color.
- Use pre-package bread mixes. Follow instructions for use on each package.
- Bake a loaf of bread from scratch. See *Recipe and Menu Planner* included with your Breadmaker for many tasty options.
- Make dough for rolls or loaves you'll bake in your regular oven. Use the Dough cycle to do the mixing and kneading for you. Then, shape and bake the bread yourself.
- Activate **PAUSE** and remove dough for shaping, filling, braiding, and more.
- Activate **PAUSE** and score the top of your loaf for a rustic-style bread or make a decorative crust with rolled oats, poppy seeds, etc.
- Make non-yeast Batter Breads™, cakes, jam, and pizza dough.
- Maintain currently activated program during power failures. A power failure back-up stores the active program for up to 30 minutes. If power is reconnected within 30 minutes, the machine returns to baking your bread at the point where it left off.

IMPORTANT: If a power failure lasts longer than 30 minutes, and you are using any dairy products, perishables, or meats in your bread, discard the contents of the recipe and start again with fresh ingredients. This is for health, sanitary and other considerations.

NOTE: Power failure back-up does not apply to power surges. If your home experiences frequent power surges, we recommend always using a surge protection device.

CAUTION:

- During use, the internal parts of the Breadmaker and the area around the Steam Vent are **HOT**.
- To protect young children, keep your Kenmore Breadmaker out of their reach when the machine is not being closely supervised—especially during the Kneading and Baking cycles.
- Use the Breadmaker on a flat, hard, stable surface. **DO NOT** place it near a flame or heat, or on a soft surface (such as a towel, tablecloth, or carpeting).
- To avoid burns, stay clear of and do not cover the Steam Vent during Kneading and Baking cycles. Also, **DO NOT** touch Viewing Window as it gets very hot.
- Unplug Breadmaker when not in use or before cleaning. After baking, wait for the machine to cool completely before touching or cleaning Bread Pan or Oven Case without oven mitts.
- Never use metal utensils or scouring pads with this Breadmaker. These can scratch the Bread Pan's non-stick surface.
- Never use the Bread Pan on a gas or electric cooktop or on an open flame.
- Always remove the Kneading Paddle from the bread prior to slicing.

OPERATING INSTRUCTIONS

BREAD PAN INSTRUCTIONS

- To insert Bread Pan into Breadmaker, seat it into Oven Case and press down until it snaps into place. Remember to insert Kneading Paddle first, then add all ingredients **BEFORE** inserting Bread Pan into Oven case.
- To remove Bread Pan from Oven Case, use an oven mitt to hold Handle and lift gently. When you remove Bread Pan after baking, **BE SURE TO WEAR OVEN MITTS** to prevent burning. After you remove the loaf by turning the Bread Pan upside down and gently shaking it, check to see that the Kneading Paddle is removed from the loaf. If it is stuck in the bread, use a non-metal utensil to gently remove it.

CAUTION: The Kneading Paddle may be very hot. Never remove it from hot bread with bare hands.

Take care not to scratch the Kneading Paddle.

1, 2, 3! 1, 2, 3!

We'll say this again, because it's so important. Always put your ingredients into the Bread Pan in this order:

1. **Wet -- water, milk, oils, fats**
2. **Dry -- salt, powdered milk, grains, sugar, flour**
3. **Yeast -- Do not use yeast past expiration date.**

OPERATING TIPS

- Use oven mitts when working with hot bread or any part of the Breadmaker during or just after Baking cycle.
- It is normal for the Viewing Window to experience condensation during the latter part of the rising cycle, prior to the activation of baking. As the bread bakes, the moisture will evaporate.
- Don't open Lid excessively during baking. This causes bread to bake improperly.
- Do not unplug Breadmaker during Kneading or Baking cycles. This will stop the operation.
- Whole Wheat cycles have a rest period for up to 30 minutes before kneading begins. **No movement occurs in the Bread Pan.** This is normal.
- After baking, a controlled Keep Warm phase will begin for each selection (except Dough and Jam). This will help to reduce condensation between loaf and Bread Pan. **However, it is best to remove bread as soon as possible after completing Baking cycle.**
- If a dough cycle was chosen, remove ball of dough as soon as the breadmaker has completed the dough cycle. Turn dough out of the pan onto a clean, floured surface. Shape, bake, or store the dough as you planned.

MAKING DOUGH AND BAKING BREAD

Step 1. Remove Bread Pan

Open Lid and remove Bread Pan.
Using the Bread Pan Handle, lift Bread Pan straight out of the machine.

Step 2. Position Kneading Paddle

Position Kneading Paddle on Drive Shaft. Match the flat side of the Drive Shaft to the flat part of the hole in the Kneading Paddle. Be sure the paddle is in place, although the fit may seem slightly loose.

Step 3. Place ingredients into Bread Pan

Place ingredients into Bread Pan. For best results, add all liquid ingredients first; then, beginning with salt, add all dry ingredients **EXCEPT yeast**.

Step 4. Add yeast

Yeast can be the "make or break" ingredient in your recipe. Follow these simple steps and you shouldn't have any yeast problems in baking.

Yeast is always the last ingredient to go in the Bread Pan. Make a shallow well in the direct center of the dry mixture sitting in the pan; no deeper than the first joint of your index finger.

Double check that the yeast is not past the date code on its envelope or label. Add the called-for measure of yeast directly into the shallow well you made in the Bread Pan.

Always be sure to keep yeast from water/liquids and salt. Premature mixing with either of these two ingredients will have a dramatic effect on the yeast. Keep yeast away from liquids (or it will start to activate immediately) and salt (or it may not activate at all). For more details, see "Troubleshooting" at the end of this manual.

Always follow proper ingredient order—especially on delay bake preparations.

Step 5. Insert Bread Pan into Oven Case

Place Bread Pan into Oven Case. (See "INSERTING AND REMOVING BREAD PAN.") Close lid and plug Breadmaker into a 120V wall outlet. Once plugged in, the Breadmaker display window **automatically** opens to Basic White Bread, 2 lb., Medium Crust.

Step 6. Select Bread Cycle SELECT

Press the SELECT button to choose the bread cycle you would like. Beginning with Basic (white), the selector will move through the types of bread settings in the following order:

Basic (white)
Whole Wheat
Fruit and Nut (sweet)
French*
Cake/Batter Bread
Jam
Pizza Dough
Bread Dough
Bake Only

*The French cycle is for breads with crisper crusts, especially those that are lowest in sweeteners, such as French and Italian breads.

Step 7. Select Loaf Size LOAF

Press the LOAF button to choose the size loaf you want to bake. You may either choose a 2 lb. or 1.5 lb. bread. This cycle can be prompted for 48 settings.

NOTE: LOAF control cannot be activated for: Batter Bread, Cake, Jam, Dough, Pizza Dough, or Bake Only.

Step 8. Select Crust Color CRUST

Press the CRUST button to choose light, medium, or dark crust. You may choose crust types on Basic White, Whole Wheat, Fruit and Nut, and French breads only.

MAKING DOUGH AND BAKING BREAD (contd.)

Step 9. Start Cycle

Press START to activate the Breadmaker. The breadmaker has already calculated your various settings and selections, and your recipe is now on its way to being prepared.

START

First, the machine mixes the ingredients. Then, it begins the Kneading process. During this process, the yeast begins to activate. The Viewing Window may begin to "fog" with condensation. This is a normal part of the process. The condensation will gradually disappear during baking.

Whole Wheat cycles have a "rest" period for up to 30 minutes before kneading begins. **No movement occurs in the pan.** This is normal.

For special cycles, such as Jam, the Breadmaker follows the processes outlined in the cycle charts at the end of this manual.

Step 10. Stop Cycle/ Remove Bread Pan

STOP

When the bread is done, the machine will beep. Press and hold the STOP button. Put on protective oven mitts and remove Bread Pan.

Remember that the Bread Pan and the bread loaf are both very hot after the Baking Cycle! **DO NOT** place either on a tablecloth, plastic surface, or other surface which might scorch or melt.

If STOP is not pressed, a Keep Warm Cycle begins. This will help keep the bread from becoming soggy. **For best results**, remove bread immediately after Baking cycle is complete.

The Keep Warm Cycle does not apply to Dough, Batter Breads/ Cakes and Jam cycles.

Step 11. Remove Bread from Bread Pan

Remove loaf of bread from Bread Pan as soon as the Breadmaker has completed the baking cycle.

Hold Bread Pan upside down a few inches from countertop and gently shake out the loaf of bread.

Place loaf of bread on a wire rack or other ventilated cooling surface to cool. Allow bread to cool 15-30 minutes before slicing.

Step 12. Remove Kneading Paddle

Be sure to remove Kneading Paddle before slicing.

CAUTION: The Kneading Paddle may be very hot. Never remove it from hot bread with bare hands.

The Kneading Paddle may stick in the loaf of bread. If it does, use a non-metal utensil to gently remove it from the bread, taking care not to scratch the paddle. Use a knife with a serrated edge for best slicing.

Step 13. Unplug Breadmaker

Always unplug your Automatic Breadmaker immediately after use.

The Super Rapid program, with hotter rise and bake temperatures, is convenient for baking a hot fresh loaf of bread in under an hour. The longer bread programs, with lower rise and bake temperatures, will bake a taller more developed loaf of bread.

Step 1

Add ingredients to the bread pan in the order listed. Refer to "For Best Baking Results" for measuring information. Place the bread pan in the bread maker.

Step 2

Close the lid. Select the Super Rapid program, and press **START**.



Step 3

When finished baking, remove bread pan from the bread maker. Invert and shake to remove the loaf. Allow loaf to cool standing upright on a wire rack before slicing.

SUPER RAPID PROGRAM HINTS

- Water temperatures must be 110°-115°F/43°-46°C.
- Larger amounts of Quick-Rise™, RapidRise™, Bread Machine or Instant Active Dry yeast must be used. They may be substituted in equal amounts.
- The dough ball for the Super Rapid program should be a very soft, sticky to the touch, loose ball with a smooth texture. Do not add extra flour.
- Check the dough at the beep, and if necessary, use a rubber spatula to push any flour or dough from the sides of the bread pan down into the dough ball.
- As a result of the increased temperatures during the rise and bake process, the loaf of bread produced from this program may have a dark crisp crust with a split on the top side of the loaf.

SUPER RAPID BREAD RECIPES

We suggest starting your Super Rapid bread baking with this White Bread Recipe. Refer to "For Best Baking Results" for measuring information. Follow each step carefully, noticing the water temperatures must be between 110°-115°F/43°-46°C and that Quick-Rise™, RapidRise™, Bread Machine or Instant Active Dry yeast must be used.

WHITE BREAD

1.5 lb. Loaf

1 1/4 cups water
2 1/2 tbsp. oil
1 1/2 tsp. salt
2 tbsp. sugar
1 1/2 tbsp. dry milk powder
3 cups bread flour
5 1/2 tsp. quick-rise yeast
PROGRAM: Super Rapid

2.0 lb. Loaf

1 1/2 cups + 3 tbsp. water
1/4 cup oil
2 tsp. salt
3 tbsp. sugar
2 tbsp. dry milk powder
4 cups bread flour
6 3/4 tsp. quick-rise yeast
PROGRAM: Super Rapid

Method:

1. Remove the bread pan from the bread maker. Attach the kneading blade onto the shaft. Have all ingredients ready. Make sure all ingredients, except water, are at room temperature.
2. Use a liquid measuring cup to measure the water (110°-115°F/43°-46°C) and pour into the bread pan.
3. Use a measuring spoon to measure the oil and add to the bread pan.
4. Use a measuring spoon to measure the sugar, salt and dry milk; level off with the straight edge of a knife and add to the bread pan.

SUPER RAPID BREAD RECIPES (contd.)

5. Lightly spoon bread flour into a dry measuring cup; level off with the straight edge of a knife and add to the bread pan.
6. Carefully measure Quick-Rise yeast with a measuring spoon; level off with the straight edge of a knife and add to the bread pan.
7. Place the bread pan into the bread maker. Push down on rim until it snaps into place. Close the lid.
8. Select Super Rapid program and press START.
9. At the beep during the kneading process (:53), check the dough ball. It should be sticky to the touch. At this time, push down any dough or flour that may be on the sides of the pan.
10. When the beeper sounds the bread has finished baking.
11. Use oven mitts to carefully remove the bread pan.

START

CAUTION: THE OVEN CAVITY, BREAD PAN, KNEADING BLADE AND BREAD WILL BE VERY HOT. USE OVEN MITTS.

12. Turn bread pan upside down and shake several times to release the bread. Do not use metal utensils inside the bread pan or bread maker. Remove the kneading blade and allow loaf to cool standing upright on wire rack approximately 20 minutes before cutting.
13. When the bread has completely cooled, approximately 1 hour, store in an air tight container.
14. UNPLUG UNIT BEFORE CLEANING. DO NOT IMMERSE THE BREAD PAN IN WATER. SEE "MAINTENANCE, CLEANING AND STORAGE."

WHITE WHEAT BREAD

1 lb. Loaf

3/4 cups + 3 tbsp. water
1 tbsp. oil
1 tsp. salt
3 tbsp. sugar
1 tbsp. dry milk powder
1 3/4 cups bread flour
1/2 cup whole wheat flour
4 1/2 tsp. quick-rise yeast
PROGRAM: Super Rapid

2.0 lb. Loaf

1 1/2 cups + 3 tbsp. water
3 tbsp. oil
2 tsp. salt
1/4 cup sugar
2 tbsp. dry milk powder
3 1/2 cups bread flour
1/2 cup whole wheat flour
6 tsp. quick-rise yeast
PROGRAM: Super Rapid

FRENCH BREAD

1 lb. Loaf

3/4 cups + 3 tbsp. water
1 tbsp. oil
3/4 tsp. salt
2 1/2 tsp. sugar
2 1/4 cups bread flour
3 1/2 tsp. quick-rise yeast
PROGRAM: Super Rapid

2.0 lb. Loaf

1 1/2 cups + 2 tbsp. water
3 tbsp. oil
1 1/2 tsp. salt
1 1/2 tbsp. sugar
4 1/3 cups bread flour
6 tsp. quick-rise yeast
PROGRAM: Super Rapid

SUPER RAPID BREAD RECIPES (contd.)

ITALIAN BREAD

1 lb. Loaf

1 cup + 1 tbsp. water
4 tsp. oil
1 tsp. salt
2 tbsp. sugar
1 tbsp. dry milk powder
1 1/2 tsp. dried Italian seasoning
2 1/4 cups bread flour
4 1/2 tsp. quick-rise yeast
PROGRAM: Super Rapid

2.0 lb. Loaf

1 1/2 cups + 1 tbsp. water
2 tbsp. oil
2 tsp. salt
1/4 cup sugar
2 tbsp. dry milk powder
1 tbsp. dried Italian seasoning
4 cups bread flour
6 3/4 tsp. quick-rise yeast
PROGRAM: Super Rapid

HONEY GRANOLA BREAD

2.0 lb. Loaf

1 1/2 cups + 1 tbsp. water
6 tbsp. oil
2 1/2 tbsp. honey
2 tsp. salt
3 tbsp. dry milk powder
4 1/4 cups bread flour
1 cup granola cereal
6 3/4 tsp. quick-rise yeast
PROGRAM: Super Rapid

CINNAMON RAISIN BREAD

1 lb. Loaf

1 cup + 1 tbsp. water
1 tbsp. oil
2 1/2 tbsp. brown sugar
1 tsp. salt
1 tbsp. dry milk powder
2 1/4 cups bread flour
3/4 tsp. cinnamon
1/3 cup walnuts
1/3 cup raisins
4 1/2 tsp. quick-rise yeast
PROGRAM: Super Rapid

2.0 lb. Loaf

1 1/4 cups + 1 tbsp. water
7 tsp. oil
3 1/2 tbsp. brown sugar
1 1/2 tsp. salt
1 1/2 tbsp. dry milk powder
3 1/2 cups bread flour
1 tsp. cinnamon
1/2 cup walnuts
1/2 cup raisins
6 3/4 tsp. quick-rise yeast
PROGRAM: Super Rapid

USING THE TIMER

DELAYED BAKING

You can program the Breadmaker to delay preparing and baking the loaf for up to 13 hours from the time you press the START button.

Set the timer for the number of hours there will be between the time you set it and the time you want the bread to finish baking.

For example:

It's 8:15 a.m. and you want the bread to be finished at 7:00 p.m. the same day. The time difference from 8:15 a.m. to 7:00 p.m. is **10 hours, 45 minutes.**

Set the timer for **10 hours, 45 minutes.**

It's 9:00 p.m. and you want breakfast bread ready at 6:30 a.m. the next morning. The number of hours + minutes from 9:00 p.m. to 6:30 a.m. is **9 hours, 30 minutes.**

Set the timer for **9 hours, 30 minutes.**

CAUTION: DO NOT use delayed baking for recipes containing perishable ingredients such as Dairy Products (eggs, milk, cheese, yogurt), Meats (cooked or uncooked), Fish, or Poultry. These ingredients may begin to spoil before baking begins and create a health hazard if eaten.

- 1, 2, 3! 1, 2, 3!

Remember to always put your ingredients into the Bread Pan in the following order:

1. **Wet -- water, milk, oils, fats**
2. **Dry -- salt, powdered milk, grains, sugar, flour**
3. **Yeast -- Do not use yeast past expiration date.**

Keep yeast away from liquids (or it will start to activate immediately) and salt (or it may not activate at all).

To Program Delayed Baking

Step 1.

Add ingredients, as usual, taking care not to let the yeast and liquid ingredients mix.

Step 2.

Close Breadmaker lid and plug it into a 120V electrical outlet.







Step 3.

Select the desired cycle, loaf size, and crust color.



Step 4.

Press the  Timer button once for each 10 minutes you wish to delay the finish time. Press the  button to subtract time if you enter too much. The time amount shows in the Display Window. Press and hold either  or  to fast forward or fast reverse time.

TIMER SET



NOTE: Actual baking times will not change.

Step 5.

Press START to begin Timer countdown. The colon (:) in the time shown in the Display Window will begin to flash. This lets you know that the Timer has started. When the Display Window shows 0:00, baking is complete.



NOTE: Always set timer for the shortest time possible. Because ingredients are partially combined in the Bread Pan, the dough may tend to deteriorate if left unbaked for too many hours, especially on a warm or humid day.

BAKE ONLY

You can set the Timer to bake breads from store-bought frozen dough or dough you have made and saved. You can also warm up a previously made loaf.

USING THE TIMER (contd.)



To Program Bake Only

Step 1.

Select the Bake Only cycle.

SELECT

Step 2.

Use the **Up**  and **Down**  arrows to set the baking time you want within a time range from 15 minutes to 1 hour, 50 minutes.



TIMER SET



Step 3.

Press **START**. The breadmaker will "beep" when baking is completed. Then, follow the instructions in steps 10 and 11 from the "MAKING DOUGH AND BAKING BREAD" section.

START

Helpful Hints:

- When you select the Bake Only or Batter Breads/Cake cycle, you cannot program the Breadmaker for delayed baking.
- If you make an error after you have begun the Timer program and you wish to start over, press and hold the **STOP** button. The Timer will clear and you may begin again.
- The Kneading Paddle isn't placed into the Bread Pan for the Bake Only cycle.

STOP

USING THE PAUSE FEATURE

Your Kenmore Automatic Breadmaker has a traditional, horizontal loaf pan. This feature, in combination with the **PAUSE** button, allows you to be very creative with bread machine baking.

When you press and hold **PAUSE** for 2 full seconds, the bread machine will stay "on hold" for up to 10 minutes. You can press **PAUSE** at any time, during any cycle.

To activate pause mode, press and hold **PAUSE** button for 2 seconds. You will hear a beep when pause begins.

PAUSE

To resume the cycle, press **START** and the machine will begin again at the point where it left off. If you forget to press **START**, the machine will automatically re-activate after the 10 minutes have elapsed.

START

Using **PAUSE** will let you do some of the following:

- Decorative crusts
- Braided breads
- Pull-apart rolls
- Monkey breads
- Add crumble toppings to coffee cakes
- Create rustic-style, Mediterranean-style rolled bread.
- Score crust

Here's a quick example of a rolled, Mediterranean-style bread using a French bread recipe:

- Activate **PAUSE** at the end of Knead 3 (see "Kneading and Baking Cycle Charts" for time details.)
- Remove dough. Roll it out on a clean, lightly floured surface. You'll want to roll the dough into an 8-1/2" x 13" rectangle.
- Lightly brush with a good olive oil, such as *Tassos*. Then, sprinkle with fresh chopped garlic, basil, rosemary, and sun-dried tomatoes. Top with 1/3 cup of crumbled feta or goat cheese. If you would like, you could even add 2-3 slices of prosciutto.
- Roll the dough up tightly into an 8-1/2" wide roll. Tuck ends under and place into the Bread Pan. Return Bread Pan to the Breadmaker, close the lid and touch **START**.
- The final rise will begin, immediately followed by **BAKE**.
- As the baking begins, you could **PAUSE** again. You can score the top crust, gently mist the loaf with cold water, return the Bread Pan to the Oven Case, close the lid and touch **START**. Your rustic, Mediterranean bread will soon finish baking.

PAUSE

START

PAUSE

START

ADD-IN BEEPER

Your Kenmore Breadmaker comes with a terrific feature called the "Add-In Beeper."

The "Add-In Beeper" should be used when you want to add nuts, fruits, herbs, chopped veggies, oats, etc. to the dough.

The beeper will sound several minutes **prior** to the end of Knead 2, approximately 23 minutes from the activation of the initial kneading.

Why is this beeper necessary? You'll find that, if you add raisins, rolled oats, seeds, or herbs into the pan with the initial ingredients, several factors may effect your final loaf.

First, dehydrated foods will rehydrate quickly and break down into small flecks. So, if you want plump raisins in your raisin bread, add them after the beeper signal.

Secondly, certain add-ins such as sun-dried tomatoes will color the bread to a red or dark pink, as well as break down. Again, if you'd like chunks of sun-drieds in the bread, add them when the beeper reminds you to.

CONVECTION COOL-DOWN

Your Kenmore breadmaker has a very important feature; true convection cool down. Towards the end of the baking cycle, a convection fan will activate.

Not only does the fan circulate air within the bread case, helping prevent condensation forming between the crust and baking pan, it also makes for a better crust and even browning.

This function keeps the bread from becoming soggy if not removed immediately.

The Jam cycle makes your favorite jams.

JAM CYCLE

See "RECIPES" at the end of this manual.

For best results:

- DO NOT reduce sugar or use sugar substitutes. The exact amounts of

sugar, fruit, and pectin are necessary for a good set.

- Use only ripe fruit (not overripe or underripe) for best flavor.
- DO NOT puree fruit. Crush with a potato masher or food processor. Jam should have bits of fruit in it.
- Recipes should not exceed 3 1/2 cups.
- Be sure to measure fruit **before** it is crushed, not **after**.
- Remove stems, seeds, or pits from fruit before crushing.

NOTE: You cannot use the Timer for delayed operation in the Jam Cycle.

Step 1.

With Kneading Paddle in position, add crushed fruit to Bread Pan.

Step 2.

Add remaining ingredients.

Step 3.

Insert Bread Pan into Oven Case.
Close lid.

Step 4.

Press SELECT button to choose Jam cycle.



Step 5.

Press START. The machine will pre-heat for 15 minutes before any movement occurs. After pre-heating, the jam will heat and mix for approximately 50 minutes, then cool for an additional 10 minutes. The machine will beep when the cycle is complete.



Step 6.

Press STOP. Use oven mitts to remove Bread Pan.



Step 7.

Pour hot jam into a heat-proof container. Leave 1/2 inch of space at top of container.

Step 8.

Cover tightly to store. Jam will thicken upon cooling and storage.

FOR BEST BAKING RESULTS

- Measure ingredients accurately, using a good set of measuring cups and spoons or a scale. Make sure to level all dry ingredients when measuring. Inaccurate measurements could cause unexpected results.
- Be precise in measuring water.
- Use fresh ingredients.
 - Since moisture is an enemy to flour, be sure to store flour in an airtight container.
 - To keep yeast active, store it in an airtight container in the refrigerator.
 - **DO NOT** use yeast if the date code on the packet has expired.
- We recommend using bread flour for baking with this bread machine. There are white, whole wheat and blended bread flours. If you cannot find bread flour, "all-purpose" flour is an acceptable substitute.
 - If you are baking a whole grain, rye, oat, or pumpernickel bread, and cannot find bread flour or all-purpose flour, you will need to add **gluten** to the recipe. Why? Because heavy, hard flours such as stone ground whole wheat and dark rye need a "boost" of protein to allow them to knead and rise.
 - Gluten is available at most large grocery chains in the baking section. The manufacturers directions for measurements should be followed. If you are using a heavy stone ground whole wheat flour for a 2 lb. recipe (4-4 1/2 cups), you will need to add 1/3 cup of gluten to the dry ingredients.
- **1, 2, 3! 1, 2, 3!**
Remember, always put your ingredients into the Bread Pan in this order:
 1. **Wet -- water, milk, oils-fats**
 2. **Dry -- salt, powdered milk, grains, sugar, flour**
 3. **Yeast -- do not use yeast past expiration date.**
- When using Timer, we recommend setting it for as short a time as possible. Because ingredients are partially combined in the Bread Pan, the dough may tend to deteriorate if left too many hours, especially on a warm or humid day.
- Keep Lid closed during Baking cycle. Opening it excessively causes uneven baking.
- After cooling and slicing bread, store it in a plastic bag or plastic wrap to prevent it from drying out.

MAINTENANCE, CLEANING, AND STORAGE

MAINTENANCE

This Automatic Breadmaker requires little maintenance. It contains no user-serviceable parts inside the housing. Contact qualified personnel if the product requires servicing.

CLEANING

CAUTION: To avoid electric shock, unplug Breadmaker before cleaning!

The Bread Pan and Kneading Paddle have non-stick surfaces for easy clean-up.

1. After baking each loaf of bread, unplug Breadmaker and discard any crumbs.
2. Remove Bread Pan from Oven Case. Remove Kneading Paddle from Bread Pan. Wash the Bread pan and Kneading paddle, inside and out, with warm, soapy water and a plain sponge or cloth. Avoid scratching the non-stick surfaces.
DO NOT PUT BREAD PAN OR KNEADING PADDLE IN A DISHWASHER OR SOAK IT IN WATER FOR LONG PERIODS OF TIME.

3. Wipe inside of Lid and oven Case with a damp cloth or sponge. If residue has scorched on heating plate, scrub with a non-abrasive scrubbing pad and wipe clean. **Do not immerse appliance in water or any other liquids.** The Lid can be removed for cleaning. **DO NOT PUT LID IN DISHWASHER.** This will cause the lid to warp.

- DO NOT use vinegar, bleach, or harsh chemicals to clean the Breadmaker.
- DO NOT soak Bread Pan for a long period of time—this could interfere with the Drive Shaft operation.
- Be sure machine is completely cooled before storing.
- The inner casing contains the heating element and drive base. When cleaning, **NEVER pour water, solvents, or cleaning solutions into this area.**

STANDARD BREAD RECIPES

NOTE: For best results, always use Bread Flour or All Purpose Flour for these bread recipes. Do not use self-rising or cake flour.

BASIC WHITE BREAD

1.5 lb. Loaf

1 cup + 2 tbsp. water
2 tbsp. Canola oil
1 1/2 tsp. salt
2 tbsp. sugar
1 1/2 tbsp. dry milk powder
3 1/4 cups white bread flour
1 3/4 tsp. active dry yeast

2.0 lb. Loaf

1 1/4 cups + 2 tbsp. water
2 tbsp. Canola oil
2 tsp. salt
3 tbsp. sugar
2 tbsp. dry milk powder
4 1/2 cups white bread flour
2 tsp. active dry yeast

WHOLE WHEAT BREAD

1.5 lb. Loaf

1 cup + 2 tbsp. water
2 tbsp. oil
1 1/2 tsp. salt
3 tbsp. brown sugar
2 tbsp. dry milk powder
3 1/4 cups whole wheat bread flour*
3 1/2 tsp. active dry yeast

2.0 lb. Loaf

1 1/4 cups water
3 tbsp. oil
2 tsp. salt
4 tbsp. brown sugar
3 tbsp. dry milk powder
4 1/3 cups whole wheat bread flour*
4 1/2 tsp. active dry yeast

* For best results when not using bread flour, we recommend adding Gluten to the recipe. Add 1/3 cup of Gluten to a 2 lb. recipe. If whole wheat flour is stone ground, you may need to add up to 1/2 cup of Gluten.

EASY FRENCH BREAD

1.5 lb. Loaf

1 cup + 2 tbsp. water
1 tbsp. olive oil
1 tsp. salt
1 1/4 tsp. sugar
3 1/4 cups white bread flour
1 1/4 tsp. yeast

2.0 lb. Loaf

1 1/3 cups water
2 tbsp. olive oil
1 1/2 tsp. salt
2 tsp. sugar
4 cups white bread flour
1 1/2 tsp. yeast

More recipes are included in the Recipe Planner.

CAKE RECIPES

PEANUT CAKE

1 1/2 cups all purpose flour	1/2 cup low-fat yogurt
1 tsp. baking powder	1/2 cup crunchy peanut butter, softened
3/4 tsp. baking soda	1/4 cup apple sauce
1/4 tsp. salt	1/4 cup water
1/2 cup white sugar	1 tsp. vanilla extract
2 eggs, large	

Combine first four ingredients and mix well. Set aside. Place eggs, yogurt, peanut butter, apple sauce, water, vanilla extract and sugar in the baking pan in that order. Close the lid and start the cake cycle. When continuous mixing begins, add the flour mixture in a slow, steady stream. Close the lid. Allow the cake to cool uncovered in the refrigerator for 25-30 minutes before attempting to remove it from the pan.

PINEAPPLE-COCONUT CLAFOUTI CAKE

1 1/2 cups all purpose flour	1/2 cup milk, whole
1 tsp. baking powder	1/2 cup canned pineapple chunks, drained
1/2 tsp. baking soda	1/4 cup pineapple juice (from can)
1/2 tsp. salt	1/2 cup sweetened shredded coconut
3/4 cups white sugar	1 tsp. vanilla extract
2 eggs, large	

Combine first four ingredients and mix well. Set aside. Place pineapple, pineapple juice, eggs, milk, coconut, sugar, and vanilla in the baking pan and place it in the machine. Close the lid and start the cake cycle. When continuous mixing begins, add the flour mixture in a slow, steady stream. Close the lid. Allow the cake to cool uncovered in the refrigerator for 25-30 minutes before attempting to remove it from the pan.

DEVIL'S FOOD POUND CAKE

1 1/2 cups all purpose flour	1 cup white sugar
1 cup cocoa powder	1/2 cup low-fat yogurt, plain
1/4 tsp. nutmeg	1/2 cup farmer's cheese, softened
1 tsp. baking powder	1/2 cup semi-sweet chocolate chips
3/4 tsp. baking soda	1 egg, large
1/2 tsp. salt	1 oz. (shot glass) whiskey or rum

In a small bowl, combine the first six ingredients and mix well. Set aside. Place the egg, yogurt, cheese, whiskey, chocolate chips and sugar in the baking pan in that order. Place the pan in the machine and close the lid. Start the cake cycle. When continuous mixing begins, add the flour mixture in a slow, steady stream. Close lid. Allow the cake to cool uncovered in the refrigerator 25-30 minutes before attempting to remove it from the baking pan. Use a spatula to help loosen the cake if necessary.

CINNAMON-RAISIN COFFEE CAKE

2 cups all purpose flour	2 tbsp. dark raisins
1 cup white sugar	1 tbsp. baking powder
1 1/4 cup milk, whole	1 tsp. vanilla extract
1/2 cup butter or shortening, melted	1/4 tsp. salt
2 eggs, large	

Place milk, butter, eggs and vanilla extract in the baking pan. Add remaining ingredients and start the cake cycle. Dust with powdered sugar after cake has cooled.

LEMON-RAISIN "CHEEZY" CAKE

1 1/2 cups all purpose flour	1/3 cup water, hot
1 cup farmer's cheese (crumbled, small)	2 tbsp. golden raisins, soaked
1/4 low-fat cream cheese (cut in small pieces)	1 tbsp. baking powder
1/2 cup white sugar	1 tsp. lemon extract
2 eggs, large	

Have all ingredients at room temperature (1 1/2 - 2 hours). It is very important that the cheeses are soft and in small pieces or they will not mix properly. Place cheese, egg, raisins, hot water, and lemon extract in baking pan. Add the remaining ingredients and start the cycle. Makes about a 2 lb. cake.

CRANBERRY-WALNUT CAKE

1 1/2 cups all purpose flour	1 cup white sugar
1/3 cup chopped walnuts	2 eggs, large
1/2 tsp. cinnamon	1/4 cup canola oil
3/4 tsp. baking powder	1 tbsp. orange juice
3/4 tsp. baking soda	1/2 tsp. orange extract
1/2 tsp. salt	1 tsp. vanilla extract
1 cup fresh or frozen cranberries, whole	

Crush the cranberries and mix with the sugar. Place in the baking pan and let stand for 10 minutes. Add the eggs, oil, orange juice and orange and vanilla extracts to the pan and place it in the machine. Close the lid and start the cake cycle. Combine the first six ingredients and mix well. When continuous mixing begins, add the flour mixture to the pan in a slow, steady stream. Close the lid. Allow the cake to cool uncovered in the refrigerator for 25-30 minutes before attempting to remove it from the baking pan.

JAM RECIPES

STRAWBERRY-RHUBARB JAM

3/4 cup (8 oz.) strawberries, hulled
3/4 cup (8 oz.) rhubarb, roughly chopped

1 2/3 cups (13 oz.) white sugar

Place all ingredients in baking pan and start the jam cycle. The strawberries should be very ripe and sweet and the rhubarb firm and crisp. Try adding 1 tbsp. of this jam to a small container of plain, low-fat yogurt.

RASPBERRY JAM

1 1/2 cups (12 oz.) red or black raspberries
1 1/2 cups (12 oz.) white sugar

2 tbsp. honey

Place all ingredients in baking pan and start the jam cycle. This jam will be very liquid when cycle is completed. It can be strained to eliminate the seeds, if desired. The jam will thicken when completely cooled.

BLUE KIWI MANGO JAM

3/4 cup (6 oz.) kiwi fruit, peeled and chopped
3/4 cup (6 oz.) mango, peeled and chopped
1 1/2 cups (12 oz.) white sugar

1 tsp. lemon zest, grated
1 tsp. orange zest, grated
4 drops blue food coloring

Place all ingredients in baking pan and start the jam cycle. The kiwi fruit should be ripe but not mushy while the mango should be barely ripe. Lemon and orange zest are grated from the surface of the peel. Make sure some of the bitter white rind is included.

PEACH-RAISIN JAM

1 1/2 cups (12 oz.) ripe peaches, pitted
1 1/2 cups + 1 tsp. white sugar
2 tbsp. golden raisins, soaked

1 tbsp. brown sugar
2 whole cloves
1/8 tsp. ground allspice

Place all ingredients in baking pan and start the jam cycle. For best results, fruit and sugar should be weighed on a small kitchen or postal scale. 1 1/2 cups of fruit or white sugar weighs 12 oz.

KNEADING AND BAKING CYCLE CHARTS

Course Selection	Basic Bread						Basic Rapid Bread					
	Light		Medium		Dark		Light		Medium		Dark	
CRUST Control	1.5 lbs.	2.0 lbs.	1.5 lbs.	2.0 lbs.	1.5 lbs.	2.0 lbs.	1.5 lbs.	2.0 lbs.	1.5 lbs.	2.0 lbs.	1.5 lbs.	2.0 lbs.
Delay Timer Range	3:07-13:00	3:10-13:00	3:15-13:00	3:20-13:00	3:25-13:00	3:30-13:00	1:47-13:00	1:50-13:00	1:55-13:00	2:00-13:00	2:05-13:00	2:10-13:00
Preheat	00	00	00	00	00	00	00	00	00	00	00	00
Knead 1	3 min.	5 min.	3 min.	5 min.	3 min.	5 min.	3 min.	5 min.	3 min.	5 min.	3 min.	5 min.
Knead 2	22 min.	20 min.	22 min.	20 min.	22 min.	20 min.	22 min.	20 min.	22 min.	20 min.	22 min.	20 min.
Rise 1	40 min.	40 min.	40 min.	40 min.	40 min.	40 min.	13 min.	13 min.	13 min.	13 min.	13 min.	13 min.
Knead 3	10 sec.	10 sec.	10 sec.	10 sec.	10 sec.	10 sec.	00	00	00	00	00	00
Rise 2	25 min.	25 min.	25 min.	25 min.	25 min.	25 min.	00	00	00	00	00	00
Knead 4	15 sec.	15 sec.	15 sec.	15 sec.	15 sec.	15 sec.	10 sec.	10 sec.	10 sec.	10 sec.	10 sec.	10 sec.
Rise 3	50 min.	50 min.	50 min.	50 min.	50 min.	50 min.	32 min.	32 min.	32 min.	32 min.	32 min.	32 min.
Baking	37 min.	40 min.	45 min.	50 min.	55 min.	60 min.	37 min.	40 min.	45 min.	50 min.	55 min.	1 hr.
Convection Cool Down	10 min.	10 min.	10 min.	10 min.	10 min.	10 min.	00	00	00	00	00	00
Total Time	3:07	3:10	3:15	3:20	3:25	3:30	1:47	1:50	1:55	2:00	2:05	2:10
Keep Warm	1 hr.	1 hr.	1 hr.	1 hr.	1 hr.	1 hr.	1 hr.	1 hr.	1 hr.	1 hr.	1 hr.	1 hr.

Course Selection	Whole Wheat Bread*						Whole Wheat Rapid Bread*					
	Light		Medium		Dark		Light		Medium		Dark	
CRUST Control	1.5 lbs.	2.0 lbs.	1.5 lbs.	2.0 lbs.	1.5 lbs.	2.0 lbs.	1.5 lbs.	2.0 lbs.	1.5 lbs.	2.0 lbs.	1.5 lbs.	2.0 lbs.
Delay Timer Range	3:38-13:00	3:40-13:00	3:43-13:00	3:45-13:00	3:52-13:00	3:55-13:00	2:13-13:00	2:15-13:00	2:18-13:00	2:20-13:00	2:27-13:00	2:30-13:00
Preheat*	30 min.	30 min.	30 min.	30 min.	30 min.	30 min.	5 min.	5 min.	5 min.	5 min.	5 min.	5 min.
Knead 1	3 min.	5 min.	3 min.	5 min.	3 min.	5 min.	3 min.	5 min.	3 min.	5 min.	3 min.	5 min.
Knead 2	17 min.	15 min.	17 min.	15 min.	17 min.	15 min.	17 min.	15 min.	17 min.	15 min.	17 min.	15 min.
Rise 1	45 min.	45 min.	45 min.	45 min.	45 min.	45 min.	30 min.	30 min.	30 min.	30 min.	30 min.	30 min.
Knead 3	10 sec.	10 sec.	10 sec.	10 sec.	10 sec.	10 sec.	00	00	00	00	00	00
Rise 2	25 min.	25 min.	25 min.	25 min.	25 min.	25 min.	00	00	00	00	00	00
Knead 4	10 sec.	10 sec.	10 sec.	10 sec.	10 sec.	10 sec.	10 sec.	10 sec.	10 sec.	10 sec.	10 sec.	10 sec.
Rise 3	45 min.	45 min.	45 min.	45 min.	45 min.	45 min.	40 min.	40 min.	40 min.	40 min.	40 min.	40 min.
Baking	43 min.	45 min.	48 min.	50 min.	57 min.	60 min.	38 min.	40 min.	43 min.	45 min.	52 min.	55 min.
Convection Cool Down	10 min.	10 min.	10 min.	10 min.	10 min.	10 min.	00	00	00	00	00	00
Total Time	3:38	3:40	3:43	3:45	3:52	3:55	2:13	2:15	2:18	2:20	2:27	2:30
Keep Warm	1 hr.	1 hr.	1 hr.	1 hr.	1 hr.	1 hr.	1 hr.	1 hr.	1 hr.	1 hr.	1 hr.	1 hr.

- Whole Wheat cycles have a rest period for up to 30 minutes before kneading begins. No movement occurs in the Bread Pan. This is normal.

KNEADING AND BAKING CYCLE CHARTS (contd.)

Course Selection	French Bread						French <i>Rapid</i> Bread					
	Light		Medium		Dark		Light		Medium		Dark	
CRUST Control												
LOAF Control	1.5 lbs.	2.0 lbs.	1.5 lbs.	2.0 lbs.	1.5 lbs.	2.0 lbs.	1.5 lbs.	2.0 lbs.	1.5 lbs.	2.0 lbs.	1.5 lbs.	2.0 lbs.
Delay Timer Range	3:27-13:00	3:30-13:00	3:35-13:00	3:40-13:00	3:45-13:00	3:50-13:00	2:27-13:00	2:30-13:00	2:35-13:00	2:40-13:00	2:45-13:00	2:50-13:00
Preheat	00	00	00	00	00	00	00	00	00	00	00	00
Knead 1	3 min.	5 min.	3 min.	5 min.	3 min.	5 min.	3 min.	5 min.	3 min.	5 min.	3 min.	5 min.
Knead 2	22 min.	25 min.	22 min.	25 min.	22 min.	20 min.	22 min.	20 min.	22 min.	20 min.	22 min.	20 min.
Rise 1	40 min.	40 min.	40 min.	40 min.	40 min.	40 min.	25 min.	25 min.	25 min.	25 min.	25 min.	25 min.
Knead 3	10 sec.	10 sec.	10 sec.	10 sec.	10 sec.	10 sec.	00	00	00	00	00	00
Rise 2	30 min.	30 min.	30 min.	30 min.	30 min.	30 min.	00	00	00	00	00	00
Knead 4	10 sec.	10 sec.	10 sec.	10 sec.	10 sec.	10 sec.	10 sec.	10 sec.	10 sec.	10 sec.	10 sec.	10 sec.
Rise 3	60 min.	60 min.	60 min.	60 min.	60 min.	60 min.	55 min.	55 min.	55 min.	55 min.	55 min.	55 min.
Baking	42 min.	45 min.	50 min.	55 min.	60 min.	65 min.	42 min.	45 min.	50 min.	55 min.	1 hr.	65 min.
Convection Cool Down	10 min.	10 min.	10 min.	10 min.	10 min.	10 min.	00	00	00	00	00	00
Total Time	3:27	3:30	3:35	3:40	3:45	3:50	2:27	2:30	2:35	2:40	2:45	2:50
Keep Warm	1 hr.	1 hr.	1 hr.	1 hr.	1 hr.	1 hr.	1 hr.	1 hr.	1 hr.	1 hr.	1 hr.	1 hr.

Course Selection	Fruit & Nut Bread						Fruit & Nut <i>Rapid</i> Bread					
	Light		Medium		Dark		Light		Medium		Dark	
CRUST Control												
LOAF Control	1.5 lbs.	2.0 lbs.	1.5 lbs.	2.0 lbs.	1.5 lbs.	2.0 lbs.	1.5 lbs.	2.0 lbs.	1.5 lbs.	2.0 lbs.	1.5 lbs.	2.0 lbs.
Delay Timer Range	3:22-13:00	3:25-13:00	3:30-13:00	3:35-13:00	3:40-13:00	3:45-13:00	2:22-13:00	2:25-13:00	2:30-13:00	2:35-13:00	2:40-13:00	2:45-13:00
Preheat	00	00	00	00	00	00	00	00	00	00	00	00
Knead 1	3 min.	5 min.	3 min.	5 min.	3 min.	5 min.	3 min.	5 min.	3 min.	5 min.	3 min.	5 min.
Knead 2	22 min.	20 min.	22 min.	20 min.	22 min.	20 min.	22 min.	20 min.	22 min.	20 min.	22 min.	20 min.
Rise 1	25 min.	25 min.	25 min.	25 min.	25 min.	25 min.	20 min.	20 min.	20 min.	20 min.	20 min.	20 min.
Knead 3	10 sec.	10 sec.	10 sec.	10 sec.	10 sec.	10 sec.	00	00	00	00	00	00
Rise 2	25 min.	25 min.	25 min.	25 min.	25 min.	25 min.	00	00	00	00	00	00
Knead 4	5 sec.	5 sec.	5 sec.	5 sec.	5 sec.	5 sec.	10 sec.	10 sec.	10 sec.	10 sec.	10 sec.	10 sec.
Rise 3	65 min.	65 min.	65 min.	65 min.	65 min.	65 min.	45 min.	45 min.	45 min.	45 min.	45 min.	45 min.
Baking	52 min.	55 min.	1 hr.	65 min.	70 min.	75 min.	52 min.	55 min.	60 min.	65 min.	70 min.	75 min.
Convection Cool Down	10 min.	10 min.	10 min.	10 min.	10 min.	10 min.	00	00	00	00	00	00
Total Time	3:22	3:25	3:30	3:35	3:40	3:45	2:22	2:25	2:30	2:35	2:40	2:45
Keep Warm	1 hr.	1 hr.	1 hr.	1 hr.	1 hr.	1 hr.	1 hr.	1 hr.	1 hr.	1 hr.	1 hr.	1 hr.

*When adding fruits, nut, herbs, etc. to doughs, wait to hear the "add-in" beeper. The beeper activates 23 minutes into the bread's cycle.

KNEADING AND BAKING CYCLE CHARTS (contd.)

Course Selection	Cake *Knead 5 1.5 min.	Jam	Pizza Dough	Dough	Bake Only
CRUST Control	N/A	N/A	N/A	N/A	N/A
LOAF Control	N/A	N/A	N/A	N/A	N/A
Delay Timer Range	1:50	1:15-13:00	0:50-13:00	1:25-13:00	
Preheat	00	15 min.	00	00	00
Knead 1	1 min.	00	5 min.	5 min.	00
Knead 2	3 min.	00	15 min.	20 min.	00
Rise 1	2 min.	00	30 min.	60 min.	00
Knead 3	2 min.	00	00	00	00
Rise 2	1 min.	00	00	00	00
Knead 4	2 min.	00	00	00	00
Rise 3	00	00	00	00	00
Baking	89 min.	50 min.	00	00	40 min.
Convection Cool Down	10 min.	10 min.	00	00	10 min.
Total Time	1:50	1:15	0:50	1:25	0:15-2:00
Keep Warm	1 hr	00	00	00	00

* You can "Bake Only" from 15 minutes to 1 hour, 50 minutes. See page 9 and 10, "Using the Timer—Bake Only" for more details.

TROUBLESHOOTING (contd.)

PROBLEM	POSSIBLE CAUSE	POSSIBLE SOLUTION
MACHINE..		
1. Does not begin cycle after pushing START	1. Machine not plugged in; SELECT not pressed prior to START; machine too hot	1. Plug in machine; make selection by pressing SELECT before START; remove Bread Pan and allow machine to cool (about 20 minutes).
2. Stops and displays "ALERT"	2. Machine unplugged; power outage	2. Plug in machine; see "Operating Instructions" on page 6.
3. Will not let me set the Timer	3. Timer cannot be set for "Jam" cycle	3. Do not attempt to use timer for Jam cycle.
4. "__H" displays when you press START	4. Machine too hot	4. Remove Bread Pan and allow machine to cool (about 20 minutes).
5. "__L" displays when you press START	5. Machine is too cold	5. Unplug machine and allow it to reach room temperature
6. "H:1", "H:HH", "L:LL", "S:SS", "888", or blank boxes appear when you press START	6. Error code message	6. Press STOP to clear display. If display does not clear, unplug machine and contact Customer Service Dept. at 1-800-233-9054

Free Manuals Download Website

<http://myh66.com>

<http://usermanuals.us>

<http://www.somanuals.com>

<http://www.4manuals.cc>

<http://www.manual-lib.com>

<http://www.404manual.com>

<http://www.luxmanual.com>

<http://aubethermostatmanual.com>

Golf course search by state

<http://golfingnear.com>

Email search by domain

<http://emailbydomain.com>

Auto manuals search

<http://auto.somanuals.com>

TV manuals search

<http://tv.somanuals.com>