



## ELECTRIC BUILT-IN OVEN

Use & Care Guide

## HORNO DE PARED

Manual del Usuario

Models, Modelos

790. 4773\*, 4777\*,  
4776\*, 4787\*

\* = Color number,  
número de color



ENGLISH

ESPAÑOL

# Table of Contents

Wall Oven Warranty .....	2	Control Pad Features .....	8
Product Record .....	2	Setting the Clock .....	9
Serial Plate Location .....	2	Setting the Oven Controls .....	10-15
<b>IMPORTANT SAFETY INSTRUCTIONS</b> .....	<b>3-4</b>	Adjusting Your Oven Temperature .....	<b>16</b>
Protection Agreements .....	5	Cleaning the Self-Clean Oven .....	<b>17-18</b>
Wall Oven Features .....	6	General Care & Cleaning .....	<b>19-21</b>
Oven Vent and Racks .....	7	Before You Call .....	<b>22-23</b>
Air Circulation in the Oven .....	7	Sears Service .....	<b>24</b>

## Please carefully read and save these instructions

This Use & Care Manual contains general operating instructions for your appliance and feature information for several models. Your product **may not** have all the described features. The graphics shown are representative. The graphics on your appliance may not look exactly like those shown. Common sense and caution must be practiced when installing, operating and maintaining any appliance.

### Kenmore Warranty

When installed, operated and maintained according to all instructions supplied with the product, if this appliance fails due to a defect in material and workmanship within one year from the date of purchase, call 1-800-4-MY-HOME® to arrange for free repair.

This warranty applies for only 90 days from the date of purchase if this appliance is ever used for other than private family purposes.

#### **This warranty covers only defects in material and workmanship. Sears will NOT pay for:**

1. Cracks in a ceramic glass cooktop that are not a result of thermal shock.
2. Stains and scratches on a ceramic glass cooktop resulting from accident or improper operation or maintenance.
3. Expendable items that can wear out from normal use, including but not limited to filters, belts, light bulbs, and bags.
4. A service technician to instruct the user in correct product installation, operation or maintenance.
5. A service technician to clean or maintain this product.
6. Damage to or failure of this product if it is not installed, operated or maintained according to the all instructions supplied with the product.
7. Damage to or failure of this product resulting from accident, abuse, misuse or use for other than its intended purpose.
8. Damage to or failure of this product caused by the use of detergents, cleaners, chemicals or utensils other than those recommended in all instructions supplied with the product.
9. Damage to or failure of parts or systems resulting from unauthorized modifications made to this product.

#### **Disclaimer of implied warranties; limitation of remedies**

Customer's sole and exclusive remedy under this limited warranty shall be product repair as provided herein. Implied warranties, including warranties of merchantability or fitness for a particular purpose, are limited to one year or the shortest period allowed by law. Sears shall not be liable for incidental or consequential damages. Some states and provinces do not allow the exclusion or limitation of incidental or consequential damages, or limitation on the duration of implied warranties of merchantability or fitness, so these exclusions or limitations may not apply to you.

This warranty applies only while this appliance is used in the United States or Canada.

This warranty gives you specific legal rights, and you may also have other rights which vary from state to state.

**Sears, Roebuck and Co., Hoffman Estates, IL 60179**  
**Sears Canada Inc., Toronto, Ontario, Canada M5B 2B8**

## Product Record

In this space below, record the date of purchase, model and serial number of your product. You will find the model and serial number printed on the serial plate.

Model No. 790.

Serial No. \_\_\_\_\_

Date of purchase \_\_\_\_\_

Save these instructions and your sales receipt for future reference.

Printed in United States

## Serial Plate Location

You will find the model and serial number printed on the serial plate. The serial plate is located along the interior side trim of the lower oven and visible when the oven door is opened.

Remember to record the serial number for future reference.

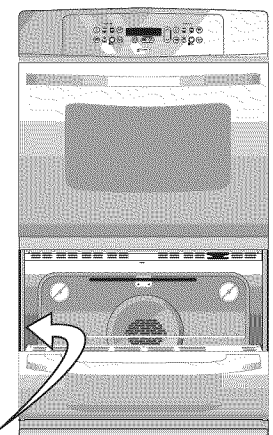

**Serial Plate Location**

# Important Safety Instructions

Read all instructions before using this appliance.  
Save these instructions for future reference.

This manual contains important safety symbols and instructions. Please pay attention to these symbols and follow all instructions given.

**⚠ WARNING** This symbol will help alert you to situations that may cause serious bodily harm, death or property damage.

**⚠ CAUTION** This symbol will help alert you to situations that may cause bodily injury or property damage.

- **Remove all tape and packaging before using the appliance.** Destroy the carton and plastic bags after unpacking the appliance. Never allow children to play with packaging material.
- **Proper Installation. Be sure your appliance is properly installed and grounded by a qualified technician in accordance with National Electrical Code ANSI/NFPA No.70 (USA) or CSA C22.1, PART 1 (Canada)-latest edition and local code requirements.** Install only per installation instructions provided in the literature package for this appliance.
- **In case of an emergency, know how to disconnect the electrical power to the appliance at the circuit breaker or fuse box and how to turn off the gas supply at the main shutoff valve.**

**⚠ CAUTION** Electronic controllers can be damaged by cold temperatures. When you use your appliance for the first time, or if it has not been used for a long period of time, make sure that it has been exposed to a temperature above 0°C/32°F for at least 3 hours before connecting it to the power supply.

- **User Servicing—Do not repair or replace any part of the appliance unless specifically recommended in the manuals.** All other servicing should be done only by a qualified technician to reduce the risk of personal injury and damage to the appliance. Sears Parts & Repair is the recommended repair service for this appliance.
- **Never modify or alter the construction of an appliance by removing panels, wire covers or any other part of the product.**

- **Remove the oven door from any unused appliance if it is to be stored or discarded.**

**⚠ WARNING** Stepping, leaning, sitting or pulling down on the door of this appliance can result in serious injuries and may also cause damage to the appliance. Do not allow children to climb or play around the appliance.

- **Storage on Appliance. Flammable materials should not be stored near surface units.** This includes paper, plastic and cloth items, such as cookbooks, plasticware and towels, as well as flammable liquids. Do not store explosives, such as aerosol cans, on or near the appliance. Flammable materials may explode and result in fire or property damage.

**⚠ WARNING** Do not use the oven for storage.

**⚠ CAUTION** Do not store items of interest to children in the cabinets above an appliance. Children climbing on the appliance to reach items could be seriously injured.

- **Do not leave children alone. Children should not be left alone or unattended in the area where an appliance is in use.** They should never be allowed to sit or stand on any part of the appliance.
- **DO NOT TOUCH SURFACE UNITS OR AREAS NEAR THESE SURFACES.** Surface units may be hot even though they are dark in color. Areas near surface units may become hot enough to cause burns. During and after use, do not touch, or let clothing or other flammable materials touch these areas until they have had sufficient time to cool. Among these areas are the cooktop and areas facing the cooktop.
- **Wear Proper Apparel. Loose-fitting or hanging garments should never be worn while using the appliance.** Do not let clothing or other flammable materials contact hot surfaces.

**⚠ WARNING** Never use your appliance for warming or heating the room.

- **Do Not Use Water or Flour on Grease Fires.** Smother the fire with a pan lid, or use baking soda, a dry chemical or foam-type extinguisher.
- **When heating fat or grease, watch it closely.** Fat or grease may catch fire if allowed to become too hot.



**⚠ WARNING**

- All wall ovens can tip.
- Injury to persons could result.
- Install anti-tip bracket packed with wall oven.
- See Installation Instructions.



To reduce the risk of tipping, the wall oven must be secured by properly installed anti-tip bracket provided with the wall oven. Refer to the Installation Instructions for proper anti-tip bracket installation.

ENGUSST

# Important Safety Instructions

- **Use Only Dry Potholders.** Moist or damp potholders on hot surfaces may result in burns from steam. Do not let the potholders touch hot heating surface units. Do not use a towel or other bulky cloth instead of a potholder.
- **Do Not Heat Unopened Food Containers.** Buildup of pressure may cause the container to burst and result in injury.

**IMPORTANT—Do not attempt to operate the appliance during a power failure.** If power fails, always turn off the appliance. If the appliance is not turned off and the power resumes, it will begin to operate again. Once the power resumes, reset the clock and oven function.

## IMPORTANT INSTRUCTIONS FOR USING YOUR OVEN

- **Use Care When Opening an Oven Door—**Stand to the side of the appliance when opening the door of a hot oven. Let hot air or steam escape before you remove or replace food in the oven.
- **Keep Oven Vent Ducts Unobstructed.** The wall oven is vented at the upper control panel or at the center trim depending of the model. Touching the surfaces in this area when the wall oven is operating may cause severe burns. Also, do not place plastic or heat-sensitive items near the oven vent. These items could melt or ignite.
- **Placement of Oven Racks.** Always place oven racks in desired location while oven is cool. Remove all utensils from the rack before removing rack. If rack must be moved while oven is hot, use extreme caution. Use pot holders and grasp the rack with both hands to reposition. Do not let pot holders contact the hot oven element or interior of the oven.
- **Do not use your broiler pan without its insert.** Your broiler pan and its grid allow dripping fat to drain and be kept away from the high heat of the broiler.
- **Do not cover your broiler grid or oven bottom with aluminum foil.** Exposed fat and grease could ignite.
- **Do not touch a hot oven light bulb with a damp cloth.** Doing so could cause the bulb to break. Disconnect the appliance or shut off the power to the appliance before removing and replacing the bulb.

- **Protective liners—**Do not use aluminum foil to line the oven bottom. Only use aluminum foil as recommended in this manual. Improper installation of these liners may result in risk of electric shock, or fire.

## IMPORTANT INSTRUCTIONS FOR CLEANING YOUR OVEN

- **Clean the appliance regularly to keep all parts free of grease that could catch fire.** Exhaust fan ventilation hoods and grease filters should be kept clean. Do not allow grease to accumulate. Greasy deposits in the fan could catch fire. Refer to the hood manufacturer's instructions for cleaning.
- **Cleaners/Aerosols—**Always follow the manufacturer's recommended directions for use. Be aware that excess residue from cleaners and aerosols may ignite causing damage and/or injury.

## SELF-CLEANING OVEN MODELS

- **Clean in the self-cleaning cycle only the parts of the appliance listed in this Owner's Guide.** Before using the self-cleaning cycle of the appliance, remove all utensils stored in the appliance.
- **Do not clean the oven door gasket.** The door gasket is essential for a good seal. Care should be taken not to rub, damage or move the gasket.
- **Do not use oven cleaners.** No oven cleaner or oven liner protective coating of any kind should be used in or around any part of the appliance

**CAUTION** The health of some birds is extremely sensitive to the fumes given off during the self-clean cycle of any wall oven. Move birds to another well ventilated room.

---

## IMPORTANT SAFETY NOTICE

The California Safe Drinking Water and Toxic Enforcement Act requires the Governor of California to publish a list of substances known to the state to cause cancer, birth defects or other productive harm, and requires businesses to warn customers of potential exposure to such substances.

---

# PROTECTION AGREEMENTS

## Master Protection Agreements

*Congratulations on making a smart purchase. Your new Kenmore® product is designed and manufactured for years of dependable operation. But like all products, it may require preventive maintenance or repair from time to time. That's when having a Master Protection Agreement can save you money and aggravation.*

The Master Protection Agreement also helps extend the life of your new product. Here's what the Agreement\* includes:

- ☑ **Parts and labor** needed to help keep products operating properly **under normal use**, not just defects. Our coverage goes **well beyond the product warranty**. No deductibles, no functional failure excluded from coverage – **real protection**.
- ☑ **Expert service** by a force of more than **10,000 authorized Sears service technicians**, which means someone you can trust will be working on your product.
- ☑ **Unlimited service calls and nationwide service**, as often as you want us, whenever you want us.
- ☑ **«No-lemon» guarantee** – replacement of your covered product if four or more product failures occur within twelve months.
- ☑ **Product replacement** if your covered product can't be fixed.
- ☑ **Annual Preventive Maintenance Check** at your request – no extra charge.
- ☑ **Fast help by phone** – we call it **Rapid Resolution** – phone support from a Sears representative on all products. Think of us as a «talking owner's manual».
- ☑ **Power surge protection** against electrical damage due to power fluctuations.
- ☑ **\$250 Food Loss Protection** annually for any food spoilage that is the result of mechanical failure of any covered refrigerator or freezer.
- ☑ **Rental reimbursement** if repair of your covered product takes longer than promised.
- ☑ **10% discount** off the regular price of any non-covered repair service and related installed parts.

Once you purchase the Agreement, a simple phone call is all that it takes for you to schedule service. You can call anytime day or night, or schedule a service appointment online.

The Master Protection Agreement is a risk free purchase. If you cancel for any reason during the product warranty period, we will provide a full refund. Or, a prorated refund anytime after the product warranty period expires. Purchase your Master Protection Agreement today!

**Some limitations and exclusions apply. For prices and additional information in the U.S.A. call 1-800-827-6655.**

**\* Coverage in Canada varies on some items. For full details call Sears Canada at 1-800-361-6665.**

## Sears Installation Service

*For Sears professional installation of home appliances, garage door openers, water heaters, and other major home items, in the U.S.A. or Canada call **1-800-4-MY-HOME**®.*

## Acuerdos maestros de protección

*Enhorabuena por haber hecho una compra inteligente. Su nuevo producto Kenmore® está diseñado y fabricado para brindarle años de funcionamiento fiable. Pero, como cualquier producto, puede necesitar mantenimiento preventivo o reparaciones periódicas. Es por eso que tener un Acuerdo maestro de protección podría ahorrarle dinero y molestias.*

El Acuerdo maestro de protección también sirve para prolongar la durabilidad de su nuevo producto. El acuerdo\* incluye lo siguiente:

- ☑ **Piezas y mano de obra** necesarias para contribuir a mantener el funcionamiento adecuado de los productos **utilizados en condiciones normales de uso**, no sólo en caso de defectos de los productos. Nuestra cobertura va **mucho más allá que la garantía del producto**. No se aplican deducibles ni exclusiones por fallas del funcionamiento: es decir, **verdadera protección**.
- ☑ **Servicio técnico por expertos** (más de **10000 técnicos autorizados de Sears**), lo cual significa que quien repare o realice el mantenimiento de su producto será un profesional de confianza.
- ☑ **Servicio técnico a escala nacional y número ilimitado de llamadas de solicitud de servicio técnico**: se puede poner en contacto con nosotros cuantas veces lo desee y cuando lo desee.
- ☑ **Garantía «sin sorpresas»**: se reemplaza el producto cubierto por el acuerdo si ocurren cuatro o más fallas del producto en un periodo de 12 meses.
- ☑ **Reemplazo del producto**: en caso de que no se pueda reparar el producto cubierto por el acuerdo.
- ☑ **Revisión anual preventiva de mantenimiento del producto**: puede solicitarla en cualquier momento, sin costo alguno.
- ☑ **Rápida asistencia telefónica**, la cual denominamos **Solución rápida**: es decir, asistencia telefónica a través de cualquiera de nuestros representantes de Sears, sobre cualquiera de nuestros productos. Piense en nosotros como en un «manual parlante del usuario».
- ☑ **Protección contra fallas eléctricas**, contra daños debidos a fluctuaciones de la corriente eléctrica.
- ☑ **\$250 al año para cubrir cualquier posible deterioro de alimentos** que haya tenido que desechar debido a una falla mecánica de cualquiera de nuestros refrigeradores o congeladores cubiertos por este acuerdo.
- ☑ **Devolución de gastos de alquiler de electrodomésticos** si la reparación de su producto asegurado toma más que el tiempo prometido.
- ☑ **10% de descuento** aplicable tanto a los costos del servicio de reparación, como de las piezas instaladas relacionadas que no hayan quedado cubiertos por este acuerdo.

Una vez que haya realizado el pago de este acuerdo, bastará una simple llamada telefónica para concertar una visita de servicio. Puede llamar a cualquier hora del día o de la noche, o bien concertar una visita de servicio por Internet.

La adquisición del Acuerdo maestro de protección es una inversión exenta de riesgos. Si por cualquier motivo decide cancelar dicho acuerdo durante el periodo de garantía del producto, le haremos un reintegro total del valor. O bien un importe proporcional si cancela el acuerdo en cualquier otro momento posterior al vencimiento del periodo de garantía del producto. ¡Adquiera hoy mismo su Acuerdo maestro de protección!

**Algunas limitaciones y exclusiones podrían aplicarse. Para solicitar precios e información adicional, llame al 1-800-827-6655 (en los EE.UU.).**

**\* La cobertura en Canadá varía en el caso de algunos artículos. Para obtener detalles completos al respecto, llame al 1-800-361-6665 de Sears de Canadá.**

## Servicio de instalación de Sears

*Para solicitar la instalación por profesionales de Sears de electrodomésticos, abridores de puertas de garaje, calentadores de agua y otros artículos de uso prioritario en el hogar, llame al **1-800-4-MY-HOME** en los EE.UU. o Canadá.*

# Wall Oven Features

Note: The features of your wall oven will vary according to model.

## Your Electric Wall Oven Features At a Glance

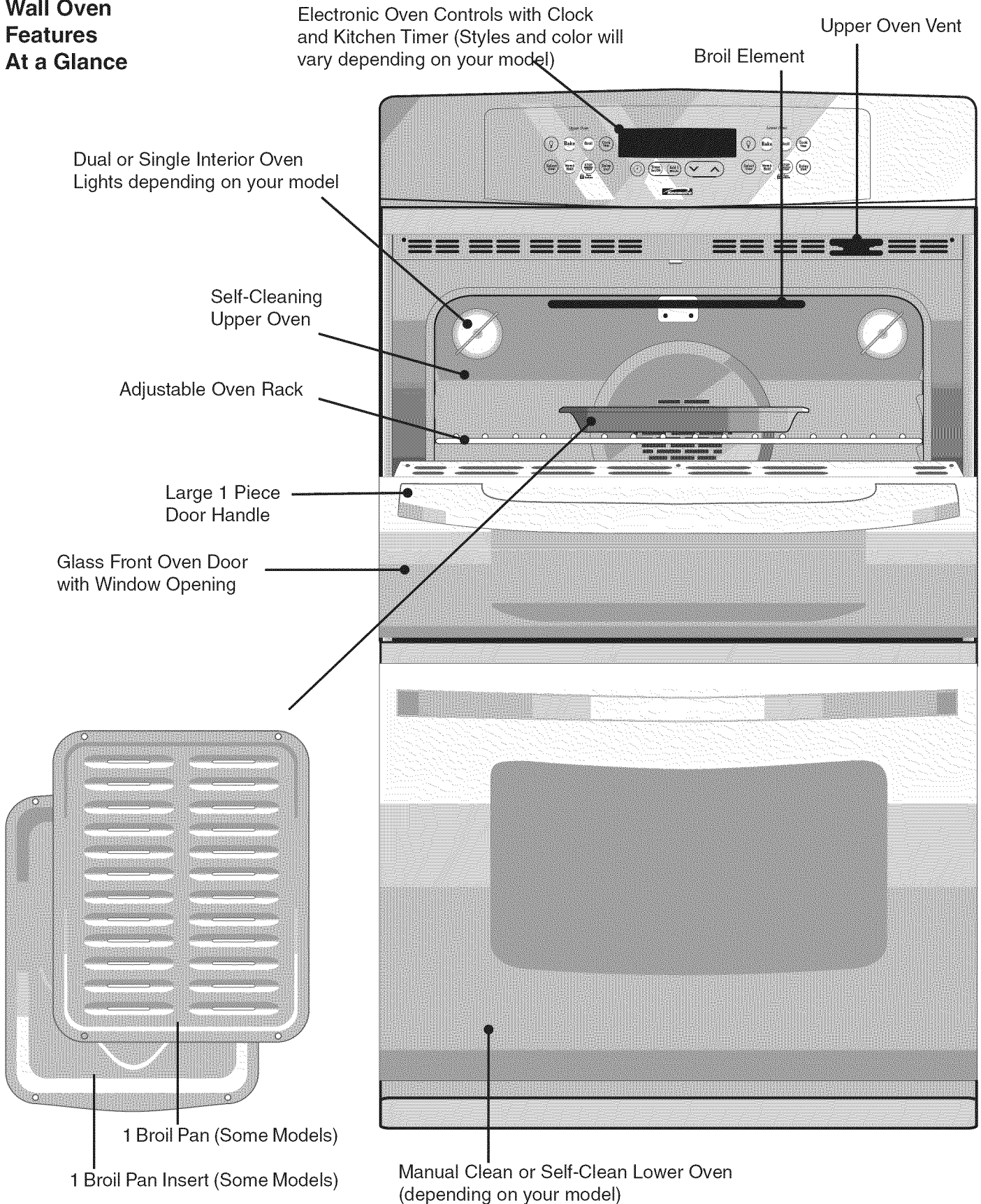

# Oven Vent(s) and Racks

Upper Oven  
Vent Location

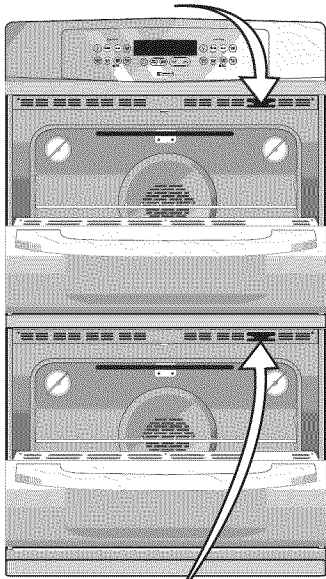

Lower Oven  
Vent Location

**⚠ CAUTION** Some models are equipped with a blower which runs in baking and self-cleaning mode to keep all internal components at a cool temperature. The blower may keep running even if the oven has been turned off, until the components have cooled down.

## Oven Vent Location

Each oven is vented **at the upper front frame**. When the oven is on, warm air is released through the vent. This venting is necessary for proper air circulation in the oven and good baking results.

## Arranging Oven Racks

*ALWAYS ARRANGE OVEN RACKS WHEN THE OVEN IS COOL (PRIOR TO OPERATING THE OVEN).* Always use oven mitts when using the oven.

**To remove an oven rack**, pull the rack forward until it stops. Lift up front of rack and slide out.

**To replace an oven rack**, fit the rack onto the guides on the oven walls. Tilt the front of the rack upward and slide the rack back into place.

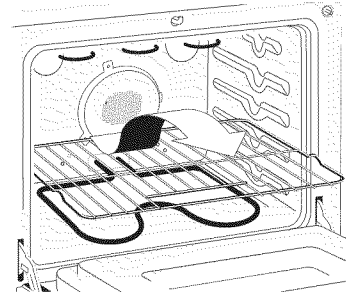

ENGLISH

## Air Circulation in the Oven

If using 1 rack, place in center of oven. If using multiple racks, stagger cookware as shown.

For best air circulation and baking results allow 2-4" (5-10 cm) around the cookware for proper air circulation and be sure pans and cookware do not touch each other, the oven door, sides or back of the oven cavity. The hot air must circulate around the pans and cookware in the oven for even heat to reach around the food.

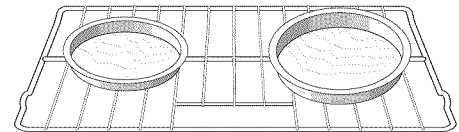

1 Oven Rack

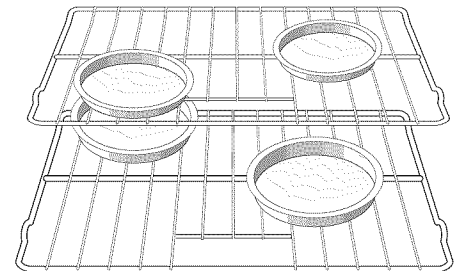

Multiple Oven Racks



# Control Pad Features

**Note:** The appearance of your oven control may differ slightly from the one illustrated below. However, all functions are the same. Also, pads may be shaped differently than those appearing in this Use and Care Guide.

**READ THE INSTRUCTIONS CAREFULLY BEFORE USING THE OVEN.** For satisfactory use of your oven, become familiar with the various functions of the oven as described below.

**OVEN INTERIOR LIGHT PAD** Used to turn oven interior light ON and OFF.

**BAKE PAD** Used to select the bake function.

**BROIL PAD** Used to select the variable broil function.

**COOK TIME PAD** Used to enter the length of the baking time.

**UP and DOWN ARROWS PADS** Used along with the function pads to select oven temperature, cook time, start time (when programming an automatic start time), time of day, clean time and minute timer.

**Oven Light Pad**

**Cook Time Pad (some models)**

**WARM & HOLD PAD** Used to set the Warm & Hold feature.

**SELECT SELF-CLEAN PAD** Used to select the Self-Cleaning cycle. A 2, 3 or 4 hour Self-Clean time may be selected.

**STOP CLEAR PAD** Used to clear any function previously entered except the time of day and minute timer. Press STOP CLEAR to stop cooking. Also the STOP CLEAR pad is used to activate oven lockout setting.

**DELAY START PAD** Used to set the desired start time for baking or cleaning. May be used with COOK TIME to program a delayed bake cycle.

**CLOCK SET PAD** Used to set the time of day.

**ADD 1 MINUTE PAD** Used to add 1 minute to the Timer Countdown. This feature works with the Kitchen Timer only and does not affect any cook time or start time functions (some models).

**TIMER SET/OFF PAD** Used to set or cancel the minute timer. The minute timer does not start or stop cooking. Also, TIMER SET/OFF Pad is used to set the Continuous Bake Feature.

**Select Clean Pad (some models)**

**Warm & Hold Pad (some models)**

**Stop Clear Pad (some models)**

**Delay Start Pad (some models)**

**Upper Oven**

**Lower Oven**

## For a silent control panel:

The **Delay Start** pad controls the Silent Control Panel feature. The Silent Control Panel feature allows the oven control to be operated without sounds or beeps whenever necessary. If desired the control can be programmed for silent operation and later returned to operating with all the normal sounds and beeps.

### To change control from normal sound operation to silent control operation

1. Press and hold **Delay Start** pad for 6 seconds. A beep will sound, "--:--" will appear, "UPPER" and "DELAY" will flash in the display. After 6 seconds, a beep will sound and "SP" (speaker) will appear in the display.
2. Press **^** or **v** pad to switch between normal sound operation and silent operation mode. If "SP" appears, the control will operate with normal sounds and beeps. If "- -" appears, the control is in the silent operation mode.
3. Wait 5 seconds to accept the change or press **STOP Clear** pad to reject the change.

## Temperature Conversion (Fahrenheit / Celsius)

The **Broil** pad controls the Fahrenheit or Celsius temperature display modes. The oven control can be programmed to display temperatures in Fahrenheit or Celsius. The oven has been preset at the factory to display in Fahrenheit. Note: both ovens will be changed at the same time.

### To change display from Fahrenheit to Celsius or Celsius to Fahrenheit

1. Press **Broil** pad and hold for 6 seconds. A beep will sound, "---" will appear "UPPER" and "BROIL" will flash in the display. After 6 seconds a beep will be heard and "F" or "C" will appear in the display. If "F" appears, the display is set to show temperatures in Fahrenheit. If "C" appears, the display is set to show temperatures in Celsius.
2. Press **^** or **v** pad to switch between Fahrenheit or Celsius display modes. The display will show either "F" or "C".
3. Wait 5 seconds to accept the change or press **STOP Clear** pad to reject the change.



# Setting the Clock



**Note:** The time of day **must** first be set in order to operate the oven.

## To Set the Clock

The  pad is used to set the clock. The clock may be set for 12 or 24 hour time of day operation. The clock has been preset at the factory for the 12 hour operation. When the appliance is first plugged in, or when the power supply to the appliance has been interrupted, the timer in the display will flash along with "PF" (power failure).





When PF appears in the display and 12:00 is flashing, press  pad. A beep will sound and PF will disappear.

### To set the clock

1. Press  pad. "CLO" and the current time of day will appear in the display.
2. Press  or  pad to set the correct time of day. Wait 5 seconds. The new time of day will appear in the display.

---

## Changing Between 12 or 24 Hour Time of Day Display:





1. Press and hold  pad for 7 seconds. "CLO" and the current time of day will appear in the display. A beep will sound and "12h" or "24h" will appear in the display.
2. Press  or  pad to switch between the 12 and 24 hour time of day display. The display will show either "12h" or "24h".
3. Wait 5 seconds to accept the change or press  pad to reject the change.
4. Reset the correct time as described in **To set the Clock** above. Please note that if the 24 hour time of day mode was chosen, the clock will now display time from 0:00 through 23:59 hours.

---

## To Set the Minute Timer

The  pad controls the Timer feature. The Timer serves as an extra timer in the kitchen that will beep when the set time has run out. It does not start or stop cooking. The Timer feature can be used during any of the other oven control functions, except during a self clean operation.



### To set the Timer

1. Press  pad. "--:--" will appear and "TIMER" will flash in the display.
2. Press  or  pad to set the desired time in the display. Wait 5 seconds and the time will begin to countdown with the set time and "TIMER" will stay in the display.
3. When the set time has run out, "End" and "TIMER" will show in the display. The clock will sound with 3 beeps every 7 seconds until  pad is pressed.

**To cancel the Kitchen Timer before the set time has run out:** Press  pad. The display will return to the time of day.

---

## To Set Add 1 Minute Feature

When the  pad is pressed, 1 minute is added to the Minute Timer feature if this feature is already active. If the Minute Timer feature is not active and the  pad is pressed, the Minute Timer feature will become active and will begin counting down from 1 minute.

# Setting Oven Controls



**Note:** The time of day **must** first be set in order to operate the oven.

**NOTICE :** The illustrations and instructions contained in this document only refer to the upper oven operations. Before every operations, you must select the proper oven which will be in use. All these instructions can also be applied to the lower oven by selecting the Lower Oven Pad on the right hand side of the control panel.

## To Set or Change the Temperature for Baking



The  pad controls normal baking. The oven can be programmed to bake at any temperature from 170° F to 550° F.

### To Set the Controls for Normal Baking:

1. Arrange interior oven racks and place food in oven.
2. Press  pad, "--" will appear, "UPPER" or "LOWER" and "BAKE" will flash in the display.
3. Press  or  pad to set the desired temperature. The desired temperature will appear "UPPER" or "LOWER" and "BAKE" continue flashing in the display.
4. Wait 5 seconds. "UPPER" or "LOWER" and "BAKE" stop flashing and the oven icon will appear in the display. A beep will sound once the oven temperature reaches the desired baking temperature.

Pressing  pad will cancel the Bake feature at any time.

### To Change the Oven Temperature after Baking has Started:





1. After the oven has already been set to bake and the oven temperature needs to be changed, press  pad. "-- °" will appear, "UPPER" or "LOWER" and "BAKE" start flashing in the display.
2. Press  or  pad to increase or decrease the set temperature.
3. Wait 5 seconds. "UPPER" or "LOWER" and "BAKE" will stop flashing and remain in the display. A beep will sound once the oven temperature reaches the desired baking temperature.

Note: If the oven was recently heated from prior cooking and has remained heated, the bake element symbol may not show in the display immediately.

## To Set Control for Continuous Bake or 12 Hour Energy Saving:

The  pad controls the Continuous Bake or 12 Hour Energy Saving Features. The oven control has a factory preset built-in 12 Hour Energy Saving feature that will shut off the oven if the oven control is left on for more than 11 hours and 59 minutes. The oven can be programmed to override this feature for Continuous Baking.



### To set control for continuous baking:

1. Press and hold  pad for 10 seconds. After 10 seconds "12h" or "-h" will appear in the display and the control will beep once.
2. Press  or  pad to switch between the 12 Hour Energy Saving and continuous bake features. Note: "12h" in the display indicates the control is set for the 12 Hour Energy Saving mode and "-h" indicates the control is set for the Continuous Bake feature.
3. Wait 5 seconds to accept the change (display will return to time of day) or press  pad to reject the change.



## To Set Control for Oven Lockout (some models):

The  pad controls the Oven Lockout feature. The Oven Lockout feature automatically locks the oven doors and prevents the Oven from being turned on. It does not disable the clock, Kitchen Timer or the interior oven lights. The ovens can be locked individually.

### To activate the Oven Lockout feature



Press and hold  pad for 3 seconds. After 3 seconds a beep will sound, "DOOR", "LOCKED" will flash and "Loc", the oven icon, "UPPER" and  will appear in the display. Once the oven door is locked the "DOOR" and "LOCKED" indicator will stop flashing and remain in the display.

### To reactivate normal oven operation:







Press and hold  pad for 3 seconds. A beep will sound. The oven icon, "UPPER", "LOC" and  will disappear from the display. "DOOR" and "LOCKED" will flash in the display until the oven door has completely unlocked. The wall oven is again fully operational. Note: Because you can set the oven lockout individually, the lower oven can be used when the upper oven lockout feature is on.

# Setting Oven Controls

## To Set the Timed Bake Feature (All upper oven, some lower oven)

The  and  pads control the Timed Bake feature. The automatic timer of the Timed Bake feature will turn the oven OFF after cooking for the desired amount of time you selected.



### To Program the Oven to Begin Baking Immediately and To Shut Off Automatically (Timed Bake):

1. Be sure that the clock shows the correct time of day.
2. Arrange interior oven rack(s) and place the food in the oven.
3. Press  pad, "UPPER" or "LOWER", "BAKE" will flash and "- - -" will appear in the display.
4. Press  or  pad to set the desired temperature. "UPPER" or "LOWER", "BAKE" will continue to flash and desired temperature will appear in the display.
5. Wait 5 seconds, "UPPER" or "LOWER" and "BAKE" stop flashing and remain in the display.
6. Press  pad. "UPPER" or "LOWER" and "TIMED" start flashing and "--:--" will appear in the display.
7. Press the  or  pad until the desired baking time appears in the display.  
**Note:** Baking time can be set for any amount of time between 1 minute to 11 hours and 59 minutes.
8. Wait 5 seconds, the display returns to the time of day.









Note: After the Timed Bake feature has been activated, press  pad to display the bake time remaining in the Timed Bake mode. Once Timed Bake has started baking, a beep will sound when the oven temperature reaches the set temperature.

Press  pad when baking has finished or at any time to cancel the Timed Bake feature.

## To Set the Delayed Timed Bake Feature (All upper oven, some lower oven)

The ,  and  pads control the Delayed Time Bake feature. The automatic timer of the Delayed Time Bake will turn the oven **on and off** at the time you select in advance. **Note:** If your clock is set for normal 12 hour display mode the Delayed Timed Bake or Delayed Timed Convection Bake cycle can never be set to start more than 12 hours in advance.

### To Program Oven for a Delayed Start Time and to Shut-Off Automatically (Delayed Start Bake):

1. Be sure that the clock is set with the correct time of day.
2. Arrange interior oven rack(s) and place the food in the oven.
3. Press  pad. "UPPER" or "LOWER", "BAKE" will flash and "- - -" will appear in the display.
4. Press  or  pad until the desired temperature appears. "UPPER" or "LOWER", "BAKE" will continue to flash and the desired temperature will appear in the display.
5. Wait 5 seconds, "UPPER" or "LOWER" and "BAKE" will stop flashing and remain in the display.
6. Press  pad. "UPPER" or "LOWER" and "TIMED" will start flashing and "--:--" will appear in the display.
7. Press the  or  pad until the desired baking time appears in the display.  
**Note:** Baking time can be set for any amount of time from 1 minute to 11 hours and 59 minutes.
8. Wait 5 seconds, the display will return to the time of day.
9. Press  pad. "UPPER" or "LOWER", "DELAY" start flashing and "--:--" will appear in the display.
10. Press the  or  pad until the desired start time appears in the display.
11. Wait 5 seconds, the current time of day will appear in the display.
12. When the desired start time is reached, the oven icon will appear in the display and the oven will start to bake at the previously selected temperature.

Press  pad when baking has completed or at any time to cancel the Delayed Time Bake feature.

### When the set bake time runs out:

1. "End" will appear in the display and the oven will shut off automatically.
2. The control will beep 3 times. The control will continue to beep 3 times every 30 seconds until  pad is pressed.

**CAUTION** Use caution with the Timed Bake and Delayed Start features. Foods that can easily spoil such as milk, eggs, fish, meat or poultry, should be chilled in the refrigerator first. Even when chilled, they should not stand in the oven for more than 1 hour before cooking begins, and should be removed promptly when cooking is completed.

# Setting Oven Controls

## Oven Baking

For best cooking results, heat the oven before baking cookies, breads, cakes, pies or pastries, etc... There is no need to preheat the oven for roasting meat or baking casseroles.

The cooking times and temperatures needed to bake a product may vary slightly from your previously owned appliance.

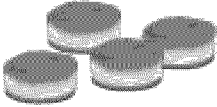
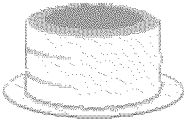
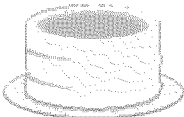
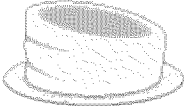
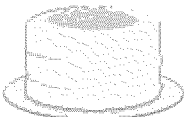
Baking Problems and Solutions Chart		
Baking Problems	Causes	Corrections
<p><b>Cookies and biscuits burn on the bottom.</b></p> 	<ul style="list-style-type: none"> <li>• Cookies and biscuits put into the oven before the preheating time is completed.</li> <li>• Oven rack overcrowded.</li> <li>• Dark pan absorbs heat too fast.</li> </ul>	<ul style="list-style-type: none"> <li>• Allow oven to preheat to the selected temperature before placing food in oven.</li> <li>• Choose pan sizes that will permit 5.1 cm to 10.2 cm (2" to 4") of air space on all sides when placed in the oven.</li> <li>• Use a medium-weight aluminum baking sheet.</li> </ul>
<p><b>Cakes too dark on top or bottom.</b></p> 	<ul style="list-style-type: none"> <li>• Cakes put into the oven before preheating time is completed.</li> <li>• Rack position too high or low.</li> <li>• Oven too hot.</li> </ul>	<ul style="list-style-type: none"> <li>• Allow oven to preheat to the selected temperature before placing food in the oven.</li> <li>• Use proper rack position for baking needs.</li> <li>• Set oven temperature 25°F/12°C lower than recommended.</li> </ul>
<p><b>Cakes not done in the center.</b></p> 	<ul style="list-style-type: none"> <li>• Oven too hot.</li> <li>• Incorrect pan size.</li> <li>• Pan not centered in oven.</li> </ul>	<ul style="list-style-type: none"> <li>• Set oven temperature 25°F/12°C lower than recommended.</li> <li>• Use pan size suggested in recipe.</li> <li>• Use proper rack position and place pan so there is 5.1 cm to 10.2 cm (2" to 4") of space on all sides of pan.</li> </ul>
<p><b>Cakes not level.</b></p> 	<ul style="list-style-type: none"> <li>• Range not level.</li> <li>• Pan too close to oven wall or rack overcrowded.</li> <li>• Pan warped.</li> </ul>	<ul style="list-style-type: none"> <li>• Place a marked glass measuring cup filled with water on the center of the oven rack. If the water level is uneven, refer to the installation instructions for leveling the range.</li> <li>• Be sure to allow 5.1 cm to 10.2 cm (2" to 4") of clearance on all sides of each pan in the oven.</li> <li>• Do not use pans that are dented or warped.</li> </ul>
<p><b>Foods not done when cooking time is up.</b></p> 	<ul style="list-style-type: none"> <li>• Oven too cool.</li> <li>• Oven overcrowded.</li> <li>• Oven door opened too frequently.</li> </ul>	<ul style="list-style-type: none"> <li>• Set oven temperature 25°F/12°C higher than suggested and bake for the recommended time.</li> <li>• Be sure to remove all pans from the oven except the ones to be used for baking.</li> <li>• Open oven door only after shortest recommended baking time.</li> </ul>

# Setting Oven Controls

## Broil

Broiling is a method of cooking tender cuts of meat by direct heat under the broil element of the oven. Be sure you center your broiler pan directly under the broil element for best results.

Arrange oven rack while oven is still cool. Position the rack as needed.

Your broiler pan and its insert allow dripping grease to drain and be kept away from the high heat of the broiler. **DO NOT** use your pan without its insert. **DO NOT cover the insert with foil.** The exposed grease could ignite.

**⚠ WARNING** Should an oven fire occur, close the oven door and turn off the oven. If the fire continues, throw baking soda on the fire or use a fire extinguisher. **DO NOT** put water or flour on the fire. Flour may be explosive and water can cause a grease fire to spread and cause personal injury.

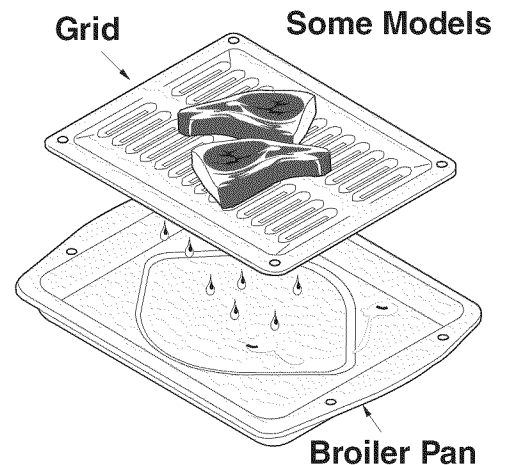

### To set the oven to broil:

1. Place your broiler pan insert on your broiler pan. Then place the food on the broiler pan insert. **DO NOT** use your broiler pan without the insert. **DO NOT** cover your broiler insert with foil. The exposed grease could ignite.
2. Arrange the interior oven rack and place your broiler pan on the rack. Be sure to center your broiler pan directly under the broiler element. **Make sure the oven door is in the broil stop position.**
3. Press **Broil** pad. "---" will appear and "**UPPER**" or "**LOWER**" and "**BROIL**" will flash in the display.
4. Press **▲** or **▼** until the desired broiling temperature appears in the display.
5. Wait 5 seconds, "**UPPER**" or "**LOWER**" and "**BROIL**" will stop flashing and the oven icon will appear in the display. The oven will begin to broil. The desired temperature will stay in the display.
6. Broil on one side until food is browned; turn and cook on the second side. Season and serve. **Note:** Always pull the rack out to the stop position before turning or removing food.
7. To cancel broiling press **STOP/CLEAR** pad.

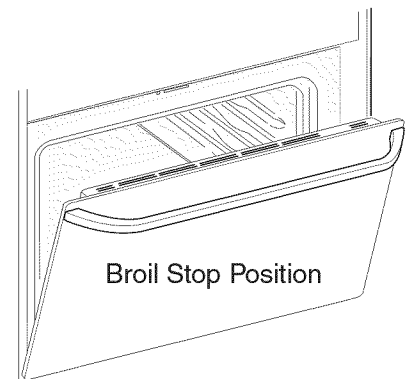

ENGLISH

## Preheating

Preheating the oven is suggested when searing rare steaks. (Remove your broiler pan before preheating. Foods will stick if placed on hot metal.) To preheat, set the control(s) to BROIL as instructed in the Owner's Guide. Wait for the element to become red-hot, usually about 2 minutes. Preheating is not necessary when broiling meats well-done.

## Determine Broiling Times

Broiling times vary, so watch the food closely. Time not only depends on the distance from element, but on the thickness and aging of meat, fat content and doneness preferred. The first side usually requires a few minutes longer than second. Frozen meats also require additional time.

### Broiler Clean-Up Tips (some models):





To make cleaning easier, line the bottom of the broiler pan with aluminum foil. **DO NOT** cover the broiler grid with foil. To prevent grease from baking on, remove the broiler pan from the oven as soon as cooking is completed. Use hot pads because the broiler pan is extremely hot. Pour off grease. Soak the pan in **HOT**, soapy water. Clean the broiler pan as soon as possible after each use. If necessary, use soap-filled steel wool pads. Heavy scouring may scratch the grid.

# Setting Oven Controls

## Setting the Warm & Hold™ Feature (All upper oven, some lower oven)



The  pad turns ON the Serve Warm & Hold feature and will maintain an oven temperature of 170° F (76°C). The **Warm & Hold** feature will keep oven baked foods warm for serving up to 3 hours after cooking has finished. After 3 hours the Warm & Hold feature will shut the oven OFF automatically. The Warm & Hold feature may be used without any other cooking operations or can be used after cooking has finished using **TIMED BAKE** or **DELAY TIMED BAKE**.

### To set Warm & Hold:

1. Arrange interior oven racks and place food in oven.
2. Press  pad. "UPPER" or "LOWER", "WARM" will flash and "HLd" will appear in the display.  
Note: If no pad is touched within 25 seconds the request to turn ON Keep Warm feature will be cancelled.
3. Press the  or  pad, "UPPER" or "LOWER", "WARM" will stop flashing, "HLd" will remain on and the oven icon will appear in the display.
4. To turn the Keep Warm OFF at any time press  pad.

**Note:** The Keep Warm feature will automatically turn OFF after 3 hours.

### To set Warm & Hold to turn ON automatically:

1. Arrange interior oven racks and place food in oven. Set the oven properly for **Timed Bake** or **Delayed Timed Bake**.
  2. Press  pad. "UPPER" or "LOWER" and "WARM" will flash and "HLd" will appear in the display.  
Note: If no pad is touched within 25 seconds the request to turn ON the Keep Warm feature and all functions previously programmed will be cleared.
  3. Press the  or  pad, "UPPER" or "LOWER" and "WARM" will stop flashing and remain in the display. Also temperature programmed will appear in the display.
  4. When the Time Bake has finished, the keep warm mode will turn ON automatically. The desired temperature, "BAKE" and "TIMED" will disappear. "HLd" will appear. "UPPER" or "LOWER" and the oven icon will remain in the display.
- Note:** The Keep Warm feature will automatically turn OFF after 3 hours.

Pressing  pad at any time will stop all oven baking operations.

### To Operate the Oven Light(s)



The interior oven light(s) will automatically turn ON when the oven door is opened.

Press  to turn the interior light(s) ON and OFF whenever the door is closed.





The interior oven light(s) is (are) located at the upper right (and left, some models) rear wall of the oven interior and is covered with a glass shield held by a wire holder. The glass shield must be in place whenever the oven is in use. To change the interior oven light(s), see changing the Oven Light in the **General Care & Cleaning** section.

# Setting Oven Controls





## To Set the Sabbath Feature (for use on the Jewish Sabbath & Holidays)



The  **COOK TIME** and  **DELAY START** pads are used to set the Sabbath feature. The Sabbath feature may only be used with the  pad. The oven temperature may be set higher or lower after setting the Sabbath feature (the oven temperature adjustment feature should be used only during Jewish Holidays), however the display will not visibly show or provide any audible tones indicating whether the change occurred correctly. Once the oven is properly set using Bake with the Sabbath feature active, the oven will remain continuously ON until cancelled. This will override the factory preset 12-Hour Energy Saving feature.

If the oven light will be needed during the Sabbath, press  before activating the Sabbath feature. Once the oven light is turned ON and the Sabbath feature is active, the oven light will remain ON until the Sabbath feature is turned OFF. If the oven light needs to be OFF, be sure to turn the oven light OFF before activating the Sabbath feature.

**IMPORTANT NOTES:** It is not advised to attempt to activate any other program feature other than **BAKE** while the Sabbath feature is active. ONLY the following key pads will function after setting the Sabbath feature; , ,  & . **ALL OTHER KEYPADS** will not function once the Sabbath feature is properly activated.



### To Program the Oven to Begin Baking Immediately & activate the Sabbath feature:

1. Be sure that the clock is set with the correct time of day.
2. Place the food in the oven.
3. Press . "---" will appear, "UPPER" or "LOWER" and "BAKE" will flash in the display.
4. Within 5 seconds, press the  or  pad until the desired temperature appears. "UPPER" or "LOWER" and "BAKE" will flash in the display.
5. Wait 5 seconds, "UPPER" or "LOWER" and "BAKE" stop flashing and the icon will appear in the display.
6. If you desire to set the oven control for a **Timed Bake** or **Delayed Start Bake** do so at this time. If not, skip this step and continue to step 6. Refer to the **Timed Bake** (complete steps 5-6) / **Delayed Start Bake** (complete steps 5-8) section for complete instructions. Remember the oven will shut down after using **Timed Bake** or **Delay Start Bake** and therefore may only be used once during the Sabbath/Jewish Holidays. The maximum **Delayed Start Bake** time is 11 hours & 59 minutes.
7. The oven will turn ON and begin heating.
8. Press and hold both the  and  pads for at least 3 seconds. **SAb** will appear in the display. Once SAb appears in the display the oven control will no longer beep when a keypad is pressed or display any further changes. The oven is properly set for the Sabbath feature.

**Note:** You may change the oven temperature once baking has started by pressing  pad, the  or  pads for the temperature you want (for Jewish Holidays only). Remember that **the oven control will no longer beep when a keypad is pressed or display any further changes** once the oven is set for the Sabbath feature.

9. The oven may be turned OFF at any time by first pressing  pad (this will turn the oven and the Sabbath feature OFF).
10. To turn off the Sabbath mode, press and hold both the  and  pads for at least 3 seconds.

Should you experience a power failure or interruption, the oven will shut off. When power is returned the oven will not turn back on automatically. If your food was nearly fully cooked, you may allow the trapped heat in the oven to finish the cooking process. Otherwise, you should remove the food when the power failure occurs, because you may only start the oven once during the Sabbath/Jewish Holidays. After the Sabbath observance turn OFF the Sabbath feature and the oven may be used with all normal functions.

After the Sabbath observance turn OFF the Sabbath feature by pressing  and . **SAb** will disappear from the display and the oven may be used with all normal functions.





For further assistance, guidelines for proper usage, and a complete list of models with the Sabbath feature, please visit the web at <http://www.star-k.org>.



## Adjusting the Oven Temperature

Your oven thermostat has been precisely set at the factory. This setting may differ from your previous oven, however, so your recipe times may not give you the results you expect. If you think that the oven is cooking too hot or cool for your recipe times, you can adjust the thermostat so that the oven cooks hotter or cooler than the temperature displayed. Note: Upper and lower oven can be adjusted independently.

### To Adjust Oven Temperature:

1. Press and hold upper or lower oven  pad for 6 seconds. The preset adjustment number will appear and "UP-PER" or "LOWER" will flash in the display.
2. To increase the temperature use the  pad to enter the desired change. The temperature may be increased as much as 35°F (19°C). To decrease the temperature use the  pad to enter the desired change. The temperature may be decreased as much as 35°F (19°C).
3. Wait 5 seconds to accept the temperature change and the display will return to the time of day. Press  pad to reject the change if necessary.

**Note:** Oven temperature adjustment made will not change the Broil and the Self-Cleaning feature temperatures.

# Self-Cleaning (All upper oven, some lower oven)

**CAUTION** During the self-cleaning cycle, the outside of the wall oven can become very hot to the touch. **DO NOT** leave small children unattended near the appliance.

**CAUTION** The health of some birds is extremely sensitive to the fumes given off during the self-clean cycle of any wall oven. Move birds to another well ventilated room.

**CAUTION** **DO NOT** line the oven walls, racks, bottom or any other part of the appliance with aluminum foil. Doing so will destroy heat distribution, produce poor baking results and cause permanent damage to the interior (aluminum foil will melt to the interior surface of the oven).

**CAUTION** **DO NOT** force the oven door open. This can damage the automatic door locking system. Use caution when opening the door after the Self-Cleaning cycle is completed. The oven may still be **VERY HOT**.



Note: See additional cleaning information for the oven door in the **General Care & Cleaning** section.

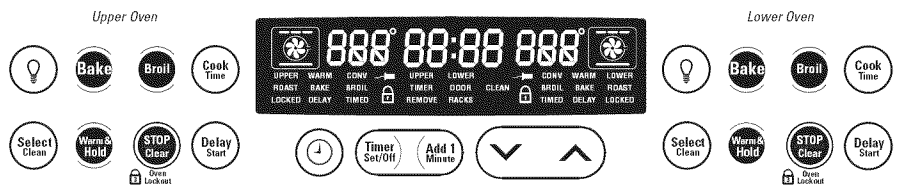

## Self-Cleaning Oven

A Self-Cleaning oven cleans itself with high temperatures (well above cooking temperatures) which eliminate soils completely or reduces them to a fine powdered ash you can wipe away with a damp cloth.

### Adhere to the following cleaning precautions:

- Allow the oven to cool before cleaning.
- Wear rubber gloves when cleaning any exterior parts of the oven manually.
- **DO NOT** clean the oven door gasket. The woven material of the oven door gasket is essential for a good seal. Care should be taken not to rub, damage or remove the gasket.
- **DO NOT** use any cleaning materials on the oven door gasket. Doing so could cause damage.
- **Remove all utensils and any aluminum foil. These items cannot withstand high cleaning temperatures.**
- This oven comes with lubricated porcelain oven racks, which can remain in the oven during the self-clean cycle. Do not clean this vegetable oil lubrication off the racks. It is important that the sides of the oven racks always have a light coating of vegetable oil. To maintain optimal rack performance, re-apply a thin layer of vegetable oil to the sides of the rack after every self-clean cycle or when the rack becomes difficult to slide.
- **Remove any excessive spillovers** in the oven cavity **before** starting the Self-Cleaning cycle. To clean, use hot, soapy water and a cloth. Large spillovers can cause heavy smoke or fire when subjected to high temperatures. **DO NOT** allow food spills with a high sugar or acid content (such as milk, tomatoes, sauerkraut, fruit juices or pie filling) to remain on the surface as they may leave a dull spot even after cleaning.
- Clean any soil from the oven frame, the door liner outside the oven door gasket and the small area at the front center of the oven bottom. These areas heat sufficiently to burn soil on. Clean with soap and water.

NOTE: Prior to setting the Self-Clean cycle, any spills remaining on the oven bottom should be removed.

Some models have an exposed Bake element in the lower oven cavity. On these models the bake element is designed to be tilted up using your hand from the front of the bake element. This will allow easier access to the oven bottom for cleaning. Be careful not to raise the element more than 4 or 5 inches from the resting position.

**CAUTION** The oven bake and broil elements may appear to have cooled after they have been turned OFF. **The elements may still be hot** and burns may occur if these elements are touched before they have cooled sufficiently.

## Self-Cleaning (All upper oven, some lower oven)

### What to Expect during Cleaning:

While the oven is in operation, the oven heats to temperatures much higher than those used in normal cooking. Sounds of metal expansion and contraction are normal. Odor is also normal as the food soil is being removed. Smoke may appear through the oven vent.







If heavy spillovers are not wiped up before cleaning, they may flame and cause more smoke and odor than usual. This is normal and safe and should not cause alarm. If available, use an exhaust fan during the self-cleaning cycle.

### Self-Clean Cycle time length

For satisfactory results, use a 2 hour Self-Clean cycle for **light soils** and a 3 hour cycle for **average** or a 4 hour cycle for **heavy soils**. **NOTE:** The kitchen area should be well ventilated using an open window, ventilation fan or exhaust hood during the Self-Clean cycle. This will help eliminate the normal odors associated with the Self-Clean cycle.

### To Set the Controls for a Self-Clean Cycle or a Delayed Start Self-Clean Cycle:

(Note: If you do not want to start a **Delayed** Self-Clean Cycle, skip steps 2 & 3.)

1. Be sure that the clock is set with the correct time of day and the oven door is closed.
2. Press . "DELAY" will flash.
3. Press and hold the  pad to scroll to the time to start the delayed Self-Clean cycle. Release the pad when the desired time is displayed.
4. Press . "— — —" appears in the display.
5. Press the  or  once. "3:00" appears in the display for a 3 hour cycle. To change to a 2 hour cycle press . "2:00" appears in the display or to select a 4 hour cycle press . "4:00" appears in the display. As soon as the controls are set, the motor driven lock will begin to close automatically and the "DOOR LOCKED" indicator light will appear. **DO NOT** open the oven door while the light is flashing (it takes about 15 seconds for the oven door to lock).
6. "CLn" will appear in the display during the Self-Clean cycle and the "DOOR LOCKED" light will glow until the Self-Cleaning cycle is complete or cancelled and the oven temperature has cooled.

### When the Self-Clean Cycle is Completed:

1. The time of day or "End" will appear in the display window and the "Clean" and "DOOR LOCKED" light will continue to glow.
2. Once the oven has cooled down for about 1 HOUR and the "DOOR LOCKED" light has gone out, the oven door can be opened.
3. If "End" is in the display and the Select Clean indicator light remains ON, press . The time of day will appear in the display.

**NOTE:** When the oven is cool, wipe away any residue or powdered ash with a damp cloth or paper towel.

### Stopping or Interrupting a Self-Cleaning Cycle

If it becomes necessary to stop or interrupt a Self-Cleaning cycle:

1. Press .
2. Once the oven has cooled down for about 1 HOUR and the "DOOR LOCKED" light has gone out, the oven door can be opened.
3. Restart the Self-Clean cycle once all conditions have been corrected.

**CAUTION** To avoid possible burns use care when opening the oven door after the Self-Cleaning cycle. Stand to the side of the oven when opening the door to allow hot air or steam to escape.

**CAUTION DO NOT** force the oven door open. This can damage the automatic door locking system. Use caution and avoid possible burns when opening the door after the Self-Cleaning cycle has completed. The oven may still be **VERY HOT**.

# General Care & Cleaning

## Cleaning Various Parts of Your Oven

Before cleaning any part of the oven, be sure all controls are turned OFF and the oven is COOL. REMOVE SPILLOVERS AND HEAVY SOILING AS SOON AS POSSIBLE. REGULAR CLEANINGS NOW WILL REDUCE THE EXTENT AND DIFFICULTY OF MAJOR CLEANING LATER.

Surfaces	How to Clean
<b>Aluminum (Trim Pieces) &amp; Vinyl</b>	Use hot, soapy water and a cloth. Dry with a clean cloth. Do not scour or use all-purpose cleaners, ammonia, powdered cleaners or commercial oven cleaner. They can scratch and discolor aluminum.
<b>Painted and Plastic Control Panel, Body Parts, and Decorative Trim</b>	<p><i>For general cleaning</i>, use hot, soapy water and a cloth. <i>For more difficult soils and built-up grease</i>, apply a liquid detergent directly onto the soil. Leave on soil for 30 to 60 minutes. Rinse with a damp cloth and dry. <b>DO NOT</b> use abrasive cleaners on any of these materials; they can scratch.</p> <p>To remove control knobs, turn to the OFF position; grasp firmly and pull straight off the shaft. To replace knobs after cleaning, line up the flat sides of both the knob and the shaft; then push the knob into place.</p>
<b>Stainless Steel, Chrome Control Panel, Decorative Trim</b>	<p><i>Before cleaning the control panel</i>, turn all controls to OFF and remove the control knobs. To remove, pull each knob straight off the shaft. Clean using hot, soapy water and a dishcloth. Rinse with a clean water using a dishcloth. Be sure to squeeze excess water from the cloth before wiping the panel; especially when wiping around the controls. Excess water in or around the controls may cause damage to the appliance. To replace knobs after cleaning, line up the flat sides of both the knob and the shaft; then push the knob into place.</p> <p>Clean <b>stainless steel</b> with hot, soapy water and a dishcloth. Rinse with clean water and a cloth. <b>Do not use cleaners with high concentrations of chlorides or chlorines.</b> Do not use harsh scrubbing cleaners. Only use kitchen cleaners that are especially made for cleaning stainless steel. Always be sure to rinse the cleaners from the surface as bluish stains may occur during heating that cannot be removed.</p>
<b>Porcelain Enamel Broiler Pan and Insert (some models), Door Liner, Body Parts</b>	Gentle scouring with a soapy scouring pad will remove most spots. Rinse with a 1:1 solution of clear water and ammonia. <i>If necessary</i> , cover difficult spots with an ammonia-soaked paper towel for 30 to 40 minutes. Rinse with clean water and a damp cloth, and then scrub with a soap-filled scouring pad. Rinse and wipe dry with a clean cloth. Remove all cleaners or the porcelain may become damaged during future heating. <b>DO NOT</b> use spray oven cleaners on the cooktop.
<b>Oven Racks</b>	<p>This oven comes with lubricated porcelain oven racks, which can remain in the oven during the self-clean cycle. Do not clean this vegetable oil lubrication off the racks. It is important that the sides of the oven racks always have a light coating of vegetable oil. To maintain optimal rack performance, re-apply a thin layer of vegetable oil to the sides of the rack after every self-clean cycle or when the rack becomes difficult to slide.</p> <p>For some models with chrome oven racks, clean by using a mild, abrasive cleaner following manufacturer's instructions. Rinse with clean water and dry.</p>
<b>Oven Door</b>	<p>Use soap &amp; water to thoroughly clean the top, sides and front of the oven door. Rinse well. You may use a glass cleaner on the outside glass of the oven door. <b>DO NOT</b> immerse the door in water. <b>DO NOT spray or allow water or the glass cleaner to enter the door vents.</b> <b>DO NOT</b> use oven cleaners, cleaning powders or any harsh abrasive cleaning materials on the outside of the oven door.</p> <p><b>DO NOT</b> clean the oven door gasket. The oven door gasket is made of a woven material, on Self-Cleaning models, which is essential for a good seal. Care should be taken not to rub, damage or remove this gasket.</p>

ENGLISH

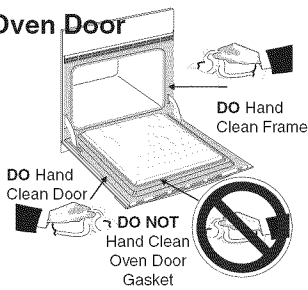
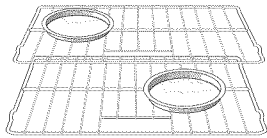

## General Care & Cleaning

### Cleaning the Porcelain Enamel Oven (Manual Clean Oven Only)

Porcelain has a smooth finish and is a type of glass fused to metal. Oven cleaners can be used on all interior oven surfaces.

REMOVE SPILLOVERS AND HEAVY SOILING AS SOON AS POSSIBLE.

**REGULAR CLEANINGS NOW WILL REDUCE THE EXTENT AND DIFFICULTY MAJOR CLEANING LATER.**

#### Adhere to the following cleaning precautions:

- Allow the oven to cool before cleaning.
- Wear rubber gloves when cleaning the appliance manually.

#### General Cleaning

Remove soils using hot, soapy water. Do not allow food spills with a high sugar or acid content (such as milk, tomatoes, sauerkraut, fruit juices or pie filling) to remain on the surface as they may cause a dull spot even after cleaning.

#### To Remove Heavy Soil

1. Allow a dish of ammonia to sit in the oven overnight or for several hours with the oven door closed. Clean softened spots using hot, soapy water. Rinse well with water and a clean cloth.
2. If soil remains, use a soap-filled scouring pad or a nonabrasive cleaner. If necessary, use an oven cleaner following manufacturer's instructions.

**⚠ CAUTION DO NOT** mix ammonia with other cleaners.

#### Adhere to the following precautions when using oven cleaners:

1. **DO NOT** spray on the electrical controls or switches because it could cause a short circuit and result in sparking or fire.
2. **DO NOT** allow a film from the cleaner to build up on the temperature sensing bulb; it could cause the oven to heat improperly. (The bulb is located in the rear of the oven.) Carefully wipe the bulb clean after each oven cleaning, being careful not to move the bulb. A change in its position could affect how the oven bakes. Avoid bending the bulb and capillary tube.
3. **DO NOT** spray any cleaner on the oven door trim or gasket, handles or any exterior surfaces of the appliance, wood or painted surfaces. The cleaner can damage these surfaces.

#### To Clean the Oven Bottom

Clean using hot, soapy water, a mild abrasive cleanser, a soap-filled abrasive pad or oven cleaner following manufacturer's instructions.

**⚠ CAUTION** Ammonia must be rinsed from all surfaces before operating the oven. Provide adequate ventilation.

**⚠ CAUTION DO NOT** line the oven walls, bottom, racks or any other part of the appliance with aluminum foil. Doing so will destroy heat distribution, produce poor baking results and cause permanent damage to the oven interior (aluminum foil will melt to the interior surface of the oven).

### Care and Cleaning of Stainless Steel (some models)

Some models are equipped with stainless steel exterior parts. Special care and cleaning are **required** for maintaining the appearance of stainless steel parts. Please refer to the table provided at beginning of the **Care & Cleaning** section in this Use & Care Manual.

# General Care & Cleaning

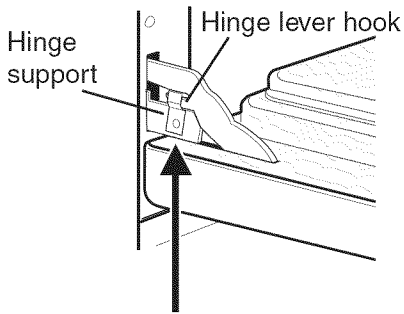

Lock engaged for door removal  
Figure 1

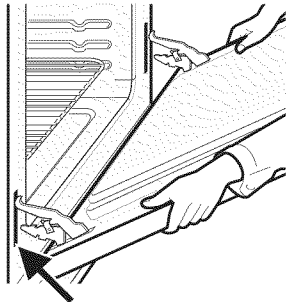

HINGE SLOT - Door removed  
from the oven  
Figure 2

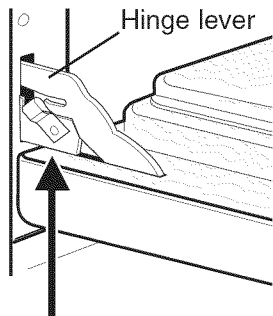

Lock in normal position  
Figure 3

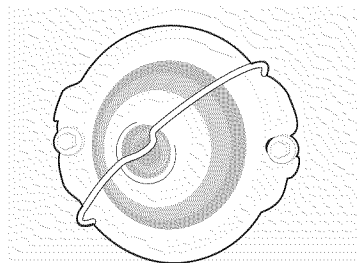

## Removing and Replacing the Oven Door

**CAUTION** The door is heavy. For safe, temporary storage, lay the door flat with the inside of the door facing down.

### To Remove Oven Door:

1. Open the door to the fully opened position.
2. Pull up the lock located on both hinge supports and engage it in the hinge lever hooks (Figure 1). You may have to apply a little downward pressure on the door to pull the locks fully over the hinge lever hooks.
3. Grab the door by the sides, and pull the bottom of the door up and toward you to disengage the hinge supports. Keep pulling the bottom of the door toward you while rotating the top of the door toward the range to completely disengage the hinge levers (Figure 2).
4. To clean oven door, follow the instructions provided in the **General Care & Cleaning** table.

### To Replace Oven Door:

1. Grab the door by the sides; place the hinge supports in the hinge slots. Open the door to the fully opened position.
2. Disengage the lock from the hinge lever hooks on both sides (Figure 3).  
Note: Make sure the hinge supports are fully engaged before unlocking the hinge levers.
3. Close the oven door.

## Special Door Care Instructions

Most oven doors contain glass that can break.

Read the following recommendations:

1. Do not close the oven door until all the oven racks are fully in place.
2. Do not hit the glass with pots, pans, or any other object.
3. Scratching, hitting, jarring or stressing the glass may weaken its structure causing an increased risk of breakage at a later time.

## Changing the Oven Light

On some models an interior oven light will turn automatically when the oven door is opened. The oven light may be turned on when the door is closed by

pushing  located on the control panel. On some models, the lamp is covered with a glass shield held in place by a wire holder. **THE GLASS SHIELD MUST BE IN PLACE WHENEVER THE OVEN IS IN USE.**

### To replace the light bulb:

**CAUTION: BE SURE THE OVEN IS COOL.**

1. Turn the power off at the main source.
2. Wear a leather-faced glove for protection against possible broken glass.
3. Replace bulb with 40-watt appliance bulb only.
4. For models with glass shield, press holder on one side to release glass shield, change bulb and be sure to replace the glass shield.

# Before You Call

## Solutions to Common Problems

**Before you call for service**, review this list. It may save you time and expense. The list includes common occurrences that are not the result of defective workmanship or materials in this appliance.

OCCURRENCE	POSSIBLE CAUSE/SOLUTION
<b>Oven Control Beeps and Displays any F code error (example F11).</b>	Electronic control has detected a fault condition. Press <b>STOP/CLEAR</b> to clear the display and stop beeping. Reprogram the oven. If a fault reoccurs, record the fault number. Press <b>STOP/CLEAR</b> and call Sears or another qualified servicer.
<b>-door- is displayed.</b>	The door was left open and controls set for self-cleaning cycle. Close the door.
<b>Installation.</b>	Place oven rack in center of oven. Place a level on the oven rack. Contact installing agent if rack and cabinet cutout flooring are not level.
	Kitchen cabinet misalignment may make oven appear to be not level. Be sure cabinets are square and level. Contact cabinet maker to correct problem.
<b>Entire oven does not operate.</b>	When the oven is first plugged in, or when the power supply to the oven has been interrupted, the display will flash. The oven cannot be programmed until the clock is set.
	Be sure electrical cord is securely connected into the electrical junction box.
	Cord/plug is not installed and/or connected. Cord is not supplied with oven. Contact Sears or another qualified servicer.
	Service wiring not complete. Contact Sears or another qualified servicer.
	Power outage. Check house lights to be sure. Call your local electric company.
	Short in cord/plug. Replace cord/plug.
	Controls are not set properly. See instructions under <b>Setting Oven Controls</b> to set the controls.
	House fuse has blown or circuit breaker has tripped immediately following installation. House fuse may not be fully engaged. Check fuse and screw or engage circuit breaker securely.
	House fuse has blown or circuit breaker has tripped after the oven has been installed and previously operating. Call Sears or another qualified servicer.
<b>Oven light does not work.</b>	Burned-out or loose bulb. Follow the instructions under <b>Changing Oven Light</b> to replace or tighten the bulb.
<b>Fan noise during cooking operation.</b>	A cooling fan may automatically turn on and off to cool internal parts. This is normal, and the fan may continue to run even after oven is turned off.



## Before You Call

### Solutions to Common Problems

OCCURRENCE	POSSIBLE CAUSE / SOLUTION
<b>Oven smokes excessively during broiling.</b>	Oven door is closed. Door should be open during broiling.
	Meat too close to the broiler unit. Reposition the rack to provide more clearance between the meat and the broiler. Preheat broil element for quick searing operation.
	Meat not properly prepared. Remove excess fat from meat. Slash remaining fatty edges to prevent curling, but do not cut into the lean.
	Grid on your broiler pan wrong side-up. Grease does not drain into broiler pan. Always place the grid on your broiler pan with the ribs up and the slots down to allow grease to drip into the pan.
	Broiler pan used without grid or grid cover with foil. <b>DO NOT</b> use your broiler pan without the grid or cover the grid with foil.
	Oven needs to be cleaned. Grease has built up on oven surfaces. Regular cleaning is necessary when broiling frequently. Old grease or food spatters cause excessive smoking.
<b>Poor baking results.</b>	Many factors affect baking results. See <b>Baking</b> for hints, causes and corrections. See <b>Adjusting Oven Temperature</b> .
<b>Self-cleaning cycle does not work.</b>	Make sure the oven door is closed.
	Controls not set properly. Follow instructions.
	Self-cleaning cycle was interrupted. Stop time must be set 2-4 hours past the start time. Follow steps under "Stopping or Interrupting a Self-Cleaning Cycle" in this Use & Care Guide.
<b>Soil not completely removed after self-cleaning cycle is completed.</b>	On a dual cavity model, one oven is in operation. If one oven is set for any mode, the second oven cannot be set to <b>CLEAN</b> .
	Failure to hand clean frame of oven or door area outside oven seal. These areas are not in the self-cleaning area, but get not enough to burn on residue. Clean these areas before the self-cleaning cycle is started. Burned on residue can be cleaned with a stiff nylon brush and water or a nylon scrubber. Do not clean the oven door gasket or it will be damaged.
	Excessive spillovers in oven. Set the self-clean cycle for longer cleaning time.
<b>Flames inside oven or smoke from vent.</b>	Excessive spillovers in oven. This is normal, especially for high oven temperatures, pie spillovers or for large amounts of grease on bottom of oven. Wipe up excessive spillovers.

# Get it fixed, at your home or ours!

## Your Home

For expert troubleshooting and home solutions advice:

**manage my home**

[www.managemyhome.com](http://www.managemyhome.com)

For repair – **in your home** – of **all** major brand appliances, lawn and garden equipment, or heating and cooling systems, **no matter who made it, no matter who sold it!**

For the replacement parts, accessories and owner's manuals that you need to do-it-yourself.

For Sears professional installation of home appliances and items like garage door openers and water heaters.

**1-800-4-MY-HOME<sup>®</sup>** (1-800-469-4663)

Call anytime, day or night (U.S.A. and Canada)

[www.sears.com](http://www.sears.com)    [www.sears.ca](http://www.sears.ca)

## Our Home

For repair of carry-in items like vacuums, lawn equipment, and electronics, call anytime for the location of your nearest

**Sears Parts & Repair Service Center**

**1-800-488-1222** (U.S.A.)

[www.sears.com](http://www.sears.com)

**1-800-469-4663** (Canada)

[www.sears.ca](http://www.sears.ca)

To purchase a protection agreement on a product serviced by Sears:

**1-800-827-6655** (U.S.A.)

**1-800-361-6665** (Canada)

Para pedir servicio de reparación a domicilio, y para ordenar piezas:

**1-888-SU-HOGAR<sup>®</sup>**

(1-888-784-6427)

Au Canada pour service en français:

**1-800-LE-FOYER<sup>MC</sup>**

(1-800-533-6937)

[www.sears.ca](http://www.sears.ca)

**Sears**

## Free Manuals Download Website

<http://myh66.com>

<http://usermanuals.us>

<http://www.somanuals.com>

<http://www.4manuals.cc>

<http://www.manual-lib.com>

<http://www.404manual.com>

<http://www.luxmanual.com>

<http://aubethermostatmanual.com>

Golf course search by state

<http://golfingnear.com>

Email search by domain

<http://emailbydomain.com>

Auto manuals search

<http://auto.somanuals.com>

TV manuals search

<http://tv.somanuals.com>