

Use & Care Guide
Manuel d'utilisation et d'entretien
English / Français



Models/Modèles: 253.25001, 253.25002, 253.25003

Kenmore®

Dehumidifier

Déshumidificateur

P/N 2020264A0337

Sears Brands Management Corporation
Hoffman Estates, IL 60179 U.S.A.

www.kenmore.com
www.sears.com



TABLE OF CONTENTS

Warranty	2	Removing Collected Water	7-8
Master Protection Agreements	3	Care and Cleaning	9
Important Safety Instructions	4	Power Cord Storage	9
Location	4	Troubleshooting Guide	10
How It Works	4	Sears Service.....	11
Dehumidifer Feature	5-7		

Kenmore Limited Warranty

When installed, operated and maintained according to all supplied instructions, if this product fails due to a defect in material and workmanship within one year from the date of purchase, call 1-800-4-MY-HOME® to arrange for free repair.

If the sealed refrigerant system of this product is defective within five years from the purchase date, call 1-800-4-MY-HOME® to arrange for free repair.

All warranty coverage applies for only 90 days from the date of purchase if this product is ever used for other than private family purposes.

This warranty covers only defects in material and workmanship. Sears will NOT pay for:

1. Expendable items that can wear out from normal use, including but not limited to filters, belts, light bulbs, and bags.
2. A service technician to instruct the user in correct product installation, operation or maintenance.
3. A service technician to clean or maintain this product.
4. Damage to or failure of this product if it is not installed, operated or maintained according to the all instructions supplied with the product.
5. Damage to or failure of this product resulting from accident, abuse, misuse or use for other than its intended purpose.
6. Damage to or failure of this product caused by the use of detergents, cleaners, chemicals or utensils other than those recommended in all instructions supplied with the product.
7. Damage to or failure of parts or systems resulting from unauthorized modifications made to this product.

Disclaimer of implied warranties; limitation of remedies

Customer's sole and exclusive remedy under this limited warranty shall be product repair as provided herein. Implied warranties, including warranties of merchantability or fitness for a particular purpose, are limited to one year or the shortest period allowed by law. Sears shall not be liable for incidental or consequential damages. Some states and provinces do not allow the exclusion or limitation of incidental or consequential damages, or limitation on the duration of implied warranties of merchantability or fitness, so these exclusions or limitations may not apply to you.

This warranty applies only while this appliance is used in the United States or Canada. This warranty gives you specific legal rights, and you may also have other rights which vary from state to state.

Sears Brands Management Corporation, Hoffman Estates, IL 60179

Sears Canada Inc., Toronto, Ontario, Canada M5B 2B8

Master Protection Agreements

Congratulations on making a smart purchase. Your new Kenmore® product is designed and manufactured for years of dependable operation. But like all products, it may require preventive maintenance or repair from time to time. That's when having a Master Protection Agreement can save you money and aggravation.

The Master Protection Agreement also helps extend the life of your new product. Here's what the Agreement * includes:

- ☑ **Parts and labor** needed to help keep products operating properly **under normal use**, not just defects. Our coverage goes **well beyond the product warranty**. No deductibles, no functional failure excluded from coverage — real protection.
- ☑ **Expert service** by a force of more than **10,000 authorized Sears service technicians**, which means someone you can trust will be working on your product.
- ☑ **Unlimited service calls and nationwide service**, as often as you want us, whenever you want us.
- ☑ **"No-lemon" guarantee** — replacement of your covered product if four or more product failures occur within twelve months.
- ☑ **Product replacement** if your covered product can't be fixed.
- ☑ **Annual Preventive Maintenance Check** at your request — no extra charge.
- ☑ **Fast help by phone** — we call it **Rapid Resolution** — phone support from a Sears representative on all products.
- ☑ Think of us as a "talking owner's manual."
- ☑ **Power surge protection** against electrical damage due to power fluctuations.
- ☑ **\$250 Food Loss Protection** annually for any food spoilage that is the result of mechanical failure of any covered refrigerator or freezer.
- ☑ **Rental reimbursement** if repair of your covered product takes longer than promised.
- ☑ **10% discount** off the regular price of any non-covered repair service and related installed parts.

Once you purchase the Agreement, a simple phone call is all that it takes for you to schedule service. You can call anytime day or night, or schedule a service appointment online.

The Master Protection Agreement is a risk free purchase. If you cancel for any reason during the product warranty period, we will provide a full refund. Or, a prorated refund anytime after the product warranty period expires. Purchase your Master Protection Agreement today!

Some limitations and exclusions apply. For prices and additional information in the U.S.A. call 1-800-827-6655.

*** Coverage in Canada varies on some items. For full details call Sears Canada at 1-800-361-6665.**

Sears Installation Service

For Sears professional installation of home appliances, garage door openers, water heaters, and other major home items, in the U.S.A. or Canada call **1-800-4-MY-HOME®**.

Read and Save These Instructions

This Use & Care Guide provides specific operating instructions for your model. Use the air conditioner only as instructed in this guide. These instructions are not meant to cover every possible condition and situation that may occur. Common sense and caution must be practiced when installing, operating, and maintaining any appliance.

Record Your Model and Serial Numbers

Record in the space provided below the model and serial numbers. The serial plate is located on the outside of the cabinet, or behind filter at the bottom of unit. Reading the numbers may be easier by using a flashlight or by removing the cabinet front as instructed under "Care and Cleaning."

Model Number : _____

Serial Number : _____

Purchase Date : _____

Important Safety Instructions

NOTE This USE & CARE GUIDE provides specific operating instructions for your model. Use the dehumidifier only as instructed in this USE & CARE GUIDE. These instructions are not meant to cover every possible condition and situation that may occur. Common sense and caution must be practiced when installing, operating, and maintaining any appliance.

WARNING Avoid fire hazard or electric shock. Do not use an extension cord or an adaptor plug. Do not remove any prong from the power cord.

Grounding type wall receptacle

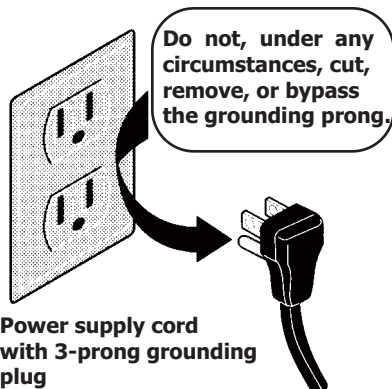

Read all instructions before using this dehumidifier.

WARNING For Your Safety

- * Do not store or use gasoline or other flammable vapors and liquids in the vicinity of this or any other appliance. Read product labels for flammability and other warnings.
- * Discard water from bucket. Water is not potable and cannot be used for drinking.

WARNING Child Safety Precautions

- * Destroy the carton, plastic bags, and any packing materials immediately after the dehumidifier is unpacked. Children should never use these items for play.
- * Do not leave children unattended in an area where the appliance is operating.
- * Do not allow them to sit or stand on the appliance.

WARNING Electrical Information

- * For your safety and protection, this dehumidifier is equipped with a three-prong grounding plug on the power cord. Do not, under any circumstances, cut or remove the round ground prong from the plug.
- * Your dehumidifier must be plugged directly into a properly grounded and polarized three-prong receptacle. If the wall receptacle you intend to use will not accept a three-prong plug, or if you are not sure the outlet is adequately grounded or protected by a time delay fuse or circuit breaker, have a qualified electrician install the proper outlet according to the National Electrical Code and applicable local codes and ordinances. Do not use an extension cord or an adapter plug.
- * Never unplug the dehumidifier by pulling on the power cord. Always grip the plug firmly and pull straight out from the receptacle.
- * Do not pinch, bend, or knot the power cord.

Location

Selecting a Location

IMPORTANT:

1. Dehumidifier must be operated in an enclosed area to be most effective. Close all doors, windows, and other outside openings to the room. The effectiveness of the dehumidifier depends on the rate at which new moisture-laden air enters the room.
2. Place dehumidifier in a location that does not restrict airflow through the front of the unit or out of the louvers on the left side of cabinet.
3. A dehumidifier operating in a basement will have little or no effect in drying an adjacent enclosed storage area, such as a closet, unless there is adequate circulation of air in and out of the area. It may be necessary to install a second dehumidifier in the enclosed area for satisfactory drying.
4. The dehumidifier must be installed on a level floor that will support it with a full bucket of water.
5. There should be a minimum of 30.5cm clearance around the dehumidifier.

How It Works

When the unit is started, the fan begins to pull moisture-laden air across the dehumidifying coils.

The coils condense or draw moisture from the air, and air flows through the side louvers into the room as dry, warm air. Moisture removed from air is collected in a bucket on the front of the dehumidifier.

The unit is designed to operate between 5 °C (41 °F), and 35 °C (96 °F).

The "Compressor" circuit has an automatic 3 minute time delayed start if the unit is turned off and on quickly. This prevents overheating of the compressor and possible circuit breaker tripping. Make sure the tank is fitted correctly otherwise unit will not turn on.

Dehumidifier Feature

**Allow the unit to reach room temperature before operating.
To begin operating the dehumidifier, follow these steps:**

NOTE: Unit must be upright for one hour prior to operating.

1. Plug the power cord into a properly grounded 115 volt AC outlet. The POWER indicators will illuminate.

NOTE: If the "BUCKET FULL" light is on, remove the bucket and reinstall it to reset the float switch.

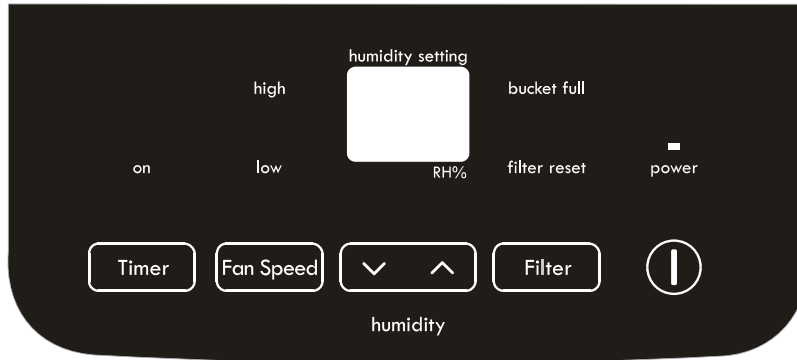

2. To turn the unit on, press the ON/OFF button. The unit will run in the factory setting of CONTINUOUS and high fan speed. In the Continuous Mode the unit will only display CO and not the room humidity. It is recommended you leave the unit running in the CONTINUOUS setting for the first three or four days until the sweating and dampness odors have stopped.

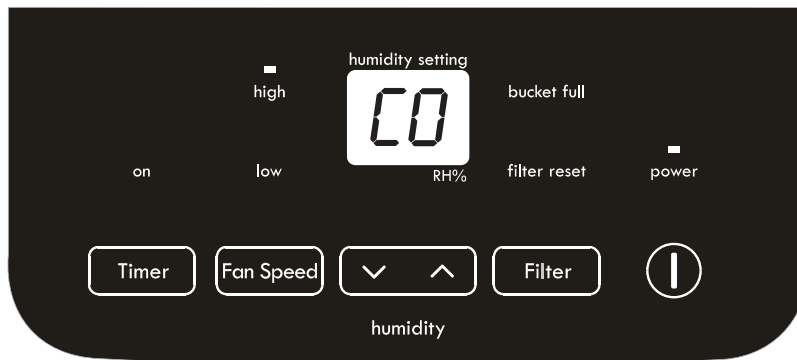

3. After a few days, when the Relative Humidity has declined, press the HUMIDITY + or - buttons to choose a value between 35% to 85%, so the room is kept at a comfortable concentration. Pressing the + or - buttons will change the humidity selection in 5% increments. After you have set the desired humidity, the readout will display the actual room humidity. If at any time you want to return to the CONTINUOUS Mode, pressing the HUMIDITY - button will lower the Relative Humidity through the 5% increments until the display reads CO.

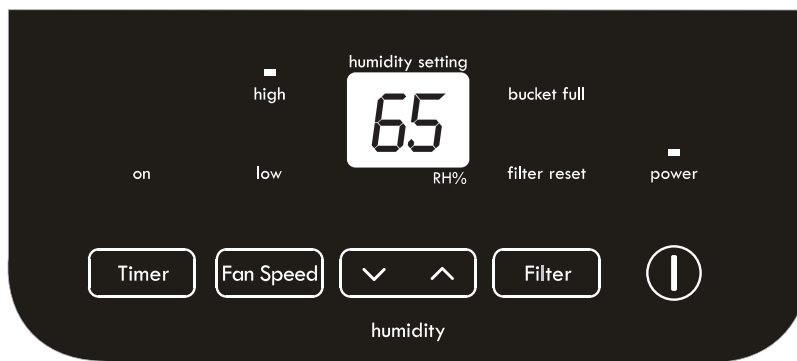

Dehumidifier Feature (continued)

4. You can also use the FAN SPEED button to change the fan speed to HIGH or LOW. The indicator light will show the setting you have selected. A higher fan speed will result in quicker moisture removal.

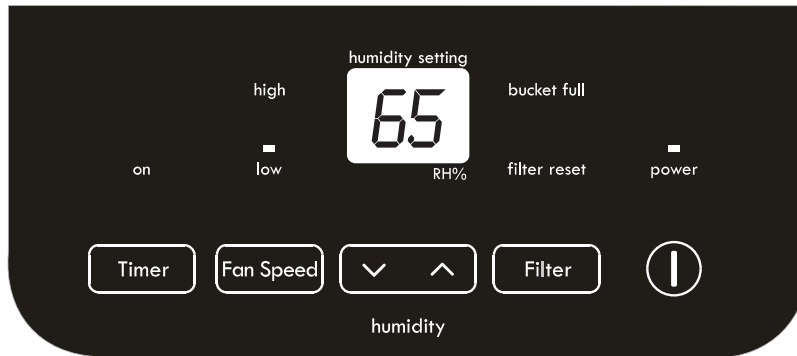

5. The FILTER RESET light will illuminate after 250 hours of operation. At this time, refer to the "Care and Cleaning section to remove and clean the filter. Once the filter has been cleaned, simply press the FILTER button to extinguish the light.

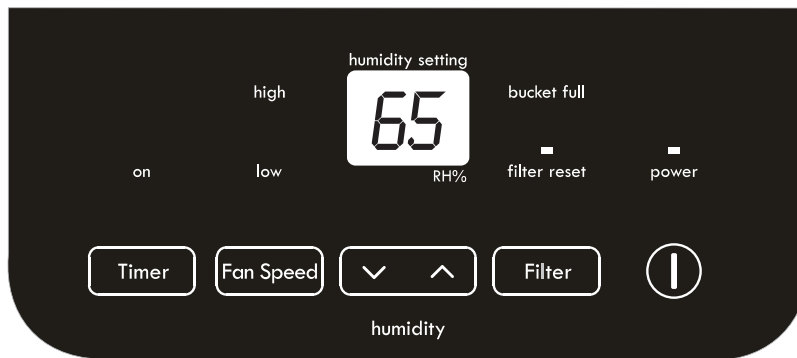

6. The TIMER function enables you to either Delay Start or Delay Stop the unit in the choice from 0.5 hour to 24 hours. If the unit is running, then selecting Timer will turn the unit off after setting hours (Delay Stop). If the unit is off, then selecting Timer will turn the unit on after setting hours (Delay Start).

TIMER setting: First press TIMER button, then to adjust timer setting, tap or hold the + or - button to change the delay timer at 0.5 hour increments, up to 10 hours, then by 1 hour increments up to 24 hours. The control will count down the time remaining (8,7.5,7, etc.) until the unit either starts or stops. For the Delay Start, the fan speed and humidity maintained will be the same as previous setting. After TIMER setting finishes, pressing TIMER button again at any time will cancel the

TIMER function. The Delay Start/Stop Feature will work until the unit either starts or stops. Once that happens, the above steps will have to be repeated again.

- NOTE: 1. Before entering TIMER setting, the power indicator must be lit to make sure power is being supplied to the unit.
2. Before entering TIMER setting, make sure first pressing HUMIDITY + or - button sets one desired room humidity.

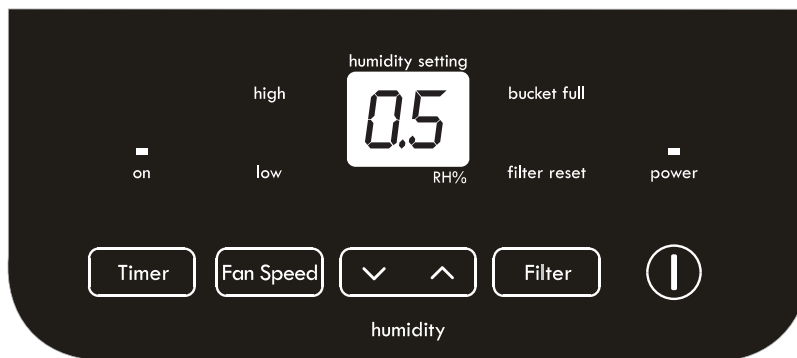

Dehumidifier Feature

(continued)

7. To shut the unit down, press the ON/OFF button.

NOTE: While the unit is plugged in, the power indicator will remain lit. Only removing the plug will extinguish this light.

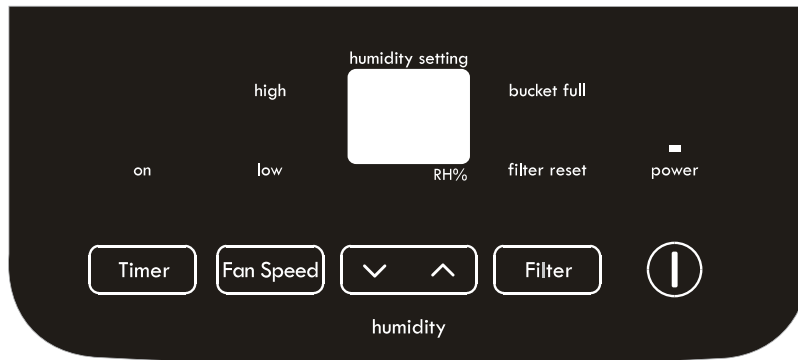

Fault Codes

If the display reads "AS" or "ES", a sensor has failed. Contact 1-800-4-MY-HOME® for repair.

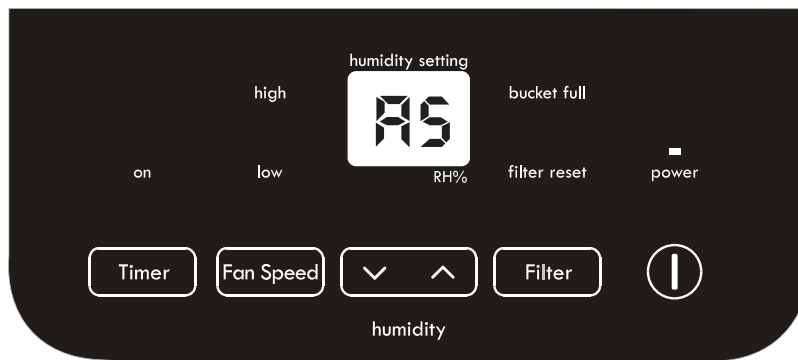

Removing Collected Water

Removing Collected Water

1. Emptying the bucket:

- a. When the bucket is full, the unit will shut down and the BUCKET FULL indicator light will illuminate.

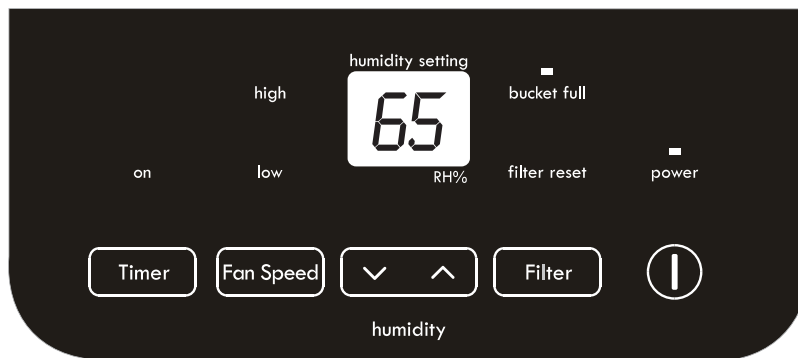

Removing Collected Water (continued)

- b. Do not move the unit at this point, otherwise water may spill on the floor.
- c. Press sides of bucket gently to unclip the bucket from the unit.
- d. Remove the bucket as shown in the photographs below and empty the bucket.

WARNING: Discard water from bucket. Water is not potable and cannot be used for drinking.

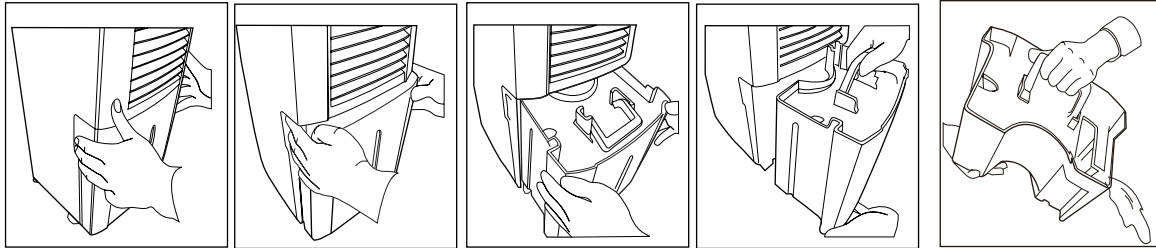

- e. Replace the empty bucket back into the unit and once seated correctly, the unit will start up again.
- f. You should hear a click when the bucket is in the correct position

If the bucket full light does not extinguish, check that the float is correctly snapped in place as indicated by the diagram.

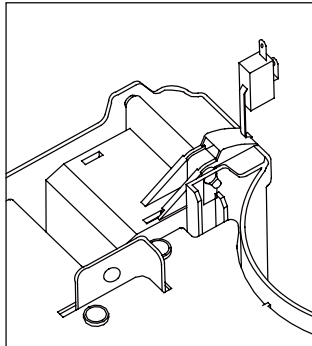

2. Continuous Drainage:

- a. For constant drainage operation, you will need a garden hose and a drain nearby to discharge the water into.
- b. Remove the bucket from the unit and set aside.
- c. Lift up the side flap located on the right side of the unit as looking from the front. (fig.1)
- d. Insert the female threaded end of the hose through the opening. (fig.2)
- e. Screw the garden hose onto the threaded portion of the tray underneath the bucket opening. (fig.3)
- f. Make sure the hose is secure so there are no leaks.
- g. Direct the hose toward the drain, making sure that there are no kinks that will stop the water flowing.
- h. Place the end of the hose into the drain.
- i. Place the bucket back in the unit and make sure that it is located correctly. (fig.4)
- j. Select the desired humidity setting and fan speed on the unit for continuous draining to start.

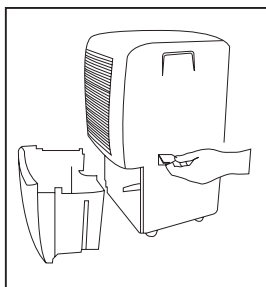

fig. 1

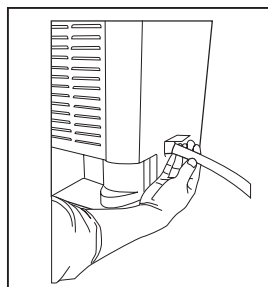

fig. 2

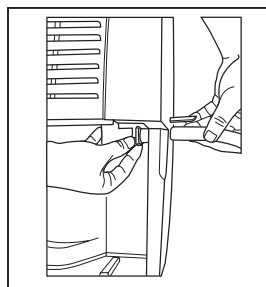

fig. 3

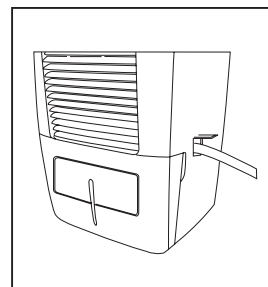
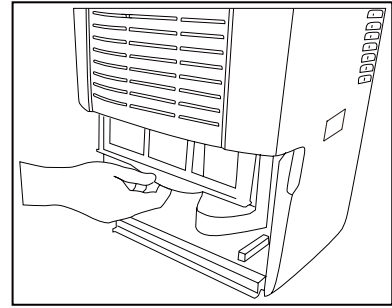

fig. 4

NOTE: If the unit stops operating, check if the bucket full light is illuminated. If it is, remove the bucket, and empty the contents and then check the seal between the hose and the drip tray. If there is a small leak, then replace the hose gasket and re-tighten the hose.

Care and Cleaning

1. Filter
 - a. Clean the filter every two weeks based on normal operating conditions.
 - b. To remove the filter, remove bucket then pull filter downwards.
 - c. Wash the filter with clean water then dry.
 - d. Reinstall the filter, then replace bucket.
2. Cabinet
 - a. Dust cabinet with an oil-free cloth, or using a damp cloth.
 - b. Vacuum grill using brush attachment.
3. Water Bucket
 - a. Clean bucket with warm water and detergent.



Power Cord Storage

When unit is not in use, unplug and use the cord wrap shown for your model type.

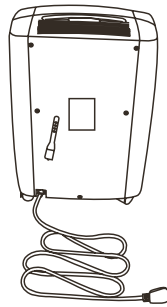
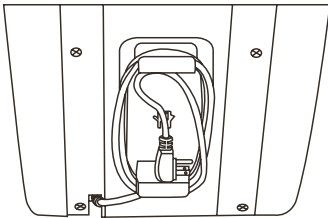

1.

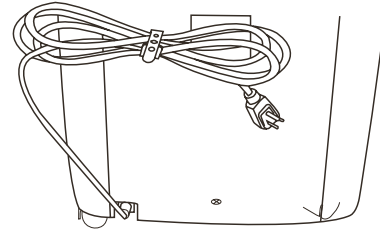

2.



Dehumidifier Troubleshooting Guide

DEHUMIDIFIER DOES NOT OPERATE.

Check if ...	Then ...
Wall plug disconnected.	Push plug firmly into wall outlet.
House fuse blown or circuit breaker tripped.	Replace fuse with time delay type or reset circuit breaker.
The dryness level you selected has been reached.	Dehumidifier automatically shuts off when selected amount of moisture has been removed from the air. If you want to remove more moisture, select 'CONTINUOUS' by using the humidity button or knob. After the dehumidifier starts, reset the control to the desired setting.
Bucket not installed properly.	Reinstall the bucket properly. See "Removing Collected Water" for reference.
Water in the bucket has reached its preset level.	Empty bucket and return bucket to position.
Dehumidifier is not turned on.	Turn unit on.
"BUCKET FULL" light is on.	Remove bucket, empty water and reinstall it correctly.

DEHUMIDIFIER RUNS TOO MUCH.

Check if ...	Then ...
Windows or doors near dehumidifier are open to outdoors.	Close all windows or doors to outside.
Area to be dehumidified is too large.	Check with your dealer to see if capacity is adequate.
Air movement through dehumidifier is blocked.	Dehumidifier must be placed in a space that does not restrict air flowing into the rear coil and out of the front grill.
Grill may be dirty.	Use brush attachment of vacuum cleaner to clean grill. See "Care and Cleaning" for reference.
Dehumidifier is in the CONT mode and will remain in this mode .	Use the humidity button or knob to set a RH% higher level.

DEHUMIDIFIER IS OPERATING BUT ROOM IS NOT DRY ENOUGH.

Check if ...	Then ...
Humidity setting is too high.	Press the HUMIDITY button or rotate knob to a lower setting to choose CONTINUOUS for maximum dryness.
Dehumidifier has been installed or restarted recently.	The higher the moisture in the room air is, the longer it will take to dry the room air.
Dehumidifier does not have sufficient clearance to operate, or air flow to front grill is blocked.	See "Selecting a Location" to select a proper location.
Room temperature is too low.	Unit will not operate satisfactorily if the room temperature is below 5 °C(41 °F). See "How It Works" for reference.
Dehumidifier runs too much.	Refer to some of the causes under DEHUMIDIFIER RUNS TOO MUCH.

FROST APPEARS ON COILS ABOVE BUCKET OR DRIP TRAY.

Check if ...	Then ...
Dehumidifier has been turned on recently.	This is normal due to refrigerant rushing through the coil. Frost will usually disappear within 60 minutes.
Room Temperature is too low.	All models will operate satisfactorily at temperatures higher than 5 °C (41 °F).

FAN NOISE.

Check if ...	Then ...
Air is moving through the dehumidifier.	This is a normal sound.

Get it fixed, at your home or ours!

Your Home

For troubleshooting, product manuals and expert advice:



www.managemylife.com

For repair – **in your home** – of **all** major brand appliances, lawn and garden equipment, or heating and cooling systems, **no matter who made it, no matter who sold it!**

For the replacement parts, accessories and owner's manuals that you need to do-it-yourself.

For Sears professional installation of home appliances and items like garage door openers and water heaters.

1-800-4-MY-HOME[®] (1-800-469-4663)

Call anytime, day or night (U.S.A. and Canada)

www.sears.com www.sears.ca

Our Home

For repair of carry-in items like vacuums, lawn equipment, and electronics, call anytime for the location of your nearest

Sears Parts & Repair Service Center

1-800-488-1222 (U.S.A.)

www.sears.com

1-800-469-4663 (Canada)

www.sears.ca

To purchase a protection agreement on a product serviced by Sears:

1-800-827-6655 (U.S.A.)

1-800-361-6665 (Canada)

Para pedir servicio de reparación a domicilio, y para ordenar piezas:

1-888-SU-HOGAR[®]

(1-888-784-6427)

www.sears.com

Au Canada pour service en français:

1-800-LE-FOYER^{MC}

(1-800-533-6937)

www.sears.ca

The Sears logo, featuring the word "Sears" in a large, stylized, serif font with a shadow effect.

© Registered Trademark / TM Trademark of KCD IP, LLC in the United States, or Sears Brands, LLC in other countries

© Marca Registrada / TM Marca de Fábrica de KCD IP, LLC en Estados Unidos, o Sears Brands, LLC in otros países

^{MC} Marque de commerce / ^{MD} Marque déposée de Sears Brands, LLC

Free Manuals Download Website

<http://myh66.com>

<http://usermanuals.us>

<http://www.somanuals.com>

<http://www.4manuals.cc>

<http://www.manual-lib.com>

<http://www.404manual.com>

<http://www.luxmanual.com>

<http://aubethermostatmanual.com>

Golf course search by state

<http://golfingnear.com>

Email search by domain

<http://emailbydomain.com>

Auto manuals search

<http://auto.somanuals.com>

TV manuals search

<http://tv.somanuals.com>