



# Ultra Wash Dishwasher

## Use & Care Guide

Table of Contents ..... 1 (English section)

# Lavavajillas Ultra Wash

## Manual de uso y cuidado

Índice ..... 1 (Sección en Español)

# Lave-vaisselle Ultra Wash

## Guide d'utilisation et d'entretien

Table des matières ..... 1 (Section Française)

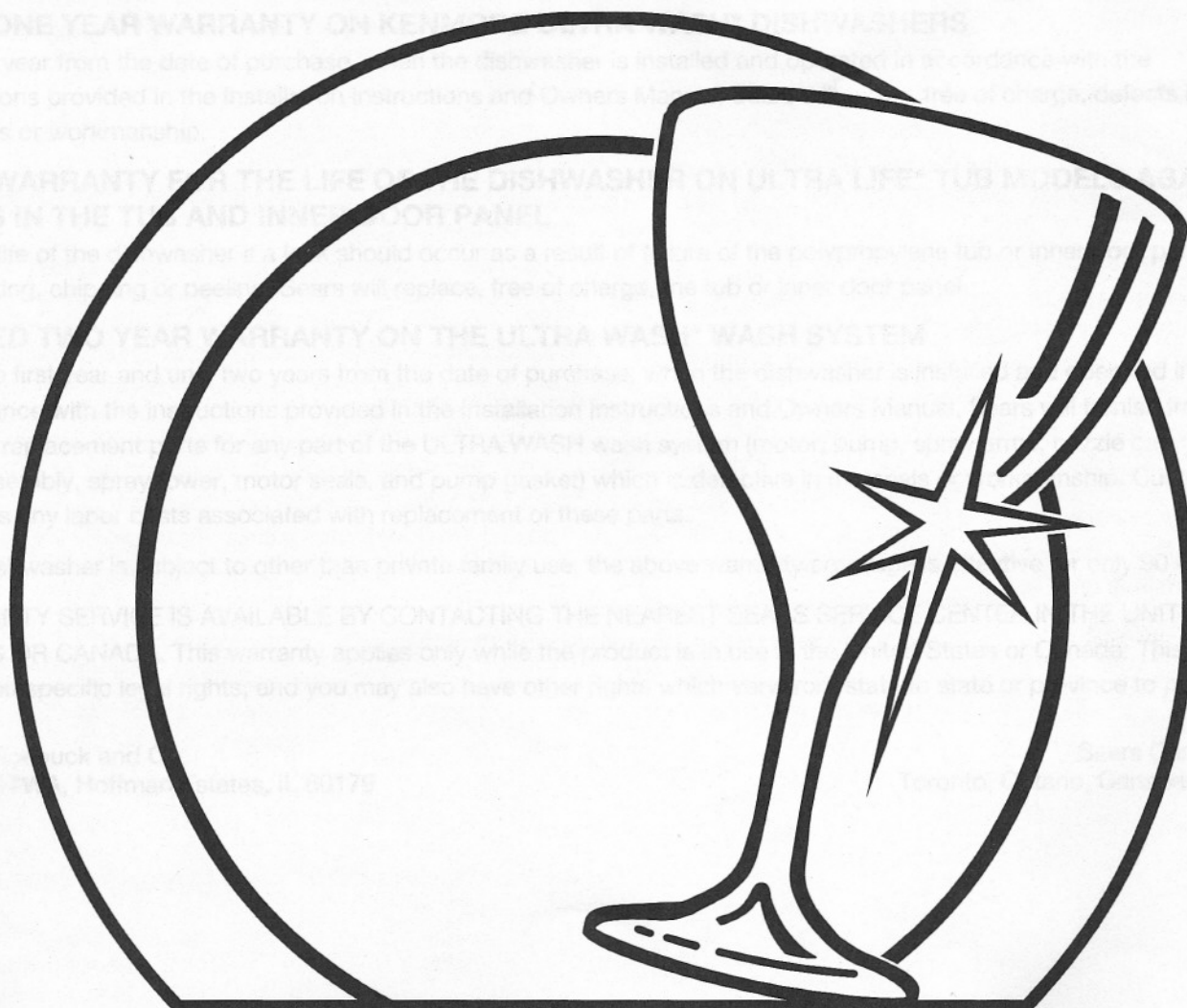

3378931

Sears, Roebuck and Co., Hoffman Estates, IL 60179 U.S.A.  
[www.sears.com](http://www.sears.com)

**MODELS/MODELOS/MODÈLES**  
**15701, 15705, 15708, 16701, 16705,**  
**16708, 17701, 17705, 17708**

# Your Part in Cleaning Dishes

## Using the detergent dispenser

- Use **automatic dishwashing detergent only**. Other detergents are too mild and much too sudsy.
- Add detergent just before starting cycle.
- Store tightly closed detergent in a cool, dry place. **Fresh automatic dishwasher detergent results in better cleaning.**

### Filling the detergent dispenser

The detergent dispenser **A** has one section with a cover and one without. Push the cover down firmly until it latches. Detergent in the open section falls into the dishwasher when closing the door. The covered section opens automatically for the main wash. It is normal for the cover to open partially when dispensing detergent.

**NOTE:** Use both sections for cycles with two washes. Use only the covered section for cycles with one wash. See the cycles chart for more details.

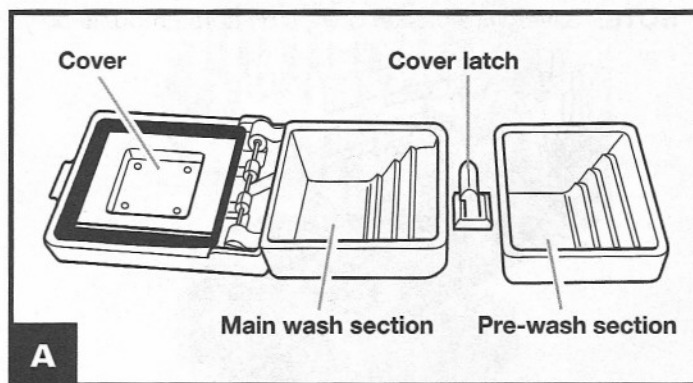

## How much detergent to use

- The amount of detergent to use depends on the hardness of your water and the type of detergent. If you use too little, dishes won't be clean. If you use too much in soft water, glassware will etch.
- Find out your water's hardness by asking the water softener department in your local Sears store or your local water department.

WATER HARDNESS	AMOUNT OF DETERGENT
<b>Soft to Medium Hard Water</b> 0 to 6 grains per gallon	<b>For normal loads:</b> <ul style="list-style-type: none"><li>• Partially fill the Main Wash section (2 tablespoons or 30 grams)</li><li>• Fill the Pre-Wash section (2 tablespoons or 30 grams)</li></ul> <b>NOTE:</b> Add only 1 tablespoon or 15 grams of detergent to the Pre-Wash section if dishes are prerinced or water is very soft. <b>For heavily soiled loads:</b> <ul style="list-style-type: none"><li>• Fill the Main Wash section (3 tablespoons or 45 grams)</li><li>• Fill the Pre-Wash section (2 tablespoons or 30 grams)</li></ul>
<b>Medium to Hard Water</b> 7 to 12 grains per gallon	<b>For normal and heavily soiled loads:</b> <ul style="list-style-type: none"><li>• Fill the Main Wash section (3 tablespoons or 45 grams)</li><li>• Fill the Pre-Wash section (2 tablespoons or 30 grams)</li></ul>

**NOTE:** Fill amounts shown are for standard powdered detergent. Amounts may vary if you use liquid or concentrated powdered detergent. Follow instructions on the package when using liquid dishwasher detergent or concentrated powdered detergent.

## Using the rinse agent dispenser

A rinse agent greatly improves dish drying and helps prevent spots or streaks. The rinse agent helps water flow off dishes and keeps water from forming droplets. A small amount of rinse agent automatically releases into the final rinse water.

**Keep the rinse agent dispenser filled with a liquid rinse agent.** For best drying results, periodically check the dispenser as follows to see if it needs filling:

- Check center of rinse aid indicator cap **A**. Clear means it needs filling.

**OR**

- Remove rinse aid indicator cap. An "E" is visible at the bottom of the dispenser when empty **B**.

**To fill dispenser:**

1. Open dishwasher door completely.
2. Remove rinse aid indicator cap.
3. Add rinse agent **C**. Fill only to smallest opening in lower part of dispenser. Overfilling may cause rinse agent to leak out. This will not harm the dishwasher, but could cause oversudsing.
4. Clean up any spilled rinse agent with a damp cloth.
5. Replace rinse aid indicator cap. Keep it closed tightly.

**NOTES:**

- Your dishwasher is designed to use a liquid rinse agent. Do not use a solid or bar-type rinse agent.
- The rinse agent dispenser holds 6 ounces (175 mL). Under normal conditions, this lasts about 3 months.
- You do not have to wait until the dispenser is empty before refilling, but do not overfill it.

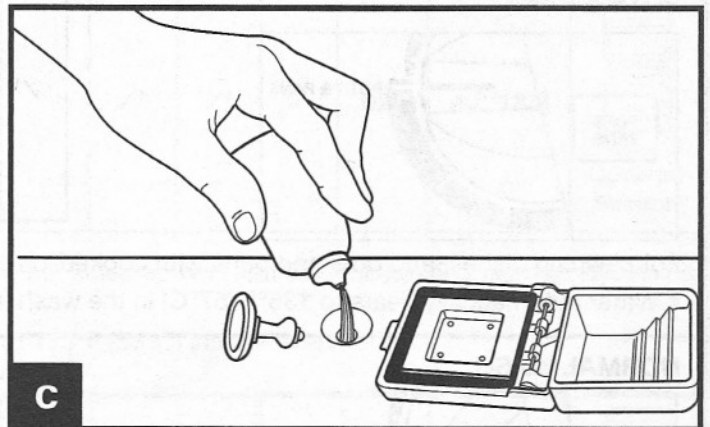
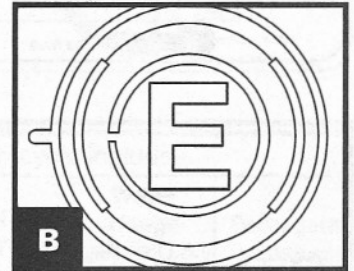
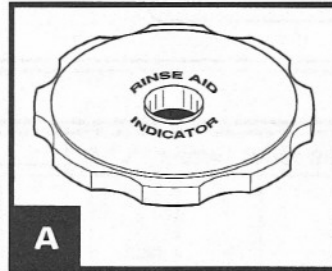

## Water temperature tips

Hot water dissolves and activates the dishwashing detergent. Hot water also dissolves grease on dishes and helps dry glasses spot-free. For best dishwashing results, water must be at least 120°F (49°C) as it enters the dishwasher. Loads may not wash as well if the water temperature is too low.

**NOTE:** Use the Water Heat option on your dishwasher if you keep your water heater at a low setting. For more information, see "Dishwasher seems to run too long" in the "Troubleshooting Guide" section.





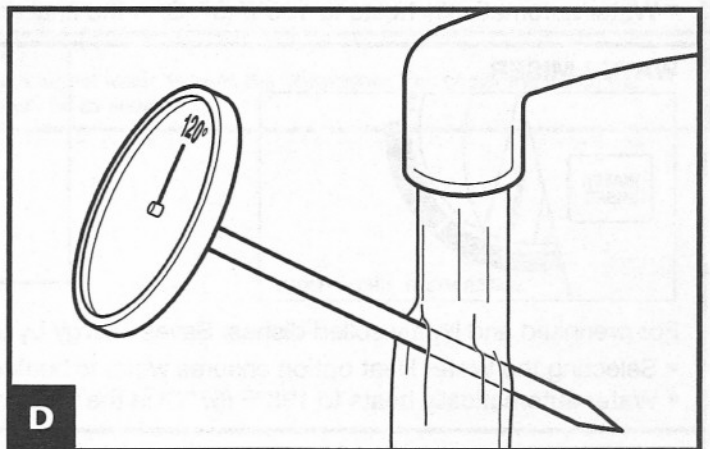

**To check water temperature:**

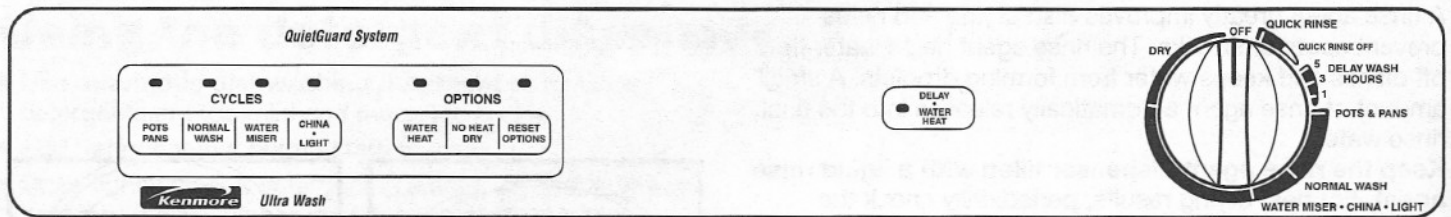
1. Run hot water at the faucet closest to your dishwasher for at least 1 minute.
2. Measure the water temperature with a candy or meat thermometer placed in the running stream of water **D**.
3. If the water temperature at the faucet is below 120°F (49°C), have a qualified person raise the water heater's thermostat setting.

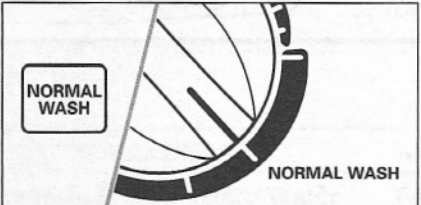

# Cycles

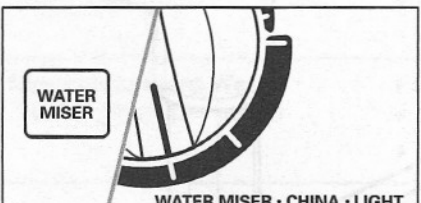

CYCLE	A "✓" shows what each cycle includes.					Cycle Time <sup>††</sup> (min.)	Water Usage (gallons[U.S.]/liters)	Detergent Dispenser Sections
	Wash	Rinse	Main Wash	Rinse	Dry			
<b>POTS &amp; PANS</b> 	✓ <sup>†</sup>	✓	✓ <sup>†</sup>	✓ <sup>†</sup>	✓	88 <sup>††</sup>	9.1/34.4	 Use Both Sections
<b>NORMAL WASH</b> 	✓		✓ <sup>†</sup>	✓ <sup>†</sup>	✓	72 <sup>††</sup>	6.9/26.1	 Use Both Sections
<b>WATER MISER</b> 			✓ <sup>†</sup>	✓ <sup>†</sup>	✓	62 <sup>††</sup>	4.8/18.2	 Use Covered Section

For cleaning dishes, and pots and pans with cooked-on or dried-on foods.

- Water automatically heats to 135°F (57°C) in the wash, main wash, and final rinse.

For everyday heavily soiled dishes. (The Energy Guide label is based on this cycle.)

- Selecting the Water Heat option ensures water is heated to 135°F (57°C) in main wash.
- Water automatically heats to 135°F (57°C) in the final rinse.



For prerinse and lightly soiled dishes. Saves energy by using less hot water than Normal Wash cycle.

- Selecting the Water Heat option ensures water is heated to 135°F (57°C) in the main wash.
- Water automatically heats to 135°F (57°C) in the final rinse.

<sup>†</sup> The Timer knob will pause while water is being heated.  
<sup>††</sup> Cycle time includes dry time and may be longer depending on the temperature of water entering the dishwasher. The cooler the water, the longer the cycle time. If the water is already hot enough, the cycle times will be as shown.

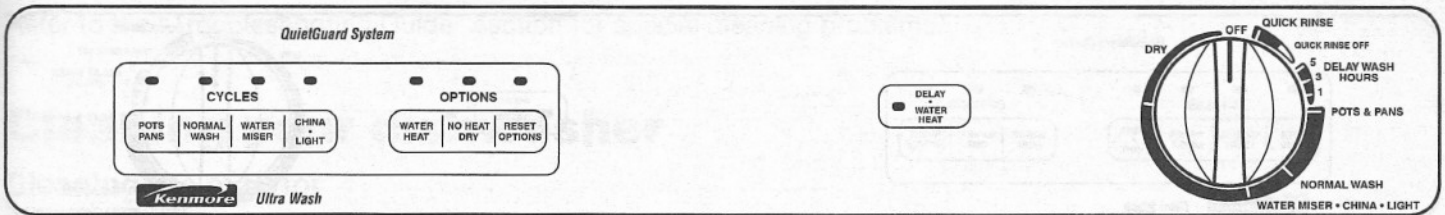
# Cycles (cont.)

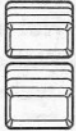

CYCLE	A "✓" shows what each cycle includes.					Cycle Time <sup>††</sup> (min.)	Water Usage (gallons[U.S.]/liters)	Detergent Dispenser Sections
	Wash	Rinse	Main Wash	Rinse	Dry			
<b>CHINA • LIGHT</b> 			✓ <sup>†</sup>	✓ <sup>†</sup>	✓	62 <sup>††</sup>	4.8/18.2	 Use Covered Section
<b>QUICK RINSE</b> 				✓		6	2.2/8.3	 No Detergent Needed

A light wash and gentle dry for china and crystal. If you have not selected No Heat Dry, the heating element cycles on and off during the drying part of the cycle.

- Selecting the Water Heat option ensures water is heated to 135°F (57°C) in main wash.
- Water automatically heats to 135°F (57°C) in the final rinse.

For rinsing dishes that will be washed later.

<sup>†</sup> The Timer knob will pause while water is being heated.  
<sup>††</sup> Cycle time includes dry time and may be longer depending on the temperature of water entering the dishwasher. The cooler the water, the longer the cycle time. If the water is already hot enough, the cycle times will be as shown.



# Options

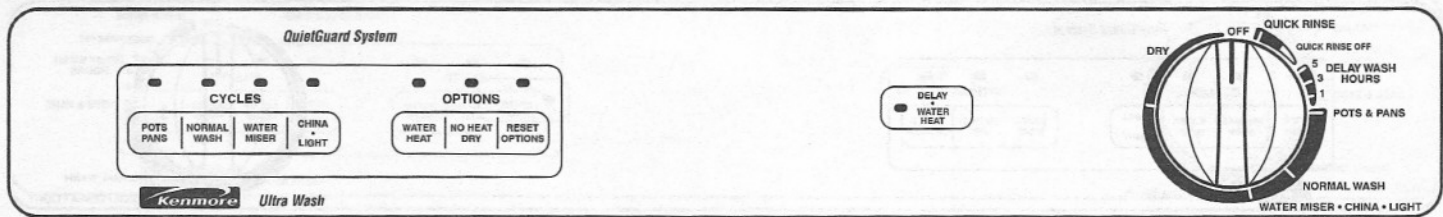

Option	When should I use it?	What does it do?
<b>Water Heat</b> <ul style="list-style-type: none"> <li>• Automatic with Pots &amp; Pans</li> <li>• Option for Normal Wash, Water Miser, and China•Light cycles</li> <li>• Not available for Quick Rinse cycle</li> </ul>	To ensure water temperature in main wash reaches 135°F (57°C).	<ul style="list-style-type: none"> <li>• When you select Water Heat, main wash delays until water heats to 135°F (57°C).</li> <li>• As water heats, washing action continues.</li> <li>• Timer knob pauses and status indicator light is on until water reaches proper temperature.</li> </ul>
<b>No Heat Dry</b> <ul style="list-style-type: none"> <li>• Option for Pots &amp; Pans, Normal, Water Miser and China•Light cycles</li> </ul>	Use when you do not need a rapid dry cycle. Allow longer drying times (overnight). Use rinse agent to improve drying.	<ul style="list-style-type: none"> <li>• Turns off heating element in 30-minute dry period.</li> </ul>
<b>Reset Options</b>	To change option selection.	<ul style="list-style-type: none"> <li>• Cancels any previously selected options.</li> </ul>
<b>Delay Wash</b> <ul style="list-style-type: none"> <li>• Option for Pots &amp; Pans and Normal Wash.</li> <li>• Not available for Quick Rinse, Water Miser, and China•Light cycles</li> </ul>	Use when you want to start a cycle later. Set delay to run dishwasher during times when off-peak utility rates are in effect. Local utilities recommend this to avoid heavy usage of energy at certain times of day.	<ul style="list-style-type: none"> <li>• Delay beginning of your selected cycle and options for up to 5 hours.</li> <li>• To set:               <ol style="list-style-type: none"> <li>1. Close the door firmly until you hear it latch.</li> <li>2. Select the desired Cycle and Options.</li> <li>3. Turn Timer knob to the number of hours you want dishwashing to be delayed. The Delay Wash status indicator will glow.</li> </ol> </li> <li>• If you wish to put more dishes in the dishwasher while it is in delay mode, be sure to latch the door after you add them. The Timer knob will not advance unless the door is latched. The amount of delay can be changed or canceled at any time before the cycle begins.</li> </ul>

## Status indicator light

### Delay • Water Heat

The Delay • Water Heat status indicator **A** glows to indicate that the dishwasher is:

- set to delay starting until a later time
- OR**
- heating water to the proper dishwashing temperature if your household water is not hot enough.

**NOTE:** The Timer knob will pause while this occurs.

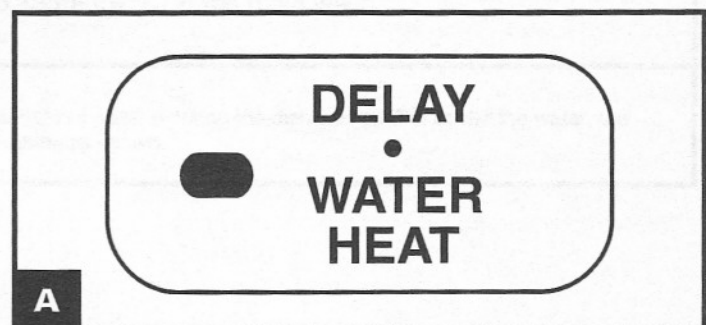

# Caring for Your Dishwasher

Refer to the "Troubleshooting Guide" section for special cleaning problems.

## Cleaning your dishwasher

### Cleaning the exterior

In most cases, regular use of a soft, damp cloth or sponge and a mild detergent is all that is necessary to keep the outside of your dishwasher looking nice and clean **A**.

### Cleaning the interior

Hard water minerals may cause a white film to build up on the inside surfaces, especially just beneath the door area.

#### To clean interior:

- Apply powdered dishwasher detergent to a damp sponge to make a paste.

#### OR

- Use liquid automatic dishwasher detergent and clean with damp sponge **B**.

**Do not** clean the dishwasher interior until it has cooled. Wear rubber gloves. **Do not** use any type of cleanser other than dishwasher detergent because it may cause foaming or sudsing.

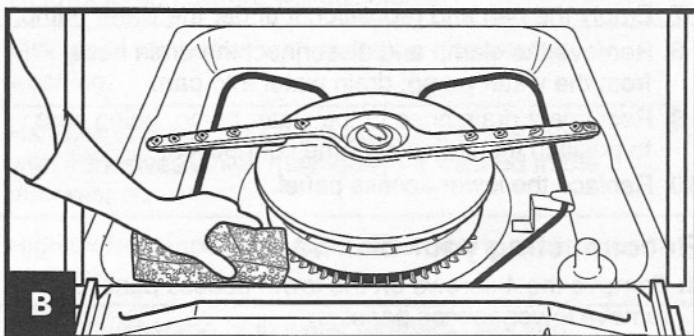
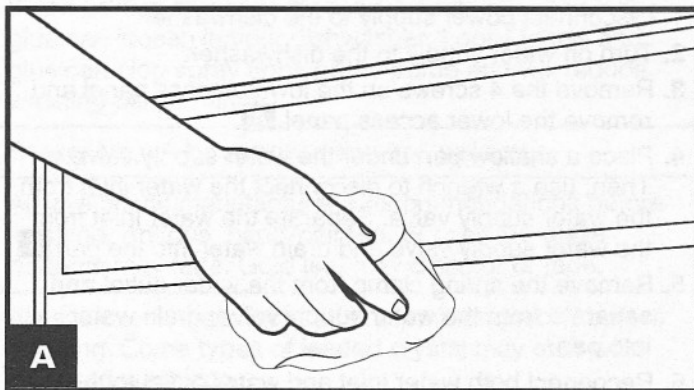

# Storing your dishwasher

## Moving or winterizing your dishwasher

Protect your dishwasher and home against water damage due to freezing water lines. If your dishwasher is left in a seasonal dwelling or could be exposed to near freezing temperatures, have a qualified person do the following:

1. Disconnect power supply to the dishwasher.
2. Turn off water supply to the dishwasher.
3. Remove the 4 screws on the lower access panel and remove the lower access panel **A**.
4. Place a shallow pan under the water supply valve. Then, use a wrench to disconnect the water inlet from the water supply valve. Separate the water inlet from the water supply valve and drain water into the pan **B**.
5. Remove the spring clamp from the water outlet and separate from the water supply valve; drain water into pan.
6. Reconnect both water inlet and water outlet to the water supply valve.
7. Empty the pan and reposition it under the water pump.
8. Remove the clamp and disconnect the drain hose from the water pump; drain water into pan.
9. Reconnect drain hose to the water pump, being sure to position the clamp over the connection.
10. Replace the lower access panel.

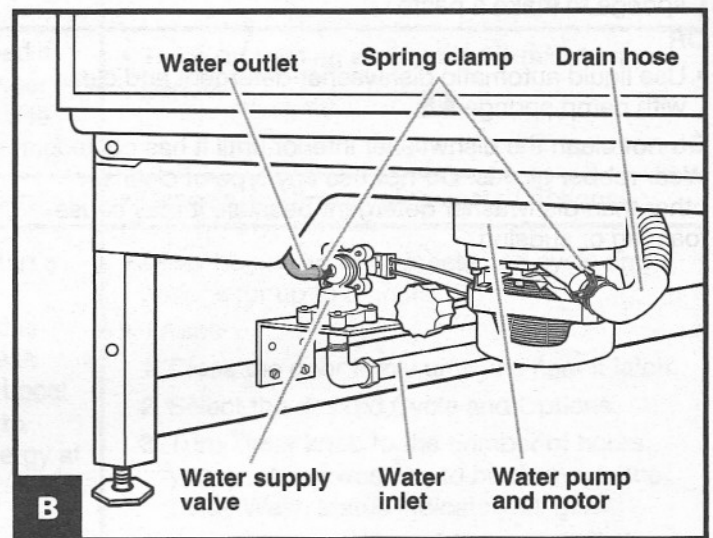
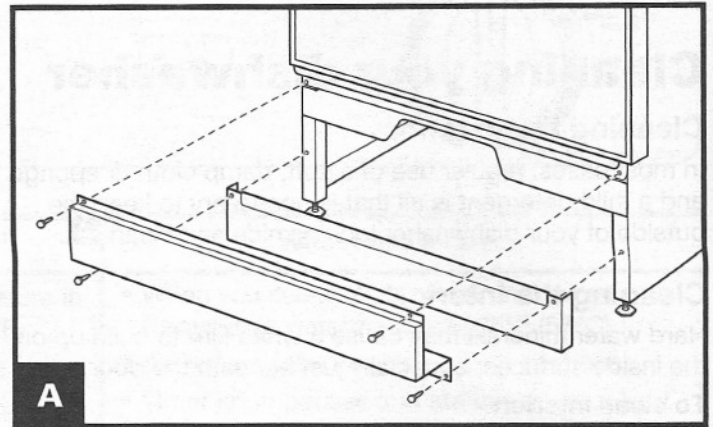

## Reconnecting your dishwasher

1. Remove the 4 screws on the lower access panel and remove lower access panel.
2. Turn on the water supply to dishwasher.
3. Turn on power supply to dishwasher.
4. Run dishwasher through a complete cycle and check for leaks.
5. Replace lower access panel.

**NOTE:** If your dishwasher is connected to a garbage disposal, do not run water into the sink after winterizing. This could cause water to refill the drain hose on your dishwasher.

## Storing for the summer

Protect your dishwasher during the summer months by turning off the water supply and power supply to the dishwasher.

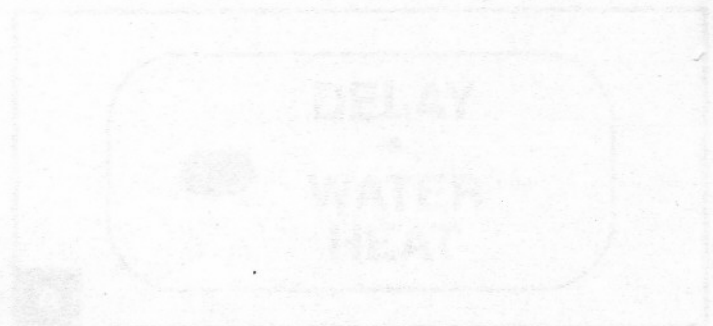



## Tips for washing special items

If you have any doubts about washing a particular item, check with the manufacturer to see if it is dishwasher safe.

MATERIAL	DISHWASHER SAFE?	EXCEPTIONS/SPECIAL INFORMATION
Aluminum	Yes	High water temperature and detergents may affect finish of anodized aluminum.
Bottles and Cans	No	Wash bottles and cans by hand. Labels attached with glue can loosen in your dishwasher. Loose labels and glue can clog spray arms or the pump and will reduce washing performance.
Cast Iron	No	Seasoning will be removed and iron will rust.
China/Stoneware	Yes	Always check manufacturer's recommendations before washing. Antique, hand-painted, or over-the-glaze patterns may fade. Gold leaf may discolor or fade.
Crystal	Yes	Always check manufacturer's recommendations before washing. Some types of leaded crystal may etch with repeated washings.
Gold	No	Gold-colored flatware will discolor.
Glass	Yes	Milk glass will yellow with repeated dishwasher washing.
Hollow-Handle Knives	No	Handles of some knives are attached to the blade with adhesives which may loosen if washed in the dishwasher.
Pewter	No	High water temperatures and detergent may discolor or pit finish.
Disposable Plastics	No	Cannot withstand high water temperatures and detergents.
Plastics	Yes	Always check manufacturer's recommendations before washing. Plastics vary in their capacity to withstand high water temperatures and detergents. Load plastics in top rack only.
Stainless Steel	Yes	Run a Quick Rinse cycle if not washing immediately. Prolonged contact with food containing salt, vinegar, milk products, or fruit juice could damage finish.
Sterling Silver or Silver Plate	Yes	Run a Quick Rinse cycle if not washing immediately. Prolonged contact with food containing salt, acid, or sulfide (eggs, mayonnaise, and seafood) could damage finish.
Tin	No	Can rust.
Wooden Ware	No	Wash by hand. Always check manufacturer's recommendations before washing. Untreated wood may warp, crack, or lose its finish.

# Starting your dishwasher for everyday loads

Here is an overview for loading and running your dishwasher. Refer to the noted pages for more details of each step.

1. The ULTRA WASH® Soil Removal System is designed to remove food particles from the wash and rinse water. Remove only large chunks of food and bones from your dishes.
2. Properly load the dishwasher **A**. Make sure nothing prevents the spray arms from spinning freely **B**. See pages 7 and 8.

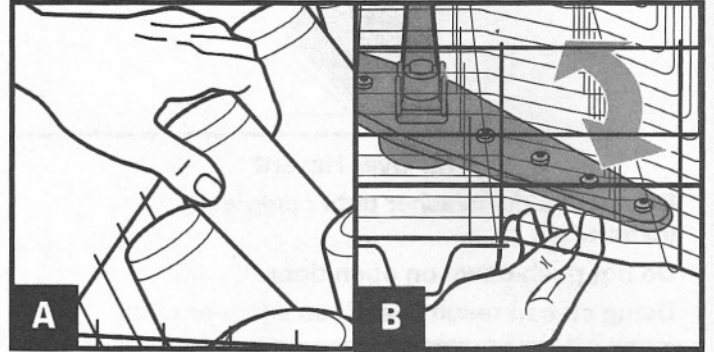

3. Add detergent **C** and check the rinse agent dispenser. Add rinse agent if needed **D**. See pages 10 and 11.

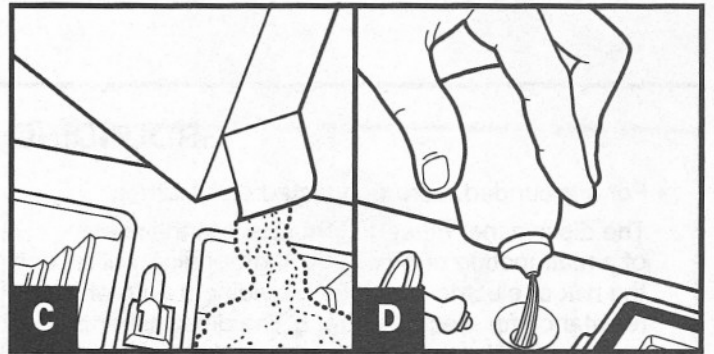

4. Push door firmly closed **E**. The door latches automatically. Run hot water at the sink nearest your dishwasher until water is hot **F**. Turn off water. See page 11.

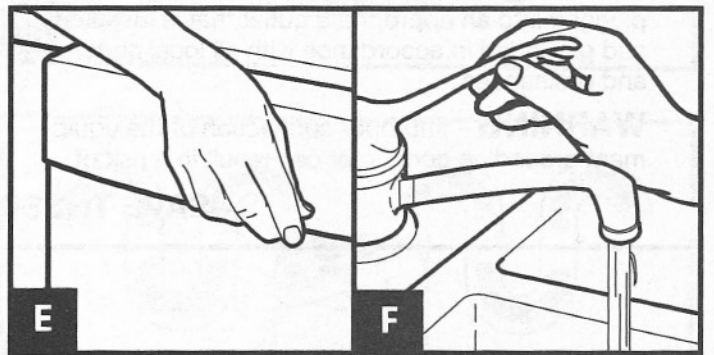

5. Press the desired Cycle and Options buttons **G**. Turn the Timer knob to the desired Cycle to start **H**. See pages 12-14.

**NOTE:** If the door is latched, you will hear the cycles start and stop as the Timer knob passes each cycle mark. This is normal and does not hurt the dishwasher. If you prefer, you can set the Timer knob with the door unlatched.

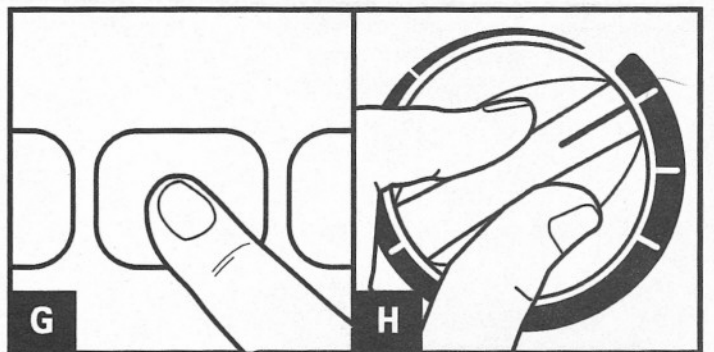

# Loading Your Dishwasher

## Preparing to load your dishwasher

- Load correctly for best washing results. Incorrect loading may cause poor washing and the need to rewash all or part of the load.
- Wash full loads. Running a half-filled dishwasher uses the same amount of electricity and hot water as a fully loaded machine.
- To save water and energy, do not rinse dishes before putting them into the dishwasher.
- Remove large pieces of food, fruit pits, bones, and other hard items. The ULTRA WASH\* module will remove food particles from the water. The module contains a chopping device which will reduce the size of food items.  
**NOTE:** If hard items such as fruit seeds, nuts, and egg shells enter the ULTRA WASH module, you might hear chopping, grinding, crunching, or buzzing sounds. Those sounds are normal when hard items enter the module. **Do not** let metallic items (such as pot handle screws) get into the ULTRA WASH module. They could damage the ULTRA WASH module.
- Foods like eggs, rice, pasta, spinach, and cooked cereals may be hard to remove if they are left to dry over a period of time. Run a Quick Rinse cycle to keep dishes moist if you do not plan to wash them soon.
- Load dishes so soiled surfaces face the rotating spray arms.
- Load dishes so they are not stacked or overlapping, if possible. It is important for the water spray to reach all soiled surfaces for best washing. For best drying, water must be able to drain from all surfaces.

## Loading the top rack

The top rack is designed for cups, glasses, and smaller items. (See recommended loading patterns below.)

**NOTE:** The features on your dishwasher rack may vary from the drawings below.

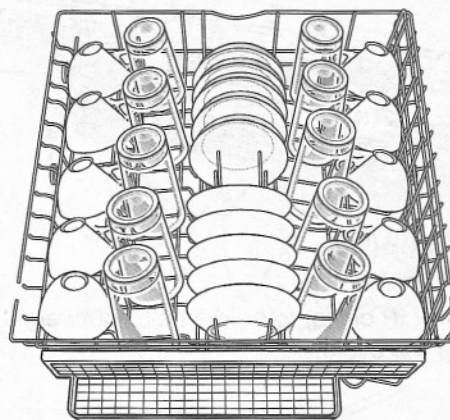

10 place setting

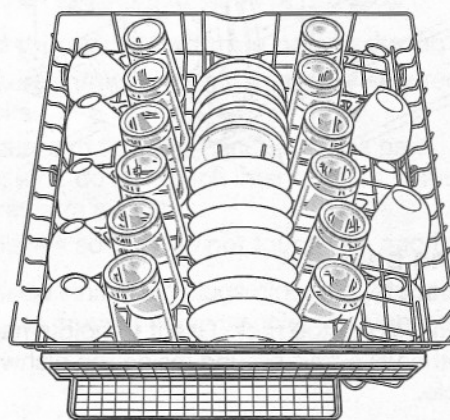

12 place setting

- Place items so open ends face down for cleaning and draining.
- Load glasses in top rack only – bottom rack is not designed for glasses. Damage may occur.
- Place cups and glasses in the rows between prongs. Placing them over the prongs can lead to breakage.
- Secure lightweight items.
- China, crystal, and other delicate items must not touch each other during dishwasher operation. Damage may occur.
- Load plastic items in the top rack only. Only plastic items marked “dishwasher safe” are recommended.
- Load plastic items so the force of the spray does not move them during the cycle.
- To avoid chipping, do not let stemware touch other items.
- Small bowls, pans, and other utensils can be placed in the top rack.

## Loading the top rack (cont.)

### Utensil basket

Use this extra capacity basket on the top rack to hold spatulas, wooden spoons, and similar items.

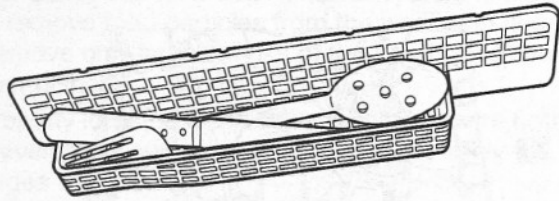

### NO-FLIP\* clip(s) (on some models)

Use the NO-FLIP clip(s) to hold small, lightweight items in place during the cycle.

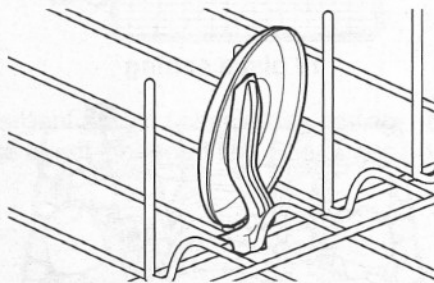

### Small items basket (on some models)

This basket fits in the top rack. Use it to hold small items that could otherwise "fly" around inside the dishwasher during a cycle.

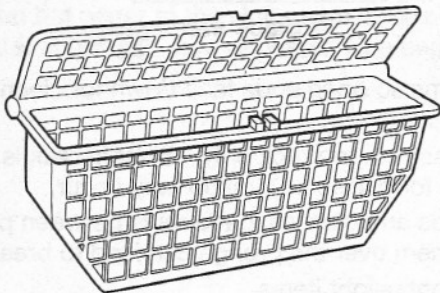

## Loading the bottom rack

Items with cooked-on or dried-on food should be loaded in the bottom rack, with soiled surfaces facing inward to the spray. (See recommended loading patterns below.)

**NOTE:** The features on your dishwasher rack may vary from the drawings below.

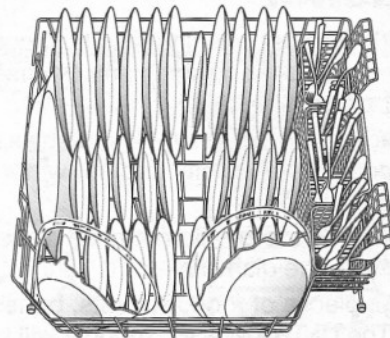

10 place setting

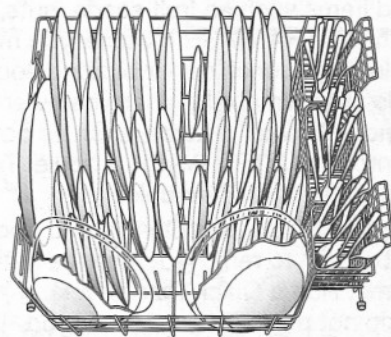

12 place setting

- Do not load glasses, cups, or plastic items in the bottom rack.
- Load plates, soup bowls, etc., between prongs and facing inward to the spray.
- Overlap edges of plates for large loads.
- Secure heavily soiled cookware face down in the rack.
- Make sure pot handles and other items do not stop rotation of the upper or lower spray arm. The spray arms must move freely.

## Loading the silverware basket

- Load the silverware basket while it is in the bottom rack or take the basket out for loading on a counter or table.

**NOTE:** You can remove the basket for easy unloading. Always unload or remove the basket before unloading the racks to avoid spilling water droplets on the silverware.

- Place small items (baby bottle caps, jar lids, etc.) in a section with a hinged cover. Close the cover over the section to hold small items in place.

**NOTE:** Silverware basket covers on some models only.

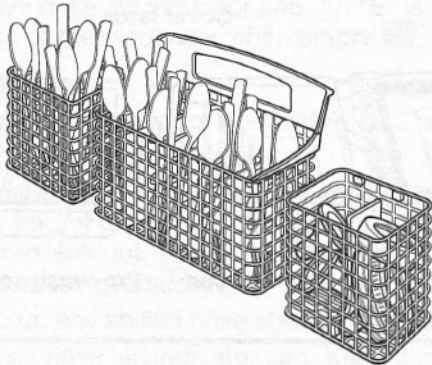

- You can separate the two small baskets from the large basket and position the small baskets elsewhere in the upper or lower rack.

### To remove a small basket:

1. Hold the center basket with one hand, and one of the small baskets with the other hand.
2. Slide the small basket to release tabs from corresponding slots.
3. Pull baskets apart.

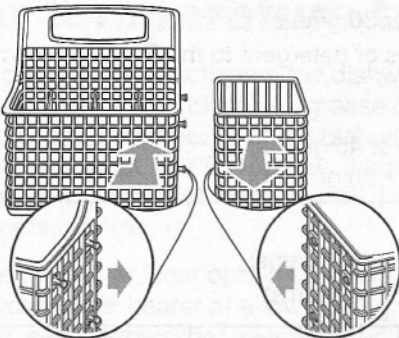

- Mix items in each section of the basket with some pointing up and some down to avoid nesting. Spray cannot reach nested items.

**IMPORTANT:** Always load sharp items (knives, skewers, forks, etc.) pointing down.

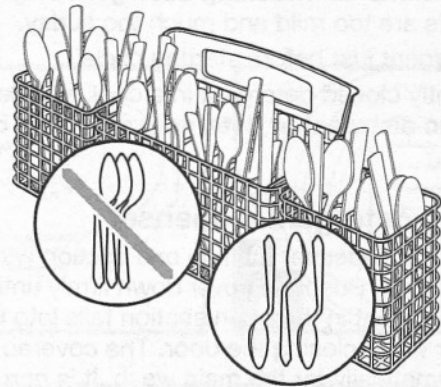

## Quiet operating tips

### To avoid thumping/clattering noises during operation:

- Make sure lightweight load items are secured in the racks.
- Make sure pot lids and handles, pizza pans, cookie sheets, etc., do not touch interior walls or interfere with the spray arm's rotation.
- Load dishes so they do not touch one another.

**NOTE:** Keep sink drain plugs closed during dishwasher operation to prevent noise transfer through drains.

# Table of Contents

	Page		Page
Sears Dishwasher Warranty .....	1	<b>Your Part in Cleaning Dishes</b>	
Dishwasher Safety .....	2	Using the detergent dispenser .....	10
Parts and Features .....	3	How much detergent to use .....	10
The ULTRA WASH* Soil Removal System .....	4	Using the rinse agent dispenser .....	11
<b>Start Up Guide</b>		Water temperature tips .....	11
Before using your dishwasher .....	5	Cycles .....	12
Starting your dishwasher for everyday loads .....	6	Options .....	14
<b>Loading Your Dishwasher</b>		Status indicator light .....	14
Preparing to load your dishwasher .....	7	<b>Caring for Your Dishwasher</b>	
Loading the top rack .....	7	Cleaning your dishwasher .....	15
Loading the bottom rack .....	8	Storing your dishwasher .....	16
Loading the silverware basket .....	9	Tips for washing special items .....	17
Quiet operating tips .....	9	<b>Troubleshooting Guide</b> .....	18
		<b>We Service What We Sell</b> .....	21

## Sears Dishwasher Warranty

### FULL ONE YEAR WARRANTY ON KENMORE ULTRA WASH\* DISHWASHERS

For one year from the date of purchase, when the dishwasher is installed and operated in accordance with the instructions provided in the Installation Instructions and Owners Manual, Sears will repair, free of charge, defects in materials or workmanship.

### FULL WARRANTY FOR THE LIFE OF THE DISHWASHER ON ULTRA LIFE\* TUB MODELS AGAINST LEAKS IN THE TUB AND INNER DOOR PANEL

For the life of the dishwasher if a leak should occur as a result of failure of the polypropylene tub or inner door panel due to cracking, chipping or peeling, Sears will replace, free of charge, the tub or inner door panel.

### LIMITED TWO YEAR WARRANTY ON THE ULTRA WASH\* WASH SYSTEM

After the first year and until two years from the date of purchase, when the dishwasher is installed and operated in accordance with the instructions provided in the Installation Instructions and Owners Manual, Sears will furnish free of charge, replacement parts for any part of the ULTRA WASH wash system (motor, pump, spray arms, nozzle cap, water feed assembly, spray tower, motor seals, and pump gasket) which is defective in materials or workmanship. Customer assumes any labor costs associated with replacement of these parts.

If the dishwasher is subject to other than private family use, the above warranty coverage is effective for only 90 days.

WARRANTY SERVICE IS AVAILABLE BY CONTACTING THE NEAREST SEARS SERVICE CENTER IN THE UNITED STATES OR CANADA. This warranty applies only while the product is in use in the United States or Canada. This warranty gives you specific legal rights, and you may also have other rights which vary from state to state or province to province.

Sears, Roebuck and Co.  
Dept. 817WA, Hoffman Estates, IL 60179

Sears Canada, Inc.  
Toronto, Ontario, Canada M5B2B8

\* Indicates symbol for Trademark

## Free Manuals Download Website

<http://myh66.com>

<http://usermanuals.us>

<http://www.somanuals.com>

<http://www.4manuals.cc>

<http://www.manual-lib.com>

<http://www.404manual.com>

<http://www.luxmanual.com>

<http://aubethermostatmanual.com>

Golf course search by state

<http://golfingnear.com>

Email search by domain

<http://emailbydomain.com>

Auto manuals search

<http://auto.somanuals.com>

TV manuals search

<http://tv.somanuals.com>