

Use & Care Guide

Manual de Uso y Cuidado

English / Español

Models/Modelos: 790.4807*, 790.4808*, 790.4809*

Kenmore Elite®

Electric Built-In Oven

Horno de pared

* = Color number, número de color

P/N 318205326A (1005)

Sears Brands Management Corporation

Hoffman Estates, IL 60179 U.S.A.

www.kenmore.com

www.sears.com



Table of Contents

Wall Oven Warranty	2	Minimum and Maximum Control Pad Settings	7
Product Record	2	Setting the Oven Controls	8-26
Serial Plate Location	2	Self-Cleaning.....	27-29
IMPORTANT SAFETY INSTRUCTIONS	3-4	Adjusting Oven Temperature	29
Wall Oven Features	5	General Care & Cleaning.....	30-32
Oven Vent and Racks	6	Before You Call.....	33-34
Air Circulation in the Oven	6	Protection Agreements.....	35
Control Pad Features	7	Sears Service.....	36

Kenmore Limited Warranty

When installed, operated and maintained according to all instructions supplied with the product, if this appliance fails due to a defect in material and workmanship within one year from the date of purchase, call 1-800-4-MY-HOME® to arrange for free repair.

This warranty applies for only 90 days from the date of purchase if this appliance is ever used for other than private family purposes.

This warranty covers only defects in material and workmanship. Sears will NOT pay for:

1. Cracks in a ceramic glass cooktop that are not a result of thermal shock.
2. Stains and scratches on a ceramic glass cooktop resulting from accident or improper operation or maintenance.
3. Expendable items that can wear out from normal use, including but not limited to filters, belts, light bulbs, and bags.
4. A service technician to instruct the user in correct product installation, operation or maintenance.
5. A service technician to clean or maintain this product.
6. Damage to or failure of this product if it is not installed, operated or maintained according to the all instructions supplied with the product.
7. Damage to or failure of this product resulting from accident, abuse, misuse or use for other than its intended purpose.
8. Damage to or failure of this product caused by the use of detergents, cleaners, chemicals or utensils other than those recommended in all instructions supplied with the product.
9. Damage to or failure of parts or systems resulting from unauthorized modifications made to this product.

Disclaimer of implied warranties; limitation of remedies

Customer's sole and exclusive remedy under this limited warranty shall be product repair as provided herein. Implied warranties, including warranties of merchantability or fitness for a particular purpose, are limited to one year or the shortest period allowed by law. Sears shall not be liable for incidental or consequential damages. Some states and provinces do not allow the exclusion or limitation of incidental or consequential damages, or limitation on the duration of implied warranties of merchantability or fitness, so these exclusions or limitations may not apply to you.

This warranty applies only while this appliance is used in the United States or Canada.

This warranty gives you specific legal rights, and you may also have other rights which vary from state to state.

Sears Brands Management Corporation, Hoffman Estates, IL 60179
Sears Canada Inc., Toronto, Ontario, Canada M5B 2B8

Product Record

In this space below, record the date of purchase, model and serial number of your product. You will find the model and serial number printed on the serial plate.

Model No. 790.

Serial No. _____

Date of purchase _____

Save these instructions and your sales receipt for future reference.

Please carefully read and save these instructions

This Use & Care Manual contains general operating instructions for your appliance and feature information for several models. Your product **may not** have all the described features. The graphics shown are representative. The graphics on your appliance may not look exactly like those shown. Common sense and caution must be practiced when installing, operating and maintaining any appliance.

Serial Plate Location

You will find the model and serial number printed on the serial plate. The serial plate is located along the interior side trim and visible when the oven door is opened.

Remember to record the serial number for future reference.

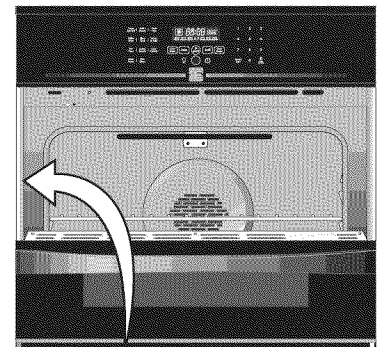

Serial Plate Location

IMPORTANT SAFETY INSTRUCTIONS

Read all instructions before using this appliance. Save these instructions for future reference. This manual contains important safety symbols and instructions. Please pay attention to these symbols and follow all instructions given.

⚠ WARNING This symbol will help alert you to situations that may cause serious bodily harm, death or property damage.

⚠ CAUTION This symbol will help alert you to situations that may cause bodily injury or property damage.

- Remove all tape and packaging before using the appliance. Destroy the carton and plastic bags after unpacking the appliance. Never allow children to play with packaging material.
- Proper Installation. Be sure your appliance is properly installed and grounded by a qualified technician in accordance with National Electrical Code ANSI/NFPA No.70 (USA) or CSA C22.1, PART 1 (Canada)-latest edition and local code requirements. Install only per installation instructions provided in the literature package for this appliance.

⚠ CAUTION Electronic controllers can be damaged by cold temperatures. When you use your appliance for the first time, or if it has not been used for a long period of time, make sure that it has been exposed to a temperature above 0°C/32°F for at least 3 hours before connecting it to the power supply.

- In case of an emergency, know how to disconnect the electrical power to the appliance at the circuit breaker or fuse box.
- User Servicing. Do not repair or replace any part of the appliance unless specifically recommended in the manuals. All other servicing should be done only by a qualified technician to reduce the risk of personal injury and damage to the appliance. Sears Parts & Repair is the recommended repair service for this appliance.
- Never modify or alter the construction of an appliance by removing panels, wire covers or any other part of the product.

- Remove the oven door from any unused appliance if it is to be stored or discarded.

⚠ WARNING Stepping, leaning, sitting or pulling down on the door of this appliance can result in serious injuries and may also cause damage to the appliance. Do not allow children to climb or play around the appliance.

- Storage on Appliance. Flammable materials should not be stored near surface units. This includes paper, plastic and cloth items, such as cookbooks, plasticware and towels, as well as flammable liquids. Do not store explosives, such as aerosol cans, on or near the appliance. Flammable materials may explode and result in fire or property damage.

⚠ WARNING Do not use the oven for storage.

⚠ CAUTION Do not store items of interest to children in the cabinets above an appliance. Children climbing on the appliance to reach items could be seriously injured.

- Do not leave children alone. Children should not be left alone or unattended in the area where an appliance is in use. They should never be allowed to sit or stand on any part of the appliance.
- DO NOT TOUCH BAKE AND BROILING ELEMENTS OR AREAS NEAR THESE ELEMENTS. Baking and broiling elements may be hot even though they are dark in color. Areas near elements may become hot enough to cause burns. During and after use, do not touch, or let clothing or other flammable materials touch these areas until they have had sufficient time to cool.

- Wear Proper Apparel. Loose-fitting or hanging garments should never be worn while using the appliance. Do not let clothing or other flammable materials contact hot surfaces.

⚠ WARNING Never use your appliance for warming or heating the room.

- Do Not Use Water or Flour on Grease Fires. Smother the fire with a pan lid, or use baking soda, a dry chemical or foam-type extinguisher.
- When heating fat or grease, watch it closely. Fat or grease may catch fire if allowed to become too hot.



⚠ WARNING

- All wall ovens can tip.
- Injury to persons could result.
- Install anti-tip bracket packed with wall oven.
- See Installation Instructions.

To reduce the risk of tipping, the wall oven must be secured by properly installed anti-tip bracket provided with the wall oven. Refer to the Installation Instructions for proper anti-tip bracket installation.



IMPORTANT SAFETY INSTRUCTIONS

- **Use Only Dry Potholders.** Moist or damp potholders on hot surfaces may result in burns from steam. Do not let the potholders touch hot heating elements. Do not use a towel or other bulky cloth instead of a potholder.
- **Do Not Heat Unopened Food Containers.** Buildup of pressure may cause the container to burst and result in injury.

IMPORTANT—Do not attempt to operate the appliance during a power failure. If power fails, always turn off the appliance. If the appliance is not turned off and the power resumes, it will begin to operate again. Once the power resumes, reset the clock and oven function.

IMPORTANT INSTRUCTIONS FOR USING YOUR OVEN

- **Use Care When Opening an Oven Door**—Stand to the side of the appliance when opening the door of a hot oven. Let hot air or steam escape before you remove or replace food in the oven.
- **Keep Oven Vent Ducts Unobstructed.** The wall oven is vented through the center trim of the oven. Touching the surfaces in this area when the wall oven is operating may cause severe burns. Also, do not place plastic or heat-sensitive items near the oven vent. These items could melt or ignite.
- **Placement of Oven Racks.** Always place oven racks in desired location while oven is cool. Remove all utensils from the rack before removing rack. If rack must be moved while oven is hot, use extreme caution. Use pot holders and grasp the rack with both hands to reposition. Do not let pot holders contact the hot oven element or interior of the oven.
- **Do not use the broiler pan without its insert.** The broiler pan and grid allow dripping fat to drain and be kept away from the high heat of the broiler.
- **Do not cover the broiler grid or oven bottom with aluminum foil.** Exposed fat and grease could ignite.
- **Do not touch a hot oven light bulb with a damp cloth.** Doing so could cause the bulb to break. Disconnect the appliance or shut off the power to the appliance before removing and replacing the bulb.
- **Protective liners**—Do not use aluminum foil to line the oven bottom. Only use aluminum foil as recommended in this manual. Improper installation of these liners may result in risk of electric shock, or fire.

IMPORTANT INSTRUCTIONS FOR CLEANING YOUR OVEN

- **Clean the appliance regularly to keep all parts free of grease that could catch fire.** Exhaust fan ventilation hoods and grease filters should be kept clean. Do not allow grease to accumulate. Greasy deposits in the fan could catch fire. Refer to the hood manufacturer's instructions for cleaning.
- **Cleaners/Aerosols**—Always follow the manufacturer's recommended directions for use. Be aware that excess residue from cleaners and aerosols may ignite causing damage and/or injury.

SELF CLEANING OVEN MODELS

- **Clean in the self-cleaning cycle only the parts of the appliance listed in this Owner's Guide.** Before using the self-cleaning cycle of the appliance, remove the broiler pan and any utensils stored in the appliance.
- **Do not clean the oven door gasket.** The door gasket is essential for a good seal. Care should be taken not to rub, damage or move the gasket.
- **Do not use oven cleaners.** No oven cleaner or oven liner protective coating of any kind should be used in or around any part of the appliance

CAUTION The health of some birds is extremely sensitive to the fumes given off during the self-clean cycle of any wall oven. Move birds to another well ventilated room.

IMPORTANT SAFETY NOTICE

The California Safe Drinking Water and Toxic Enforcement Act requires the Governor of California to publish a list of substances known to the state to cause cancer, birth defects or other productive harm, and requires businesses to warn customers of potential exposure to such substances.

Wall Oven Features

Note: The features of your wall oven will vary according to model type & color.

Your Electric Wall Oven

Features Include (790.4809*):

1. Electronic Oven Control with Timer
2. Decorative Accent Light
3. Self-Clean Door Latch
4. Oven Vent
5. Broil Element
6. Self-Cleaning Oven interior
7. Dual Oven Convection Fans & Cover
8. Adjustable Oven Rack
9. Oven Door Handle
10. Full Width Oven Door with Large Window
11. Decorative Bottom Trim

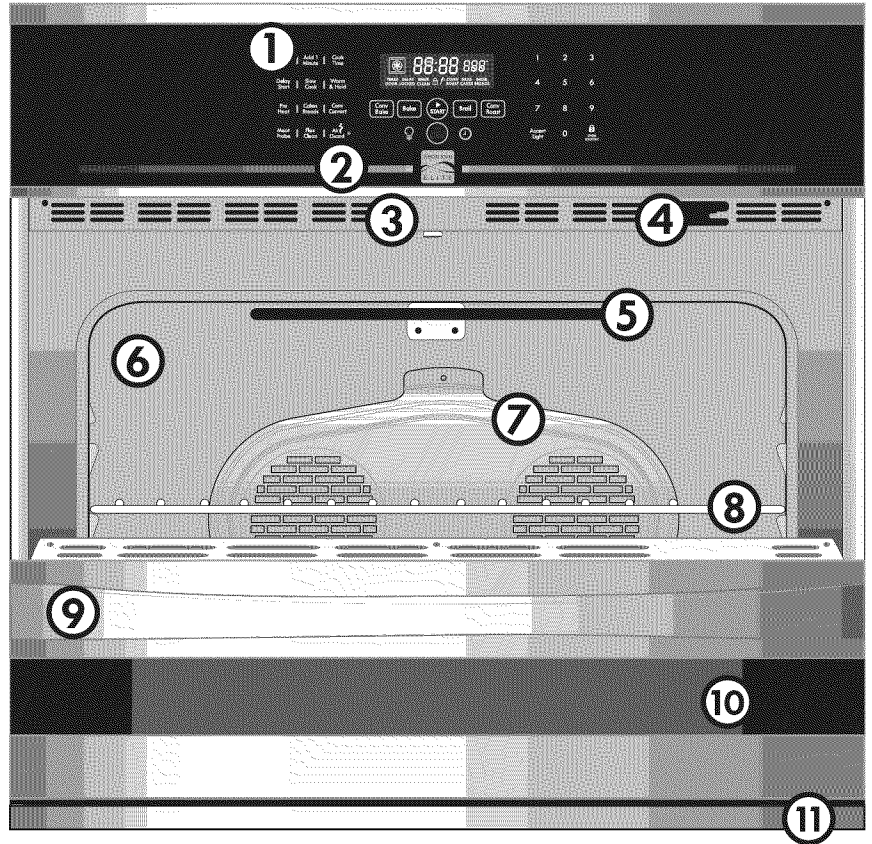

Your Electric Wall Oven

Features Include (790.4807*, 790.4808*):

1. Electronic Oven Control with Timer
2. Decorative Accent Light
3. Self-Clean Door Latch
4. Oven Vent
5. Broil Element
6. Self-Cleaning Oven interior
7. Oven Convection Fan & Cover
8. Adjustable Oven Rack
9. Oven Door Handle
10. Full Width Oven Door with Large Window
11. Decorative Bottom Trim

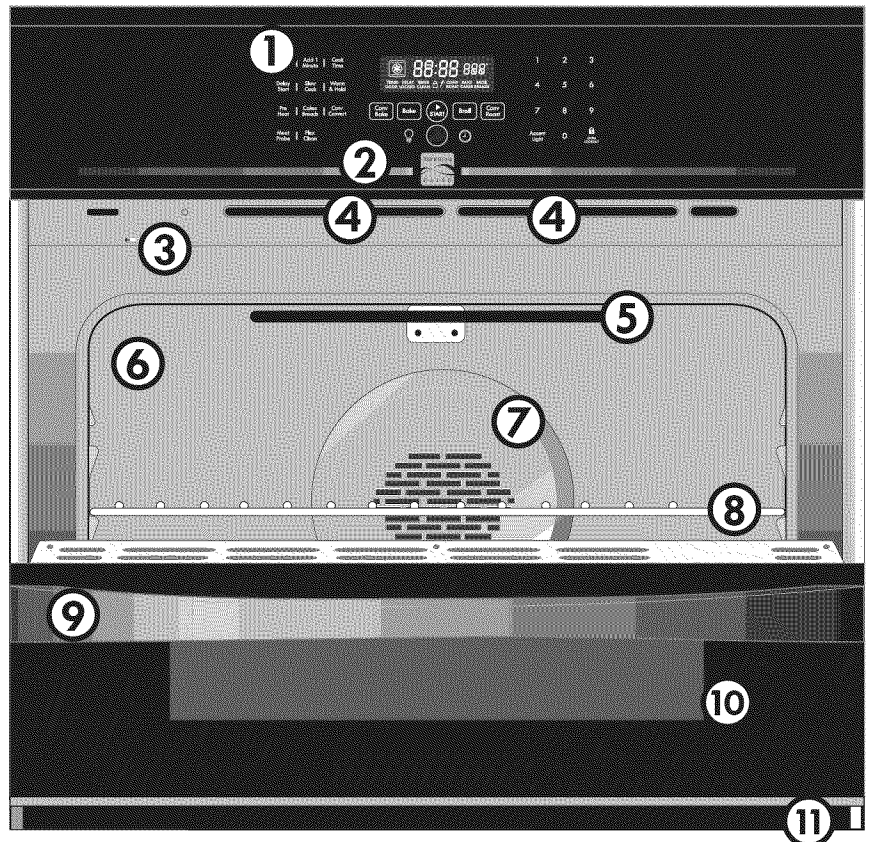

Oven Vent and Racks

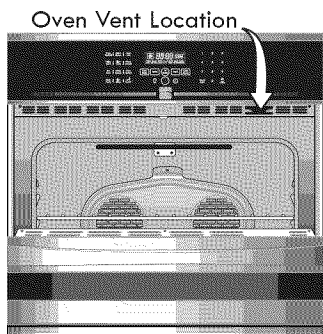

Model 790.4809*

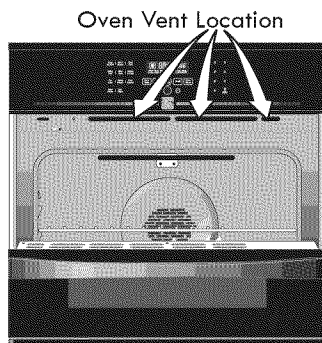

Models 790.4807* & 790.4808*

CAUTION Some models are equipped with a blower which runs in baking and self-cleaning mode to keep all internal components at a cool temperature. The blower may keep running even if the oven has been turned off, until the components have cooled down.

Oven Vent Location

The oven is vented through its upper front frame. When the oven is on, warm air is released through the vent. This venting is necessary for proper air circulation in the oven and good baking results.

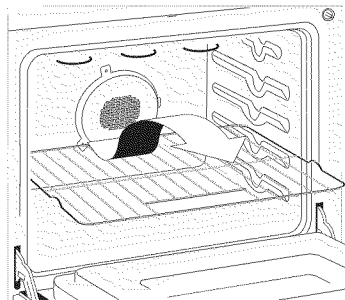

Arranging Oven Racks

Always use oven mitts when using the oven.

To remove an oven rack, pull the rack forward until it stops. Lift up front of rack and slide out.

To replace an oven rack, fit the rack onto the guides on the oven walls. Tilt the front of the rack upward and slide the rack back into place.

Types of Oven Racks

CAUTION Always use pot holders or oven mitts when adjusting the oven racks. Wait until the oven has completely cooled if possible. Oven racks may HOT and cause burns.

Your appliance may be equipped with one or more of the oven rack types shown; **Flat Handle Oven Rack** and **Offset Oven Rack** (some models). To maximize cooking space the offset rack can be used in the lowest rack position to roast large cuts of meat and poultry.

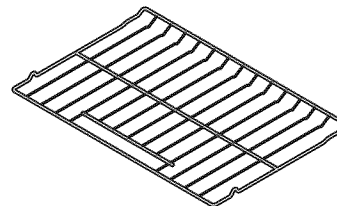

Flat Handle Oven Rack

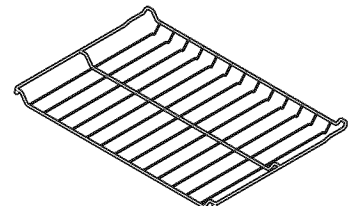

Offset Oven Rack
(some models)

Air Circulation in the Oven

If using 1 rack, place in center of oven. If using multiple racks, stagger cookware as shown.

For best air circulation and baking results allow 2-4" (5-10 cm) around the cookware for proper air circulation and be sure pans and cookware do not touch each other, the oven door, sides or back of the oven cavity. The hot air must circulate around the pans and cookware in the oven for even heat to reach around the food.

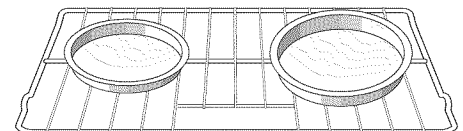

1 Oven Rack

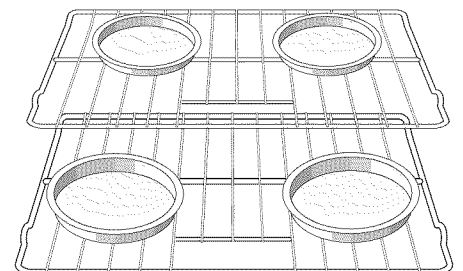

Multiple Oven Racks

Control Pad Features

READ THE INSTRUCTIONS CAREFULLY BEFORE USING THE OVEN. For satisfactory use of your oven, become familiar with the various features and functions of the oven as described below. **Detailed instructions for each feature and function follow later in this Use & Care Guide.**

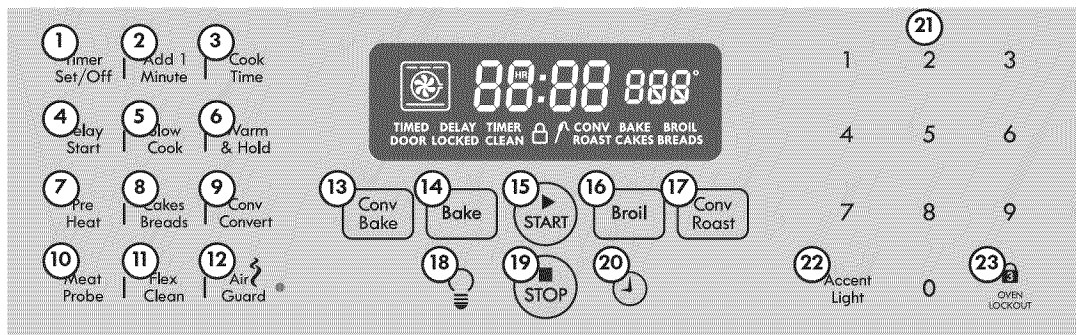

Oven Control Keypads

1. **Timer Set/Off** - Used to set or cancel Timer. The minute timer does not start or stop cooking.
2. **Add 1 Minute** - Used to add additional minutes to Timer.
3. **Cook Time** - Used to enter the length of the cook time desired.
4. **Delay Start** - Used to set the desired start time for baking. May be used with COOK TIME to program a delayed timed bake or clean cycle.
5. **Slow Cook** - Used to select the Slow Cook Feature cycle.
6. **Warm & Hold** - Used to set the Warm & Hold function.
7. **Preheat Pad** - Used to preheat the oven.
8. **Cakes or Breads** - Used to select the cakes or breads.
9. **Conv Convert** - Used to select the Convection Convert feature.
10. **Meat Probe Pad** - Used to set meat probe.
11. **Flex Clean** - Used to set a 2 to 4 hours Self-Clean cycle.
12. **Air Guard Pad & indicator light** - Used after preheat to help freshen kitchen air during cooking (some models).
13. **Conv Bake** - Used to select the Convection Bake feature.
14. **Bake** - Used to enter the normal bake feature.
15. **START** - Used to start all oven features (not used with Oven Light).
16. **Broil** - Used to select variable broil feature.
17. **Convection Roast** - Used to select the convection roast mode.
18. **Oven Light** - Used to turn oven light ON and OFF.
19. **STOP** - Used to cancel any oven function previously entered except Clock and Timer.
20. **Clock Set** - Used to set the time of day.
21. **0 thru 9 number** - Used to enter temperature and times.
22. **Accent Light** - Used to turn accent light ON and OFF.
23. **Oven Lockout** - Used to lock the oven key pads and oven door.

Minimum & maximum control settings

All of the features listed below have minimum and maximum time or temperature settings that may be entered into the control. An ENTRY acceptance beep will sound each time a control pad is touched (the Oven Lockout pad is delayed 3 seconds).

An ENTRY ERROR tone (3 short beeps) will sound if the entry of the temperature or time is below the minimum or above the maximum settings for the feature.

Feature	Min. Temp. or time	Max. temp. or time
PreHeat	170°F/77°C	550°F/288°C
Bake	170°F/77°C	550°F/288°C
Broil	400°F/205°C	550°F/288°C
Timer	0:01 Min.	11:59 Hr./Min.
Flex Clean	2 hours	4 hours
Conv Bake	170°F/77°C	550°F/288°C
Conv Convert	170°F/77°C	550°F/288°C
Conv Roast	170°F/77°C	550°F/288°C
Slow Cook	Lo (225°F/180°C)	Hi (225°F/180°C)
Cook Time	0:01 Min.	11:59 Hr./Min.
Delay Time 12 Hr.	1:00 Hr./Min.	12:59 Hr./Min.
Delay Time 24 Hr.	0:00 Hr./Min.	23:59 Hr./Min.
Meat probe target	140°F/60°C	210°F/99°C

Setting the Oven Controls

Setting the Clock

The  pad is used to set the clock. The clock may be set for 12 or 24 hour time of day operation. The clock has been preset at the factory for the 12 hour operation. When the range is first plugged in, or when the power supply to the range has been interrupted, the time in the display will flash (See Fig. 1).



Fig. 1

INSTRUCTIONS

PRESS

DISPLAY

To set the clock (example below for 1:30)





1. Press . "CLO" will appear in the display (Fig. 2).
2. Press **1 3 0** pads to set the time of day to 1:30 (Fig. 3). Press . "CLO" will disappear and the clock will start (Fig. 4).



Fig. 2

Changing between 12 or 24 hour time of day display

1. Press and hold  for 7 seconds until "12Hr dAy" or "24Hr dAy" appears in the display.
2. Press ^{Flex}Clean to switch between the 12 and 24 hour time of day display. 12Hr dAy (Fig. 5) or 24Hr dAy (Fig. 6) will be displayed.
3. Press  to accept the change or press  to reject the change.
4. Reset the correct time as described in **To set the Clock** above. Please note that if the 24 hour time of day mode was chosen, the clock will now display time from 0:00 through 23:59 hours.

 for 7 seconds

^{Flex}Clean

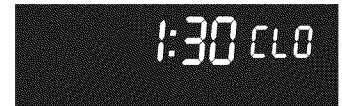

Fig. 3



Fig. 4



Fig. 5



Fig. 6

Setting Silent Control Operation



The ^{Delay}Start and ^{Flex}Clean pads control the Silent Control operation feature. The Silent Control operation feature allows the oven control to be operated without sounds or beeps whenever necessary. If desired the control can be programmed for silent operation and later returned to operating with all the normal sounds and beeps.

INSTRUCTIONS

PRESS

DISPLAY

To change control from normal sound operation to silent control operation

1. To tell if your range is set for normal or silent operation press and hold ^{Delay}Start for 7 seconds (Fig. 7).
2. Press ^{Flex}Clean to switch between normal sound operation and silent operation mode. The display will show either **bEEp On** (Fig. 8) or **bEEp OFF** (Fig. 9).
If **bEEp On** appears (Fig. 8), the control will operate with normal sounds and beeps. If **bEEp OFF** appears (Fig. 9), the control is in the silent operation mode.
3. Press  to accept the change or press  to reject the change.

^{Delay}Start for 7 seconds
^{Flex}Clean

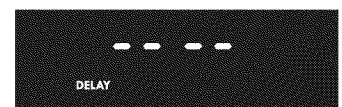

Fig. 7



Fig. 8

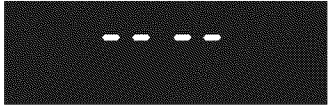









Fig. 9

Setting the Oven Controls







Setting Continuous Bake or 12 Hour Energy Saving

The ^{Timer} Set/Off and ^{Flex} Clean pads control the Continuous Bake or 12 Hour Energy Saving features. The oven control has a factory preset built-in 12 Hour Energy Saving feature that will shut off the oven if the oven control is left on for more than 11 hours and 59 minutes. The oven can be programmed to override this feature for Continuous Baking.

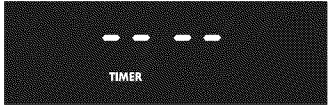
INSTRUCTIONS	PRESS	DISPLAY
To set the control for Continuous Bake or 12 Hour Energy Saving features		
1. Press and hold ^{Timer} Set/Off for 7 seconds or until the control beeps once (Fig. 1). "12Hr OFF" or "StAy On" will appear in the display and the control will beep once.	^{Timer} Set/Off for 7 seconds	 Fig. 1
2. Press ^{Flex} Clean to switch between the 12 Hour Energy Saving and continuous bake features. Note: "12Hr OFF" (Fig. 2) in the display indicates the control is set for the 12 Hour Energy Saving mode and "StAy On" (Fig. 3) indicates the control is set for the Continuous Bake feature.	^{Flex} Clean	 Fig. 2
3. Press  to accept the change (Fig. 4; display will return to time of day) or press  to reject the change.	 or 	 Fig. 3  Fig. 4

Setting Timer

The **TIMER** ^{Timer} Set/Off pad controls the Timer feature. The Timer serves as an extra timer in the kitchen that will beep when the set time has run out. It does not start or stop cooking. The Timer feature can be used during any of the other oven control functions. Refer to "Minimum and Maximum Control Pad Settings" for time amount settings.

INSTRUCTIONS	PRESS	DISPLAY
To set the Kitchen Timer (example for 5 minutes)		
1. Press ^{Timer} Set/Off (Fig. 5).	^{Timer} Set/Off	 Fig. 5
2. Press the number pads to set the desired time in the display (example 5). Press  . The time will begin a count down (Fig. 6).		 Fig. 6
Note: If  is not pressed the timer will return to the time of day after 25 seconds.		
3. When the set time has run out, the clock will sound with 3 long beeps every 5 seconds until ^{Timer} Set/Off is pressed (Fig. 7).	^{Timer} Set/Off	 Fig. 7
To cancel the Timer before the set time has run out		
Press ^{Timer} Set/Off. The display will return to the time of day.	^{Timer} Set/Off	









To Set Add 1 Minute Feature

The ^{Add 1} Minute pad is used to set the Add 1 Minute feature. When the ^{Add 1} Minute pad is pressed, 1 minute is added to the Timer feature if this feature is already active. If the Timer feature is not active and the ^{Add 1} Minute pad is pressed, the Timer feature will become active and will begin counting down from 1 minute. For further information on how to set the Timer feature see Setting Timer instructions above.

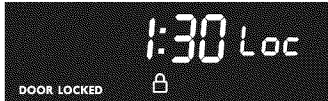

Setting the Oven Controls



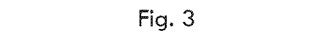







Setting Oven Lockout Feature

The  pad controls the Oven Lockout feature. The Oven Lockout feature automatically locks the oven door and prevents the oven from being turned on. It does not disable the clock, Timer or the interior oven lights.

INSTRUCTIONS	PRESS	DISPLAY
To activate the Oven Lockout feature	 for 3 seconds	
<ol style="list-style-type: none"> 1. Press and hold  for 3 seconds. 2. After 3 seconds a beep will sound, door Loc will appear (Fig. 1) and DOOR LOCKED will flash in the display. Once the oven door is locked the DOOR LOCKED indicator will stop flashing (Fig. 2). 	 for 3 seconds	
To reactivate normal oven operation:	 for 3 seconds	
<ol style="list-style-type: none"> 1. Press and hold  for 3 seconds. A beep will sound. The DOOR LOCKED will continue to flash until the oven door has completely unlocked (Fig. 3). 2. The oven is again fully operational. 		

Setting Temperature Display — Fahrenheit or Celsius:

The  and  pads control the Fahrenheit or Celsius temperature display modes. The oven control can be programmed to display temperatures in Fahrenheit or Celsius. The oven has been preset at the factory to display in Fahrenheit.

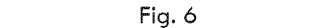
INSTRUCTIONS	PRESS	DISPLAY
To change display from Fahrenheit to Celsius or Celsius to Fahrenheit		
<ol style="list-style-type: none"> 1. To tell if the display is set for Fahrenheit or Celsius press  (Fig. 4) and hold for 7 seconds; "550°" will first appear in the display and then beep will sound. If "F" appears, the display is set to show temperatures in Fahrenheit (Fig. 5). If "C" appears, the display is set to show temperatures in Celsius (Fig. 6). 		
<ol style="list-style-type: none"> 2. Press  to switch between Fahrenheit or Celsius display modes. The display will show either "F" (Fig. 5) or "C" (Fig. 6). 	 or 	
<ol style="list-style-type: none"> 3. Press  to accept the change or press  to reject the change. 		





Setting the Oven Controls

Setting Accent Light

Your appliance includes a decorative Accent Light centered horizontally across touch-sensitive control panel. The Accent light comes with a theatre style intensity feature that slowly increases brightness at turn on and slowly fades when turning off.

When the Accent light is off, the light is in automatic mode. This means the Accent light will turn on automatically when an oven or Timer has been activated. The Accent light will turn off automatically when these functions are no longer active.

When the Accent light is OFF, it may be turned ON by pressing ^{Accent}Light once. When the Accent light has been manually turned on, it will remain on until manually turned off by pressing ^{Accent}Light again. The brightness may also be adjusted.

INSTRUCTIONS	PRESS	DISPLAY
Example - To adjust the Accent light brightness:		
1. Press and hold ^{Accent} Light until an acceptance tone sounds (about 6 seconds)	^{Accent} Light	
2. The default setting of 100 will appear in the display (See Fig. 1).	Value between	Fig. 1
3. Using the numeric keypad, enter any digit from 0 to 100 to change the brightness level. Entering 0 (Fig. 2) will effectively turn the Accent light OFF until the brightness level is adjusted to a higher level.	0 to 100	
4. Press  to save the desired brightness setting.		Fig. 2

Operating Oven Lights

The interior oven lights will turn ON when the oven door is opened.

Press  to turn oven light ON an OFF whenever the oven door is closed.









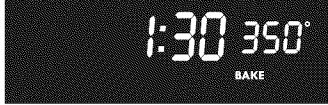

The interior oven lights are located on the rear wall of the oven interior and are covered with a glass shield. The glass shield protects the bulb from high temperatures and should always be in place whenever the oven is in use.

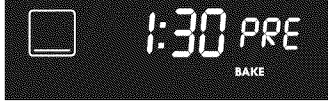
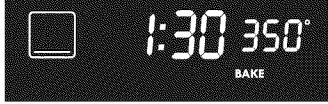
To replace the interior oven lights, see **Replacing oven lights** in the Care and Cleaning section.

Setting the Oven Controls

Setting Preheat

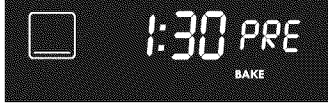
The ^{Pre}Heat pad controls the Preheat feature. The Preheat feature will bring the oven up to temperature and then indicate when to place the food in the oven. Preheating is not necessary when roasting or cooking casseroles. The oven can be programmed to preheat at any temperature between 170°F to 550°F.

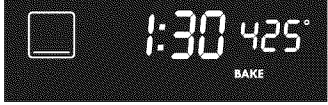
INSTRUCTIONS	PRESS	DISPLAY
To set the Preheat temperature for 350°F		
1. Arrange the interior oven racks. 2. Press ^{Pre} Heat. " 350 " (the default oven temperature set) and " BAKE " will appear in the display (Fig. 1).	Pre Heat	
3. Press  . " BAKE " will appear in the display. " PRE " and the actual oven temperature shown in the display will alternate as the oven heats and reaches 350°F (Fig. 2).		
Note: After the oven has reached the desired temperature (this example, 350°F) the control will sound a long beep, the " PRE " will turn off and oven temperature will be displayed (Fig. 3). When PRE disappears from the display, the oven set temperature has been reached. Once the oven has preheated, PLACE FOOD IN THE OVEN.		
Press  when baking is complete or to cancel the preheat feature.		Fig. 3
To change Preheat temperature while oven is preheating (example: changing from 350°F to 425°F)		
If it is necessary to change the preheat temperature while the oven is preheating to the original temperature:		
1. While preheating, press ^{Pre} Heat again (Fig. 3)		
2. Enter the new preheat temperature. Press 4 2 5 . " 425° " will appear in the display (Fig. 4).	4 2 5	Fig. 4
3. Press  . " PRE " will appear in the display as the oven heats to 425°F (Fig. 5). A long beep will sound once the oven temperature reaches 425°F (Fig. 6).		
4. When baking is complete press  .		
Note: During the first rise of temperature, the convection fan will be activated to allow the oven to reach its target temperature faster. The Bake, Broil and Convection elements will also cycle for a better heat distribution.		Fig. 6

Setting Oven Controls

Important Things to Know Before Setting any Basic Oven Cooking Function

This appliance has been factory pre-set to start any **BAKE, CONV BAKE, CONV ROAST, PREHEAT, CAKES** or **BREADS** function with the oven set temperature automatically set for 350°F. However if desired, the oven set temperature may be adjusted at any time during the cooking process. You may also choose to add a **COOK TIME** or **DELAY START** with any of the functions listed above.

Temperature Visual Display

Your oven is equipped with a temperature visual display. When a cooking mode is set, the actual temperature will be shown in the display and will rise as the unit preheat. When the unit has reached its target temperature, a chime will sound to remind you to place the food in the oven. This feature will be active with some cooking modes; bake, convection bake, convection roast, cakes and breads. NOTE: The lowest temperature that can be displayed is 100°F.



Using the AirGuard feature (some models)















Your appliance is equipped with a catalytic oven exhaust cleaner that may be turned on during any cooking process. This feature helps remove smoke and eliminates 85% of the odors generated when using your oven. DO NOT use AirGuard when baking delicate bakery items.

If you wish to have AirGuard clean the oven exhaust once cooking has started, press .

Note: The AirGuard indicator light will glow anytime AirGuard is active. AirGuard will automatically turn on and cannot be manually turned off during the Self-Cleaning cycle.

Setting Bake

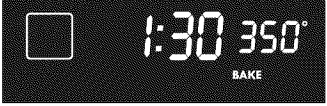
The **BAKE**  pad controls normal baking. If preheating is necessary, refer to the **Pre Heat**  Preheat Feature for instructions. The oven can be programmed to bake at any temperature from 170° F to 550° F (the sample shown below is for 350°F).

INSTRUCTIONS	PRESS	DISPLAY
To set the Bake Temperature to 350°F 1. Arrange interior oven racks and place food in oven. 2. Press  , 350 will automatically appear in the display (Fig. 1). 3. Press  . The actual temperature will be displayed (Fig.2). A long beep will sound once the oven set temperature reaches 350°F and the display will show 350 and BAKE (Fig. 3). Note: Pressing  will cancel the Bake feature at any time.	  	 Fig. 1  Fig. 2  Fig. 3
To change the Bake Temperature (example: changing from 350°F to 425°F) 1. After the oven has already been set to bake at 350°F and the oven temperature needs to be changed to 425°F, press  (Fig. 4). 2. Press 4 2 5 (Fig. 5). 425° will appear in the display. 3. Press  . 4. The oven is now set for 425°F. Note: During the first rise of temperature, the convection fan will be activated to allow the oven to reach its target temperature faster. The Bake, Broil and Convection elements will also cycle for a better heat distribution.	 4 2 5 	 Fig. 4  Fig. 5

Setting Oven Controls

Oven Baking



For best cooking results, heat the oven before baking cookies, breads, cakes, pies or pastries, etc. There is no need to preheat the oven for roasting meat or baking casseroles.

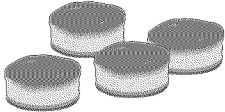
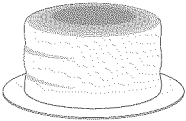
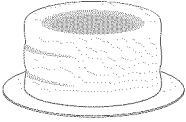
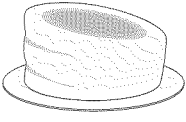
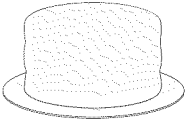











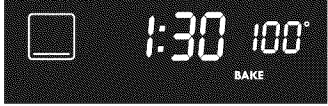

The cooking times and temperatures needed to bake a product may vary slightly from your previously owned appliance.

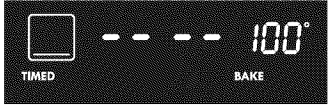
Baking Problems and Solutions Chart		
Baking Problems	Causes	Corrections
<p>Cookies and biscuits burn on the bottom.</p> 	<ul style="list-style-type: none"> • Cookies and biscuits put into the oven before the preheating time is completed. • Oven rack overcrowded. • Dark pan absorbs heat too fast. 	<ul style="list-style-type: none"> • Allow oven to preheat to the selected temperature before placing food in oven. • Choose pan sizes that will permit 5.1 cm to 10.2 cm (2" to 4") of air space on all sides when placed in the oven. • Use a medium-weight aluminum baking sheet.
<p>Cakes too dark on top or bottom.</p> 	<ul style="list-style-type: none"> • Cakes put into the oven before preheating time is completed. • Rack position too high or low. • Oven too hot. 	<ul style="list-style-type: none"> • Allow oven to preheat to the selected temperature before placing food in the oven. • Use proper rack position for baking needs. • Set oven temperature 25°F/12°C lower than recommended.
<p>Cakes not done in the center.</p> 	<ul style="list-style-type: none"> • Oven too hot. • Incorrect pan size. • Pan not centered in oven. 	<ul style="list-style-type: none"> • Set oven temperature 25°F/12°C lower than recommended. • Use pan size suggested in recipe. • Use proper rack position and place pan so there is 5.1 cm to 10.2 cm (2" to 4") of space on all sides of pan.
<p>Cakes not level.</p> 	<ul style="list-style-type: none"> • Range not level. • Pan too close to oven wall or rack overcrowded. • Pan warped. 	<ul style="list-style-type: none"> • Place a marked glass measuring cup filled with water on the center of the oven rack. If the water level is uneven, refer to the installation instructions for leveling the range. • Be sure to allow 5.1 cm to 10.2 cm (2" to 4") of clearance on all sides of each pan in the oven. • Do not use pans that are dented or warped.
<p>Foods not done when cooking time is up.</p> 	<ul style="list-style-type: none"> • Oven too cool. • Oven overcrowded. • Oven door opened too frequently. 	<ul style="list-style-type: none"> • Set oven temperature 25°F/12°C higher than suggested and bake for the recommended time. • Be sure to remove all pans from the oven except the ones to be used for baking. • Open oven door only after shortest recommended baking time.

Setting Oven Controls

Setting Cook Time

The  and  pads control the Cook Time feature. The automatic timer of the Cook Time feature will turn the oven OFF after cooking for the desired amount of time you selected.

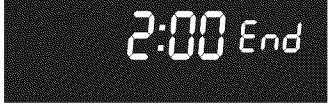
INSTRUCTIONS	PRESS	DISPLAY
<p>To program the oven to begin baking immediately and to shut off automatically (example: BAKE at 350°F for 30 minutes)</p>		 <p>Fig. 1</p>
<p>1. Be sure the clock is set for the correct time of day. 2. Arrange interior oven rack(s) and place the food in the oven. 3. Press  (See Fig. 1). 4. Press . "BAKE" and the actual oven temperature will appear in the display (See Fig. 2).</p>	 	 <p>Fig. 2</p>
<p>5. Press  (See Fig. 3). 6. Enter the desired baking time by pressing 3 0. Note: Baking time can be set for any amount of time between 1 minute to 11 hours and 59 minutes (See Fig. 4).</p>	 3 0	 <p>Fig. 3</p>
<p>7. Press  (See Fig. 5). Note: After the Cook Time feature has activated, press  to display the bake time remaining in the Cook Time mode. Once Cook Time has started baking, a long beep will sound when the oven temperature reaches the set temperature.</p>		 <p>Fig. 4</p>
<p>Press  when baking has finished or at any time to cancel the Cook Time feature.</p>		 <p>Fig. 5</p>
<p>When the Cook Time finishes:</p> <p>1. "End" and the time of day will show in display. The oven will shut off automatically (Fig. 6). 2. The control will beep 3 times. The control will continue to beep 3 times every 30 seconds until  is pressed.</p>		 <p>Fig. 6</p>

Important notes:











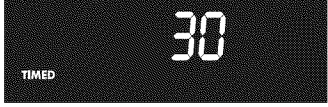





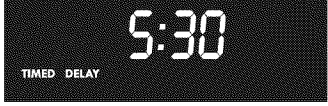

- The cook time feature may be set with Bake, Conv Bake, Conv Roast, Slow Cook and Preheat. Cook time or Delay Start will not operate with the Broil function.
- The maximum default Cook Time setting is 11 hours and 59 minutes.
- After Cook Time feature has been activated, press the Cook Time keypad to display any cook time remaining.
- Dark or dull pans absorb more heat than shiny bakeware resulting in dark or overbrowning of foods. It may be necessary to reduce the oven temperature or cook time to prevent overbrowning of some foods. Dark pans are recommended for pies. Shiny pans are recommended for cakes, cookies or muffins.

CAUTION Use caution with the **COOK TIME** or **DELAY START** functions. Use the **COOK TIME** function when cooking cured or frozen meats and most fruits and vegetables. Foods that can easily spoil such as milk, eggs, fish, meat or poultry, should be chilled in the refrigerator first. Even when chilled, they should not stand in the oven for more than 1 hour before cooking begins, and should be removed **PROMPTLY** when cooking is completed. Eating spoiled food can result in sickness from food poisoning.

Setting Oven Controls

Setting Delay Start

The ^{Delay}Start pads control the **Delay Start** feature. The automatic timer of the Delay Start feature will turn the oven ON and OFF at the times you select in advance.

INSTRUCTIONS	PRESS	DISPLAY
<p>To program the oven for a delayed BAKE start time and to shut off automatically (example: baking at 375°F for 30 minutes and starting at 5:30)</p>		 <p>Fig. 1</p>
<ol style="list-style-type: none"> 1. Be sure that the clock is set with the correct time of day. 2. Arrange interior oven rack(s) and place the food in the oven. 3. Press ^{Cook}Time (Fig. 1). 4. Enter the desired baking time using the number key pads by pressing 3 0 (Fig. 2). Note: Baking time may be set for any amount of time from 1 minute to 11 hours and 59 minutes. 	<p>Cook Time</p>	 <p>Fig. 2</p>
<ol style="list-style-type: none"> 5. Press  (Fig. 3). 6. Press ^{Delay}Start (Fig. 4). 7. Enter the desired start time using the number pads by pressing 5 3 0 (Fig. 5). 	<p> Delay Start</p>	 <p>Fig. 3</p>
<ol style="list-style-type: none"> 8. Press  (Fig. 6). 9. Press  (Fig. 7). 	<p>5 3 0  </p>	 <p>Fig. 4</p>
<ol style="list-style-type: none"> 10. Press 3 7 5. 11. Press  (Fig. 8). 	<p>3 7 5 </p>	 <p>Fig. 5</p>
<p>Note: Once Delay Start has started, press ^{Cook}Time to display the bake time remaining. Once the Delay Start has started baking, a long beep will sound when the oven temperature reaches the set temperature.</p>		 <p>Fig. 6</p>
<p>Press  when baking has completed or at any time to cancel the Delay Start feature.</p>	<p></p>	 <p>Fig. 7</p>
<p>When the set bake time runs out:</p> <ol style="list-style-type: none"> 1. «End» will appear in the display. The oven will shut off automatically (Fig. 9). 2. The control will beep 3 times. The control will continue to beep 3 times every 30 seconds until  is pressed. 		 <p>Fig. 8</p>
<p>Important notes:</p> <ul style="list-style-type: none"> • Delay Start may be using a 24 hour clock. See setting 12 or 24 hour display modes for more information • The Delay Start feature may be used with Bake, Conv Bake, Conv Roast, Conv Convert, Slow Cook and Flex Clean functions. Delay Start or Cook Time will not operate with the Broil function. 		 <p>Fig. 9</p>

Setting Oven Controls

Setting Broil

The  pad controls the Broil feature. When broiling, heat radiates downward from the oven broiler for even coverage. The Broil temperature is preset to start broiling at 550°F, however, the Broil temperature may be set at any temperature between 400°F and 550°F.

The broil pan and broil pan insert used together allow dripping grease to drain and be kept away from the high heat of the oven broiler. **DO NOT** use the broil pan without the insert (See Figure 5). **DO NOT cover the broil pan insert with foil.** The exposed grease could catch fire.

⚠ WARNING Should an oven fire occur, leave the oven door closed and turn off the oven. If the fire continues, throw baking soda on the fire or use a fire extinguisher. **DO NOT** put water or flour on the fire. Flour may be explosive and water can cause a grease fire to spread and cause personal injury.

INSTRUCTIONS

PRESS

DISPLAY

To set the oven to broil at 550°F



- Place the broiler pan insert on the broiler pan. Then place the food on the broiler pan insert. **DO NOT** use the broiler pan without the insert. **DO NOT** cover the broiler insert with foil. The exposed grease could ignite.
- Arrange the interior oven rack and place the broiler pan on the rack. Be sure to center the broiler pan directly under the broiler element. **Make sure the oven door is in the broil stop position** (See Figure 4). Preheat the oven for 5 minutes.
- Press  (Fig. 1).
- If a lower broil temperature is desired (minimum broil temperature setting is 400°F), press the desired temperature before continuing to step 5.
- Press . The oven will begin to broil. "BROIL" and "550°" will appear in the display (Fig. 2).
- Broil on one side until food is browned; turn and cook on the second side. Season and serve. **Note:** Always pull the rack out to the stop position before turning or removing food.
- To cancel broiling press  (Fig. 3).



Fig. 1



Fig. 2



Fig. 3

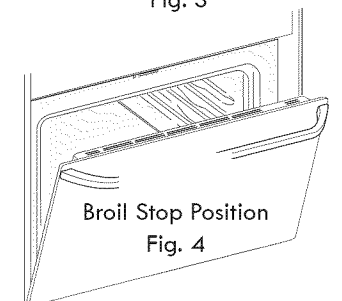

Broil Stop Position
Fig. 4

Broiling Times and Searing Grill (if equipped)

Use the following table for approximate broiling times. Increase or decrease broiling times, or move the broiling pan to a different rack position to suit for doneness. If the food you are broiling is not listed in the table, follow the instructions provided in your cookbook and watch the item closely. Use the Searing Grill for meats and steaks if desired. Before placing the meat, be sure to heat the Searing Grill using Broil for 10 minutes. Cook times should be reduced 1-2 minutes per side when cooking with the Searing Grill. Place Searing Grill on top of Broiler Pan and insert for meats and steaks (See Fig. 6).

Electric Range Broiling Table Recommendations

Food Item	Rack Position	Temp Setting	Cook Time		Doneness
			Doneness		
Steak 1) thick	2nd	550° F	6:00	4:00	Rare
	2nd	550° F	7:00	5:00	Medium
Pork Chops 3/4) thick	2nd	550° F	8:00	6:00	Well
Chicken - Bone In	3rd	450° F	20:00	10:00	Well
Chicken - Boneless	2nd	450° F	8:00	6:00	Well
Fish	2nd	500° F	13:00	n/a	Well
Shrimp	3rd	550° F	5:00	n/a	Well
Hamburger 1) thick	2nd	550° F	9:00	7:00	Medium
	3rd	550° F	10:00	8:00	Well

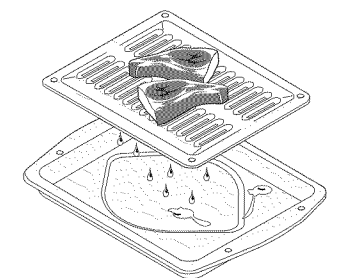

Supplied with some models

Fig. 5

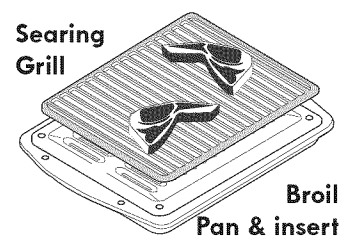

Supplied with some models

Fig. 6

Setting Oven Controls

Setting Convection Bake

The  pad controls the **Convection Bake** feature. Use the **Convection Bake** feature when cooking speed is desired. The oven can be programmed for Convection baking at any temperature between 170° F (77°C) to 550° F (288°C).

Convection baking uses a fan to circulate the oven's heat evenly and continuously within the oven (See Fig. 1). This improved heat distribution allows for even cooking and excellent results using multiple racks at the same time. Foods cooked on a single oven rack will generally cook faster and more evenly with **convection bake**. Multiple oven rack cooking may slightly increase cook times for some foods, but the overall result is time saved. Breads and pastries brown more evenly.

Tips for Convection Bake

1. Time reductions will vary depending on the amount and type of food to be cooked. Cookies and biscuits should be baked on pans with no sides or very low sides to allow heated air to circulate around the food. Food baked on pans with a dark finish will cook faster.
2. Preheating is not necessary when cooking casseroles with **Convection Bake**.
3. When using **Convection Bake** with a single rack, place oven rack in position 2 or 3. If cooking on multiple racks, place the oven racks in positions 2 and 4.

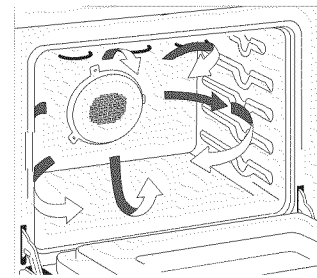

Air circulation during Convection Bake

Fig. 1 4th Rack position

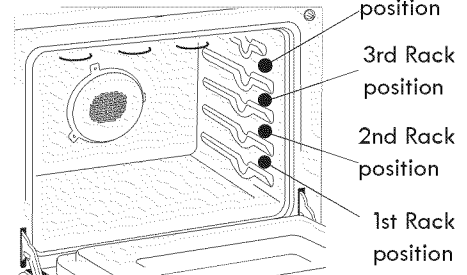





Fig. 2

Benefits of Convection Bake:

- Multiple rack baking.
- No special pans or bakeware needed.

INSTRUCTIONS

To set the oven for Convection Bake and temperature to 375°F

1. Arrange interior oven racks and place food in oven.
 2. Press  (Fig. 3).
 3. Press **3 7 5** (Fig. 4).
 4. Press . The actual oven temperature will be displayed (Fig. 5).
- Note: The oven icon will show a rotating fan within a square. This rotating fan icon indicates when the Convection Fan is operating.
- Press  to stop **Convection Bake** or cancel **Convection Bake** at any time.

PRESS



3 7 5



DISPLAY

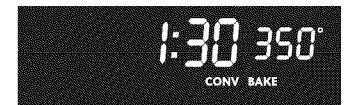

Fig. 3



Fig. 4













Fig. 5

Setting Oven Controls



Setting Convection Convert feature

The ^{Conv} Convert pad is used to automatically convert a standard **Baking** recipe for convection baking. When set properly, this feature is designed to display the oven set converted (reduced) temperature in the display. Convection Convert **MUST** be used with the **Convection Bake** keypad. Cook Time or Delay Start function may be added.

INSTRUCTIONS	PRESS	DISPLAY
Using Convection Convert feature to adjust oven temperature from a Bake recipe (example below when setting oven for 350°)		
1. Arrange interior oven racks and place food in oven.		Fig. 1
2. Press  (Fig. 1). If a Cook Time or Delay Start is desired, enter the times now.		
3. Press ^{Conv} Convert, " CONV BAKE " and the oven temperature adjustment will appear briefly in the display (for this example it is 325°F). A beep will sound once the adjusted oven temperature is reached (Fig. 2).	^{Conv} Convert 	Fig. 2
Note: When used with a Cook Time or a Delay Start setting, the Convection Convert feature will display a "CF" for check food when the bake time is 75% complete (Fig. 3). At this time the oven control will sound 3 long beeps at regular intervals until baking has finished. When the bake time has completely finished the control will display "End" and will sound 3 long beeps every 30 seconds until the  pad is pressed (Fig. 4).		
The oven icon will show a rotating fan within the square. This rotating fan icon indicates when the Convection Fan is operating (see Figs 2 or 3).		Fig. 3
Press  to cancel Convection feature at any time.		
Note: The minimum amount of cook time using the Convection Convert feature with a Cook Time or Delay Start function is 20 minutes.		Fig. 4

Setting Oven Controls

Setting the Food Categories Features

The  and  pads may be used when cooking certain food items. These pads have been designed to give optimum baking performance for the foods selected in each category.



The **CONV ROAST** pad combines a cook cycle with the convection fan and element to roast meats and poultry. Preheating is not necessary for meats and poultry. Heated air circulates around the food from all sides, sealing in juices and flavors. Foods are crisp brown on the outside while staying moist on the inside. **DO NOT** cover food during convection roast.

The **CAKES** feature provides a preheat with a gentle cycling of heat giving cakes more volume and allowing delicate foods to cook more evenly.

The **BREADS** feature adds a special preheat feature to the bake cycle to thoroughly heats the oven from top to bottom to give more evenly browned foods.

INSTRUCTIONS	PRESS	DISPLAY
--------------	-------	---------

Example - To Set the Convection Roast feature at 375°F

1. Arrange oven racks.
 2. Press  (Fig. 1).
 3. Enter the desired roasting temperature using the number pads **3 7 5**.
 4. Press  (Fig. 2). The actual oven temperature, **CONV ROAST** and the fan icon will be displayed.
- Press  to stop Convection Roast at any time.



3 7 5



Fig. 1



Fig. 2







Fig. 3



Fig. 4

Example - To Set the Cakes or Breads features

1. Arrange oven racks.
 2. For Cakes, press  until **CAKES** appears in the display (Fig. 3).
For Breads, press  until **BREADS** appears in the display. (Fig. 4)
 3. Press .
- Press  to cancel **Cakes** or **Breads** at any time.

Cakes
Breads

Cakes
Breads



Recommended foods to be cooked in each category	CONV ROAST	CAKES	BREADS
Fig. 3	Meat Poultry	Cakes Brownies Pies (fresh & Frozen) Baked Custards Cheesecake	Breads Rolls Biscuits Muffins Cornbread

Roasting Rack Instructions (if equipped)

When preparing meats for convection roasting, use broiler pan and insert along with the roasting rack. The broiler pan will catch grease spills and the insert will prevent grease splatters. The roasting rack will allow the heat to circulate around the meat.

WARNING To prevent food from contacting the broil element and to prevent grease splattering, **DO NOT** use the roasting rack when broiling.

1. Place oven rack on bottom or next to the bottom rack position. Heated air to circulate under the food for even cooking and helps to increase browning on the underside. Make sure the roasting rack is securely seated on the insert in the broiler pan. **DO NOT** use the broiler pan without the insert. **DO NOT** cover the insert with aluminum foil.
2. Position food (fat side up) on the roasting rack (Fig. 4).
3. Place the broiler pan on the oven rack.

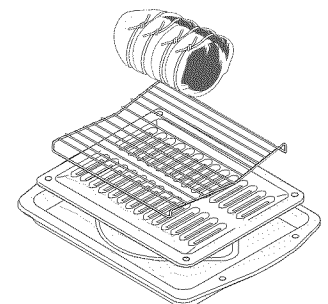

Supplied with some model

Fig. 4

Setting Oven Controls

Using and Setting Meat Probe

Checking the internal temperature of your food is the most effective way of insuring that your food has been properly cooked. When cooking meat such as roasts, hams or poultry you can use the meat probe to check the internal temperature without any guesswork. For some foods, especially poultry and roasts, testing the internal temperature is the best method to insure properly cooked meats.

Important things to consider:

- Use only the probe supplied with your appliance; any other may result in damage to the probe or the appliance.
- Handle the probe carefully when inserting and removing from the food or the receptacle.
- Do not use tongs to pull the cable when inserting or removing the probe from the food or the receptacle.
- Defrost your food completely before inserting the probe to avoid damaging probe.
- Never leave or store the probe inside the oven when not in use.
- To prevent the possibility of burns, after cooking carefully unplug the probe using a pot holder.

Proper Meat Probe placement:

- Always insert the probe so that the tip rests in the center of the thickest part of the meat. Do not allow the probe to touch bone, fat, gristle or the pan.
- For bone-in ham or lamb, insert the probe into the center of the lowest large muscle or joint . For dishes such as meat loaf or casseroles, insert the probe into the center of the food. To find the center of the food visually measure with the probe (See Fig. 1). When cooking fish, insert the probe just above the gill.
- For whole poultry or turkey, insert the probe into the thickest part of the inner thigh, below the leg (See Fig. 2).

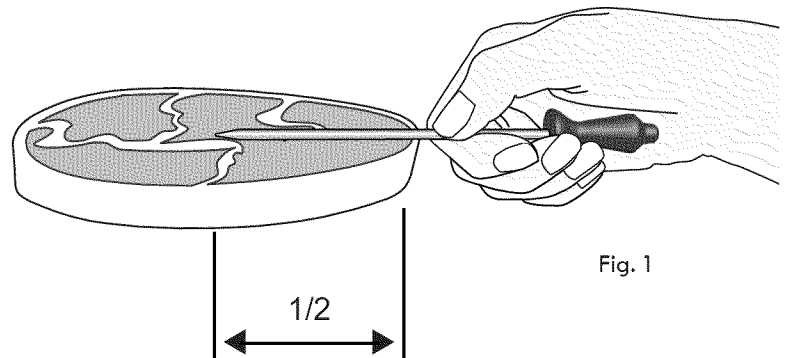

Fig. 1

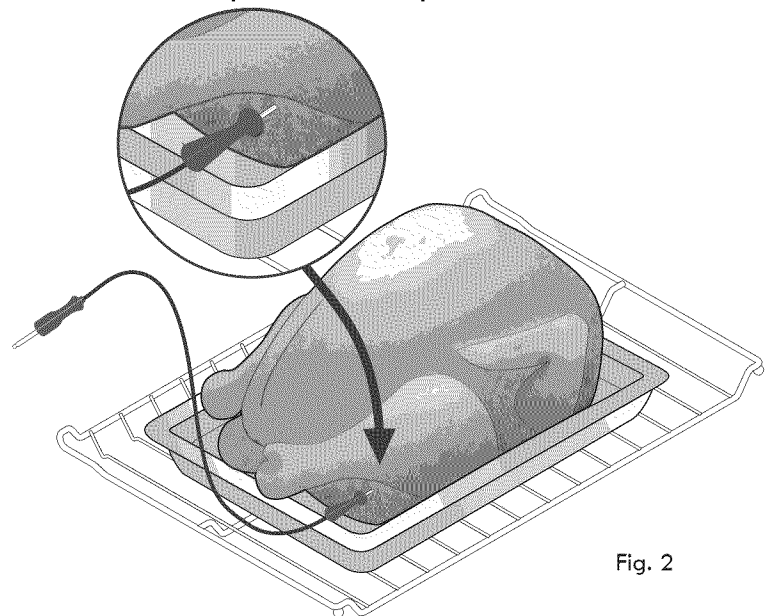







Fig. 2

Setting Oven Controls

Using and Setting Meat Probe



To use the meat probe:

1. Prepare the food and properly insert the temperature probe into the food. **DO NOT PREHEAT** or start cooking **before** properly inserting the meat probe. The probe should be inserted into the food and receptacle while the oven is still cool.
2. Place the prepared food on the desired oven rack position and slide into the oven.
3. Plug the meat probe into the probe receptacle located on the left front oven cavity side.
4. Close the oven door.
5. The oven control will detect if the meat probe is correctly plugged in and will illuminate with  icon in the display.
6. The actual meat probe temperature will appear in the display.
7. To set the target temperature press ^{Meat}Probe pad once then enter the desired the desired target internal temperature using the numeric key pads (default setting is 170°F/77°C)*. Press  to accept the meat probe target temperature.
8. Set the oven control for ,  or  and the desired oven temperature. You may use the meat probe with some other baking features but not be set with **Broil** or **Flex-Clean**.
9. During the cooking process the actual meat probe temperature will be displayed.
10. If the target temperature needs to be changed during the cooking process, press ^{Meat}Probe and use the numeric keypads to adjust the target temperature. Press the  key to accept the change.

* Setting the oven to automatically stop cooking after reaching meat probe target temperature:

The oven leaves the factory preset to alert you when the internal target temperature has been reached and to continue with the keep warm feature. You may desire to change how your oven reacts when using the meat probe.

Note: Changing how the meat probe reacts must be done before starting the cooking process.

1. To set oven to shut-off the baking function and continue in keep warm after reaching the Meat Probe target temperature press ^{Meat}Probe and hold for 7 seconds then use the ^{Flex}Clean key toggle to the message CAnCEL then press  to accept.
2. Use the ^{Flex}Clean key to toggle back to COnTInU and then press  to accept if you wish for the oven to continue cooking after the meat probe reaches the target temperature.

Setting Oven Controls









Setting the Slow Cook Feature

The ^{Slow}Cook pad is used to activate this feature. The **Slow Cook** feature may be used to cook foods more slowly, at lower oven temperatures and provides cooking results much the same way as a Slow Cooker or Crock-Pot. The **Slow Cook** feature is ideal for roasting beef, pork & poultry. Slow Cooking meats may result in the exterior of meats becoming dark but not burnt. This is normal.

There are 2 settings available, high (**Hi**) or low (**Lo**). The low setting is best for cooking foods from an 8 to 9 hour time period. The high setting is best for cooking foods from a 4 to 5 hour time period. The maximum cook time for the **Slow Cook** feature is 12 hours unless the oven control has been changed to the **Continuous Bake** mode. This feature may be used with the additional settings of a **Cook Time** or a **Delay Start**.

Below is a list of preparation and cooking tips you should review for best possible results using Slow Cook:

- Completely thaw all frozen foods before cooking with the **Slow Cook** feature.
- When using a single rack, place in position 2 or 3.
- Position multiple racks to accommodate size of cooking utensils when cooking multiple food items.
- Do not open the oven door often or leave the door open when checking foods. If the oven heat escapes often, the **Slow Cook** time may need to be extended.
- Cover the foods to keep them moist or use a loose or vented type cover to allow foods to turn crisp or brown.
- Cook times will vary; depending on the weight, fat content, bone & the shape of the meat.
- Use the recipe's recommended food temperature and a food thermometer to determine when the food is done.
- Preheating the oven will not be necessary when using the Slow Cook feature.
- Add any cream or cheese sauces during the last hour of cooking.

INSTRUCTIONS	PRESS	DISPLAY
To Program the Oven to begin baking with the Slow Cook feature		
1. Place the food in the oven.		
2. Press ^{Slow} Cook. "SLO" and "Hi" (Fig. 1) will appear in the display (If no further keypads are touched within 25 seconds the request for Slow Cook will clear).		 Fig. 1
3. If a Lo setting is desired, press the ^{Slow} Cook pad a 2nd time to set the Slow Cook feature at a low setting "SLO" and "Lo" will appear in the display (Fig. 2).		 Fig. 2
4. Press  . The slow cook feature will activate (Fig. 3).		
5. If desired, add any Cook Time or Delay Start settings at this time.		
6. To cancel the Slow Cook feature press  at anytime.		 Fig. 3

Setting Oven Controls



Setting the Warm & Hold™ Feature

The ^{Warm} & Hold pad turns ON the **Warm & Hold** feature and will maintain an oven temperature of 170°F (77°C). The **Warm & Hold** feature will keep oven baked foods warm for serving up to 3 hours after cooking has finished. After 3 hours the **Warm & Hold** feature will shut the oven OFF. The **Warm & Hold** feature may be used without any other cooking operations or may be used after cooking has finished using **Cook Time** or **Delay Start**.

INSTRUCTIONS

PRESS



To set Warm & Hold

1. Arrange interior oven racks and place baked food in oven. If food is already in the oven go to step 2
2. Press ^{Warm} & Hold.
Note: If no pad is touched within 25 seconds the request to turn ON **Warm & Hold** feature will be cancelled.
3. Press .
4. To turn the **Warm & Hold** OFF at any time press . **Note:** The **Warm & Hold** feature will automatically turn OFF after 3 hours.

Warm
& Hold



To set Warm & Hold to turn ON automatically

1. Arrange interior oven racks and place food in oven. Set the oven properly for **Cook Time** or **Delay Start with Cook Time**.
2. Press ^{Warm} & Hold.
Note: If no pad is touched within 25 seconds the request to turn ON **Warm & Hold** feature will be cancelled.
3. Press .
4. To turn the **Warm & Hold** feature OFF at any time press . **Note:** The **Warm & Hold** feature will automatically turn OFF after 3 hours.

Warm
& Hold







Pressing  at any time will stop all oven baking operations.













Setting Oven Controls

To Set the Sabbath Feature (for use on the Jewish Sabbath & Holidays)

The ^{Cook}Time and ^{Delay}Start pads are used to set the Sabbath feature. The Sabbath feature may only be used with the  pad. The oven temperature may be set higher or lower after setting the Sabbath feature (the oven temperature adjustment feature should be used only during Jewish Holidays), however the display will not visibly show or provide any audible tones indicating whether the change occurred correctly. Once the oven is properly set using **Bake** with the Sabbath feature active, the oven will remain continuously ON until cancelled. This will override the factory preset 12-Hour Energy Saving feature. If the oven light will be needed during the Sabbath, press  before activating the Sabbath feature. Once the oven light is turned ON and the Sabbath feature is active, the oven light will remain ON until the Sabbath feature is turned OFF. If the oven light needs to be OFF, be sure to turn the oven light OFF before activating the Sabbath feature.

IMPORTANT NOTES: It is not advised to attempt to activate any other program feature other than **BAKE** while the Sabbath feature is active. ONLY the following key pads will function after setting the Sabbath feature; 0-9 number pads, , , & . **ALL OTHER KEYPADS** should not be used once the Sabbath feature is properly activated.



INSTRUCTIONS	PRESS	DISPLAY
To Program the Oven for 350°F, Begin Baking Immediately & activate the Sabbath feature		
1. Be sure that the clock is set with the correct time of day.		Fig. 1
2. Arrange the oven racks and place the food in the oven.		
3. Press  . "350°F" will appear in the display (Fig. 1).		
4. Press  . The actual oven temperature will appear in the display and the oven will turn ON and begin heating (Fig. 2).		Fig. 2
5. If a Cook Time or Delay Start is needed the enter the time in this step. If not, skip this step and continue to step 6. Refer to the Cook Time or Delay Start instructions. Remember the oven will shut down after using a Cook Time or Delay Start and therefore may only be used once during the Sabbath/Jewish Holidays. The maximum Delay Start time is 11 hours & 59 minutes.		
6. At the same time press and hold both the ^{Cook} Time and ^{Delay} Start pads for at least 3 seconds. The control will beep and SAb will appear in the display (Fig. 3). Once SAb appears in the display the oven control will no longer beep or display any further changes and the oven is properly set for the Sabbath feature.	^{Cook} Time and ^{Delay} Start	Fig. 3
Note: You may change the oven temperature once baking has started. Press  , enter the oven temperature change (170 to 550°F) and press  twice (for Jewish Holidays only). Remember that the oven control will no longer beep or display any further changes once the oven is set for the Sabbath feature.		
7. The oven may be turned OFF at any time by first pressing  pad (this will turn the oven OFF only). To turn OFF the Sabbath feature press and hold at the same time ^{Cook} Time and ^{Delay} Start pads for at least 3 seconds. SAb will disappear from the display.		























Should you experience a power failure or interruption, the oven will shut off. When power is returned the oven will not turn back on automatically. If your food was nearly fully cooked, you may allow the trapped heat in the oven to finish the cooking process. Otherwise, you should remove the food when the power failure occurs, because you may only start the oven once during the Sabbath/Jewish Holidays. After the Sabbath observance turn OFF the Sabbath feature and the oven may be used with all normal functions.

After the Sabbath observance turn OFF the Sabbath feature. Press and hold both the ^{Cook}Time and ^{Delay}Start pads for at least 3 seconds. **SAb** will disappear from the display and the oven may be used with all normal functions. For further assistance, guidelines for proper usage, and a complete list of models with the Sabbath feature, please visit the web at <http://www.star-k.org>.

Setting Oven Controls

To Set the Recipe Recall Feature

The Recipe Recall feature may be used to record and recall your favorite recipe settings. This feature may store 1 setting for each of the 5 basic cooking pads. The key pad that a recipe may be stored with are , , , Slow Cook & Cakes Breads. This feature will also store and recall Slow Cook, Cook Time or Warm & Hold added setting. Note: Pressing the Start pad after entering cooking temperatures and times will start the oven. If you wish to store the recipes but not start the oven press STOP after pressing the START pad. Once a recipe has been stored the recipe information will appear in the display when pressing the pad in future.

INSTRUCTIONS	PRESS	DISPLAY
To Store a typical cookie recipe (example for baking at 375°F for 9 minutes and to shut-off automatically)		
1. Arrange interior oven racks. If needed, Preheat* the oven to the desired temperature. Place the food in the oven.		Fig. 1
2. Press  (Fig. 1).		
3. Press 3 7 5 (Fig. 2).	3 7 5	Fig. 2
4. Press  . The actual oven temperature will appear in the display (Fig. 3)		
5. Press  (Fig. 4).		Fig. 3
6. Enter the desired baking time. Press 9 (Fig. 5).	9	
7. Press  and hold for 3 seconds (Fig. 6). This recipe is now stored with the Bake key pad.	 for 3 seconds.	
		Fig. 4
When the Cook Time finishes:		
1. "End" will display. The oven will shut-off automatically (Fig. 8).		Fig. 5
2. The control will beep 3 times. The control will continue to beep 3 times every 30 seconds until  is pressed.		
* The Cook Time you enter does NOT include additional time required to Preheat the oven. The oven will begin to count down the cooking time as soon as the feature is activated.		Fig. 6
To Recall a previous stored Recipe under  pad		
1. Place the food in the oven.		Fig. 7
2. Press  . The stored recipe is recalled (Fig. 6).		
3. Press  (Fig. 7).		Fig. 8

Restoring factory default settings

When new, your appliance left the factory with predetermined oven control setting. Over time, the user may make changes to these settings. The following options have user preferences that could be modified and may have been changed since the appliance was new: 12 or 24 hour display mode, Continuous bake or 12-Hour Energy Savings mode, Silent or audible control, Oven temperature display (Fahrenheit or Celsius), Oven temperature adjustment, Any stored recipes, Meat probe setting, Accent Light brightness setting.

Please remember the if you choose to restore, ALL of the above preferences will be restored to factory default settings, the oven temperature offset will reset and any stored information will be cleared.

1. Press and hold **7** keypad until first beep sounds (about 6 seconds).
2. Press .

Self Cleaning

CAUTION During the self-cleaning cycle, the outside of the wall oven can become very hot to the touch. **DO NOT** leave small children unattended near the appliance.

CAUTION The health of some birds is extremely sensitive to the fumes given off during the self-clean cycle of any wall oven. Move birds to another well ventilated room.

CAUTION **DO NOT** line the oven walls, racks, bottom or any other part of the appliance with aluminum foil. Doing so will destroy heat distribution, produce poor baking results and cause permanent damage to the interior (aluminum foil will melt to the interior surface of the oven).

CAUTION **DO NOT** force the oven door open. This can damage the automatic door locking system. Use caution when opening the door after the Self-Cleaning cycle is completed. The oven may still be **VERY HOT**.



Note: See additional cleaning information for the oven door in the **General Care & Cleaning** section.

CAUTION The oven bake and broil elements may appear to have cooled after they have been turned OFF. **The elements may still be hot** and burns may occur if these elements are touched before they have cooled sufficiently.

Self-Cleaning Oven

A Self-Cleaning oven cleans itself with high temperatures (well above cooking temperatures) which eliminate soils completely or reduces them to a fine powdered ash you can wipe away with a damp cloth.

Adhere to the following cleaning precautions:

- Allow the oven to cool before cleaning.
- Wear rubber gloves when cleaning any exterior parts of the oven manually.
- **DO NOT** clean the oven door gasket. The woven material of the oven door gasket is essential for a good seal. Care should be taken not to rub, damage or remove the gasket.
- **DO NOT** use any cleaning materials on the oven door gasket. Doing so could cause damage.
- **Remove the searing grill, broiler pan and broiler pan insert, all utensils and any aluminum foil. These items cannot withstand high cleaning temperatures.**
- This oven comes with lubricated porcelain oven racks, which can remain in the oven during the self-clean cycle. Do not clean this vegetable oil lubrication off the racks. It is important that the sides of the oven racks always have a light coating of vegetable oil. To maintain optimal rack performance, re-apply a thin layer of vegetable oil to the sides of the rack after every self-clean cycle or when the rack becomes difficult to slide.
- **Remove any excessive spillovers** in the oven cavity **before** starting the Self-Cleaning cycle. To clean, use hot, soapy water and a cloth. Large spillovers can cause heavy smoke or fire when subjected to high temperatures. **DO NOT** allow food spills with a high sugar or acid content (such as milk, tomatoes, sauerkraut, fruit juices or pie filling) to remain on the surface as they may leave a dull spot even after cleaning.
- Clean any soil from the oven frame, the door liner outside the oven door gasket and the small area at the front center of the oven bottom. These areas heat sufficiently to burn soil on. Clean with soap and water.

NOTE: Prior to setting the Self-Clean cycle, any spills remaining on the oven bottom should be removed.

What to Expect during Cleaning

While the oven is in operation, the oven heats to temperatures much higher than those used in normal cooking. Sounds of metal expansion and contraction are normal. Odor is also normal as the food soil is being removed. Smoke may appear through the oven vent.

If heavy spillovers are not wiped up before cleaning, they may flame and cause more smoke and odor than usual. This is normal and safe and should not cause alarm. If available, use an exhaust fan during the self-cleaning cycle.

Self Cleaning

Self-Clean Cycle Time Length

The ^{Flex}Clean pad controls the Self-Cleaning feature. When used with a the ^{Delay Start} pad, a delayed Self-Cleaning cycle may also be programmed. The Flex Clean feature allows for any Self-Cleaning cycle time from 2 (2:00) to 4 hours (4:00). You may also choose the clean time in 1 minute increments (for example 2 hours and 50 minutes) by pressing the number keypads **2 5 0**.

If you are planning to use the oven directly after a self-clean cycle remember to allow time for the oven to cool down and the oven door to unlock. This normally takes about one hour. So a 3 hour self-clean cycle will actually take about 4 hours to complete.

*It is recommend to use a 2 hour self-clean cycle for **light soils**, a 3 hour cycle for **average soils**, and a 4 hour cycle for **heavy soils** (to assure satisfactory results).

CAUTION To avoid possible burns use care when opening the oven door after the Self-Cleaning cycle. Stand to the side of the oven when opening the door to allow hot air or steam to escape.

CAUTION **DO NOT** force the oven door open. This can damage the automatic door locking system. Use caution and avoid possible burns when opening the door after the Self-Cleaning cycle has completed. The oven may still be **VERY HOT**.

INSTRUCTIONS

PRESS

DISPLAY

To start an immediate Self-Cleaning cycle or to set a Delay Start time of 9:00 o'clock and shut-off automatically (example provided is a default 3 hour Self-Clean cycle)

1. Be sure the clock is set with the correct time of day, the oven is **EMPTY** and the oven door is closed.
2. Press ^{Flex}Clean. "**CLEAN**" will flash and "**3:00 HR**" will show in the display (Fig. 1). The control will automatically clean for a 3 hour period (default self-cleaning cycle time). Note: If a 2 or 4 hour clean time is desired, press **2 0 0** for 2 hour or press **4 0 0** for a 4 hour clean time. Set the cleaning time based on the amount of soil: light, medium or heavy (* See above).
3. Press . The "**DOOR LOCKED**" icon will flash (Fig. 2).
4. The motor driven oven door lock will begin to close automatically. Once the door has been locked the "**DOOR LOCKED**" indicator light will stop flashing and remain on (Fig. 3).

Note: Allow about 15 seconds for the oven door lock to close.

Note: If the optional delay Self-Clean feature is needed, finish steps 5-7. If Self-Clean is started immediately skip the remaining steps and continue with "When the Self-Clean cycle is done" on the following page.

5. Press ^{Delay Start} (Fig. 4). Enter the desired Self-Clean starting time using the number pads **9 0 0** (Fig. 5).
6. Press . "DELAY", "DOOR LOCKED", "CLEAN" and Cooktop locked icons will remain on.
7. The control will calculate forward from the set start time to determine when the Self-Cleaning cycle should end. The Self-Cleaning cycle will turn on automatically at the set time. At that time the icon "DELAY" will go out; the oven icon will come on, the start time, "CLEAN" and "CLn" will remain in the display (Fig. 6)

^{Flex}
Clean

2 0 0 or **4 0 0**



^{Delay}
Start

9 0 0



Fig. 1



Fig. 2



Fig. 3

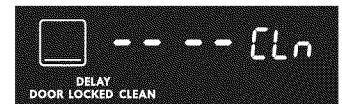

Fig. 4



Fig. 5

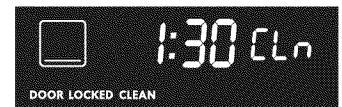

Fig. 6

Self Cleaning

INSTRUCTIONS

PRESS

DISPLAY

When the Self-Clean Cycle is Completed

1. The "DOOR LOCKED", "CLEAN" and "HOT" icon will remain in the display.
2. Once the oven has cooled down for approximately 1 HOUR, and the "DOOR LOCKED" icon is no longer displayed, the oven door can then be opened.



Fig. 1

Stopping or Interrupting a Self-Cleaning Cycle

If it becomes necessary to stop or interrupt a self-cleaning cycle due to excessive smoke or fire in the oven:

1. Press .
2. Once the oven has cooled down for approximately 1 HOUR, and the "DOOR LOCKED" icon is no longer displayed, the oven door can then be opened (Fig. 1).



Adjusting Oven Temperature

The temperature in the oven has been pre-set at the factory. When first using the oven, be sure to follow recipe times and temperatures. If you think the oven is cooking too hot or too cool for the temperature you select, you can adjust the actual oven temperature to be more or less than what is displayed. Before adjusting, test a recipe by using a temperature setting that is higher or lower than the recommended temperature. The baking results should help you to decide how much of an adjustment is needed.



Note: The oven temperature adjustments made with this feature will not change the Self-Clean cycle temperature.

INSTRUCTIONS

PRESS

DISPLAY

To adjust the oven temperature higher

1. Press  for 6 seconds. "UPO" and degree offset will appear in the display (Fig. 2).
2. To increase the temperature use the number pads to enter the desired change (Example 30°F) **3 0** (Fig. 3). The temperature may be increased as much as 35°F (19°C).
3. Press  to accept the temperature change and the display will return to the time of day (Fig. 4). Press  to reject the change if necessary.



3 0



Fig. 2







Fig. 3



Fig. 4

To adjust the oven temperature lower

1. Press  for 6 seconds. "UPO" and degree offset will appear in the display (Fig. 2).
2. To decrease the temperature use the number pads to enter the desired change (Example -30°F) **3 0** and then press  (Fig. 5). The temperature may be decreased as much as 35°F (19°C).
3. Press  to accept the temperature change and the display will return to the time of day (Fig. 4). Press  to reject the change if necessary.



3 0 



Fig. 5

General Care & Cleaning

Cleaning Various Parts of Your Oven

Before cleaning any part of the oven, be sure all controls are turned OFF and the oven is COOL. REMOVE SPILLOVERS AND HEAVY SOILING AS SOON AS POSSIBLE. REGULAR CLEANINGS NOW WILL REDUCE THE EXTENT AND DIFFICULTY OF MAJOR CLEANING LATER.

Surfaces	How to Clean
Aluminum (Trim Pieces) & Vinyl	Use hot, soapy water and a cloth. Dry with a clean cloth. Do not scour or use all-purpose cleaners, ammonia, powdered cleaners or commercial oven cleaner. They can scratch and discolor aluminum.
Painted and Plastic, Control Panel, Body Parts, and Decorative Trim	<i>For general cleaning</i> , use hot, soapy water and a cloth. <i>For more difficult and built-up grease</i> , apply a liquid detergent directly onto the soil. Leave on soil for 30 to 60 minutes. Rinse with a damp cloth and dry. DO NOT use abrasive cleaners on any of these materials; they can scratch.
Stainless Steel, Chrome, Control Panel, Decorative Trim	<i>Before cleaning the control panel</i> , turn all controls to OFF. Clean using hot, soapy water and a dishcloth. Rinse with a clean water using a dishcloth. Be sure to squeeze excess water from the cloth before wiping the panel; especially when wiping around the controls. Excess water in or around the controls may cause damage to the appliance. To replace knobs after cleaning, line up the flat sides of both the knob and the shaft; then push the knob into place. Clean stainless steel with hot, soapy water and a dishcloth. Rinse with clean water and a cloth. Do not use cleaners with high concentrations of chlorides or chlorines. Do not use harsh scrubbing cleaners. Only use kitchen cleaners that are especially made for cleaning stainless steel. Always be sure to rinse the cleaners from the surface as bluish stains may occur during heating that cannot be removed.
Porcelain Enamel, Broiler Pan and Insert, Door Liner, Body Parts	Gentle scouring with a soapy scouring pad will remove most spots. Rinse with a 1:1 solution of clear water and ammonia. <i>If necessary</i> , cover difficult spots with an ammonia-soaked paper towel for 30 to 40 minutes. Rinse with clean water and a damp cloth, and then scrub with a soap-filled scouring pad. Rinse and wipe dry with a clean cloth. Remove all cleaners or the porcelain may become damaged during future heating. DO NOT use spray oven cleaners on the cooktop.
Oven Racks	This oven comes with lubricated porcelain oven racks, which can remain in the oven during the self-clean cycle. Do not clean this vegetable oil lubrication off the racks. It is important that the sides of the oven racks always have a light coating of vegetable oil. To maintain optimal rack performance, re-apply a thin layer of vegetable oil to the sides of the rack after every self-clean cycle or when the rack becomes difficult to slide.
Oven Door	Use soap & water to thoroughly clean the top, sides and front of the oven door. Rinse well. You may use a glass cleaner on the outside glass of the oven door. DO NOT immerse the door in water. DO NOT spray or allow water or the glass cleaner to enter the door vents. DO NOT use oven cleaners, cleaning powders or any harsh abrasive cleaning materials on the outside of the oven door. DO NOT clean the oven door gasket. The oven door gasket is made of a woven material, on Self-Cleaning models, which is essential for a good seal. Care should be taken not to rub, damage or remove this gasket.

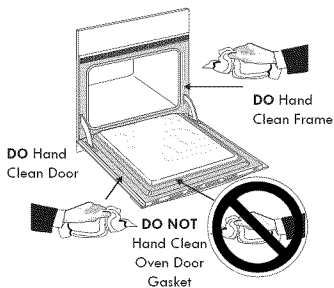
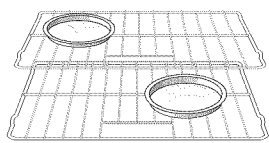

General Care & Cleaning

Care and Cleaning of Stainless Steel (Some models)

Some models are equipped with stainless steel exterior parts. Special care and cleaning are **required** for maintaining the appearance of stainless parts. Please refer to the table provided at the beginning of the **General Care & Cleaning** section in this Use & Care Guide.

Removing and Replacing the Lift-Off Oven Door

CAUTION The door is heavy. For safe, temporary storage, lay the door flat with the inside of the door facing down.

To Remove Oven Door:

1. Open oven door completely (horizontal with floor - See Fig. 1).
2. Pull the door hinge locks on both left and right door hinges down from the oven frame completely towards the oven door (See Fig. 2). A tool such as a small flat-blade screwdriver may be required.
3. Firmly grasp both sides of oven door along the door sides (Do not use the oven door handle - See Fig. 3).
4. Close the door to about a 10 degree angle as shown in Fig. 3.
5. With the oven door in this position, lift the oven door hinge arms away from the roller pins located on each side of the oven frame (See Fig. 4).

To Replace Oven Door:

1. Firmly grasp both sides of oven door along the door sides (Do not use the oven door handle - See Fig. 3).
2. Holding the oven door at the same angle as the removal position, seat the hook of the hinge arm onto the roller pins located on each side of the oven door frame (See Fig. 4). The hook of the hinge arms must be fully seated onto the roller pins.
3. Fully open the oven door (horizontal with floor - See Fig. 1).
4. Push the door hinge locks up towards and into the oven frame on both left and right oven door hinges (See Fig. 2) to the locked position.
5. Close the oven door.

Special Door Care Instructions - Most oven doors contain glass that can break.

Read the following recommendations:

1. Do not close the oven door until all the oven racks are fully in place.
2. Do not hit the glass with pots, pans, or any other object.
3. Scratching, hitting, jarring or stressing the glass may weaken its structure causing an increased risk of breakage at a later time.

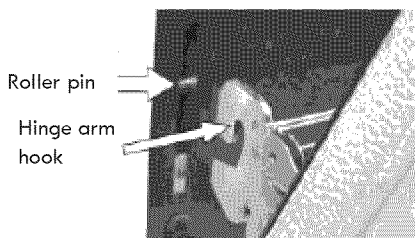
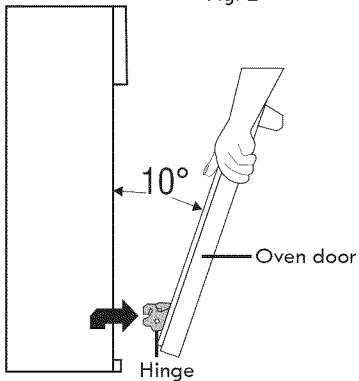
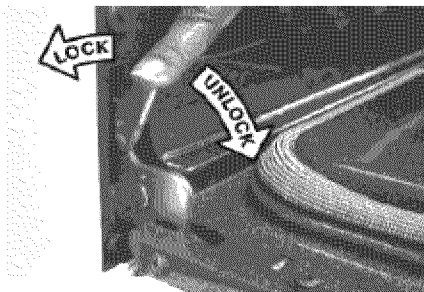
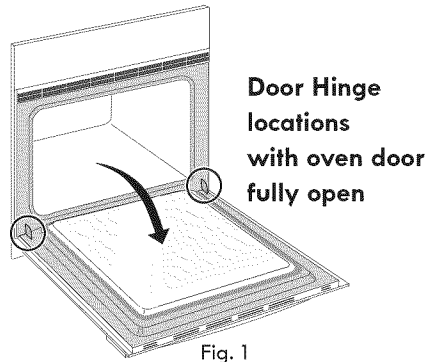

General Care & Cleaning

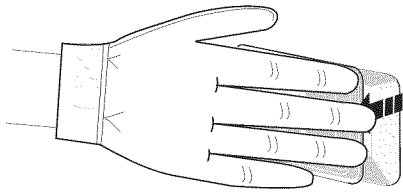

Lift up and pull out.

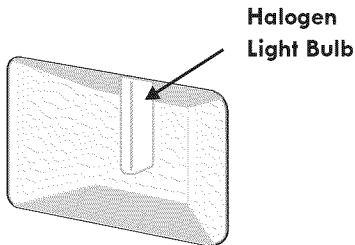

Changing the Oven Light

Changing the Halogen Oven Light (some models)

The oven lights will automatically turn ON when the oven door is opened. The oven lights may also be manually operated by pressing the  pad.

The oven light bulb is covered with a glass shield. The glass shield can be removed to be cleaned manually or to change oven light. **THIS GLASS SHIELD MUST BE IN PLACE WHENEVER THE OVEN IS IN USE.**

To replace the light bulb:

CAUTION: BE SURE THE OVEN IS COOL.

1. Turn the power off at the main source.
2. Wear a leather-faced glove for protection against possible broken glass.
3. To remove the glass shield, lift up on side and use force to pull shield out.
4. Replace halogen light appliance bulb taking care not to touch the bulb with your bare fingers. Touching bulb with your skin can leave a film on the bulb that causes it to burn out quickly.
5. Replace glass shield in opposite order and manner of removal.

Changing the Regular Oven Light (some models)

CAUTION Be sure the oven is unplugged and all parts are COOL before replacing the oven light bulb. Do not turn the oven light on during the self-cleaning cycle. High temperature will reduce lamp life.

The interior oven light will turn on automatically when the oven door is opened.

The oven light may be turned on when the door is closed by using the oven light switch located on the control panel.

On a self clean oven the lamp is covered with a glass shield held in place by a wire holder.

THIS GLASS SHIELD MUST BE IN PLACE WHENEVER THE OVEN IS IN USE.

To replace the light bulb:

CAUTION: BE SURE OVEN IS COOL

1. Turn the power off at the main source.
2. Wear a leather-faced glove for protection against possible broken glass.
3. Replace bulb with a 40 watt appliance bulb only.
4. For self-cleaning oven, press wire holder to one side to release glass shield, change bulb and be sure to replace glass shield.

To Remove the Bake Element Cover (some models)

1. In order to remove the bake element cover for cleaning, pull the back edge with one hand about 1/2" inch and lift up the bake element cover with both hands (See picture).
2. When re-installing the bake element cover, be sure to put it all the way to the back of the oven and lay it down on the 2 shoulder screws. Then push the front edge of the cover in its place below the front bracket.

To have easier access to the bake element cover, you can remove the oven door by following the instructions on previous page.

IMPORTANT: Always replace the bake element cover before the next use.

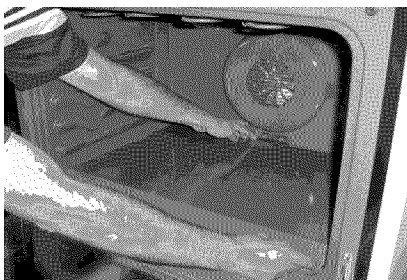

Before You Call

Solutions to Common Problems

Before you call for service review this list. It may save you time and expense. The list includes common occurrences that are not the result of defective workmanship or materials in this appliance.

OCCURRENCE	POSSIBLE CAUSE/SOLUTION
Oven Control Beeps and Displays any F code error (example F11).	Electronic control has detected a fault condition. Press STOP/CLEAR to clear the display and stop the beeping. Reprogram the oven. If a fault reoccurs, record the fault number. Press STOP/CLEAR and call Sears or another qualified servicer
"d-O" is displayed.	The door was left open and controls set for self-cleaning cycle. Close the door and push upper or lower oven CANCEL pad .
Range not level. Bad cooking results.	Place oven rack in center of oven. Place a level on the oven rack. Contact installing agent if rack and cabinet cutout flooring are not level. Kitchen cabinet misalignment may make oven appear to be not level. Be sure cabinets are square and level. Contact cabinet maker to correct problem.
Entire oven does not operate.	When the oven is first plugged in, or when the power supply to the oven has been interrupted, the display will flash. The oven cannot be programmed until the clock is set. Be sure electrical cord is securely connected into the electrical junction box. Cord/plug is not installed and/or connected. Cord is not supplied with oven. Contact Sears or another qualified servicer. Service wiring not complete. Contact Sears or another qualified servicer. Power outage. Check house lights to be sure. Call your local electric company. Short in cord/plug. Replace cord/plug. Controls are not set properly. See instructions under Setting Oven Controls to set the controls. House fuse has blown or circuit breaker has tripped immediately following installation. House fuse may not be fully engaged. Check fuse and screw or engage circuit breaker securely. House fuse has blown or circuit breaker has tripped after the oven has been installed and previously operating. Contact Sears or another qualified servicer.
Oven light does not work.	Burned-out or loose bulb. Follow the instructions under Changing Oven Light to replace or tighten the bulb.
Fan noise during cooking operation.	A cooling fan may automatically turn on and off to cool internal parts. This is normal, and the fan may continue to run even after oven is turned off.

Before You Call

Solutions to Common Problems

OCCURRENCE	POSSIBLE CAUSE/SOLUTION
Oven smokes excessively during broiling.	Oven door is closed. Door should be open during broiling.
	Meat too close to the broiler unit. Reposition the rack to provide more clearance between the meat and the broiler. Preheat broil element for quick searing operation.
	Meat not properly prepared. Remove excess fat from meat. Slash remaining fatty edges to prevent curling, but do not cut into the lean.
	Grid on broiler pan wrong-side up. Grease does not drain into broiler pan. Always place the grid on the broiler pan with the ribs up and the slots down to allow grease to drip into the pan.
	Broiler pan used without grid or grid cover with foil. DO NOT use the broiler pan without the grid or cover the grid with foil.
Oven needs to be cleaned. Grease has built up on oven surfaces. Regular cleaning is necessary when broiling frequently. Old grease or food spatters cause excessive smoking.	
Poor baking results.	Many factors affect baking results. See Baking for hints, causes and corrections. See Adjusting Oven Temperature .
Self-cleaning cycle does not work.	Make sure the oven door is closed.
	Controls not set properly. Follow instructions.
	Self-cleaning cycle was interrupted. Follow steps under «Stopping or Interrupting a Self-Cleaning Cycle» in the Use & care Guide.
Soil not completely removed after self-cleaning cycle is completed.	Failure to hand clean oven frame and door liner outside the oven door gasket before starting the self-clean cycle. Hand clean burned on residue with a stiff nylon brush and water or a nylon scrubber. Do not clean the oven door gasket or it will be damaged.
	Excessive spillovers in oven. Set the self-clean cycle for longer cleaning time.
Flames inside oven or smoke from vent.	Excessive spillovers in oven. This is normal, especially for high oven temperatures, pie spillovers or for large amounts of grease on bottom of oven. Wipe up excessive spillovers.

PROTECTION AGREEMENTS

Master Protection Agreements

Congratulations on making a smart purchase. Your new Kenmore® product is designed and manufactured for years of dependable operation. But like all products, it may require preventive maintenance or repair from time to time. That's when having a Master Protection Agreement can save you money and aggravation.

The Master Protection Agreement also helps extend the life of your new product. Here's what the Agreement* includes:

- ☑ **Parts and labor** needed to help keep products operating properly **under normal use**, not just defects. Our coverage goes **well beyond the product warranty**. No deductibles, no functional failure excluded from coverage – **real protection**.
- ☑ **Expert service** by a force of more than **10,000 authorized Sears service technicians**, which means someone you can trust will be working on your product.
- ☑ **Unlimited service calls and nationwide service**, as often as you want us, whenever you want us.
- ☑ **«No-lemon» guarantee** – replacement of your covered product if four or more product failures occur within twelve months.
- ☑ **Product replacement** if your covered product can't be fixed.
- ☑ **Annual Preventive Maintenance Check** at your request – no extra charge.
- ☑ **Fast help by phone** – we call it **Rapid Resolution** – phone support from a Sears representative on all products. Think of us as a «talking owner's manual».
- ☑ **Power surge protection** against electrical damage due to power fluctuations.
- ☑ **\$250 Food Loss Protection** annually for any food spoilage that is the result of mechanical failure of any covered refrigerator or freezer.
- ☑ **Rental reimbursement** if repair of your covered product takes longer than promised.
- ☑ **10% discount** off the regular price of any non-covered repair service and related installed parts.

Once you purchase the Agreement, a simple phone call is all that it takes for you to schedule service. You can call anytime day or night, or schedule a service appointment online.

The Master Protection Agreement is a risk free purchase. If you cancel for any reason during the product warranty period, we will provide a full refund. Or, a prorated refund anytime after the product warranty period expires. Purchase your Master Protection Agreement today!

Some limitations and exclusions apply. For prices and additional information in the U.S.A. call 1-800-827-6655.

*** Coverage in Canada varies on some items. For full details call Sears Canada at 1-800-361-6665.**

Sears Installation Service

*For Sears professional installation of home appliances, garage door openers, water heaters, and other major home items, in the U.S.A. or Canada call **1-800-4-MY-HOME**®.*

Acuerdos maestros de protección

Enhorabuena por haber hecho una compra inteligente. Su nuevo producto Kenmore® está diseñado y fabricado para brindarle años de funcionamiento fiable. Pero, como cualquier producto, puede necesitar mantenimiento preventivo o reparaciones periódicas. Es por eso que tener un Acuerdo maestro de protección podría ahorrarle dinero y molestias.

El Acuerdo maestro de protección también sirve para prolongar la durabilidad de su nuevo producto. El acuerdo* incluye lo siguiente:

- ☑ **Piezas y mano de obra** necesarias para contribuir a mantener el funcionamiento adecuado de los productos **utilizados en condiciones normales de uso**, no sólo en caso de defectos de los productos. Nuestra cobertura va **mucho más allá que la garantía del producto**. No se aplican deducibles ni exclusiones por fallas del funcionamiento: es decir, **verdadera protección**.
- ☑ **Servicio técnico por expertos** (más de **10000 técnicos autorizados de Sears**), lo cual significa que quien repare o realice el mantenimiento de su producto será un profesional de confianza.
- ☑ **Servicio técnico a escala nacional y número ilimitado de llamadas de solicitud de servicio técnico**: se puede poner en contacto con nosotros cuantas veces lo desee y cuando lo desee.
- ☑ **Garantía «sin sorpresas»**: se reemplaza el producto cubierto por el acuerdo si ocurren cuatro o más fallas del producto en un periodo de 12 meses.
- ☑ **Reemplazo del producto**: en caso de que no se pueda reparar el producto cubierto por el acuerdo.
- ☑ **Revisión anual preventiva de mantenimiento del producto**: puede solicitarla en cualquier momento, sin costo alguno.
- ☑ **Rápida asistencia telefónica**, la cual denominamos **Solución rápida**: es decir, asistencia telefónica a través de cualquiera de nuestros representantes de Sears, sobre cualquiera de nuestros productos. Piense en nosotros como en un «manual parlante del usuario».
- ☑ **Protección contra fallas eléctricas**, contra daños debidos a fluctuaciones de la corriente eléctrica.
- ☑ **\$250 al año para cubrir cualquier posible deterioro de alimentos** que haya tenido que desechar debido a una falla mecánica de cualquiera de nuestros refrigeradores o congeladores cubiertos por este acuerdo.
- ☑ **Devolución de gastos de alquiler de electrodomésticos** si la reparación de su producto asegurado toma más que el tiempo prometido.
- ☑ **10% de descuento** aplicable tanto a los costos del servicio de reparación, como de las piezas instaladas relacionadas que no hayan quedado cubiertos por este acuerdo.

Una vez que haya realizado el pago de este acuerdo, bastará una simple llamada telefónica para concertar una visita de servicio. Puede llamar a cualquier hora del día o de la noche, o bien concertar una visita de servicio por Internet.

La adquisición del Acuerdo maestro de protección es una inversión exenta de riesgos. Si por cualquier motivo decide cancelar dicho acuerdo durante el periodo de garantía del producto, le haremos un reintegro total del valor. O bien un importe proporcional si cancela el acuerdo en cualquier otro momento posterior al vencimiento del periodo de garantía del producto. ¡Adquiera hoy mismo su Acuerdo maestro de protección!

Algunas limitaciones y exclusiones podrían aplicarse. Para solicitar precios e información adicional, llame al 1-800-827-6655 (en los EE.UU.).

*** La cobertura en Canadá varía en el caso de algunos artículos. Para obtener detalles completos al respecto, llame al 1-800-361-6665 de Sears de Canadá.**

Servicio de instalación de Sears

*Para solicitar la instalación por profesionales de Sears de electrodomésticos, abridores de puertas de garaje, calentadores de agua y otros artículos de uso prioritario en el hogar, llame al **1-800-4-MY-HOME** en los EE.UU. o Canadá.*

Get it fixed, at your home or ours!

Your Home

For troubleshooting, product manuals and expert advice:



www.managemylife.com

For repair – **in your home** – of **all** major brand appliances, lawn and garden equipment, or heating and cooling systems, **no matter who made it, no matter who sold it!**

For the replacement parts, accessories and owner's manuals that you need to do-it-yourself.

For Sears professional installation of home appliances and items like garage door openers and water heaters.

1-800-4-MY-HOME[®] (1-800-469-4663)

Call anytime, day or night (U.S.A. and Canada)

www.sears.com www.sears.ca

Our Home

For repair of carry-in items like vacuums, lawn equipment, and electronics, call anytime for the location of your nearest

Sears Parts & Repair Service Center

1-800-488-1222 (U.S.A.) **1-800-469-4663** (Canada)

www.sears.com

www.sears.ca

To purchase a protection agreement on a product serviced by Sears:

1-800-827-6655 (U.S.A.)

1-800-361-6665 (Canada)

Para pedir servicio de reparación a domicilio, y para ordenar piezas:

1-888-SU-HOGAR[®]

(1-888-784-6427)

www.sears.com

Au Canada pour service en français:

1-800-LE-FOYER^{MC}

(1-800-533-6937)

www.sears.ca

The Sears logo, featuring the word "Sears" in a large, stylized, serif font with a thick outline.

® Registered Trademark / TM Trademark of KCD IP, LLC in the United States, or Sears Brands, LLC in other countries

® Marca Registrada / TM Marca de Fábrica de KCD IP, LLC en Estados Unidos, o Sears Brands, LLC in otros países

^{MC} Marque de commerce / ^{MD} Marque déposée de Sears Brands, LLC

Free Manuals Download Website

<http://myh66.com>

<http://usermanuals.us>

<http://www.somanuals.com>

<http://www.4manuals.cc>

<http://www.manual-lib.com>

<http://www.404manual.com>

<http://www.luxmanual.com>

<http://aubethermostatmanual.com>

Golf course search by state

<http://golfingnear.com>

Email search by domain

<http://emailbydomain.com>

Auto manuals search

<http://auto.somanuals.com>

TV manuals search

<http://tv.somanuals.com>