



Electric Range

Use & Care Guide

Estufa eléctrica

Guía para el Uso y Cuidado

Models, Modèles **790- .9663*, 9664***

* = color number, numéro de couleur

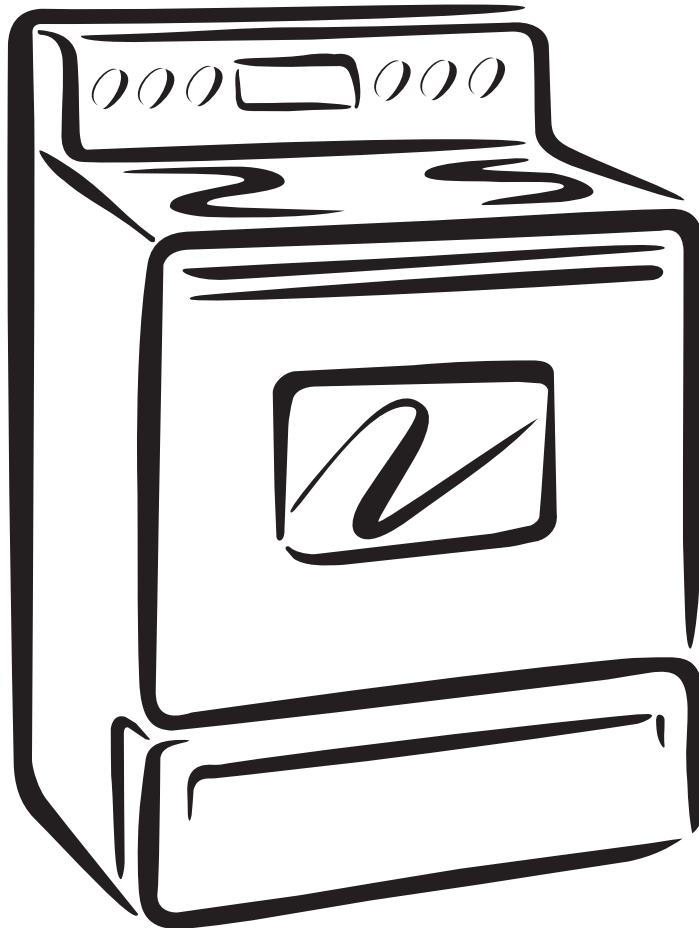

ENGLISH

ESPAÑOL

Table of Contents

Freestanding Range Warranty	2	• Setting Preheat	25
IMPORTANT SAFETY INSTRUCTIONS	3-4	• Using Air Guard™	26
Protection Agreements	5	• Setting Bake	26
Range Features	6-7	• Setting Cook Time	27
Before Setting Oven Controls	7-8	• Setting Delay Start	28
Before Setting Surface Controls	9	• Setting Broil & Searing Grill	29
Setting Surface Controls	10-15	• Setting Convection Roast	30
Surface Cooking	16-17	• Setting Cakes and Breads	30
Setting Warmer Drawer & Controls	18-19	• Meat Probe	31-32
Electronic Oven Control Pad Features	20	• Setting Convection Bake	33
Minimum & Maximum Control Pad Settings	20	• Setting Convection Convert	34
Setting Oven Controls	21-37	• Setting Slow Cook	35
• Setting the Clock	21	• Setting the Sabbath Feature	36-37
• Changing between 12 or 24 Hour Display	21	• Setting Warm & Hold	37
• Silent Control Operation	21	Warmer Drawer Removal	38
• Continuous Bake or Twelve Hour Energy Saving Mode ...	22	Self-Cleaning	39-41
• Timer	22	Adjusting Oven Temperature	42
• Locking & Unlocking Oven Lockout	23	General Care & Cleaning	43-46
• Changing Temperature Display	23	Before You Call for Service	47-48
• Saving & Recalling Recipe Settings	24	Recipes for Slow Cook	49
		Sears Service	back cover

Kenmore Elite Appliance Warranty

One Year Limited Warranty

When installed, operated and maintained according to all instructions supplied with the product, if this appliance fails due to a defect in material or workmanship within one year from the date of purchase, call 1-800-4-MY-HOME® to arrange for free repair. If this appliance is used for other than private family purposes, this warranty applies for only 90 days from the date of purchase.

This warranty covers only defects in material and workmanship. Sears will NOT pay for:

1. Expendable items that can wear out from normal use, including but not limited to filters, belts, light bulbs, and bags.
2. A service technician to instruct the user in correct product installation, operation or maintenance.
3. A service technician to clean or maintain this product.
4. Damage to or failure of this product if it is not installed, operated or maintained according to all instructions supplied with the product.
5. Damage to or failure of this product resulting from accident, abuse, misuse or use for other than its intended purpose.
6. Damage to or failure of this product caused by the use of detergents, cleaners, chemicals or utensils other than those recommended in all instructions supplied with the product.
7. Damage to or failure of parts or systems resulting from unauthorized modifications made to this product.

FIVE-YEAR LIMITED WARRANTY

For five years from the date of purchase, when this range is installed, operated, and maintained according to all instructions supplied with this product, Sears will replace the following range parts free of charge if they fail for the reasons below.

Customer must pay labor cost of installation.

- Cooktop glass if it fails due to thermal shock.
- Cooktop elements if they are defective.

Disclaimer of implied warranties; limitation of remedies

Customer's sole and exclusive remedy under this limited warranty shall be product repair as provided herein. Implied warranties, including warranties of merchantability or fitness for a particular purpose, are limited to one year or the shortest period allowed by law. Sears shall not be liable for incidental or consequential damages. Some states and provinces do not allow the exclusion or limitation of incidental or consequential damages, or limitations on the duration of implied warranties of merchantability or fitness, so these exclusions or limitation may not apply to you.

This warranty applies only while this appliance is used in the United States and Canada.

This warranty gives you specific legal rights, and you may also have other rights which vary from state to state.

Sears, Roebuck and Co., Dept. 817WA, Hoffman Estates, IL 60179

Sears Canada Inc., Toronto, Ontario, Canada M5B 2B8

Important Safety Instructions

Read all instructions before using this appliance. Save these instructions for future reference.

This manual contains important safety symbols and instructions. Please pay attention to these symbols and follow all instructions given.

⚠ WARNING This symbol will help alert you to situations that may cause serious bodily harm, death or property damage.

⚠ CAUTION This symbol will help alert you to situations that may cause bodily injury or property damage.

• **Remove all tape and packaging before using the range.**
Destroy the carton and plastic bags after unpacking the range. Never allow children to play with packaging material.

• **Proper Installation—Be sure your appliance is properly installed and grounded by a qualified technician in accordance with the National Electrical Code ANSI/NFPA No. 70 latest edition and local electrical code requirements.** Install only per installation instructions provided in the literature package for this range.

Ask your dealer to recommend a qualified technician and an authorized repair service. Know how to disconnect the power to the range at the circuit breaker or fuse box in case of an emergency.

• **User servicing—Do not repair or replace any part of the appliance unless specifically recommended in the manuals.** All other servicing should be done only by a qualified technician. This may reduce the risk of personal injury and damage to the range.

• **Never modify or alter the construction of a range by removing leveling legs, panels, wire covers, anti-tip brackets/screws, or any other part of the product.**

⚠ WARNING

- All ranges can tip.
- Injury to persons could result.
- Install anti-tip device packed with range.
- See Installation Instructions.



⚠ WARNING To reduce the risk of tipping, the range must be secured by properly installed anti-tip bracket provided with the range. To check if the bracket is installed properly, visually check that rear leveling leg is inserted into and fully secured by the anti-tip bracket by removing lower panel or storage drawer. For models with a warmer drawer, grasp the top rear edge of the range and carefully attempt to tilt it forward. Refer to the installation instructions for proper anti-tip bracket installation.

⚠ WARNING Stepping, leaning or sitting on the doors or drawers of this range can result in serious injuries and also cause damage to the range. Do not allow children to climb or play around the range. The weight of a child on an open door may cause the range to tip, resulting in serious burns or other injury.

⚠ CAUTION Do not store items of interest to children in the cabinets above a range or on the backguard of a range. Children climbing on the range to reach items could be seriously injured.

⚠ WARNING Do not use the oven or warmer drawer (if equipped) for storage.

⚠ WARNING Never Use Your Appliance for Warming or Heating the Room.

• **Storage in or on Appliance—Flammable materials should not be stored in an oven, warmer drawer, near surface units or in the storage drawer.** This includes paper, plastic and cloth items, such as cookbooks, plasticware and towels, as well as flammable liquids. Do not store explosives, such as aerosol cans, on or near the range.

• **Do Not Leave Children Alone—Children should not be left alone or unattended in the area where appliance is in use.** They should never be allowed to sit or stand on any part of the appliance.

• **DO NOT TOUCH SURFACE UNITS, AREAS NEAR THESE UNITS, HEATING ELEMENTS OR INTERIOR SURFACES OF THE OVEN.** Both surface units and oven heating elements may be hot even though they are dark in color. Areas near surface units may become hot enough to cause burns. During and after use, do not touch, or let clothing or other flammable materials touch these areas until they have had sufficient time to cool. Among these areas are the cook top, surfaces facing the cook top, the oven vent openings and surfaces near these openings, oven door and window.

• **Wear Proper Apparel—Loose-fitting or hanging garments should never be worn while using the appliance.** Do not let clothing or other flammable materials contact hot surfaces.

• **Do Not Use Water or Flour on Grease Fires—Smother the fire with a pan lid, or use baking soda, a dry chemical or foam-type extinguisher.**

• **When heating fat or grease, watch it closely.** Fat or grease may catch fire if allowed to become too hot.

• **Use Only Dry Potholders - Moist or damp potholders on hot surfaces may result in burns from steam.** Do not let potholders touch hot heating elements. Do not use a towel or other bulky cloth instead of a potholder.

• **Do Not Heat Unopened Food Containers - Buildup of pressure may cause container to burst and result in injury.**

• **Remove the oven door from any unused range if it is to be stored or discarded.**

IMPORTANT—Do not attempt to operate the range during a power failure. If the power fails, always turn off the range. If the range is not turned off and the power resumes, the range will begin to operate again. Once the power resumes, reset the clock and oven function.

Important Safety Instructions

IMPORTANT INSTRUCTIONS FOR USING YOUR COOKTOP

- **Know which knob controls each surface heating unit.** Place a pan of food on the unit before turning it on, and turn the unit off before removing the pan.
- **Use Proper Pan Size**—This appliance is equipped with one or more surface units of different sizes. Select utensils having flat bottoms large enough to cover the surface unit heating element. The use of undersized utensils will expose a portion of the heating element to direct contact and may result in ignition of clothing. Proper relationship of utensil to element will also improve efficiency.
- **Utensil Handles Should Be Turned Inward and Not Extend Over Adjacent Surface Elements**—To reduce the risk of burns, ignition of flammable materials, and spillage due to unintentional contact with the utensil, the handle of the utensil should be positioned so that it is turned inward, and does not extend over adjacent surface units.
- **Never Leave Surface Elements Unattended at High Heat Settings**—Boilovers cause smoking and greasy spillovers that may ignite, or a pan that has boiled dry may melt.
- **Do Not Immerse or Soak Removable Heating Elements**—Heating elements should never be immersed in water. Heating elements clean themselves during normal operation.
- **Glazed Cooking Utensils**—Only certain types of glass, glass/ceramic, ceramic, earthenware, or other glazed utensils are suitable for cook top service without breaking due to the sudden change in temperature. Check the manufacturer's recommendations for cook top use.
- **When flaming foods under a ventilating hood, turn the fan on.**

SELF CLEANING OVENS

- **Clean in the self-cleaning cycle only the parts listed in this Use & Care Manual.** Before self cleaning the oven, remove the broiler pan and any utensils or foods from the oven.
- **Do Not Use Oven Cleaners**—No commercial oven cleaner or oven liner protective coating of any kind should be used in or around any part of the oven.
- **Do Not Clean Door Gasket**—The door gasket is essential for a good seal. Care should be taken not to rub, damage or move the gasket.
- The health of some birds is extremely sensitive to the fumes given off during the self-cleaning cycle of any range. Move birds to another well-ventilated room.

IMPORTANT INSTRUCTIONS FOR CLEANING YOUR RANGE

- **Clean the range regularly to keep all parts free of grease that could catch fire.** Pay particular attention to the area underneath each surface element. Do not allow grease to accumulate.
- **Kitchen cleaners and aerosols**—Always follow the manufacturer's recommended directions for use. Be aware that excess residue from cleaners and aerosols may ignite causing damage and injury.
- **Clean Ventilating Hoods Frequently**—Grease should not be allowed to accumulate on the hood or filter. Follow manufacturer's instructions for cleaning.

FOR CERAMIC-GLASS COOK TOP MODELS

- **Do Not Cook on Broken Cook Top**—If cook top should break, cleaning solutions and spillovers may penetrate the broken cook top and create a risk of electric shock. Contact a qualified technician immediately.
- **Clean Cook Top with Caution**—If a wet sponge or cloth is used to wipe spills on a hot cooking area, be careful to avoid a steam burn. Some cleaners can produce noxious fumes if applied to a hot surface.

Important Safety Notice

The California Safe Drinking Water and Toxic Enforcement Act requires the Governor of California to publish a list of substances known to the state to cause cancer, birth defects or other reproductive harm, and requires businesses to warn customers of potential exposure to such substances.

IMPORTANT INSTRUCTIONS FOR USING YOUR OVEN

- **Use Care When Opening Oven Door or Warmer Drawer (if equipped)**—Stand to the side of the range when opening the door of a hot oven. Let hot air or steam escape before you remove or replace food in the oven.
- **Keep Oven Vent Ducts Unobstructed.** The oven vent is located under the left rear surface element if your model is equipped with coil elements. The oven vent is located below the backguard for models equipped with ceramic-glass cook tops. Touching the surfaces in this area when the oven is operating may cause severe burns. Also, do not place plastic or heat-sensitive items on or near the oven vent. These items could melt or ignite.
- **Placement of Oven Racks.** Always place oven racks in desired location while oven is cool. If rack must be moved while oven is hot use extreme caution. Use potholders and grasp the rack with both hands to reposition. Do not let potholders contact the hot heating elements in the oven. Remove all utensils from the rack before moving.
- **Do not use the broiler pan without its insert.** The broiler pan and its insert allow dripping fat to drain and be kept away from the high heat of the broiler.
- **Do not cover the broiler insert with aluminum foil. Exposed fat and grease could ignite.**
- **Protective Liners**—Do not use aluminum foil to line the oven bottom. Only use aluminum foil as recommended in this manual. Improper installation of these liners may result in risk of electric shock, or fire.

Master Protection Agreements

Acuerdos de protección

Master Protection Agreements

Congratulations on making a smart purchase. Your new Kenmore® product is designed and manufactured for years of dependable operation. But like all products, it may require preventive maintenance or repair from time to time. That's when having a Master Protection Agreement can save you money and aggravation.

The Master Protection Agreement also helps extend the life of your new product. Here's what the Agreement* includes:

- ☑ **Parts and labor** needed to help keep products operating properly **under normal use**, not just defects. Our coverage goes **well beyond the product warranty**. No deductibles, no functional failure excluded from coverage – **real protection**.
- ☑ **Expert service** by a force of more than **10,000 authorized Sears service technicians**, which means someone you can trust will be working on your product.
- ☑ **Unlimited service calls and nationwide service**, as often as you want us, whenever you want us.
- ☑ **"No-lemon" guarantee** – replacement of your covered product if four or more product failures occur within twelve months.
- ☑ **Product replacement** if your covered product can't be fixed.
- ☑ **Annual Preventive Maintenance Check** at your request – no extra charge.
- ☑ **Fast help by phone** – we call it **Rapid Resolution** – phone support from a Sears representative on all products. Think of us as a "talking owner's manual".
- ☑ **Power surge protection** against electrical damage due to power fluctuations.
- ☑ **\$250 Food Loss Protection** annually for any food spoilage that is the result of mechanical failure of any covered refrigerator or freezer.
- ☑ **Rental reimbursement** if repair of your covered product takes longer than promised.
- ☑ **10% discount** off the regular price of any non-covered repair service and related installed parts.

Once you purchase the Agreement, a simple phone call is all that it takes for you to schedule service. You can call anytime day or night, or schedule a service appointment online.

The Master Protection Agreement is a risk free purchase. If you cancel for any reason during the product warranty period, we will provide a full refund. Or, a prorated refund anytime after the product warranty period expires. Purchase your Master Protection Agreement today!

Some limitations and exclusions apply. For prices and additional information in the U.S.A. call 1-800-827-6655.

*** Coverage in Canada varies on some items. For full details call Sears Canada at 1-800-361-6665.**

Sears Installation Service

For Sears professional installation of home appliances, garage door openers, water heaters, and other major home items, in the U.S.A. or Canada call 1-800-4-MY-HOME®.

Acuerdos maestros de protección

Enhorabuena por haber hecho una compra inteligente. Su nuevo producto Kenmore® está diseñado y fabricado para brindarle años de funcionamiento fiable. Pero, como cualquier producto, puede necesitar mantenimiento preventivo o reparaciones periódicas. Es por eso que tener un Acuerdo maestro de protección podría ahorrarle dinero y molestias.

El Acuerdo maestro de protección también sirve para prolongar la durabilidad de su nuevo producto. El acuerdo* incluye lo siguiente:

- ☑ **Piezas y mano de obra** necesarias para contribuir a mantener el funcionamiento adecuado de los productos **utilizados en condiciones normales de uso**, no sólo en caso de defectos de los productos. Nuestra cobertura va **mucho más allá que la garantía del producto**. No se aplican deducibles ni exclusiones por fallas del funcionamiento: es decir, **verdadera protección**.
- ☑ **Servicio técnico por expertos** (más de **10000 técnicos autorizados de Sears**), lo cual significa que quien repare o realice el mantenimiento de su producto será un profesional de confianza.
- ☑ **Servicio técnico a escala nacional y número ilimitado de llamadas de solicitud de servicio técnico**: se puede poner en contacto con nosotros cuantas veces lo desee y cuando lo desee.
- ☑ **Garantía "sin sorpresas"**: se reemplaza el producto cubierto por el acuerdo si ocurren cuatro o más fallas del producto en un periodo de 12 meses.
- ☑ **Reemplazo del producto**: en caso de que no se pueda reparar el producto cubierto por el acuerdo.
- ☑ **Revisión anual preventiva de mantenimiento del producto**: puede solicitarla en cualquier momento, sin costo alguno.
- ☑ **Rápida asistencia telefónica**, la cual denominamos **Solución rápida**: es decir, asistencia telefónica a través de cualquiera de nuestros representantes de Sears, sobre cualquiera de nuestros productos. Piense en nosotros como en un "manual parlante del usuario".
- ☑ **Protección contra fallas eléctricas**, contra daños debidos a fluctuaciones de la corriente eléctrica.
- ☑ **\$250 al año para cubrir cualquier posible deterioro de alimentos** que haya tenido que desechar debido a una falla mecánica de cualquiera de nuestros refrigeradores o congeladores cubiertos por este acuerdo.
- ☑ **Devolución de gastos de alquiler de electrodomésticos** si la reparación de su producto asegurado toma más que el tiempo prometido.
- ☑ **10% de descuento** aplicable tanto a los costos del servicio de reparación, como de las piezas instaladas relacionadas que no hayan quedado cubiertos por este acuerdo.

Una vez que haya realizado el pago de este acuerdo, bastará una simple llamada telefónica para concertar una visita de servicio. Puede llamar a cualquier hora del día o de la noche, o bien concertar una visita de servicio por Internet.

La adquisición del Acuerdo maestro de protección es una inversión exenta de riesgos. Si por cualquier motivo decide cancelar dicho acuerdo durante el periodo de garantía del producto, le haremos un reintegro total del valor. O bien un importe proporcional si cancela el acuerdo en cualquier otro momento posterior al vencimiento del periodo de garantía del producto. ¡Adquiera hoy mismo su Acuerdo maestro de protección!

Algunas limitaciones y exclusiones podrían aplicarse. Para solicitar precios e información adicional, llame al 1-800-827-6655 (en los EE.UU.).

*** La cobertura en Canadá varía en el caso de algunos artículos. Para obtener detalles completos al respecto, llame al 1-800-361-6665 de Sears de Canadá.**

Servicio de instalación de Sears

Para solicitar la instalación por profesionales de Sears de electrodomésticos, abridores de puertas de garaje, calentadores de agua y otros artículos de uso prioritario en el hogar, llame al 1-800-4-MY-HOME en los EE.UU. o Canadá.

Range Features

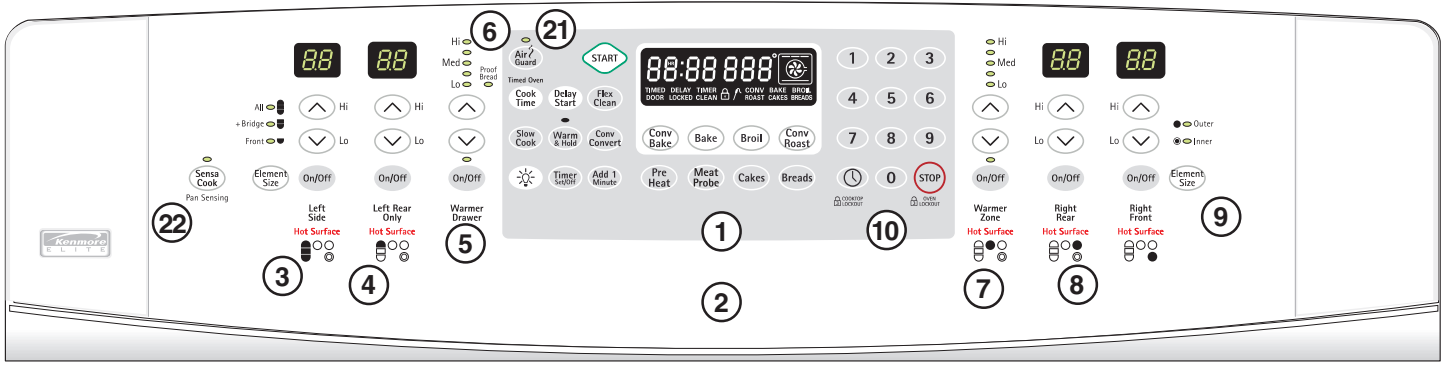

Your Electric Range Features Include:

1. Electronic Oven Control with Timer.
2. Glass Touch Sensitive Control Panel.
3. Left Front Element & Bridge Control & Electronic Display (some models).
3. Left Front Dual Element Control & Electronic Display (some models).
4. Left Rear 6" or 8" Element Control & Digital Display.
5. Warm & Ready Drawer Control & Indicator Light.
6. Bread Proof Indicator Lights.
7. Warm & Ready™ Zone Control & Indicator Lights.
8. Right Rear 6" Element Control & Digital Display.
9. Right Front 6-9-12" Triple Element & Digital Display (some models).
9. Right Front 9-12" Double Element & Digital Display (some models).
10. Oven & Cooktop Lockout Controls.
11. 2 Halogen Oven Interior Lights with removable Covers.
12. Automatic Oven Door Light Switch.
13. Self-Cleaning Oven interior.
14. Self-Clean Door Latch.
15. Adjustable Heavy Duty Porcelain Oven Racks.
16. Dual Oven Convection Fans & Cover.
17. Large 1 piece Oven Door Handle.
18. Full width Oven Door with Large Window.
19. Warm & Ready™ Drawer & Rack (not illustrated)
20. Warmer Drawer Humidity Controller
21. AirGuard™ Control & Indicator Light (some models).
22. SensaCook™ Control & Indicator Light (some models).
23. Broil Pan.
24. Broil Pan Insert.
25. Searing Grill.
26. Roasting Rack.
27. Griddle.
28. Leveling Legs and Anti-tip Bracket (included).

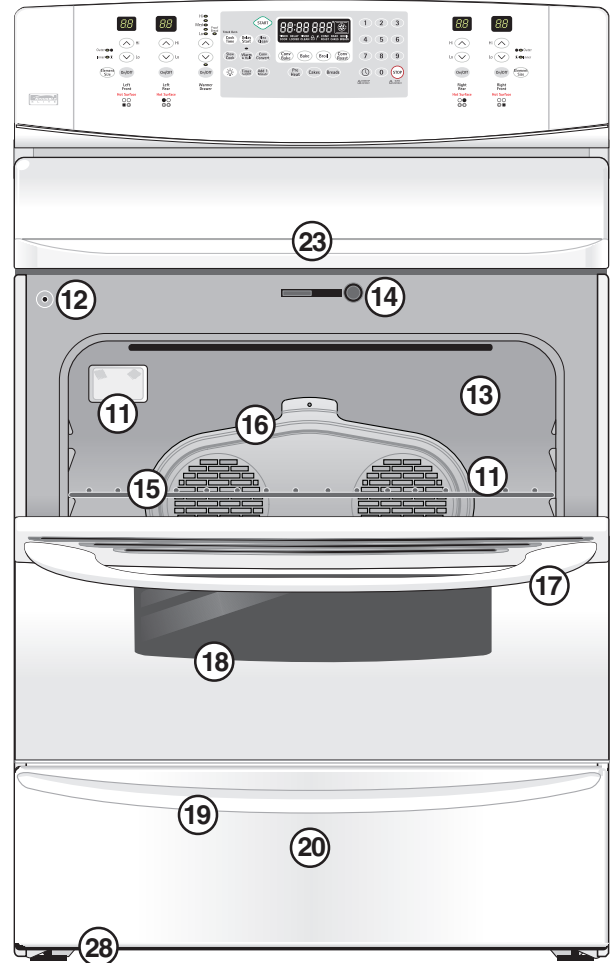

NOTE: The features of your range may vary according to model type & color.

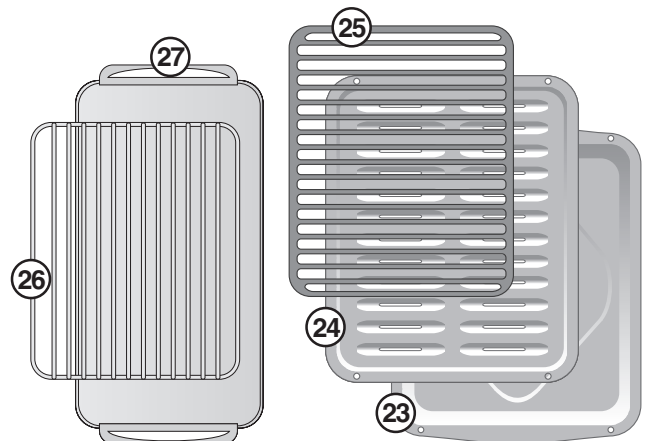

Range Features

Your Electric Range Features Include (cont'd):

- 29. Ceramic Smoothtop
- 30. 6" Single Radiant Element (some models).
- 31. 7" Single Radiant Element with pan sensing (some models).
- 32. Bridge Radiant Elements with pan sensing (some models).
- 33. 6-9" Double Element (some models).
- 34. Warm & Ready™ Zone Element.
- 35. 6" Single Radiant Element with pan sensing.
- 36. 9-12" Double Element with pan sensing (some models).
- 37. 6-9-12" Triple Radiant Element (some models).

NOTE: The features of your range may vary according to model type & color.

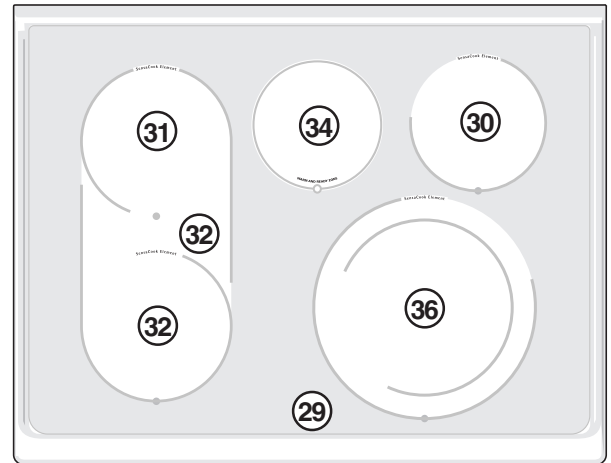
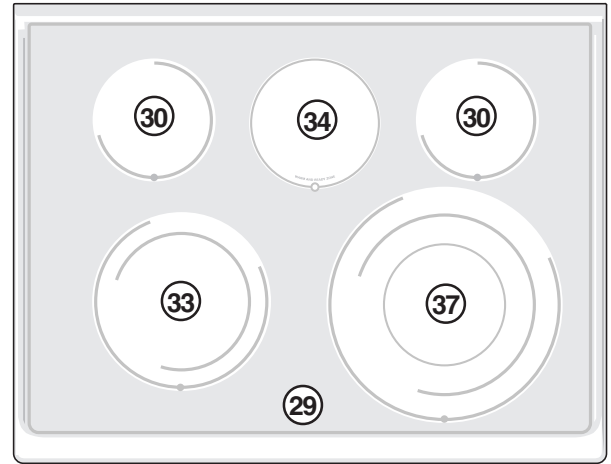

Cooktop with SensaCook™

ENGLISH

Before Setting Oven Controls

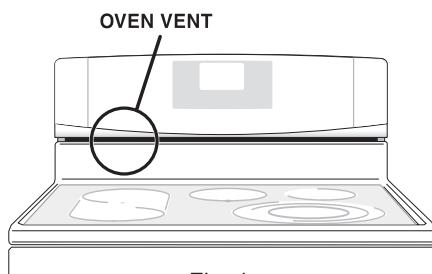

Fig. 1

Oven Vent Location

The oven vent is located **under the left side of the control panel** (See Fig. 1). When the oven is on, warm air passes through the vent. This venting is necessary for proper air circulation in the oven and good baking results. **DO NOT BLOCK OVEN VENT.**

Removing & Replacing Oven Racks

To remove, pull the rack forward until it stops. Lift up front of rack and slide out. **To replace,** fit the rack onto the guides on the oven walls. Tilt the front of the rack upward and slide the rack back into place.

Arranging Oven Racks

ALWAYS ARRANGE OVEN RACKS WHEN THE OVEN IS COOL (PRIOR TO OPERATING THE OVEN). Refer to Fig. 2. Always use oven mitts when using the oven. This range has a total of 7 oven rack positions.

Recommended Rack Positions for Broiling, Baking & Roasting:

Food	Rack Position
Broiling hamburgers & steaks	See Broil
Broiling meats, chicken or fish	See Broil
Cookies, cakes, pies, biscuits & Muffins	3 or 4
Frozen pies, angel food cake, yeast, bread, casseroles, small cuts of meat or poultry	1 or 2
Turkey, roast or ham	1 or Roasting Shelf



Fig. 2

Before Setting Oven Controls

Types of Oven Racks

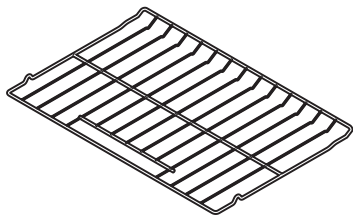

Flat Handle Oven Rack
Fig. 1

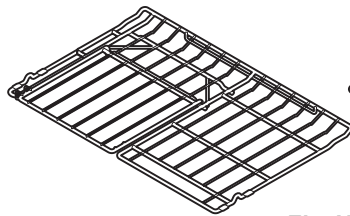

Flat Half Rack
Fig. 2

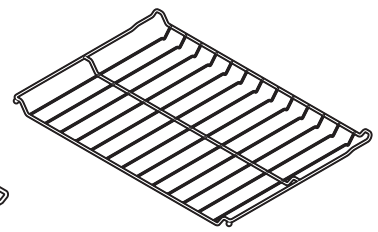
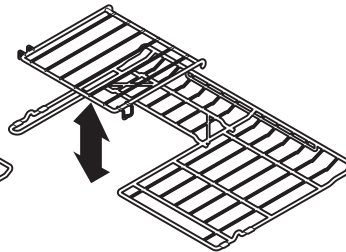

Offset Oven Rack
(some models)
Fig. 3

CAUTION Always use pot holders or oven mitts when adjusting the oven racks. Wait until the oven has completely cooled if possible. Oven racks may be HOT and may cause burns.

Your range may be equipped with one or more of the oven rack types shown; **Flat Handle Oven Rack** (Fig. 1), **Flat Oven Half Rack** (Fig. 2) and **Offset Rack** (Fig. 3). To maximize cooking space the **Offset Rack** can be used in the lowest rack position to roast large cuts of meat and poultry.

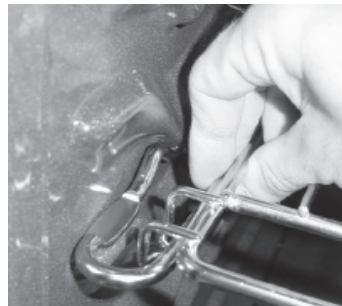

Fig. 4

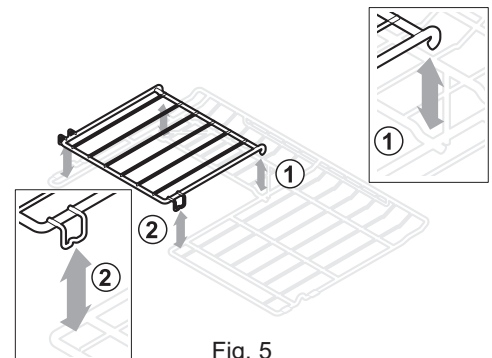

Fig. 5

The **Flat Half Rack** has a removable insert that can provide extra space for larger food items. The right half rack portion may still be used for other food items like a casserole dish (See Fig. 5). To remove the insert, squeeze on the left front insert side (See Fig. 4) of the rack and tilt out clockwise. To reinstall insert rear hooks at back of insert (See 1-Fig. 5) and lay insert down. Make sure both insert front hooks snap into rack (See 2-Fig. 5).

Do not use cookware that extends beyond the edge of the Flat Half Rack. For best results, allow 2 inches between the pan placed on the rack and oven side or rear walls.

Baking Layer Cakes with 1 or 2 Oven Racks

For best results when baking cakes using 2 oven racks, place cookware on rack positions 2 (Flat Handle Oven Rack) & 5 with the Offset Oven Rack (See Fig. 6). For best results when using a single oven rack, place cookware on rack position 4 (See Fig. 7).

Air Circulation in the Oven

For best air circulation and baking results allow 2-4" (5-10 cm) around the cookware for proper air circulation and be sure pans and cookware do not touch each other, the oven door, sides or back of the oven cavity. The hot air must be able to circulate around the pans and cookware in the oven for even heat to reach around the food.



Fig. 6

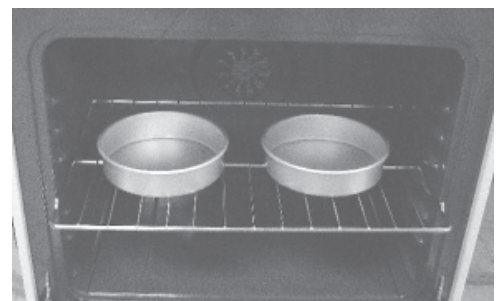

Fig. 7

Before Setting Surface Controls

- General Cooktop Information
- About Radiant Surface Elements
- Locations of the Radiant Surface Elements and Controls
- Locking & Unlocking the Cooktop

About the Ceramic Glass Cooktop

The ceramic cooktop has radiant surface elements located below the surface of the glass. The design of the ceramic cooktop outlines the area of the surface element underneath (See Figs. 1, 2, 3 & 4).

Heat is transferred up through the surface of the cooktop to the cookware. The type and size and condition of the cookware, the number of surface elements in use and their settings, are all factors that will affect the amount of heat that will spread to areas beyond the surface elements. **Note: The areas surrounding the elements may become hot enough to cause burns.**

About the Radiant Surface Elements

The element temperature rises gradually and evenly. As the temperature rises, the element will glow red. To maintain the selected setting, the element will cycle on and off. The heating element retains enough heat to provide a uniform and consistent heat during the off cycle. For efficient cooking, turn off the element several minutes before cooking is complete. This will allow any remaining heat to complete the cooking process.

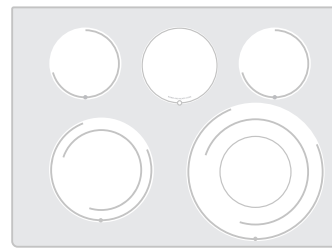

Fig. 1

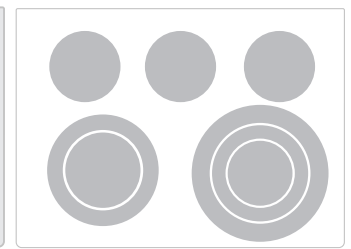

Fig. 2

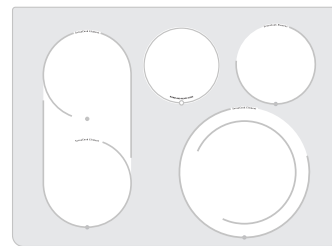

Fig. 3

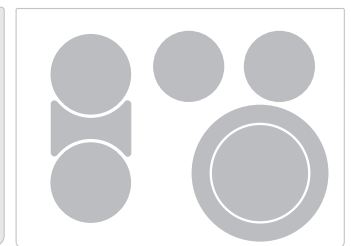



Fig. 4

NOTE: Radiant elements have a limiter that allows the element to cycle on and off, even at the HI setting. This helps to prevent damage to the ceramic smoothtop. Cycling at the HI setting is normal and can occur if the cookware is too small for the radiant element or if the pan bottom is not flat. Refer to page 17 for more details about using proper cookware on the cooktop.

NOTE: Be sure to read detailed instructions for ceramic glass cooktop cleaning in the **General Care & Cleaning** section and **Before You Call** checklist section of this manual.

To Set the Cooktop Lockout Feature

The  pad is used to activate the Cooktop Lockout feature which will lock all surface elements from being accidentally turned ON (including Warmer Zone). This feature will only lock the cooktop.



To turn the Cooktop Lockout Feature ON:

1. BE SURE ALL surface element controls are set to the OFF position.
2. Press and hold  until a 2nd beep sounds. If a triple beep sounds instead, check all surface elements and turn them to the OFF position and repeat this step. The Cooktop Locked indicator light will turn ON and the cooktop controls and functions are locked out until the cooktop is unlocked (See Fig. 5).

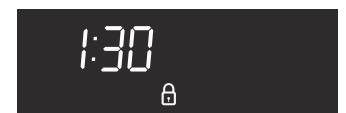



Fig. 5

To turn the Cooktop Lockout Feature OFF:

1. BE SURE ALL surface element controls are set to the OFF position.
2. Press and hold  until a 2nd beep sounds (after 3 seconds). If a triple beep sounds instead, check all surface elements and turn them to the OFF position and repeat this step. The Cooktop Locked indicator light will turn OFF and the cooktop may be used normally (See Fig. 6).

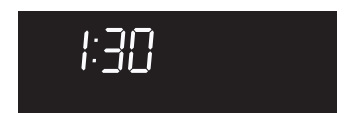

Fig. 6

Note: Starting a Self-Clean cycle will automatically turn ON the Cooktop Lockout feature. The cooktop will remain locked until the Self-Clean cycle has completed and the oven door has unlocked. If a power failure occurs after the Cooktop Lockout has been activated, you must turn OFF the Cooktop Lockout feature before being able to use the cooktop features again.

Setting Surface Controls

- Electronic Surface Element Controls (ESEC)
- Available ESEC Display Settings
- Hot Surface Indicator Lights
- Cooktop Sabbath Day Feature and Message (Sb)
- ESEC Lockout Feature (- -)

The Electronic Surface Element Control (ESEC)

The Electronic Surface Element Control ("ESEC") feature provides a digital display of the radiant surface elements on the cooktop. The ESEC displays in combination with the touch pads are designed to replace the conventional control knob and power level tick mark indicators.

In addition your range includes shared radiant element touch pad settings. The "Bridge" element combinations and Triple radiant element settings are also shown in the ESEC display windows.

The available ESEC Window Display Settings

The ESEC control will display heat levels ranging from **Hi** (Fig. 1) to **Lo** (Fig. 6) and **OFF** (Fig. 7) that will display in the ESEC windows. The settings between **9.0** (Fig. 2) and **3.0** (Fig. 3) decrease or increase in increments of .5 (1/2). The settings between **3.0** (Figs. 3 & 4) and **1.0** (Fig. 5) are Simmer settings which decrease or increase in increments of .2 to **Lo** (Fig. 6; lowest Simmer setting) for more precise settings at lower heat levels. Use the Recommended Surface Setting Chart (See page 11, Fig. 1) to determine the correct setting for the kind of food you are preparing.

Hot Surface Indicator Lights

After using any of the radiant element positions the cooktop will become very hot. After turning any of these elements OFF, the cooktop will remain HOT for some time. The backguard control monitors the temperature for 5 positions on the cooktop. The "**Hot Surface**" indicator light (Fig. 8) will glow whenever any of the element positions becomes HOT. The **Hot Surface** indicator light will remain ON while hot and turn OFF once the cooktop has cooled sufficiently (Fig. 9).

ESEC PF message

The ESEC will display the PF message whenever there has been a power interruption to the appliance. PF will appear in the ESEC display windows as shown in Fig. 10. To clear the PF message touch any ON/OFF ESEC control pad to reset and be sure to reset the clock with the correct time of day if necessary. If the PF displays again repeat these steps.

Cooktop Sabbath Day Feature and (Sb) Message

The ESEC will display the **Sb** messages whenever the Sabbath Day feature is active (Fig. 11). When activated, the Sabbath Day Feature works for both the oven and cooktop together. Once the Sabbath Day Feature is active, changes to the heat levels for the cooktop elements will not show in the displays. The cooktop will react slower to heat level changes. To set the Sabbath Day feature see the complete instructions on page 32.

ESEC Lockout Feature (- -)

The ESEC feature will not operate during a Self-Clean cycle or when the Oven Lockout feature is active. Whenever the ESEC Lockout feature is active, " - - " will appear in any display window (See Fig. 12. Also refer to the Oven Lockout instructions on page 21).



Fig. 1



Fig. 2



Fig. 3



Fig. 4



Fig. 5



Fig. 6



Fig. 7

Right
Rear

Hot Surface



Fig. 8

Right
Rear



Fig. 9



Fig. 10



Fig. 12



Fig. 11

Setting Surface Controls

- Recommended Surface Cooking Settings
- Operating Single Surface Radiant Controls

Recommended Surface Cooking Settings

Recommended settings for the Single, Bridge & Triple Surface Radiant Cooktop Elements	
Setting	Type of Cooking
HIGH (8.0 - Hi)	Start most foods, bring water to a boil or pan broiling
MEDIUM HIGH (5.0 - 8.0)	Continue a rapid boil, fry or deep fat fry
MEDIUM (3.0 - 5.0)	Maintain a slow boil, thicken sauces and gravies or steam vegetables
MEDIUM LOW (2.0 - 4.0)	Keep foods cooking, poach or stew (2.8 or lower is a simmer setting).
LOW/SIMMER (Lo - 2.0)	Keep warm, melt or simmer (2.8 or lower is a simmer setting).

Fig. 1

Note: The size and type of cookware used will influence the setting needed for the best cooking results. The simmer settings are used to simmer and keep larger quantities of foods warm such as stews and soups. The lower simmer settings are ideal for delicate foods and melting chocolate or butter.

Operating Single Radiant Surface Elements

The cooktop has 2 SINGLE radiant surface elements; the **RIGHT REAR** position and the **LEFT REAR** element positions may be used as single element (See Fig. 2 or 3). Refer to Fig. 1 for recommended surface cooking settings.

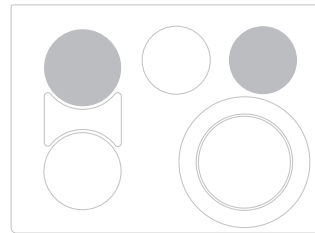

Fig. 2

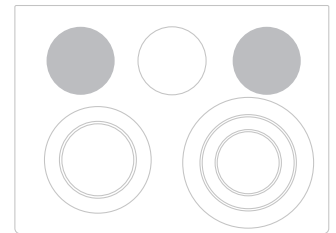

Fig. 3

ENGLISH

To Operate the Single Radiant Surface Elements:

1. Place correctly sized cookware on the radiant surface element.
2. Touch and hold the **On/Off** pad for the desired element position until a beep is heard. The display will show "--".

NOTE: Each time a pad is touched a beep will sound. If no further pads are touched within 10 seconds the request to power the element ON will clear.

3. Touch the element position's **Hi** pad once to turn ON the power level **Hi** or **Lo** pad once for **Lo** (See Fig. 4). The **Hot Surface** indicator light will turn ON when the element becomes hot.
4. Each touch of the **Lo** or **Hi** pad will decrease or increase the power level by 1/2 from 9.0 through 3.0. Simmer power levels between 3.0 and 1.0 will decrease or increase by .2 increments. **Lo** is the lowest power level available. Note: The power level may be adjusted at any time while the element is ON.
5. When cooking has been completed touch the **On/Off** pad once to turn the element OFF.

Each surface element provides a constant amount of heat at each setting. A glowing red surface heating area extending beyond the bottom edge of the cookware indicates the cookware is **too small** for the surface heating area.

Note: The **Hot Surface** indicator light will remain ON if the cooktop is still hot and will remain ON until the heating surface area has cooled sufficiently.



Right Rear

Hot Surface



Fig. 4

CAUTION Radiant surface elements may appear to have cooled after they have been turned off. **The glass surface may still be hot** and burns may occur if the glass surface is touched before it has cooled sufficiently.

CAUTION Do not place aluminum foil or plastic items such as salt and pepper shakers, spoon holders or plastic wrappings on top of the range when it is in use. These items could melt or ignite. Potholders, towels or wooden spoons could catch fire if placed too close to the surface elements.

Setting Surface Controls

- Operating the Double Surface Radiant Control

Operating the Double Element (some models)

The cooktop is equipped with Double radiant surface elements (See Fig. 1). Indicator lights on the control panel at that position are used to indicate what portions of the double radiant element will heat. The **INNER** light indicates that only the inner element will heat. The **OUTER** light indicates that both inner and outer elements will heat together.

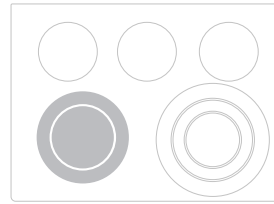

Fig. 1

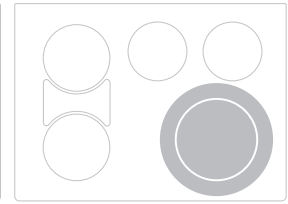

Fig. 2

To Operate the Double Surface Elements:

- Place correctly sized cookware on the radiant surface element.
- Touch and hold the **On/Off** pad for the Double element position until a beep is heard. The display will show "--".

NOTE: Each time a pad is touched a beep will sound. If no further pads are touched within 10 seconds the request to power the element ON will clear.

- Select the **INNER** (See Fig. 2) or **OUTER** (See Fig. 3) to heat by pressing the **Element Size** pad once or twice.
- Touch the Double element **Hi** or **Lo** pad once to turn ON the power level **Hi** or **Lo** (See Fig.4). The **Hot Surface** indicator light will turn ON when the element becomes hot.
- Each touch of the **Lo** or **Hi** pad will decrease or increase the power level by 1/2 from **9.0** through **3.0**. Simmer power levels between **3.0** and **1.0** will decrease or increase by .2 increments. **Lo** is the lowest power level available. Note: The power level may be adjusted at any time while the element is ON.
- When cooking has been completed touch the **On/Off** pad once to turn the element OFF.

Each surface element provides a constant amount of heat at each setting. A glowing red surface heating area extending beyond the bottom edge of the cookware indicates the cookware is **too small** for the surface heating area.

Note: The **Hot Surface** indicator light will remain ON if the cooktop is still hot and will remain ON until the heating surface area has cooled sufficiently.

Note: If no element size is chosen when the Double element is turned ON, the control will default to the inner coil only. See page 11, Fig. 1 for recommended surface cooking settings.

CAUTION Radiant surface elements may appear to have cooled after they have been turned off. **The glass surface may still be hot** and burns may occur if the glass surface is touched before it has cooled sufficiently.

CAUTION Do not place aluminum foil or plastic items such as salt and pepper shakers, spoon holders or plastic wrappings on top of the range when it is in use. These items could melt or ignite. Potholders, towels or wooden spoons could catch fire if placed too close to the surface elements.

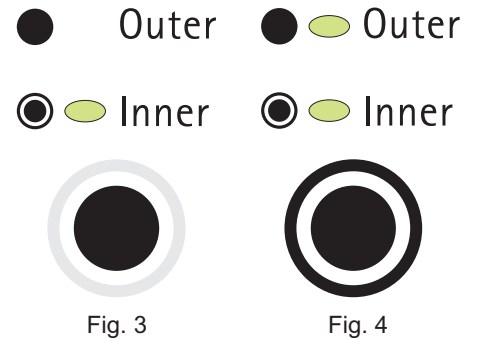

Fig. 3



Fig. 4



Right Front

Hot Surface



Fig. 5

Setting Surface Controls

- Operating the Triple Surface Radiant Control

Operating the Triple Element (some models)

The cooktop is equipped with a TRIPLE radiant surface element located at the right front cooktop position (See Fig. 1). Indicator lights on the control panel at that position are used to indicate what portions of the Triple radiant element will heat. The **INNER** light indicates that only the inner element will heat. The **+MIDDLE** light indicates that both inner and middle elements will heat together. The **ALL** light indicates that all 3 portions of the element will heat. You may switch between all of these different settings at any time during cooking.

To Operate the Triple Surface Element:

- Place correctly sized cookware on the radiant surface element.
- Touch and hold the **On/Off** pad for the Triple element position until a beep is heard. The display will show " - - ".

NOTE: Each time a pad is touched a beep will sound. If no further pads are touched within 10 seconds the request to power the element ON will clear.

- Select the **INNER** (See Fig. 2), **+MIDDLE** (See Fig. 3) or **ALL** 3 elements (See Fig. 4) to heat by pressing the **Element Size** pad once, twice or three times (See Figs. 4 & 5 show indicator lights with **ALL** 3 elements selected).
- Touch the Triple element **Hi** pad once to turn ON the power level **Hi** or **Lo** pad once for **Lo** (See Fig. 4). The **Hot Surface** indicator light will turn ON when the element becomes hot.
- Each touch of the **Lo** or **Hi** pad will decrease or increase the power level by 1/2 from **9.0** through **3.0**. Simmer power levels between **3.0** and **1.0** will decrease or increase by .2 increments. **Lo** is the lowest power level available. Note: The power level may be adjusted at any time while the element is ON.
- When cooking has been completed touch the **On/Off** pad once to turn the element OFF.

Each surface element provides a constant amount of heat at each setting. A glowing red surface heating area extending beyond the bottom edge of the cookware indicates the cookware is **too small** for the surface heating area. **Note:** The **Hot Surface** indicator light will remain ON if the cooktop is still hot and will remain ON until the heating surface area has cooled sufficiently.

Note: If no element size is chosen when the Triple element is turned ON, the control will default to the inner coil only. See page 11, Fig. 1 for recommended surface cooking settings.

CAUTION Radiant surface elements may appear to have cooled after they have been turned off. **The glass surface may still be hot** and burns may occur if the glass surface is touched before it has cooled sufficiently.

CAUTION Do not place aluminum foil or plastic items such as salt and pepper shakers, spoon holders or plastic wrappings on top of the range when it is in use. These items could melt or ignite. Potholders, towels or wooden spoons could catch fire if placed too close to the surface elements.

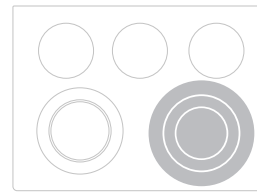

Fig. 1

● All

● +Middle

● Inner



Fig. 2

● All

● +Middle

● Inner



Fig. 3

● All

● +Middle

● Inner



Fig. 4



● All

● +Middle

● Inner

Right Front

Hot Surface



Fig. 5

Setting Surface Controls

- Operating the Bridge Radiant Surface Element Control

Operating the Bridge Element (some models)

The cooktop is equipped with a "BRIDGE" surface element located at the left cooktop position (See Fig. 1). Indicator lights on the control panel are used to indicate what portions of the Bridge element will heat. The Bridge element begins with the left **FRONT** position only (Fig. 2) and when selected with the **+BRIDGE** element (Fig. 3) it will provide a combination of 2 heating surfaces. When set for **ALL** 3 element positions the left rear element is added for a total combination of 3 even heating surfaces (See Fig. 4).

The Bridge element is designed for rectangular or oval shaped cookware. The **griddle** that is supplied with this appliance **should be used with the Bridge element ONLY**. For round shaped cookware, the left front element may be used as a single element.

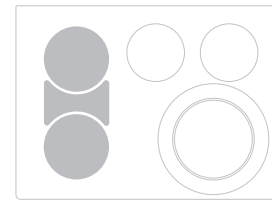

Fig. 1

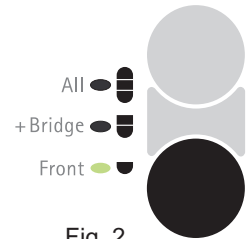

Fig. 2

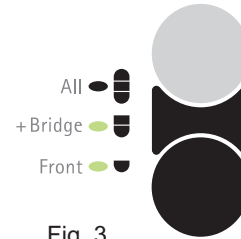

Fig. 3

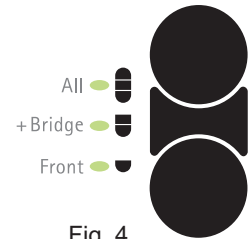
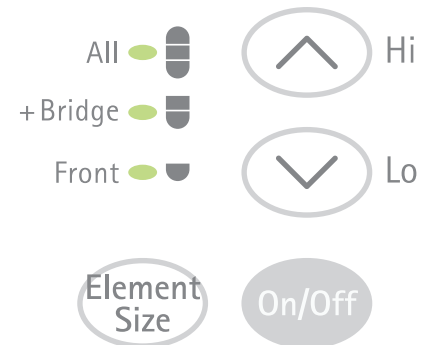

Fig. 4

To Operate the Bridge Surface Element:

- Place correctly sized cookware on the radiant surface element.
- Touch and hold the **On/Off** pad for the Bridge element position until a beep is heard. The display will show " - - ". **NOTE:** Each time a pad is touched a beep will sound. If no further pads are touched within 10 seconds the request to power the element ON will clear.
- Select the **FRONT** (See Fig. 2), **+BRIDGE** (See Fig. 3) or **ALL** 3 elements (See Fig. 4) to heat by pressing the **Element Size** pad once, twice or three times (Figs. 4 & 5 shows indicator lights with **ALL** 3 elements selected).
- Touch the Bridge element **Hi** pad once to turn ON the power level **Hi** or **Lo** pad once for **Lo** (See Fig. 4). The **Hot Surface** indicator light will turn ON when the element becomes hot.
- Each touch of the **Lo** or **Hi** pad will decrease or increase the power level by 1/2 from **9.0** through **3.0**. Simmer power levels between **3.0** and **1.0** will decrease or increase by .2 increments. **Lo** is the lowest power level available. Note: The power level may be adjusted at any time while the element is ON.
- When cooking has been completed touch the **On/Off** pad once to turn the element OFF.



Left Side

Hot Surface



Fig. 5

NOTE: If all 3 Bridge elements are selected, any previous power level setting for the **LEFT REAR** element will be changed to the power level setting for the Bridge.

Each surface element provides a constant amount of heat at each setting. A glowing red surface heating area extending beyond the bottom edge of the cookware indicates the cookware is **too small** for the surface heating area.

Note: The **Hot Surface** indicator light will remain ON if the cooktop is still hot and will remain ON until the heating surface area has cooled sufficiently. If no element size is chosen when the Bridge element is turned ON, the control will default to the left front element only. See page 11, Fig. 1 for recommended surface cooking settings.

CAUTION Radiant surface elements may appear to have cooled after they have been turned off. **The glass surface may still be hot** and burns may occur if the glass surface is touched before it has cooled sufficiently.

CAUTION Do not place aluminum foil or plastic items such as salt and pepper shakers, spoon holders or plastic wrappings on top of the range when it is in use. These items could melt or ignite. Potholders, towels or wooden spoons could catch fire if placed too close to the surface elements.

Setting Surface Controls

- Setting Warmer Zone Control

Operating the Warmer (Warm & Ready™) Zone

The purpose of the Warmer Zone is to keep hot cooked foods at serving temperature. Use the Warmer Zone to keep cooked foods hot such as; vegetables, gravies, casseroles, soups, stews, breads, pastries and oven-safe dinner plates. Always start with hot food. It is not recommended to heat cold food on the Warmer Zone.





All food placed on the Warmer Zone should be covered with a lid to maintain moisture. For best results when warming pastries or breads, the cover should have an opening to allow moisture to escape. **Do not use plastic wrap or aluminum foil to cover food. Plastic or aluminum foil may melt onto the cooktop.**

Use only plates, utensils and cookware recommended for oven and cooktop use on the Warmer Zone.

Warmer Zone Temperature Selection

Refer to the Warmer Zone table for recommended heating levels (See Fig. 1). If a particular food is not listed, start with the medium level, and adjust as needed. Most foods can be kept at serving temperatures by using the medium level.

To Set the Warmer Zone Control:

- Touch the **On/Off** pad at the Warmer Zone control position once. The Warmer Zone indicator light will flash. **NOTE:** If no further pads are touched within 25 seconds the request to power the Warmer Zone ON will clear.
- At the Warmer Zone control position touch  once to turn ON the power level for **Hi** (See Fig. 2) or  to turn ON the power level for **Lo** (See Fig. 5). The Warmer Zone indicator light will glow steady indicating the Warmer Zone is ON. The **Hot Surface** indicator light will turn ON when the Warmer Zone becomes hot.
- Each touch of the  or  will decrease or increase the power levels. The Warmer Zone has 5 power levels from **Hi** (See Fig. 2) through **Med** (See Fig. 4) to **Lo** (See Fig. 5). The power level may be adjusted at any time while the Warmer Zone is ON.
- When the food is ready to serve, touch the **On/Off** pad once to turn the Warmer Zone OFF. The Warmer Zone indicator light will turn OFF.

Note: The **Hot Surface** indicator light will remain ON if the cooktop is still hot and will remain ON until the heating surface area has cooled sufficiently (See Fig. 3).

CAUTION Radiant surface elements may appear to have cooled after they have been turned off. **The glass surface may still be hot** and burns may occur if the glass surface is touched before it has cooled sufficiently.

CAUTION **Do not place aluminum foil or plastic items such as salt and pepper shakers, spoon holders or plastic wrappings on top of the range when it is in use.** These items could melt or ignite. Potholders, towels or wooden spoons could catch fire if placed too close to the surface elements.

CAUTION The Warmer Zone will not glow red when it becomes hot, but becomes hot enough to cause burns. Avoid placing hands on or near the Warmer Zone until the Warmer Zone Hot Surface indicator light is OFF. Always use potholders or oven mitts when removing food from the Warmer Zone as cookware and plates will be hot.

Food Item	Heating Level
Hot Beverages	Hi
Fried Foods	Hi
Vegetables	Med
Soups (Cream)	Med
Stews	Med
Sauces	Med
Meats	Med
Gravies	Lo
Eggs	Lo
Dinner Plates with Food	Lo
Casseroles	Lo
Breads/Pasteries	Lo

Fig. 1

ENGLISH

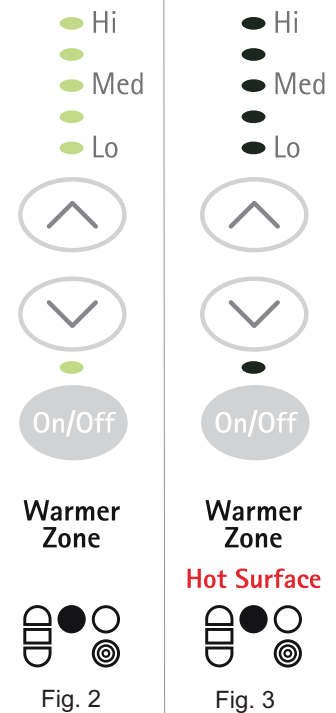

Fig. 2

Fig. 3

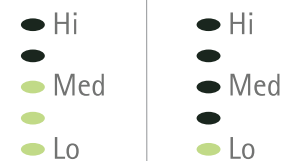

Fig. 4

Fig. 5

Surface Cooking

SensaCook™ (some models)

Some models come with SensaCook™, a pan sensing feature. The SensaCook™ key will activate or deactivate pan sensing feature and the dual element pan sizing features (Fig. 1).

The LED light located above the SensaCook™ pad (Fig. 1) will indicate when this feature is active. If the feature is active, any cooking zone marked SensaCook™ Element (Fig. 2) will begin to heat only when properly sized metallic cookware is placed on one of the surface cooking zones.

If metallic cookware is not used or if metallic cookware is not properly centered on the cooking zone, the surface element control display will **flash** the power level setting indicating that the cooking zone is **not** heating. When proper cookware has been detected, the surface element control will display the power level without flashing.

If the SensaCook™ feature is active and the cookware is removed from heating zone while cooking, the SensaCook™ feature will deactivate the affected cooking zone and will stop heating (the display will **flash** the power level). If the cookware is not placed back on the cooking zone within 1 minute, the cooktop control will provide a reminder beep. If the cookware is not placed back on the cooking zone within 5 minutes the SensaCook™ feature will completely deactivate the affected cooking zone and flush the previous power level setting automatically.

Any cooking zone may also be used without activating the SensaCook™ feature. If deactivated, the cooking zone elements produce heat when using all types of cookware.

When the SensaCook™ feature is active, the Element Size keypad for the Bridge Element will be available for setting. The Element Size keypad for the Dual Element will not be available, but the SensaCook™ pan sensing system will automatically detect and set the proper pan size. The SensaCook™ feature does not work with the Warming Zone element (See Fig. 3).



Fig. 1



Fig. 2

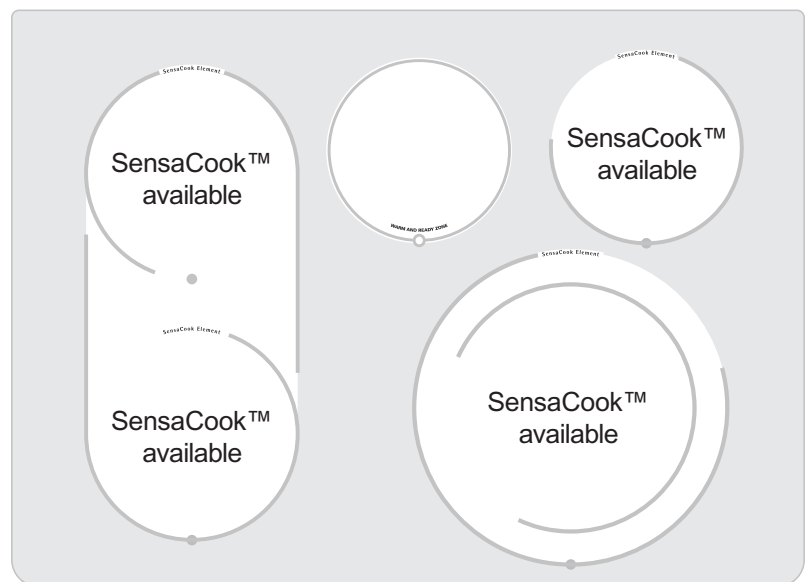

Fig. 3

NOTE: Only proper sized metallic cookware should be used when using SensaCook™. Cookware detection abilities of the SensaCook™ feature will depend on the cookware material type, thickness and flatness.

Surface Cooking

- Using Proper Cookware
- Cookware Material Types
- Arranging Warmer Drawer Racks

Using proper cookware

The size and type of cookware used will influence the setting needed for best cooking results. Cookware should have flat bottoms that make good contact with the entire surface heating element (See Fig. 2). Check for flatness by rotating a ruler across the bottom of the cookware (See Fig. 1).

Be sure to follow the recommendations for using proper cookware as illustrated.

For more information about the ceramic cooktop see "Cooktop Cleaning & Maintenance" in the **General Care & Cleaning** section.

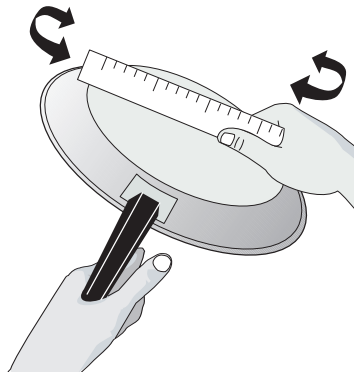
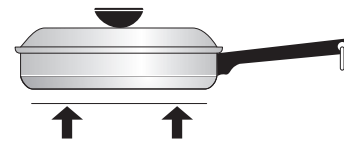

Fig. 1

*CORRECT



- Flat bottom and straight sides.
- Tight fitting lids.
- Weight of handle does not tilt pan. Pan is well balanced.
- Pan sizes match the amount of food to be prepared and the size of the surface element.
- Made of a material that conducts heat well.
- Easy to clean.
- Always match pot diameter to element surface diameter.

INCORRECT



- Curved and warped pan bottoms.
-
- Pan overhangs element by more than one-half inch.
-
- Pan is smaller than element.
-
- Heavy handle tilts pan.

Fig. 2

Cookware Material Types

The cookware material determines how evenly and quickly heat is transferred from the surface element to the pan bottom. The most popular materials available are:

ALUMINUM - Excellent heat conductor. Some types of food will cause it to darken (Anodized aluminum cookware resists staining & pitting). If aluminum pans slide across the ceramic cooktop, they may leave metal marks which will resemble scratches. Remove these marks immediately.

COPPER - Excellent heat conductor but discolors easily. May leave metal marks on ceramic glass (see Aluminum above).

STAINLESS STEEL - Slow heat conductor with uneven cooking results. Is durable, easy to clean and resists staining.

CAST IRON - A poor heat conductor however will retain heat very well. Cooks evenly once cooking temperature is reached. Not recommended for use on ceramic cooktops.

PORCELAIN-ENAMEL on METAL - Heating characteristics will vary depending on base material. Porcelain-enamel coating must be smooth to avoid scratching ceramic cooktops.

GLASS - Slow heat conductor. Not recommended for ceramic cooktop surfaces because it may scratch the glass.

Arranging Warmer (Warm & Ready™) Drawer Rack Positions

The rack can be used in two ways:

- In the **upward position** (See Fig. 1) to allow low profile food items to be placed both under and on top of the rack (for example, rolls or biscuits on top of the rack and a casserole dish underneath).
- In the **downward position** (See Fig. 2) to allow you to place light weight food items and empty dishware (for example, rolls or pastries and dinner plates) on the rack.

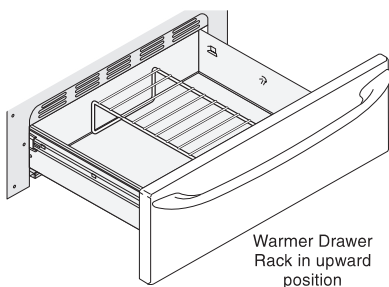

Fig. 1

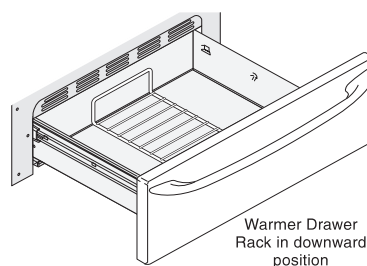

Fig. 2

CAUTION Always use potholders or oven mitts when removing food from the Warmer Drawer as cookware and plates will be hot and you can be burned.

Setting Warmer Drawer Controls

- Operating & Setting Warmer Drawer Controls
- Warmer Drawer & Bread Proofing Indicator Lights
- Warmer Drawer Humidity Controller

Operating the Warmer Drawer

The purpose of the Warmer Drawer is to keep hot cooked foods at serving temperature. Always start with hot food. It is not recommended to heat cold food in the Warmer Drawer. All food placed in the Warmer Drawer should be covered with a lid or aluminum foil to maintain quality.

Do not use plastic wrap to cover food. Plastic may melt onto the drawer and be very difficult to clean. Use only utensils and cookware recommended for oven use in the Warmer Drawer.

Warmer (Warm & Ready™) Drawer & Bread Proofing Indicator Lights

The control and indicator lights for the Warmer Drawer and Bread Proofing features are located on the control panel. The indicator lights will turn ON when the control is set, and remain ON until the controls are turned OFF.

Note: The Warmer Drawer will not operate during the Self-Clean cycle.

Warmer Drawer Humidity Controller Feature

This feature may be used to control humidity levels in the Warmer Drawer. The control knob is located on the inner front panel of the Warmer Drawer.

To help keep foods moist, move the handle to the right. This closes the vents and helps keep the moisture inside the Warmer Drawer. For crisp foods, move the handle to the left. This opens the vents and allows more of the moisture to escape.

For Dry Heat: Slide the humidity control knob in the direction of (Less) < (See Fig. 1). This allows more of the moist heat to escape and provides a dryer environment for the food in the Warmer Drawer.

For Moist Heat: Slide the humidity control knob in the direction of (More) > (See Fig. 2). This will help keep the food in the Warmer Drawer from drying out. Both heat and moisture will be applied to the Warmer Drawer cavity.

Note: For some types of servings you may want to store previously prepared food in a “dry heat” environment. For frequent controller adjustments, slightly loosen humidity controller knob and slide to any desired position. To maintain a desired setting, adjust controller knob into position and tighten knob.

Warmer Drawer Recommended Food Settings Table	
Food Item	Setting
Bacon	Hi
Hamburger Patties	Hi
Poultry	Hi
Pork Chops	Hi
Fried Foods	Hi
Pizza	Hi
Gravies	Med
Casseroles	Med
Eggs	Med
Roasts (Beef, Pork, Lamb)	Med
Vegetables	Med
Biscuits	Med
Rolls, hard	Med
Pastries	Med
Rolls (soft)	Lo
Empty Dinner Plates	Lo

Fig. 3

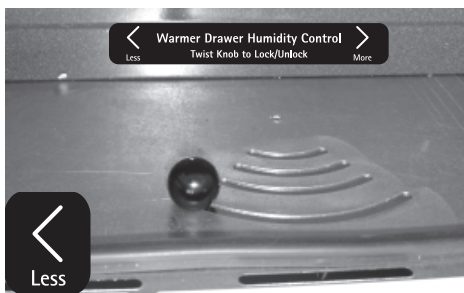

Fig. 1









Fig. 2

Setting Warmer Drawer Controls

- Arranging Warmer Drawer Racks
- Bread Proofing

To Set the Warmer Drawer & Bread Proofing Controls:

1. Touch the **On/Off** pad at the Warmer Drawer control position. The Warmer Drawer indicator light will flash. Note: If no further pads are touched within 25 seconds the request to power the Warmer Drawer ON will clear.
2. Set the desired power level. Touch  once to turn ON the power level for **Hi** (Fig. 2) or  to turn ON the power level for **Lo** (See Fig. 4). The Warmer Drawer indicator light will glow steady indicating the Warmer Drawer is ON.
3. Each touch of the  or  pads will decrease or increase through 6 power levels from **Hi** (See Fig. 2) to **Med** (See Fig. 3) to **Lo** (See Fig. 4) and to the **Bread Proofing** feature (Fig. 5). If the Warmer Drawer is set at the **Lo** setting and the  pad is touched again the Bread Proofing feature will be turned ON (The Bread Proof indicator light will glow steady indicating the Bread Proofing feature in ON (See Fig. 5 & bread dough preparation instructions on this page). To return to standard Warmer Drawer settings touch  pad at least once. Note: For best results, preheat the Warmer Drawer before adding the food or bread dough. An empty drawer will preheat in approximately 15 minutes.
4. When the food or dough is ready for removal, touch the **On/Off** pad once to turn the Warmer Drawer or Bread Proof feature OFF. The Warmer Drawer indicator light will turn OFF.

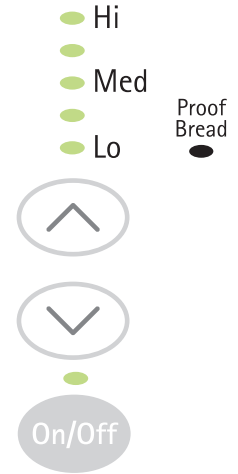

Warmer Drawer

Fig. 1

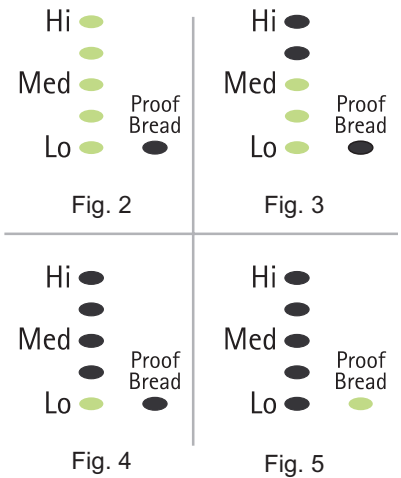

Fig. 2

Fig. 3

Fig. 4

Fig. 5

ENGLISH

Warmer Drawer Food Temperature Settings

Use the recommended Warmer Drawer food temperature settings table (See page 16, Fig. 3). If a particular food is not listed, start with the **Med** setting. If more crispness is desired, remove the lid or aluminum foil from the food. Most foods can be kept at serving temperatures on the **Med** setting. When a combination of foods are to be kept warm (for instance, a meat with 2 vegetables and rolls), use the **Hi** setting. To avoid heat loss, do not open the Warmer Drawer repeatedly while in use.

Preparing Bread Dough for the Warmer Drawer

The Warmer Drawer has a "Proof Bread" feature that can be used to help prepare bread dough. The recommended length of time to keep the bread dough in the Warmer Drawer is about 45-60 minutes. Be sure however to follow the recipe's recommended times.

The prepared bread dough should be placed in a large bowl because the dough will nearly double in volume. Arrange the Warmer Drawer Rack in the downward position (See Fig. 6). Place the bowl on the rack in the Warmer Drawer and follow the Warmer Drawer and Bread Proof Control setting instructions at the top of this page.

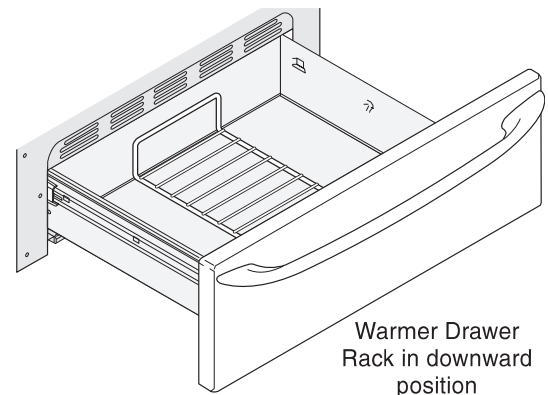

Fig. 6

Warmer Drawer Rack in downward position

Electronic Oven Control Pad Features

Air Guard™ & indicator light — Use after preheat to help freshen kitchen air during cooking.

COOK TIME— Use to enter the length of the baking time.

WARM & HOLD — Use to select the Warm & Hold feature.

SLOW COOK— Use to select the Slow Cook feature.

CONV CONVERT— Use to select the Convection Convert feature.

OVEN LIGHT— Use to turn the oven light ON and OFF.

TIMER ON/OFF— Use to set or cancel the Timer. The Timer does not start or stop the cooking process.

DELAY START— Use with **BAKE**, **COOK TIME**, and **CLEAN** to program a Delayed Cook Time or Delay Self-Cleaning cycle start time.

FLEX CLEAN— Use to select the Self-Cleaning feature.

START— Use to start all oven features (not used with Oven Light).

BAKE— Use to enter the normal Bake feature.

BROIL— Use to select variable Broil feature.

CONV ROAST— Use to select the Convection Roast for meats from a variety of food categories.

0 THRU 9 NUMBER PADS— Use to enter temperature and times.

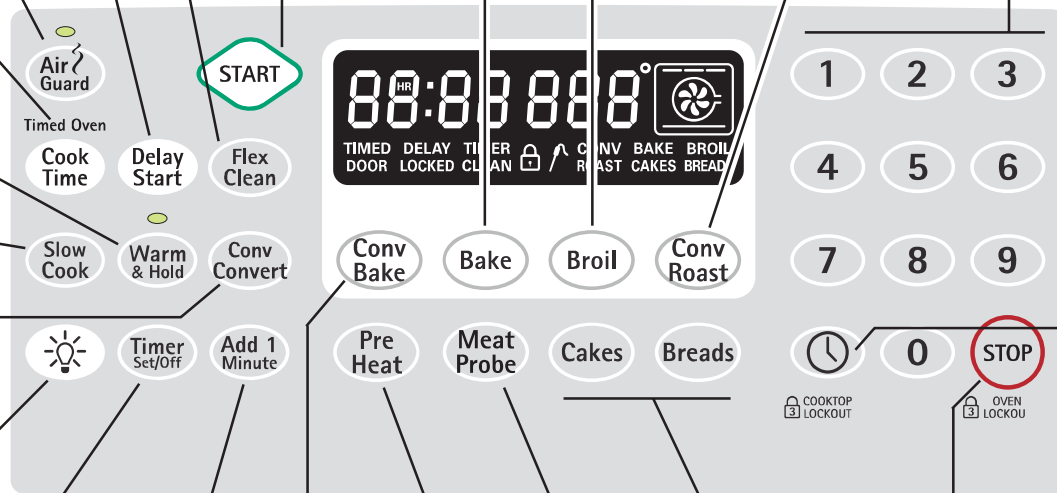

CLOCK— Use to set the time of day.

ADD 1 MINUTE— Use to select Add 1 Minute feature.

CONV BAKE— Use to select the Convection Bake feature.

PREHEAT— Use to pre-condition the oven temperature.

MEAT PROBE— Use to set meat probe.

CAKES or BREADS— Use to select the cakes or breads from a variety of food categories.

STOP— Use to cancel any oven mode previously entered except the time of day and minute timer. Press **STOP** to stop cooking. **STOP** also controls the Oven Lockout feature.

READ THE INSTRUCTIONS CAREFULLY BEFORE USING THE OVEN. For satisfactory use of your oven, become familiar with the various features and functions of the oven as described below. Detailed instructions for each feature and function follow later in this Use & Care Guide.

Minimum & Maximum Control Pad Settings

All of the features listed have minimum and maximum time or temperature settings that may be entered into the control. An ENTRY acceptance beep will sound each time a control pad is touched (the Oven Lockout pad is delayed by 3 seconds).

An ENTRY ERROR tone (3 short beeps) will sound if the entry of the temperature or time is below the minimum or above the maximum settings for the feature.

FEATURE		MIN. TEMP. /TIME	MAX. TEMP. /TIME
PREHEAT TEMP.		170°F / 77°C	550°F / 288°C
BAKE TEMP.		170°F / 77°C	550°F / 288°C
BROIL TEMP.		400°F / 205°C	550°F / 288°C
TIMER	12 Hr.	0:01 Min.	11:59 Hr./ Min.
	24 Hr.	0:01 Min.	11:59 Hr./ Min.
CLOCK TIME	12 Hr.	1:00 Hr./ Min.	12:59 Hr./ Min.
	24 Hr.	0:00 Hr./ Min.	23:59 Hr./ Min.
COOK TIME	12 Hr.	0:01 Min.	11:59 Hr./ Min.
	24 Hr.	0:01 Min.	23:59 Hr./ Min.
START TIME	12 Hr.	1:00 Hr./ Min.	12:59 Hr./ Min.
	24 Hr.	0:00 Hr./ Min.	23:59 Hr./ Min.
CLEAN TIME		2 hours	4 hours
CONV BAKE/ROAST		170°F / 77°C	550°F / 288°C

Setting Oven Controls





- Setting the Clock
- Changing between 12 or 24 hour display
- Silent Control Operation

Setting the Clock





The **CLOCK**  pad is used to set the clock. The clock may be set for 12 or 24 hour time of day operation. The clock has been preset at the factory for the 12 hour operation. When the range is first plugged in, or when the power supply to the range has been interrupted, the timer in the display will flash (See Fig. 1).

INSTRUCTIONS



To set the clock (example below for 1:30):

1. Press . "CLO" will appear in the display (See Fig. 2).
2. Press    pads to set the time of day to 1:30 (See Fig. 3). Press . "CLO" will disappear and the clock will start (See Fig. 4).

Changing between 12 or 24 hour time of day display:



1. Press and hold  for 6 seconds until "12h" or "24h" appears in the display.
2. Press  to switch between the 12 and 24 hour time of day display. "12h" or "24h" will be displayed (See Figs. 5 or 6).
3. Press  to accept the desired change or press  to reject the change.
4. Reset the correct time as described in **To set the clock** above. Please note that if the 24 hour time of day mode was chosen, the clock will now display time from 00:00 through 23:59 hours.

Setting Silent Control Operation



The **DELAY START**  and **FLEX CLEAN**  pads control the Silent Control operation feature. The Silent Control operation feature allows the oven control to be operated without sounds or beeps whenever necessary. If desired the control can be programmed for silent operation and later returned to operating with all the normal sounds and beeps.

INSTRUCTIONS

To change control from normal sound to silent control operation:

1. To tell if your range is set for normal or silent operation press and hold  for 7 seconds. (See Fig. 7)
2. Press  to switch between normal sound operation and silent operation mode. The display will show either "SP" (See Fig. 8) or " - - " (See Figs. 2 or 3).

If "SP" appears (See Fig. 2), the control will operate with normal sounds and beeps. If " - - " appears (See Fig. 9), the control is set for silent operation mode.

3. Press  to accept the change or press  to reject the change.

PRESS



PRESS



DISPLAY



Fig. 1



Fig. 2



Fig. 3



Fig. 4



Fig. 5



Fig. 6

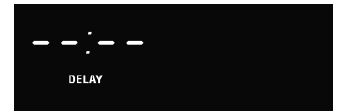

Fig. 7



Fig. 8





Fig. 9

ENGLISH

Setting Oven Controls





- Continuous Bake or Twelve Hour Energy Saving Mode
- Timer

Setting Continuous Bake or 12 Hour Energy Saving

The **TIMER**  and **FLEX CLEAN**  pads control the Continuous Bake or 12 Hour Energy Saving features. The oven control has a factory preset built-in 12 Hour Energy Saving feature that will shut off the oven if the oven control is left on for more than 11 hours and 59 minutes. The oven can be programmed to override this feature for Continuous Baking.

INSTRUCTIONS

To set the control for Continuous Bake or 12 Hour Energy Saving features:

1. Press and hold  for 6 seconds or until the control beeps once. (Fig.1). "12h" or "- - h" will appear in the display and the control will beep once.
2. Press  to switch between the 12 Hour Energy Saving and continuous bake features. Note: "12h" (See Fig. 2) in the display indicates the control is set for 12 Hour Energy Saving feature and "- - h" (See Fig. 3) indicates the control is set for the Continuous Bake feature.
3. Press  to accept the change (See Fig. 4) display will return to time of day) or press  to reject the change.

PRESS

DISPLAY

 for 6 seconds



Fig. 1





Fig. 2

 or 



Fig. 3







Fig. 4

Setting Timer

The **TIMER**  pad controls the Timer feature. The Timer serves as an extra reminder in the kitchen that will beep when the set time has run out. The Timer will not START or STOP the cooking process. The Timer feature may be used during any of the other oven control functions. Refer to "Minimum & Maximum Control Pad Settings" on page 18 for time amount settings.

INSTRUCTIONS

To set the Timer (example for 5 minutes):

1. Press . (See Fig. 5).
2. Press the number pads to set the desired time in the display (example ). Press . The timer will begin a count down. (See Fig. 6).
Note: If  is not pressed the timer will return to the time of day.
3. When the set time has run out, the clock will sound with 3 long beeps every 5 seconds until  is pressed (See Fig. 7).

PRESS

DISPLAY



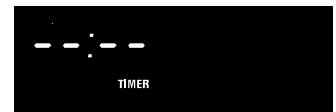

Fig. 5



Fig. 6





Fig. 7

To cancel the Timer before the set time has run out:

Press . The display will return to the time of day.



Setting Oven Controls

- Oven Lockout
- Setting Temperature Display

Setting Oven Lockout Feature OVEN LOCKOUT

The  pad controls the Oven Lockout feature. The Oven Lockout feature automatically locks the oven door, prevents the Warmer Drawer and most oven controls from being turned ON. It does not disable the clock, Timer or the interior oven light.

INSTRUCTIONS

To activate the Oven Lockout feature:

1. Press and hold  for 3 seconds.
2. After 3 seconds a beep will sound, **Loc** will appear and "DOOR LOCKED" will flash in the display. Once the oven door is locked the "DOOR LOCKED" indicator will stop flashing. (See Fig. 1)

To reactivate normal oven operation:

1. Press and hold  for 3 seconds. A beep will sound. **Loc** will clear. The "DOOR LOCKED" will continue to flash until the oven door has completely unlocked (See Fig. 2).
2. The oven is fully operational.

PRESS

 for 3 seconds

DISPLAY





Fig. 1

 for 3 seconds







Fig. 2

Setting Temperature Display — Fahrenheit or Celsius

The **BROIL**  and **FLEX CLEAN**  pads control the Fahrenheit or Celsius temperature display modes. The oven control can be programmed to display temperatures in Fahrenheit or Celsius. The oven has been preset at the factory to display in Fahrenheit.

INSTRUCTIONS

To change display from Fahrenheit to Celsius or Celsius to Fahrenheit:

1. To tell if the display is set for Fahrenheit (**F**) or Celsius (**C**) press  (See Fig. 3) and hold for 7 seconds; "550°" will first appear in the display and then a beep will sound. If "F" appears, the display is set to show temperatures in Fahrenheit (See Fig. 4). If "C" appears, the display is set to show temperatures in Celsius (See Fig. 5).
2. Press  to switch between Fahrenheit or Celsius display modes. The display will show either "F" (See Fig. 4) or "C" (See Fig. 5).
3. Press  to accept the change or press  to reject the change.

PRESS

 for 7 seconds

DISPLAY

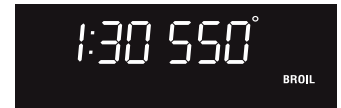

Fig. 3





Fig. 4

 or 



Fig. 5

Setting Oven Controls

- Saving & Recalling Recipe Settings

To Set the Recipe Recall Feature

The Recipe Recall feature may be used to record and recall your favorite recipe settings. This feature may store 1 setting for each of the 5 basic cooking pads. The key pads that a recipe may be stored with are **BAKE** (Bake), **CONV BAKE**

(Conv Bake), **CONV ROAST** (Conv Roast), **CAKES** (Cakes) & **BREADS** (Breads). This feature will also store and recall **Slow Cook**, **Cook Time** or **Warm & Hold** added setting. **Note:** Pressing the **START** pad after entering cooking temperatures and times will start the oven. If you wish to store the recipes but not start the oven press **STOP** after pressing the **START** pad. Once a recipe has been stored the recipe information will appear in the display when pressing the pad in the future.

To store a typical cookie recipe: (example for baking at 375°F for 9 minutes and to shut-off automatically):

INSTRUCTIONS

1. Arrange interior oven racks. If needed, **Preheat*** the oven to the desired set temperature. Place cookies on cookie sheet(s). Place cookie sheet on the oven racks in the oven.
2. Press **Bake** (See Fig. 1).
3. Press **3** **7** **5** (See Fig. 2).
4. Press **START** (See Fig. 2).
5. Press **Cook Time** (See Fig.3).
6. Enter the desired baking time. Press **9** (See Fig. 4).
7. Press **START** and hold for 3 seconds (See Fig. 5). This recipe is now stored with the **BAKE** key pad

When the Cook Time finishes:

1. "End" will display. The oven will shut-off automatically (See Fig. 7).
2. The control will beep 3 times. The control will continue to beep 3 times every 30 seconds until **STOP** is pressed.

The **Cook Time you enter does NOT include additional time required to **Preheat** the oven. The oven will begin to count down the cooking time as soon as the feature is activated.

To recall the cookie recipe stored under the **Bake** key

1. Press **Bake** (See Fig. 6). The stored recipe is recalled.
2. Press **START** (See Fig. 5).

To quickly erase all stored recipes:

1. Press and hold the **7** key pad until the first single beep sounds (6 seconds).
2. After the first beep press the **START** key pad once. Any stored recipes will be erased. Please Note: Clearing the recipes will also reset all other adjustments back to the factory settings. These include **12 or 24 Hour Time of Day display**, **Continuous Bake or 12 Hour Energy Savings mode**, **Silent Control Operation**, **Fahrenheit or Celsius Temperature Display** and any Oven Temperature adjustments that are set.

PRESS

DISPLAY

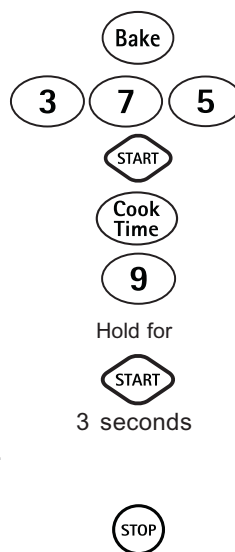

Fig. 1



Fig. 2



Fig. 3

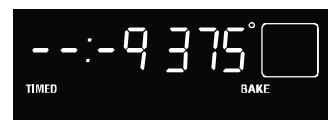

Fig. 4



Fig. 5



Fig. 6

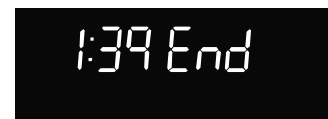



Fig. 7

Setting Oven Controls



- Preheat for Electric Ranges

Setting Preheat

For the best baking performance use the **PREHEAT**  feature. The Preheat feature will bring the oven up to the set baking temperature and then indicate when to place the food in the oven. Preheating is not necessary when roasting or cooking casseroles. The oven can be programmed to preheat at any temperature between 170°F to 550°F.

INSTRUCTIONS

To set the Preheat temperature for 350°F:







1. Arrange the interior oven racks.
2. Press . "350 F", the default oven set temperature, will appear in the display (See Fig. 1). (See **BAKE** instructions for changing oven set temperature.)
3. Press . "PRE" and "BAKE" will appear in the display as the oven heats and reaches 350°F (See Fig 2).

Note: After the oven has reached the desired temperature (this example, 350°F) the control will sound a long beep, the "PRE" light will turn off and oven set temperature will be displayed (Fig. 3). When PRE disappears from the display, the oven set temperature has been reached. Once the oven has preheated, **PLACE FOOD IN THE OVEN.**

Press  when baking is complete or to cancel the Preheat feature.

To change Preheat temperature while oven is preheating (example changing from 350 to 425°F):

If it is necessary to change the preheat temperature while the oven is preheating to the original set temperature:

1. While preheating, press  again. (See Fig. 3)
2. Enter the new preheat temperature. Press   . "425°" will appear in the display (See Fig. 4).
3. Press . "PRE" will appear in the display as the oven heats to 425°F (See Fig. 5). A long beep will sound once the oven set temperature reaches 425°F (See Fig. 6).
4. When baking is complete press .

PRESS



DISPLAY

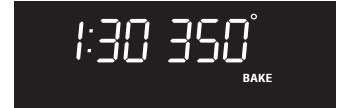

Fig. 1



Fig. 2

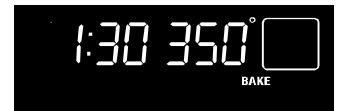

Fig. 3

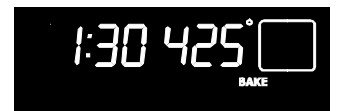

Fig. 4



Fig. 5

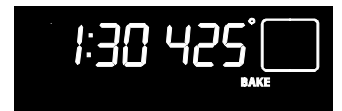

Fig. 6

ENGLISH

Setting Oven Controls

- Using Air Guard™
- Setting Bake

Some Important Things to Know Before Setting any Basic Oven Cooking Function:

This appliance has been factory pre-set to start any **BAKE, CONV BAKE, CONV ROAST, PREHEAT, CAKE** or **BREAD** function with the oven set temperature automatically set for 350°F. However if desired, the oven set temperature may be adjusted at any time during the cooking process. You may also choose to add a **COOK TIME** or **DELAY START** with any of the functions listed above.



Using the Air Guard™ feature (some models)

Your appliance is equipped with a catalytic oven exhaust cleaner that may be turned on during any active cooking process. This feature helps remove smoke and eliminates 85% of the odors generated when using your oven.

If you wish to have AirGuard™ clean the oven exhaust once cooking has started, press .



Note: The **Air Guard™** indicator light will glow anytime the Air Guard™ is active. Air Guard™ will turn on and cannot be manually turned off during the Self-cleaning cycle.

Setting Bake

The **BAKE**  pad controls normal baking. If preheating is necessary, refer to the **PREHEAT**  feature for instructions. The oven can be programmed to bake at any temperature from 170°F to 550°F (The sample shown below is for 350°F).

INSTRUCTIONS

To set the Bake Temperature to 350°F:

1. Arrange interior oven racks and place food in oven.
2. Press , 350° will automatically appear in the display (See Fig. 1).
3. Press . A long beep will sound once the oven set temperature reaches 350° F (See Fig. 2).

Note: Pressing  will cancel the Bake feature at any time.

PRESS



DISPLAY

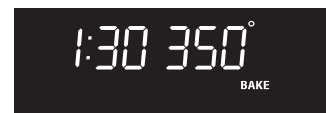

Fig. 1

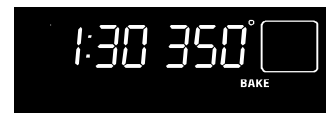



Fig. 2

To change the Bake Temperature (example changing from 350° to 425°F):

1. After the oven has already been set to bake at 350°F and the oven set temperature needs to be changed to 425°F, press

 (See Fig. 2).

2. Press   . 425° will appear in the display.

3. Press  (See Fig. 3).

4. The oven is now set for 425°F.

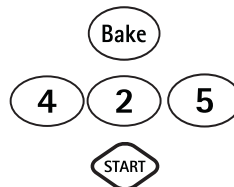



Fig. 3

Setting Oven Controls

- Setting Cook Time

Setting Cook Time

The **BAKE**  and **COOK TIME**  pads control the **Cook Time** feature. The automatic timer of the **Cook Time** feature will turn the oven OFF after cooking for the desired amount of time you select.

INSTRUCTIONS



To program the oven to begin baking immediately and to shut off automatically: (example below to bake at 350°F for 50 minutes):

1. Arrange interior oven rack(s) and place the food in the oven.

2. Press  (See Fig.1).

3. Press  (See Fig. 2).

4. Press  (See Fig.3).

5. Enter the desired baking time by pressing  .

Note: Baking time can be set for any amount of time between 1 minute to 11 hours and 59 minutes. (See Fig. 4)

6. Press . (See Fig. 5)

Note: After the **Cook Time** feature has activated, press  to display the bake time remaining in the **Cook Time** mode. Once **Cook Time** has started baking, a long beep will sound when the oven temperature reaches the set temperature.

Press  when baking has finished or at any time to cancel the **Cook Time** feature.

When the Cook Time finishes:

1. "End" and the time of day will show in the display. The oven will shut off automatically (See Fig. 6).
2. The control will beep 3 times. The control will continue to beep 3 times every 30 seconds until  is pressed.

PRESS



DISPLAY

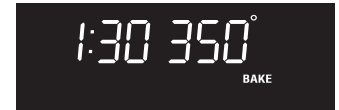

Fig. 1

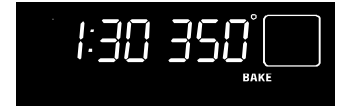

Fig. 2

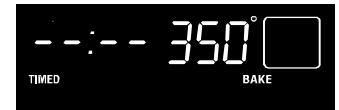

Fig. 3

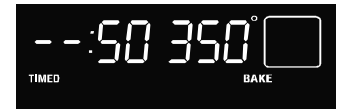

Fig. 4

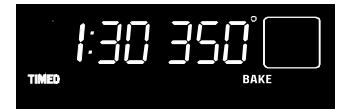

Fig. 5

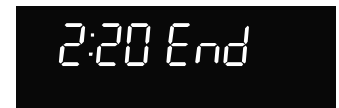

Fig. 6

ENGLISH

CAUTION Use caution with the **Cook Time** or **Delay Start** functions. Use the **Cook Time** function when cooking cured or frozen meats and most fruits and vegetables. Foods that can easily spoil such as milk, eggs, fish, meat or poultry, should be chilled in the refrigerator first. Even when chilled, they should not stand in the oven for more than 1 hour before cooking begins, and should be removed PROMPTLY when cooking is complete. Eating spoiled food can result in sickness from food poisoning.

Setting Oven Controls

- Setting Delay Start

Setting Delay Start

The **BAKE** (BAKE), **OVEN COOK TIME** (Cook Time) and **DELAY START** (Delay Start) pads control the **Delay Start** feature. The automatic timer of the **DELAY START** feature will turn the oven ON and OFF at the times you select.

INSTRUCTIONS

To program the oven for a Delay Start and to shut off automatically (example for baking at 375°F for 50 minutes and starting at 5:30):

1. Be sure that the clock is set with the correct time of day.
2. Arrange interior oven rack(s) and place the food in the oven.
3. Press (Cook Time) (See Fig. 1)
4. Enter the desired baking time using the number key pads by pressing (5) (0) (See Fig. 2). Note: Baking time may be set for any amount of time from 1 minute to 11 hours and 59 minutes.
5. Press (START) (See Fig. 3).
6. Press (Delay Start) (See Fig. 4).
7. Enter the desired start time using the number pads (5) (3) (0). (See Fig. 5)
8. Press (START) (See Fig. 6)
9. Press (Bake) (See Fig. 7)
10. Press (3) (7) (5) .
11. Press (START) (See Fig. 8)

Note: Once **Delay Start** has started, press (Cook Time) to display the bake time remaining. Once the **Delay Start** has started baking, a long beep will sound when the oven temperature reaches the set temperature.

Press (STOP) when baking has finished or at any time to cancel the **Delay Start** feature.

When the set bake time runs out:

1. "End" will show in the display. The oven will shut off automatically (See Fig. 9).
2. The control will beep 3 times. The control will continue to beep 3 times every 30 seconds until (STOP) is pressed.

PRESS

DISPLAY



Fig. 1



Fig. 2



Fig. 3



Fig. 4

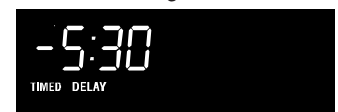

Fig. 5



Fig. 6



Fig. 7

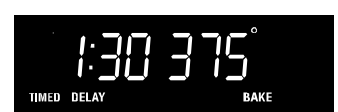

Fig. 8



Fig. 9

NOTE: If your clock is set for normal 12 hour display mode the **Delay Start** feature can never be set to start more than 12 hours in advance. To set the **Delay Start** 12-24 hours in advance see page 19 for instructions to set the control for the 24 hour time of day display mode.

Setting Oven Controls

- Setting Broil (Electric Range)

The **Broil** pad controls the Broil feature. When broiling, heat radiates downward from the oven broiler for even coverage. The Broil feature is preset to start broiling at 550°F, however, the Broil feature temperature may be set at any temperature between 400°F and 550°F.

The broil pan and broil pan insert used together allows dripping grease to drain and be kept away from the high heat of the oven broiler. **DO NOT** use the broil pan without the insert (See Fig. 6). **DO NOT cover the oven racks with aluminum foil.** The exposed grease could catch fire.

⚠ WARNING Should an oven fire occur, leave the oven door closed and turn the oven OFF. If the fire continues, throw baking soda on the fire or use a fire extinguisher. **DO NOT** put water or flour on the fire. Flour may be explosive and water can cause a grease fire to spread and cause personal injury.

INSTRUCTIONS

To set the oven to broil at the default setting (550°F):

- Place the broiler pan insert on the broiler pan. Then place the food on the broiler pan insert. **DO NOT** use the broiler pan without the insert.
- Arrange the interior oven rack and place the broiler pan on the rack. Be sure to center the broiler pan directly under the broiler element. **Make sure the oven door is in the broil stop position** (See Fig. 5). Preheat the oven for 4 minutes.
- Press **Broil**. (See Fig. 1).
- If a lower broil temperature is desired (minimum broil temperature setting is 400°F), press the desired temperature before continuing to step 5.
- Press **START**. The oven will begin to broil. "**BROIL**" and "**550°**" will appear in the display (See Fig. 2).
- Broil on one side until food is browned; turn and cook on the second side. Season and serve. **Note:** Always pull the rack out to the stop position before turning or removing food.
- To cancel broiling or if finished broiling press **STOP** (See Fig. 3).

Recommended Broiling Times and Searing Grill

Use the following table for approximate broiling times. Increase or decrease broiling times, or move the broiling pan to a different rack position to suit for doneness. If the food you are broiling is not listed in the table, follow the instructions provided in your cookbook and watch the item closely. Use the Searing Grill for meats and steaks if desired. Before placing the meat, be sure to heat the Searing Grill using Broil for 10 minutes. Cook times should be reduced 1-2 minutes per side when cooking with the Searing Grill. Place Searing Grill on top of Broiler Pan and insert for meats and steaks (Fig. 7).

Broiling Table (Refer to Fig. 4)

Food Item	Rack Position	Temp Setting	Cook Time		Doneness
			1st side	2nd side	
Steak 1" thick	5th or 6th	550° F	6:00	4:00	Medium
	5th or 6th	550° F	7:00	5:00	Medium-well
Pork Chops 3/4" thick	5th	550° F	8:00	6:00	Well
Chicken - Bone In	4th	450° F	20:00	10:00	Well
Chicken - Boneless	5th	450° F	8:00	6:00	Well
Fish	5th	500° F	13:00	n/a	Well
Shrimp	4th	550° F	5:00	n/a	Well
Hamburger 1" thick	6th	550° F	9:00	7:00	Medium
	5th	550° F	10:00	8:00	Well

PRESS

DISPLAY



Fig. 1



Fig. 2



Fig. 3



Fig. 4

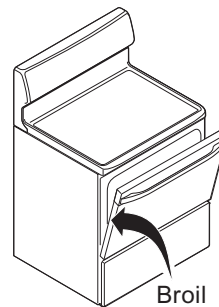

Fig. 5 Broil Stop Position

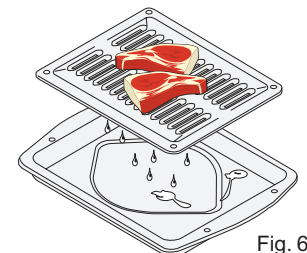

Fig. 6

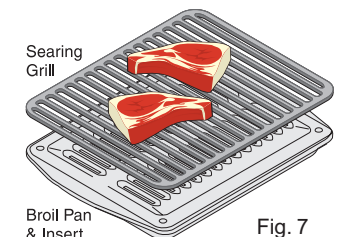

Fig. 7

Setting Oven Controls

- Setting Convection Roast
- Setting Cakes or Breads

Benefits of Convection Roast:

- Some foods cook up to 25 to 30% faster, saving time and energy.
- Multiple oven rack baking.
- No special pans or bakeware needed.

Setting the Food Categories Features

The **CONV ROAST** , **CAKES**  and **BREADS**  pads may be used when cooking certain food items. These pads have been designed to give optimum cook performance for the foods selected in each category.



The **CONV ROAST** pad combines a cook cycle with the convection fan and element to roast meats and poultry. Preheating is not necessary for meats and poultry. Heated air circulates around the food from all sides, sealing in juices and flavors. Foods are crispy brown on the outside while staying moist on the inside.

The **CAKES** pad provides a preheat with a gentle cycling of heat giving cakes more volume and allowing delicate foods to cook more evenly.

The **BREADS** pad adds a preheat feature to the bake cycle to thoroughly heat the oven from top to bottom to give more evenly browned foods. Refer to Fig. 3 for foods to cook in each category.

INSTRUCTIONS

To set the Food Convection Roast feature (example for meats to cook at 350°F):

1. Arrange interior oven racks and place food in oven.
2. Press . (See Fig. 1).
3. Press . (See Fig. 2). The convection fan icon will come on.

Press  to stop Convection Roast at any time.

Note: The **Cakes** or **Breads** features may be programmed like the example provided above. It is recommended to follow the recipe instructions with the food items package. The convection fan will not turn on with the **Cakes** or **Breads** key pad

PRESS



DISPLAY



Fig. 1



Fig. 2

Recommended foods to be cooked in each category	CONV ROAST	CAKES	BREADS
Fig. 3	Meat Poultry	Cakes Brownies Pies (fresh & frozen) Baked Custards Cheesecake	Breads Rolls Biscuits Muffins Cornbread

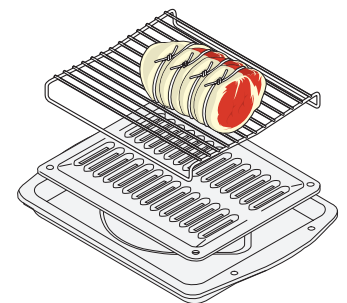

Fig. 4

Roasting Rack Instructions

When preparing meats for convection roasting, use the broiler pan and insert along with the roasting rack. The broiler pan will catch grease spills and the insert will help prevent grease splatters. The roasting rack will allow the heat to circulate around the around the meat.

WARNING To prevent food from contacting the broil element and to prevent grease splattering, **DO NOT** use the roasting rack when broiling.

1. Place oven rack on bottom or next to the bottom rack position. See Arranging Oven Racks in the **Before Setting Oven** heated air to circulate under the food for even cooking and helps to increase browning on the underside. Make sure the roasting rack is securely seated on the insert in the broiler pan. **DO NOT** use the broiler pan without the insert. **DO NOT** cover the insert with aluminum foil.
3. Position food (fat side up) on the roasting rack (See Fig. 4).
4. Place the broiler pan on the oven rack.

Setting Oven Controls

- Using the Meat Probe

Using and Setting Meat Probe

Checking the internal temperature of your food is the most effective way of insuring that your food has been properly cooked. When cooking meat such as roasts, hams or poultry you can use the meat probe to check the internal temperature without any guesswork. For some foods, especially poultry and roasts, testing the internal temperature is the best method to insure properly cooked meats.

Important things to consider:

- Use only the probe supplied with your appliance; any other may result in damage to the probe or the appliance.
- Handle the probe carefully when inserting and removing from the food or the receptacle.
- Do not use tongs to pull the cable when inserting or removing from the food or the receptacle.
- Defrost your food completely before inserting the probe to avoid damaging probe.
- Never leave or store the probe inside the oven when not in use.
- To prevent the possibility of burns, after cooking carefully unplug the probe using a pot holder.

Proper Meat Probe placement

- Always insert the probe so that the tip rests in the center of the thickest part of the meat. Do not allow the probe to touch bone, fat, gristle or the pan.
- For bone-in ham or lamb, insert the probe into the center of the lowest large muscle or joint . For dishes such as meat loaf or casseroles, insert the probe into the center of the food. To find the center of the food visually measure with the probe (See Fig. 1). When cooking fish, insert the probe just above the gill.
- For whole poultry or turkey, insert the probe into the thickest part of the inner thigh, below the leg (See Fig. 2).

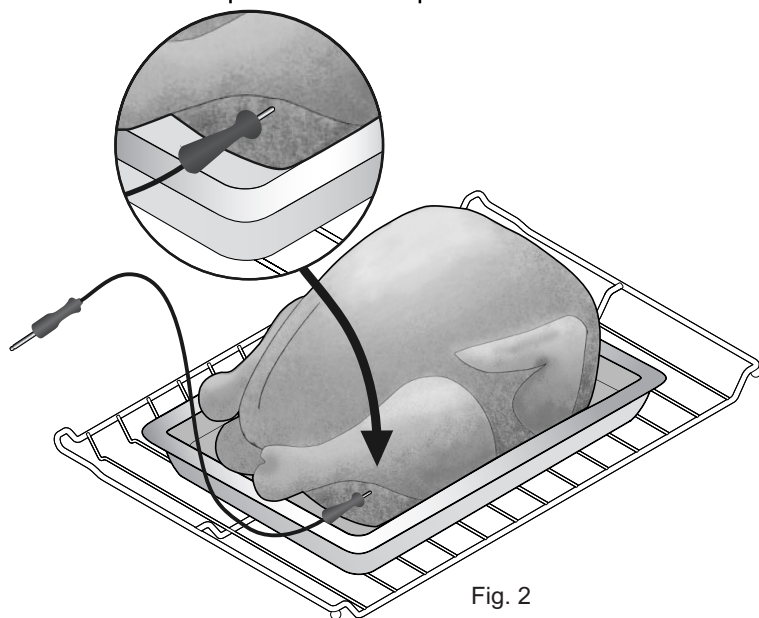
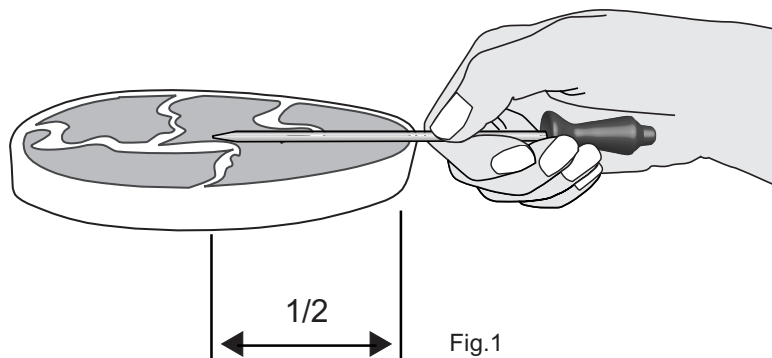

Setting Oven Controls

- Using the Meat Probe

Using and Setting the Meat Probe (cont'd)

To use the Meat Probe:









1. Prepare the food and properly insert the temperature probe into the food. **DO NOT PREHEAT** or start cooking **before** properly inserting the meat probe. The probe should be inserted into the food and receptacle while the oven is still cool.
2. Place the prepared food on the desired oven rack position and slide into the oven.
3. Plug the meat probe into the probe receptacle located on the left front oven cavity side (See Fig. 1 for location of probe receptacle).
4. Close the oven door.
5. The oven control will detect if the meat probe is correctly plugged in and will illuminate with  icon in the display.
6. The actual meat probe temperature will appear in the display.
7. To set the target temperature press  pad once then enter the desired target internal temperature using the numeric key pads (default setting is 170°F/77°C)†. Press  to accept the meat probe target temperature.
8. Set the oven control for , , or  and the desired oven temperature. You may use the meat probe with some other baking features but cannot be set with **Broil** or **Flex-Clean**.
9. During the cooking process you may check the actual internal temperature by pressing the  key once. The actual temperature will display. After 8 seconds the display will return to the actual oven temperature.
10. If the target temperature needs to be changed during the cooking process, press the  twice and use the numeric keypads to adjust the target temperature. Press the  key to accept the change.



Fig.1





† The U.S. Department of Agriculture states, "Rare fresh beef is popular, but you should know that cooking it to only 140°F/60°C means some food poisoning organisms may survive." (Source: Safe Food Book, Your Kitchen Guide, USDA Rev. June 1985.)

The lowest temperature recommended by the USDA is 145°F/63°C for medium rare fresh beef.

Setting the oven to automatically stop cooking after reaching meat probe target temperature:

The oven leaves the factory preset to alert you when the internal target temperature has been reached but to continue cooking at the oven set temperature. You may desire to change how your oven reacts when using the meat probe.

Note: Changing how the meat probe reacts must be done before starting the cooking process:

1. To set the oven to shut-off automatically after reaching the Meat Probe target temperature press  and hold for 7 seconds then use the  key to toggle to the message **P CC** (Probe, cancel cooking) then press  to accept.
2. Use the  key to toggle back to **PnCC** (Probe, no cancel cooking) and then press  to accept if you wish for the oven to continue cooking after the meat probe reaches the target temperature.

Setting Oven Controls

- Setting Convection Bake

Benefits of Convection Bake:

- Multiple oven rack baking.
- No special pans or bakeware needed.

Setting Convection Bake

The **CONV BAKE**  pad controls the **Convection Bake** feature.

Use the **Convection Bake** feature when cooking speed is desired. The oven can be programmed for **Convection Bake** at any temperature between 170° F (77° C) to 550° F (288° C).



Convection baking uses a fan to circulate the oven's heat evenly and continuously within the oven (See Fig. 1). This improved heat distribution allows for even cooking and excellent results using multiple racks at the same time. Foods cooked on a single oven rack will generally cook faster and more evenly with **Convection Bake**. Multiple oven rack cooking may slightly increase cook times for some foods, but the overall result is time saved. **Breads** and pastries brown more evenly.

Tips for Convection Bake

1. Time reductions will vary depending on the amount and type of food to be cooked. Cookies and biscuits should be baked on pans with no sides or very low sides to allow heated air to circulate around the food. Food baked on pans with a dark finish will cook faster.
2. Preheating is not necessary when cooking casseroles with **Convection Bake**.
3. When using **Convection Bake** with a single rack, place oven rack in position 3 or 4. If cooking on multiple racks, place the oven racks in positions 2 and 5 (for 2 racks). Place in positions 1, 3 and 6 (for 3 racks). Refer to Fig. 1.
4. **Cakes** will have better results when baked using the  keypad.

INSTRUCTIONS

To set the oven for Convection Bake and temperature to 350°F:

1. Arrange interior oven racks and place food in oven (See Fig. 1).
2. Press . (See Fig. 2).
3. Press .

Note: The oven icon will show a rotating fan within the square. This rotating fan icon indicates when the Convection Fan is operating (See fan icon shown in Fig. 3).

Press  to stop **Convection Bake** or cancel **Convection Bake** at any time.

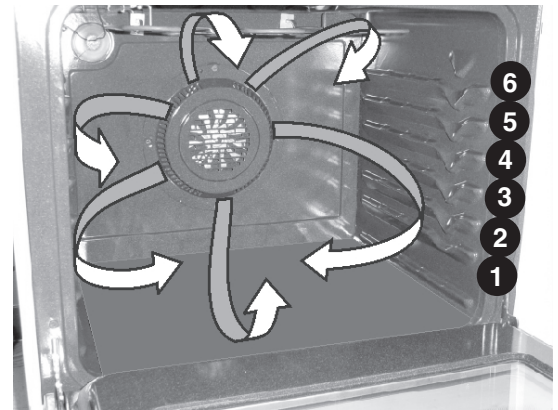

Air circulation of Convection Cooking

Fig. 1

ENGLISH

PRESS

DISPLAY



Fig. 2



Fig. 3



Setting Oven Controls

- Setting Convection Convert Feature
- Setting Add 1 Minute Feature



To set the Convection Convert feature

The  **CONV CONVERT** pad is used to automatically convert a standard **Baking** recipe for convection baking. When set properly, this feature is designed to display the oven set converted (reduced) temperature in the display.

Convection Convert **MUST** be used with a **Convection Bake** keypad. Cook Time or Delay Start functions may be added.

INSTRUCTIONS

Using Convection Convert feature to adjust oven temperature from a Bake recipe (example below when setting oven for 350°F):

1. Arrange interior oven racks and place food in oven.
2. Press , (See Fig. 1). If a **Cook Time** or a **Delay Start** is desired, enter the times now.
3. Press . "**CONV BAKE**" and the oven set temperature **adjustment** will appear in the display (for this example it is 325°F). A beep will sound once the **adjusted** oven set temperature is reached. (See Fig. 2).

Notes: When used with a **Cook Time** or a **Delay Start** setting, the **Convection Convert** feature will display a "**CF**" for check food when the bake time is 75% complete (See Fig. 3). At this time the oven control will sound 3 long beeps at regular intervals until baking has finished. When the bake time has completely finished the control will display "**End**" and will sound 3 long beeps every 30 seconds until the  pad is pressed (See Fig. 4).

The oven icon will show a rotating fan within the square. This rotating fan icon indicates when the Convection Fan is operating (See Figs 2 or 3)

Press  to cancel Convection feature at any time.

Note: The minimum amount of cook time using the Convection Convert feature with a **Cook Time** or a **Delay Start** function is 20 minutes.

PRESS

DISPLAY



Fig. 1



Fig. 2







Fig. 3



Fig. 4



To Set Add 1 Minute Feature

The  keypad is used to set additional minutes to the Timer. Each time the  pad is pressed, another minute is added. If the Timer is not active and the  key pad is pressed, the Timer feature will become active and will begin counting down from 1 minute. When the Timer reaches the end of the set time, "**End**" will display and signal 3 long beeps at regular intervals until  is pressed again.

Setting Oven Controls

- Setting the Slow Cook Feature
- Oven Light

Setting the Slow Cook Feature

The  **SLOW COOK** pad is used to activate this feature. The **Slow Cook** feature may be used to cook foods more slowly, at lower oven temperatures and provides cooking results much the same way as a Slow Cooker or Crock-Pot. The **Slow Cook** feature is ideal for roasting beef, pork & poultry. Slow Cooking meats may result in the exterior of meats becoming dark but not burnt. This is normal.

There are 2 settings available, high (**Hi**) or low (**Lo**). The low setting is best for cooking foods from a 8 to 9 hour time period. The high setting is best for cooking foods from a 4 to 5 hour time period. The maximum cook time for the **Slow Cook** feature is 12 hours unless the oven control has been changed to the **Continuous Bake** mode. This feature may be used with the additional settings of a **Cook Time** or a **Delay Start**.

Some tips you should review for best possible results using Slow Cook feature:

- Completely thaw all frozen foods before cooking with the **Slow Cook**.
- When using a single rack, place in position 2 or 3.
- Position multiple racks to accommodate size of cooking utensils when cooking multiple food item.
- Do not open the oven door often or leave the door open when checking foods. If the oven heat escapes often, the **Slow Cook** time may need to extended.
- Cover the foods to keep them moist or use a loose or vented type cover to allow foods to turn crisp or brown.
- Roasts may be left uncovered so browning can occur. Cook times will vary; depending on the weight, fat content, bone & the shape of the roast.
- Use the recipe's recommended food temperature and a food thermometer to determine when the food is done.
- Preheating the oven will not be necessary when using the **Slow Cook** feature.
- Add any cream or cheese sauces during the last hour of cooking.

See the suggested **Slow Cook** feature recipes provided in the back of this Use & Care Guide.

INSTRUCTIONS

PRESS

DISPLAY

To Program the Oven to begin baking with the **Slow Cook** feature (example below shows clock at 1:30):





1. Place the food in the oven.
2. Press . “SLO” and “Hi” (See Fig. 1) will appear in the display (If no further keypads are touched within 25 seconds the request for **Slow Cook** will clear).
3. If a **Lo** setting is desired, press the  a 2nd time to set the **Slow Cook** feature with a low setting. “SLO” and “Lo” will appear in the display (See Fig. 2).
4. Press . The **Slow Cook** feature will activate (See Fig. 3).
5. If desired, add any **Cook Time** or **Delay Start** settings at this time.
6. To cancel the **Slow Cook** feature press  at anytime.



Fig. 1

optional 



Fig. 2



Fig. 3

Setting Oven Controls

- Setting the Sabbath Day Feature



To Set the Sabbath Feature (for use on the Jewish Sabbath & Holidays)

The **OVEN COOK TIME** and **DELAY START** pads are used to set the Sabbath feature. The Sabbath feature

may only be used with the pad. The oven temperature may be set higher or lower after setting the Sabbath feature (the oven temperature adjustment feature should be used only during Jewish Holidays), however the display will not visibly show and no audible tones will be provided when a change occurs. Once the oven is properly set using **Bake** with the Sabbath feature active, the oven will remain continuously ON until cancelled. This will override the factory preset 12-Hour

Energy Saving feature. If the oven light is needed during the Sabbath, press before activating the Sabbath feature.

Once the oven light is turned ON and the Sabbath feature is active, the oven light will remain ON until the Sabbath feature is turned OFF. If the oven light needs to be OFF, be sure to turn the oven light OFF before activating the Sabbath feature.

IMPORTANT NOTES: It is not advised to attempt to activate any other program feature except **BAKE** while the Sabbath feature is active. ONLY the following key pads will function correctly with the Sabbath feature: **0-9 number pads**,

& . **ALL OTHER KEYPADS** should not be used once the Sabbath feature is activated.

INSTRUCTIONS

PRESS

DISPLAY

To Program the Oven for 350°F, Begin Baking Immediately and activate the Sabbath feature:

1. Be sure that the clock is set with the correct time of day.
2. Arrange the oven racks and place the food in the oven.
3. Press , "350°F" will appear in the display (See Fig. 1).
4. Press . The oven will turn ON and begin heating (See Fig. 2).
5. If a **Cook Time** or **Delay Start** is needed then enter the time in this step. If not, skip this step and continue to step 6. Refer to the **Cook Time** or **Delay Start** instructions on pages 25-26. Remember the oven will shut down after completing a **Cook Time** or **Delay Start** and therefore may only be used once during the Sabbath/Jewish Holidays. The maximum **Delay Start** time is 11 hours & 59 minutes.
6. At the same time press and hold both the and pads for at least 3 seconds. The control will beep and **SAb** will appear in the display (See Fig. 3). Once **SAb** appears in the display the oven control will no longer beep or display any

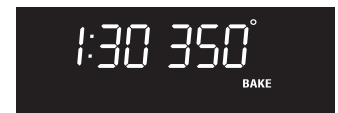

Fig. 1

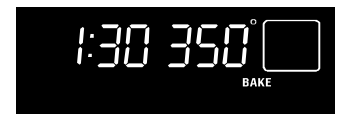

Fig. 2

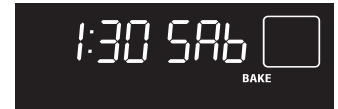

Fig. 3

further changes and the oven is properly set for the Sabbath feature.



Note: You may change the oven temperature once baking has started. Press , enter the oven temperature change (170 to 550F°) and press (for Jewish Holidays only). Remember that **the oven control will no longer beep or display any further changes** once the oven is set for the Sabbath feature.

7. The oven may be turned OFF at any time by pressing pad (this will turn the oven OFF only). To turn OFF the Sabbath feature press and hold at the same time both the and pads for at least 3 seconds. **SAb** will disappear from the display.

Setting Oven Controls

- Setting the Sabbath Day Feature (cont'd)
- Setting the Warm & Hold™ Feature

It is recommended that any oven temperature change with the Sabbath feature activated be followed with 2 presses of the **START** pad. This will insure the oven remains ON even if the attempt to set the oven temperature was lower or higher than the oven control can accept. If the oven temperature is set incorrectly, the oven temperature will default to 170°F or 550°F. Try to set the desired oven temperature again.

Should you experience a power failure or interruption, the oven will shut off. When power is returned the oven will not turn back on automatically. The oven will remember that it is set for the Sabbath and the food may be safely removed from the oven while still in the Sabbath feature, however the oven cannot be turned back on until after the Sabbath/Holidays. After the Sabbath observance turn OFF the Sabbath feature. At the same time press and hold both the  and  pads for at least 3 seconds. **SAb** will disappear from the display and the oven may be used with all normal functions. For further assistance, guidelines for proper usage, and a complete list of models with the Sabbath feature, please visit the web at <http://www.star-k.org>.



Setting the Warm & Hold™ Feature

The  pad turns ON the **Warm & Hold** feature and will maintain an oven temperature of 170° F. The **Warm & Hold** feature will keep oven baked foods warm for serving up to 3 hours after cooking has finished. After 3 hours the **Warm & Hold** feature will shut the oven OFF automatically. The **Warm & Hold** feature may be used without any other cooking operations or may be used after cooking has finished using **Cook Time** or **Delay Start**.

INSTRUCTIONS



PRESS

To set Warm & Hold:

1. Arrange interior oven racks and place baked food in oven. If the food is already in the oven go to step 2.
2. Press . The **Warm & Hold** indicator light will flash.
Note: If no further pads are touched within 25 seconds the request to turn ON **Warm & Hold** will be cleared.
3. Press . The **Warm & Hold** indicator light will glow steady indicating **Warm & Hold** is ON.
4. To turn the **Warm & Hold** OFF at any time press . The **Warm & Hold** indicator light will turn OFF. Note: The **Warm & Hold** feature will automatically turn OFF after 3 hours.



To set Warm & Hold to turn ON automatically:

1. Arrange interior oven racks and place food in oven. Set the oven properly for **Cook Time** or **Delay Start**.
2. Press . The **Warm & Hold** indicator light will flash.
Note: If no further pads are touched within 25 seconds the request to turn ON **Warm & Hold** will be cleared.
3. Press . The **Warm & Hold** indicator light will glow steady indicating **Warm & Hold** is set to turn ON automatically after **Cook Time** or **Delay Start** has finished.
4. To turn the **Warm & Hold** OFF at any time press . The **Warm & Hold** indicator light will turn OFF. Note: The **Warm & Hold** feature will automatically turn OFF after 3 hours.



Pressing  at any time will stop all oven baking operations.



Warmer Drawer Removal

- Removing & Replacing Warmer Drawer

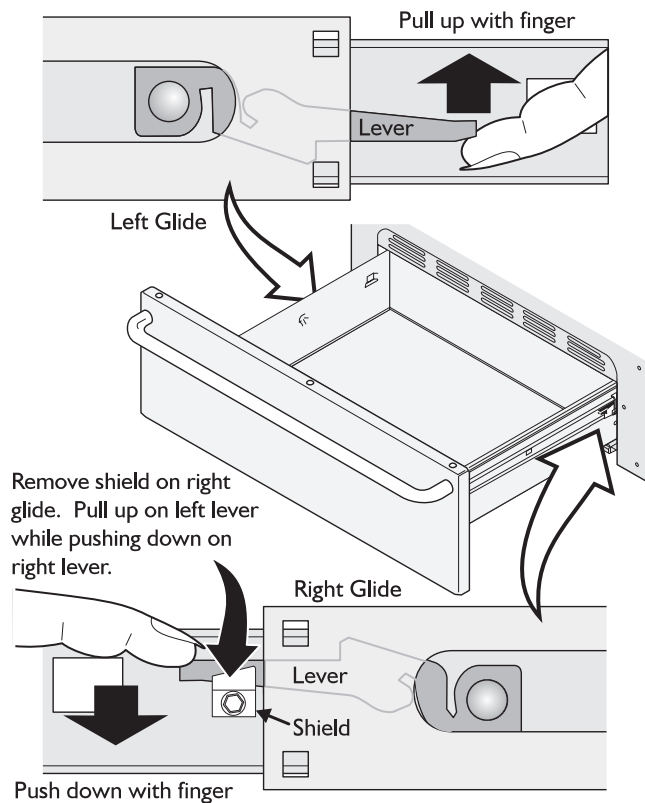

Fig. 1

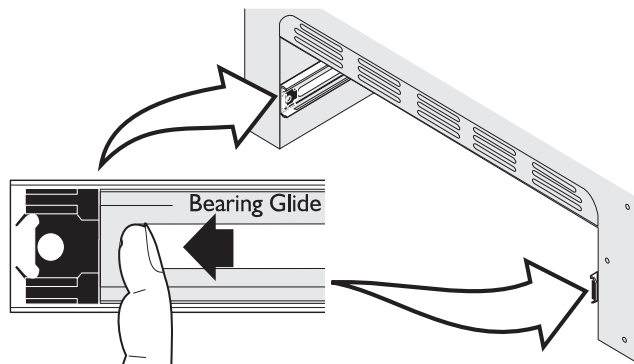

Fig. 2

To Remove and Replace Warmer (Warm & Ready™) Drawer



⚠ WARNING Electrical Shock Hazard can occur and result in serious injury or death. Disconnect appliance from electric power before cleaning and servicing the warmer drawer.

To Remove Warmer Drawer:

1. **⚠ CAUTION** Turn power **OFF** before removing the warmer drawer.
2. Open the drawer to the fully opened position.
3. On the right glide you will find a shield attached with a hex-head screw (See Fig. 1). Use a 1/4" socket and ratchet to remove the shield.
4. Locate glide lever on each side of drawer, pull up on the left glide lever and push down on the right glide lever.
5. Pull the drawer away from the range.

To Replace Warmer Drawer:

1. Replace shield on the right glide of the drawer body.
2. **Pull the bearing glides to the front** of the chassis glide (See Fig. 2).
3. Align the glide on each side of the drawer with the glide slots on the range.
4. Push the drawer into the range until levers "click" (approximately 2"). Pull the drawer open again to seat bearing glides into position. **If you do not hear the levers "click" or the bearing glides do not feel seated remove the drawer and repeat steps 2-4.** This will minimize possible damage to the bearing glides.

NOTE: The Warmer Drawer will **NOT** operate while in the Self-Clean and "Oven Lockout" modes

Self-Cleaning

- Preparing for a Self-Clean cycle

CAUTION During the Self-Cleaning cycle, the outside of the range can become very hot to the touch. **DO NOT** leave small children unattended near the appliance.

CAUTION The health of some birds is extremely sensitive to the fumes given off during the Self-Cleaning cycle of any range. Move birds to another well-ventilated room.

CAUTION DO NOT line the oven walls, racks, bottom or any other part of the range with **aluminum foil**. Doing so will destroy heat distribution, produce poor baking results and cause permanent damage to the oven interior (aluminum foil will melt to the interior surface of the oven).

CAUTION DO NOT force the oven door open. This can damage the automatic door locking system. Use caution when opening the door after the Self-Cleaning cycle is completed. The oven may still be **VERY HOT**.

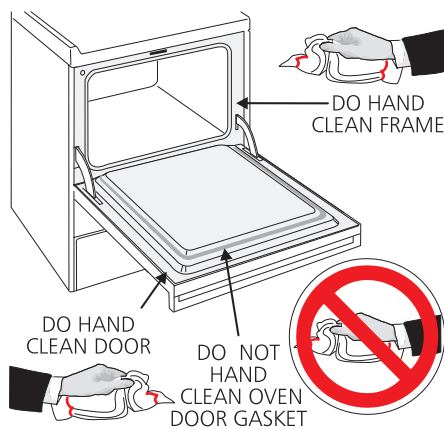

Note: See additional cleaning information for the oven door in the **General Care & Cleaning** section.

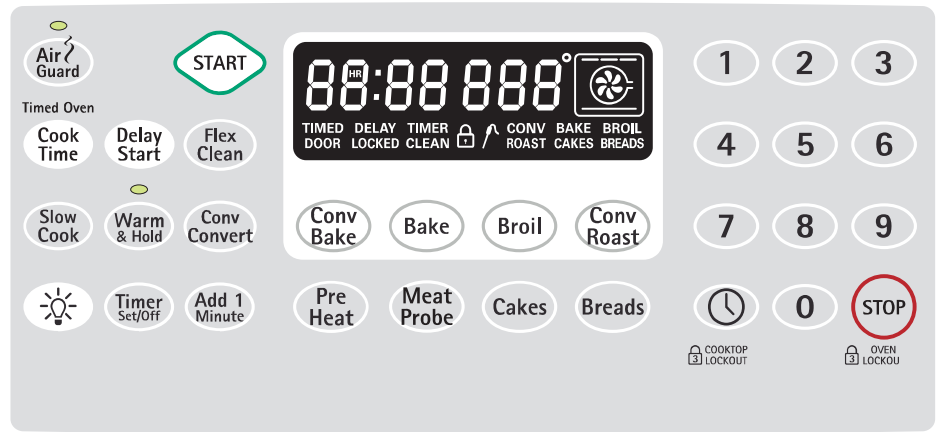

Self-Cleaning Oven

A Self-Cleaning oven cleans itself with high temperatures (well above cooking temperatures) which eliminate soils completely or reduces them to a fine powdered ash you can wipe away with a damp cloth.





Adhere to the following cleaning precautions:

- **DO NOT** use oven cleaners or oven protective coatings in or around any part of the Self-Cleaning oven.
- **DO NOT** clean the oven door gasket. The woven material of the oven door gasket is essential for a good seal. Care should be taken not to rub, damage or remove the gasket.
- **DO NOT** use any cleaning materials on the oven door gasket. Doing so could cause damage.
- **Remove the broiler pan and insert, all utensils and any aluminum foil. These items cannot withstand high cleaning temperatures.**
- Porcelain Oven racks do not have to be removed. After the cycle is complete and the oven has cooled, rub the sides of the oven racks with wax paper or a cloth containing a small amount of vegetable oil (this will make the racks glide easier into the rack position).
- **Remove any excessive spillovers** in the oven cavity **before** starting the Self-Cleaning cycle. To clean, use hot, soapy water and a cloth. Large spillovers can cause heavy smoke or fire when subjected to high temperatures. **DO NOT** allow food spills with a high sugar or acid content (such as milk, tomatoes, sauerkraut, fruit juices or pie filling) to remain on the surface as they may leave a dull spot even after cleaning.
- Clean any soil from the oven frame, the door liner outside the oven door gasket and the small area at the front center of the oven bottom. These areas heat sufficiently to burn soil on. Clean with soap and water.

NOTE: Prior to setting the Self-Clean cycle, any spills remaining on the oven bottom should be removed.

Self-Cleaning

- Setting Flex Clean or Delay Flex Clean

The **FLEX CLEAN**  pad is used to start a Self-Cleaning cycle. When used with the **DELAY START**  pad, a delayed Self-Cleaning cycle may also be programmed. The **FLEX CLEAN** feature allows for any Self-Cleaning cycle time from 2 (2:00) to 4 hours (4:00) to be selected. You may also choose the clean time in 1 minute increments (for example 2 hours and 50 minutes) by pressing the number keypads   .





WARNING During the Self-Cleaning cycle, the outside of the range can become VERY HOT to the touch. **DO NOT** leave small children unattended near the appliance.



CAUTION **DO NOT** force the oven door open. This can damage the automatic door locking system. Use care when opening the oven door after the Self-Cleaning cycle. Stand to the side of the oven when opening the door to allow hot air or steam to escape. The oven may still be **VERY HOT**.

INSTRUCTIONS

To start an immediate Self-Cleaning cycle or to set a Delay Start time of 9:00 o'clock and shut-off automatically (example provided is a default 3 hour Self-Clean cycle):

1. Be sure the clock is set with the correct time of day, the oven is EMPTY and the oven door is closed.

2. Press . "CLEAN" will flash, "3:00" (hours) and the Cooktop locked icon will show in the display (See Fig. 1). 2-4 hours of Self-Cleaning time may be chosen by pressing any amount of time from    (2 hours) through





   (4 hours) in one minute increments. You may also skip the time entry and accept the default cleaning time of 3 hours by pressing the **START** key pad (See Step 3).

3. Press . The "DOOR LOCKED" icon will flash; "CLEAN", Cooktop Lockout icon and the letters "CLn" will remain on in the display (See Fig. 2).

4. As soon as the control is set, the motor driven oven door lock will begin to close automatically. Once the door has been locked the "DOOR LOCKED" indicator light will quit flashing

NOTE: If the optional delay Self-Clean feature is needed, finish steps 5-7. If Self-Clean is started immediately skip the remaining steps and continue with "When the Self-Clean cycle is done" on the following page.

and remain on. The Cooktop locked icon will remain on (Fig. 3).

5. Press  (See Fig. 4). Enter the desired Self-Clean starting time using the number pads    (See Fig. 5).

6. Press . "CLn" icon will turn off; "DELAY", "DOOR LOCKED", "CLEAN" and Cooktop locked icons will remain on.

7. The control will calculate forward from the set start time to determine when the Self-Cleaning cycle should end. The Self-Cleaning cycle will turn on automatically at the set time. At that time the icon "DELAY" will go out; the oven icon will come on, the start time, Cooktop locked icon, "CLEAN" and "CLn" will remain in the display (See Fig. 6).

PRESS

DISPLAY



2:00 thru 4:00 using number pads

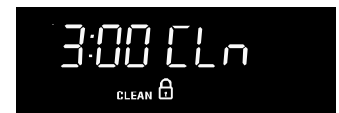

Fig. 1



Fig. 2

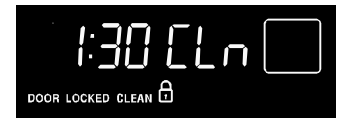

Fig. 3



Fig. 4

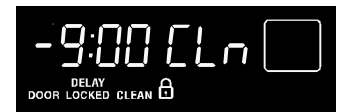

Fig. 5

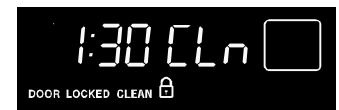

Fig. 6

Self-Cleaning

- Setting Flex Clean
- Setting Delay Flex Clean

INSTRUCTIONS

PRESS

DISPLAY

When the Self-Clean cycle is done:

1. The time of day, "**DOOR LOCKED**" and "**CLEAN**" icon will remain in the display.
2. Once the oven has cooled down for approximately 1 HOUR, and the "**DOOR LOCKED**" icon is no longer displayed, the oven door can then be opened.

Stopping or Interrupting a Self-Cleaning cycle:

If it becomes necessary to stop or interrupt a Self-Cleaning cycle due to excessive smoke or fire in the oven:

1. Press .
2. Once the oven has cooled down for approximately 1 HOUR and the "**DOOR LOCKED**" icon is no longer displayed, the oven door can then be opened (See Fig. 7).



Fig.7

IMPORTANT NOTES when using the Self-Clean feature:

1. The Self-Clean feature will not operate whenever a radiant surface remains ON.
2. A Self-Clean cycle may be started if the appliance has the **Cooktop Lockout** active. A Self-Clean cycle cannot be started if **Oven Lockout** feature is active.
3. If a Self-Cleaning-Cycle has started but not finished and a power failure occurs, the appliance may be thoroughly cleaned. After the door unlocks and power has been restored, set for another Self-Clean cycle.
4. If your clock is set for normal 12 hour display mode the Delay Self-Clean cycle can never be set to start more than 12 hours in advance. To set for Delay Flex-Clean 12-24 hours in advance see page 19 for instructions to set the control for the **24 hour time of day** display mode.

Adjusting Oven Temperature

- How to adjust the oven temperature higher or lower

The cooking temperatures for in the oven have been pre-set at the factory. When using the oven for the first time, be sure to follow recipe times and temperatures. If you think the oven is too hot or too cool, the temperature in the oven may be adjusted. Before adjusting, test a recipe by using a temperature setting that is higher or lower than the recommended temperature. The baking results should help you to decide how much of an adjustment is needed.

INSTRUCTIONS

PRESS

DISPLAY

To adjust the oven temperature higher:

1. Press **Bake** for 6 seconds (See Fig. 1).
2. To increase the temperature use the number keypads to enter the desired change. (Example 30°F) **3** **0** (Fig. 2).
The temperature may be increased as much as 35°F (19°C).
3. Press **START** to accept the temperature change and the display will return to the time of day (See Fig. 3). Press **STOP** to reject the change if necessary.

Bake



Fig. 1

3 **0**

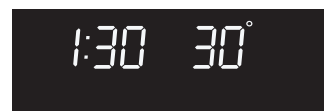

Fig. 2

START

STOP

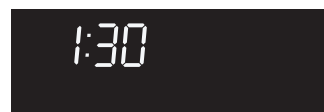

Fig. 3

To adjust the oven temperature lower:

1. Press **Bake** for 6 seconds (See Fig. 4).
2. To decrease the temperature use the number pads to enter the desired change. (Example -30°F) **3** **0** and then press **Flex Clean** (See Fig. 5). The temperature may be decreased as much as 35°F (19°C). **Note:** If the temperature shows an adjustment of -30°F, and a +30°F adjustment is needed, you can toggle between - and + in the display by pressing the **Flex Clean** key pad
3. Press **START** to accept the temperature change and the display will return to the time of day (See Fig. 6). Press **STOP** to reject the change if necessary.

Bake



Fig. 4

3 **0** **Flex Clean**



Fig. 5

START

STOP



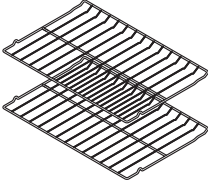
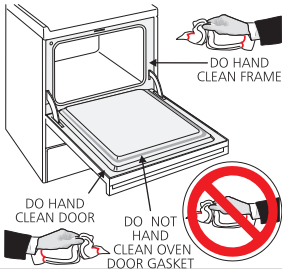

Fig. 6

NOTE: The oven temperature adjustments made with this feature will not affect the Self-Clean cycle temperature.

General Care & Cleaning

- Cleaning Table

Surfaces:	How to Clean:
Aluminum & Vinyl	Use hot, soapy water and a cloth. Dry with a clean cloth.
Painted & plastic control panel parts & decorative trims	<i>For general cleaning</i> , use hot, soapy water and a cloth. <i>For more difficult soil and built-up grease</i> , apply a liquid detergent directly onto the soil. Leave on soil for 30 to 60 minutes. Rinse with a damp cloth and dry. DO NOT use abrasive cleaners on any of these materials; they can scratch.
Glass control panel  	<p>CAUTION Before cleaning the glass control panel make sure all cooktop controls are set to OFF and activate the Cooktop Lockout feature (See page 8 for complete Cooktop Lockout instructions).</p> <p>Clean using hot, soapy water and a dishcloth then rinse with clean water. Be sure to squeeze excess water from the cloth before wiping the panel; especially when wiping around the controls. Excess water in or around the controls may cause damage to the appliance.</p> <p>DO NOT use abrasive cleaners. This type of cleaner will permanently scratch the glass control panel. DO NOT place or leave cleaning supplies on the ceramic cooktop while cleaning the glass control panel. Move these items to a kitchen counter-top. To finish cleaning or for lighter soil use a typical household glass cleaner and paper towels.</p>
Stainless Steel , chrome control panel & metal decorative trims	Clean Stainless Steel with hot, soapy water and a dishcloth. Rinse with clean water and a cloth. Do not use cleaners with high concentrations of chlorides or chlorines. Do not use harsh scrubbing cleaners. Only use kitchen cleaners that are especially made for cleaning Stainless Steel. Always be sure to rinse the cleaners from the surface as bluish stains may occur during heating that cannot be removed.
Porcelain enamel broiler pan & insert, door liner, body parts & interior Warmer Drawer area	Gentle scouring with a soapy scouring pad will remove most spots. Rinse with a 1:1 solution of clear water and ammonia. <i>If necessary</i> , cover difficult spots with an ammonia-soaked paper towel for 30 to 40 minutes. Rinse with clean water and a damp cloth, and then scrub with a soap-filled scouring pad. Rinse and wipe dry with a clean cloth. Remove all cleaners or the porcelain may become damaged during future heating. DO NOT use spray oven cleaners on the cooktop.
Porcelain oven racks 	Porcelain oven racks may be left in the oven during the Self-Clean cycle. If further cleaning is required, remove the racks after the oven has cooled & clean using a mild non-abrasive cleaner following manufacturer's instructions. Rinse with clean water and let dry. After the Self-Clean cycle is done and the oven has cooled, rub the sides of the oven racks with wax paper or a cloth containing a small amount of vegetable oil. This will make the racks glide easier into the oven rack positions.
Oven door 	To clean oven door remove following the door removal instructions in this Use & Care Guide. Wash soiled areas with hot, soapy water and a clean cloth. DO NOT immerse the door in water. DO NOT clean the oven door gasket. On Self-Cleaning models the oven door gasket is made of a woven material which is essential for a good seal. Care should be taken not to rub, damage or remove this gasket.
Ceramic Cooktop	Follow the instructions the "Cooktop Cleaning & Maintenance" in this Use & Care Guide.

General Care & Cleaning

- Cooktop Cleaning & Maintenance
- Cleaning Recommendations for the Ceramic Glass Cooktop

Cooktop Cleaning & Maintenance

Consistent and proper cleaning is essential to maintaining your ceramic glass cooktop.

Prior to using your cooktop for the first time, apply the recommended CookTop® Cleaning Creme to the ceramic surface (on the web visit www.sears.com for replacement cooktop cleaner, item number 40079). Buff with a **non-abrasive** cloth or no-scratch cleaning pad. This will make cleaning easier when soiled from cooking. The special cooktop cleaning cream leaves a protective finish on the glass to help prevent scratches and abrasions.

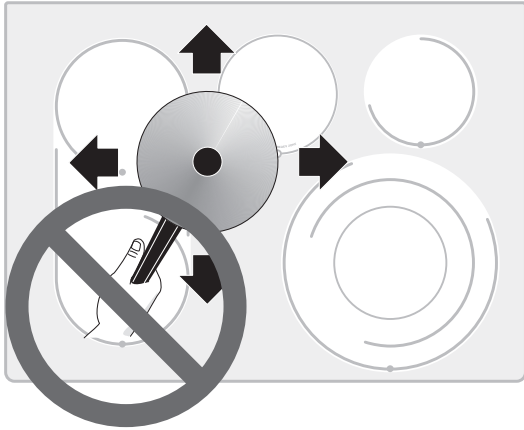

Sliding aluminum or copper clad bottom pans on the cooktop can cause metal markings on the cooktop surface. These marks should be removed **immediately** after the cooktop has cooled using the cooktop cleaning cream. Metal marks can become permanent if not removed prior to future use.

Cookware (cast iron, metal, ceramic or glass) with rough bottoms can mark or scratch the cooktop surface. **Do not slide anything metal or glass** across the cooktop. **Do not** use your cooktop as a cutting board or work surface in the kitchen. **Do not** cook foods directly on the cooktop surface without a pan. **Do not** drop heavy or hard objects on the glass cooktop, they may cause it to crack.

CAUTION Before cleaning the cooktop, be sure the controls are turned to **OFF** and the cooktop is **COOL**.

WARNING **DO NOT** use a cooktop cleaner on a hot cooktop. The fumes can be hazardous to your health, and can chemically damage the ceramic-glass surface.

Cleaning Recommendations for the Ceramic Glass Cooktop

For light to moderate soil:

Apply a few drops of CookTop® Cleaning Creme directly to the cooktop. Use a paper towel or use a **non-abrasive** plastic type no-scratch cleaning pad to clean the entire cooktop surface. Make sure the cooktop is cleaned thoroughly, leaving no residue.

For heavy, burned on soil:

Apply a few drops of CookTop® Cleaning Creme directly to the soiled area. Rub the soiled area using a **non-abrasive** plastic type no-scratch cleaning pad, applying pressure as needed. Do not use the pad you use to clean the cooktop for any other purpose.

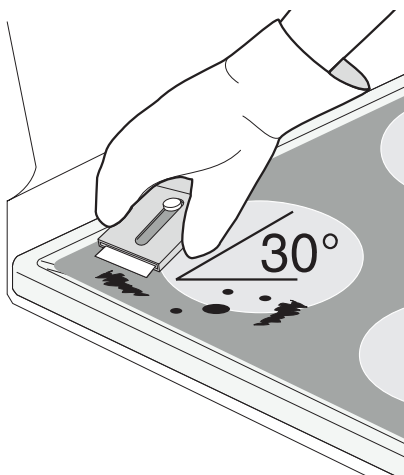

If soils remain, carefully scrape soils with a metal razor blade scraper, holding scraper at a 30 degree angle to the surface. Remove loosened soils with cooktop cleaning cream and buff surface clean.

IMPORTANT NOTE: Damage to the ceramic glass cooktop may occur if you use an abrasive type cleaning pad. Only use cleaning products that have been specifically designed for ceramic glass cooktops.

Plastic or foods with a high sugar content:

These types of soils need be removed immediately if spilled or melted onto the ceramic cooktop surface. Permanent damage (such as pitting of the cooktop surface) may occur if not removed **immediately**. After turning the surface elements **OFF**, use a razor blade scraper or a metal spatula with a mitt and scrape the soil from the hot surface (as illustrated). Allow the cooktop to cool, and use the same method for heavy or burned on soils.

General Care & Cleaning

- Cleaning Recommendations for the Ceramic Glass Cooktop (cont'd)
- Special Caution for Aluminum Use on the Ceramic Cooktop
- Removing & Replacing the Lift-Off Oven Door



Do not use the following on the ceramic glass cooktop:

- Do not use abrasive cleaners and scouring pads, such as metal and some nylon pads. They may scratch the cooktop, making it more difficult to clean.
- Do not use harsh cleaners, such as chlorine bleach, ammonia or oven cleaners, as they may etch or discolor the cooktop.
- Do not use dirty sponges, cloths or paper towels, as they can leave soil or lint on the cooktop which can burn and cause discoloration.

Special Caution for Aluminum Use on the Ceramic Cooktop:

- **Aluminum Foil** - Use of aluminum foil on a hot cooktop will damage the ceramic cooktop. Do not use thin aluminum cooking utensils or allow aluminum foil to touch the ceramic cooktop under ANY circumstances.
- **Aluminum utensils** - The melting point of aluminum is much lower than that of other metals. Care must be taken when aluminum pots or pans are used on the cooktop. If allowed to boil dry, not only will the utensil be destroyed, but it may fuse to, break or mark the ceramic glass surface, permanently damaging the cooktop surface.

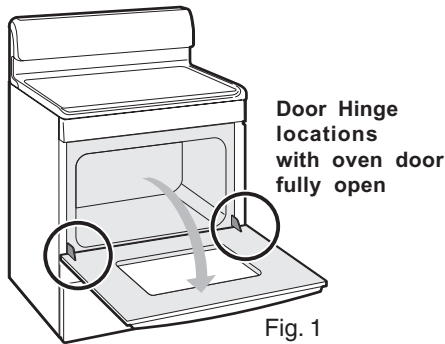

Fig. 1

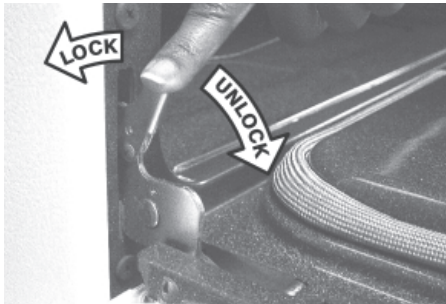

Fig. 2

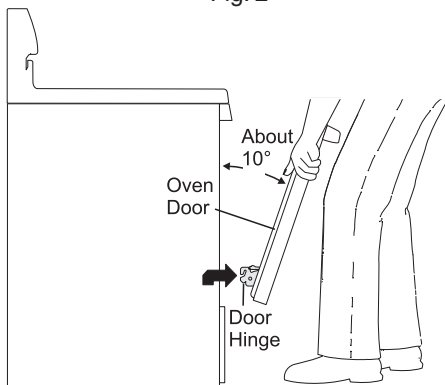

Fig. 3

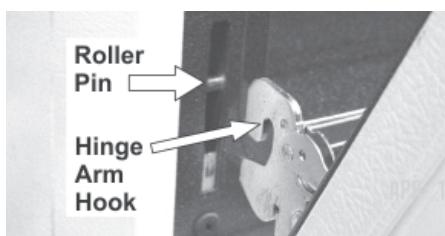

Fig. 4

Removing & Replacing the Lift-Off Oven Door

⚠ CAUTION The door is heavy. For safe, temporary storage, lay the door flat with the inside of the door facing down.

To Remove Oven Door:

1. Open oven door completely (horizontal with floor - See Fig. 1).
2. Pull the door hinge locks on both left and right door hinges down from the oven frame completely towards the oven door (See Fig. 2). A tool such as a small flat-blade screwdriver may be required.
3. Firmly grasp both sides of oven door along the door sides (Do not use the oven door handle - See Fig. 3).
4. Close the door to the broil stop position (the oven door will stop into this position just before fully closing).
5. With the oven door in the broil stop position, lift the oven door hinge arms over the roller pins located on each side of the oven frame (See Fig. 4).

To Replace Oven Door:

1. Firmly grasp both sides of oven door along the door sides (Do not use the oven door handle - See Fig. 3).
2. Holding the oven door at the same angle as the removal position, seat the hook of the hinge arm over the roller pins located on each side of the oven door frame (See Fig. 4). The hook of the hinge arms must be fully seated onto the roller pins.
3. Fully open the oven door (horizontal with floor - See Fig. 1).
4. Push the door hinge locks up towards and into the oven frame on both left and right oven door hinges (See Fig. 2) to the locked position.
5. Close the oven door.

Door Care Instructions - Most oven doors contain glass that can break. Read the following recommendations:

1. Do not close the oven door until all the oven racks are fully in place.
2. Do not hit the glass with pots, pans, or any other object.
3. Scratching, hitting, jarring or stressing the glass may weaken its structure causing an increased risk of breakage at a later time.

General Care & Cleaning

- Changing Oven Lights
- Care & Cleaning of Stainless Steel (some models)

Changing Oven Lights

CAUTION Be sure the range is unplugged and all parts are COOL before replacing oven light. Wear a leather-faced glove for protection against possible broken glass.

The oven lights automatically turn ON when the door is opened. The oven lights may also be manually operated by pressing the  pad.

The upper oven light bulbs are located at the rear of the oven cavity and both are covered with a glass shield. The glass shield must be in place whenever the oven is in use.

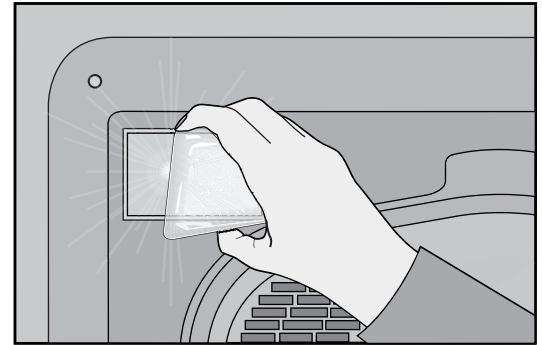

Replacing the upper oven interior light bulbs:

1. Turn electrical power off at the main source or unplug the range.
2. Remove upper oven interior light shield as illustrated below.
3. Replace bulb with a new **T-4 type 40 Watt Halogen** appliance bulb. Please note: do not allow your fingers to touch the new bulb when replacing. This will shorten the life of the new bulb. Use a paper towel to cover the new bulb when installing.
4. Replace glass shield over bulb.
5. Turn power back on again at the main source (or plug the range back in).
6. The clock will then need to be reset.

Care & Cleaning of Stainless Steel (some models)

Some models are equipped with stainless steel exterior parts. Special care and cleaning are **required** for maintaining the appearance of stainless parts. Refer to the **Care & Cleaning Table** for detailed cleaning instructions.

Before You Call

- Solutions to Common Problems

Before you call for service, review this list. It may save you time and expense. The list includes common occurrences that are not the result of defective workmanship or materials in this appliance.

OCCURRENCE	POSSIBLE CAUSE/SOLUTION
Range is not level.	<p>Poor installation. Place oven rack in center of oven. Place a level on the oven rack. Adjust leveling legs at base of range until the oven rack is level.</p> <hr/> <p>Be sure floor is level and is strong and stable enough to adequately support range.</p> <hr/> <p>If floor is sagging or sloping, contact a carpenter to correct the situation.</p> <hr/> <p>Kitchen cabinet alignment may make range appear unlevel. Be sure cabinets are square and have sufficient room for range clearance.</p>
Cannot move appliance easily. Appliance must be accessible for service.	<p>Cabinets not square or are built in too tightly. Contact builder or installer to make appliance accessible.</p> <hr/> <p>Carpet interferes with range. Provide sufficient space so range can be lifted over carpet.</p>
Oven control beeps and displays any F code error (for example F11).	<p>Electronic control has detected a fault condition. Press the STOP key pad to clear the display and stop beeping. Reprogram oven. If fault recurs, record fault number. Press the STOP key pad and call 1-800-4-MY-HOME® for assistance (See back cover).</p>
Surface element too hot or not hot enough.	<p>Incorrect control setting. Make sure the correct control is on for the element to be used.</p>
Surface element does not heat.	<p>Lightweight or warped pans used. Use only flat, evenly balanced, medium or heavyweight cookware. Flat pans heat better than warped pans. Cookware materials and weight of the material affect heating. Heavy and medium-weight pans heat evenly. Because lightweight pans heat unevenly, foods may burn easily.</p> <hr/> <p>No power to the appliance. Check steps under "Entire Appliance Does Not Operate" in this Before You Call checklist.</p> <hr/> <p>Incorrect control setting. Make sure the correct control is set for the surface element to be used.</p>
Entire appliance does not operate.	<p>Make sure cord/plug is plugged correctly into outlet. Check circuit breakers.</p> <hr/> <p>Service wiring is not complete. Call 1-800-4-MY-HOME® for assistance (See back cover).</p> <hr/> <p>Power outage. Check house lights to be sure. Call your local electric company for service.</p>
ESEC displays " - - " message.	<p>The ESEC Control will display " - - " in the digital display windows indicating that the ESEC has a "Lockout" condition. This condition is normal when using the cooktop lockout or Self-Clean features. Wait for the Self-Clean cycle to completely finish or if using the Cooktop Lockout feature, touch the CLOCK key pad for 3 seconds to unlock the cooktop.</p>
ESEC displays any "F" message.	<p>The ESEC control constantly monitors the internal circuitry as well as several circuits to insure they are all operating correctly. If at any time one of these systems fails, the ESEC will immediately stop the current operation and flash an error code. If any of these error messages remain or reappear in the display, call 1-800-4-MY-HOME® (See back cover).</p>

ENGLISH

Before You Call

- Solutions to Common Problems

OCCURRENCE

POSSIBLE CAUSE/SOLUTION

Oven light does not work.

Replace or tighten bulb. See **Changing Oven Light** section in this Use & Care Guide.

Oven smokes excessively during broiling.

Control(s) not set properly. Follow instructions under **Setting Oven Controls**.

Make sure oven door is opened to **broil stop position**.

Meat too close to the element. Reposition the rack to provide proper clearance between the meat and the element. Preheat broil element for searing.

Meat not properly prepared. Remove excess fat from meat. Cut remaining fatty edges to prevent curling, but do not cut into lean.

Insert on broiler pan wrong side up and grease not draining. Always place grid on the broiler pan with ribs up and slots down to allow grease to drip into pan.

Grease has built up on oven surfaces. Regular cleaning is necessary when broiling frequently. Old grease or food spatters cause excessive smoking.

Poor baking results.

Many factors affect baking results. Make sure the proper rack position is used. Center food in the oven and space pans to allow air to circulate. Allow the oven to preheat to the set temperature before placing food in the oven. Try adjusting the recipe's recommended temperature or baking time. If you feel the oven is too hot or cool, see **Adjusting Your Oven Temperature** in this Use & Care Guide.

Self-Cleaning cycle does not work.

Control(s) not set properly. Follow instructions under **Self-Cleaning**.

Self-Cleaning cycle was interrupted. Follow steps under "Stopping or Interrupting a Self-Cleaning Cycle" under **Self-Cleaning**.

Soil not completely removed after Self-Cleaning cycle.

Failure to clean bottom, front top of oven, frame of oven or door area outside oven seal. These areas are not in the self-cleaning area, but get hot enough to burn on residue. Clean these areas before the self-cleaning cycle is started. Burned-on residue can be cleaned with a stiff nylon brush and water or a nylon scrubber. Be careful not to damage the oven gasket.

Flames inside oven or smoking from vent.

Excessive spillovers in oven. Set Self-Clean cycle for a longer cleaning time.

Excessive spillovers in oven. This is normal, especially for high oven temperatures, pie spillovers or large amounts of grease on bottom of oven. Wipe up excessive spillovers before starting cycle. If flames or excessive smoke are present, stop the self-clean cycle and follow steps under "Stopping or Interrupting a Self-Cleaning Cycle" in the **Self-Cleaning** section.

Scratches or abrasions on cooktop surface (Ceramic-Glass cooktop models only).

Coarse particles such as salt or sand between cooktop and utensils can cause scratches. Be sure cooktop surface and bottoms of utensils are clean before usage. Small scratches do not affect cooking and will become less visible with time.

Cleaning materials not recommended for ceramic-glass cooktop have been used. See "Cooktop Cleaning and Maintenance" in the **General Care & Cleaning** section.

Cookware with rough bottom has been used. Use smooth, flat-bottomed cookware.

Metal marks (Ceramic-Glass cooktop models only).

Sliding or scraping of metal utensils on cooktop surface. Do not slide metal utensils on cooktop surface. Use a ceramic-glass cooktop cleaning creme to remove the marks. See "Cooktop Cleaning and Maintenance" in the **General Care & Cleaning** section.

Brown streaks or specks (Ceramic-Glass cooktop models only).

Boilovers are cooked onto surface. Use razor blade scraper to remove soil. See "Cooktop Cleaning and Maintenance" in the **General Care & Cleaning** section.

Areas of discoloration with metallic sheen (Ceramic-Glass cooktop models only).

Mineral deposits from water and food. Remove using a ceramic-glass cooktop cleaning creme. Use cookware with clean, dry bottoms.

Recipes for Slow Cook

Slow Cook Turkey Breast

1 turkey breast
2 cups chicken broth
1 medium onion, sliced
2 teaspoons minced garlic
1 teaspoon salt
½ teaspoon pepper

In a roasting pan, place turkey breast meat-side up. Rub salt and pepper under the skin, and inside the cavity. Pour chicken broth around turkey breast, adding the onions and garlic. Cover roasting pan with lid or foil. Using the Slow Cook feature pad, set control on "Lo" setting for 7 to 8 hours, or the "Hi" setting for 4 to 5 hours. 4 to 6 servings.

Parmesan Green Beans and Potatoes

32oz frozen whole green beans
6 medium red potatoes, sliced
1 large onion, sliced
1 tablespoon seasoning salt
½ cup margarine
1 cup parmesan cheese, grated

Combine green beans, potatoes, onions, seasoning salt, margarine and parmesan cheese in large casserole dish. Cover with lid or aluminum foil.

Using the Slow Cook feature pad, set control on "Lo" setting for 7 to 8 hours, or the "Hi" setting for 4 to 5 hours. 4 to 6 servings.

Orange Surprise Cake

1 - pkg. orange cake mix
1 - 3.3oz pkg. white chocolate instant pudding
1 - 16oz. container sour cream
¾ cup vegetable oil
1 cup orange juice
4 eggs
1 - 9oz pkg. white chocolate pieces

Combine all ingredients, except white chocolate pieces. Blend well; then add white chocolate pieces. Pour mixture into a 5 quart oven safe dish coated with nonstick cooking spray.

Using the Slow Cook feature pad, set control on "Lo" setting for 5 to 6 hours, or the "Hi" setting for 3 to 4 hours. Spoon into bowl while still warm and serve with vanilla bean ice cream, or whipped cream.

4 to 6 servings.

Pork Chops with Potatoes

1 can (10 ¾ oz) cream of mushroom soup
¼ cup dry white wine
¼ cup Dijon mustard
1 teaspoon dry thyme, crushed
1 teaspoon garlic, minced
6 pork chops, cut ¾" thick
1 teaspoon pepper seasoning
1 teaspoon salt seasoning
1 tablespoon parsley
6 medium potatoes, sliced
1 medium onion, sliced

In a large mixing bowl, combine first 5 ingredients; blend well. In a roasting pan, spread potatoes and onions over the bottom of the pan. Pour soup mixture over potatoes and onions; topping

with the pork chops. Sprinkle pepper seasoning and parsley on top of pork chops. Cover pan with lid or aluminum foil and place on rack in the oven.

Using the Slow Cook feature pad, set control on "Lo" setting for 5 to 6 hours, or the "Hi" setting for 3 to 4 hours. 4 to 6 servings.

Apple Bread Pudding

5 cups sour dough bread cubes (½ ")
½ cup butter, melted
¾ cup brown sugar
½ teaspoon cinnamon
¼ teaspoon nutmeg
pinch of salt
4 to 5 cups apples, peeled and sliced thickly
1 cup raisins
1 cup walnuts, chopped

In large mixing bowl, combine all ingredients; blend well. Pour mixture into a 5 quart oven safe dish. Cover with lid or aluminum foil and place on rack in oven.

Using the Slow Cook feature pad, set control on "Lo" setting for 5 to 6 hours, or the "Hi" setting for 3 to 4 hours. 4 to 6 servings.

Roast Beef with Vegetables

3 to 3 ½ lb sirloin tip roast
2 cups water
4 to 5 medium potatoes, quartered
1 lb. small carrots
2 large onion, quartered
4 garlic cloves
¼ cup worstershire sauce
salt
pepper

Center roast in large roasting pan. Add water. Spread potatoes, carrots, onions and garlic cloves evenly around roast. Pour worstershire sauce on top of roast. Sprinkle all with salt and pepper to taste. Cover with lid or aluminum foil.

Using the Slow Cook feature pad, set control on "Lo" setting for 5 to 6 hours, or the "Hi" setting for 3 to 4 hours. 4 to 6 servings.

Peach Cobbler

1 cup self rising flour
1 cup sugar
1 cup milk
½ cup butter, melted
1 lb. frozen peaches

In 5 quart oven safe dish, combine first four ingredients. Blend well. Stir in peaches. Place on rack in oven.

Using the Slow Cook feature pad, set control on "Lo" setting for 5 to 6 hours, or the "Hi" setting for 3 to 4 hours. 4 to 6 servings.

Get it fixed, at your home or ours!

Your Home

For repair – **in your home** – of **all** major brand appliances, lawn and garden equipment, or heating and cooling systems, **no matter who made it, no matter who sold it!**

For the replacement parts, accessories and owner's manuals that you need to do-it-yourself.

For Sears professional installation of home appliances and items like garage door openers and water heaters.

1-800-4-MY-HOME[®] (1-800-469-4663)

Call anytime, day or night (U.S.A. and Canada)

www.sears.com www.sears.ca

For expert home solutions advice: www.managemyhome.com

Our Home

For repair of carry-in items like vacuums, lawn equipment, and electronics, call or go on-line for the location of your nearest

Sears Parts & Repair Service Center

1-800-488-1222 (U.S.A.) **1-800-469-4663** (Canada)

Call anytime, day or night

www.sears.com www.sears.ca

To purchase a protection agreement on a product serviced by Sears:

1-800-827-6655 (U.S.A.)

1-800-361-6665 (Canada)

Para pedir servicio de reparación a domicilio, y para ordenar piezas:

1-888-SU-HOGAR[®]

(1-888-784-6427)

Au Canada pour service en français:

1-800-LE-FOYER^{MC}

(1-800-533-6937)

www.sears.ca



® Registered Trademark / TM Trademark / SM Service Mark of Sears Brands, LLC

® Marca Registrada / TM Marca de Fábrica / SM Marca de Servicio de Sears Brands, LLC

MC Marque de commerce / MD Marque déposée de Sears Brands, LLC

© Sears Brands, LLC

Free Manuals Download Website

<http://myh66.com>

<http://usermanuals.us>

<http://www.somanuals.com>

<http://www.4manuals.cc>

<http://www.manual-lib.com>

<http://www.404manual.com>

<http://www.luxmanual.com>

<http://aubethermostatmanual.com>

Golf course search by state

<http://golfingnear.com>

Email search by domain

<http://emailbydomain.com>

Auto manuals search

<http://auto.somanuals.com>

TV manuals search

<http://tv.somanuals.com>