

Use & Care Guide

Model No.

153.321160 60 Gallon

153.321180 80 Gallon



Kenmore® Elite

Hybrid Electric Water Heater

For potable water heating only.
Not suitable for space heating.

INSTALLER: Affix these instructions to or near
the water heater.

OWNER: Retain these instructions for future
reference.

ADVERTENCIA

Si no puede leer o entender el inglés y necesita el manual de instrucciones en español, puede solicitarlo al 1-800-821-2017. NO TRATE DE INSTALAR U OPERAR ESTE CALENTADOR DE AGUA SI NO ENTIENDE LAS INSTRUCCIONES. No hacer caso de esta advertencia podría originar lesiones graves o mortales.

P/N 319994-000 (0910)

Sears Brands Management Corporation,
Hoffman Estates, IL 60179 U.S.A.

www.kenmore.com

www.sears.com







SAFE INSTALLATION, USE AND SERVICE

Your safety and the safety of others is extremely important in the installation, use and servicing of this water heater.

Many safety-related messages and instructions have been provided in this manual and on your own water heater to warn you and others of a potential injury hazard. Read and obey all safety messages and instructions throughout this manual. It is very important that the meaning of each safety message is understood by you and others who install, use or service this water heater.

	This is the safety alert symbol. It is used to alert you to potential personal injury hazards. Obey all safety messages that follow this symbol to avoid possible injury or death.
---	--

	DANGER indicates an imminently hazardous situation which, if not avoided, will result in death or injury.
	WARNING indicates a potentially hazardous situation which, if not avoided, could result in death or injury.
	CAUTION indicates a potentially hazardous situation which, if not avoided, could result in minor or moderate injury.
	CAUTION used without the safety alert symbol indicates a potentially hazardous situation which, if not avoided, could result in property damage.

All safety messages will generally tell you about the type of hazard, what can happen if you do not follow the safety message and how to avoid the risk of injury.

The California Safe Drinking Water and Toxic Enforcement Act requires the Governor of California to publish a list of substances known to the State of California to cause cancer, birth defects, or other reproductive harm, and requires businesses to warn of potential exposure to such substances.

This product contains a chemical known to the State of California to cause cancer, birth defects, or other reproductive harm. This appliance can cause low level exposure to some of the substances listed in the act.

IMPORTANT DEFINITIONS

- **Sears Service Center:** The Sears Service Center has the ability equivalent to a licensed tradesman in the fields of plumbing and electrical work including a thorough understanding of the requirements of the National Electrical Code as it relates to the installation of electric water heaters. The Sears Service Center also has a thorough understanding of this instruction manual, and is able to perform repairs strictly in accordance with the service guidelines provided by the manufacturer.

GENERAL SAFETY

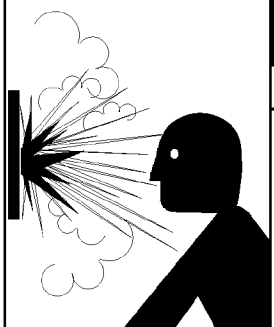

	⚠ WARNING
	<p>Read and understand instruction manual and safety messages before installing, operating or servicing this water heater.</p> <p>Failure to follow instructions and safety messages could result in death or serious injury.</p> <p>Instruction manual must remain with water heater.</p>

CAUTION
Improper installation and use may result in property damage.
<ul style="list-style-type: none">• Do not operate water heater if flood damaged.• Inspect and replace the anode as needed.• Install in location with drainage.• Fill tank with water before operation.• Be alert for thermal expansion. <p>Refer to instruction manual for installation and service.</p>

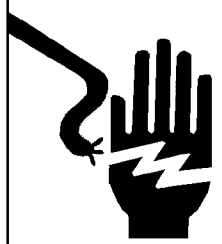
	⚠ WARNING
	Explosion Hazard <ul style="list-style-type: none">• Overheated water can cause water tank explosion.• Properly sized temperature and pressure relief valve must be installed in opening provided.

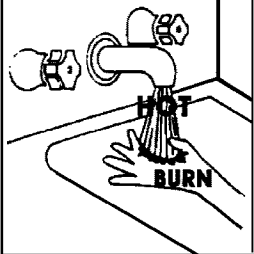
	⚠ WARNING
	<ul style="list-style-type: none">• Before removing any access panels or servicing the water heater, make sure the electrical supply to the water heater is turned "OFF".• Failure to do this could result in death, serious bodily injury, or property damage.

	⚠ DANGER
	<p>Water temperature over 125°F (52°C) can cause severe burns instantly resulting in severe injury or death.</p> <p>Children, the elderly, and the physically or mentally disabled are at highest risk for scald injury.</p> <p>Feel water before bathing or showering.</p> <p>Temperature limiting valves are available.</p> <p>Read instruction manual for safe temperature setting.</p>

⚠ WARNING		
Fire Hazard / Electric Shock Hazard		
	<ul style="list-style-type: none">• Do not use this water heater with any voltage other than shown on the model rating plate.• Failure to use the correct voltage shown on the model rating plate could result in death, serious bodily injury, or property damage.	

PRODUCT WARRANTY

10 - YEAR LIMITED WARRANTY ON WATER HEATER

For ten years from the date of purchase, if this water heater is installed and operated in a single-family home in accordance with the owner's manual instructions and all local applicable plumbing codes, Sears will:

1. Supply free water heater parts for those that are defective in material or workmanship.
2. Supply a free water heater for one that develops a leak.

For the second through tenth year from the purchase date, you must pay the labor cost for installation of parts or water heater.

For commercial, institutional, industrial or residential use by two or more families, the above limited warranty is only for two years. During the second year you must pay the labor cost for parts or water heater installation.

If governmental regulations prohibit Sears from furnishing a comparable model replacement water heater under this warranty, Sears will furnish a new water heater of comparable output as permitted by such governmental regulations; however, the Owner will be charged for the additional cost associated with the changes made to the replacement water heater design to comply with such governmental regulations.

Replacements and/or repairs furnished under this warranty do not carry a new warranty, and are only covered by the unexpired portion of the original warranty.

1 - YEAR EXCLUSIVE KENMORE LABOR WARRANTY

For the first year from the date of purchase, Sears will, free of charge, supply and install new water heater parts for defective ones or a new water heater for one that develops a leak.

WARRANTY SERVICE

To obtain warranty service, call 1-800-4-MY-HOME® (1-800-469-4663).

This warranty applies only while this product is in use in the United States.

This warranty gives you specific legal rights, and you may also have other rights which vary from state to state.

SEARS BRANDS MANAGEMENT CORPORATION, Hoffman Estates, IL 60179

The price of your water heater does not include a free checkup service call. On water heater installations arranged by Sears, Sears warrants the installation.

A charge will be made on service calls due to poor or incomplete installation. These include:

- a. Adjusting thermostat
- b. Condensation
- c. Leaks in pipes or fittings

Master Protection Agreements

Congratulations on making a smart purchase. Your new Kenmore® product is designed and manufactured for years of dependable operation. But like all products, it may require preventive maintenance or repair from time to time. That's when having a Master Protection Agreement can save you money and aggravation.

The Master Protection Agreement also helps extend the life of your new product. Here's what the Agreement* includes:

- **Parts and labor** needed to help keep products operating properly **under normal use**, not just defects. Our coverage goes **well beyond the product warranty**. No deductibles, no functional failure excluded from coverage— **real protection**.
- **Expert service** by a force of more than **10,000 authorized Sears service technicians**, which means someone you can trust will be working on your product.
- **Unlimited service calls and nationwide service**, as often as you want us, whenever you want us.
- **"No-lemon"** guarantee – replacement of your covered product if four or more product failures occur within twelve months.
- **Product replacement** if your covered product can't be fixed.
- **Annual Preventive Maintenance Check** at your request – no extra charge.
- **Fast help by phone** – we call it **Rapid Resolution** – phone support from a Sears representative on all products. Think of us as a "talking owner's manual."
- **Power surge protection** against electrical damage due to power fluctuations.

- **\$250 Food Loss Protection** annually for any food spoilage that is the result of mechanical failure of any covered refrigerator or freezer.
- **Rental reimbursement** if repair of your covered product takes longer than promised.
- **10% discount** off the regular price of any non-covered repair service and related installed parts.

Once you purchase the Agreement, a simple phone call is all that it takes for you to schedule service. You can call anytime day or night, or schedule a service appointment online.

The Master Protection Agreement is a risk free purchase. If you cancel for any reason during the product warranty period, we will provide a full refund. Or, a prorated refund anytime after the product warranty period expires. Purchase your Master Protection Agreement today!

Some limitations and exclusions apply. For prices and additional information in the U.S.A. call 1-800-827-6655.

*** Coverage in Canada varies on some items. For full details, call Sears Canada at 1-800-361-6665.**

Sears Installation Service

*For Sears professional installation of home appliances, garage door openers, water heaters, and other major home items, in the U.S.A. or Canada call **1-800-4-MY-HOME®**.*

TABLE OF CONTENTS

SAFE INSTALLATION, USE AND SERVICE	2
GENERAL SAFETY	3
PRODUCT WARRANTY	4
TABLE OF CONTENTS	5
INTRODUCTION	6
PRODUCT SPECIFICATIONS	6
MATERIALS AND BASIC TOOLS NEEDED	7
Materials Needed	7
Basic Tools	7
Additional Tools Needed When Sweat Soldering	7
INSTALLATION INSTRUCTIONS	8-14
Removing the Old Water Heater	8
Facts to Consider About the Location	9
Insulation Blankets	9
Water Piping System	10
Piping Installation	10
Condensate Drain Line Installation	10
T & P Valve and Pipe Insulation	11
Temperature-Pressure Relief Valve	12
Filling the Water Heater	13
Wiring	13-14
Wiring Diagrams	14
INSTALLATION CHECKLIST	17-22
SERVICE AND ADJUSTMENT	17-22
Before Use	16
Temperature Regulation	16
Adjusting the User Interface Module/Operational Modes	16
Operating Mode Descriptions	17
Temperature-Pressure Relief Valve Operation	17-18
Draining and Flushing	18
Element Removal/Replacement	18-19
Routine Preventive Maintenance	19
Air Filter Cleaning/Maintenance	19
Inspection/Cleaning of the Condensate Drain Pan & Condensate Drain Lines	20
Drain Valve Washer Replacement	20
Service	20
TROUBLESHOOTING GUIDE	21-22
Start Up Conditions	21
Thermal Expansion	21
Strange Sounds	21
Operational Conditions	21-22
Powered Anode Rod Operation	21
“Air” in Hot Water Faucets	22
Rumbling Noise	22
High Temperature Shut Off System	22
DIAGNOSTIC CODES	23
TROUBLESHOOTING CHART	24
LEAKAGE CHECKPOINTS	25
REPAIR PARTS LIST	26
NOTES	27

INTRODUCTION

Thank You for purchasing a Sears water heater. Properly installed and maintained, it should give you years of trouble free service. It is strongly suggested that this new water heater be professionally installed, contact the local Sears Service Center or any Sears store. They will arrange for prompt, quality installation by Sears authorized contractors.

Abbreviations Found In This Instruction Manual:

UL – Underwriters Laboratories Inc.

NEC – National Electrical Code

ANSI – American National Standards Institute

- Read the *General Safety* section, page 3 of this manual first and then the entire manual carefully. If you don't follow the safety rules, the water heater will not operate properly. It could cause DEATH, SERIOUS BODILY INJURY AND/OR PROPERTY DAMAGE.

This manual contains instructions for the installation, operation, and maintenance of this electric water heater. It also contains warnings throughout the manual that you must read and be aware of. All warnings and all instructions are essential to the proper operation of the water heater and your safety. Since we cannot put everything on the first few pages, **READ THIS ENTIRE MANUAL BEFORE ATTEMPTING TO INSTALL OR OPERATE THE WATER HEATER.**

- The installation must conform with the instructions in this manual; electric company rules; and Local Codes, or in

the absence of Local Codes, with the current edition of the NEC - National Electrical Code, NFPA 70. This publication is available from your local government or public library or electric company or by writing Underwriters Laboratories Inc., 333 Pfingsten Road, Northbrook, IL 60062.

- If after reading this manual you have any questions or do not understand any portion of the instructions, call Sears Service Center.
- Carefully plan the place where you are going to put the water heater. Correct electrical wiring and connections are very important in preventing death from possible electrical shock and fires.

Examine the location to ensure the water heater complies with the *Facts to Consider About the Location* section.

For California installation, this water heater must be braced, anchored, or strapped to avoid falling or moving during an earthquake. See instructions for correct installation procedures. Instructions may be obtained from California's Office of the State Architect, 1102 Q Street, Suite 5100, Sacramento, CA95811. Instructions can also be downloaded to your computer at www.dsa.dgs.ca.gov/Pubs.

Massachusetts Code requires this water heater to be installed in accordance with Massachusetts 248-CMR 2.00; State Plumbing Code and 248-CMR 5.00. In the Commonwealth of Massachusetts, this product must be installed by a licensed plumber or gasfitter.

PRODUCT SPECIFICATIONS

The Kenmore Elite Hybrid Electric Water Heater is an integrated heat pump water heater unit, having an 850 Watt compressor and an external coil heat exchanger with backup electric elements. When in Efficiency Mode the heat pump draws heat from the ambient air in the room and transfers it to the water in the tank through the coil heat exchanger. While in Electric Mode the water heater functions like a standard electric water heater, relying on the electric elements to heat the water. A Hybrid Mode is available that relies primarily on the heat pump to heat the water while the electric elements only function during high demand periods. The more often the unit operates using the heat pump, rather than the elements, the more efficient the unit will be.

The large tank capacities of the Kenmore Elite Hybrid Electric Water Heaters are intended to take optimal advantage of the heat pump's capability to heat water for large families or those having higher than normal hot water requirements. The larger capacities enable the units to operate in the maximum efficiency mode more often than other models having lower capacities.

These Electric Heat Pump Water Heaters use about half the electricity of a comparably sized conventional electric water heater when operating in the Efficiency Mode and provide up to 1/2 ton cooling capacity and dehumidification. They are designed for indoor, residential applications for installation in a basement, garage or utility room.

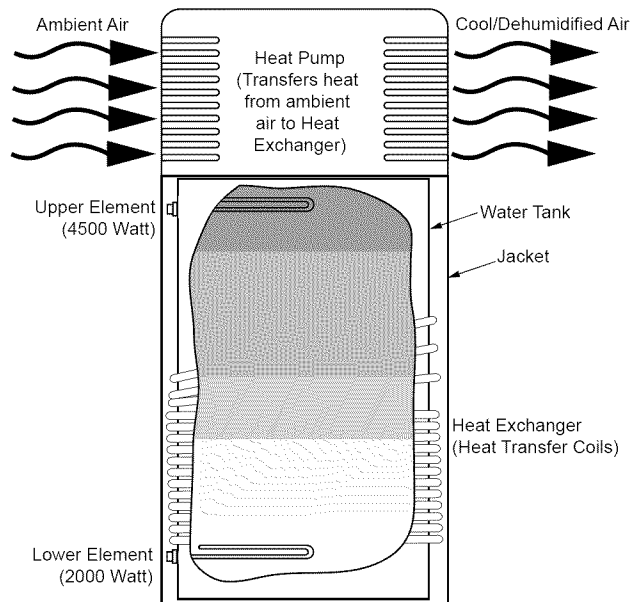

FIGURE 1.

MODEL NUMBER	TANK CAPACITY IN GALLONS	DIMENSIONS IN INCHES (mm)		RECOVERY RATE GALS. PER HOUR @ 90°F RISE	ELEMENT WATTAGE @ 240 VOLTS	MINIMUM WIRE SIZE* (GAUGE)	MINIMUM FUSE OR CIRCUIT BREAKER SIZE (AMPS)
		DIA.	HEIGHT				
153.321160	60	24 (610)	67.3 (1709)	20.7**	4500 Upper/2000 Lower	10 AWG	25
153.321180	80	24 (610)	80.9 (2055)	20.7**	4500 Upper/2000 Lower	10 AWG	25

* Wiring size based on standard 60°C copper wire. If distance from fuse box to water heater is more than 90 feet, refer to your local electrical code.

** Actual recovery will differ under Efficiency and Hybrid modes based upon ambient temperature, humidity, and other environmental factors.

MATERIALS AND BASIC TOOLS NEEDED

Materials Needed

To simplify the installation Sears has available the installation parts shown below. You may or may not need all of these materials, depending on your type of installation.

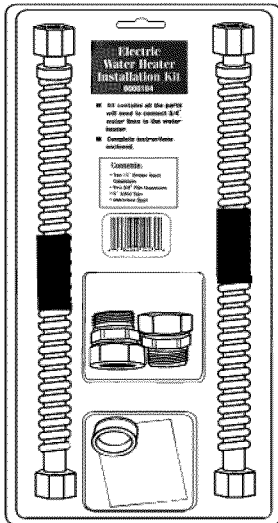

WATER HEATER INSTALLATION KIT WITH FLEXIBLE CONNECTORS FOR 3/4" THREADED OR COPPER PLUMBING.

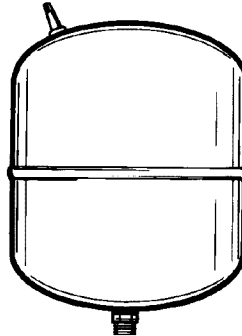

EXPANSION TANKS FOR THERMAL EXPANSION CONDITIONS AVAILABLE IN 2 GALLONS, AND 5 GALLONS CAPACITY THROUGH LOCAL SEARS STORE OR SERVICE CENTER.

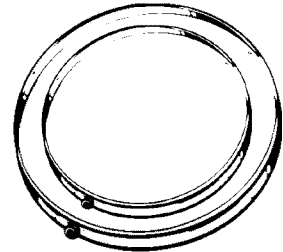

METAL DRAIN PANS AVAILABLE IN 20" DIAMETER FOR WATER HEATERS HAVING A DIAMETER 18" OR LESS AND IN 24" DIAMETER FOR WATER HEATERS HAVING A DIAMETER OF 22" OR LESS.

Basic Tools

You may or may not need all of these tools, depending on your type of installation. These tools can be purchased at your local Sears store.

- Pipe Wrench (2)
- Screwdriver
- 6 Foot Tape or Folding Rule
- Garden Hose
- Drill
- Pipe Dope or Teflon® Tape



ROLL OF TEFLON® TAPE (USE ON WATER CONNECTIONS)

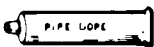

PIPE DOPE (SQUEEZE TUBE) USE FOR WATER CONNECTIONS



GARDEN HOSE



6 FOOT TAPE

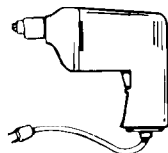

DRILL

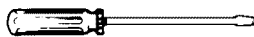

SLOT-HEAD SCREWDRIVER



PHILLIPS SCREWDRIVER



PIPE WRENCH

Additional Tools Needed When Sweat Soldering

- Tubing Cutters or Hacksaw
- Propane Torch
- Soft Solder
- Solder Flux
- Emery Cloth
- Wire Brushes



TUBING CUTTER

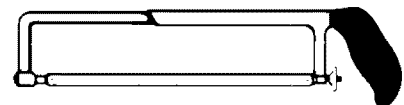

HACKSAW



PROPANE TORCH



ROLL OF EMERY CLOTH



ROLL OF LEAD-FREE SOFT SOLDER



SOLDER FLUX



3/4" (19 mm) WIRE BRUSH

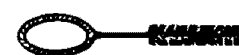

1/2" (13 mm) WIRE BRUSH

INSTALLATION INSTRUCTIONS

Removing the Old Water Heater

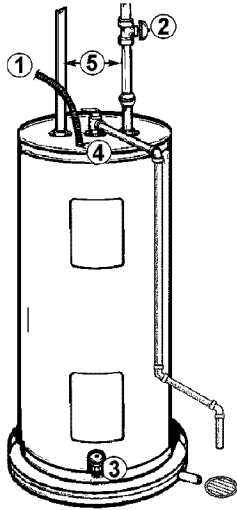

FIGURE 2.

1. Turn "OFF" electrical supply to the water heater.

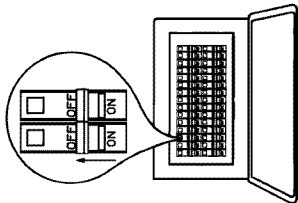

FIGURE 3.

2. Open a nearby hot water faucet until the water is no longer hot. When the water has cooled, turn "OFF" the water supply to the water heater at the water shut-off valve or water meter.



FIGURE 4.

3. Attach a hose to the water heater drain valve and put the other end in a floor drain or outdoors. Open the water drain valve. Open a nearby hot water faucet which will relieve pressure in the water heater and speed draining.

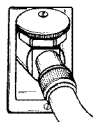

FIGURE 5.

▲ DANGER

- Burn hazard
- Hot water discharge.
- Keep hands clear of drain valve discharge.

The water passing out of the drain valve may be extremely hot. To avoid being scalded, make sure all connections are tight and that the water flow is directed away from any person.

4. Check again to make sure the electrical supply is turned "OFF" to the water heater. Then unplug the water heater (cord set) or disconnect the electrical supply connection from the water heater junction box.

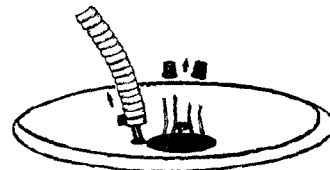

FIGURE 6.

- 5a. If you have copper piping to the water heater, the two copper water pipes can be cut with a hacksaw approximately four inches away from where they connect to the water heater. This will avoid cutting off the pipes too short. Additional cuts can be made later if necessary. Disconnect the temperature-pressure relief valve drain line. When the water heater is drained, disconnect the hose from the drain valve. Close the drain valve. The water heater is now completely disconnected and ready to be removed.

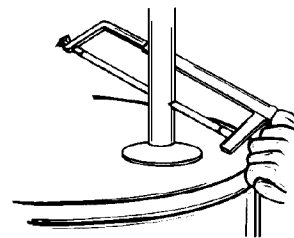

FIGURE 7.

- 5b. If you have galvanized pipe to the water heater, loosen the two galvanized pipes with a pipe wrench at the union in each line. Also disconnect the piping remaining to the water heater. These pieces should be saved since they may be needed when reconnecting the new water heater. Disconnect the temperature-pressure relief valve drain line. When the water heater is drained, disconnect the hose from the drain valve. Close the drain valve. The water heater is now completely disconnected and ready to be removed.

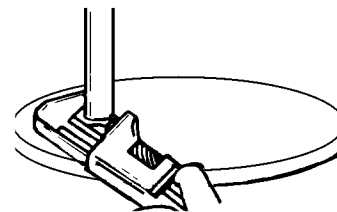

FIGURE 8.

CAUTION
Mineral Buildup or Sediment May Accumulate
<ul style="list-style-type: none"> • This causes the water heater to become much heavier than normal. • If spilled, could cause staining.

Mineral buildup or sediment may have accumulated in the old water heater. This causes the water heater to be much heavier than normal and this residue, if spilled out, could cause staining.

Facts to Consider About the Location

You should carefully choose an indoor location for the new water heater, because the placement is a very important consideration for the safety of the occupants in the building and for the most economical use of the appliance. **This water heater is not intended for outdoor installation.**

Whether replacing an old water heater or putting the water heater in a new location, the following critical points must be observed.

Select a location near the center of the water piping system. The unit must be installed indoors and in a vertical position on a level surface. The flooring beneath the water heater must be able to support the weight of the water heater when filled with water (See Table 1).

IMPORTANT: The water heater must be located in a space 750 cubic feet or larger, and must have unrestricted airflow. As an example, a room that has an 8 foot tall ceiling and is 10 feet long by 9-1/2 feet wide would contain 760 cubic feet.

NOTE: For optimal efficiency and serviceability, the following clearances should be maintained: 3 feet on the air inlet side, 5 feet on the air outlet side, 6 inches in the back, 4 inches above, and 2 feet in the front.

The water heater should be located in an area not subject to freezing temperatures. Water heaters located in unconditioned spaces (i.e., garages, basements, etc.) may require the water piping, condensate piping, and drain piping to be insulated to shelter against freezing. The drain and controls must be easily accessible for operation and service.

The site location must be free from any corrosive elements in the atmosphere such as sulfur, fluorine, and chlorine. These elements are found in aerosol sprays, detergents, bleaches, cleaning solvents, air fresheners, paint, and varnish removers, refrigerants, and many other commercial and household products. In addition, excessive dust and lint may affect the operation of the unit (See "Cleaning the Filter" section).

The ambient air temperature must also be considered when installing this unit. In Efficiency Mode the ambient air temperature must be above 45°F and below 109°F. If the ambient air temperature falls outside these upper and lower limits the electrical elements will activate to meet the hot water demand and the heat pump does not operate.

NOTE: Local codes and requirements in your area may require the installation of your water heater be accomplished in a way that the bottom element is elevated from the floor at least 18 inches. Ensure that a platform capable of supporting the combined weight of the water heater and water is used. Reference Table 1.

TABLE 1.	
Capacity	Weight (filled with water)
60 Gallon	760 lbs
80 Gallon	967 lbs

- This water heater, as well as all water heaters, will eventually leak. Do not install without adequate drainage provisions so water flow will not cause damage.

CAUTION
Property Damage Hazard
<ul style="list-style-type: none"> • All water heaters eventually leak • Do not install without adequate drainage.

WATER HEATERS EVENTUALLY LEAK: Installation of the water heater must be accomplished in such a manner that if the tank or any connections should leak, the flow of water will not cause damage to the structure. When such locations cannot be avoided, a suitable metal drain pan should be installed under the water heater. Drain pans are available at your local Sears stores. Such drain pans must be piped to an adequate drain.

Water heater life depends upon water quality, water pressure and the environment in which the water heater is installed. Water heaters are sometimes installed in locations where leakage may result in property damage, even with the use of a metal drain pan piped to a drain. However, unanticipated damage can be reduced or prevented by a leak detector or water shut-off device used in conjunction with a piped metal drain pan. These devices are available from some plumbing supply wholesalers and retailers, and detect and react to leakage in various ways:

- Sensors mounted in the metal drain pan that trigger an alarm or turn off the incoming water to the water heater when leakage is detected.
- Sensors mounted in the metal drain pan that turn off the water supply to the entire home when water is detected in the drain pan.
- Water supply shut-off devices that activate based on the water pressure differential between the cold water and hot water pipes connected to the water heater.

CAUTION
Installations in Residential Garages
<ul style="list-style-type: none"> • Water heater must be located in a protective area.

INSTALLATION IN RESIDENTIAL GARAGES: The water heater must be located and/or protected so it is not subject to physical damage by a moving vehicle.

- The location selection must provide adequate clearances for servicing and proper operation of the water heater.

Insulation Blankets

The use of an insulation blanket on this water heater is not needed or recommended. The purpose of an insulation blanket is to reduce the standby heat loss encountered with storage tank heaters. Your water heater meets or exceeds the National Appliance Energy Conservation Act standards with respect to insulation and standby loss requirements, making an insulation blanket unnecessary.

Water Piping System

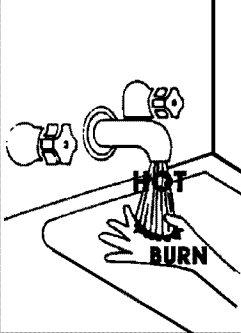

Water temperature over 125°F (52°C) can cause severe burns instantly resulting in severe injury or death.

Children, the elderly, and the physically or mentally disabled are at highest risk for scald injury.

Feel water before bathing or showering.

Temperature limiting valves are available.

Read instruction manual for safe temperature setting.

Piping, fittings, and valves should be installed according to the installation drawing (Figure 9). If the indoor installation area is subject to freezing temperatures, the water piping must be properly insulated.

The water supply pressure should not exceed 80 psi. If this occurs, a pressure reducing valve with a bypass should be installed in the cold water inlet line. This should be placed on the supply to the entire house in order to maintain equal hot and cold water pressures.

IMPORTANT:

- **Heat must not be applied to the water fittings on the heater as they may contain nonmetallic parts. If solder connections are used, solder the pipe to the adapter before attaching the adapter to the hot and cold water fittings.**
 - Always use a good grade of joint compound and be certain that all fittings are tight.
- IMPORTANT:** DO NOT over apply joint compound.

Piping Installation

NOTE: To protect against untimely corrosion of hot and cold water fittings, it is strongly recommended that di-electric unions or couplings be installed on this water heater when connected to copper pipe.

1. Install the water piping and fittings as shown in Figure 9. Connect the cold water supply (3/4" NPT) to the fitting marked "Cold". Connect the hot water supply (3/4" NPT) to the fitting marked "Hot".
2. The installation of unions in both the hot and cold water supply lines are recommended for ease of removing the water heater for service or replacement.
3. Some local codes may require, and the manufacturer of this water heater recommends, installing a mixing valve or an anti-scald device in the domestic hot water line as shown in Figure 9. These valves reduce the point-of-use temperature of the hot water by mixing cold and hot water and are readily available. Contact a licensed plumber or the local plumbing authority for more information.
4. Some local codes may require, and the manufacturer of this water heater recommends, installing a pressure reducing valve (PRV) in the cold water inlet line where it enters the residence as shown in Figure 9.
5. If installing the water heater in a closed water system, install an expansion tank in the cold water line as specified under "Closed System/Thermal Expansion."
6. Install a shut off valve in the cold water inlet line. It should be located close to the water heater and be easily accessible. Know the location of this valve and how to shut off the water to the heater.
7. Install a discharge line from the temperature and pressure relief valve in the opening marked "T & P RELIEF VALVE". See Figure 10 and the "Temperature and Pressure Relief Valve" section.)

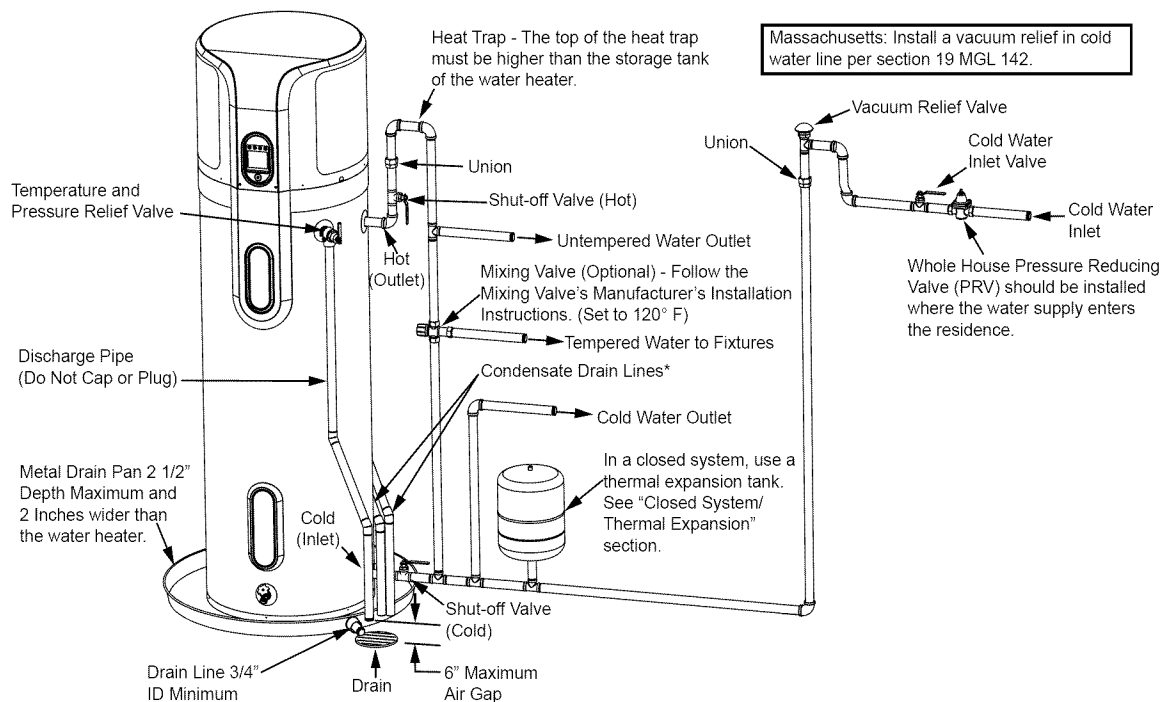

* If an adequate drain is not available for the condensate drain lines then a condensate pump should be used. DO NOT discharge the condensate drain lines into the metal drain pan.

FIGURE 9.

8. After piping has been properly connected to the water heater, open the nearest hot water faucet. Then open the cold water shut off valve and allow the tank to completely fill with water. To purge the lines of any excess air and sediment, keep the hot water faucet open for 3 minutes after a constant flow of water is obtained. Close the faucet and check all connections for leaks.

Please note the following:

- The system should be installed only with piping that is suitable for potable (drinkable) water such as copper, CPVC, or polybutylene. This water heater must not be installed using iron piping or PVC water piping.
- Use only pumps, valves, or fittings that are compatible with potable water.
- Use only full flow ball or gate valves. The use of valves that may cause excessive restriction to water flow is not recommended.
- Use only 95/5 tin-antimony or other equivalent solder. Any lead based solder must not be used.
- Piping that has been treated with chromates, boiler seal, or other chemicals must not be used.
- Chemicals that may contaminate the potable water supply must not be added to the piping system.

CAUTION
Property Damage Hazard
<ul style="list-style-type: none"> • Avoid water heater damage. • Install thermal expansion tank if necessary. • Do not apply heat to cold water inlet. • Contact qualified installer or service agency.

Condensate Drain Line Installation

Install two 1/2" PVC discharge lines from the condensate drains (located on the right side near the back). The lines should terminate a maximum of six inches above an adequate drain. Do not discharge the condensate drain lines into the metal drain pan. If no floor drain is available or the drain is above the level of the condensate line, a condensate pump should be installed. These pumps are available from local distributors.

When installing the drain line, note the following:

- Plastic pipe or tubing must be used to connect the condensate drain to a suitable drain or condensate pump.
- Condensate drain lines should be installed in conditioned areas only. Install approved insulation on the condensate drain lines to prevent condensation from forming on the outside of the drain lines. Condensation drain lines installed in areas that are subject to freezing temperatures should be wrapped with a nationally recognized/listed heat tape. Install per manufacturer's instructions.
- Do not connect condensate drain lines with other drain or discharge lines into a single (common) pipe or line. Each line (condensate drain line, temperature and pressure relief valve discharge pipe, etc) should be independently run to an adequate drain.

- Slope the condensate drain lines toward the inside floor drain or condensate pump.
- The condensate drain lines and connections to the drain piping must comply with all local codes.
- Use appropriate primer and glue to cement the condensate drain lines to the heat pump drain pan. **NOTE:** The heat pump drain pan is ABS and the two condensate drain pipes should be PVC.
- If a condensate pump is installed it should shut off the heat pump in the event the condensate pump fails or the float switch in the pump activates (See "Condensate Pump Installation" section.)

T & P Valve and Pipe Insulation

NOTE: Your water heater is insulated to minimize heat loss from the tank. Further reduction in heat loss can be accomplished by insulating the hot water lines from the water heater.

1. Locate the temperature and pressure relief valve on the water heater (also known as a T&P relief valve). See Figure 10.
2. Locate the slit running the length of the T&P relief valve insulation.
3. Spread the slit open and fit the insulation over the T&P relief valve. See Figure 10. Apply gentle pressure to the insulation to ensure that it is fully seated on the T&P Relief Valve. Once seated, secure the insulation with duct tape, electrical tape, or equivalent. **IMPORTANT:** The insulation and tape must not block the discharge opening or hinder access to the manual relief lever (Figure 10). Ensure a discharge pipe is installed into the T&P valve discharge opening per the instructions in this manual.
4. Locate the hot water (outlet) & cold water (inlet) pipes to the water heater.
5. Locate the slit running the length of a section of pipe insulation.
6. Spread the slit open and slip the insulation over the cold water (inlet) pipe. Apply gentle pressure along the length of the insulation to ensure that it is fully seated around the pipe. Also, ensure that the base of the insulation is flush with the water heater. Once seated, secure the insulation with duct tape, electrical tape, or equivalent.
7. Repeat steps 5 and 6 for the hot water (outlet) pipe.
8. Add additional sections of pipe insulation as needed.

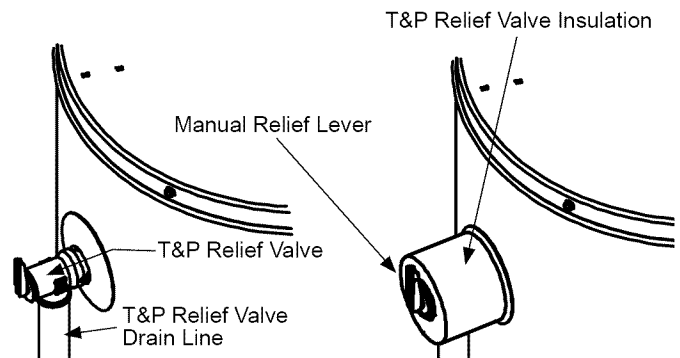
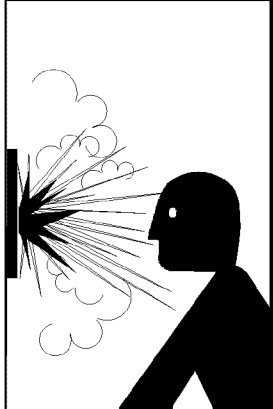

FIGURE 10.

Temperature-Pressure Relief Valve

	<h3>⚠ WARNING</h3>
	<h4>Explosion Hazard</h4> <ul style="list-style-type: none"> • Temperature-pressure relief valve must comply with ANSI Z21.22 CSA 4.4 and ASME code. • Properly sized temperature-relief valve must be installed in opening provided. • Can result in overheating and excessive tank pressure. • Can cause serious injury or death.

This heater is provided with a properly certified combination temperature - pressure relief valve by the manufacturer.

The valve is certified by a nationally recognized testing laboratory that maintains periodic inspection of production of listed equipment of materials as meeting the requirements for Relief Valves for Hot Water Supply Systems, ANSI Z21.22 • CSA 4.4, and the code requirements of ASME.

If replaced, the valve must meet the requirements of local codes, but not less than a combination temperature and pressure relief valve certified as indicated in the above paragraph.

The valve must be marked with a maximum set pressure not to exceed the marked hydrostatic working pressure of the water heater (150 psi = 1,035 kPa) and a discharge capacity not less than the water heater input rate as shown on the model rating plate. (For electric heaters, watts x 3.412 equals Btu/hr input rate)

For safe operation of the water heater, the relief valve must not be removed from its designated opening nor plugged.

The temperature-pressure relief valve must be installed directly into the fitting of the water heater designed for the relief valve. Position the valve downward and provide tubing so that any discharge will exit only within 6 inches (153 mm) above, or at any distance below the structural floor. Be certain that no contact is made with any live electrical part. The discharge opening must not be blocked or reduced in size under any circumstances. Excessive length, over 30 feet (9.14 m), or use of more than four elbows can cause restriction and reduce the discharge capacity of the valve.

<h3>CAUTION</h3>
<h4>Water Damage Hazard</h4>
<ul style="list-style-type: none"> • Temperature-pressure relief valve discharge pipe must terminate at adequate drain.

No valve or other obstruction is to be placed between the relief valve and the tank. Do not connect tubing directly to discharge drain unless a 6 inch air gap is provided. To prevent bodily injury, hazard to life, or property damage, the relief valve must be allowed to discharge water in quantities should circumstances demand. If the discharge pipe is not connected to a drain or other suitable means, the water flow may cause property damage.

The Discharge Pipe:

- Shall not be smaller in size than the outlet pipe size of the valve, or have any reducing couplings or other restrictions.
- Shall not be plugged or blocked.
- Shall be of material listed for hot water distribution.
- Shall be installed so as to allow complete drainage of both the temperature-pressure relief valve, and the discharge pipe.
- Shall terminate a maximum of six inches above a floor drain or external to the building. In cold climates, it is recommended that the discharge pipe be terminated at an adequate drain inside the building.
- Shall not have any valve between the relief valve and tank.

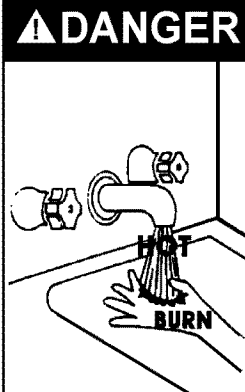
	<h3>⚠ DANGER</h3> <p>Water temperature over 125°F (52°C) can cause severe burns instantly resulting in severe injury or death.</p> <p>Children, the elderly, and the physically or mentally disabled are at highest risk for scald injury.</p> <p>Feel water before bathing or showering.</p> <p>Temperature limiting valves are available.</p> <p>Read instruction manual for safe temperature setting.</p>
--	--

The temperature-pressure relief valve must be manually operated at least once a year. Caution should be taken to ensure that (1) no one is in front of or around the outlet of the temperature-pressure relief valve discharge line, and (2) the water manually discharged will not cause any bodily injury or property damage because the water may be extremely hot.

If after manually operating the valve, it fails to completely reset and continues to release water, immediately close the cold water inlet to the water heater, follow the draining instructions, and replace the temperature-pressure relief valve with a new one.

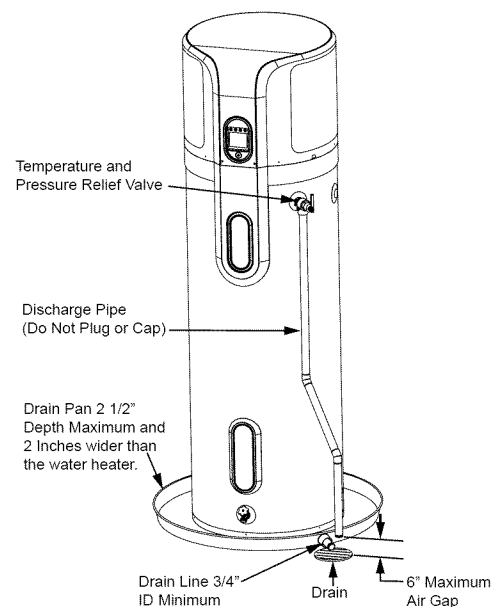

FIGURE 11.

Filling the Water Heater

CAUTION
Property Damage Hazard
<ul style="list-style-type: none">• Avoid water heater damage.• Fill tank with water before operating.

Never use this water heater unless it is completely full of water. To prevent damage to the tank and heating element, the tank must be filled with water. Water must flow from the hot water faucet before turning "ON" power.

To fill the water heater with water:

1. Close the water heater drain valve by turning the handle to the right (clockwise). The drain valve is located on the lower front of the water heater.
2. Open the cold water supply valve to the water heater.

NOTE: The cold water supply valve must be left open when the water heater is in use.

3. To ensure complete filling of the tank, allow air to exit by opening the nearest hot water faucet. Allow water to run until a constant flow is obtained. This will let air out of the water heater and the piping.
4. Check all new water piping for leaks. Repair as needed.

Wiring

You must provide all wiring of the proper size outside of the water heater. You must obey local codes and electric company requirements when you install this wiring.

If you are not familiar with electric codes and practices, or if you have any doubt, even the slightest doubt, in your ability to connect the wiring to this water heater, obtain the service of a competent electrician. Contact your Sears salesperson to arrange for a professional electrician.

WATER HEATERS EQUIPPED FOR ONE VOLTAGE ONLY: This water heater is equipped for one type voltage only. Check the rating plate for the correct voltage. **DO NOT** use this water heater with any voltage other than the one shown on the model rating plate. Failure to use the correct voltage can cause problems which can result in **DEATH, SERIOUS BODILY INJURY, OR PROPERTY DAMAGE.** If you have any questions or doubts consult your electric company.

⚠ WARNING	
Fire Hazard / Electric Shock Hazard	
	<ul style="list-style-type: none">• Do not use this water heater with any voltage other than shown on the model rating plate.• Failure to use the correct voltage shown on the model rating plate could result in death, serious bodily injury, or property damage.

If wiring from your fuse box or circuit breaker box was aluminum for your old water heater, replace it with copper wire. If you wish to reuse the existing aluminum wire, have the connection at the water heater made by a competent electrician. Contact your Sears salesperson to arrange for a professional electrician.

1. Provide a way to easily shut off the electric power when working on the water heater. This could be with a circuit breaker or fuse block in the entrance box or a separate disconnect switch.
2. Install and connect a circuit directly from the main fuse or circuit breaker box. This circuit must be the right size and have its own fuse or circuit breaker. Refer to the chart in the *Product Specifications* section for the correct size wire and fuse or circuit breaker.
3. If metal conduit is used for the grounding conductor:
 - a. The grounding electrode conductor shall be of copper, aluminum, or copperclad aluminum. The material shall be of one continuous length without a splice or joint.
 - b. Rigid metal conduit, intermediate metal conduit, or electrical metallic tubing may be used for the grounding means if conduit or tubing is terminated in fittings approved for grounding.
 - c. Flexible metal conduit or flexible metallic tubing shall be permitted for grounding if all the following conditions are met:
 - The length in any ground return path does not exceed 6 feet.
 - The circuit conductors contained therein are protected by overcurrent devices rated at 20 amperes or less.
 - The conduit or tubing is terminated in fittings approved for grounding.

For complete grounding details and all allowable exceptions, refer to the current edition of the NEC - National Electrical Code NFPA 70.

Figures 13 & 14 are provided as reference drawings. Always reference the wiring diagram located on the water heater for the correct electrical connections and connect the electrical supply to the water heater in accordance with local utility requirements and codes.

When installing the electrical wiring to the water heater:

4. Although this water heater is equipped with "Dry Fire" protection circuitry, be sure tank is completely filled with water, and all air is purged from the tank before making any electrical connections. See "Draining and Flushing Section".
5. Turn off power to the electrical wiring for the water heater at the circuit breaker/fuse box.
6. Remove the left louvered access panel (when facing the water heater) by loosening the screws securing it to the water heater.
7. Loosen and set aside the screws securing the electrical junction box cover to the water heater.

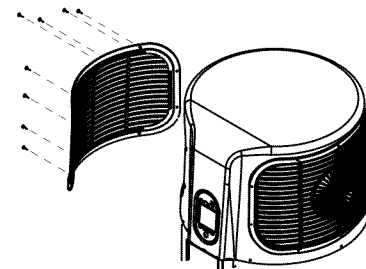

FIGURE 12.

8. Connect the electrical supply to the water heater.
NOTE: Remove the standard 1/2 inch knock-out (opening) in the junction box for conduit connections.
9. Connect ground wire to green ground wire in the electrical junction box of the water heater.
10. Reinstall the junction box cover.
11. Reattach the left louvered access panel to the water heater and secure it using the screws loosened earlier.
12. Turn on electrical power to the water heater.
13. Press the power button to turn the water heater on, then press the Efficiency button to set the operating mode.
NOTE: The water heater will conduct a system diagnostic (approximately 8 minutes) prior to operation.
14. Once the diagnostic sequence has finished, the fan should turn on followed by the compressor.
NOTE: The heat pump's fan will not turn on if the incoming water temperature is less than 59 °F and/or the ambient air temperature is above 109 °F or below 45 °F. Should the internal diagnostics detect a problem with the heat pump, an error message will be displayed.
15. Set the operational mode. For typical installation, the Hybrid Mode offers the best combination of efficiency and hot water delivery. For detailed descriptions of all operational modes see "Adjusting the User Interface Module/Operational Modes" section.

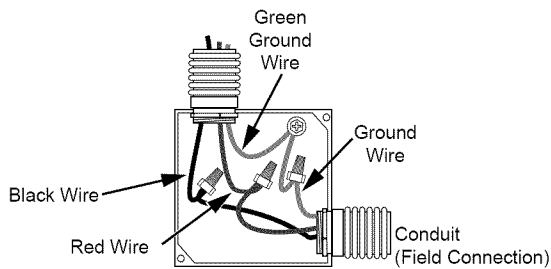

FIGURE 13.

Wiring Diagram

⚠ WARNING

- Before removing any access panels or servicing the water heater, make sure the electrical supply to the water heater is turned "OFF".
- Failure to do this could result in death, serious bodily injury, or property damage.

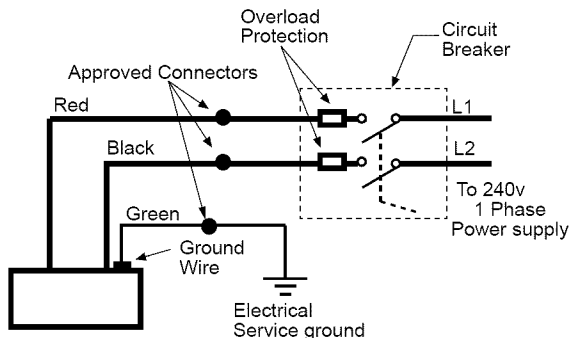

FIGURE 14.

Connecting the Condensate Pump Overflow Shut Off Switch

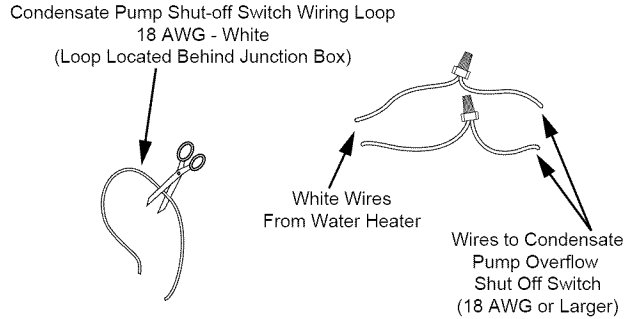

FIGURE 15.

1. Turn off power to the electrical wiring for the water heater at the circuit breaker/fuse box.
2. Locate the white 18 AWG wire loop behind the field wiring junction box. See Figure 15.
3. Cut the loop and strip insulation off of the two ends. See Figure 15.
4. Measure the distance from the field wiring junction box to the condensate pump, and cut two 18 AWG or larger wires to correct length and strip the insulation at both ends of each wire. See Figure 15.
5. Connect these two wires to the two wires on the water heater using wire nuts or other connectors.
6. Connect the free ends of the two wires to the shut off switch on the condensate pump in accordance with the manufacturers recommendations.
7. Turn on electrical power to the water heater.
8. Press the power button to turn the water heater on and select the desired operational mode. After about 8 minutes, the heat pump will turn on.
9. Test the operation of the shut off switch by unplugging the condensate pump and filling the condensate reservoir with water until the float switch opens the circuit.
10. The heat pump should turn off and the error code "HEAT PUMP FAULT" will appear on the user interface screen.
11. Plug the condensate pump in and verify that the pump operates and pumps the water out of the condensate reservoir.
12. The error on the user interface should clear and the heat pump should operate after 8 minutes.

INSTALLATION CHECKLIST

Water Heater Location

- Centrally located with the water piping system.
- The flooring beneath the water heater must be able to support the weight of the water heater when filled with water (See Table 1).
- Located indoors (such as a basement or garage) and in a vertical position. Sheltered from freezing temperatures.
- Provisions made to shelter the area from water damage. Metal drain pan installed and piped to an adequate drain.
- Sufficient room to service the water heater.
- Sufficient air for the heat pump to function. The water heater must be located in a space 750 cubic feet or larger, and must have unrestricted airflow. As an example, a room that has an 8 foot tall ceiling and is 10 feet long by 9-1/2 feet wide would contain 760 cubic feet.
NOTE: For optimal efficiency and serviceability, the following clearances should be maintained: 3 feet on the air inlet side, 5 feet on the air outlet side, 6 inches in the back, and 2 feet in the front.
- The unit cannot be placed into any type of closet or small enclosure.
- The site location must be free from any corrosive elements in the atmosphere such as sulfur, fluorine, and chlorine. These elements are found in aerosol sprays, detergents, bleaches, cleaning solvents, air fresheners, paint, and varnish removers, refrigerants, and many other commercial and household products. In addition excessive dust and lint may affect the operation of the unit and require more frequent cleaning (See "Routine Preventive Maintenance" section).
- Ambient air temperature must be above 45°F and below 109°F. If the ambient air temperature falls outside these upper and lower limits the electrical elements will activate to meet the hot water demand.

Water System Piping

- Temperature and pressure relief valve properly installed with a discharge pipe run to an adequate drain and sheltered from freezing (See Figure 10).
- All piping properly installed and free of leaks.
- Heater completely filled with water (See "Water Piping System" section).
- Closed system pressure buildup precautions installed (See "Closed System/Thermal Expansion" section).
- Mixing valve (when applicable) installed per manufacturer's instructions (See "Temperature Regulation" section).

Condensate Drain Line

- Must be located with access to an adequate drain or condensate pump.
- Condensate drain lines installed and piped to an adequate drain or condensate pump (See Figure 9).

Electrical Connections

- This water heater requires a 240 VAC single phase 25 amp power supply. DO NOT use a 208 VAC service.
- Wiring size and connections comply with all applicable codes or in the absence of local or state codes follow NFPA-70, the National Electrical Code-current edition.
- Water heater and electrical supply are properly grounded.
- Wiring enclosed in approved conduit (if required by local codes).
- Proper overload fuse or circuit breaker protection installed.

Post Installation Review

- Understand how to use the User Interface Module to set the various modes and functions (See "Adjusting the User Interface Module/Operating Modes" section).
- Hybrid Mode is the recommended Operating Mode. Understand the various Operating Modes and which mode may be best based on season, ambient temperature, and usage (See "Operating Mode Description" section).
NOTE: It may be necessary to temporarily change modes if for example filling a spa or hot tub.
- Understand the importance of routine inspection/maintenance of the condensate drain pan and lines (See "Inspection/Cleaning of the Condensate Drain Pan & Condensate Drain Lines" section). This is to help prevent any possible drain line blockage resulting in the condensate drain pan overflowing.
IMPORTANT: Water coming from the plastic shroud is an indicator that both condensation drain lines may be blocked. Immediate action is required.
- To maintain optimal operation check, remove and clean the air filter (See "Air Filter Cleaning/Replacement" section).
- The Installation Instructions and Use & Care Guide should be kept with the water heater for reference.

SERVICE AND ADJUSTMENT

Before Using

1. Make sure the water heater has been properly installed. See "Installing Your Water Heater" section.
2. Make sure the air filter is correctly seated, as it may shift during shipping or installation. See "Repair Parts Illustration" section.
3. Completely fill the tank with water (See "Water Piping" section).
4. After the water heater tank is completely filled with water, connect electrical power to the water heater.
5. Read the "Water Temperature Regulation" section of this manual. If you do not fully understand these instruction, contact a qualified person.
6. Press the power button (See Figure 16) to turn the water heater on and allow it to run a system diagnostic check. This typically takes eight minutes. Once complete, proceed to the next step.
NOTE: If the system diagnostic check yields any codes, reference the Diagnostic Code section in this manual.
7. Adjust the thermostat to the desired temperature setting as described under "Adjusting the User Interface Module/Operational Modes" section.

IMPORTANT: Do not attempt to operate this water heater if the unit has been submerged, subjected to flooding, or surrounding insulation has been exposed to water in any way.

Do not attempt to repair a unit subjected to flood conditions. Water heaters subjected to flood conditions or any time the unit has been submerged in water require replacement of the entire water heater.

Temperature Regulation

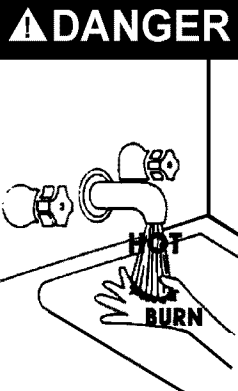

▲ DANGER Water temperature over 125°F (52°C) can cause severe burns instantly resulting in severe injury or death.

Children, the elderly, and the physically or mentally disabled are at highest risk for scald injury.

Feel water before bathing or showering.

Temperature limiting valves are available.

Read instruction manual for safe temperature setting.

HOTTER WATER CAN SCALD: Water heaters are intended to produce hot water. Water heated to a temperature which will satisfy clothes washing, dish washing, and other sanitizing needs can scald and permanently injure you upon contact. Some people are more likely to be permanently injured by hot water than others. These include the elderly, children, the infirm, or physically/mentally handicapped. If anyone using hot water in your home fits into one of these groups or if there is a local code

or state law requiring a certain temperature water at the hot water tap, then you must take special precautions. In addition to using the lowest possible temperature setting that satisfies your hot water needs, some type of tempering device, such as a mixing valve, should be used at the hot water taps used by these people or at the water heater. Mixing valves are available at plumbing supply or hardware stores. Follow manufacturers instructions for installation of the valves, Before changing the factory setting of the thermostat see Temperature Settings table at right.

Never allow small children to use a hot water tap, or to draw their own bath water. Never leave a child or handicapped person unattended in a bathtub or shower.

The water heater is adjusted to a temperature setting of no higher than 120°F when it is shipped from the factory. Water temperature can be regulated by adjusting the User Interface Module to the preferred setting as shown in "Adjusting the User Interface Module/Operational Mode" The preferred starting point is 120°F. There is a hot water scald potential if the temperature set point is set too high.

IMPORTANT: Adjusting the set point above 120°F on the User Interface Module will increase the risk of scald injury in the times shown below.



TABLE 2: WATER TEMPERATURES

Water Temperature °F	Time for 1st Degree Burn (Less Severe Burns)	Time for Permanent Burns 2nd & 3rd Degree (Most Severe Burns)
110	(normal shower temp.)	
116	(pain threshold)	
116	35 minutes	45 minutes
122	1 minute	5 minutes
131	5 seconds	25 seconds
140	2 seconds	5 seconds
149	1 second	2 seconds
154	instantaneous	1 second

(U.S. Government Memorandum, C.P.S.C., Peter L. Armstrong, Sept. 15,1978)

NOTE: Water temperature range of 120°—140°F (49°-60°C) recommended by most dishwasher manufacturers.

Adjusting the User Interface Module/Operational Modes

The water temperature setting can be adjusted from 95°F to 150°F. Use the Up and Down Buttons   on the front panel to set the desired temperature.

NOTE: The temperatures displayed on the User Interface are approximates. The actual temperature of the heated water may vary.

IMPORTANT: Before attempting to adjust the thermostat, read the "Water Temperature Regulation" section. If the instructions are not clear, contact a qualified person.

IMPORTANT: Filling a spa or hot tub from this water heater may result in extended recovery/re-heat time. Hybrid mode will provide the shortest recovery.

Operating Mode Descriptions

The operating modes can be changed by touching the desired mode icon on the User Interface Module (see Figure 16.)
NOTE: All buttons on the User Interface are touch sensitive and require only a light touch to actuate.



Hybrid Mode - This is the default, recommended setting. Combining high energy efficiency with reduced recovery time, this mode uses the heat pump as the primary heating source. The heating element will heat water if demand exceeds a predetermined level so that the set point temperature can be recovered more quickly.



Efficiency Mode - Is the most energy efficient mode. This mode uses the heat pump to heat water in the tank. The elements are not used unless the ambient operating temperature is below 45°F or above 109°F. If hot water demands are not met in Efficiency Mode it may be necessary to switch to Hybrid Mode.



Electric Mode - The water heater functions as a conventional electric unit, relying totally on the elements to heat the water in the tank. This mode may be useful in winter to eliminate the output of cold air from the unit.



Vacation Mode - The controller adjusts the water temperature to approximately 60°F. This mode is recommended when the water heater is not in use for a long period of time. This mode effectively turns the controller temperature setting down to a temperature that prevents the water in the water heater from freezing while still conserving energy.
NOTE: To activate the Vacation Mode touch the vacation button. To deactivate Vacation Mode touch the vacation button. **IMPORTANT:** The anode protecting the tank requires power to the unit to operate. Do not shut off power to the unit for extended periods of time. If power must be turned off for an extended period of time, drain the tank completely.



Lock - Holding this button for more than 3 seconds switches the lock mode on or off. When the User Interface Module is locked a symbol and "Lock" text will be visible on the display (see Figure 16).



°F/°C - The button switches the display to show the set temperature in Fahrenheit or Celsius.

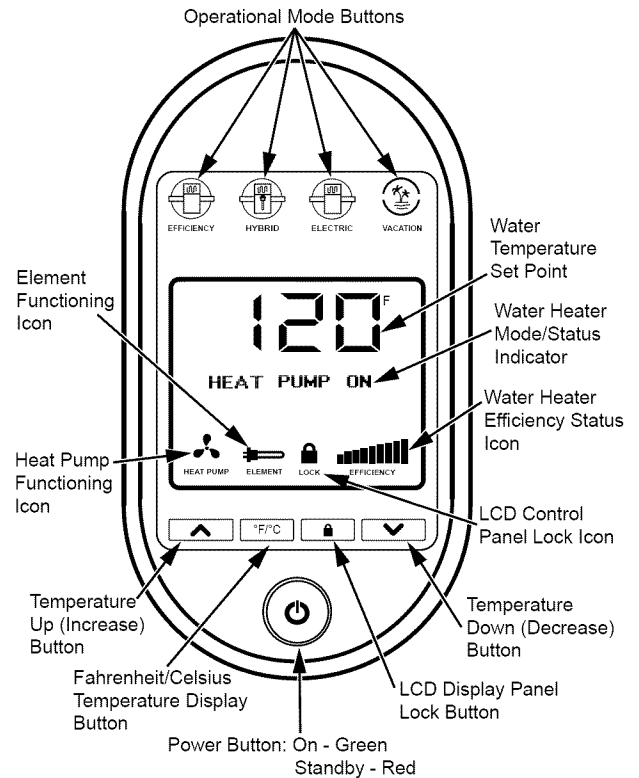
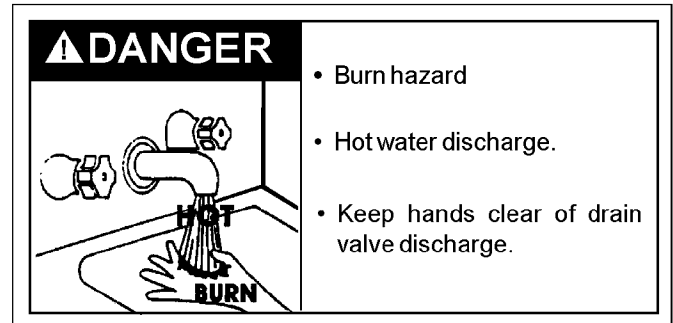

FIGURE 16.

Temperature-Pressure Relief Valve Operation

The temperature-pressure relief valve must be manually operated at least once a year.



The temperature-pressure relief valve must be manually operated at least once a year. Caution should be taken to ensure that (1) no one is in front of or around the outlet of the temperature-pressure relief valve discharge line, and (2) the water manually discharged will not cause any property damage or bodily injury. The water may be extremely hot.

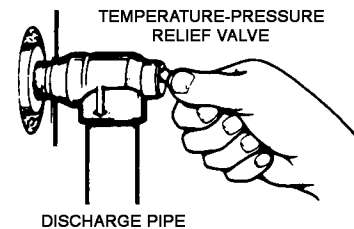

FIGURE 17.

If after manually operating the valve, it fails to completely reset and continues to release water, immediately close the cold water inlet to the water heater, follow the draining instructions, and replace the temperature-pressure relief valve with a new one.

Failure to install and maintain a new properly listed temperature-pressure relief valve will release the manufacturer from any claim which might result from excessive temperature or pressure.

If the temperature-pressure relief valve on the appliance weeps or discharges periodically, this may be due to thermal expansion. Your water heater may have a check valve installed in the water line or a water meter with a check valve. Consult your local Sears Service Center for further information. Do not plug the temperature-pressure relief valve.

Draining and Flushing

⚠ DANGER	<ul style="list-style-type: none"> • Burn hazard • Hot water discharge. • Keep hands clear of drain valve discharge.

It is recommended that the tank be drained and flushed every 6 months to remove sediment which may build up during operation. The water heater should be drained if being shut down during freezing temperatures.

To drain the tank, perform the following steps:

⚠ WARNING	<ul style="list-style-type: none"> • Before removing any access panels or servicing the water heater, make sure the electrical supply to the water heater is turned "OFF". • Failure to do this could result in death, serious bodily injury, or property damage.

1. Place the water heater in Standby Mode by pressing the power button on the user interface module.
2. Turn off the power to the water heater at the circuit breaker/fuse box.
3. Open a nearby hot water faucet until the water is no longer hot.

4. Close the cold water inlet valve.
5. Connect a hose to the drain valve and terminate it to an adequate drain or external to the building.
6. Open the water heater drain valve and allow all of the water to drain from the tank. Flush the tank with water as needed to remove sediment.
7. Close the drain valve, refill the tank (open the cold water inlet valve), and restart the heater as directed in this manual. **IMPORTANT:** Do not turn on power to the water heater unless it is completely filled with water. To ensure that the tank is full, open a hot water faucet and allow the water to run until the air is purged and the water flows uninterrupted from the faucet.
8. Press the power button to turn the water heater on. **NOTE:** The water heater will conduct a system diagnostic prior to operation.

If the water heater is going to be shut down for an extended period, the drain valve should be left open.

CAUTION
Improper installation and use may result in property damage.
<ul style="list-style-type: none"> • Fill tank with water before operation.

Never use this water heater unless it is completely full of water. To prevent damage to the tank and heating element, the tank must be filled with water. Water must flow from the hot water faucet before turning "ON" power.

Element Removal/Replacement

⚠ WARNING	<ul style="list-style-type: none"> • Before removing any access panels or servicing the water heater, make sure the electrical supply to the water heater is turned "OFF". • Failure to do this could result in death, serious bodily injury, or property damage.

Replacement heating elements must be of the same style and voltage/wattage rating as the ones originally in the water heater. This information can be found on the flange or terminal block of the element or on the water heater data plate.

IMPORTANT: Before replacing any element confirm that you have the correct replacement element (wattage). This water heater has a 4500 watt upper element and a 2000 watt lower element. DO NOT replace the element(s) with a wattage different than the ones specified for the upper and/or lower element.

IMPORTANT: Using an element greater than 2000 watts in place of the lower element will damage the water heater.

1. Press the power button on the user interface module to place the water heater in Standby Mode.
2. Turn off the power to the water heater.

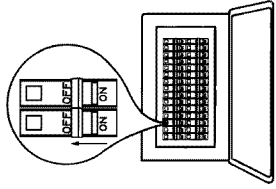
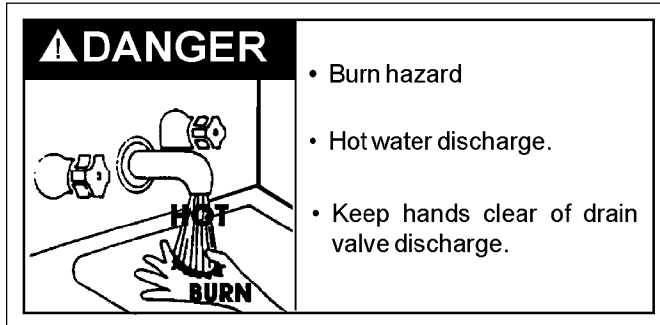

FIGURE 18.

3. Drain the water heater as directed in the “Draining and Flushing” section.



4. Remove the access cover(s), then remove the foam insulation block.
5. Remove the protective plastic cover(s) over the elements from their attachment point.
6. Disconnect the electrical wires from the heating element(s) by loosening the screws (Figure 19). Remove the screw-in element(s) by turning the element(s) counterclockwise with a 1-1/2 inch socket wrench. Remove the existing gasket(s).

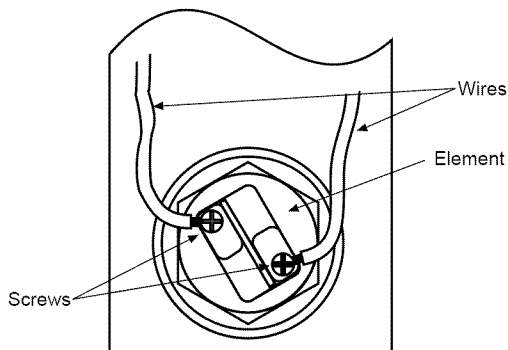

FIGURE 19.

7. Clean the area where the gasket(s) fits to the tank and internal threads. If you are replacing the bottom element, remove any accumulated sediment on the bottom of the tank.
8. If you are cleaning the element you have removed, do so by scraping or soaking in vinegar or a de-liming solution.
9. Make sure the replacement element(s) has the correct voltage and wattage rating by matching it to the rating plate on the water heater. Position the new gasket(s) on the element and insert it into the water heater tank (Figure 20). **NOTE:** Apply a light coat of hand dishwashing soap and water to the gasket. Tighten the element by turning it clockwise until secure.

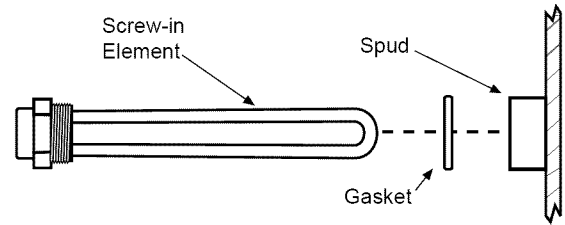

FIGURE 20.

10. Close the drain valve and open the nearest hot water faucet. Then open the cold water shut off valve and allow the tank to fill completely with water. To purge the lines of any excess air and sediment, keep the hot water faucet open for 3 minutes after a constant flow of water is obtained.
11. Check for leaks around the element(s).
12. Reconnect the electrical wires to the element and securely tighten the screws (See Figure 19).
13. Replace the protective plastic cover(s) removed earlier. Make sure the cover(s) are securely engaged on the attachment point(s).
14. Replace the foam block(s) and access cover(s).
15. Although this water heater is equipped with “Dry Fire” protection circuitry, be sure tank is completely filled with water before applying electrical power to the water heater.
16. Reconnect electrical power to the water heater at the circuit breaker/fuse box.
17. Press the power button to turn the water heater on. Set the desired water temperature and operating mode. **NOTE:** The water heater will conduct a system diagnostic check (approximately 8 minutes) prior to operation.

Routine Preventive Maintenance

At least monthly, a visual inspection should be made of the following:

- Air Filter (Remove and inspect, clean if needed, and reinstall).
- Condensate drain pan and condensate lines.
- The lower metal drain pan for standing water which may indicate a clogged condensate drain pan, condensate lines, or plumbing leak.
- Leaking or damaged water piping.
- Presence of corrosive materials in the installation area.
- Presence of combustible materials near the water heater.

IMPORTANT: If you lack the necessary skills required to properly perform this visual inspection, you should not proceed, but get help from a qualified person.

Air Filter Cleaning/Replacement

IMPORTANT: Before attempting to clean or replace the air filter press the power button to place the water heater in Standby Mode and turn-off power to the water heater at the circuit breaker/fuse box.

1. Locate the screw securing the filter panel to the heat pump shroud and loosen it.

2. Remove (slide) the filter from the unit.
3. If you are replacing the filter skip to step 4. To clean the filter use a vacuum with a hose attachment to remove any dust or debris.
4. Place the new or cleaned filter into the water heater and secure the filter to the shroud with the screw loosened earlier.
NOTE: Use the guides/slots when inserting the filter into the water heater.
5. Restore power to the water heater and press the power button to turn the water heater on. **NOTE:** The water heater will conduct a system diagnostic check prior to operation.

Inspection/Cleaning of the Condensate Drain Pan & Condensate Drain Lines

IMPORTANT: Before attempting to clean or replace the condensate drain pan or lines press the power button to place the water heater in Standby Mode and shut-off power to the water heater at the circuit breaker/fuse box.

1. Remove the access panel (fan side) by loosening the screws securing it to the unit.
2. Check the condensate drain pan and drain lines for any dirt or debris that might interfere with proper drainage. Wipe out any dirt or debris with a damp cloth.
3. Once the condensate drain pan and lines have been inspected/cleaned, secure the access panel to the water heater.
4. Restore power to the water heater and press the power button to turn the water heater on.
NOTE: The water heater will conduct a system diagnostic check prior to operation.

Drain Valve Washer Replacement

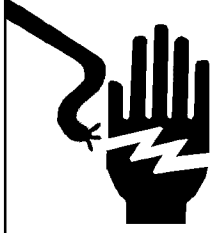
	<p>⚠ WARNING</p> <ul style="list-style-type: none"> Before removing any access panels or servicing the water heater, make sure the electrical supply to the water heater is turned "OFF". Failure to do this could result in death, serious bodily injury, or property damage.
---	---

NOTE: For replacement, use a 17/32" x 13/64" x 1/8" thick washer available at your nearest hardware store.

- Before beginning turn "OFF" the electrical power supply to the water heater.
- Follow *Draining* instructions. See *Draining* section.
- Turning counter clockwise, remove the hex cap below the screw handle.
- Remove the washer and put the new one in place.
- Screw the handle and cap assembly back into the drain valve and retighten using a wrench. **DO NOT OVER TIGHTEN.**
- Follow *Filling the Water Heater* instructions in the *Installation Instructions* section.
- Check for leaks.
- Turn "ON" electric power to the water heater.



FIGURE 21.

Service

Before calling for repair service, read the *Start Up Conditions* and *Operational Conditions* found in the *Troubleshooting* section of this manual.

If a condition persists or you are uncertain about the operation of the water heater, let a qualified person check it out.

Contact Sears Repair Services at 1-800-4-MY-HOME® (1-800-469-4663).

TROUBLESHOOTING

Start Up Conditions

THERMAL EXPANSION

CAUTION

Property Damage Hazard

- Avoid water heater damage.
- Install thermal expansion tank or device if necessary.
- Contact qualified installer or service agency.

As water is heated, it expands (thermal expansion). In a closed system, the volume of water will grow. As the volume of water grows, there will be a corresponding increase in water pressure due to thermal expansion. Thermal expansion can cause premature tank failure (leakage). This type of failure is not covered under the limited warranty. Thermal expansion can also cause intermittent temperature-pressure relief valve operation: water discharged from the valve due to excessive pressure build up. The temperature-pressure relief valve is not intended for the constant relief of thermal expansion. This condition is not covered under the limited warranty.

A properly-sized thermal expansion tank should be installed on all closed systems to control the harmful effects of thermal expansion. Thermal expansion tanks are available from Sears stores and through the Sears Service Centers. Contact the local plumbing inspector, water supplier and/or the Sears Service Center for assistance in controlling these situations.

Table 3: Thermal Expansion Tank Specifications

Model Number	Tank Capacity In Gallons	Dimensions in Inches		Pipe Fitting On Tank
		Diameter	Length	
153.331020	2	8 (203 mm)	12-3/4" (323 mm)	3/4" Male
153.331050	5	11 (279 mm)	14-3/4" (375 mm)	3/4" Male

Table 4: Expansion Tank Sizing Chart

Expansion Tank Capacity Needed	Inlet* Water Pressure	Water Heater Capacity (Gallon)				
		30	40	50	66	82
	40psi	2	2	2	5	5
	50psi	2	2	2	5	5
	60psi	2	2	5	5	5
	70psi	2	2	5	5	5
	80psi	2	5	5	5	5

*Highest recorded inlet water pressure in a 24 hour period or regulated water pressure.

NOTE: Expansion tanks are pre-charged with a 40 psi air charge. If the inlet water pressure is higher than 40 psi, the expansion tank's air pressure must be adjusted to match that pressure, but must not be higher than 80 psi.

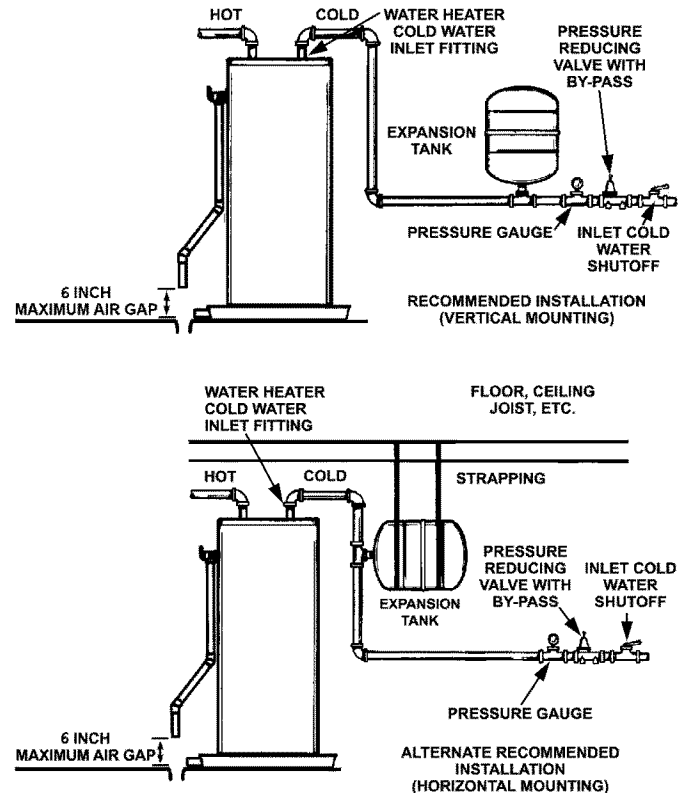

FIGURE 22.

STRANGE SOUNDS

Possible noises due to expansion and contraction of some metal parts during periods of heat-up and cool-down do not represent harmful or dangerous conditions.

Operational Conditions

POWERED ANODE ROD OPERATION

To shelter the glass-lined water tank from corrosion through electrolysis, this water heater is equipped with a non-sacrificial powered anode which should not need to be replaced under normal operating conditions. **NOTE:** The powered anode operates only when electrical power is applied.

If the powered anode malfunctions it should be replaced by a qualified technician.

IMPORTANT: If a faulty powered anode is not repaired or has been removed permanently, then all warranties are void.

“AIR” IN HOT WATER FAUCETS

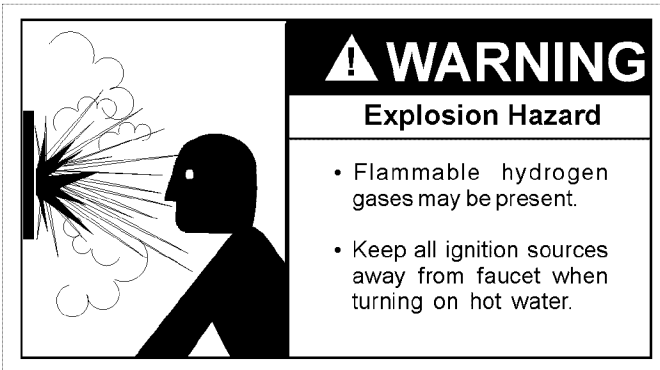

HYDROGEN GAS: Hydrogen gas can be produced in a hot water system that has not been used for a long period of time (generally two weeks or more). Hydrogen gas is extremely flammable and explosive. To prevent the possibility of injury under these conditions, we recommend the hot water faucet be opened for several minutes at the kitchen sink before any electrical appliances which are connected to the hot water system are used (such as a dishwasher or washing machine).

DIAGNOSTIC CODES

If a fault is detected by the system, an error message will be displayed on the MAIN screen indicating the general nature of the fault. More detailed fault information can be obtained by viewing the MAINTENANCE screen. The MAINTENANCE screen is accessed by simultaneously actuating the UP and DOWN arrows on the user interface touch pad for 3 seconds. (Note: engaging the child lock feature will not prevent access to the MAINTENANCE screen, but will prevent inadvertent changing of the set point temperature.) Once the screen changes to MAINTENANCE, use the up arrow to scroll to the error messages. There are six (6) system temperature messages display in succession, followed by four (4) stored fault messages. Fault messages are stored newest to oldest and are labeled EO1 - EO4. Utilize the DIAGNOSTIC CODES table for explanation of what each fault message means and corrective action steps for each.”

If hydrogen gas is present, there will probably be an unusual sound similar to air escaping through the pipe as the hot water faucet is opened. There must be no smoking or open flame near the faucet at the time it is open.

RUMBLING NOISE

In some water areas, scale or mineral deposits will build up on your heating elements. This buildup will cause a rumbling noise. Follow *Element Removal/Replacement* instructions to clean and replace the elements.

HIGH TEMPERATURE SHUT OFF SYSTEM

This water heater is designed to automatically shut-off in the event that the water temperature exceeds 190°F or 87.8°C. A temperature limit switch or ECO (Energy Cut Off) is used to shut off the power to the system if the water temperature exceeds 190°F or 87.8°C (See “Water Temperature Regulation” section). To reset the ECO disconnect power at the circuit breaker/fuse box then remove the upper access panel. Reset the ECO by firmly pushing in the red reset button located on the ECO block. If the ECO continues to shut-off the water heater contact a qualified person for service.

System temperature parameters are available on the MAINTENANCE screen to aid in assessing the operation of the heat pump. Access the MAINTENANCE screen as described in the preceding paragraph. Scroll through the parameters using the UP and DOWN arrows. The six (6) system temperatures are listed in the following order:

- AMBIENT TEMPERATURE
- TANK TEMPERATURE (average)
- UPPER TANK TEMPERATURE
- LOWER TANK TEMPERATURE
- DISCHARGE TEMPERATURE (compressor discharge)
- COIL TEMPERATURE (evaporator coil outlet)

DIAGNOSTIC CODES

DISPLAY SHOWS	INDICATES	CORRECTIVE ACTION
UPPER ELEMENT CONNECT FAULT	1. Upper element is not functioning	1. Turn off power at the circuit breaker/fuse box and check for a loose connection at the element. For access directions see "Element Removal/Replacement" section. If error persists proceed to the next step. 2. Replace non-functioning element. See "Element Removal/Replacement" section.
LOWER ELEMENT CONNECT FAULT	1. Lower element is not functioning	1. Turn off power at the circuit breaker/fuse box and check for a loose connection at the element. For access directions see "Heating Element Replacement" section. If error persists proceed to the next step. 2. Replace non-functioning element. See "Element Removal/Replacement" section. IMPORTANT: Using an element greater than 2000 watts in place of the lower element will damage the water heater.
HEAT PUMP CONNECT FAULT	1. Heat Pump compressor is not functioning.	1. Contact a qualified person to service the heat pump.
FAN CONNECT FAULT	1. Heat Pump fan is not functioning.	1. Contact a qualified person to service the unit.
AMBIENT TEMP SENSOR SHORT OR OPEN OR AD ERROR	1. Ambient Temperature Sensor is not functioning.	1. Contact a qualified person to service the unit.
UPPER TEMP SENSOR SHORT OR OPEN OR AD ERROR	1. Upper Temperature Sensor is not functioning.	1. Contact a qualified person to service the unit.
LOWER TEMP SENSOR SHORT OR OPEN OR AD ERROR	1. Lower Temperature Sensor is not functioning.	1. Contact a qualified person to service the unit.
DISCHARGE TEMP SENSOR SHORT OR OPEN OR AD ERROR	1. Discharge Temperature Sensor is not functioning.	1. Contact a qualified person to service the unit.
COIL TEMP SENSOR FAULT OR AD ERROR	1. Coil Temperature Sensor is not functioning.	1. Contact a qualified person to service the unit.
MAIN CIRCUIT BOARD FAULT	1. Main Circuit Board is not functioning.	1. Contact a qualified person to service the unit.
HIGH TEMP LOCKOUT	1. Water temperature in unit has exceeded 190° F.	1. See "High Temperature Shut-off System" section.
CONDENSATE DRAIN ALARM (If Accessory Condensate Pump is Installed)	1. Condensate pump failure.	1. Check to see if accessory condensate pump is plugged in and has power. Also check circuit breaker/fuse box and GFCI (if used). If error persists proceed to the next step. 2. Check condensate pump outlet tube for blockage. If error persists proceed to the next step. 3. Check control wire connections to condensate pump. If error persists proceed to the next step. 4. Replace accessory condensate pump. If error persists contact a Qualified Person.
LOW WATER LEVEL ALARM	1. Not enough water in the tank. (Tank not full)	1. Fill Completely - Open all hot water taps in home and run until water (uninterrupted by air) flows from all open hot water taps.
COMMUNICATION ERROR	1. No communication between mainboard and user interface board.	1. Contact a qualified person to service the unit.
ELECTRONIC POWER ANODE ERROR #0-9 (# CAN BE 0-9)	1. Indicates the power anode is not operating properly	1. Contact a qualified person to service the unit.

NOTE: The diagnostic codes listed above are the most common. If a diagnostic code not listed above is displayed, contact Sears Repair Services at 1-800-4-MY-HOME (1-800-469-4663).

TROUBLESHOOTING CHART

PROBLEM	POSSIBLE CAUSE(S)	CORRECTIVE ACTION
NO HOT WATER	<ol style="list-style-type: none"> 1. No power to the water heater (power button not lit) 2. Unit in standby (power button RED) 3. Unit in Vacation mode 4. High temperature limit switch open 5. Hot water usage pattern exceeds the capability of the water heater in current mode 6. Non-functioning upper temperature sensor 	<ol style="list-style-type: none"> 1. Check for blown fuse or tripped breaker. Restore power to unit then press power button. 2. Press the power button to turn the unit on (power button GREEN) 3. Press Vacation Mode Button to exit Vacation mode and return to desired operating mode. 4. Reset the high temperature limit switch; see "Safety shut-off" section for more information 5. Change to different mode or modify usage patterns 6. Contact a qualified person for service
INSUFFICIENT HOT WATER/ SLOW HOT WATER RECOVERY	<ol style="list-style-type: none"> 1. Temperature set-point too low 2. Air filter dirty 3. Hot water usage pattern exceeds the capability of the water heater in current mode 4. Water connections to unit reversed 5. Heat lost through long run of exposed pipe 6. Hot water leak at faucet or piping 7. Non-functioning heating element 8. Sediment or scale build up in tank 	<ol style="list-style-type: none"> 1. Increase set point temperature; see "Adjusting the User Interface Module" section 2. Clean air filter 3. Change to different mode or modify usage patterns (For example if in Efficiency Mode switch to Hybrid Mode) 4. Ensure the cold connection is at the bottom and that the hot connection is at the top 5. Insulate exposed piping 6. Repair hot water leaks 7. Call qualified person for service 8. Drain and flush tank. Water conditioning may be necessary to minimize build up
HIGH OPERATION COSTS	<ol style="list-style-type: none"> 1. Temperature set-point too high 2. Air filter dirty 3. Electric mode selected 4. Water connections to unit reversed 5. Heat lost through long run of exposed pipe 6. Hot water leak at faucet or piping 7. Sediment or scale build up in tank 	<ol style="list-style-type: none"> 1. Decrease set point temperature; see "Adjusting the User Interface Module" 2. Clean air filter 3. Change to Efficiency or Hybrid mode for reduced energy costs 4. Ensure the cold connection is at the bottom and that the hot connection is at the top 5. Insulate exposed piping 6. Repair hot water leaks 7. Drain and flush tank. Water conditioning may be required to minimize build up
DRIP FROM TEMPERATURE & PRESSURE RELIEF VALVE (Warning: Do not plug or cap T&P discharge pipe.)	<ol style="list-style-type: none"> 1. Excessive water pressure 2. Thermal expansion 3. Non-functioning Temperature & Pressure Relief Valve 	<ol style="list-style-type: none"> 1. Check water supply inlet pressure. If higher than 80 PSIG, install a pressure reducing valve (50-60 PSIG is the recommended pressure.) 2. See "Closed System/Thermal Expansion" section 3. Replace the Temperature & Pressure Relief Valve
OTHER	<ol style="list-style-type: none"> 1. The water heater does not immediately start 2. The heat pump does not run in Efficiency mode. 	<ol style="list-style-type: none"> 1. When first started the water heater takes about 8 minutes to complete a diagnostic routine 2. Contact a qualified person for service

LEAKAGE CHECKPOINTS

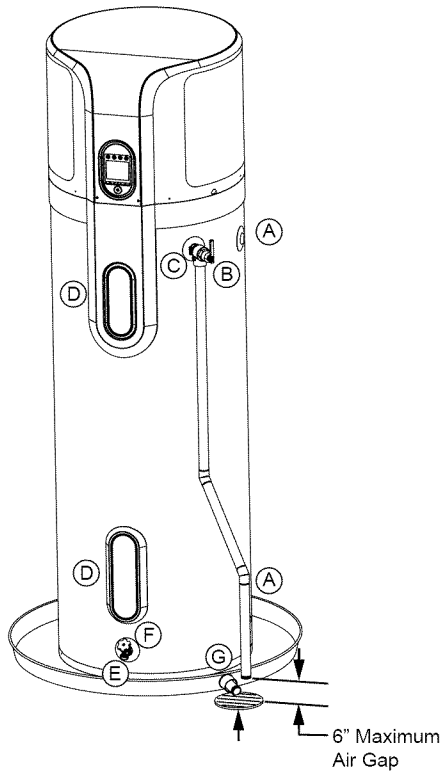

Never use this water heater unless it is completely full of water. To prevent damage to the tank and heating element, the tank must be filled with water. The water must flow from the hot water faucet before turning "ON" power.

- A. *Condensation may be seen on pipes in humid weather or pipe connections may be leaking.
- B. Small amounts of water from the temperature-pressure relief valve may be due to thermal expansion or high water pressure in your area.
- C. *The temperature-pressure relief valve may be leaking at the tank fitting.
- D. *The element may be leaking at the tank fitting.

	⚠ WARNING
	<ul style="list-style-type: none"> Before removing any access panels or servicing the water heater, make sure the electrical supply to the water heater is turned "OFF". Failure to do this could result in death, serious bodily injury, or property damage.

	⚠ WARNING
	<p>Read and understand instruction manual and safety messages before installing, operating or servicing this water heater.</p> <p>Failure to follow instructions and safety messages could result in death or serious injury.</p> <p>Instruction manual must remain with water heater.</p>

Read this manual first. Then before checking the water heater make sure the electric supply has been turned "OFF", and never turn the electric supply "on" before the tank is completely full of water.

Use this guide to check a "Leaking" water heater. Many suspected "Leakers" are not leaking tanks. Often the source of the water can be found and corrected.

If you are not thoroughly familiar with electric codes, the water heater, and safety practices, contact your local Sears Service Center to check the water heater.

CAUTION
Improper installation and use may result in property damage.
<ul style="list-style-type: none"> Fill tank with water before operation.

Turn electrical power "OFF", remove access panel and insulation cap with handle. If leaking around element, follow proper draining instructions and remove element. Reposition or replace gasket on element. Place element into opening and tighten securely. Then follow *Filling the Water Heater* instructions in the *Installation Instructions* section.

- E. Water from drain valve may be due to the valve being opened slightly
- F. *The drain valve may be leaking at the tank fitting.
- G. Water in the water heater bottom or on the floor may be from condensation, loose connections or the temperature-pressure relief valve. DO NOT replace the water heater until a full inspection of all possible water sources is made and necessary corrective steps taken.

Check for leaks at the condensate lines and connection points. If a condensate pump is used check for leaks at the pump. Also check to see if the pump is not operating or clogged.

Leakage from other appliances, water lines, or ground seepage should also be checked.

* **To check where threaded portion enters tank, insert cotton swab between jacket opening and fitting. If cotton is wet, follow *Draining* instructions in the *Service and Adjustment* section and then remove fitting. Put pipe dope or teflon tape on the threads and replace. Then follow *Filling the Water Heater* instructions in the *Installation Instructions* section.**

REPAIR PARTS LIST

KENMORE ELITE HYBRID ELECTRIC HEAT PUMP WATER HEATERS

MODEL NUMBERS

153.321160	60 Gallon
153.321180	80 Gallon

ITEM NO.	PARTS DESCRIPTION	MODEL NUMBER	
		153.321160	153.321180
1	Upper Access Cover	409230-000	409230-000
2	Lower Access Cover	409231-000	409231-000
3	Upper Element (4500 Watts)	9007479015	9007479015
4	Lower Element (2000 Watts)	9003946115	9003946115
5	Energy Cut-Off (ECO) Switch	9007480015	9007480015
6	Temperature & Pressure Relief Valve (T&P)	9007483005	9007483005
7	Dip Tube (at hot water outlet)	9007481015	9007481015
8	Powered Anode Rod	9007324005	9007564005
9	User Interface Module	9007478005	9007478005
10	Air Filter	9007482005	9007482005
11	Air Inlet Side Panel	409184-000	409184-000
12	Air Outlet Side Panel	409185-000	409185-000
13	Fan Assembly	9007486005	9007486005
14	Drain Valve	9001870015	9001870015
15	Element Terminal Cover	409195-000	409195-000
16	ECO Cover	408454-000	408454-000
17	Control Board	9007477005	9007477005
18	Compressor ECO Relay	9007476005	9007476005
19	EPS Cover	409196-000	409196-000
20**	Ambient / Coil / Discharge Temperature Sensor	9007473015	9007473015
21**	Upper / Lower Tank Temperature Sensor	9007474015	9007474015
22**	Run Capacitor	9007475005	9007475005
23**	Control Board Module Fuses	9007485015	9007485015
24**	Manual	319994-000	319994-000

** Not Shown

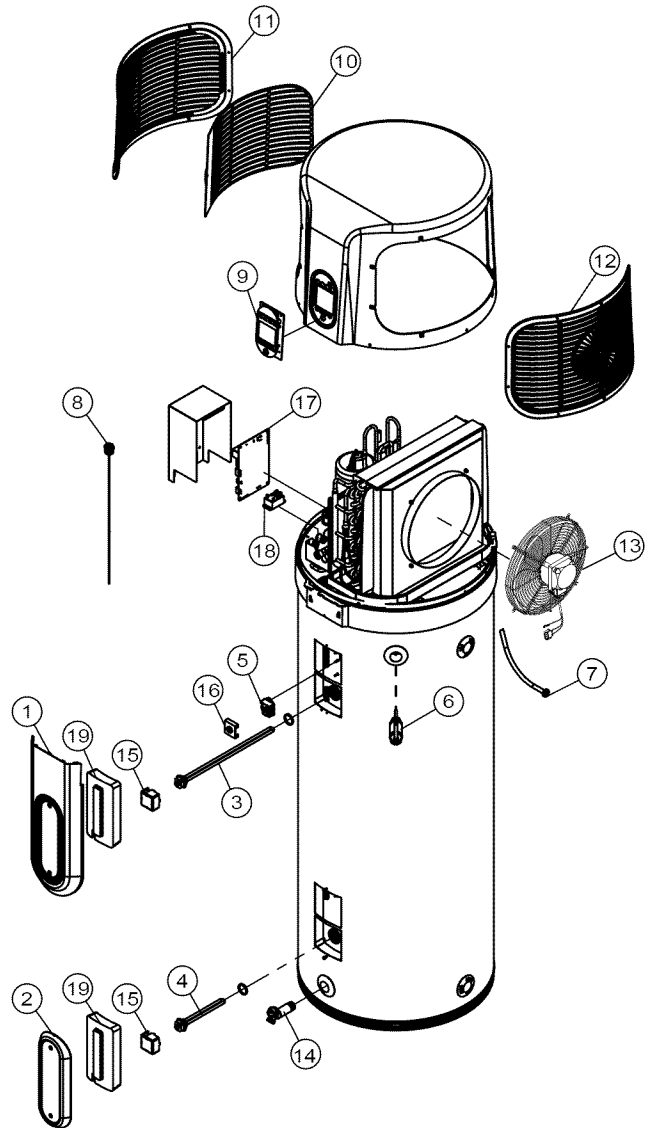

Now that you have purchased this water heater, should a need ever exist for repair parts or service, simply contact any Sears Service Center or call 1-800-4-MY-HOME® (1-800-469-4663). Be sure to provide all pertinent facts when you call or visit.

All Parts listed may be ordered from any Sears Service Center and by calling 1-800-366-PART (1-800-366-7278).

If the parts you need are not stocked locally, your order will be electronically transmitted to a Sears Repair Parts Distribution Center for handling.

The model number of the water heater will be found on the model rating plate located near the access panel.

WHEN ORDERING REPAIR PARTS, ALWAYS GIVE THE FOLLOWING INFORMATION:

- Model Number • Part Number
- Serial Number • Part Description

THIS IS A REPAIR PARTS LIST, NOT A PACKING LIST.

NOTES

Get it fixed, at your home or ours!

Your Home

For troubleshooting, product manuals and expert advice:



www.managemylife.com

For repair – **in your home** – of **all** major brand appliances, lawn and garden equipment, or heating and cooling systems, **no matter who made it, no matter who sold it!**

For the replacement parts, accessories and owner's manuals that you need to do-it-yourself.

For Sears professional installation of home appliances and items like garage door openers and water heaters.

1-800-4-MY-HOME[®] (1-800-469-4663)

Call anytime, day or night (U.S.A. and Canada)

www.sears.com www.sears.ca

Our Home

For repair of carry-in items like vacuums, lawn equipment, and electronics, call anytime for the location of your nearest

Sears Parts & Repair Service Center

1-800-488-1222 (U.S.A.)

www.sears.com

1-800-469-4663 (Canada)

www.sears.ca

To purchase a protection agreement on a product serviced by Sears:

1-800-827-6655 (U.S.A.)

1-800-361-6665 (Canada)

Para pedir servicio de reparación a domicilio, y para ordenar piezas:

1-888-SU-HOGAR[®]

(1-888-784-6427)

www.sears.com

Au Canada pour service en français:

1-800-LE-FOYER^{MC}

(1-800-533-6937)

www.sears.ca

The Sears logo, featuring the word "Sears" in a large, stylized, cursive font.

® Registered Trademark / TM Trademark of KCD IP, LLC in the United States, or Sears Brands, LLC in other countries

® Marca Registrada / TM Marca de Fábrica de KCD IP, LLC en Estados Unidos, o Sears Brands, LLC in otros países

^{MC} Marque de commerce / ^{MD} Marque déposée de Sears Brands, LLC

Free Manuals Download Website

<http://myh66.com>

<http://usermanuals.us>

<http://www.somanuals.com>

<http://www.4manuals.cc>

<http://www.manual-lib.com>

<http://www.404manual.com>

<http://www.luxmanual.com>

<http://aubethermostatmanual.com>

Golf course search by state

<http://golfingnear.com>

Email search by domain

<http://emailbydomain.com>

Auto manuals search

<http://auto.somanuals.com>

TV manuals search

<http://tv.somanuals.com>