

# KENWOOD

MONITOR WITH DVD RECEIVER

## DDX8029

---

## INSTRUCTION MANUAL

Kenwood Corporation



© B64-3658-00/00 (EV/E2V)

# Contents

<b>How to read this manual</b>	<b>4</b>
<b>Safety precautions</b>	<b>6</b>
<b>Notes</b>	<b>7</b>

<b>Watching DVD/VCD &amp; DVD Audio Listening</b>	<b>16</b>
Functions During the Playback Screen	16
Functions When Displaying the Easy Control Panel	17
Functions While Displaying the Control Screen	18
DVD Disc Menu	19
VCD Zoom Control	21
Direct Search	21

<b>Music Disc &amp; Audio File Listening</b>	<b>22</b>
Functions When Displaying the Easy Control Panel	22
Functions While Displaying the Control Screen	23
Set Disc Name	26
Folder Select (Function of Audio File)	26
Disc Select (Function of Disc Changer)	27
Direct Search	27

<b>Video File/Picture File Watching</b>	<b>28</b>
Function During Playback Screen	28
Functions When Displaying the Easy Control Panel	28
Functions While Displaying the Control Screen	29
Picture Control	30
Folder Select	30

<b>Radio Listening</b>	<b>31</b>
Functions When Displaying the Easy Control Panel	31
Functions While Displaying the Control Screen	31
Seek Mode	32
Auto Memory	33
Manual Memory	33
Preset Select	34
Radio Text	34
Direct Search	35
Traffic Information	35
Search for Program Type	36

<b>Basic Operations</b>	<b>12</b>
-------------------------	-----------

<b>iPod Control</b>	<b>37</b>
Connecting an iPod	37
Functions when Displaying the Easy Control Panel	37
Functions while displaying the Control Screen	38
iPod List	39

<b>USB Device Control</b>	<b>40</b>
Functions when Displaying the Easy Control Panel	40
Functions while displaying the Control Screen	40
USB List	41
Folder Select	42

<b>TV Watching</b>	<b>43</b>
Functions During TV Screen	43
Functions When Displaying the Easy Control Panel	43
Functions While Displaying the Control Screen	44
Seek Mode	44
Auto Memory	45
Manual memory	45
Preset Select	46
Set Station Name	46

<b>Video Watching</b>	<b>47</b>
Functions When Displaying the Easy Control Panel	47
Functions While Displaying the Control Screen	47

<b>DAB Tuner Control</b>	<b>48</b>
Functions When Displaying the Easy Control Panel	48
Functions While Displaying the Control Screen	48
Seek Mode	49
Auto Ensemble Memory	50
Service Preset Memory	50
Service Select	51
Language Filter Setting	51
Search for Program Type	52
DAB Announcement	52

<b>Source Select</b>	<b>53</b>
Displaying the Control Screen	53

<b>External Device Power Supply Control</b>	<b>54</b>
External Device Power Supply Control	54

<b>Muting Audio Volume upon Reception of Phone call</b>	<b>55</b>
Muting Audio Volume upon Reception of Phone Call	55

<b>Character Entry</b>	<b>56</b>
How To Use the Character Entry Screen	56

<b>Screen Control</b>	<b>57</b>
Screen Control	57

<b>Hands Free Unit Control</b>	<b>58</b>
Control Screen Function	58
When Called	59
When Dialing	59
Quick Dialing	60
Calling by Phone Book	60
Redialing	62
Setting up the Hands-Free Phone	63
Selecting a Hands-Free Phone	63
Deleting the Hands-Free Phone	64

<b>Setup Menu</b>	<b>66</b>
Setup Menu	66
Audio Setup	66
Crossover Network Setup	67
DVD Setup	67
Language Setup	68
Parental Level Setup	69
DivX Setup	70
iPod Setup	71
Software Information	71
System Setup	71
AV Interface Setup	72
User Interface	73
Entering Background	75
Background Delete	75
Background Select	76
Touch panel Adjustment	76
Clock Setup	77
Monitor Setup	78
Security Code Setup	80
TV Setup	81
RDS Setup	82
DAB Setup	82
Announcement Select	83
AMP Control	83
Setup Memory	84
EXT SW Setup	85

<b>Audio Control</b>	<b>86</b>
Audio Control Menu	86
Audio Control	86
Equalizer Control	87
Tone Setup	88
Zone Control	88

<b>Remote Controller</b>	<b>90</b>
Battery installation	90
Remote Controller mode switch	90
Common operations (AUD mode)	91
DVD/DVD Audio/VCD/CD/Audio files (DVD mode)	92
TV (TV mode)	93
Radio (AUD mode)	94
NAVI (NAVI mode)	94

<b>Help? Troubleshooting</b>	<b>96</b>
<b>Help? Error</b>	<b>97</b>

<b>DVD language codes</b>	<b>98</b>
<b>Specifications</b>	<b>100</b>

# How to read this manual

This manual uses illustrations to explain its operations.

The displays and panels shown in this manual are examples used to provide clear explanations of the operations. For this reason, they may be different from the actual displays or panels used, or some display patterns may be different.

▼ : Continues to the next line.  
● : Ends here.

## Short Press

Press the button, denoted by .

## Continue to the next page

The instruction continues to the next page. Make sure to flip the page for the rest of the instruction.

### Seek mode

Sets a station selection.



The mode is switched in following order each time you touch the button.

Display	Setting
"AUTO1"	Tunes in a station with good reception automatically.
"AUTO2"	Tunes in stations in memory one after another.
"MANU"	Switches to the next frequency manually.

### Manual Memory

Stores the current receiving station in memory.

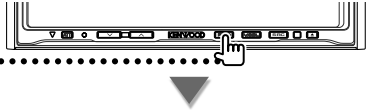

#### 1 Select a station you wish to store in memory

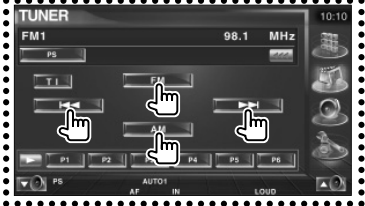

#### 2 Store in memory



Next page ►

The above operation example with the mark differs from the actual operation.



### Remote controller operation

Some functions can only be used from a remote controller. In this case, the operation using the remote controller is described, showing a  mark.

The characters below indicate a remote controller mode switch setting.



### Change in the screen

With each operation, the screen changes in the order shown here.



### Selecting a screen item

Select and choose an item on the screen. Select the item by touching the button on the screen.



### Press 1 second or more

Press the button, denoted by , for 1 second or more (2-3 seconds).

Indicates to press and hold down the button until operation starts or the screen changes. The left example indicates to press the button for 1 second.

Press it approximately for the seconds shown in the clock.

### Other marks



Important precautions are described to prevent injuries etc.



Special instructions, supplementary explanations, limitations, and reference pages are described.



General precautions and reference pages are shown on the item.



The initial value of each setup is shown.

# Safety precautions

## **▲WARNING**

### **To prevent injury or fire, take the following precautions:**

- To prevent a short circuit, never put or leave any metallic objects (such as coins or metal tools) inside the unit.
- Do not watch or fix your eyes on the unit's display when you are driving for any extended period.
- Mounting and wiring this product requires skills and experience. For safety's sake, leave the mounting and wiring work to professionals.

## **▲CAUTION**

### **To prevent damage to the machine, take the following precautions:**

- Make sure to ground the unit to a negative 12V DC power supply.
- Do not install the unit in a spot exposed to direct sunlight or excessive heat or humidity. Also avoid places with too much dust or the possibility of water splashing.
- Do not subject the faceplate to excessive shock, as it is a piece of precision equipment.
- When replacing a fuse, only use a new fuse with the prescribed rating. Using a fuse with the wrong rating may cause your unit to malfunction.
- Do not apply excessive force to the open faceplate or place objects on it. Doing so will cause damage or breakdown.
- Do not use your own screws. Use only the screws provided. If you use the wrong screws, you could damage the unit.

### **Do Not Load 3-in. CDs in the CD slot**

If you try to load a 3 in. CD with its adapter into the unit, the adapter might separate from the CD and damage the unit.

### **About CD players/disc changers connected to this unit**

Kenwood disc changers/ CD players released in 1998 or later can be connected to this unit. Refer to the catalog or consult your Kenwood dealer for connectable models of disc changers/ CD players. Note that any Kenwood disc changers/ CD players released in 1997 or earlier and disc changers made by other makers cannot be connected to this unit. Connecting unsupported disc changers/CD players to this unit may result in damage. Set the "O-N" Switch to the "N" position for the applicable Kenwood disc changers/ CD players. The functions you can use and the information that can be displayed may differ depending on the models being connected.



- You can damage both your unit and the CD changer if you connect them incorrectly.

### **Lens Fogging**

When you turn on the car heater in cold weather, dew or condensation may form on the lens in the CD player of the unit. Called lens fogging, this condensation on the lens may not allow CDs to play. In such a situation, remove the disc and wait for the condensation to evaporate. If the unit still does not operate normally after a while, consult your Kenwood dealer.

# Notes

- If you experience problems during installation, consult your Kenwood dealer.
- When you purchase optional accessories, check with your Kenwood dealer to make sure that they work with your model and in your area.
- The characters conforming to ISO 8859-1 character set can be displayed.
- The RDS or RBDS feature won't work where the service is not supported by any broadcasting station.
- The illustrations of the display and the panel appearing in this manual are examples used to explain more clearly how the controls are used. Therefore, what appears on the display in the illustrations may differ from what appears on the display on the actual equipment, and some of the illustrations on the display may be inapplicable.

## How to reset your unit

- If the unit fails to operate properly, press the Reset button. The unit returns to factory settings when the Reset button is pressed.
- Remove the USB device before pressing the Reset button. Pressing the Reset button with the USB device installed can damage the data contained in the USB device. For how to remove the USB device, refer to <Playing a USB device> (page 13).
- Press the reset button if the disc auto changer fails to operate correctly. Normal operation should be restored.



Reset button

## Cleaning the Unit

If the faceplate of this unit is stained, wipe it with a dry soft cloth such as a silicon cloth.  
If the faceplate is stained badly, wipe the stain off with a cloth moistened with neutral cleaner, then wipe it again with a clean soft dry cloth.



- Applying spray cleaner directly to the unit may affect its mechanical parts. Wiping the faceplate with a hard cloth or using a volatile liquid such as thinner or alcohol may scratch the surface or erase characters.

## TV tuner that can be connected to this unit

- KTC-V500E
- KTC-V300E
- KTC-D500E

## About Navigation units that can be connected to this unit

- KNA-G520/G420
- KNA-DV3200
- KNA-DV2200

## About iPod that can be connected to this unit

You can control an iPod from this unit by connecting an iPod (commercial product) with Dock connector using an optional accessory iPod connection cable (KCA-iP300V).

The following iPods can be controlled from this unit.

Controllable iPod	Software version
iPod nano	iPod nano software 1.2
iPod nano second generation	iPod nano software 1.1.1
iPod with video	iPod software 1.2

You must update your iPod software if its version is less than the above.

The iPod software version is displayed in the "Version" field by pressing the iPod MENU button and then selecting "Set", "Information". The latest iPod software updater can be downloaded from the Apple Computer web site.

The character set supported by this unit is ISO8859-1.

Characters that cannot be displayed correctly appear as "※".

By connecting your iPod to this unit with an optional accessory iPod connection cable (KCA-iP300V), you can supply power to your iPod as well as charge it while playing music. However, the power of this unit must be on.

### Handling CDs

- Do not touch the recording surface of the CD.
- Do not stick tape etc. on the CD, or use a CD with tape stuck on it.
- Do not use disc type accessories.
- Clean from the center of the disc and move outward.
- When removing CDs from this unit, pull them out horizontally.
- If the CD center hole or outside rim has burrs, use the CD only after removing the burrs with a ballpoint pen etc.

### CDs that cannot be used

- CDs that are not round cannot be used.

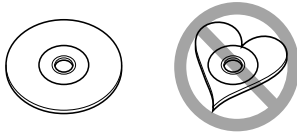

- CDs with coloring on the recording surface or CDs that are dirty cannot be used.
- This unit can only play the CDs with . This unit may not correctly play discs which do not have the mark.
- You cannot play a CD-R or CD-RW that has not been finalized. (For the finalization process refer to your CD-R/CD-RW writing software, and your CD-R/CD-RW recorder instruction manual.)

### List of playable discs

Disc types	Standard	Support	Remark
DVD	DVD Video	○	
	DVD Audio	○	
	DVD-R	○	
	DVD-RW	○	MP3/WMA/AAC/JPEG/MPEG/DivX Playback Multi-border/Multisession (Playback depends on authoring conditions)
	DVD+R	○	Compatible with 8-cm (3 inch) discs
	DVD+RW	○	
	DVD-R DL (Double layer) DVD+R DL (Double layer)	○	Only Video format.
CD	DVD-RAM	×	
	Music CD	○	CD-TEXT/8-cm (3 inch) discs supported.
	CD-ROM	○	MP3/WMA/AAC/JPEG/DivX playback
	CD-R	○	Multisession supported
	CD-RW	○	Packet write not supported.
	DTS-CD	○	
	Video CD (VCD)	○	
	Super video CD	×	
	Photo CD	×	
	CD-EXTRA	△	Only music CD session can be played.
HDCD	△	Sound quality of normal CD music	
Others	CCCD	×	
	Dualdisc	×	
	Super audio CD	△	Only CD layer can be played.

- : Playback is possible.
- △ : Playback is partly possible.
- × : Playback is impossible.



- DivX file must have the extension ".divx", ".div", or ".avi".
- When buying DRM enabled contents, check the Registration Code in the <DivX Setup> (page 70). Registration Code changes each time a file with the displayed Registration Code is played to protect against copying.



## Region codes in the world

The DVD players are given a region code according to the country or area it is marketed, as shown in the following map.

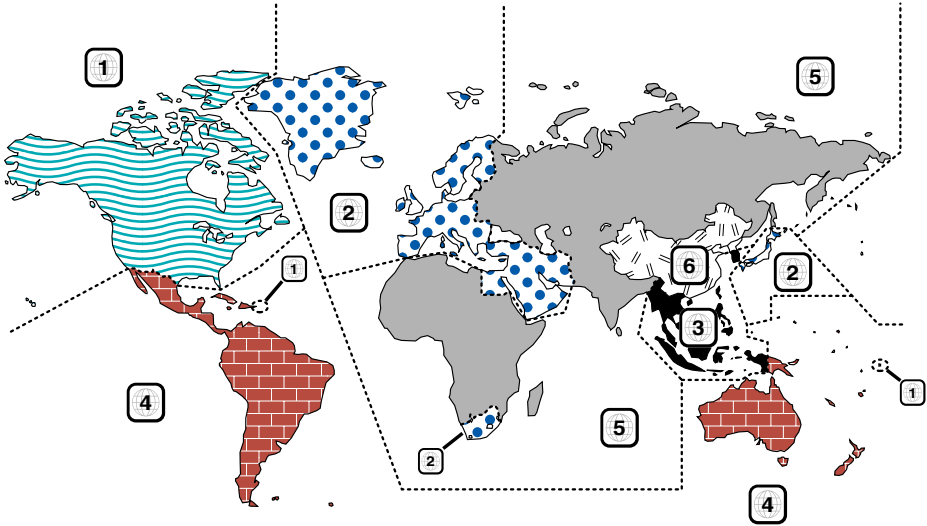

## DVD disc marks

Symbol	Description
	Indicates a region number. The discs with this mark can be played with any DVD player.
	Indicates the number of audio languages recorded. Up to 8 languages can be recorded in a movie. You can select a favorite language.
	Indicates the number of subtitled languages recorded. Up to 32 languages can be recorded.
	If a DVD disc has scenes shot from multiple angles, you can select a favorite angle.
	Indicates the type of screen for the image. The left mark indicates that a wide image picture (16:9) is displayed on a standard TV set screen (4:3) with a black band at both the top and bottom of the screen (letter box).

## Operation regulatory marks

With this DVD, some functions of this unit such as the play function may be restricted depending on the location where the DVD is playing. In this case, the following marks will appear on the screen. For more information, refer to the disc manual.



## Discs with limited period of use

Do not leave discs with a limited period of use in this unit. If you load an already expired disc, you may not be able to remove it from this unit.

## About Audio files

### • Playable Audio file

AAC-LC (.m4a), MP3 (.mp3), WMA (.wma)



- If music of normal CD and other playback systems are recorded in the same disc, only the playback system recorded at the first setout is played.

### • Playable AAC file

"m4a" file encoded by AAC-LC format.

Transfer bit rate: 16 – 320 kbps

Sampling frequency: 16 – 48 kHz

### • Playable MP3 file

MPEG 1/2 Audio Layer 3 file

Transfer bit rate: 8 – 320 kbps

Sampling frequency: 8 – 48 kHz

### • Playable WMA file

The file in accordance with Windows Media Audio (Except for the file for Windows Media Player 9 or after which applies the new functions)

Transfer bit rate: 48 – 192 kbps

Sampling frequency: 32, 44.1, 48 kHz

### • Playable disc media

CD-R/RW/ROM, DVD±R/RW

### • Playable disc file format

ISO 9660 Level 1/2, Joliet, Romeo, Long file name.

### • The maximum number of characters for display (CD-R/RW/DVD±R/RW)

File/Folder name: 128 characters

MP3 ID3 Tag version 1.x: 30 characters

### • Limitation of structure for the file and the folder (CD-R/RW/DVD±R/RW/USB device)

Maximum number of directory levels: 8

Maximum number of folders: 254

Maximum number of folders: 255

Maximum number of files per playlist: 7000 (USB device)

### • Playable USB device

USB mass storage class, iPod with KCA-iP300V

### • Playable USB device file system

FAT16, FAT32

### • About the Connection of the USB device

If an extension cable is needed for USB device connection, usage of the CA-U1EX (option) is recommended.

Normal playback is not guaranteed when a cable other than the USB compatible cable is used.

Connecting a cable whose total length is longer than 5 m can result in abnormal playback.

Although the audio files are complied with the standards listed above, the play maybe impossible depending on the types or conditions of media or device.

### • Playing order of the Audio file

In the example of folder/file tree shown below, the files are played in the order from ① to ⑩.

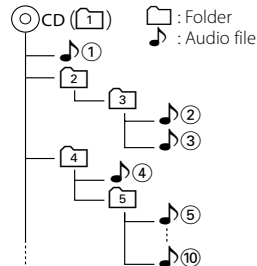

The Audio file plays in the order which is written by CD writing software. You may be able to set the playing order by writing the play sequence numbers such as "01" to "99" at the beginning of the file name.

Audio files are played in the order the files are written. You can specify the order of playback by numbering files in a folder and writing them by folder. (USB device)



- In this manual, the word "USB device" is used for flash memories and digital audio players which work as mass-storage-class devices.
- "iPod" in this manual refers to iPod connected with KCA-iP300V (Optional accessory). iPod connected with KCA-iP300V can be controlled from this unit. iPods that can be connected to KCA-iP300V are iPod nano and iPod with video. If you connect an iPod with commercially available USB cable, it is treated as a mass storage class device.
- For the supported formats and types of USB device, refer to [www.kenwood.com/usb/](http://www.kenwood.com/usb/).
- Attach the correct extension for the Audio file (AAC: ".M4A", MP3: ".MP3", WMA: ".WMA")
- Do not attach the extensions to files other than the Audio file. If the extension is attached, the file, which is not the Audio file, will play and outputs a loud noise, causing damage to the speaker.
- The files with copy protection cannot be played.
- The unit may not be compatible with upgrade of compression format standard and additional specifications.
- CD-RW discs which are quick formatted by the writing software cannot be used.
- When recording to the maximum CD-R/RW media capacity at once, the writing software is set to "Disc at once".
- File/Folder name is the number of the characters including the extensions.
- This unit can display the following versions of MP3 ID3 tag: version 1.0/ 1.1/ 2.2 (USB device)/ 2.3 (USB device)
- AAC ID3 Tag cannot be displayed.
- Contact the sales agent as to whether your USB device conforms to the USB mass storage class specs.

- Using an unsupported USB device can result in abnormal playback or display of the audio file.  
Even if you use the USB device conforming to the above specs, audio files cannot be played normally depending on the type or condition of the USB device.
- Do not leave the USB device in the vehicle for a long time. It can deform or damage due to direct sunlight, high temperature, etc.

## About Video files

### Acceptable video files

- Format: MPEG1, MPEG2, DivX
- Picture size:  
MPEG1: 320 × 240, 352 × 240  
MPEG2: 640 × 480, 704 × 480  
DivX: 352 × 240, 352 × 288, 720 × 450, 720 × 576
- Audio format:  
MPEG1/2: MPEG Audio Layer 2  
DivX: MP3, Dolby Digital
- Audio sampling frequencies: 32/ 44.1/ 48 kHz
- Audio bit rate: 32–384 kbps (Only constant bit rates)

### Extensions

Video files must have one of the following extensions:  
mpg, mpeg, mpe, m1v, m2v

Disc formats, file and folder names and playing order are the same as those for audio files. Refer to <About Audio files> (page 10).

## About Picture files

### Acceptable picture files

- Format: JPEG
- Baseline format:  
Up to a maximum of 8192(W) × 7680(H) pixels
- Progressive format:  
Up to a maximum of 1600(W) × 1200(H) pixels



- Enlarges and reduces images up to the size shown above to fit to the screen.
- The picture files with information attached (such as Exif) may not be displayed or operated (e.g.: rotation display) properly.

### Extensions

Picture files must have one of the following extensions:

jpg, jpeg, jpe

Acceptable discs, disc formats, file and folder names and playing order are the same as those for audio files. Refer to <About Audio files> (page 10).

## About USB device

- Install the USB device in the place where it will not

- prevent you from driving your vehicle properly.
- You cannot connect a USB device via a USB hub.
- Take backups of the audio files used with this unit. The files can be erased depending on the operating conditions of the USB device.  
We shall have no compensation for any damage arising out of erasure of the stored data.
- No USB device comes with this unit. You need to purchase a commercially available USB device.

## Use of "DualDisc"

When playing a "DualDisc" on this unit, the surface of the disc that is not played may be scratched while the disc is inserted or ejected. Since the music CD surface does not conform to the CD standard, playback may be impossible.

(A "DualDisc" is a disc with one surface containing DVD standard signals and the other surface containing music CD signals.)

# Basic Operations

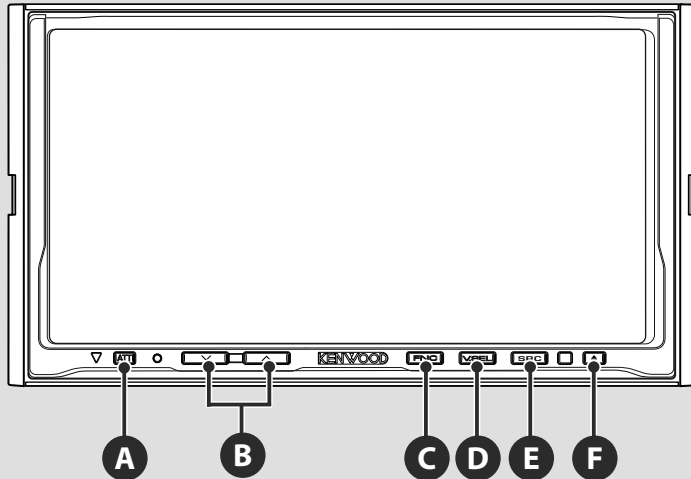

**A**

## Attenuates the volume

Press it again to cancel muting.

**A**

## Listening the traffic information

Press it for more than 1 second to turn the Traffic Information function On or Off. (page 35)

**B**

## Adjusts the volume

**F**

## Playing a disc

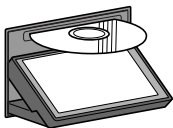

Press [**▲**] (Eject) button to open the operation panel.  
When you load a disc into disc loading slot, the disc starts playing.  
If a menu appears, when playing a video disc, select the desired item.



• See <List of playable discs> (page 8) for a list of supported discs and formats.

## Remove a disc

Press [**▲**] (Eject) button to open the operation panel.  
After removing the disc, press [**▲**] (Eject) button to close the operation panel.

**E**

## Turns power ON/OFF

Press the button to turn on the power.  
When the button is pressed and held down for 1 second or more, the power is turned off.

**C**

## Switches AV OUT source

Switches the source that is output at the AV OUTPUT terminal when it is pressed more than 1 second.

## Playing a USB device

When connecting a USB device, playback starts automatically.

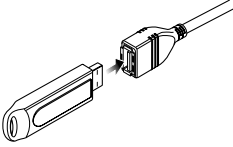

## Remove the USB device

Press  on the USB control screen to enter the USB suspend mode, and then remove the USB device. Refer to <USB Device Control> (page 40).



- Removing the USB device before entering the USB suspend mode may result in damaging the data in the USB device.



- If the USB source is selected when a USB device is not connected, "No Device" is displayed.
- When the playback is stopped and then restarted, the playback will start from the point where it was stopped at the last time. Even if the USB is removed and connected again, the playback will start from the last stopped point unless the contents in the USB device is changed.
- Make sure that the USB device is connected firmly.



## Switches the function screen

The function control screen switches in the following order each time you press the button.

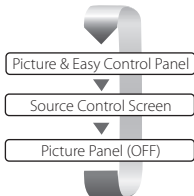

The following buttons are always displayed on the source control screen.



- 1 Displays the Source Select screen. (page 53)
- 2 Returns to the Source Control screen.
- 3 Displays the Audio Control Menu screen. (page 86)
- 4 Displays the SETUP Menu screen. (page 66)
- 5 Adjusts the Volume.
- 6 Clock display



- Touch  displayed at bottom right of various screens to return to the original screen.

## Basic Operations

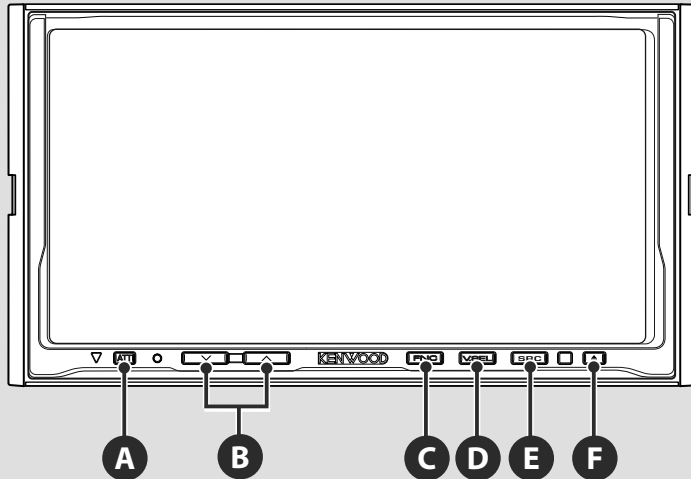

### D

#### Switches the video source

The video source switches in the following order each time you press the button.

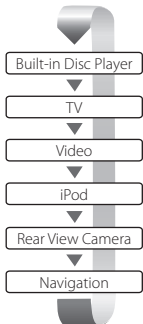

You can also turn off the video display by pressing the button longer than 1 second.

When you press the button again, the previous video display comes back on.



- The Rear view camera video is displayed when the vehicle's gear is in "Reverse".
- Set the "NAVIGATION" of the <AV Interface Setup> (page 72) to "RGB"/"AV-IN" to display the Navigation video.

**E****Switches the audio source**

The audio source is switched in the following order each time you press the button.

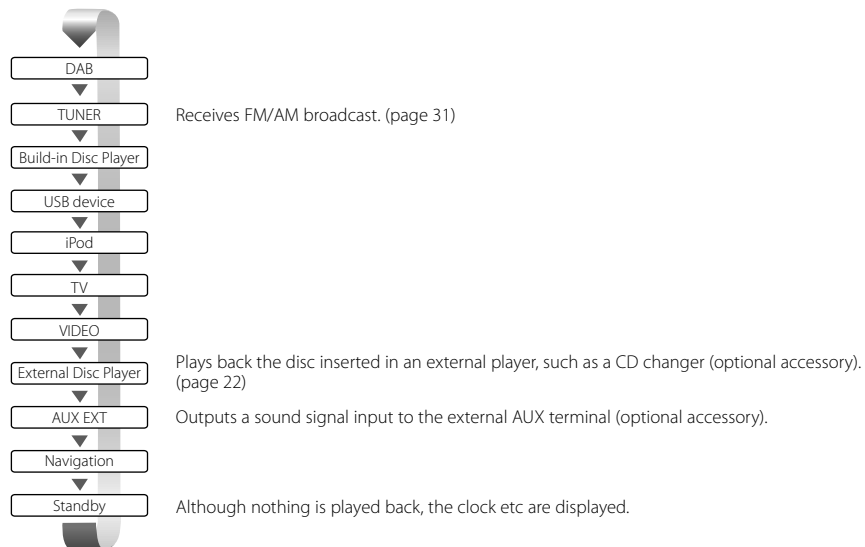

- You cannot switch to a source that is not connected or inserted.
- You can also play audio files, video files, and picture files with the Built-in Disc Player. Refer to <List of playable discs> (page 8) for the type and format of these media.
- It is necessary to set "NAVIGATION Source" of <AV Interface Setup> (page 72) to "On" to add Navigation as an audio source that can be selected with the [SRC] button.

# Watching DVD/VCD & DVD Audio Listening

You can play DVD/VCD using various functions.



- For the basic method of how to watch DVD/VCD, refer to <Basic Operations> (page 12).
- Set the remote controller mode switch to "DVD" mode before starting operation, refer to <Remote Controller mode switch> (page 90).

## Functions During the Playback Screen

Basic functions are available even when the playback screen is displayed.

### Display the playback screen.

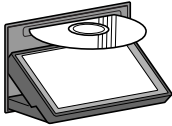

or

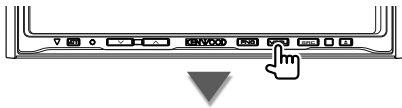

### DVD playback screen

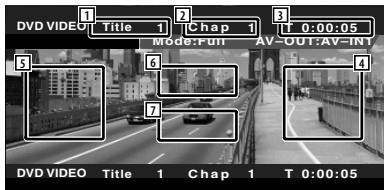

- 1 Title Number Display
- 2 Chapter Number Display
- 3 Play Time Display
- 4 Forward Chapter Search Area  
Selects the next chapter.
- 5 Backward Chapter Search Area  
Selects the previous chapter.
- 6 DVD Disc Menu Control Buttons Area  
Displays the Disc Menu Control buttons (page 19).
- 7 Information Display Button Area

### DVD Audio playback screen

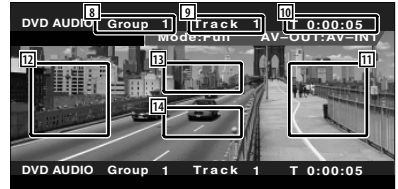

- 8 Group Number Display
- 9 Track Number Display
- 10 Play Time Display
- 11 Forward Track Search Area  
Selects the next track.
- 12 Backward Track Search Area  
Selects the previous track.
- 13 DVD Disc Menu Control Buttons Area  
Displays the Disc Menu Control buttons (page 19).
- 14 Information Display Button Area





### Functions While Displaying the Control Screen

Switches to control screen to use various playback functions.

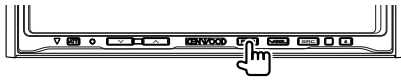
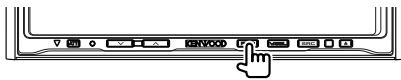

### When playing DVD Audio



### When playing a VCD



- 1 Ejects the disc from the built-in disc player.
- 2 Fast Forwards or Fast Backwards.
- 3 Stops playing.  
When pressed twice, the disc is played from its beginning when you play it in the next time.
- 4 Selects a chapter, a scene or a track.  
When the play is paused, touch this button to start single-frame stepping.
- 5 Plays or pauses.
- 6 Slow Forwards or Backwards. (during DVD play)
- 7 Switches the button display.
- 8 Switches the Repeat Play operations in the following sequence.  
DVD: Title Repeat, Chapter Repeat, Repeat Off  
DVD Audio: Group Repeat, Track Repeat, Repeat Off  
VCD: Track Repeat, Repeat Off (Available when the PBC is off)
- 9 Switches the play time display in the following sequence.  
DVD: Chapter, title, remaining titles  
DVD Audio: Track, Group, remaining Group  
VCD: Track, disc, remaining discs (Effective only when the PBC function is off)
- 10 Title Number Display (during DVD play)  
Group Number Display (during DVD Audio play)
- 11 Chapter/Scene/Track Number Display
- 12 Play Mode Display
- 13 Play Time Display

- 14 Volume Label Display  
When  is appeared, the text display is scrolled by pressing it.
- 15 Function Indicator
- 16 Appears when a disc is inserted.
- 17 Turns the PBC function of VCD On or Off.  
(only when VCD Ver 2.0 is in use)



- 18 Displays the external device control screen. See <External Device Power Supply Control> (page 54).

## DVD Disc Menu

Selects an option from the DVD Disc Menu.

### 1 Display the Disc Menu Control screen

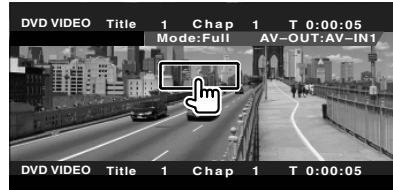

- 1 Calls the Menu.
- 2 Returns to the Disc Menu screen.
- 3 Selects a menu option.
- 4 Enters your menu selection.
- 5 Returns to the previous menu screen.
- 6 Displays the Top Menu.
- 7 Highlight Control.
- 8 Clears the Disc Menu Control.

### Highlight Control

You can select a chapter and title for the DVD Menu screen. When you touch the screen, you can select the DVD menu.



Next page ►



• To cancel Highlight Control, press [VSEL] button.

## 2 Select Disc Menu options

### Disc Menu



- 9 Calls the Menu Control.
- 10 Switches the picture angle.  
(during program playback only)
- 11 Switches the subtitle language.  
(during program playback only)
- 12 Switches the voice language.  
(during program playback only)
- 13 Displays the Zoom Control screen.
- 14 Clears the Disc Menu Control.

### Zoom Control



- 15 Changes the zoom ratio at 4 levels (2 times, 3 times, 4 times, or off) each time you touch.
- 16 Scrolls the screen in the direction you touch.
- 17 Returns to the Disc Menu Control screen.
- 18 Clears the Disc Menu Control.

## VCD Zoom Control

Displays an enlarged VCD screen.

### 1 Display the Zoom Control screen

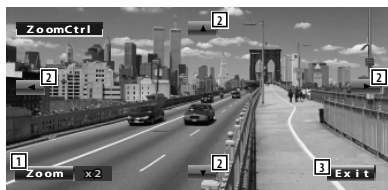
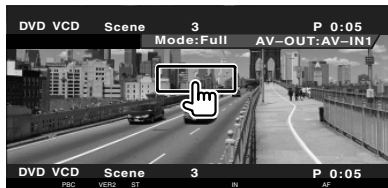

- 1 Changes the zoom ratio at 2 levels (2 times or off) each time you touch.
- 2 Scrolls the screen in the direction you touch.
- 3 Clears the Zoom Control button.

## Direct Search



You can search for a DVD/VCD chapter, scene or track by entering its number.

### 1 Select the Direct Search mode



The following items can be searched directly each time it is pressed.

DVD: Title, Chapter, Time, Direct number

DVD Audio: Group, Track, Direct number

VCD (when PBC is On): Scene, Direct number

VCD (when PBC is Off): Track

However, the direct search may not be supported for some discs.

### 2 Enter a number or time

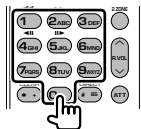

When playing back a VCD, enter a PBC scene number (if PBC is On) or a track number (if PBC is Off).



- To clear your incorrect entry, press **CLEAR** (CLEAR).

### 3 Search

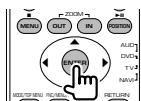

- The operation ends automatically if you do not operate within 10 seconds.
- The time search function cannot be searched correctly at the time set up depending on particular disc.

# Music Disc & Audio File Listening

You can recall various control screens during CD/Audio file/Disc Changer playback.



- For the basic method of how to play a music disc/audio file, refer to <Basic Operations> (page 12).
- Refer to <List of playable discs> (page 8) for playable discs.
- Refer to <About Audio file> (page 10) for playable files.

## Functions When Displaying the Easy Control Panel

Displays a floating control panel in the screen.

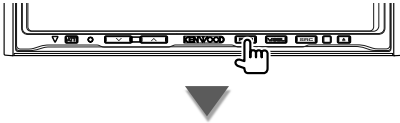

### During CD playback



### During Audio file playback



### During playback on disc changer



- 1 Switches the source.
- 2 Stops playing.
- 3 Fast Forwards or Fast Backwards. (only when a CD is played back on the built-in disc player)
- 4 Selects a music.  
When you continue to touch button:  
Fast Forwards or Fast Backwards.  
Disabled when a CD (built-in disc player) are being played.
- 5 Plays or pauses.
- 6 Selects a folder. (only when an Audio file is played back on the built-in disc player)
- 7 Selects a disc. (only when a disc is played back on the disc changer)
- 8 Displays the Screen Control screen.

(page 57 for the <Screen Control>)

- 9 Displays the external device control screen. See <External Device Power Supply Control> (page 54).



- The Easy Control Panel is hidden when you touch a central part of the monitor.

## Functions While Displaying the Control Screen

Switches to control screen to use various playback functions.

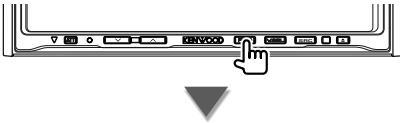
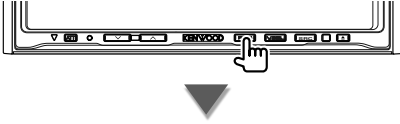

### During CD playback

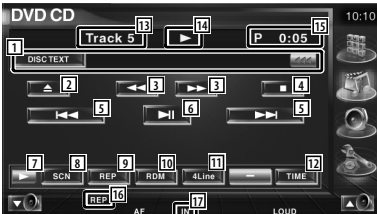

- 1 Music information display  
Selects the Disc Name (See <Set Disc Name>, page 26), Disc Text or Track Text. When  is appeared, the text display is scrolled by pressing it.
- 2 Ejects the disc from the built-in disc player.
- 3 Fast Forwards or Fast Backwards.
- 4 Stops playing the built-in disc player. When pressed twice, the disc is played from its beginning when you play it in the next time.
- 5 Selects a track.
- 6 Plays or pauses.
- 7 Switches the button display.

- 8 Starts or stops Scan Play (that plays the beginning of each music one after the other).
- 9 Repeats to play (the present track).
- 10 Starts or stops Random Play (to play music in random order).
- 11 Switches the number of lines displayed in the Information Display.
- 12 Switches the play time display between Track, Disc, and Disc Remaining Time.
- 13 Track (Music) Number Display
- 14 Play Mode Display
- 15 Play Time Display
- 16 Function Indicator
- 17 Appears when a disc is inserted.





- 18 Sets a name to the disc being played. See <Set Disc Name> (page 26).
- 19 Displays the external device control screen. See <External Device Power Supply Control> (page 54).

Next page ►

English ● 23

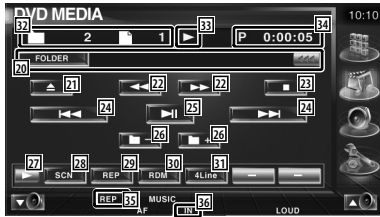
**During Audio file playback**



- 20 Music information display  
Selects Folder Name, File Name, Title, Artist Name, or Album Name.  
When  is appeared, the text display is scrolled by pressing it.
- 21 Ejects a disc.
- 22 Fast Forwards or Fast Backwards.  
(Disabled when a JPEG is being played.)
- 23 Stops playing.  
When pressed twice, the disc is played back from its beginning in the next time.
- 24 Selects a file.
- 25 Plays or pauses.
- 26 Selects a folder.
- 27 Switches the button display.
- 28 Starts or stops Scan Play (that plays the beginning of each music or data one after the other).
- 29 Repeats to play (the preset files or data).
- 30 Starts or stops Random Play (to play files of the present folder in random order).
- 31 Switches the number of lines displayed in the Information Display.
- 32 Folder and File Number Display
- 33 Play Mode Display
- 34 Play Time Display
- 35 Function Indicator
- 36 Appears when a disc is inserted.



- 37 Repeats to play the music or data of the present folder.

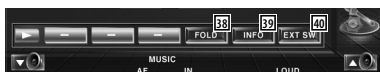

- 38 You can search for folders and Audio files through a hierarchy. See <Folder Select (Function of Audio File)> (page 26).
- 39 Displays music information (such as Tag and content property) of Audio file being played.
- 40 Displays the external device control screen. See <External Device Power Supply Control> (page 54).



## During playback on disc changer

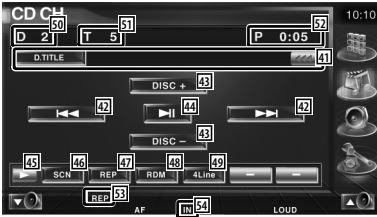

- 41 Music information display  
Selects the Disc Name (see <Set Disc Name>, page 26) or Track Text mode for text display.  
When  is appeared, the text display is scrolled by pressing it.
- 42 Selects a track.  
Starts Fast Forward or Fast Backward when it is held down.
- 43 Selects a disc. (Function of Disc Changer)
- 44 Plays or pauses.
- 45 Switches the button display.
- 46 Starts or stops Scan Play (that plays the beginning of each music one after the other).
- 47 Repeats to play (the present music).
- 48 Starts or stops Random Play (to play music in random order).
- 49 Switches the number of lines displayed in the Information Display.
- 50 Disc Number Display (Function of Disc Changer)
- 51 Track Number Display
- 52 Play Time Display
- 53 Function Indicator
- 54 Appears when a disc is inserted.



- 55 Repeats to play a disc (the present disc). (Function of Disc Changer)
- 56 Starts or stops Magazine Random Play (to play songs of the disc changer in random order). (Function of Disc Changer)



- 57 Sets a name to the disc being played. (page 26)
- 58 Displays a list of discs in the Disc changer and allows you to select the disc to listen. See <Disc Select> (page 27).
- 59 Displays the external device control screen. See <External Device Power Supply Control> (page 54).



- The functions that can be used and the information that can be displayed will differ depending on the models being connected.
- The information shown will be different depending on the Disc Changer being used.
- The buttons and information displayed depend on the Audio file being played and CD and Disc changer functions.

### Set Disc Name

Assigns a name to a CD.

**1 Play a CD you wish to name**

**2 Start Name set**



**3 Enter the name**

See <Character Entry> (page 56) for information on how to enter a name.

**4 End Name set**



### Folder Select (Function of Audio File)

Searches folders and Audio files stored in media and devices according to hierarchy.

**1 Start Folder Select**



**2 Selects a song**



- 1 Scrolls the list.
- 2 Lists folders and Audio files  
Folder opens when touched, and the Audio file is played.
- 3 Moves to the top hierarchy level.
- 4 Moves up a hierarchy level.
- 5 Returns to the original screen.

## Disc Select (Function of Disc Changer)

Displays a list of discs in the Disc changer and allows you to select the disc to listen.

### 1 Start Direct Select



### 2 Select a Disc

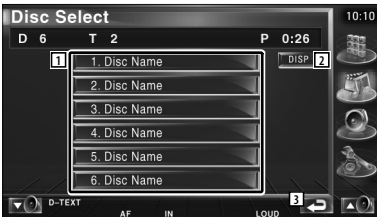

- 1 Lists the discs. Plays when touched.
- 2 Switches the list name to Disc name or Disc Text.
- 3 Returns to the original screen.

## Direct Search

Searches for a disc or a track when its number is entered.

During play on the built-in disc player

### 1 Select the Direct Search mode



The following items can be searched directly each time it is pressed.

CD: Track number, Total play time

Audio file: Folder, File

### 2 Enter a track number

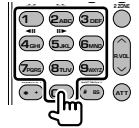

### 3 Search

When searching for a track:

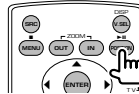

During play of an external disc player or disc changer

### 1 Enter a disc or track number

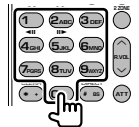

### 2 Search

When searching for a track:

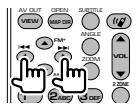

When searching for a disc:

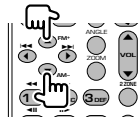

- The operation ends automatically if you do not operate within 10 seconds.

# Video File/Picture File Watching

You can recall various control screens during playback of video file (MPEG 1, MPEG 2 and DivX file) and picture file (JPEG file).

## Function During Playback Screen

Basic functions are available even when the playback screen is displayed.

### Display the playback screen.

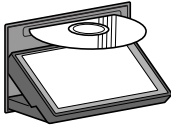

or

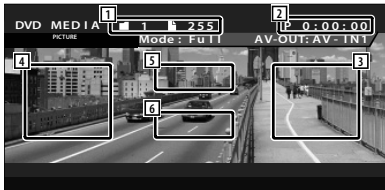

- 1 Folder/File Number Display
- 2 Play Time Display
- 3 Forward File Search Area  
Selects the next file.
- 4 Backward File Search Area  
Selects the previous file.
- 5 JPEG: Picture Control Button Area (page 30)  
DivX: Sub=Off, Audio 1/1  
MPEG: Not effective
- 6 Information Display Button Area

## Functions When Displaying the Easy Control Panel

Displays a floating control panel in the screen.



- 1 Switches the source.
- 2 Stops playing.
- 3 Selects a folder.
- 4 Selects a file.
- 5 Plays or pause.



- The Easy Control Panel is hidden when you touch a central part of the monitor.

## Functions While Displaying the Control Screen

Switches to control screen to use various playback functions.

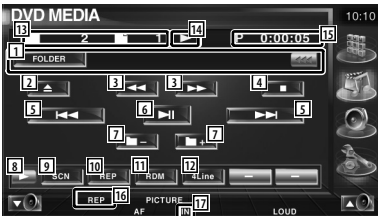
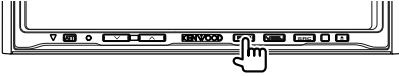

- 1 Video/Picture information display  
Selects Folder Name, File Name, Title, Artist Name, or Album Name.  
When  is appeared, the text display is scrolled by pressing it.
- 2 Ejects a disc.
- 3 Fast Forwards or Fast Backwards.  
(Disabled when a JPEG is being played.)
- 4 Stops playing.  
When pressed twice, the disc is played back from its beginning in the next time.
- 5 Selects a file.
- 6 Plays or pauses.
- 7 Selects a folder.
- 8 Switches the button display.
- 9 Starts or stops Scan Play (that plays the beginning of each song or data one after the other).

- 10 Repeats to play (the preset files or data).
- 11 Starts or stops Random Play (to play files of the present folder in random order).
- 12 Switches the number of lines displayed in the Information Display.
- 13 Folder and File Number Display
- 14 Play Mode Display
- 15 Play Time Display
- 16 Function Indicator
- 17 Appears when a disc is inserted.



- 18 Repeats to play the file of the present folder.



- 19 You can search for folders and files through a hierarchy. See <Folder Select> (page 30).
- 20 Displays information of file being played.
- 21 Displays the external device control screen. See <External Device Power Supply Control> (page 54).

## Picture Control

Adjusting the video display.

### 1 Starts Picture Control



### 2 Adjusts the video display



- 1 Reverses the picture horizontally.
- 2 Rotates counter clockwise.
- 3 Rotates clockwise.
- 4 Ends Picture Control.

## Folder Select

Searches folders and Video files/Pictures stored in media and devices according to hierarchy.

### 1 Start Folder Select



### 2 Selects a file



- 1 Scrolls the list.
- 2 Lists folders and Video files/Picture files. Folder opens when touched, and the Video file/Picture file is played.
- 3 Moves to the top hierarchy level.
- 4 Moves up a hierarchy level.
- 5 Returns to the original screen.

# Radio Listening

Various control screens appear in the Tuner Source mode.



- For the basic method of receiver button operations, refer to <Basic Operations> (page 12).
- Set the remote controller mode switch to "AUD" mode before starting operation, refer to <Remote Controller mode switch> (page 90).

## Functions When Displaying the Easy Control Panel

Displays a floating control panel in the screen.



- 1 Switches the source.
- 2 Switches the band (to AM or FM1/2/3).
- 3 Tunes in a station.
- 4 Switches the Seek Mode.  
See <Seek Mode> (page 32).
- 5 Displays the Screen Control screen.  
See <Screen Control> (page 57).
- 6 Displays the external device control screen. See <External Device Power Supply Control> (page 54).



- The Easy Control Panel is hidden when you touch a central part of the monitor.

## Functions While Displaying the Control Screen

Switch to control screen to use various functions.

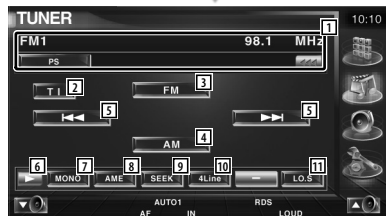

- 1 Radio station information display.  
Selects the Program Service Name, Title, Artist name, Station Name, Category Name 1/2, or Radio Text.
- 2 Turns the Traffic Information function On or Off.  
See <Traffic Information>, (page 35).
- 3 Switches to the FM1/2/3 band.
- 4 Switches to the AM band.
- 5 Tunes in a station.  
Use the <Seek Mode> (page 32) to change the frequency switching.

Next page ►

- 6 Switches the button display.
- 7 Selects the Monaural reception mode. (Only when receiving the FM broadcast)
- 8 Selects the Auto Memory mode. (Refer to page 33 for the <Auto Memory>)
- 9 Switches the Seek Mode. (Refer to page 32 for the <Seek Mode>)
- 10 Switches the number of lines displayed in the Information Display.
- 11 Turns the Local Seek function On or Off.



- 12 When P1 to P6 buttons appear, you can recall the stations on memory. For memory of broadcasting stations, refer to <Auto Memory> (page 33) or <Manual Memory> (page 33).



- 13 Searches station by program type. See <Search for Program Type> (page 36).
- 14 Lists and selects memorized station. See <Preset Select> (page 34).
- 15 Displays Radio Text screen. See <Radio Text> (page 34).
- 16 Displays the external device control screen. See <External Device Power Supply Control> (page 54).

## Seek Mode

Sets a station selection.



The mode is switched in following order each time you touch the button.

Display	Setting
"AUTO1"	Tunes in a station with good reception automatically.
"AUTO2"	Tunes in stations in memory one after another.
"MANU"	Switches to the next frequency manually.





: Press for # seconds.

## Auto Memory

Stores stations with good reception in memory automatically.

### 1 Select a band you wish to store in memory



### 2 Select the Auto Memory mode



### 3 Start Auto Memory



Touch  or .

Auto Memory terminates when 6 stations are stored or when all stations are tuned in.



- The operation ends automatically if you do not operate within 10 seconds.

## Manual Memory

Stores the current receiving station in memory.

### 1 Select a station you wish to store in memory



### 2 Store in memory



Continue to touch until the memory number appears.

## Preset Select

Lists and selects memorized station.

### 1 Start Preset Select

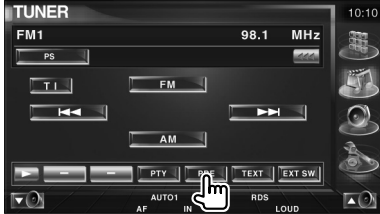

### 2 Selects a station

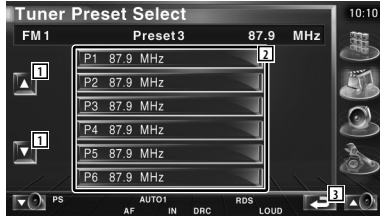

- 1 Scrolls the list.
- 2 Memorized stations are displayed. Touch to tune in.
- 3 Returns to the original screen.

## Radio Text

You can display the radio text. (Only when receiving the FM broadcast)

### 1 Select a station

### 2 Display the radio text

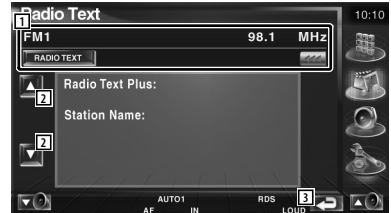

- 1 Select the Program Service Name, Title & Artist name, Station Name, Category1/2, or Radio Text for text display. When  is appeared, the text display is scrolled by pressing it.
- 2 Scrolls the Radio text plus display.
- 3 Returns to the original screen.

## Direct Search



Tunes in a station when its frequency is entered.

### 1 Select a band

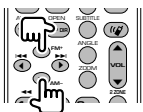

### 2 Select the Direct Search mode



### 3 Enter frequency

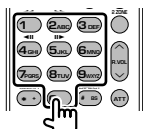

When you enter frequency, signal reception starts.

Example: When you receive FM 92.1 MHz



Example: When you receive AM 810 kHz



- The operation ends automatically if you do not operate within 10 seconds.

## Traffic Information

When a traffic bulletin starts, any source is switched to the traffic information and it is displayed automatically.

### 1 Set the Traffic information mode



### When the traffic bulletin starts...

The Traffic Information screen appears automatically.

### Traffic Information screen



- It is necessary to have Traffic Information function set to On in order to have the Traffic Information screen appear automatically.
- During reception of traffic information the adjusted volume is automatically remembered, and the next time it switches to traffic information it's automatically the remembered volume.

## Search for Program Type

A program is tuned when you set its program type. (Only when receiving the FM broadcast)

### 1 Enter Program Type mode



### 2 Select a Program Type



- 1 Program Type is displayed. Touch to select a Program Type.
- 2 Scrolls the Program Type list.
- 3 Search for the program type.  
It is displayed when the Program type is selected.
- 4 Returns to the original screen.

### 3 Searches station of the selected Program Type



# iPod Control

You can control and listen to songs in your iPod by connecting iPod with video or iPod nano to this unit with KCA-iP300V (optional accessory). You can also display video contents on this unit when connecting an iPod with video. Only one iPod can be connected to this unit.

## Connecting an iPod

Connect an iPod to this unit.

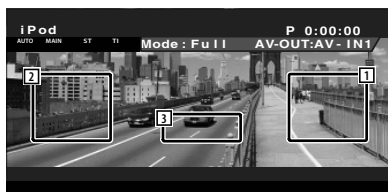
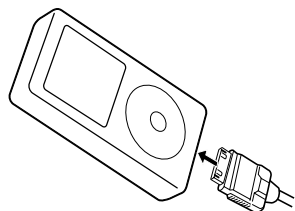

- 1 Forward music/video search area  
Select the next music/video.
- 2 Backward music/video search area  
Select the previous music/video.
- 3 Information display button area  
The information is display for 5 seconds.



- Remove all accessories such as headphone before connecting an iPod. You may not be able to control the iPod if you connect it with accessories attached.
- When you connect an iPod to this unit, playback starts from the song you were playing on the iPod itself (Resume Function).
- If the played song is not a video content, "No iPod Video Signal" is displayed on the video screen.
- While connecting an iPod, "KENWOOD" appears on the iPod and the iPod's control is disabled.

## Functions when Displaying the Easy Control Panel

Displays a floating control panel in the screen.



- 1 Switches the source.
- 2 Fast Forward or Fast Backward.
- 3 Music/Video Search.
- 4 Plays or pause.
- 5 Display the Screen Control screen. (Refer to <Screen Control> (page 57))
- 6 Displays the external device control screen. See <External Device Power Supply Control> (page 54).



- The Easy Control Panel display is hidden when you touch a central area of the monitor.

## Functions while displaying the Control Screen

Switches to control screen to use various playback functions.

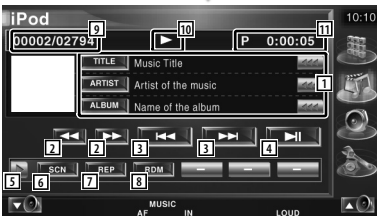
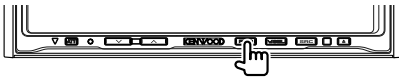
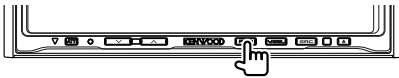

- 1 Music/Video Information Display  
Selects the Title, Artist Name, Album Name or iPod Name.  
When  is appeared, the text display is scrolled by pressing it.
- 2 Fast Forward or Fast Backward.
- 3 Select Music/Video.
- 4 Plays or pause.
- 5 Switches the button display.

- 6 Starts or stops Scan Play (that plays the beginning of each music or video one after the other).
- 7 Repeats to play (the preset files or data).
- 8 Starts or stops Random play.\*1
- 9 Total number of music in the iPod and the music number display
- 10 Play Mode Display
- 11 Play Time Display



- 12 Starts or stops Album Random Play (plays randomly from current album).\*1



- 13 Display the list of music category.  
See <iPod List> (page 39).
- 14 Display the list of video category.  
See <iPod List> (page 39).
- 15 Displays the previous music/video list.  
See <iPod List> (page 39).
- 16 Displays information screen of music/video being played.
- 17 Displays the external device control screen. See <External Device Power Supply Control> (page 54).



\*1 Disable when video is being played.

## iPod List

Lists and searches music/video contained in the iPod.

### 1 Display the iPod List

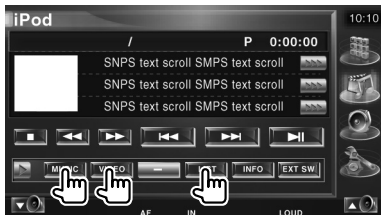

### 2 Select music/video

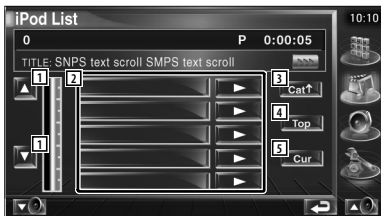

- 1 Switches list page.
- 2 Categories and music are listed.  
Touch a category name to move its lower level. If music title is displayed, the music is played by touching it.  
If  is touched, all the music in its category is played.
- 3 Returns to previous category.
- 4 Moves to the top category.
- 5 Displays the currently playing category.

# USB Device Control

You can control and listen to songs in your USB device by simply connecting it to the USB connector of this unit.



- For the connection of a USB device, refer to <Basic Operations> (page 12).

## Functions when Displaying the Easy Control Panel

Displays a floating control panel in the screen.



- 1 Switches the source.
- 2 Selects a folder.  
(Only in Folder Select mode)
- 3 Selects a file.
- 4 Plays or pause.
- 5 Display the Screen Control screen. (see <Screen Control> (page 57))
- 6 Displays the external device control screen. See <External Device Power Supply Control> (page 54).



- The Easy Control Panel display is hidden when you touch a central area of the monitor.

## Functions while displaying the Control Screen

Switches to control screen to use various playback functions.

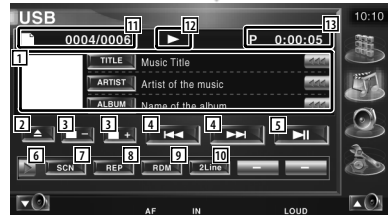

- 1 Music information display  
Selects Folder Name, File Name, Title, Artist Name, or Album Name.  
When [RE] is appeared, the text display is scrolled by pressing it.
- 2 Removes the USB device.  
When "No Device" is shown, the USB device can be removed safely.  
If you wish to play it again while the USB device is connected, press it again.
- 3 Selects a folder. (Only in Folder Select Mode)
- 4 Selects a file.



- 5 Plays or pauses.
- 6 Switches the button display.
- 7 Starts or stops Scan Play (that plays the beginning of each music one after the other).
- 8 Repeats to play (the present music).
- 9 Starts or stops Random Play (to play music in random order). (Only in Folder Select Mode)\*1
- 10 Switches the number of lines displayed in the Information Display.
- 11 Track (Music) Number Display
- 12 Play Mode Display
- 13 Play Time Display



- 14 Repeats to play the music or data of the present folder. (Only in Folder Select Mode)



- 15 Displays the folder list. Refer to <Folder Select> (page 42).
- 16 Displays the list of category. Refer to <USB List> (page 41).
- 17 Displays information screen of music being played.
- 18 Displays the external device control screen. See <External Device Power Supply Control> (page 54).



\*1 Disable during play list mode.

## USB List

Lists and searches music contained in the USB device.

### 1 Display the Category List

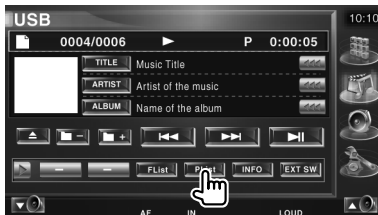

### 2 Select a category



- 1 Returns to the original screen.

### 3 Select music



- 2 Switches to the lower level of the category.
- 3 Lists all the music in the selected category.
- 4 Moves to the upper level of the category.
- 5 Moves to the top category.
- 6 Displays the currently playing category. (Only in Category Mode)
- 7 Returns to the original screen.

## Folder Select

Searches folders and Audio files stored in the USB device according to hierarchy.

### 1 Start Folder Select

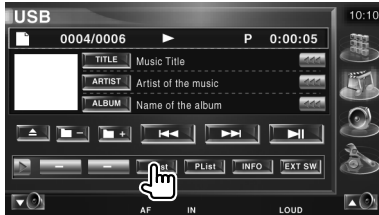

### 2 Selects a song



- 1 Scrolls the list.
- 2 Lists folders and Audio files  
Folder opens when touched, and the Audio file is played.
- 3 Moves to the top hierarchy level.
- 4 Moves up a hierarchy level.
- 5 Displays the currently playing file.
- 6 Returns to the original screen.

# TV Watching

Various control screens appear in the TV Source mode. (You can only operate TV with the optional accessory TV Tuner connected.)

## Functions During TV Screen

Basic functions are available even when the TV screen is displayed.

### Display the TV screen

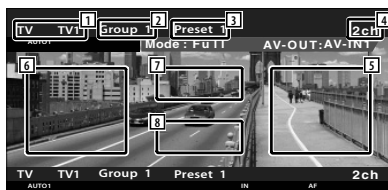

- 1 TV Band Number Display
- 2 TV Area Group Display  
Refer to <TV Setup> (page 81).
- 3 Memory Number Display
- 4 Channel Number Display
- 5 Channel Up Area  
Increase the channel.  
Use the <Seek mode> (page 44) to change the channel tuning sequence.
- 6 Channel Down Area  
Decrease the channel.  
Use the <Seek mode> (page 44) to change the channel tuning sequence.
- 7 Band Switch Area  
Switches to TV1 or TV2.
- 8 Information Display Button Area



- For TV picture selection and receiver button operations, see <Basic operations> (page 12).
- The information display is cleared automatically after approximately 5 seconds. Also, the information can be displayed automatically when it is updated.

## Functions When Displaying the Easy Control Panel

Displays a floating control panel in the screen.

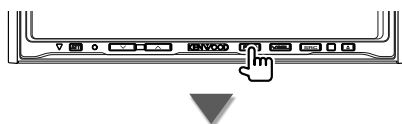

- 1 Switches the source.
- 2 Switches the TV band (to TV1 or TV2).
- 3 Select a channel.  
Use the <Seek mode> (page 44) to change the channel tuning sequence.
- 4 Switches the Seek mode.  
(page 44 for the <Seek mode>)
- 5 Displays the Screen Control screen.  
(page 57 for the <Screen Control>)
- 6 Displays the external device control screen.  
See <External Device Power Supply Control> (page 54).



- The Easy Control Panel display is hidden when you touch a central area of the monitor.

### Functions While Displaying the Control Screen

Switches to control screen to use various playback functions.

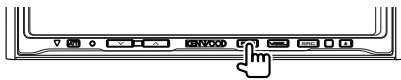
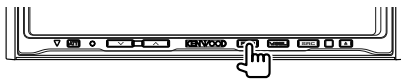

- 1 Channel information display
- 2 Switches to TV1 or TV2.
- 3 Select a channel.  
Use the <Seek Mode> (page 44) to change the channel tuning sequence.
- 4 Switches the button display.
- 5 Selects the Auto Memory mode.  
Refer to <Auto Memory> (page 45).
- 6 Switches the Seek Mode.  
Refer to <Seek Mode> (page 44).

- 7 Indicates current Seek Mode.
- 8 TV Area Group Display  
Refer to <TV Setup> (page 81).
- 9 Memory Number Display
- 10 Channel Number Display



- 11 When **P1** to **P6** buttons appear, you can recall channels on memory.  
For memory of broadcasting stations, see <Auto Memory> (page 45) or <Manual Memory> (page 45).



- 12 Sets a name to the tuned station. (page 46)
- 13 Lists and selects memorized station. See <Preset Select> (page 46).
- 14 Displays the external device control screen. See <External Device Power Supply Control> (page 54).

### Seek Mode

Sets a station selection.



The mode is switched in following order each time you touch the button.

Display	Setting
"AUTO1"	Tunes in a station with good reception automatically.
"AUTO2"	Tunes in stations in memory one after another.
"MANU"	Switches to the next frequency manually.



: Press for # seconds.

## Auto Memory

Stores stations with good reception in memory automatically.

### 1 Select a band you wish to store in memory



### 2 Select the Auto Memory mode



### 3 Start Auto Memory



Auto Memory terminates when 6 stations are stored or when all stations are tuned in.



- The operation ends automatically if you do not operate within 10 seconds.

## Manual memory

Stores the current receiving channel in memory.

### 1 Select a station you wish to store in memory



### 2 Store in memory



Continue to touch until the memory number appears.

## Preset Select

Lists and selects memorized station.

### 1 Start Preset Select



### 2 Selects a station

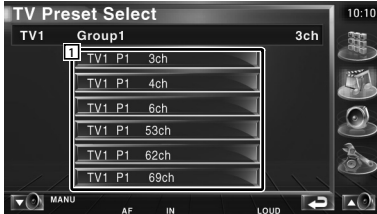

- 1 Memorized stations are displayed. Touch to tune in.

## Set Station Name

Assigns a name to a station.

### 1 Select a station you wish to name



### 3 Enter the name

See <Character Entry> (page 56) for information on how to enter a name.

### 4 End Name set



- You can enter characters only after you have applied the parking brake.

# Video Watching

## Functions When Displaying the Easy Control Panel

Displays a floating control panel in the screen.



- 1 Video switch Area  
Switches to Video1/Video2.

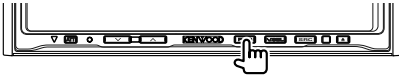

- 2 Switches the source.
- 3 Displays the external device control screen. See <External Device Power Supply Control> (page 56)
- 4 Displays the Screen Control screen. (page 59 for the <Screen Control>)
- 5 Switches to Video1.
- 6 Switches to Video2.



- The Easy Control Panel display is hidden when you touch a central area of the monitor.

## Functions While Displaying the Control Screen

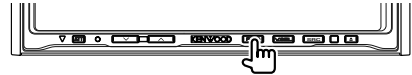

- 1 Switches to Video1.
- 2 Switches to Video2.
- 3 Displays the external device control screen. See <External Device Power Supply Control> (page 54)

# DAB Tuner Control

Various control screens appear in the DAB Tuner source mode. (with the optional accessory DAB tuner connected only)

## Functions When Displaying the Easy Control Panel

Displays a floating control panel in the screen.

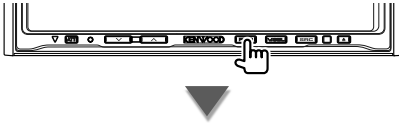

- 1 Switches the source.
- 2 Switches the band (to DAB1/2/3).
- 3 Selects a service.
- 4 Selects the Ensemble.
- 5 Switches the Seek Mode.  
(See page 49 for the <Seek Mode>)
- 6 Displays the Screen Control screen.  
(page 57 for the <Screen Control>)
- 7 Displays the external device control screen. See <External Device Power Supply Control> (page 54)



- The Easy Control Panel display is hidden when you touch a central area of the monitor.

## Functions While Displaying the Control Screen

Switches to control screen to use various functions.

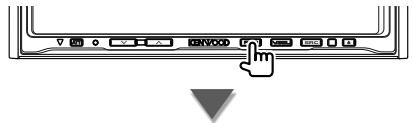
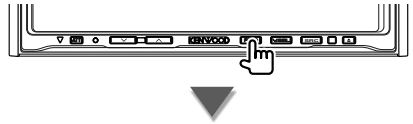

- 1 Displays information concerning music being played.  
Changes the display between Ensemble label, PTY label, Component label, Region label, and Audio quality.  
When is appeared, the text display is scrolled by pressing it.
- 2 Switches the band (to DAB1/2/3).
- 3 Selects a service.
- 4 Selects the Ensemble.
- 5 Switches the button display.



- 6 Selects the primary or secondary operation.
- 7 Selects the Auto memory mode. (page 50 for the <Auto Ensemble memory>)
- 8 Switches the Seek Mode. (page 49 for the <Seek Mode>)
- 9 Switches the number of lines displayed in the Information Display.
- 10 Indicates current Seek Mode.



- 11 When **P1** to **P6** buttons appear, you can recall a service from memory.



- 12 You can set the menu language. See <Language Filter Setting> (page 51)
- 13 Searches station by specifying program type. See <Search for Program Type> (page 52).
- 14 You can list and select services. See <Service Select> (page 51).
- 15 Displays DAB information.
- 16 Displays the external device control screen. See <External Device Power Supply Control> (page 54).

## Seek Mode

Sets a station selection mode.



The mode is switched in following order each time you touch the button.

Display	Setting
"AUTO1"	Tunes in a ensemble with good reception automatically.
"AUTO2"	Tunes in service in memory one after another.
"MANU"	Switches to the next channel manually.

### Auto Ensemble Memory

An ensemble with good reception is stored in memory automatically.

**1 Select a band you wish to store in memory**



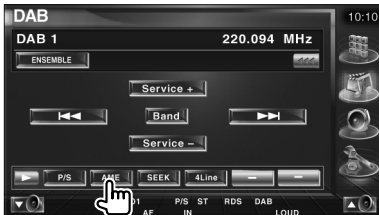

**2 Select the Auto Memory mode**



**3 Start Auto Memory**



Touch  or .  
Auto Memory terminates when 6 stations are stored or when all stations are tuned in.

### Service Preset Memory

The current receiving service is stored in memory.

**1 Select a service you wish to store in memory**



**2 Store in memory**

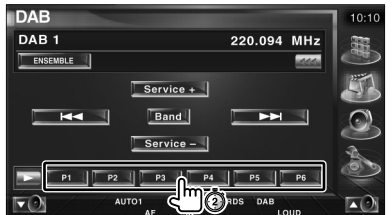

Continue to touch until the memory number appears.



## Service Select

Listing and selecting service in the current ensemble.

### 1 Start Service Select



### 2 Select a service

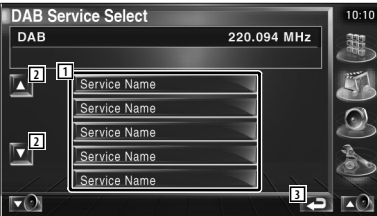

- 1 Selects a service.  
Tunes in the touched service.
- 2 Scrolls the service list.
- 3 Returns to the original screen.

### 3 Search the service

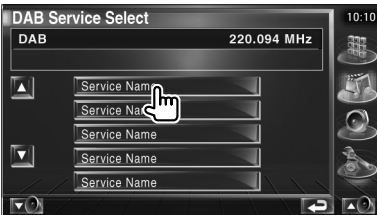

## Language Filter Setting

Setting the menu language.

### 1 Start Language Filter Setting



### 2 Select a language



- 1 Language display
- 2 Switches language list.
- 3 Returns to the original screen.

### 3 Search the language



### Search for Program Type

Specifying program type and searching service.

#### 1 Start Program Type mode



#### 2 Select Program Type



- 1 Program Type display
- 2 Switches Program Type.
- 3 4 5 are displayed and you can switch the language. Touching once more erases 4 5 and then you can switch the program type.
- 4 Language display
- 5 Switches language list.
- 6 Returns to the original screen.

#### 3 Searches service of the selected Program Type



### DAB Announcement

When the Announcement you have turned on starts, any source is switched to the Announcement automatically.

#### When the announcement starts...

The Announcement screen appears automatically.

#### Announcement screen



# Source Select

The source you wish to listen to can be selected quickly.

## Displaying the Control Screen

### 1 Display control screen

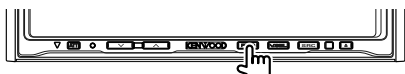

Press several times until the Control Screen appears.

### 2 Display source select screen



### 3 Select a source



- 1 Switches to the selected source.
- 2 Scrolls the source display.
- 3 Displays the external device control screen. See <External Device Power Supply Control> (page 54).
- 4 Switches the skin. (3 types)
- 5 Displays the Hands-Free Control screen. See <Hands Free Unit Control> (page 58).



- The displayed source depends on the type of device connected. In addition, you cannot press the button of currently unavailable source.

# External Device Power Supply Control

Controlling the external device power supply.

## External Device Power Supply Control

Controlling the external device power supply.

### 1 Displays the EXT SW Control screen

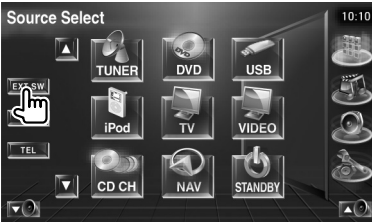

[EXT SW] appears when the control screen of each source or Easy control panel is displayed.

### 2 Controls the external device power supply



- 1 You can turn on or off the external device power supply.
- 2 Returns to the original screen.



- You must connect a commercially available relay unit in order to use this function.  
Connect the external device to be controlled to that relay unit.
- Refer to <EXT SW Setup> (page 85) for information on setting the power on or off specification.

# Muting Audio Volume upon Reception of Phone call

## Muting Audio Volume upon Reception of Phone Call

When the telephone is called, the system is paused automatically.

### When the telephone is called...

The Phone Call ("CALL") screen appears, and system is paused.

### Phone Call ("CALL") screen



### If you want to continue to listen to the audio source during phone call...



The system resumes audio play during the phone call.

### When the call ends...

#### Hang up the phone.

The system resumes playing automatically.



- To use the TEL Mute feature, you need to hook up the MUTE wire to your telephone using a commercial telephone accessory. Refer to <INSTALLATION MANUAL>.

# Character Entry

## How To Use the Character Entry Screen

When you select the Set Disc Name mode or others, the following screen appears for character entry.

### Character Entry screen



1 Shifts the cursor.

2 Enters a space.

If you erase a character, locate the cursor on it and touch this button.

3 Enters characters.

4 Scrolls up or down the character button display.

5 Exits the Character Entry mode and returns to the previous screen.



- You can enter characters only after you have applied the parking brake.



# Screen Control

## Screen Control

Setting the monitor screen.

### 1 Display Easy control panel

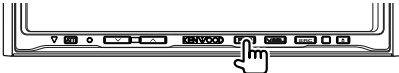

### 2 Display the Screen Control screen



### 3 Adjust the picture quality

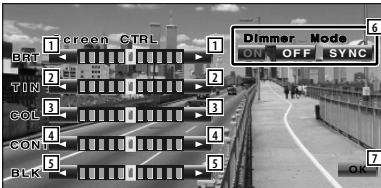

- 1 Brightness Control
- 2 Tint Control  
Displayed for an NTSC system image on TV, Video, iPod or Rear View Camera.
- 3 Color Control  
Displayed on the TV, Video, iPod or Rear View Camera screen only.
- 4 Contrast Control
- 5 Black Level Adjustment
- 6 Dimmer Mode Setup  
"SYNC": Turning the Dimmer function On or Off when the vehicle light control switch is turned On or Off.  
"On": The display dims.  
"Off": The display doesn't dim.
- 7 Returns to the previous screen.



- The Screen Control screen is displayed only when you have applied the parking brake.
- The picture quality can be set for each source.
- You can set image quality of screens such as menu from <Monitor Setup> (page 78) of the <Setup Menu>.

# Hands Free Unit Control



- You need to register your cell-phone to your Bluetooth Hands Free Box beforehand. Make sure to read the instruction manual of the Bluetooth Hands Free Box as well.

## Control Screen Function

Displaying the control screen and using various functions.

### 1 Display the control screen

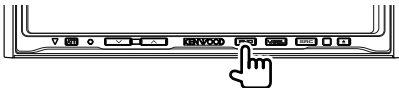

Press several times until the Control Screen appears.

### 2 Display the source select screen



- Displays the status of connection with the cell-phone.  
White: The cell-phone is connected.  
Orange: The cell-phone is not connected, or it is outside the service range.

### 3 Display the Hands-Free Control screen

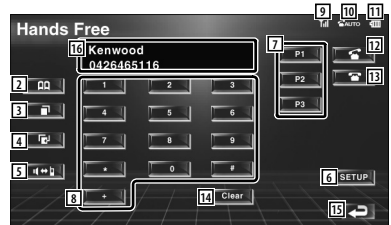

- Displays the Search for Phone Book screen. (See <Calling by Phone Book>, page 60)
- Displays the Out Going Calls screen. (See <Redialing>, page 62)
- Displays the Incoming Calls screen. (See <Redialing>, page 62)
- Switches between the private and hands-free modes (only when a call in progress).
- Displays the Hands-Free Set Up screen. (See <Setting up the Hands-Free Phone>, page 63)
- Enter three phone numbers for quick dialing. (See <Quick Dialing>, page 60)
- Enters a phone number. (See <When Dialing>, page 59)
- Displays the signal strength.\*  
The more the number of bar segments, the stronger the signal.
- Displays the present Auto Answering status  
When Auto Answering is on: AUTO  
When Auto Answering is off:
- Displays the battery drain of the cell-phone.\*  
The more the number of bar segments, the higher the battery level.
- Starts the call.
- Ends the call.  
Clears the phone number being entered.
- Clears the entered phone number.
- Returns to the previous screen.
- Displays the calling and called phone numbers.  
If you have registered a phone number in the Phone Book, the destination person name is displayed.



- While your car is moving, some functions are disabled for safety's sake. The buttons associated with the disabled functions become ineffective if pressed.
- When the Hands-Free Control screen appears, the name of the connected cell-phone is displayed for 5 seconds.
- \* Since the number of steps of the control unit is different from that of the cell-phone, the statuses displayed on the control unit may discord from those displayed on the cell-phone. No status is displayed if information about it cannot be obtained.
- Setting the cell-phone in the private mode can disable the hands-free function.

## When Called

When you receive a call, you can use the hands-free phone.

### 1 Respond to a call



When a call arrives, the Hands-Free Control screen appears automatically.

### 2 End the call



The previous screen reappears.

## When Dialing

Make a call by entering a phone number.

### 1 Enter a phone number

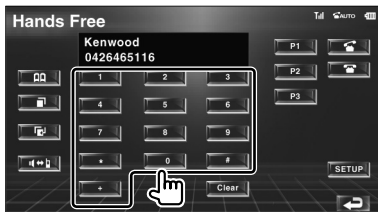

### 2 Make a call

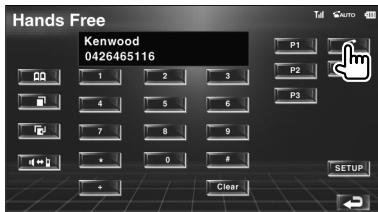

You can start talking when the destination responds.



- To clear your incorrect entry, touch **Clear** .

### 3 End the call

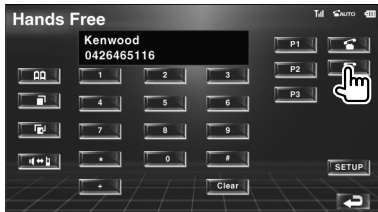

The previous screen reappears.



- You can input max 32 digits.

### Quick Dialing

You can register up to 3 phone numbers for quick dialing.

**To register a phone number:**

**1 Display a phone number you wish to register**

See the <Calling by Phone Book> (page 60), <Redialing> (page 62) and <When Dialing> (page 59).

**2 Register the phone number**

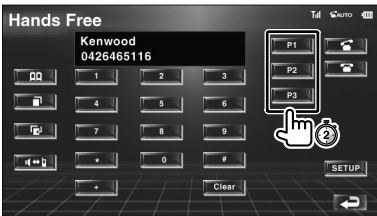

Continue to touch more than 2 seconds.

**To call a phone number from memory:**

**1 Recall the phone number**

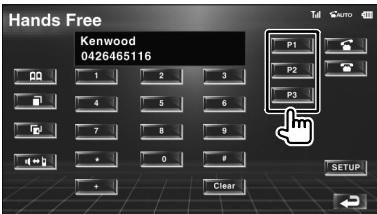

**2 Make a call**

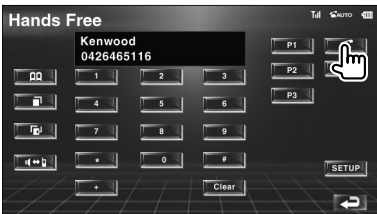

- Only the phone numbers can be registered for Quick Dialing. Therefore, the destination subscriber name and others are not displayed during dialing.

### Calling by Phone Book

You can call a person using his/her phone number that you have registered in the Phone Book.

**1 Display the Phone Book screen**

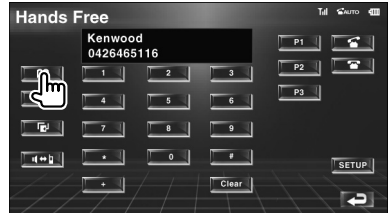

The Initial Input screen appears.



**Initial Input screen**

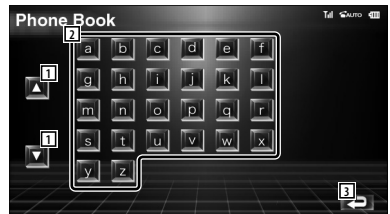

- 1 Scrolls the character array display.
- 2 Displays the Phone Book beginning with the name whose first character you have touched.
- 3 Returns to the Hands-Free Control screen.

**2 Select the initial character of a person name in memory**

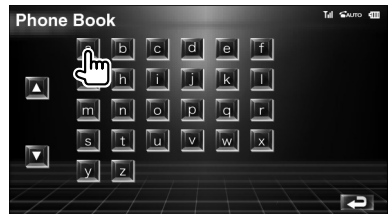

The Phone Book List screen appears.



## Phone Book List screen

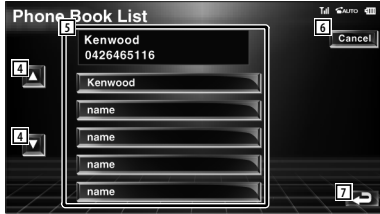

- 4 Scrolls the list.
- 5 Enters the destination name.
- 6 Cancels the operations.
- 7 Returns to the Hands-Free Control screen.

## 3 Select a destination you wish to call

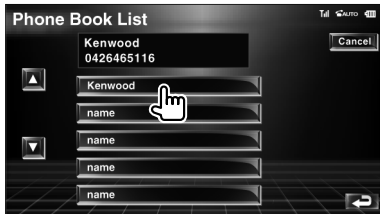

## 4 Confirm the destination

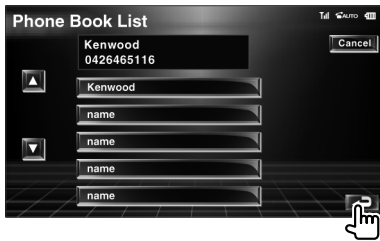

The Hands-Free Control screen appears again.  
The selected destination data is displayed.

## 5 Make a call

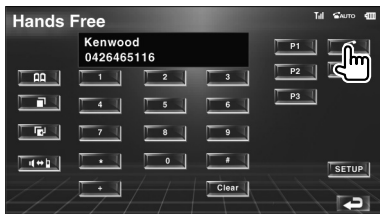

You can start talking when the destination responds.

## 6 End the call

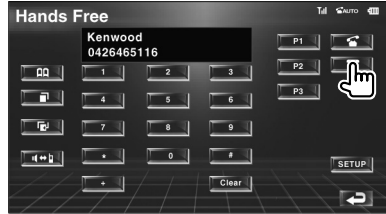

The previous screen reappears.



- To use the Phone Book, it must have been downloaded from the cell-phone. For more details, see the instruction manual of your bluetooth Hands Free Box and your cell phone.
- Up to 20 characters can be displayed for each name in the Phone Book.
- Initials including no corresponding name will not be displayed.
- During search, a non-accent character such as "u" is searched for instead of an accent character such as "ü".

## Redialing

You can redial, one of the last 10 phone numbers that you have called or received.

### 1 Display the Search for Out Going Calls or Incoming Calls screen

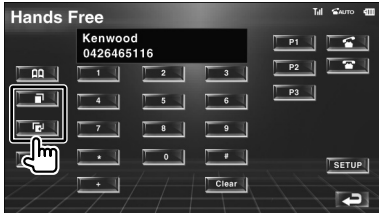

: Outgoing Calls

: Incoming Calls

The Outgoing Calls or Incoming Calls list screen appears.

### Out Going Calls or Incoming Calls screen



- 1 Scrolls the list.
- 2 Enters the destination name.
- 3 Switches the Redial List between 5 numbers display and single number display.
- 4 Enters the destination data and returns to the Hands-Free Control screen.
- 5 Returns to the Hands-Free Control screen.

### 2 Select a destination you wish to call



### 3 Confirm the destination

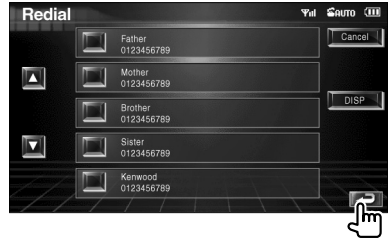

The Hands-Free Control screen appears again. The selected destination data is displayed.

### 4 Make a call

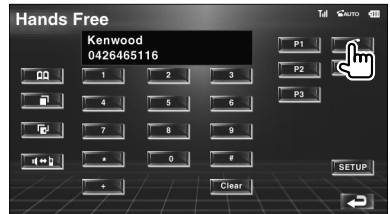

You can start talking when the destination responds.

### 5 End the call

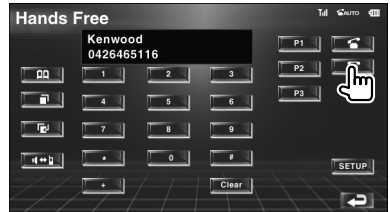

The previous screen reappears.



- The Out Going Calls list screen or Incoming Calls list screen shows the list of the calls originated from or received at this unit. They are not the ones stored in the cell-phone memory.

## Setting up the Hands-Free Phone

The Hands-Free system can be set as follows.

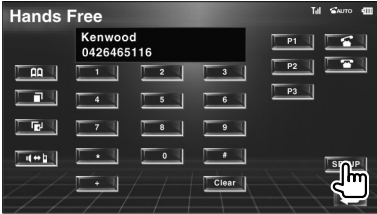

Hands-Free Set Up screen

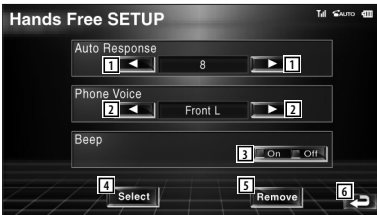

- 1 Sets an automatic response time after call termination. ( "8"  
"Off": This function can not use.  
"0-99":Sets to calling ring time (second).
- 2 Sets a ringing tone output position.  
( "Front-R")  
"Front-L": Outputs the tone from the front left-hand side speaker.  
"Front-R": Outputs the tone from the front right-hand side speaker.  
"Front All": Outputs the tone from the both front speakers.
- 3 Sets the beep of the incoming call.  
( "On")  
"On": Beep is heard.  
"Off": Beep is canceled.
- 4 Displays the Phone Select screen.
- 5 Displays the Phone Delete screen.
- 6 Returns to the Hands-Free Control screen.



- Either the time interval for automatic answer set on this unit or the time interval set on the cell-phone, whichever is shorter, takes effect.
- Select the speaker which is further from the microphone in order to prevent howling or echoes.

## Selecting a Hands-Free Phone

You can choose the Hands-Free phone from the list.

### 1 Display the Hands-Free Set Up screen

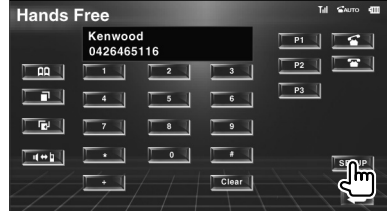

### 2 Display the Phone Select list

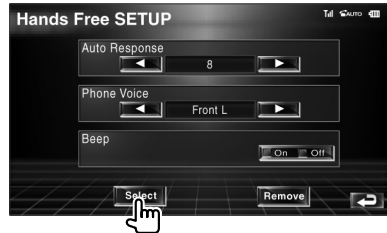

### Phone Select screen



- 1 Selects the cell-phone to be used as a hands-free phone.
- 2 Returns to the Hands-Free Set Up screen.

### 3 Select a Hands-Free phone you wish to use



## Deleting the Hands-Free Phone

You can cancel a registration of Hands-Free phone.

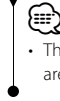

- The Phone Book, outgoing call list, and incoming call list are deleted together with the deleted Hands-Free phone.

### 1 Display the Hands-Free Set Up screen

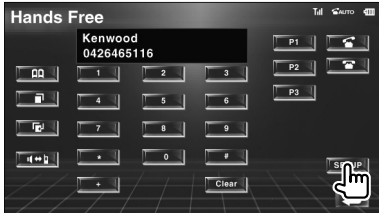

### 2 Display the Phone Delete list

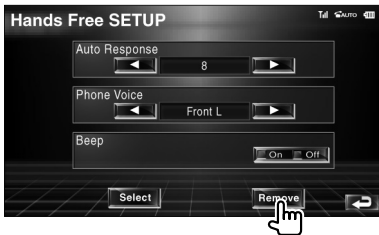

### Phone Delete screen

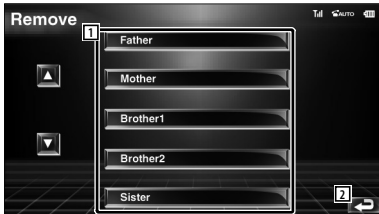

- 1 Selects the cell-phone to be deleted from the list.
- 2 Returns to the Hands-Free Set Up screen.

### 3 Select a Hands-Free phone you wish to delete







# Setup Menu

You can set up various receiver parameters.

## Setup Menu

Displays the Setup Menu to set various functions.

### 1 Display the control screen



Press several times until the control screen appears.

### 2 Display the setup Menu



### 3 Select the setup item

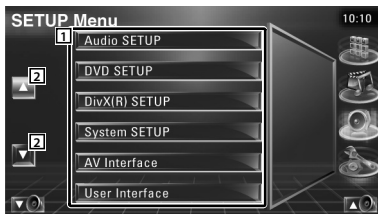

- 1 The selected setup screen appears.
- 2 Scrolls the setup menu.

## Audio Setup

You can setup a speaker network, etc.

### 1 Display the Audio SETUP screen

Touch [Audio SETUP] in the SETUP Menu (page 66).



- [Audio SETUP] cannot be selected when no source is selected.

### 2 Setup each item

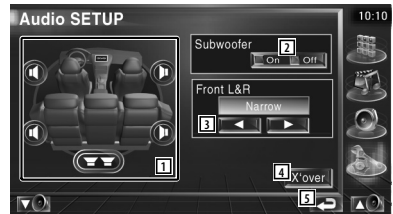

- 1 Selects the speaker to set the crossover. See <Crossover Network Setup> (page 67).
- 2 Sets the availability of subwoofers.
- 3 Selects the type of front speakers.  
"Standard": Setup for general diameter speakers  
"Narrow": Setup for small diameter speakers  
"Middle": Setup for middle diameter speakers  
"Wide": Setup for large diameter speakers
- 4 Switches to the crossover setup screen. See <Crossover Network Setup> (page 67).
- 5 Returns to the original screen.

## Crossover Network Setup

You can set a crossover frequency of speakers.

### 1 Select the speaker to set the crossover

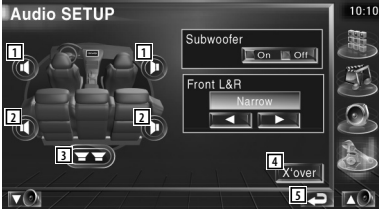

- 1 Sets the High Pass Filter of the front speaker.
- 2 Sets the High Pass Filter of the rear speaker.
- 3 Sets the Low Pass Filter of the sub woofer.
- 4 Switches to the crossover setup screen.
- 5 Returns to the original screen.

### 2 Display the Crossover setup screen



### 3 Set the crossover



- 6 Sets the cross over frequency.
- 7 Sets the sub woofer phase. (Only when "Subwoofer" is set to "On" in Audio setup and "LPF SUB FREQ" is set to other than "Through")
- 8 Returns to the original screen.

## DVD Setup

You can set up the DVD play.

### 1 Display the DVD SETUP screen

Touch [DVD SETUP] in the SETUP Menu (page 66).

### 2 Setup each item



- 1 Selects a disc menu language.\*1  
(See <Language Setup>, page 68)
- 2 Selects a subtitle language.\*1  
(See <Language Setup>, page 68)
- 3 Selects an audio language.\*1  
(See <Language Setup>, page 68)
- 4 Sets the dynamic range. (Wide)\*1  
The dynamic range is reduced by changing from "Wide" to "Normal" and from "Normal" to "Dialog". "Dialog" makes the total sound volume becomes larger as compared with "Wide" and "Normal", allowing you to listen to the movie's dialog more clearly. This is effective only when you are using a Dolby Digital software.
- 5 Returns to the original screen.



- \*1 Disabled when a DVD is being played.



- 6 Sets an angle mark display. (On)
- 7 Selects the screen display mode.\*1 (16:9)  
 "16:9": Displays wide pictures.  
 "4:3 LB": Displays wide pictures in the Letter Box format (having black stripes at the top and bottom of screen).  
 "4:3 PS": Displays wide pictures in the Pan & Scan format (showing pictures cut at the right and left ends).
- 8 Displays the Parental Lock screen.\*1 (Off)  
 (See <Parental Level Setup>, page 69)
- 9 Keep "Auto" to use.\*1



\*1 Disabled when a DVD is being played.

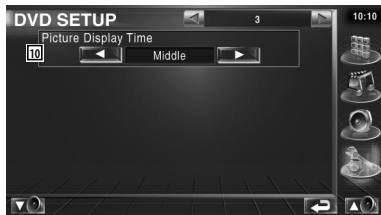

- 10 Selects a picture display time. \*1 (Middle)  
 The Display of a JPEG picture is changed.  
 "Short", "Middle", "Long"



\*1 Disabled when a DVD is being played.

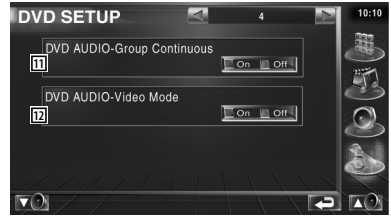

- 11 Switches Group Continuous On or Off. (Off)  
 If "Off" is selected, the group playback is stopped or menu screen is appeared at the end of the group playback.  
 If "On" is selected, the group playback is continued.
- 12 Switches the Video Mode of a DVD Audio disc On or Off. (Off)  
 If "On" is selected, a DVD Audio disc is played as a DVD Video disc.  
 If "Off" is selected, a DVD Audio disc is not played as a DVD Video disc.

## Language Setup

Selects a language you use for the speech and menus.

### 1 Select the language item to set

Refer to <DVD Setup> (page 67) and select [Menu Language], [Subtitle Language] or [Audio Language].

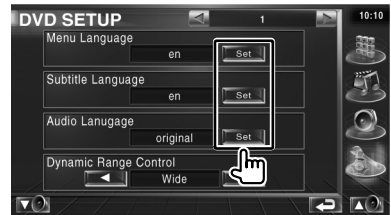

## 2 Display the Language Setup screen

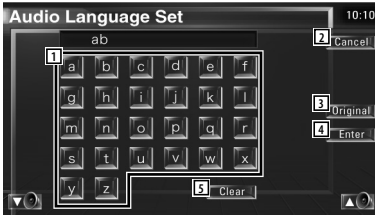

- 1 Enters a language code.
- 2 Cancels the language setup and returns to the DVD SETUP 1 screen.
- 3 Sets the original audio language.  
(It appears during Audio Language setup.)
- 4 Sets the language and returns to the DVD SETUP 1 screen.  
(It appears after you have entered a language code.)
- 5 Clears the language code.

## 3 Enter a language code

See <DVD language codes> (page 98) and select the desired language.

## 4 Set the language you use



## Parental Level Setup

Sets a parental level.

### 1 Display the Parental Level code number screen



Refer to <DVD Setup> (page 67) and touch [Parental Level].



- 1 Enters a code number.
- 2 Cancels the current setup and returns to the DVD SETUP 2 screen.
- 3 Indicates the present parental lock level.
- 4 Determines the code number and displays the Parental Level setup screen.
- 5 Clears the code number.

### 2 Enter the code number



- The number you enter first is set as your code number.
- You can clear the code number by pressing the Reset button.

Next page ►

**3 Display the Parental Level SETUP screen**

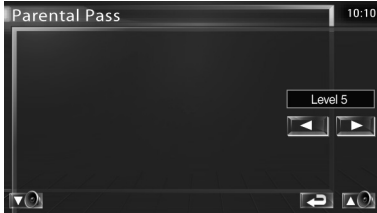

**4 Select a parental level and complete the setup**

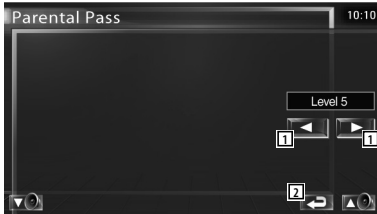

- 1 Selects a parental level.
- 2 Complete the parental level setup and returns to DVD SETUP 2 screen.



- If a disc has higher parental lock level, you need to enter the code number.
- The parental lock level varies depending on a loaded disc.
- If a disc has no parental lock, anybody can play it back even when you have set the parental lock.

**DivX Setup**

Checks the registration code. This code is needed when making a disc which has DRM (Digital Rights Management).

**1 Display the DivX SETUP screen**

Touch [DivX SETUP] in the SETUP Menu (page 66).



- 1 Displays the registration code.
- 2 Returns to the original screen.



- When downloading a DivX VOD file controlled by DRM, register the code appeared on the screen such as the one above. Otherwise the file may not be able to play with this unit.
- Remaining number of viewing is displayed when playing a DivX VOD file with the viewing restriction. When the remaining number of viewing reached 0, a warning message appears and the file cannot be played.

## iPod Setup

Performs setup when using iPod.

### 1 Display the iPod SETUP screen

Touch [iPod SETUP] in the SETUP Menu (page 66).

### 2 Setup each item

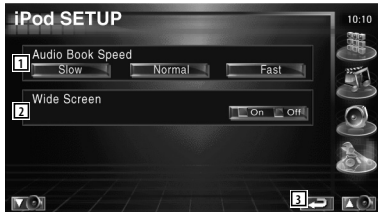

- 1 Sets the Audiobook playback speed.
- 2 Sets Wide Screen on or off.
- 3 Returns to the original screen.



- "Wide Screen" cannot be set while the iPod is connected.

## Software Information

Checks the software version of this unit.

### 1 Display the Software Information screen

Touch [Software Information] in the SETUP Menu (page 66).

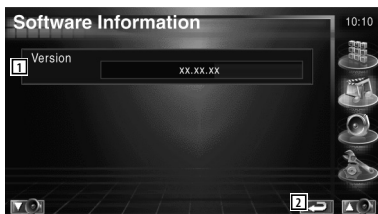

- 1 Displays the software version.
- 2 Returns to the original screen.

## System Setup

You can set up the system parameters.

### 1 Display the System SETUP screen

Touch [System SETUP] in the SETUP Menu (page 66).

### 2 Setup each item

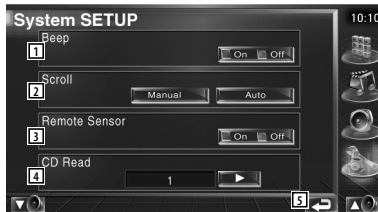

- 1 Turns the key touch tone On or Off. (📄 On)
- 2 Allows scrolling of text display on the Source Control screen. (📄 Manual)  
"Auto": Scrolls the screen automatically.  
"Manual": Allows you to scroll the screen manually.
- 3 Selects a remote control signal. (📄 On)  
When turned "Off", the remote control of TV reception is rejected.
- 4 Sets a music CD playback. (📄 1)  
"1": Automatically recognizes and plays back an Audio file disc, a DVD or a music CD.  
"2": Forcibly plays back a disc as a music CD. Select "2" if you wish to play a music CD having a special format or if you cannot play a disc in the "1" position.
- 5 Return to the original screen.



- You cannot play an Audio file/VCD disc in the "2" position. Also, you may not play some music CDs in the "2" position.
- Your setup is disabled when the disc is being played.

## AV Interface Setup

You can set audio and visual (AV) interface parameters.

### 1 Display the AV Interface screen

Touch [AV Interface] in the SETUP Menu (page 66).

### 2 Setup each item



- 1 Sets a name to be displayed when you select a system that is connected via the AV INPUT1 port. (📎 VIDEO1)



- If you have set the navigation system connection to "AV-IN", the display is fixed to "NAV1".

- 2 Sets an image display of the system that is connected via the AV INPUT2 port. (📎 Off)  
 "Off": When the image source is switched, an image entered via the AV INPUT2 port is displayed.  
 "On": When an image signal is entered via the AV INPUT2 port, this image is displayed.

- 3 Sets a name to be displayed when you select an image of the system that is connected via the AV INPUT2 port. (📎 VIDEO2)

- 4 Selects a navigation system connection. (📎 RGB)  
 "RGB": Allows the Kenwood's Navigation System to connect via its interface cable.  
 "AV-IN": Allows a third-party navigation system to connect via the AV INPUT port.  
 "Off": Must be used if no navigation system is connected. (The navigation display is cancelled when the AV source is switched.)

- 5 Return to the original screen.



- 6 Selects an AV source to be output at the AV OUTPUT port. (📎 AV-IN1)
- 7 Sets a method to switch to the rear view camera video display. (📎 Off)  
 "On": Switches to the rear view camera video display when engaging the shift knob of car to "Reverse".  
 "Off": Switches to the rear view camera video display when engaging the shift knob of car to "Reverse" and then pressing the [V.SEL] switch several times.
- 8 You can flip the left and right of the rear view camera video display. Set to "Reverse" and the rear view will be displayed left and right in mirror image on the screen. (📎 Off)

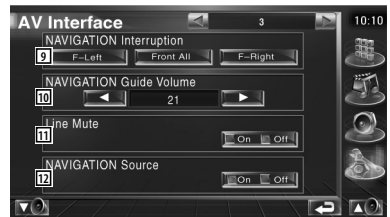

- 9 Selects speakers used for voice guidance of the navigation system. (📎 F-Left)  
 "F-Left": Uses the front left side speaker for voice guidance.  
 "F-Right": Uses the front right side speaker for voice guidance.  
 "Front All": Uses both front speakers for voice guidance.
- 10 Adjusts the volume for voice guidance of the navigation system. (📎 21)



- 11 Mutes the volume during voice guidance of the navigation system. (On)
 

When turned "On", the volume level drops for voice guidance.
- 12 Sets a selecting method of audio source from the Navigation system. (Off)
 

"On": Allows you to select the audio source input from the Navigation system interface by pressing [SRC] or selecting it on Source Select screen.

"Off": The audio source cannot be selected using [SRC] or on Source Select screen.

## User Interface

You can set up user interface parameters.

### 1 Display the User Interface screen

Touch [User Interface] in the SETUP Menu (page 66).

### 2 Setup each item



- 1 Selects the background to display.
 

"Change": Displays images entered into this unit. Refer to <Background Select> (page 76).
- 2 Enables entering or deleting of background images into of from this unit.
 

Press **▲** to enter the USB suspend mode, and then remove the USB device.

"Memory": Enables entering of background images. Refer to <Entering Background> (page 75).

"Delete": Enables deleting of background image entered into this unit. Refer to <Background Delete> (page 75).
- 3 Sets whether to display the target when touching the panel.
- 4 Sets the display method of the unrecognized characters.
 

"On": Displays in the Russian character.

"Off": Displays in the European character.
- 5 Returns to the original screen.

Next page ►

English ● 73



- 6 Sets an on-screen display of the iPod Playback screen. (Auto)
  - "Auto": Information is displayed for 5 seconds when updated.
  - "Manual": Information is displayed when you touch on the screen.
- 7 Sets an on-screen display of the navigation screen. (Off)
  - "Auto": Information is displayed for 5 seconds when updated.
  - "Off": Information is not displayed.
- 8 Sets an on-screen display of the Video1 playback screen. (Auto)
  - "Auto": Information is displayed for 5 seconds when updated.
  - "Manual": Information is displayed when you touch on the screen.
- 9 Sets an on-screen display of the Video2 playback screen. (Auto)
  - "Auto": Information is displayed for 5 seconds when updated.
  - "Manual": Information is displayed when you touch on the screen.
- 10 Returns to the original screen.



- 11 Sets an on-screen display of the DVD Playback screen. (Manual)
  - "Auto": Information is displayed for 5 seconds when updated.

"Manual": Information is displayed when you touch on the screen.





- 12 Sets an on-screen display of the TV screen. (Auto) (with the optional accessory TV tuner connected only)

"Auto": Information is displayed for 5 seconds when updated.

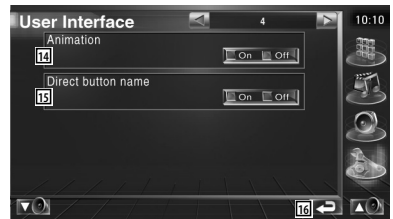
"Manual": Information is displayed when you touch on the screen.

- 13 Returns to the original screen.



- 14 Sets whether to display animation when switching screens. (On)
- 15 Sets whether to display the name of the
  - 
  - 
  - 
  - 
 buttons on the right side of the menu screen. (Off)
- 16 Returns to the original screen.

## Entering Background

Loads images for background.

- 1 Connect the device which has the image to load

- 2 Display the User Interface screen



- 3 Select the image to load

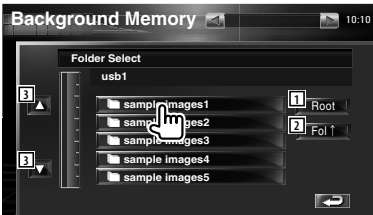

- 1 Returns to Media Select screen.
- 2 Returns to the previous folder.
- 3 Scrolls the list.

- 4 Load the image



- 4 Rotates the image.
- 5 Returns to the Picture Select screen.



- Refer to <About file files> (page 11) for readable image specifications.
- Up to 3 images can be loaded.
- This operation is not possible when USB is selected as the source.

## Background Delete

Deletes the background image.

- 1 Display Delete Image Select screen

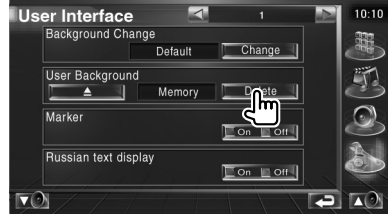

- 2 Select the image to be deleted

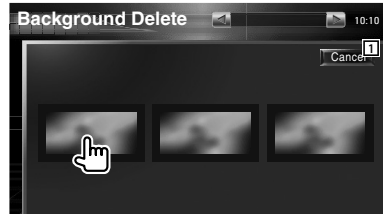

- 1 Returns to the original screen.

- 3 Delete the image

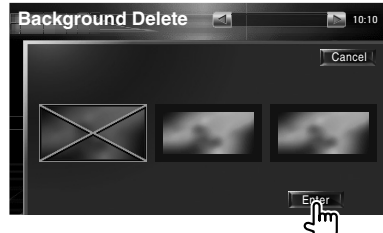

- 4 Confirm

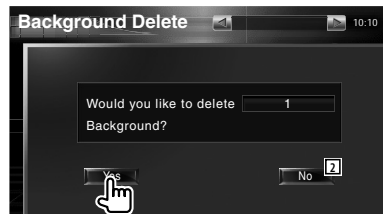

- 2 Returns to the Picture Select screen.

## Background Select

Selects a image for background.

### 1 Select Background Select screen



### 2 Select a image for background

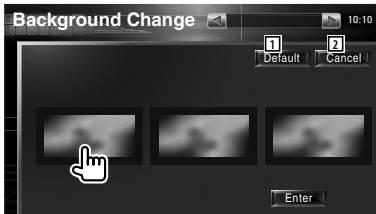

- 1 Returns to the initial background.
- 2 Returns to the original screen.

### 3 Set the image as the background

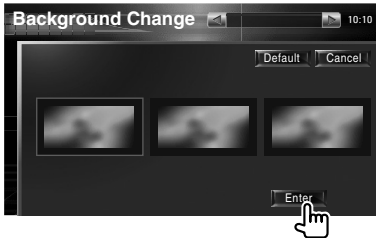

## Touch panel Adjustment

You can adjust the touch panel operations.

### 1 Display the Touch panel Adjustment screen

Touch [Touch] in the SETUP Menu (page 66).

### 2 Starts Touch panel setup



- 1 Returns to the original screen.

### 3 Adjusts the Touch panel

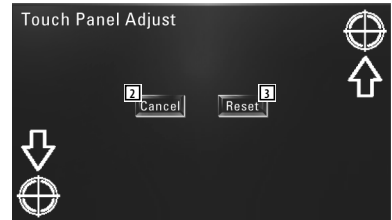

- Follow the instruction on the screen and touch the center of .
- 2 Cancels the adjustment and returns to the Touch Panel Adjust screen.
  - 3 Resets to the initial status.

## Clock Setup

You can adjust the clock time.

### 1 Display the Clock Setup screen

Touch [Clock] in the SETUP Menu (page 66).

### 2 Setup the Clock

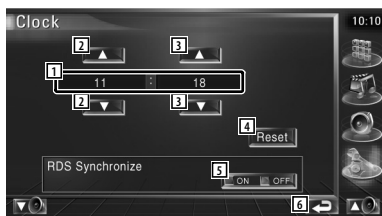

- 1 Clock time display
- 2 Adjusts hours.
- 3 Adjusts minutes.
- 4 Sets "00" minute.  
Setup examples: 3:00~3:29 ➔ 3:00  
3:30~3:59 ➔ 4:00
- 5 Sets the clock time in synchronization with the time data sent from the RDS station.  
 On  
When turned "On", the synchronized mode starts and the clock cannot be adjusted manually.
- 6 Returns to the original screen.

### 3 Adjust the clock time



## Monitor Setup

You can adjust the position, picture quality and the screen mode of the monitor.

### 1 Displaying the Monitor SETUP screen

Touch [Monitor SETUP] in the SETUP Menu (page 66).

### 2 Setup each item

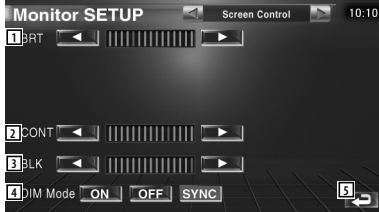

1 Brightness Control

2 Contrast Control

3 Black Level Adjustment

4 Dimmer Mode Setup

"SYNC": Turning the Dimmer function On or Off when the vehicle light control switch is turned On or Off.

"On": The display dims.

"Off": The display doesn't dim.

5 Returns to the original screen.



- In this Screen Control screen, you can perform setups for the menu screen. Setups for videos such as DVD can be performed on the <Screen Control> (page 57).

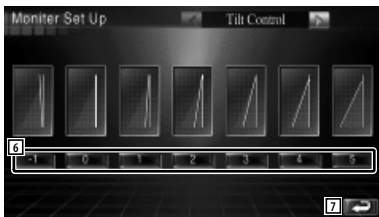

6 Sets the Monitor angle.

7 Returns to the original screen.

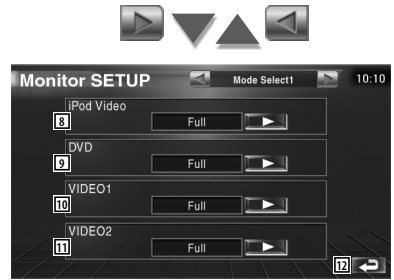

8 Selects a screen mode of the iPod Video playback screen.

You can select any of the following screen mode.

"Full", "Just", "Zoom", "Normal"

9 Selects a screen mode of the DVD playback screen.

You can select any of the following screen mode.

"Full", "Just", "Zoom", "Normal"

10 Selects a screen mode of the VIDEO1 playback screen.

You can select any of the following screen mode.

"Full", "Just", "Zoom", "Normal"

11 Selects a screen mode of the VIDEO2 playback screen.

You can select any of the following screen mode.

"Full", "Just", "Zoom", "Normal"

12 Returns to the original screen.

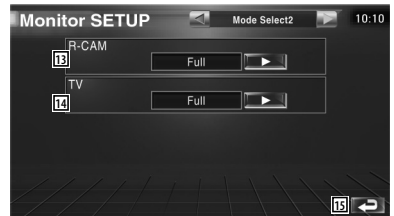

13 Selects a screen mode of the rear view camera (R-CAM) screen.

You can select any of the following screen mode.

"Full", "Just", "Zoom", "Normal"

14 Selects a screen mode of the TV screen.  
You can select any of the following screen mode.

"Full", "Just", "Zoom", "Normal"

15 Returns to the original screen.



- When you select the Menu, Easy Control screen, or Navigation, the display is shown in the full-size display mode automatically. The screen mode of these displays cannot be changed.
- The picture quality can be set for each source.

#### Full picture mode (Full)

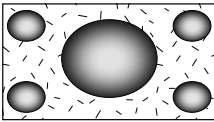

#### Zoom picture mode (Zoom)

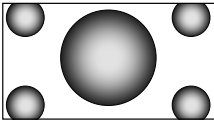

#### Justify picture mode (Just)

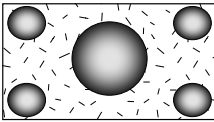

#### Normal picture mode (Normal)

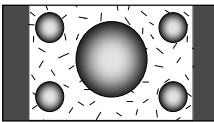

## Security Code Setup

You can set a security code to protect your receiver system against theft.



- When the Security Code function is activated it cannot be released.  
Note, your Security Code is the 4 digit number entered in your "Car Audio Passport" in this package.

### 1 Display the Security Code Setup screen

Touch [Security] in the SETUP Menu (page 66).



- Displays the Security code input screen.
- Turns the SI function on or off.  
If turned "On", the burglar alarm lamp flashes when the vehicle ignition is off. (On)
- Returns to the original screen.

### 2 Start Security Code setup



- If you have already completed the code registration, cannot touch **Set**.

### 3 Enter a security Code

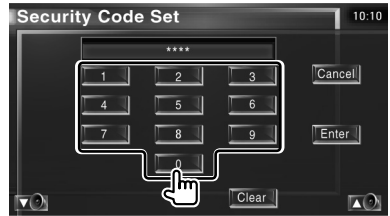

Input four-digit number.

### 4 Register your security code



### 5 Reenter the security code

Reenter the same security code as that you have entered in Step 3 for confirmation.



- If you enter a different security code, the screen returns to Step 3 (for the first code entry).

### 6 Register the security code again



Now, your security code is registered. If you press the Reset button or if you disconnect your receiver from the battery after the code registration, you need to enter the registered security code.



**If you have pressed the Reset button or if you have disconnected the Receiver from battery...**

**1 Enter the correct security code**

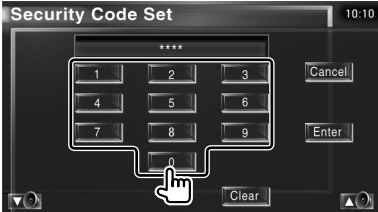

You must enter the same security code as that you have entered in Step 3.

**2 Enter the security code**



Now, you can use your Receiver.



- If you enter an incorrect security code, you cannot use your Receiver for a while.

Incorrect entry count	Receiver inoperable time
1	-
2	5 minutes
3	1 hour
4 or more	24hours

**TV Setup**

The TV signal receiving areas can be set. (with the optional accessory TV Tuner connected only)

**1 Displaying TV SETUP screen**

Touch [TV SETUP] in the SETUP Menu (page 66).

**2 Setting up TV**



- 1 Sets the present TV1 receiving area.
- 2 Returns to the original screen.



- 3 Sets the present TV2 receiving area.
- 4 Returns to the original screen.

## RDS Setup

The related RDS parameters can be set.

### 1 Display RDS SETUP screen

Touch [RDS SETUP] in the SETUP Menu (page 66).

### 2 Setting up RDS



- 1 Sets a news bulletin interrupt time.
- 2 Turns the Alternative Frequency function On or Off. (📄 On)
- 3 Turns the Region Restriction function On or Off. (📄 On)
- 4 Turns the Auto TP Seek function On or Off. (📄 On)
- 5 Returns to the original screen.



- 6 Selects a display language for the PTY function.
- 7 Returns to the original screen.

## DAB Setup

You can set the DAB reception. (only with the optional accessory DAB Tuner connected)

### 1 Display the DAB Setup screen

Touch [DAB Set Up] in the SETUP Menu (page 66).

### 2 Setting up DAB

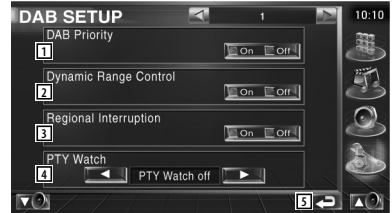

- 1 Turns the DAB Priority On or Off.
- 2 Turns the Dynamic Range Control function On or Off.
- 3 Turns the Regional Announcement function On or Off.
- 4 Sets a program type to be selected automatically when the receiving ensemble starts.
- 5 Returns to the original screen.



- 6 Displays the Announcement Selection screen. (page 83)

## Announcement Select

You can set various announcement reception parameters.

### 1 Display the Announcement screen

See <DAB Setup> (page 82).

### 2 Set the announcement parameters



1 Turns the Announcement Reception function On or Off.

2 Returns to the original screen.

## AMP Control

Sets the power amp connected via the LX bus. (with the optional accessory LX Power Amp connected only)

### 1 Displaying the Amp Control screen

Touch [Amp Control] in the SETUP Menu (page 66).

### 2 Setting up Amp Control

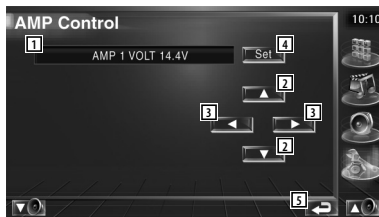

1 Setup option and value display

2 Select a setup option.

3 Selects a set value.

4 Enters the set value.

5 Returns to the original screen.



- For the model name of amp you can control from the system, see the amp's catalog.
- For the options and values you can change and for the amp's operation when changed, see the amp's instruction manual.

## Setup Memory

Audio Set Up and AV Interface settings can be memorized. The memorized settings can be recalled at any time. For example, even when the settings are cleared due to replacement of the battery, the settings can be restored.

### 1 Display the SETUP Memory screen

Touch [SETUP Memory] in the SETUP Menu (page 66).

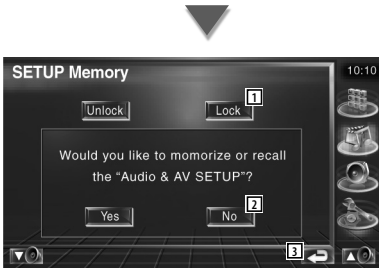

- 1 Locks the Audio Set Up and AV Interface settings. When **Lock** is selected, you cannot set the Audio Set Up and AV Interface settings.
- 2 Memorizes or recalls the settings. To cancel the function, touch **No**. To cancel memorization, touch **No**. The Setup Menu screen appears again.
- 3 Returns to the original screen.

### 2 Start Set Up Memory

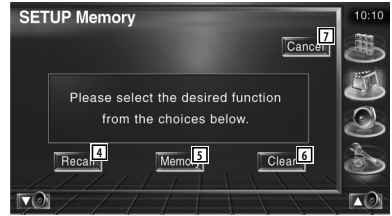
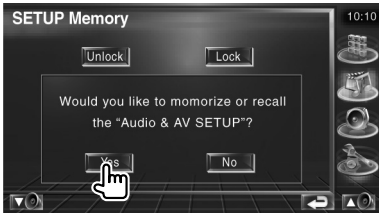

- 4 Recalls the memorized settings.
- 5 Memorizes the current Audio Set Up and AV Interface settings.
- 6 Clears the currently memorized settings.
- 7 Returns to Set Up Memory screen.

### 3 Memorize or recall the settings

**When memorizing the Audio Set Up and AV Interface settings:**

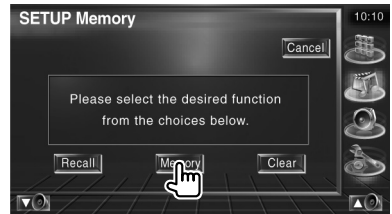

If settings have already been memorized, a confirmation message appears. Touch **Yes**. To cancel memorization, touch **No**.

**When recalling the memorized settings:**



Touching the screen displays a confirmation message. Touch **Yes**. To cancel recalling, touch **No**.

**When clearing the currently memorized settings:**



Touching the screen displays a confirmation message. Touch **Yes**. To cancel clearing, touch **No**.

**4 Quit memorization/recalling of settings**

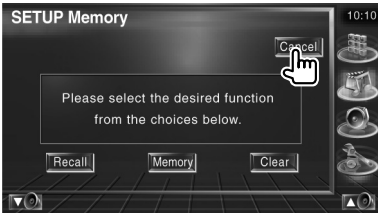

**EXT SW Setup**

Setting up power specification of the external device for which the power is controlled from this unit.

**1 Display the EXT SW SETUP screen**

Touch [Ext SW SETUP] in the SETUP Menu (page 66).

**2 Perform EXT SW Setup**

**Setting EXT SW Control 1 (EXT SW1)**

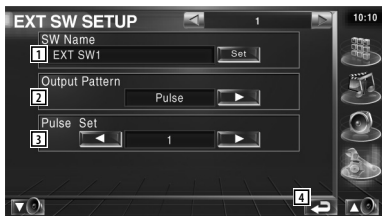

1 Sets the name of the external device. See <Character Entry> (page 56) for information on how to enter the name.

2 Sets the power signal output mode.  
 (EXT SW1: Pulse, EXT SW2: Level)  
 Pulse: Generates a single power signal pulse.



Level: Continues output of high power signal.



Sets to turn output on/off each time the button on the EXT SW Control screen is pressed.

3 Sets the Pulse signal output time. Outputs 500ms when "1" is set. Increases by 200ms with each step. Up to 100 steps can be set.

4 Returns to the original screen.



**Setting EXT SW Control 2 (EXT SW2)**

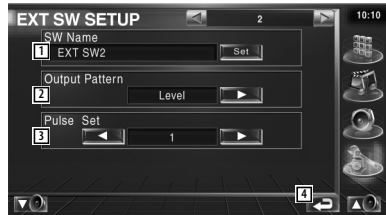

The setup method is the same as "EXT SW1".

# Audio Control

## Audio Control Menu

Displays the Audio Control menu to set the sound effect function of this unit.

### 1 Display the control screen



Press several times until the control screen appears.

### 2 Display the Audio Control menu



### 3 Select the Audio Control item

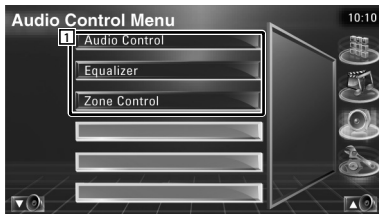

- 1 Switches to the selected Audio Control screen.

## Audio Control

You can adjust the front/rear and right/left audio balance.

### 1 Display Audio Control



Touch [Audio Control] in the Audio Control Menu (page 86).

### 2 Display the Audio Control screen

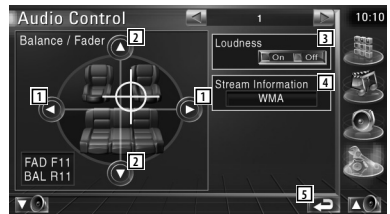

- 1 Adjusts the right and left volume balance.
- 2 Adjusts the front and rear volume balance.
- 3 Turns the Loudness control function On or Off.  
If turned "On", high and low tones are automatically enhanced during low volume.
- 4 Displays the present source information.  
The stream (Dolby Digital, dts, Linear PCM, MPEG or MP3/WMA), input channels (front or rear channels) are displayed.
- 5 Returns to the original screen.

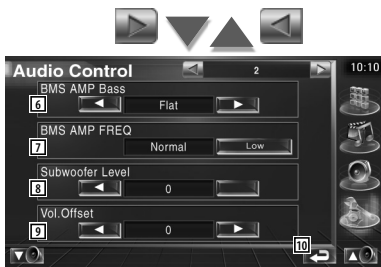

- 6 Adjusts the bass boost of the B.M.S power amplifier (optional accessory).
- 7 Sets the center frequency of bass boost you have set for "AMP Bass".  
If you set the center frequency to "Low", it will be dropped approximately 20% to 30%.
- 8 Adjusts the subwoofer volume.
- 9 Adjusts the volume of the present source based on the difference level of original volume.
- 10 Returns to the original screen.



- If you have increased the volume first, then reduced the volume using the "Vol. Offset", the sound generated if you suddenly switch to another source may be extremely loud.
- You may not set some models of power amp boost to "+18". See the catalog or instruction manual of power amplifier.

## Equalizer Control

You can set up the equalizer.

### 1 Display Equalizer Control



Touch [Equalizer] in the Audio Control Menu (page 86).

### 2 Display the Equalizer screen



- 1 Selects an equalizer curve type.  
You can select any of the following equalizer curves.
  - "Natural"
  - "Rock"
  - "Pops"
  - "Easy"
  - "Top40"
  - "Jazz"
- 2 Selects items to be adjusted for tone curve setup.  
If turned "Off", only Level can be setup for tone curves.
- 3 Displays the Tone curve setup screen. (page 88)
- 4 Returns to the original screen.

## Tone Setup

You can set a Tone curve.

### 1 Display the Tone screen

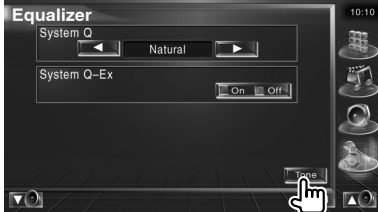

See <Equalizer Control> (page 87).

### 2 Set the Tone



- 1 Bass adjustment items are displayed.
- 2 Middle adjustment items are displayed.
- 3 Treble adjustment items are displayed.
- 4 Bass DC Extend settings (Only when Bass is selected)  
If turned "On", it extends the bass center frequency to the low register by approximately 20%.
- 5 Tone curve becomes flat.
- 6 Sets the Center frequency.
- 7 Sets the level.
- 8 Sets the Q factor. (Only Bass and Middle can be set)
- 9 Returns to the original screen.

## Zone Control

You can set the front and rear audio source.

### 1 Display Zone Control



Touch [Zone Control] in the Audio Control Menu (page 86).



### 2 Set the Zone Control

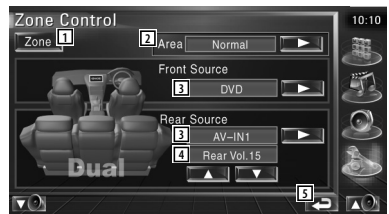

- 1 Turns the Zone Function (that sets different source sounds for front and rear speakers) On or Off.
- 2 Switches the front and rear audio sources. (This button appears when the Zone function is On.)  
Use "Reverse" to change over the front and rear audio sources.
- 3 Sets the front and rear audio source separately. (This button appears when the Zone function is On.)





- When the rear speaker sound is switched, the audio source that is output at the AV OUTPUT terminal is also switched to the same source.  
However, if you have set the "Area" to "Reverse", the audio source that is output at the AV OUTPUT terminal is switched depending on the front sound source.
  - 4 Adjusts the volume of the rear channel.  
(This button appears when the Zone function is On.)
  - 5 Returns to the original screen.



- There are following limitations when zone function is set to "On".
  - There is no output from the subwoofer.
  - <Audio Setup> (page 66) and <Equalizer Control> (page 87) are not available.

# Remote Controller

This unit can be operated using the Remote Controller supplied with the unit.



- Put the Remote Controller in a place where it will not move during braking or other operations. A dangerous situation could result, if the Remote Controller falls down and gets wedged under the pedals while driving.
- Do not place the battery near an open flame or heat source. This may cause the battery to explode.
- Do not recharge, short, break up or heat the battery or place it in an open fire. Such actions may cause the battery to leak fluid. If spilled fluid comes in contact with your eyes or on clothing, immediately rinse with water and consult a physician.
- Place the battery out of reach of children. In the unlikely event that a child swallows the battery, immediately consult a physician.

## Battery installation

Use two "AAA"/"R03"-size batteries.

Slide the cover while pressing downwards to remove it as illustrated.

Insert the batteries with the  $\oplus$  and  $\ominus$  poles aligned properly, following the illustration inside the case.

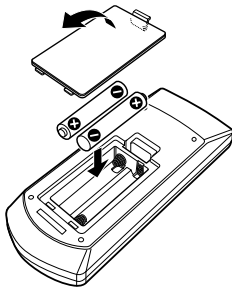

- If the Remote Controller operates only over shorter distances or does not operate at all, it is possible that the batteries are depleted. In such instances, replace the both batteries with new ones.

## Remote Controller mode switch

The functions operated from the remote controller differ depending on the position of the mode switch.

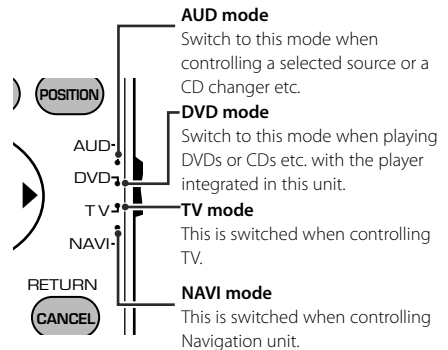

- The position of the remote control mode switch is indicated in the title of each mode, e.g., "(AUD mode)".
- When controlling a player that is not integrated in the unit, select "AUD" mode.

## Common operations (AUD mode)

### Source switching

Switches to the source to be played.

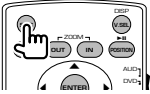

### Volume control

Adjusts the volume.

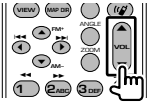

### Volume attenuator

Press the key once to lower the volume. Press again to restore the previous volume.

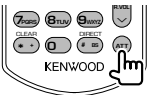

### Dual Zone

Switches the Dual Zone function ON and OFF.

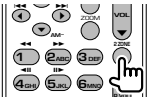

### Rear volume control

Adjusts volume at rear when the Dual Zone function is ON.

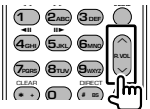

### V.SEL

Switch video

Switches the video each time it is pressed.

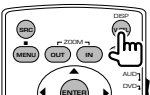

### Display angle

Switches the display angle each time it is pressed.

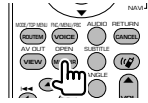

### Cursor key

Moves the cursor when displaying menu.

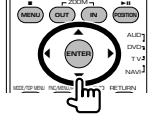

### ENTER

Enters options.

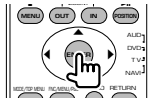

### Hands-free communication

Enters the dialing method selection mode.

When a call comes in, it answers the call.

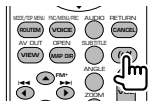

### Function

Switches the function screen



### MODE

Switches the screen mode.

Screen mode changes each time you press this key.



**DVD/DVD Audio/VCD/CD/Audio files  
(DVD mode)**

**Folder search**

Selects the folder to be played.

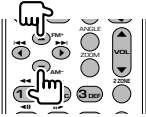

**Track search and file search**

Selects the track or file to be played.

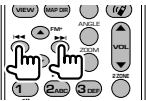

**Play/Pause**

Pauses the track.

Press again to resume playing.

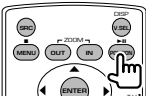

**Stop**

Memorizes the last point where the disc stopped.

When pressed again, the last point is deleted.

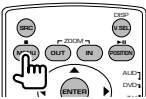

**Direct search**

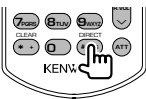

Pressing this button switches the features that can be searched directly.

**DVD**

- \_\_\_\_\_ Title number
- \_\_\_\_\_ Chapter number
- \_\_\_\_\_ Play time
- \_\_\_\_\_ Item number\*
- \_\_\_\_\_ Cancel

\* You may not be able to use this function with some discs or scenes.

**DVD Audio**

- \_\_\_\_\_ Group number
- \_\_\_\_\_ Track number
- \_\_\_\_\_ Item number\*
- \_\_\_\_\_ Cancel

\* You may not be able to use this function with some discs or scenes.

**CD**

- \_\_\_\_\_ Track number
- \_\_\_\_\_ Play time
- \_\_\_\_\_ Cancel

**Audio files**

- \_\_\_\_\_ Folder number
- \_\_\_\_\_ File number
- \_\_\_\_\_ Cancel

**VCD 1.X, VCD 2.X (PBC OFF)**

- \_\_\_\_\_ Track number
- \_\_\_\_\_ Cancel

**VCD 2.X (PBC ON)**

- \_\_\_\_\_ Scene number
- \_\_\_\_\_ Number
- \_\_\_\_\_ Cancel

Once you have switched to the direct search feature, specify the search number from the numeric keypad, and then press [ENTER] key.

**Numeric keypad**

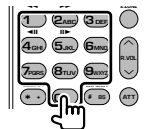

- Specify the number to search in direct search.
- Press **1** **2** to fast forward/backward. Switches the fast forward/backward speed each time you press this key.
- Press **4** **5** to slow forward/backward. Switches the slow playback speed each time you press this key.

## DVD Top Menu

Returns to the DVD top menu.



## DVD Menu

Displays the DVD menu.

Turns the playback control on or off while playing VCD.

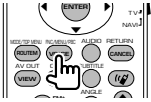

## Subtitle

Switches the subtitle language.



## Zoom

Switches the zoom ratio each time you press this key.

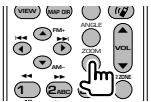

## Picture Angle

Switches the picture angle each time you press this key.

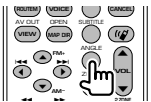

## AUDIO

Switch Voice Language

Switches the voice language each time you press this key.



## TV (TV mode)

### Switching Band/Video

Switches between the station of the TV band to receive and video input.

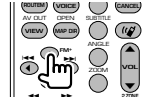

### Channel Selection

Selects the TV channel to be received.

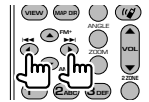

### Numeric keypad

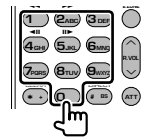

- The number of the memorized station is selected. (1 - 6)
- Press the direct tuning key first, then specify the channel of the station to receive.

**Radio (AUD mode)**

**Band switching**

Switches to bands received by the unit.

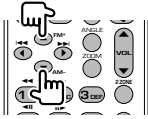

**Station selection**

Switches to broadcast stations received by the unit.

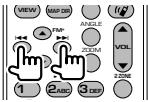

**Direct tuning**

After pressing this key, use the keypad to specify the broadcast station you wish to receive.

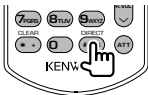

Example: 92.1MHz (FM)



Example: 810kHz (AM)



**Numeric keypad**

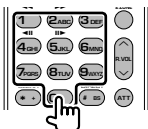

- To use preset tuning, press the number of a programmed broadcast station. (1 – 6)
- Press the direct tuning key first, then specify the frequency of the station to receive.

**NAVI (NAVI mode)**

**Joystick**

Scrolls the map, or moves the cursor.

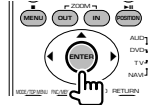

**ENTER**

Performs the selected function.

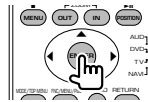

**Zoom**

Zooms in or out the navigation map.

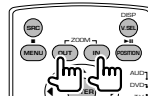

**MENU**

Displays Main menu.

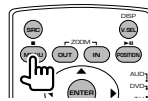

**CANCEL**

Displays previous screen.

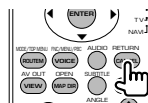

**POSITION**

Displays the current position.

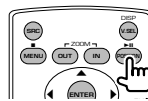

## ROUTEM

Displays Route Option menu.

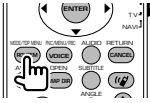

## VIEW

Switches between 2D and 3D map displays.

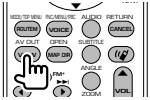

## VOICE

Plays Voice guidance.

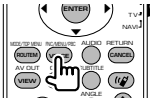

## MAP DIR

Switches between the heading up navigation and north up navigation map displays.

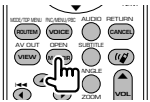

## Hands-free communication

Enters the dialing method selection mode.

When a call comes in, it answers the call.

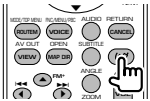

# Help? Troubleshooting

Some functions of this unit may be disabled by some settings made on this unit.

- ❗ **Cannot set up the subwoofer.**
- ❗ **Cannot set up subwoofer phase.**
- ❗ **No output from the subwoofer.**
- ❗ **Cannot set up the low pass filter.**
- ❗ **Cannot set up the high pass filter.**
  - ▶ Subwoofer is not set to On.  
☞ <Audio Setup>(page 66)
  - ▶ The Dual zone function is enabled.  
☞ <Zone Control> (page 88)

- ❗ **Cannot set up the subwoofer phase.**
  - ▶ Subwoofer is not set to On.  
☞ <Audio Setup>(page 66)
  - ▶ Low pass filter is set to Through.  
☞ <Crossover Network Setup> (page 67)

- ❗ **Cannot select the output destination of the subsource in the Dual zone.**
- ❗ **Cannot adjust the volume of the rear speakers.**
  - ▶ The Dual zone function is disabled.  
☞ <Zone Control> (page 88)

- ❗ **Cannot play audio files.**
  - ▶ "CD Read" of <System Setup> (page 71) is set to "2".

- ❗ **Cannot Folder select.**
  - ▶ The Scan play or Random play function is enabled.

- ❗ **Cannot perform Repeat play.**
  - ▶ The PBC function is enabled.

- ❗ **Cannot set up the equalizer.**
- ❗ **Cannot set up the crossover network.**
  - ▶ The Dual zone function is enabled.  
☞ <Zone Control> (page 88)

What might seem to be a malfunction in your unit may just be the result of slight misoperation or miswiring. Before calling service, first check the following table for possible problems.

## General

- ❓ **The Touch Sensor Tone doesn't sound.**
  - ✓ The preout jack is being used.
  - ☞ The Touch Sensor Tone can't be output from the preout jack.

## Tuner source

- ❓ **Radio reception is poor.**
  - ✓ The car antenna is not extended.
  - ☞ Pull the antenna out all the way.
  - ✓ The antenna control wire is not connected.
  - ☞ Connect the wire correctly, referring to the section on <INSTALLATION MANUAL>.

## Disc source

- ❓ **The specified disc does not play, but another one plays instead.**
  - ✓ The specified CD is quite dirty.
  - ☞ Clean the CD.
  - ✓ The disc is loaded in a different slot from that specified.
  - ☞ Eject the disc magazine and check the number for the specified disc.
  - ✓ The disc is severely scratched.
  - ☞ Try another disc instead.

## Audio file source

- ❓ **The sound skips when an Audio file is being played.**
  - ✓ The media is scratched or dirty.
  - ☞ Clean the media, referring to the CD cleaning of the section on <Handling CDs> (page 8).
  - ✓ The recording condition is bad.
  - ☞ Record the media again or use another media.



---

## When the unit fails to operate correctly, the cause of the failure appears on the display.

### Protect :

Protective circuit has been activated because a speaker cord has shorted or it has come in contact with the car chassis.

- ➔ Wire or insulate the speaker cord as appropriate and then push the Reset button.

---

### Hot Error :

When the internal temperature of this unit rises to 60°C or more, the protection circuit is activated and you may not be able to operate the unit. At such times this message will appear.

- ➔ Use the unit again after reducing the temperature inside the vehicle.

---

### Hold Error :

Activation of the protective circuit when the temperature inside the disc changer is higher than 60 degrees Celsius stops the disc changer from operating. At such times this message will appear.

- ➔ Use when the temperature at the site where the disc changer has been fitted has dropped.

---

### Mecha Error :

The disc player is malfunctioning.

- ➔ Eject the disc and try inserting it again. Contact the Kenwood dealer if this indicator continues blinking or the disc cannot be ejected.

---

### Disc Error :

An unplayable disc is inserted.

---

### Read Error :

- Disc is quite dirty.
  - ➔ Clean the disc, referring to the section on <Handling CDs> (page 8).
- Disc is upside down.
  - ➔ Load the disc with the labeled side up.

---

### Region code Error :

The disc you wanted to play has a region code that cannot be played with this unit.

---

### Parental level Error:

The disc you wanted to play has a higher level than the parental level you set.

---

### Error 07-67:

The unit is not operating correctly due to some reason or other.

- ➔ Push the unit's Reset button. If the "Error 07-67" message does not disappear, see your nearest Kenwood dealer.

---

### No Device (USB device)/ Disconnected (iPod):

The USB device/iPod is selected as a source although no USB device/iPod is connected.

- ➔ Change the source to any source other than USB/iPod. Connect an USB device/iPod, and change the source to USB/iPod again.

---

### No Music:

The connected USB device contains no playable audio file.

Media was played that doesn't have data recorded that the unit can play.

---

### USB Device Error!!:

The connected USB device is rated a current capacity higher than the allowable limit.

- ➔ Check the USB device.
  - Some trouble may have occurred to the connected USB device.
- ➔ Change the source to any source other than USB. Remove the USB device.

---

### Authorization Error:

Connection to the iPod has failed.

- ➔ Remove the iPod and then reconnect it.
- The unit does not support the iPod.
- ➔ Refer to <About iPod that can be connected to this unit> (page 7).

---

### Update your iPod:

The iPod's software is an older version which the unit can not support.

- ➔ Confirm that the software for the iPod is the latest version. Refer to <About iPod that can be connected to this unit> (page 7).

---

### EXT SW: Error:

Connection to the external device has failed.

- ➔ Remove the external device and then reconnect it.
- ➔ Turn off the power or ACC and turn it back on.

---

### You can connect only one iPod:

More than one iPod are connected to this unit.

- ➔ Disconnect all the iPods, and then reconnect only one.

# DVD language codes

Code	Language
aa	Afar
ab	Abkhazian
af	Afrikaans
am	Amharic
ar	Arabic
as	Assamese
ay	Aymara
az	Azerbaijani
ba	Bashkir
be	Byelorussian
bg	Bulgarian
bh	Bihari
bi	Bislama
bn	Bengali, Bangla
bo	Tibetan
br	Breton
ca	Catalan
co	Corsican
cs	Czech
cy	Welsh
da	Danish
de	German
dz	Bhutani
el	Greek
en	English
eo	Esperanto
es	Spanish
et	Estonian
eu	Basque
fa	Persian
fi	Finnish
fj	Fiji
fo	Faroese
fr	French
fy	Frisian
ga	Irish
gd	Scots Gaelic
gli	Galician
gn	Guarani
gu	Gujarati
ha	Hausa
he	Hebrew
hi	Hindi
hr	Croatian
hu	Hungarian
hy	Armenian
ia	Interlingua
ie	Interlingue
ik	Inupiak
id	Indonesian

Code	Language
is	Icelandic
it	Italian
ja	Japanese
jav	Javanese
ka	Georgian
kk	Kazakh
kl	Greenlandic
km	Cambodian
kn	Kannada
ko	Korean
ks	Kashmiri
ku	Kurdish
ky	Kirghiz
la	Latin
lb	Luxembourgish
ln	Lingala
lo	Laotian
lt	Lithuanian
lv	Latvian, Lettish
mg	Malagasy
mi	Maori
mk	Macedonian
ml	Malayalam
mn	Mongolian
mo	Moldavian
mr	Marathi
ms	Malay
mt	Maltese
my	Burmese
na	Nauru
ne	Nepali
nl	Dutch
no	Norwegian
oc	Occitan
om	(Afan) Oromo
or	Oriya
pa	Punjabi
pl	Polish
ps	Pashto, Pushto
pt	Portuguese
qu	Quechua
rm	Rhaeto-Romance
rn	Kirundi
ro	Romanian
ru	Russian
rw	Kinyarwanda
sa	Sanskrit
sd	Sindhi
sg	Sangho
sh	Serbo-Croatian

Code	Language
si	Singhalese
sk	Slovak
sl	Slovenian
sm	Samoa
sn	Shona
so	Somali
sq	Albanian
sr	Serbian
ss	Siswati
st	Sesotho
su	Sundanese
sv	Swedish
sw	Swahili
ta	Tamil
te	Telugu
tg	Tajik
th	Thai
ti	Tigrinya
tk	Turkmen
tl	Tagalog
tn	Setswana
to	Tongan
tr	Turkish
ts	Tsonga
tt	Tatar
tw	Twi
uk	Ukrainian
ur	Urdu
uz	Uzbek
vi	Vietnamese
vo	Volapuk
wo	Wolof
xh	Xhosa
yo	Yoruba
zh	Chinese
zu	Zulu



# Specifications

## Monitor section

### Picture size

: 6.95 inches (diagonal) wide  
156.2 x 82.4 mm

### Display system

: Transparent TN LCD panel

### Drive system

: TFT active matrix system

### Number of pixels

: 336,960 (480Hx234VxRGB)

### Effective pixels

: 99.99%

### Pixel arrangement

: RGB striped arrangement

### Back lighting

: Cold Cathode Fluorescent Tube

## DVD section

### D/A Converter

: 24 bit

### Decoder

: Linear PCM/ Dolby Digital/ dts/ MLP/ MP3/  
WMA/AAC

### Wow & Flutter

: Below Measurable Limit

### Frequency Response

Sampling frequency; 192 kHz : 20 – 88,000 Hz  
Sampling frequency; 176.4 kHz : 20 – 80,000 Hz  
Sampling frequency; 96 kHz : 20 – 44,000 Hz  
Sampling frequency; 88.2 kHz : 20 – 40,000 Hz  
Sampling frequency; 48 kHz : 20 – 22,000 Hz  
Sampling frequency; 44.1 kHz : 20 – 20,000 Hz

### Total Harmonic Distortion

: 0.008% (1 kHz)

### S/N Ratio (dB)

: 100dB(DVD-Audio 192k)

### Dynamic Range

: 100dB(DVD-Audio 192k)

### DISC Format

: DVD-Audio/DVD-Video/VIDEO-CD/CD-DA

### Sampling frequency

: 44.1kHz/48kHz/88.2kHz/96kHz/176.4kHz/192kHz

### Quantifying bit number

: 16/ 20/ 24 bit

## USB IF section

### USB Standard

: USB 1.1 / 2.0

### File System

: FAT 16/32

### Maximum Power Supply Current

: 500mA

### D/A Converter

: 24Bit

### Decoder

: MP3/WMA/AAC

## FM tuner section

### Frequency Range

: 87.5MHz – 108.0MHz (50kHz)

### Usable Sensitivity (S/N : 26 dB)

: 0.7  $\mu$ V/75  $\Omega$

### Quieting Sensitivity (S/N : 46 dB)

: 1.6  $\mu$ V/75  $\Omega$

### Frequency Response ( $\pm$ 3.0 dB)

: 30 Hz – 15 kHz

### S/N

: 65dB(MONO)

### Selectivity ( $\pm$ 400 kHz)

:  $\geq$  80 dB

### Stereo Separation

: 35dB(1kHz)

## LW Tuner section

Frequency Range (9 kHz)

: 153kHz – 281kHz

Usable Sensitivity

: 45 $\mu$ V

## MW Tuner section

Frequency Range (9 kHz)

: 531kHz – 1611kHz

Usable Sensitivity

: 25 $\mu$ V

## Video section

Color system of external video input

: NTSC/PAL

External video input level (RCA jacks)

: 1Vp-p/75 $\Omega$

External audio max input level (RCA jacks)

: 2V/25k $\Omega$

Analog RGB input

: 0.7Vp-p/75 $\Omega$

Video Output level (RCA jacks)

: 1Vp-p/75 $\Omega$

Audio Output level (RCA jacks)

: 1.2V/10k $\Omega$

## Audio section

Maximum Power (Front&Rear)

: 50W $\times$ 4

Full Bandwidth Power (Front&Rear)

(PWR DIN45324,+B=14.4v)

: 30W $\times$ 4

Preout level (V)

: 5V/10k $\Omega$

Preout impedance

: 80 $\Omega$

Speaker impedance

: 4 – 8  $\Omega$

Tone action

Bass: 100 Hz  $\pm$ 8 dB

Middle: 1 kHz  $\pm$ 8 dB

Treble: 10 kHz  $\pm$ 8 dB

## External SW

Maximum Power Supply Current

: 500mA

## General

Operating voltage

: 14.4 V (11 – 16 V allowable)

Current Consumption

: 15 A

Installation Size (W  $\times$  H  $\times$  D)

: 182  $\times$  112  $\times$  163 mm

Operational Temperature Range

: -10  $^{\circ}$ C – +60  $^{\circ}$ C

Storage Temperature Range

: -20  $^{\circ}$ C – +85  $^{\circ}$ C

Weight

: 2.75 kg

Specifications subject to change without notice.

Although the effective pixels for the liquid crystal panel is given as 99.99% or more, 0.01% of pixels may not light or may light incorrectly.

## **About DivX**

DivX is a popular media technology created by DivX, Inc. DivX media Files contain highly compressed video with high visual quality that maintains a relatively small file size. DivX files can also include advanced media features like menus, subtitles, and alternate audio tracks. Many DivX media files are available for download online, and you can create your own using your personal content and easy-to-use tools from DivX.com.

## **About DivX Certified**

DivX Certified products are officially tested by the creators of DivX and guaranteed to play all versions of DivX video, including DivX 6. Certified products qualify for one of several DivX Profiles that designate the type of video the product supports, from compact portable video to high-definition video.

## The marking of products using lasers (Except for some areas)

**CLASS 1  
LASER PRODUCT**

The label is attached to the chassis/case and says that the component uses laser beams that have been classified as Class 1. It means that the unit is utilizing laser beams that are of a weaker class. There is no danger of hazardous radiation outside the unit.

## Information on Disposal of Old Electrical and Electronic Equipment (applicable for EU countries that have adopted separate waste collection systems)



Products with the symbol (crossed-out wheeled bin) cannot be disposed of as household waste. Old electrical and electronic equipment should be recycled at a facility capable of handling these items and their waste byproducts. Contact your local authority for details in locating a recycle facility nearest to you. Proper recycling and waste disposal will help conserve resources whilst preventing detrimental effects on our health and the environment.

This Product is not installed by the manufacturer of a vehicle on the production line, nor by the professional importer of a vehicle into an EU Member State.

The "AAC" logo is trademark of DolbyLaboratories.

Apple, the Apple logo, and iPod are trademarks of Apple Inc., registered in the U.S. and other countries.

DivX, DivX Certified, and associated logos are trademarks of DivX, Inc. and are used under license.

 is a trademark of DVD Format/Logo Licensing Corporation registered in the U.S., Japan and other countries.

This product incorporates copyright protection technology that is protected by U.S. patents and other intellectual property rights. Use of this copyright protection technology must be authorized by Macrovision, and is intended for home and other limited viewing uses only unless otherwise authorized by Macrovision. Reverse engineering or disassembly is prohibited.

Manufactured under license from Dolby Laboratories.  
"Dolby" and the double-D symbol are trademarks of Dolby Laboratories.

"DTS" and "DTS 2.0 + Digital Out" are trademarks of Digital Theater Systems, Inc.

---

# KENWOOD



## Free Manuals Download Website

<http://myh66.com>

<http://usermanuals.us>

<http://www.somanuals.com>

<http://www.4manuals.cc>

<http://www.manual-lib.com>

<http://www.404manual.com>

<http://www.luxmanual.com>

<http://aubethermostatmanual.com>

Golf course search by state

<http://golfingnear.com>

Email search by domain

<http://emailbydomain.com>

Auto manuals search

<http://auto.somanuals.com>

TV manuals search

<http://tv.somanuals.com>