

KENWOOD

FM/AM RECEIVER

R-SG7

CD PLAYER

DP-SG7

CASSETTE TAPE DECK

X-SG7

INSTRUCTION MANUAL

KENWOOD CORPORATION



B60-4358-00

Ⓔ

2 Before applying power

 **Caution : Read this page carefully to ensure safe operation.**

R-SG7 / DP-SG7 / X-SG7 (EN)

Units are designed for operation as follows.

U.S.A. and Canada **AC 120 V only**
Australia **AC 240 V only**

Europe and U.K. **AC 230 V only**
China and Russia **AC 220 V only**
***Other countries** **AC 110-120 / 220-240 V switchable**

For the United Kingdom

Factory fitted moulded mains plug

- 1.The mains plug contains a fuse. For replacement, use only a 13-Amp ASTA-approved (BS1362) fuse.
- 2.The fuse cover must be refitted when replacing the fuse in the moulded plug.
- 3.Do not cut off the mains plug from this equipment. If the plug fitted is not suitable for the power points in your home or the cable is too short to reach a power point, then obtain an appropriate safety approved extension lead or adapter, or consult your dealer. If nonetheless the mains plug is cut off, remove the fuse and dispose of the plug immediately, to avoid a possible shock hazard by inadvertent connection to the mains supply.

IMPORTANT: The wires in the mains lead are coloured in accordance with the following code:





Blue : Neutral
Brown : Live

Do not connect those leads to the earth terminal of a three-pin plug.

Preparation section

Safety precautions

WARNING : TO PREVENT FIRE OR ELECTRIC SHOCK, DO NOT EXPOSE THIS APPLIANCE TO RAIN OR MOISTURE.

	CAUTION RISK OF ELECTRIC SHOCK DO NOT OPEN		CAUTION: TO REDUCE THE RISK OF ELECTRIC SHOCK, DO NOT REMOVE COVER (OR BACK). NO USER-SERVICEABLE PARTS INSIDE. REFER SERVICING TO QUALIFIED SERVICE PERSONNEL.
	THE LIGHTNING FLASH WITH ARROWHEAD SYMBOL, WITHIN AN EQUILATERAL TRIANGLE, IS INTENDED TO ALERT THE USER TO THE PRESENCE OF UNINSULATED "DANGEROUS VOLTAGE" WITHIN THE PRODUCT'S ENCLOSURE THAT MAY BE OF SUFFICIENT MAGNITUDE TO CONSTITUTE A RISK OF ELECTRIC SHOCK TO PERSONS.		
	THE EXCLAMATION POINT WITHIN AN EQUILATERAL TRIANGLE IS INTENDED TO ALERT THE USER TO THE PRESENCE OF IMPORTANT OPERATING AND MAINTENANCE (SERVICING) INSTRUCTIONS IN THE LITERATURE ACCOMPANYING THE APPLIANCE.		



The marking of products using lasers (Except for some areas)

**CLASS 1
LASER PRODUCT**

The marking is located on the rear panel and says that the component uses laser beams that have been classified as Class 1. It means that the unit is utilizing laser beams that are of a weaker class. There is no danger of hazardous radiation outside the unit.

Contents

Preparation section

 Before applying power	2
 Safety precautions	2
 IMPORTANT SAFEGUARDS	4
The High grade Micro Component Series	6
About the Instruction Manual	6
Special features	7
System Composition and Installation	8
System connection	9
Antenna connection	9
Connection of audio cord	10
Connection of speakers	12
Connection of system control cord	13
Power Cord Connection	13
Controls and indicators	14
Main Unit	14
Remote control Unit	16
Operation of remote control unit	17

Basic section

Hearing sound	18
Basic use	18
Playback of CD	20
Playback of tape	22
Receiving broadcast station	26
Collective presetting of stations (auto preset)	27
One-by-one presetting (manual preset)	27
Recording	28
Recording	28



Application section

Playback of CD	31
Listening in the desired sequence	
(program playback)	31
Repeated playback	33
Listening to an unexpected title sequence	
(random playback)	34
Convenient CD recording	35
Selecting the optimum recording method	35
Giving preference to the tape length	
over the track sequence	
(time edit recording)	36
Recording only desired tracks	
(ONE TOUCH EDIT.....single track recording)	37
One-touch recording of an entire CD	
(ONE TOUCH EDIT.....recording of all tracks)	38
R.D.S. (Radio Data System)	39
Searching for a desired program type	
(PTY search)	40
To be able to listen to the desired information	
at any time	
(EON reservation)	42
Listening with high sound quality (Pure A)	43
Listening in Pure A mode	43
Clock adjustment	44
Timer operation	45
Operate easy To use Timer (O.T.T.)	45
Sleep timer	45
Timer programming	46

Preparation section

Knowledge section

Important items	49
Handling of discs and tapes	49
Maintenance	50
Reference	51
In case of difficulty	52
Specifications	55

IMPORTANT SAFEGUARDS

Please read all of the safety and operating instructions before operating this appliance. Adhere to all warnings on the appliance and in the instruction manual. Follow all the safety and operating instructions. These safety and operating instructions should be retained for future reference.

- 1. Power sources** – The appliance should be connected to a power supply only of the type described in the instruction manual or as marked on the appliance. If you are not sure of the type of power supply to your home, consult your appliance dealer or local power company. For appliances intended to operate from battery power, or other sources, refer to the instruction manual.
- 2. Power-cord protection** – Power-supply cords should be routed so that they are not likely to be walked on or pinched by items placed upon or against them, paying particular attention to cords at plugs, convenience receptacles, and the point where they exit from the appliance.
- 3. CAUTION – Polarization** – This appliance may be equipped with a polarized alternating-current line plug (a plug having one blade wider than the other). This plug will fit into the power outlet only one way. This is a safety feature. If you are unable to insert the plug fully into the outlet, try reversing the plug. If the plug should still fail to fit, contact your electrician to replace your obsolete outlet. Do not defeat the safety purpose of the polarized plug.
- 4. Ventilation** – Slots and openings in the cabinet are provided for ventilation and to ensure reliable operation of the appliance and to protect it from overheating, and these openings must not be blocked or covered. The appliance should be situated so that its location or position does not interfere with its proper ventilation. To maintain good ventilation, do not put records or a table-cloth on the appliance. Place the appliance at least 10 cm away from the walls.
Do not use the appliance on a bed, sofa, rug or similar surface that may block the ventilation openings. This appliance should not be placed in a built-in installation such as a bookcase or rack unless proper ventilation is provided or the manufacturer's instructions have been adhered to.
- 5. Water and moisture** – The appliance should not be used near water - for example, near a bathtub, washbowl, kitchen sink, laundry tub, in a wet basement, or near a swimming pool, etc.
- 6. Temperature** – The appliance may not function properly if used at extremely low, or freezing temperatures. The ideal ambient temperature is above +5°C (41°F).
- 7. Heat** – The appliance should be situated away from heat sources such as radiators, heat registers, stoves, or other appliances (including amplifiers) that produce heat.
- 8. Electric shock** – Care should be taken so that objects do not fall and liquid is not spilled into the enclosure through openings. If a metal object, such as a hair pin or a needle, comes into contact with the inside of this appliance, a dangerous electric shock may result. For families with children, never permit children to put anything, especially metal, inside this appliance.
- 9. Enclosure removal** – Never remove the enclosure. If the internal parts are touched accidentally, a serious electric shock might occur.
- 10. Magnetic fields** – Keep the appliance away from sources of magnetic fields such as TV sets, speaker systems, radios, motorized toys or magnetized objects.
- 11. Cleaning** – Unplug this appliance from the wall outlet before cleaning. Do not use volatile solvents such as alcohol, paint thinner, gasoline, or benzine, etc. to clean the cabinet. Use a clean dry cloth.
- 12. Accessories** – Do not place this appliance on an unstable cart, stand, tripod, bracket, or table. The appliance may fall, causing serious injury to a child or adult, and serious damage to the appliance. Use only with a cart, stand, tripod, bracket, or table recommended by the manufacturer, or sold with the appliance. Any mounting of the appliance should follow the manufacturer's instructions, and should use a mounting accessory recommended by the manufacturer. An appliance and cart combination should be moved with care. Quick stops, excessive force, and uneven surfaces may cause the appliance and cart combination to overturn.
- 13. Lightning** – For added protection for this appliance during a lightning storm, or when it is left unattended and unused for long periods of time, unplug it from the wall outlet and disconnect the antenna or cable system. This will prevent damage to the appliance due to lightning and power-line surges.
- 14. Abnormal smell** – If an abnormal smell or smoke is detected, immediately turn the power OFF and unplug the appliance from the wall outlet. Contact your dealer or nearest service center.

15. Damage requiring service – The appliance should be serviced by qualified service personnel when:

- A. The power-supply cord or the plug has been damaged.
- B. Objects have fallen, or liquid has been spilled into the appliance.
- C. The appliance has been exposed to rain or water.
- D. The appliance does not appear to operate normally by following the instruction manual. Adjust only those controls that are covered by the instruction manual as an improper adjustment of other controls may result in damage and will often require extensive work by a qualified technician to restore the appliance to its normal operation.
- E. The appliance has been dropped, or the enclosure damaged.
- F. The appliance exhibits a marked change in performance.

16. Servicing – The user should not attempt to service the appliance beyond that described in the instruction manual. All other servicing should be referred to qualified service personnel.

17. Outdoor antenna grounding – If an outside antenna is connected to the appliance, be sure the antenna system is grounded so as to provide some protection against voltage surges and built up static charges. Article 810 of the National Electrical Code ANSI/NFPA 70, provides information with respect to proper grounding of the mast and supporting structure, grounding of the lead-in wire to an antenna discharge unit, size of grounding conductors, location of antenna discharge unit, connection to grounding electrodes, and requirements for the grounding electrode. See Figure.

18. Power lines – An outside antenna system should not be located in the vicinity of overhead power lines or other electric light or power circuits, or where it can fall into such power lines or circuits. When installing an outside antenna system, extreme care should be taken to keep from touching such power lines or circuits as contact with them might be fatal.

19. AC outlets – Do not connect other audio equipment with a power consumption larger than that specified to the AC outlet on the rear panel. Never connect other electrical appliances, such as an iron or toaster, to it to prevent fire or electric shock.

20. Overloading – Do not overload wall outlets, extension cords, or integral convenience receptacles as this can result in a risk of fire or electric shock.

21. Attachment – Do not use attachments not recommended by the appliance manufacturer as they may cause hazards.

22. Replacement parts – When replacement parts are required, be sure the service technician has used replacement parts specified by the manufacturer or have the same characteristics as the original parts. Unauthorized substitutions may result in fire, electric shock, or other hazards.

23. Safety check – Upon completion of any service or repairs to this appliance, ask the service technician to perform safety checks to determine that the appliance is in proper operating condition.

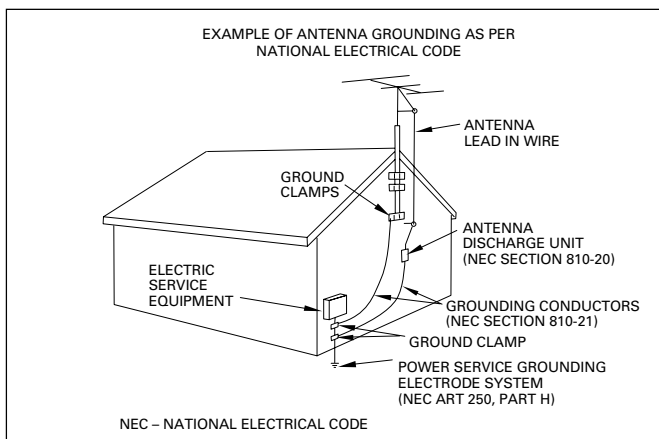

Notes:

- 1. Item 3 is not required except for grounded or polarized equipment.
- 2. Item 17 and 18 are not required except for units provided with antenna terminals.
- 3. Item 17 complies with UL in the U.S.A.

The High grade Micro Component Series

Thank you for purchasing the High grade Micro component series.

This system is available in various configuration according to your preferences.

The system configuration is up to you, but as the following convenient system operations can be executed by connecting the various units to the system control, the respective units should be purchased as required.

Remote Control

The remote control supplied with the receiver can be used for basic operation of the source units (CD player, cassette deck, MD recorder).

Automatic Operation

When playback is started on the playback source unit, the input selector on the amp tuner will automatically be set to input for that source unit. Also, when source input is selected on the amp tuner, playback of the input source unit will be started automatically.

Synchronized Recording

With recording from CD or MD, it is possible to start synchronized recording by the recording unit (MD recorder or cassette deck). (Recording from one MD recorder onto another one is not possible.)

There are also other convenient functions like one-touch edit recording for CD and MD etc.

Timer Operation

The clock function of the receiver can be used for timer playback and timer recording of source equipment (CD player, cassette deck, MD recorder).

High grade Micro Component Series components

R-SG7 (receiver)

X-SG7 (cassette deck)

DP-SG7 (CD player)

DM-SG7 (MD recorder)

About the Instruction Manual

While some models of the High grade Micro component series have an instruction manual explaining the system operation for R-SG7 (receiver), DP-SG7 (CD player), and X-SG7 (cassette deck), other models have only an operation manual for that model itself. This is done so that the system operation can be done easily even when optional equipment is purchased at a later date. Please read the required sections according to the components you purchased.

With the High grade Micro component series, the system explanations show only the connection method for the DM-SG7 (MD recorder). Please refer to the instruction manual enclosed with the DM-SG7 for the detailed operation.

Model name (name of the purchased component)	Enclosed instruction manual (explained models)
Basic system (R-SG7, DP-SG7)	System instruction manual (R-SG7, DP-SG7, X-SG7)
Cassette deck (X-SG7)	Individual instruction manual (X-SG7)
MD recorder (DM-SG7)	Individual instruction manual (DM-SG7)



Special features

■ Amplifier unit that accomplishes high grade sound quality and low distortion

● "Pure A" High Quality Mode at Low Volume

→ 43

When listening with low volume close to the set or late at night, we recommend the "Pure A" operation mode. Then you can enjoy smooth high-quality sound with little distortion. Please use the normal mode to listen at higher volumes.

■ CD player unit that accomplishes improved sound quality and stability

● Newly developed D.R.I.V.E. IC installed

A **D.R.I.V.E.** (Dynamic Resolution Incentive Vector Enhancement) IC that rapidly improves distortion at minute levels is installed in the CD player in order to extract the maximum performance possible from the CD.

■ Convenient easy to use operation

● Easy Operation

When the High grade Micro component series is connected to the system control, input switching with the input selector (**TAPE, TUNER, CD, MD**) of the R-SG7 will start playback by the selected unit. Reversely, when playback is started from a unit, the input will be switched automatically to this unit.

● CD TEXT compatibility

Disc title and track names recorded on the CD appear in the display of the MD player (DM-SG7: sold separately).

● Convenient Edit Recording

→ 36

Time edit recording: Recording so that no track is interrupted within the specified time.
One-touch edit recording: When listening to a CD, either a single track or the entire CD can be recorded on tape by one-touch operation.

● Simple Timer Operation

→ 45

The wake-up timer and the sleep timer can be set easily.
A daily program timer also can be reserved.

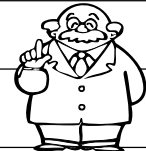

● R.D.S. (Radio Data System)

→ 39

The RDS data included in FM broadcasts can be used to search for the intended broadcasting contents and for automatic reception from standby.

Unpacking

Unpack the unit carefully and make sure that all accessories are put aside so they will not be lost.

Examine the unit for any possibility of shipping damage. If your unit is damaged or fails to operate, notify your dealer immediately. If your unit was shipped to you directly, notify the shipping company without delay. Only the consignee (the person or company receiving the unit) can file a claim against the carrier for shipping damage.

We recommend that you retain the original carton and packing materials for use should you transport or ship the unit in the future.

Accessories

Accessories using with R-SG7

AM loop antenna (1)
Loop antenna stand (1)
FM indoor antenna (1)
Remote control unit (1)
Batteries (R6/AA) (2)

Accessories using with DP-SG7

Audio cord (1)
System control cord (1)

Accessories supplied with X-SG7

Audio cord (2)
System control cord (1)

8 System Composition and Installation

R-SG7/DP-SG7/X-SG7 (EN)

The High grade Micro component series permits various combinations according to the purchased components. As the installation differs according to the components you purchase, please install correctly under reference to the illustrations.

Basic System (R-SG7, DP-SG7)

Seen from the front

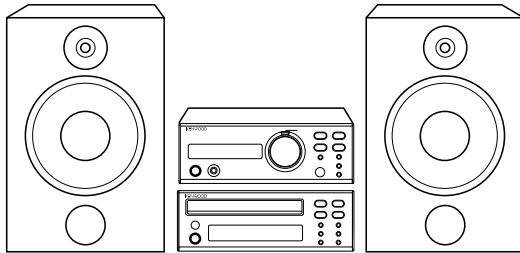

Installation method

R-SG7

DP-SG7

Basic System + Cassette Deck (R-SG7, DP-SG7, X-SG7)

Seen from the front

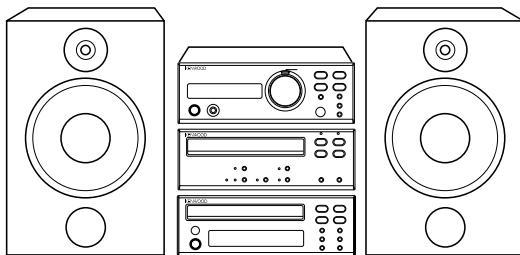

Installation method

R-SG7

X-SG7
(optional)

DP-SG7

Basic System + MD recorder (R-SG7, DP-SG7, DM-SG7)

Seen from the front

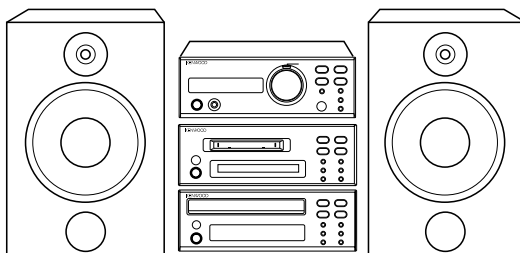

Installation method

R-SG7

DM-SG7
(optional)

DP-SG7

Full System (R-SG7, DP-SG7, DM-SG7, X-SG7)

Seen from the front

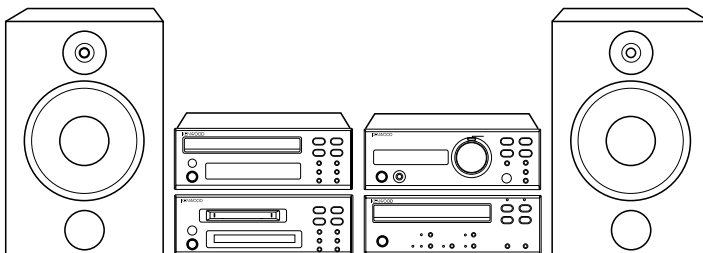

Installation method

DP-SG7

R-SG7

DM-SG7
(optional)

X-SG7
(optional)

CAUTION

When the power of the R-SG7 (receiver) is switched on, the heat generated on the inside is radiated to the outside. Always install the R-SG7 on top, and don't place any objects impairing heat radiation onto the top of the unit.

1. Antenna connection

Connect the antenna as shown in the figure.

Do not plug the power cord into a wall AC outlet until the connection has been completed.

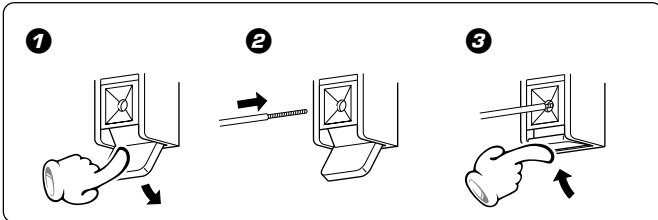

Connection of the Accessory Antenna

FM indoor antenna

The accessory antenna is for temporary indoor use only. For stable signal reception we recommend using an outdoor antenna. Remove the indoor antenna if you connect one outdoors.

AM loop antenna

The supplied antenna is for indoor use. Place it as far as possible from the main system, TV set, speaker cords and power cord, and set it to a direction which provides the best reception.

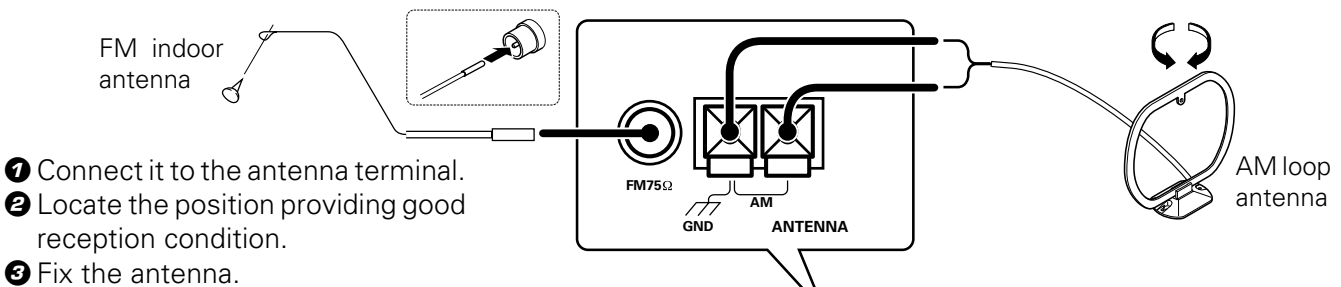

- ① Connect it to the antenna terminal.
- ② Locate the position providing good reception condition.
- ③ Fix the antenna.

In case of bad reception

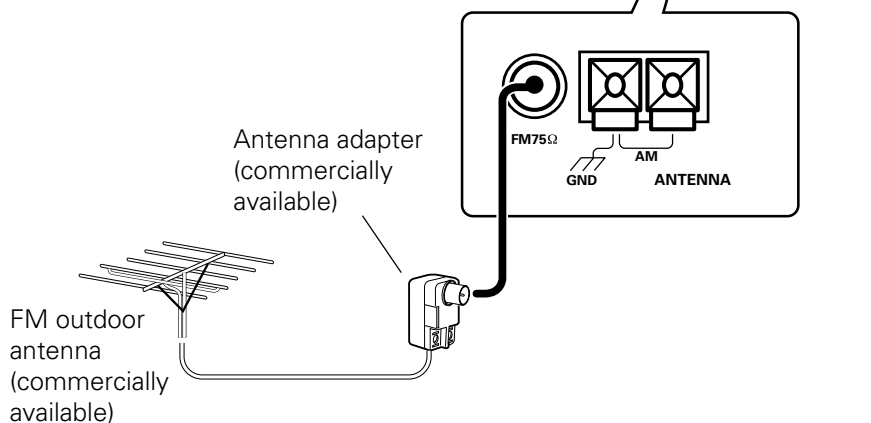

FM outdoor antenna

Lead the 75Ω coaxial cable connected to the FM outdoor antenna into the room and connect it to the FM 75Ω terminal.

R-SG7

2. Connection of audio cord

Here, connection of separately sold components also will be explained under consideration of system connection. Please install correctly according to the purchased components and connect the required cords.

Malfunction of microcomputer

If operation is not possible or erroneous display appears even though all connections have been made properly, reset the microcomputer referring to "In case of difficulty".



→ 52

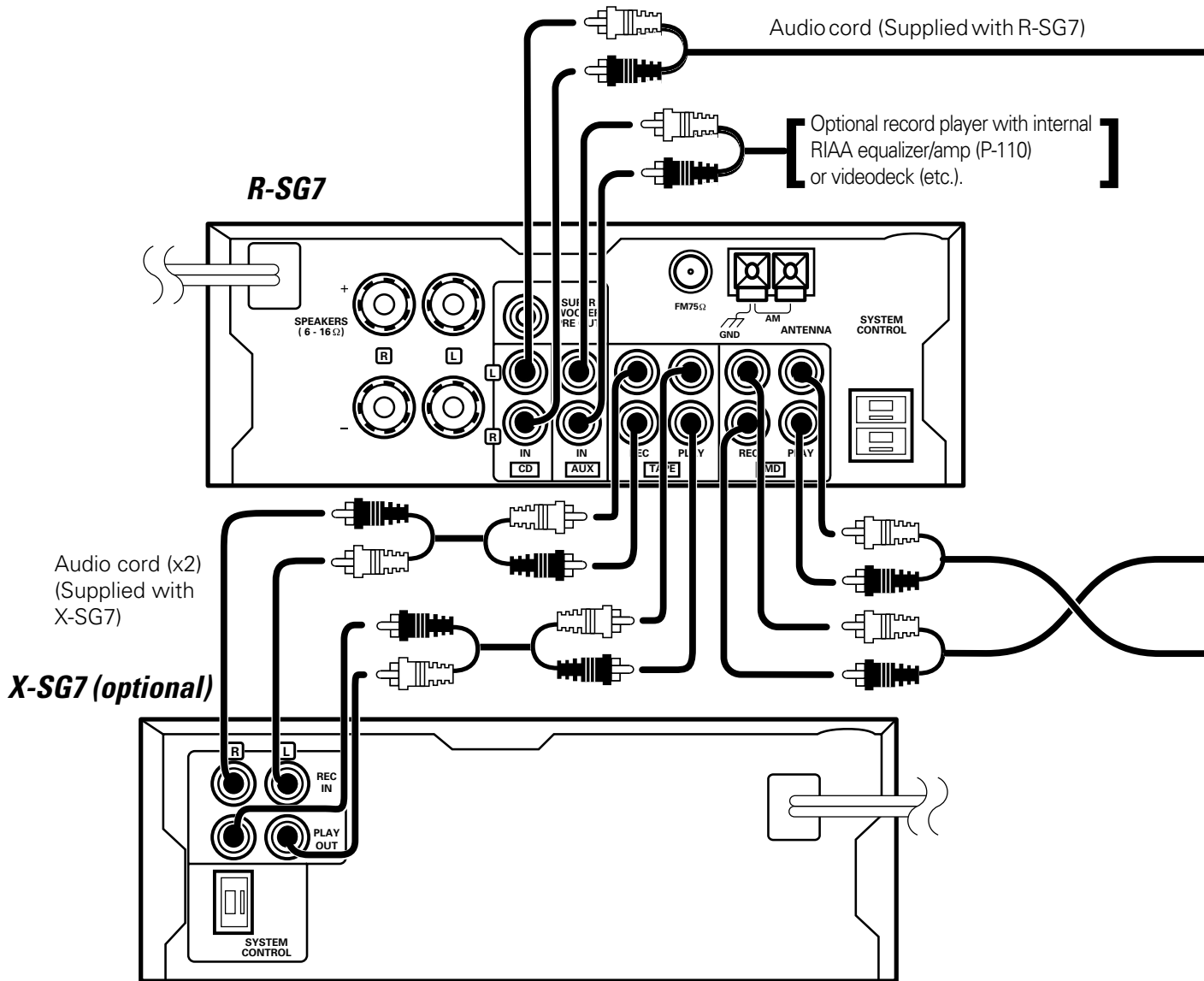

Connection with Optical Fiber Cable

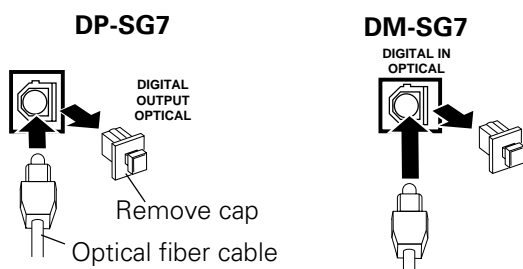

This is used for digital connections. Digital transmission permits recording without loss of the high CD sound quality.

Remove the cap and connect an optical fiber cable.



Caution for Connection

Do not plug the power cord into a wall AC outlet until the connection has been completed. Connect the equipment as shown in the figures.

CAUTION

Be sure to adhere followings. Or proper ventilation will be blocked causing damage or fire hazard.

- Install the R-SG7 on the top of the system.
- Do not place any objects impairing heat radiation onto the top of unit.
- Leave a space around the unit (from the largest outside dimension including projection) equal or greater than, shown below.

Top panel : 50 cm
Side panel : 10 cm
Back panel : 10 cm

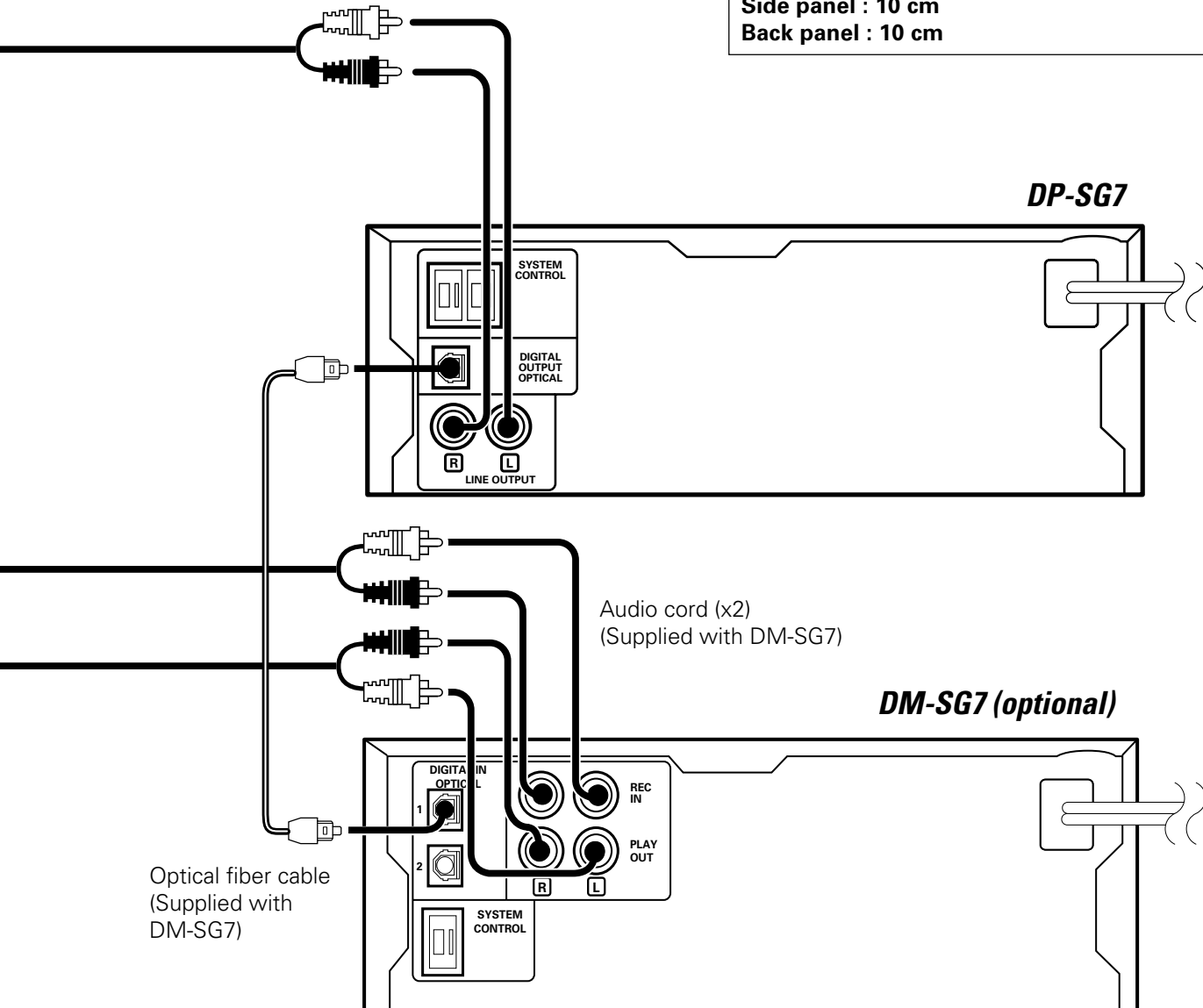

1. In case an associated system component is connected, also read the instruction manual of the component.
2. Insert the optical-fiber cable straight into the connector until it clicks.
3. Be sure to attach the protection cap when the connector is not used.
4. Be careful not to bend, coil or bundle the optical fiber cable.

3. Connection of speakers

Connect the speakers as shown in the figure.

Do not plug the power cord into a wall AC outlet until the connection has been completed.

1 Cord preparation.



2 Loosen.

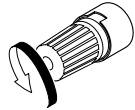

3 Insert.

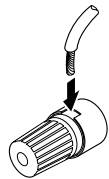

4 Secure.

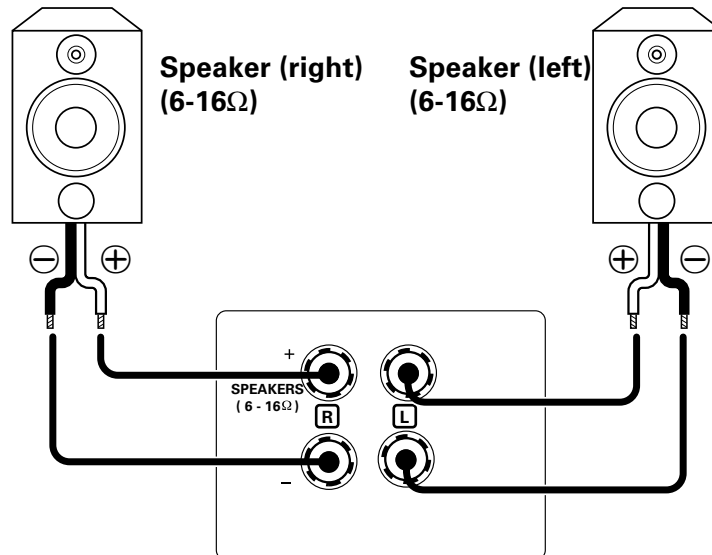
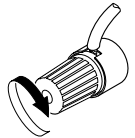

R-SG7

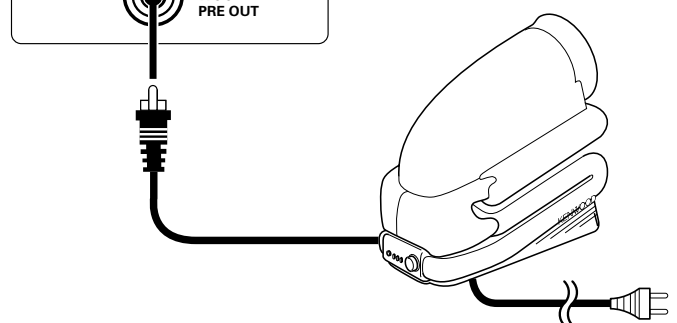
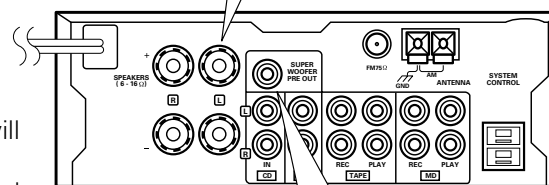

- Never short-circuit the + and – speaker cords.
The protection circuit will operate and no sound will be put out.
- If the left and right speaker connections or the + and – polarity are inverted, the sound will be unnatural with unclear localization of musical instruments, etc.
Be sure to connect them without mistake.

Super woofer (SW-500) (optional)

Extremely low frequency sound is played back powerfully.
This can be used with any type of playback.

4. Connection of system control cord

Connect the system control cords and the power cords as shown in the figure.

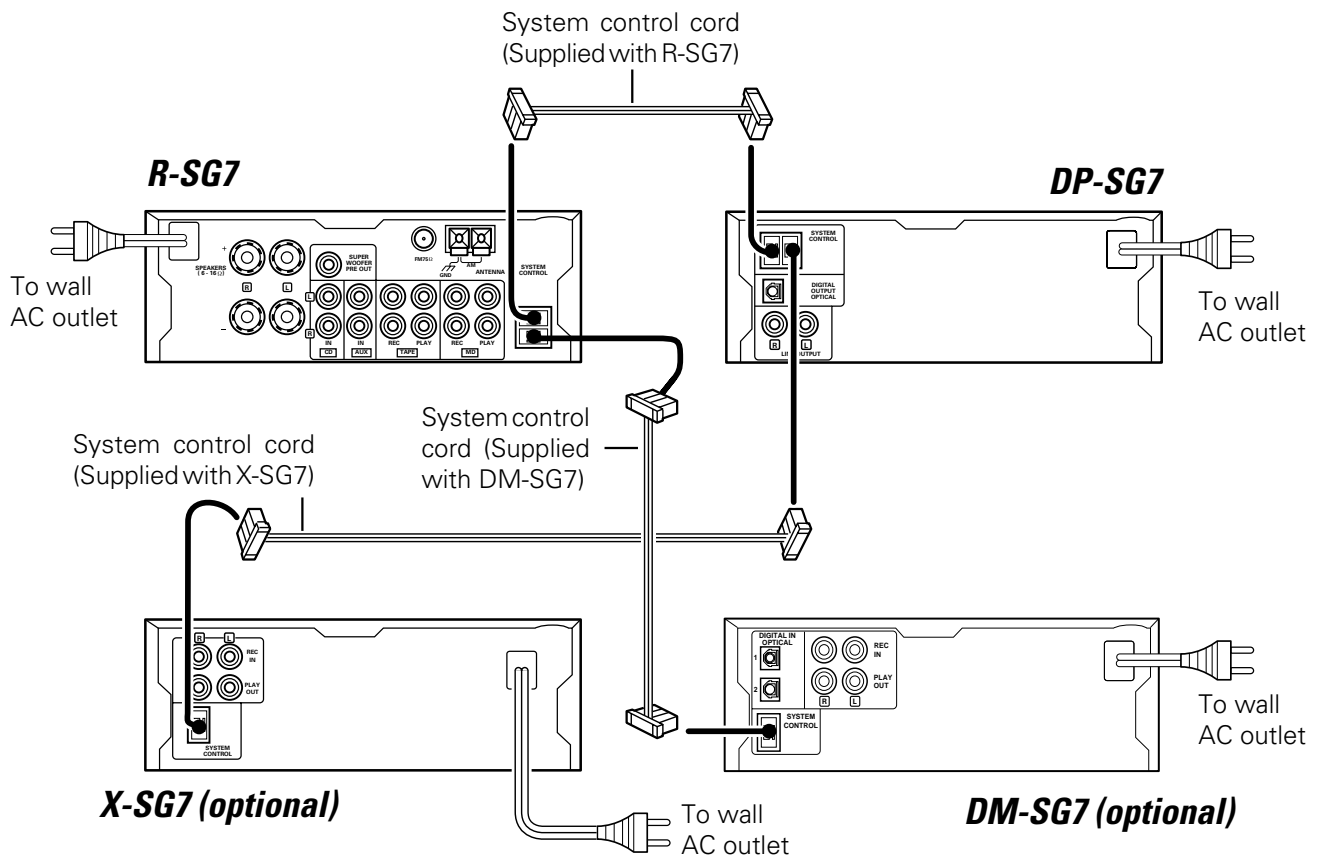

Connection of system control cord

Plugging the connector

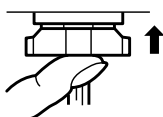

Insert the plug straight into the connector until it locks.

Unplugging the connector

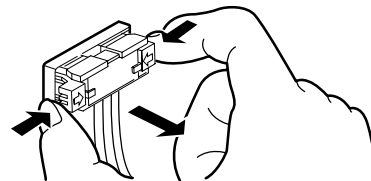

While pushing the two sides of connector in, pull it straight out.

5. Power Cord Connection

Insert the power cord plug into a wall AC outlet after all other connections have been completed.



1. Be sure to insert all connection cords securely. If their connections are imperfect, the sound may not be produced or noise may interfere.
2. Before plugging or unplugging a connection cord, be sure to unplug the power cord from the wall AC outlet. If connection cords are plugged or unplugged with the power cord left plugged in, malfunction or damage may result.

Main Unit

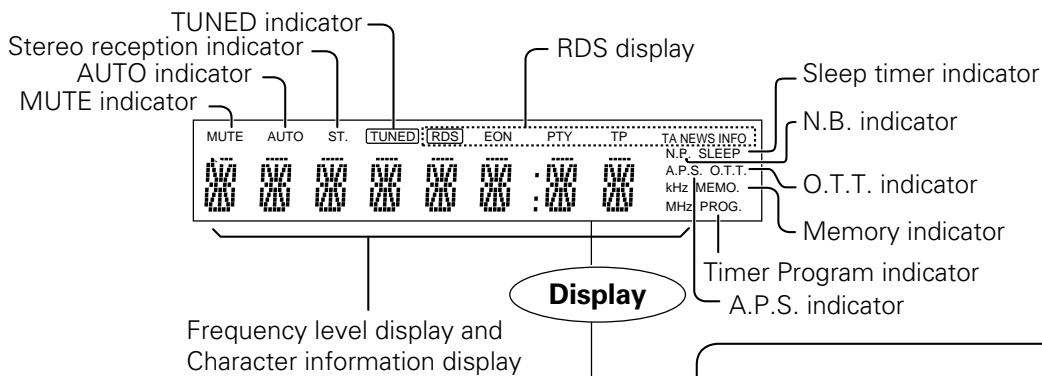

Receiver R-SG7

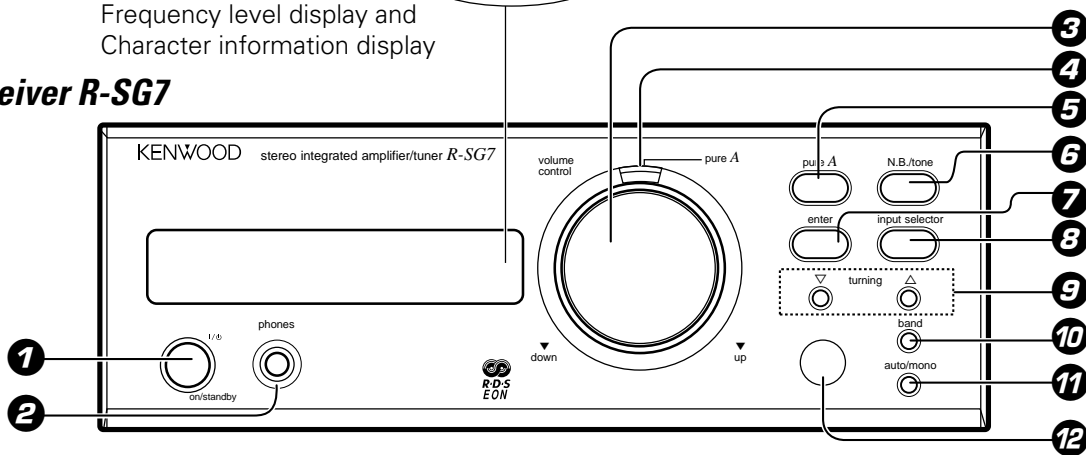

Cassette deck X-SG7 (optional)

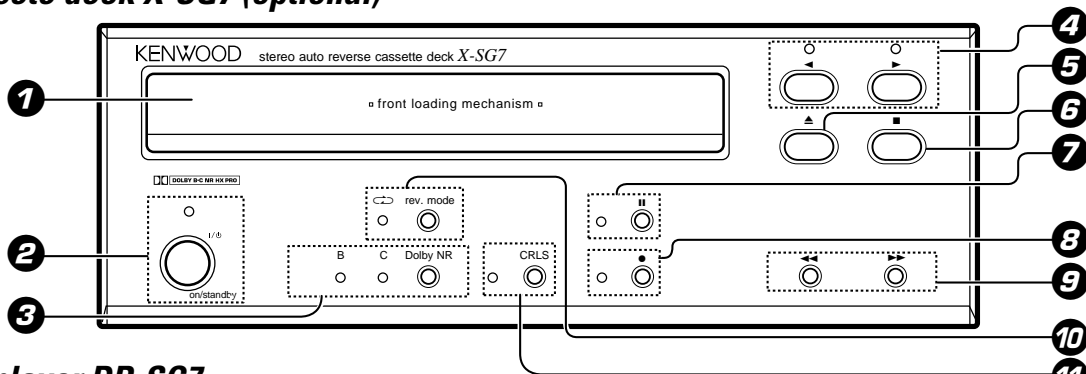

CD player DP-SG7

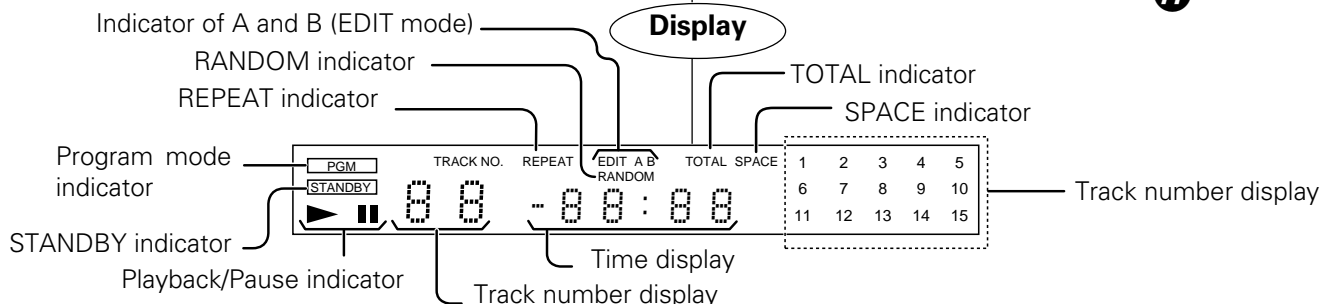
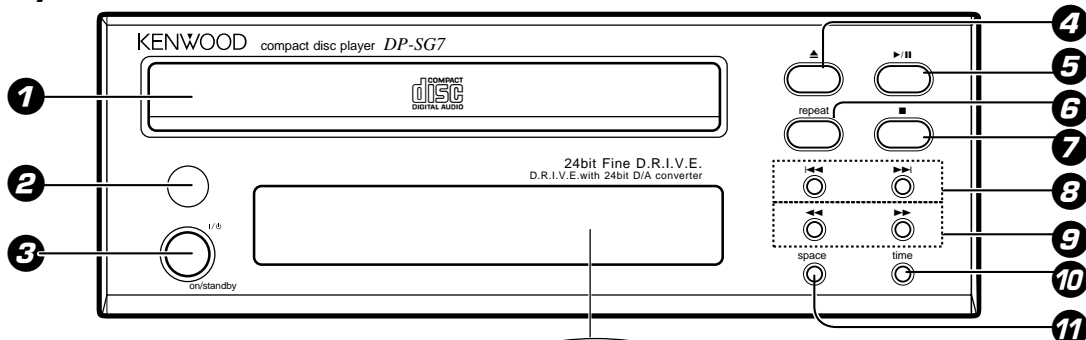

Receiver R-SG7

- 1** | / ⏻ (on/standby) key → 18
The power is switched ON and OFF (standby). At the time of system connection, the power is switched ON and OFF for the entire system.
- 2** "phones" jack → 19
Headphones with a stereo mini plug (optional) can be connected.
- 3** "volume control" knob → 18
Normally, this is used to adjust the volume. It is also used for timer reservation and clock setting.
- 4** Pure A indicator → 43
This lights at the time of pure A mode.
- 5** "pure A" key → 19 → 43
When the power is ON : Switches Pure A mode ON/OFF.
When the power is OFF : Switches A.P.S. (auto power save) ON/OFF.
- 6** "N.B./tone" key → 19
This is used for bass and treble compensation.

- 7** "enter" key → 19 → 27 → 44
This key is used in many operations including the tone adjustment, station presetting, clock adjustment and timer setting.
- 8** "input selector" key → 18
This selects the input source. When TAPE, CD, or MD is selected and a tape or disc already has been set, playback starts automatically.
- 9** "tuning" (Δ ▽) key → 26 → 45 → 48
When the power is ON : Used for station tuning.
When the power is OFF: Used for timer reservation.
Δkey: Program ON/OFF
▽key: O.T.T. reservation
- 10** "band" key → 26 → 48
When the power is ON : Reception band switching.
When the power is OFF: Used for timer reservation.
- 11** "auto/mono" key → 26 → 44
When the power is ON : The tuning mode is switched.
When the power is OFF: Used for clock setting.
- 12** Remote control sensor → 17
This is used with the R-SG7 system remote control (RC-R0713E).

Cassette deck X-SG7

- 1** Tape tray → 22
This houses the cassette tape.
- 2** | / ⏻ (on/standby) key/Standby indicator
The power is switched ON and OFF (standby). This is not used in case of system connection.
- 3** Dolby NR key/indicators → 23
Dolby noise reduction ON/OFF switching is executed.
- 4** Playback keys (◀ ▶)/Operation indicator → 22
During stop and pause: the tape direction lights red.
During playback and recording: the tape direction lights green.
During fast forward and rewind: the tape direction flashes green.
- 5** Open/Close key (▲) → 22
This opens the tape tray for tape insertion and removal.

- 6** Stop (■) key → 23
- 7** Pause (||) key/indicator → 23
- 8** Record (●) key/indicator → 28
Recording is started. When this switch is pressed during recording, an unrecorded (blank) portion of about 4 sec is produced and then the tape stops.
- 9** Fast forward and rewind (◀◀ ▶▶) keys → 23
- 10** "rev. mode" key/indicator → 23
The reverse mode of the deck (both sides, one side) is switched.
- 11** CRLS key/indicator → 30
The recording level is set automatically according to the sound source being recorded.

CD player DP-SG7

- 1** Disc tray → 20
One disc can be stored.
- 2** Remote control sensor
This is not used with system connection.
- 3** | / ⏻ (on/standby) key
The power is switched ON and OFF (standby). This is not used with system connection.
- 4** Open/Close key (▲) → 20

- The disc tray is opened and closed.
- 5** Playback/Pause key (▶/||) → 20
- 6** "repeat" key → 33
This is used for repeated playback of a CD.
- 7** Stop (■) key → 21
- 8** Skip (◀◀ ▶▶) key → 21
- 9** Fast forward, rewind (◀◀ ▶▶) key → 21
- 10** "time" key → 21
The CD time display is switched.
- 11** "space" key → 32
During program playback, a silent part of several seconds is produced between tracks.

Remote control Unit [RC-R0713E]

When the system control cord is connected, this remote control can be used to operate the entire system.

The keys on the remote control unit with the same names as on the main unit have the same function as the keys on the main unit.

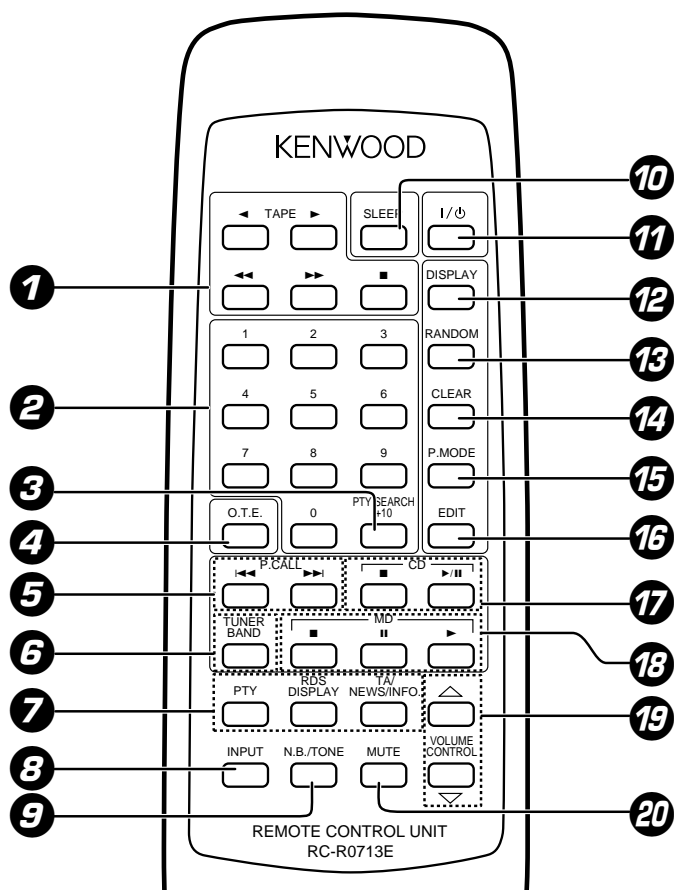

1 Cassette deck operation keys → 22

These keys are used to operate the cassette deck (X-SG7).

2 Numeric keys → 21 → 27

These keys can be used as numeric keys when **CD** or **MD** is selected as input. When **TUNER** is selected as input, preset stations can be called.

3 PTY SEARCH/+10 key → 40

This is used to specify the program type and to search for a station.

4 O.T.E. key → 36

When this key is pressed during CD or MD playback, only the track being played at that time will be recorded on tape. When this key is pressed during stop, the CD or MD selected at that time will be recorded on tape from the first track onward.

5 ⏮ ⏭ key → 21 → 26

(Skip/Preset call)

When **TUNER** is selected:

This is used as preset call key.

When **CD** or **MD** is selected:

This is used as skip key.

6 BAND key → 26

This is used to switch the tuner reception bands.

7 Keys related to RDS → 39

RDS DISPLAY key

The display contents are switched during reception of RDS broadcasts.

PTY (Program Type) key

This is used to specify the program type when searching for a station.

TA/NEWS/INFO key

Used for automatic reception of transmissions of a certain content.

8 INPUT key → 18

This key selects the input source. When **TAPE**, **CD**, or **MD** is selected and a tape or disc already has been set, playback starts automatically.

9 N.B./TONE key → 19

This is used for bass and treble compensation.

10 SLEEP key → 45

Use to set the sleep timer.

11 I/⏻ (on/standby) key → 18

The power for the receiver is switched ON and OFF (standby). At the time of system connection, the power is switched ON and OFF for the entire system.

12 DISPLAY key → 27

Switches the display on the AMP/TUNER (R-SG7) (between the clock display and the input display).

13 RANDOM key → 34

Selects CD or MD tracks randomly for playback.

14 CLEAR key → 32

The contents of the CD program playback are cleared title by title from the end.

15 P.MODE keys → 31

Used to program the CD playback sequence.

16 EDIT key → 36

Used for CD edit recording (time edit recording).

17 CD operation keys → 21

These keys are used to operate the CD player.

18 MD operation keys

These keys are used to operate the MD recorder (DM-SG7).

19 VOLUME CONTROL keys → 18

This has the same function as the **volume control** knob on the main unit. However, the **AI VOLUME** function does not operate.

20 MUTE key → 19

This is used to mute the sound temporarily.

Loading batteries

① Remove the cover.

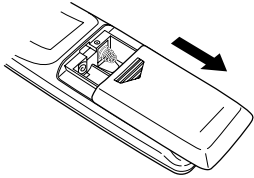

② Insert batteries.

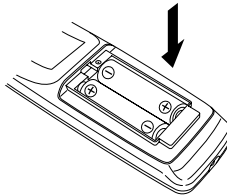

③ Close the cover.

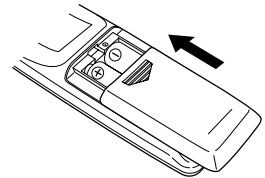

- Insert two R6 ("AA"-size) batteries following the polarity indications.

Operation

After plugging the power cord of this unit, press the **I / ⏻ (on/standby)** key of the remote control unit to turn the power of the system ON. When the power is turned ON, press the key of the function to be operated.

- When pressing more than one remote control keys successively, press the keys securely by leaving an interval of 1 second or more between keys.

Operating range (approx.)

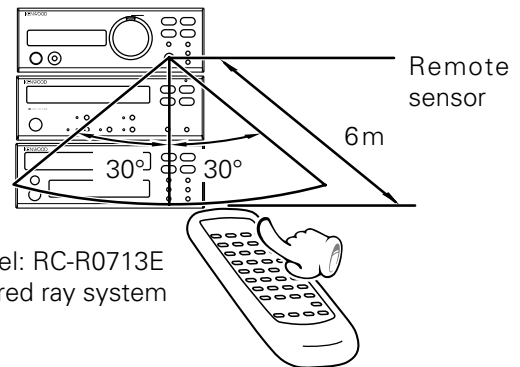

1. The provided batteries are intended for use in operation checking, and their service life may be short.
2. When the remote controllable distance becomes short, replace both of the batteries with new ones.
3. If direct sunlight or the light of a high-frequency fluorescent lamp (inverter type, etc.) is incident to the remote sensor, malfunction may occur. In such a case, change the installation position to avoid malfunction.

Basic use

Listening through headphones

Bass and treble compensation

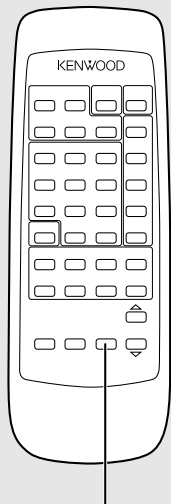

Muting the sound temporarily

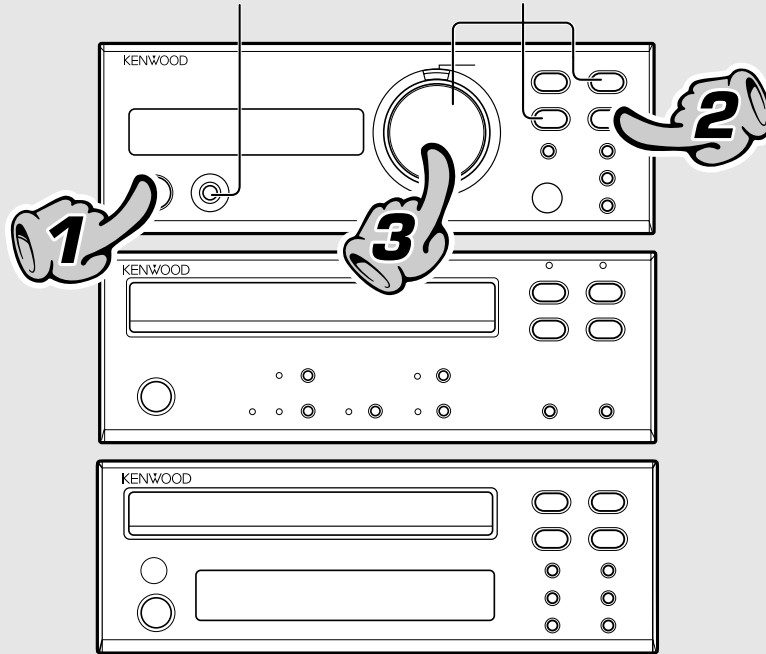

Basic section

Press the I / ⏻ (on/standby) key of the receiver.

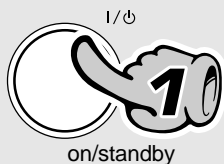

1. Switching the power ON (OFF).

When the I / ⏻ (on/standby) key is pressed while the power is ON, the power will be switched OFF.

- The entire system can be switched ON and OFF. The I / ⏻ (on/standby) key on the remote control has the same function.
- The display part becomes dark when the power is switched OFF. (DIMMER function)

input selector

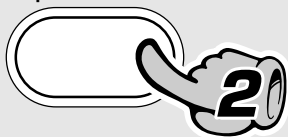

2. Selecting the desired output.

- | | | |
|---|-------|------|
| ① | TUNER | - 26 |
| ② | CD | - 20 |
| ③ | TAPE | - 22 |
| ④ | MD | |
| ⑤ | AUX | |

For MD, refer to the instruction manual for the MD recorder (DM-SG7).

- When CD, TAPE or MD is selected, playback will start when a disc or a tape already has been inserted.

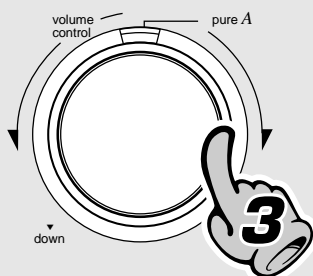

3. Volume adjustment.

- Quick turning produces a larger change amount. (Dynamic rotary volume control function)
- The display shows a reference value.

Muting the sound temporarily (Remote control unit only)

Remote control unit

- Press again to resume the original volume.
- This is also cancelled when the volume is adjusted.

Listening through headphones

➊ Insert the headphone plug into the phones jack.

➋ Adjust the volume. → 18 (step 3)

- Headphones with a stereo mini plug can be connected.
- The sounds from all speakers are cut off.

When **CD** has been selected.



Volume display R-SG7

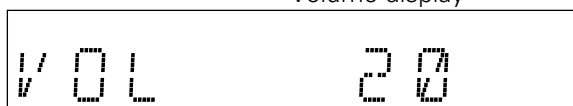

Bass and treble compensation (N.B.: Natural Bass circuit)

The indication changes each time this key is pressed.

- ➊ **NB ON1** ... Compensation of highest and lowest frequencies according to the current volume level (Effective during low-level listening).
- ➋ **NB ON2** Compensation of lowest frequencies according to the current volume level.
- ➌ **TONE FLAT (TONE)** Variation of tone.

Adjust the "TONE"

- ➊ Press the **N.B./tone** key so that **"TONE FLAT"** (**"TONE"**) is displayed.
- ➋ Press the **ENTER** key while **"TONE FLAT"** (**"TONE"**) is displayed.

The indication changes each time this key is pressed.

- ➊ **BASS** Adjusts the lowest frequencies.
- ➋ **TREBLE** ... Adjusts the highest frequencies.

- Use the **VOLUME** control to adjust **BASS** or **TREBLE** in the range between -10 and +10. (**"TONE FLAT"** is displayed when both the **BASS** and **TREBLE** values are set to +/-0. **"TONE"** is displayed when any of them is adjusted to a value other than 0.)

AUTO POWER SAVE function

When the power is ON and neither recording nor playback is executed for 30 minutes or more, the power is switched off automatically by this function. This function can be made active or not active by the following operation.

Press when the power is OFF.

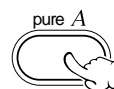

Each press switches the modes as follows.

- ➊ **APS ON**..... Auto power save is used.
- ➋ **APS OFF**.... Auto power save is not used.

- When the **TUNER** input is selected, it is available only when the volume is set to 0.

Power Switch Standby

When this system is in standby condition (time display for the R-SG7, STANDBY indication for DP-SG7, standby indicator lit for X-SG7), a slight current flows for memory protection. At this time also, the remote control can be used for power ON.

Playback of CD

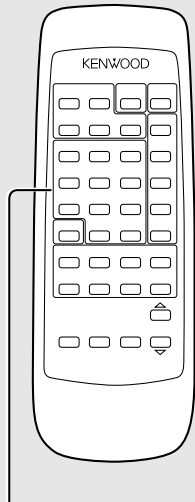

Playback from desired track

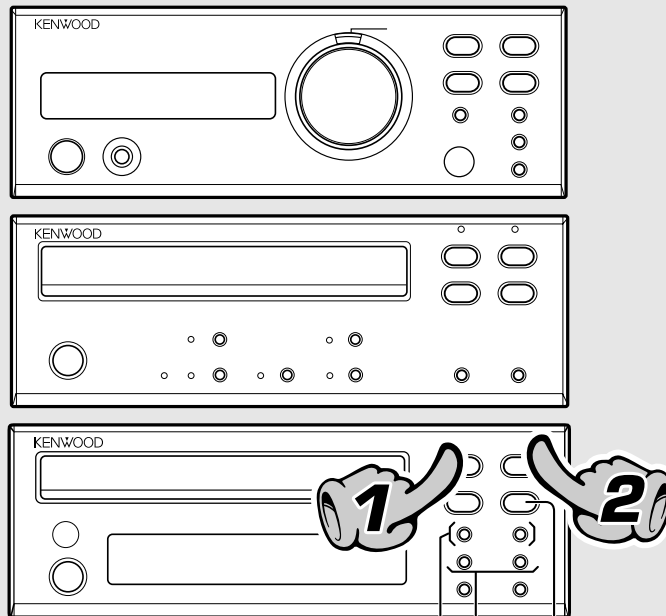

Skipping tracks
To fast forward and backward

To stop playback

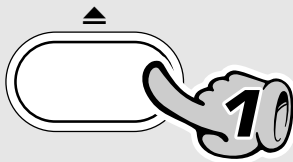

The tray opens when the key is pressed and closes when the key is pressed again.

1. Load a disc.

- ① Open the tray.
- ② Place a disc.
- ③ Close the tray.

The label must be on top.

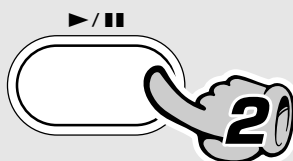
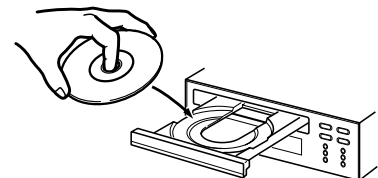

2. Start playback.



When the power is ON and a disc has been set in advance to the CD player, playback will start just by setting the input selection to CD.

Skipping tracks

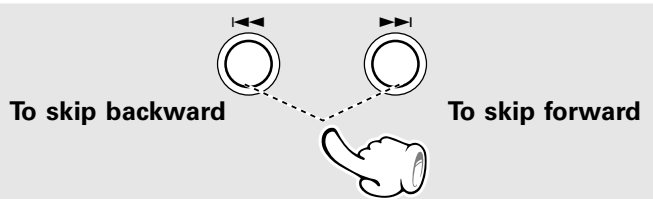

- The track in the direction of the button pressed is skipped, and the selected track will be played from the beginning.
- When the I◀◀ key is pressed once during playback, the track being played will be played from the beginning.
- To skip further to the previous track, press the I◀◀ key quickly.

Playback from desired track

Select the desired track No.

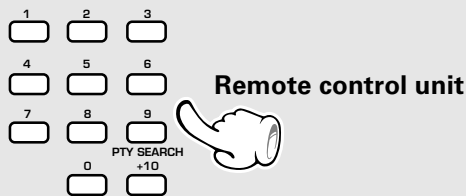

Press the numeric keys as shown below....

- To enter track No. 23 : [+10] [+10] [3]
 To select track No. 40 : [+10] [+10] [+10] [+10] [0]

- Do not touch the playback side of disc.

The recorded track Nos. are shown.

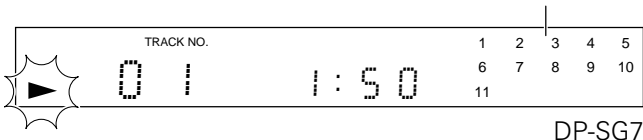

- After a few seconds, play starts from track No.1.

To fast forward and backward

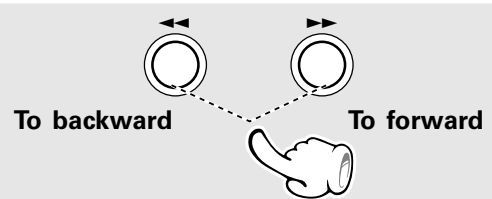

- Playback starts from the position where the key is released.

To pause playback



- Each press pauses and plays the CD alternately.

To stop playback

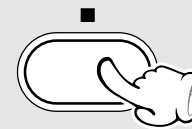

Time display on CD player

Each press of the "time" key changes the displayed contents.

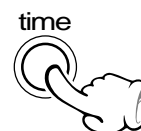

- ① 1: 23 : Elapsed time of track being played
- ② - 2: 37 : Remaining time of track being played
- ③ 23: 45 : Elapsed time of entire disc
- ④ - 36: 15 : Remaining time on entire disc

- In edit mode and in random mode, display is made only for the track being played.

About the CD TEXT function

When a CD with text information (Titles, Artist name, etc.) is loaded and the optional MD player (DM-SG7) is connected, the disc title and track names appear in the display of the MD player. See the operating instructions for DM-SG7 for details.

Playback of tape

Selection of DOLBY NR Selection of reverse mode

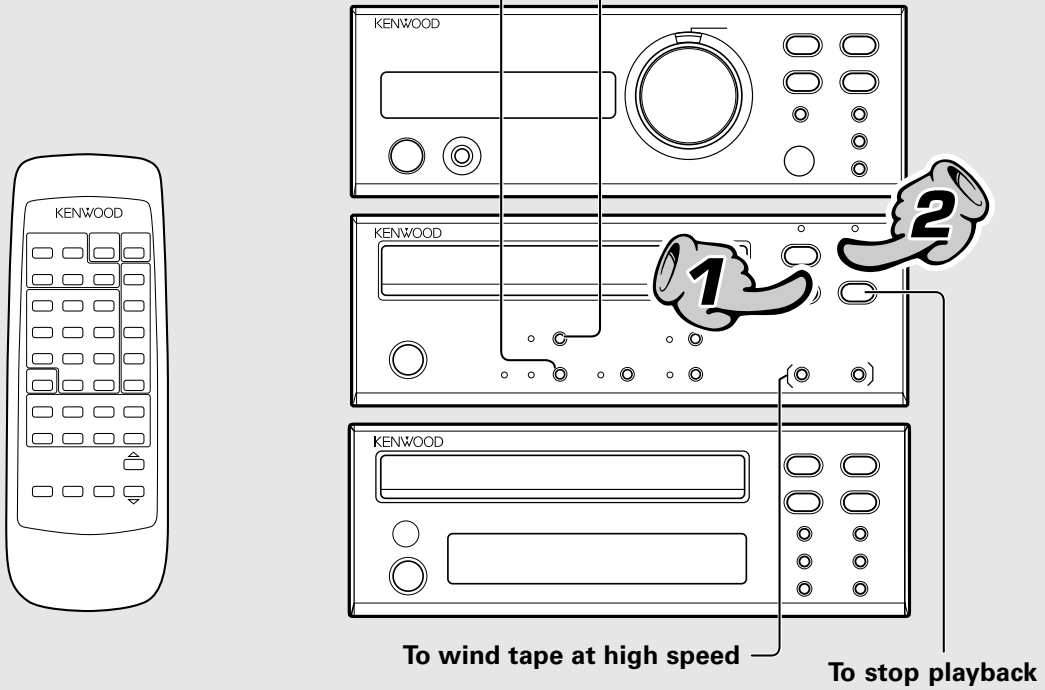

Basic section

1. Load a cassette tape.

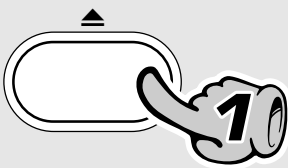

- ❶ Open the tray.
- ❷ Insert a tape and close the tray.

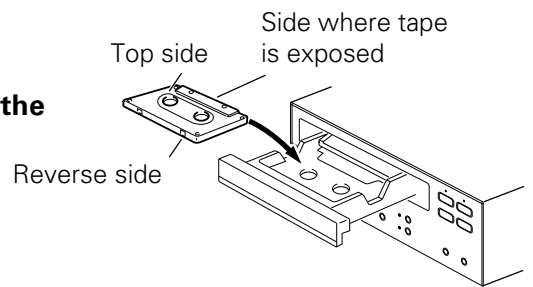

2. Start playback.

Press the key for the running direction to be played.

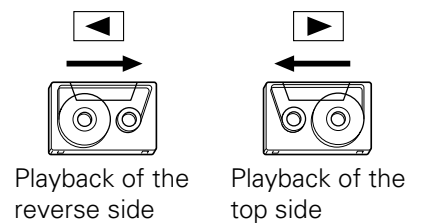
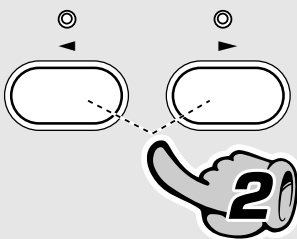

The tape direction lights green.



When the power is ON and a cassette has been set in advance to the cassette deck, playback will start just by setting the input selection to TAPE.

To pause the tape

- Press the ◀ or ▶ key to restart playback.

To wind tape at high speed

To fast wind in direction ◀ To fast wind in direction ▶

- Press the ■ key to stop fast winding.

Selection of reverse mode

rev. mode

Each press switches the modes as follows.

- ① "↔" lit Both sides are played. (The tape stops after recording onto both sides.)
- ② Goes off Only one side is played back (recorded), and then the tape stops.

To stop playback

- The tape direction lights red.

Selection of DOLBY NR (Noise Reduction)

The Dolby NR system minimizes the hiss noise heard when playing tape.

B C Dolby NR

Each press switches the modes as follows.

- ① "B" is lit ... Dolby B NR is used.
- ② "C" is lit ... Dolby C NR is used.
- ③ "B" and "C" not lit ... Dolby NR is not used.

- Select the Dolby NR mode according to the recording condition of the tape.



Since longer tape than 100 minutes cassette tape is very thin, the tape could adhere to the pinch roller or be easily cut. It is recommended that these tapes not be used with this unit to prevent possible damage.

- Set the tape correctly as shown in the figure. Wrong tape setting can cause trouble.
- Normal (TYPE I), high (TYPE II), or metal (TYPE IV) tape selection is set automatically.
- Remove tape slack before loading.

Transport direction indicators

The ◀ and ▶ indicators indicate the current direction in which the tape advances when playback or recording is started automatically by the easy operation function, etc. This direction is the direction stored in memory when the tape was last stopped. (To change the direction, press the key for the desired playback direction, and then press the ■ key.)

Transport direction indicators

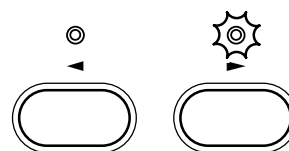

DPSS

DPSS (Direct Program Search System) detects an unrecorded part of 4 seconds or more as the interval between tracks and permits easy operation of cassette tape like a CD.

Skip search

Plays the desired music program from the beginning by skipping programs until you reach the desired program.

Up to 16 programs can be skipped.

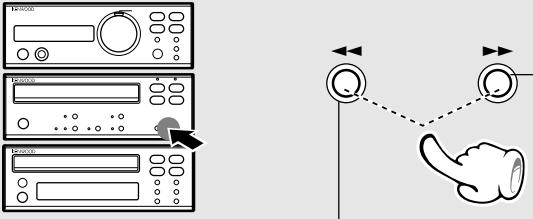
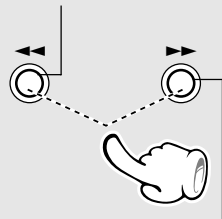
<p>During playback of top side (while ► is lit)</p> <p>To play the next program : Press once. To play the 4th program after the current program : Press 4 times.</p>  <p>To return to the beginning of the current program : Press once. To play the 4th program before the current program : Press 5 times.</p>	<p>During playback of reverse side (while ◀ is lit)</p> <p>To play the next program : Press once. To play the 4th program after the current program : Press 4 times.</p>  <p>To return to the beginning of the current program : Press once. To play the 4th program before the current program : Press 5 times.</p>
--	--

Listening with fast forward for unrecorded portions (dash & play)

Plays music programs repeatedly by skipping non-recorded spaces of more than 10 seconds.

Main unit only

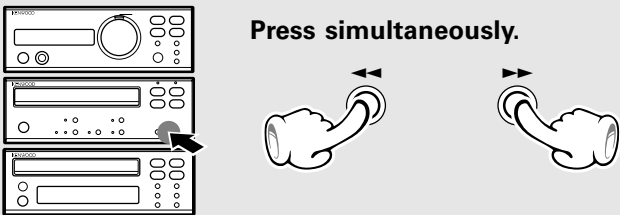

Press simultaneously.

- The operation changes in reverse mode.
 - ① "↔" lit The two tape sides are played 8 times, after which playback stops.
 - ② **Goes off** A tape side is played 8 times, after which playback stops.
- When the ■ key is pressed, playback stops and the dash & play is canceled.

One-program repeat playback

Plays a single music program repeatedly up to 16 times.

Press during playback.

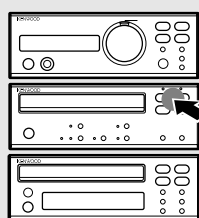

During playback of reverse side (while ◀ is lit)

During playback of top side (while ▶ is lit)

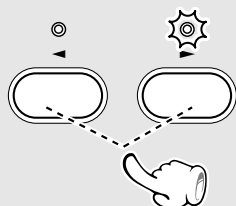

- The program being played will be repeated 16 times, after which normal playback resumes.
- When the ■ key is pressed, playback stops and the one-program repeat is canceled.

Rewind playback

Rewinds tape to the beginning and restarts playback from there.

Main unit only

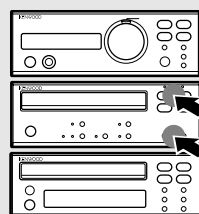

During playback of top side (while ▶ is lit)

During playback of reverse side (while ◀ is lit)

Press simultaneously.

Press simultaneously.

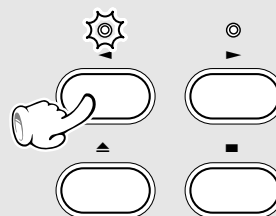
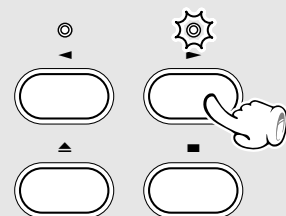

The DPSS may not function normally with the following kinds of tape.

- Tapes containing several no-sound intervals of more than 4 seconds, such as conversation and talk tapes.
- Tapes containing pianissimo sections, such as classical music tape.
- Tapes in which large noise is recorded in blanks between programs.
- Tapes containing blanks between programs that are shorter than 4 seconds.
- Tapes recorded at low level.
- Tapes recorded by cross-fade recording (in which the beginning of next program is overlapped on the end of previous program).

Receiving broadcast station

It is also possible to receive them by one-touch operations by storing up to 40 stations in the preset memory.

Collective presetting of stations (auto preset)
One-by-one presetting (manual preset)

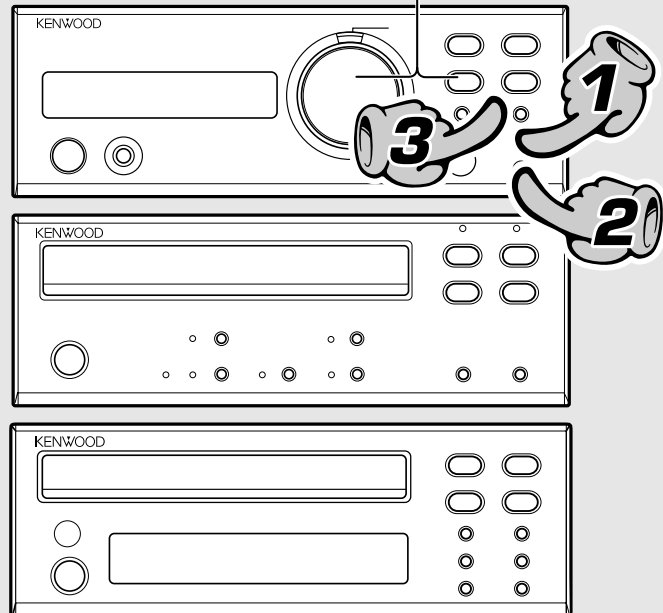
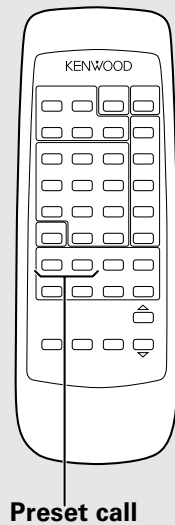

1. Select the broadcast band.

Each press alternates the band.

- ① FM
- ② AM

Remote control unit
P.CALL

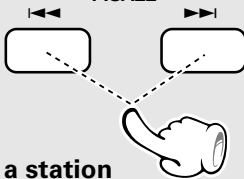

2. Select a station. (It is recommended that you memorize the station in preset memory in advance.)

→ 27

When stations have been memorized (preset call)

Every time the key is pressed, the preset stations are switched over as follows.

Press ►► for the order of 1→2→3 ... 38→39→40→1...

Press ◀◀ for the order of 40→39→38 ... 3→2→1→40...

When no stations have been memorized

Select the station tuning mode according to the strength of radio waves in your environment.

When the radio wave condition is good

: Auto tuning mode (stereo reception)

When the reception is noisy due to weak radio wave

: Manual tuning mode (monaural reception)

① Select the auto or manual tuning mode.

Each press alternates the mode.

- ① "AUTO" lit (Auto tuning)
- ② "AUTO" not lit (Manual tuning)

● Normally, use the **AUTO** (Auto tuning) mode.

auto/mono



To increase frequency

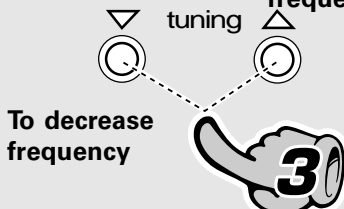

To decrease frequency

Collective presetting of stations (auto preset)

- ❶ Receive a FM broadcast.
- ❷ Keep the "enter" key depressed (for 2 sec or more).
During recording, the indicator "A MEMO" flashes.



One-by-one presetting (manual preset)

- ❶ Press the "enter" key during reception.
Presetting is cancelled when no operation is executed for 5 seconds or more.
- ❷ Select one of the preset numbers from 1 to 40.
Presetting is cancelled when no operation is executed for 5 seconds or more.
- ❸ Press the "enter" key again.

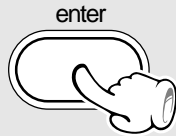
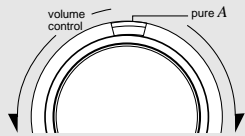
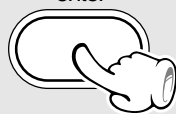

- Up to 30 stations can be memorized.
- For use of the RDS function, stations must be memorized by RDS auto presetting.
- RDS stations are given priority during auto presetting. If there is memory left after presetting, the receiver continues presetting regular FM stations.

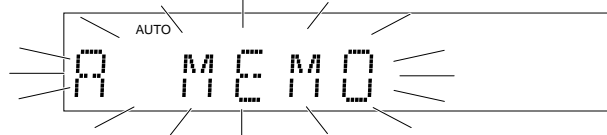

- For memorizing of stations other than RDS stations (FM, AM), memorize the stations according to chapter "One-by-one presetting (manual preset)".
"MEMO." lights (for approx. 5 sec.)

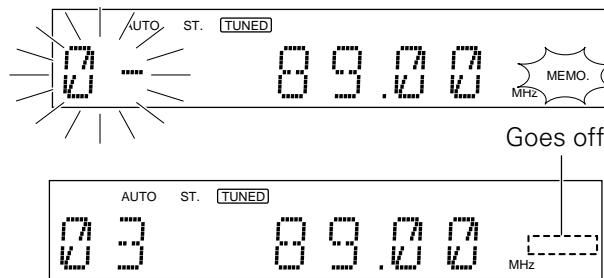

- Repeat steps ❶❷❸ to preset other stations.
- If several stations are preset under the same number, the previous memory is replaced with the latest memory contents.

R-SG7

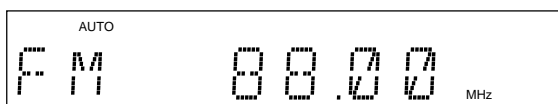

- When a key is held depressed, preset stations will be skipped at an interval of about 0.5 second.
- Preset calls also can be made by numerical input via the numeric keys on the remote control. When the key for the tens digit has been pressed erroneously at the time of input, press the +10 key several times to return to the original display and then enter the number again.

Lights during stereo reception Frequency display R-SG7

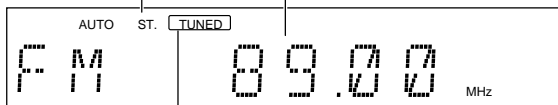

The "TUNED" indicator lights when a station is received.

- ❷ Tune in a station.
Auto tuning : Each press receives the next station.
Manual tuning : Press and hold until the desired station is received.

About display change during tuner reception (remote control only)

The display will change each time the DISPLAY key is pressed.

- DISPLAY
-
- ❶ Reception band/Frequency
 - ❷ Preset number/Frequency
 - ❸ Clock

Recording



Note that this cassette deck cannot record onto Metal tapes.

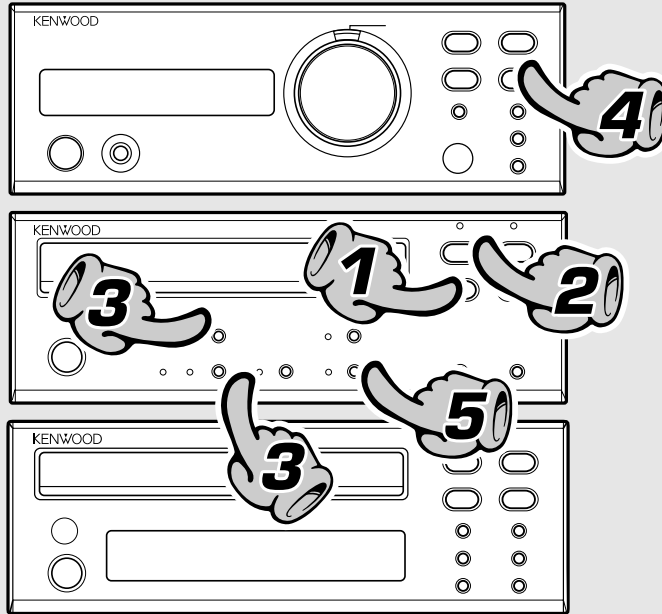
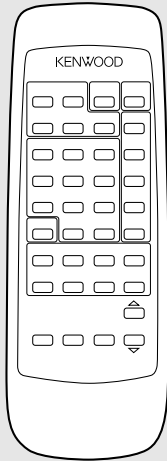

Basic section

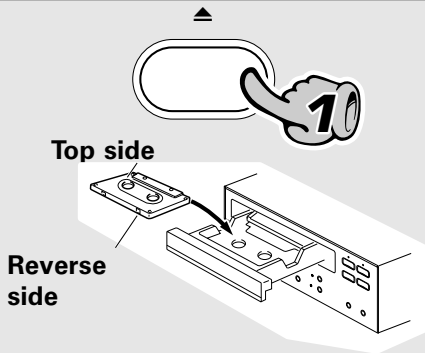

1. Load a tape in deck.

- ❶ Open the tray of the cassette deck.
- ❷ Insert a tape.
- ❸ Close the tray.

- Differentiation between normal (TYPE I) and high (TYPE II) tape is set automatically.
- Remove tape slack before loading.



Since longer tape than 100 minutes cassette tape is very thin, the tape could adhere to the pinch roller or be easily cut. It is recommended that these tapes not be used with this unit to prevent possible damage.

Check the tape transport direction indicator.

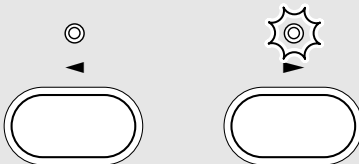

2. Select the tape transport direction.

To reverse the transport direction

- ❶ Press the playback key for the direction to be played (lights green).
- ❷ Stop playback (lights red).

- When recording is started, the tape is transported in the direction selected in this step.
- Wind the tape to the position where recording is to be started.

Dolby NR rev. mode



3. Set the recording condition.

- ❶ Select the reverse mode.
- ❷ Select the DOLBY NR mode.



Temporary stop during recording

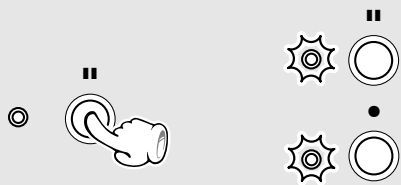

- Press the record key to restart recording.

To interrupt recording

An unrecorded section of about 4 sec is produced directly after the recording has been interrupted.

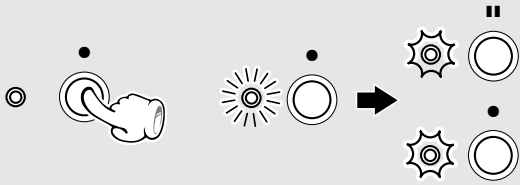

- Recording pause condition is reached after approximately 4 sec.

An unrecorded section of about 4 sec is produced (auto recording mute)

- 1 Obtain stop condition.
- 2 Press the record key twice.

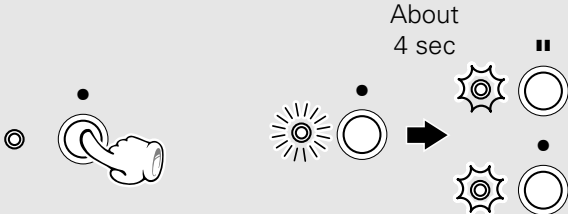

- An unrecorded section of about 4 sec is produced and recording pause condition is reached.

To end recording

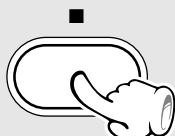

input selector

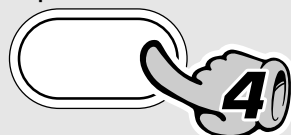

Select an input source other than "TAPE" input.

4. Select the source to be recorded.

The input source component to be recorded should be displayed.

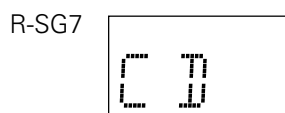

- When the **CD** input is selected and if a disc has been set in the CD player, its playback starts immediately.



5. Start recording.

- 1 Play (or tune) the input source to be recorded.
- 2 Start recording.



- The recording level is adjusted automatically when the CRLS function is used. → 30
- Recording stops automatically when the tape side(s) to be recorded have been fully recorded.

To repeat a recording

Return to the recording start position.

Press the rewind key during recording.

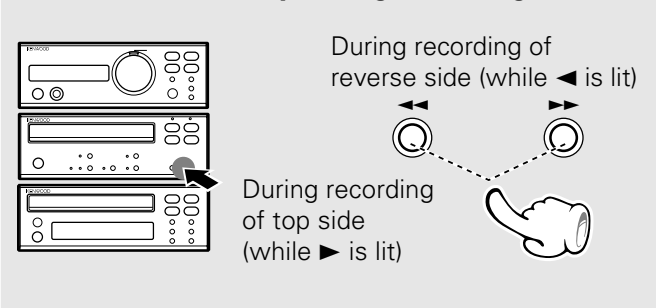

- If there is a non-recorded space of more than 4 seconds before the recording start position, recording is aborted and tape is rewound as shown below.

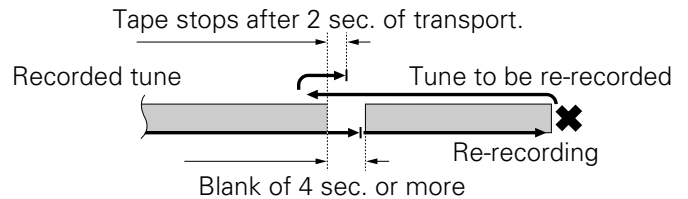

- If there is no recorded tune before, the tape will be rewound then stopped.

Automatic Adjustment of the Recording Level (CRLS)

A standard recording level has been set in advance for the cassette deck (X-SG7), but when the CRLS function is used, the max. recording level is set automatically for the music source.

① Play the contents to be recorded (or receive the radio station to be recorded).

② Press the CRLS key.

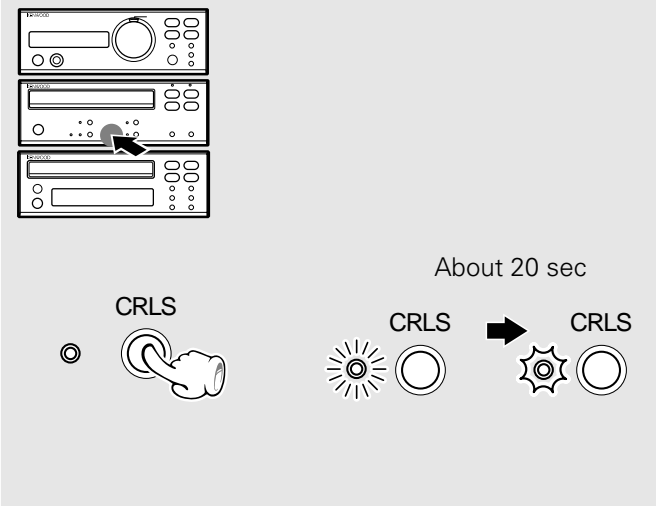

If the key has never been pressed

.....The sound is recorded with the basic level set with the unit.

If the key is pressed

.....The recording level is set automatically and stored in memory as the recording level to be used with the current input being selected. From the next time on, this recording level is set automatically for that input even if the key is not pressed.

To return to the basic level

.....Hold the key depressed until the indicator goes off (for approx. 3 seconds).

- The recording level setting completes in approx. 20 seconds, after which the deck enters the record-pause mode.
- If recording is started during the setting (while the CRLS indicator is blinking), distorted sound may be recorded.
- If a non-recorded space of more than 3 seconds is detected after the **CRLS** key is pressed, the recording level setting is aborted.

Points for Recording from a CD or an MD

For recording from a CD or an MD, playback from the music source and recording by the cassette deck can be started simultaneously (synchro recording function) when the cassette deck is set to record pause status in advance.



- ① Pause the CD or MD to be played.
 - ② Use the skip keys (◀▶) to select the title to be recorded. (Pause will be reached at the beginning of the selected title.)
 - ③ Bring the cassette deck to recording pause condition.
 - ④ Start playback of the CD or MD. (Synchro recording will start.)
- The recording is stopped when the stop key of the playback unit is pressed.

Dolby HX Pro

The Dolby HX Pro headroom extension system records high frequencies such as the cymbal sound clearly by controlling the bias current during recording according to the frequency composition of the sound being recorded. This system is activated automatically during recording with this unit.

Listening in the desired sequence (program playback)

Any tracks on the discs in the tray can be listened to in the desired sequence. (Max. 32 tracks)

Select the "CD" input.

1 Check that the CD player is in the stop mode.

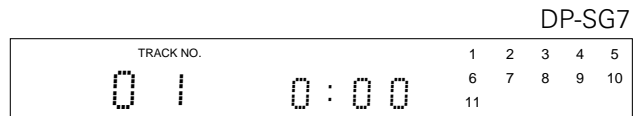
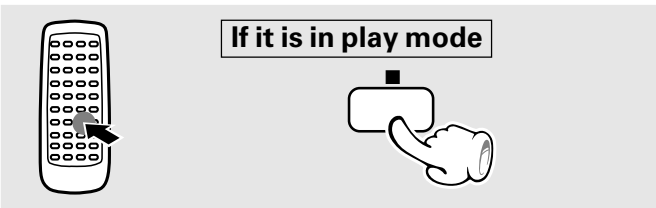

2 Light the "PGM" indicator.

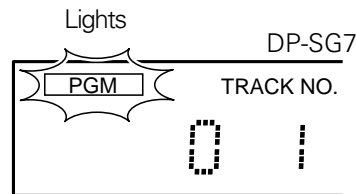
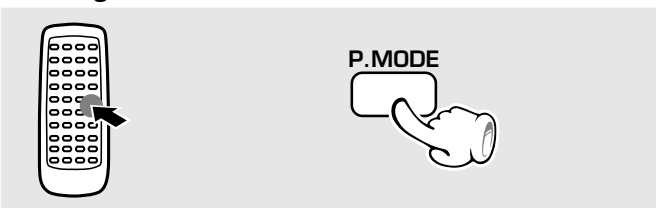

3 Enter track Nos. in the order you want to play them.

1 Select the track.

2 Confirmation.

Within 8 seconds!

3 Repeat steps 1 and 2.

- Up to 32 tracks can be programmed. When "FULL" is displayed, no more tracks can be programmed.
- When an error has been made, press the **CLEAR** key and select again.

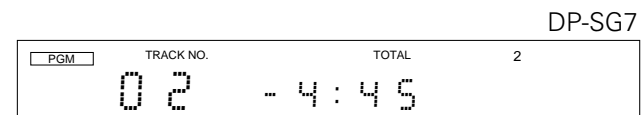
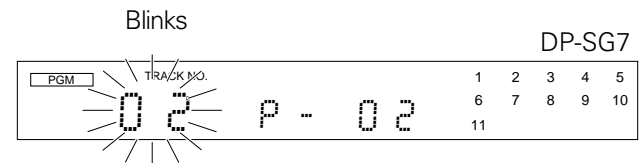

4 Start playback.

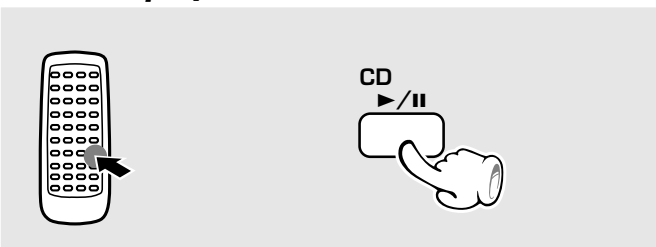

- Tracks will be played in the order they were programmed (in order of P Nos.).
- When the ◀◀ or the ▶▶ key is pressed during play, the program will jump to the preceding or the following track respectively.
- When the ◀◀ key is pressed once during playback, the play position returns to the beginning of the current track being played.

To add a track to the program

① Select the track.

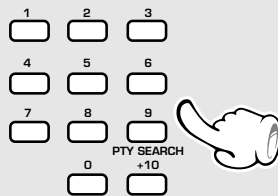

② Press the P. MODE key.

- When a track No. is entered, the track will be added to the end of the existing program.

To delete a programmed track

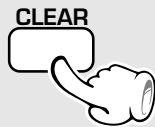

- Each time the key is pressed, the last track will be deleted.
- A track being played can not be deleted.

To quit the program mode

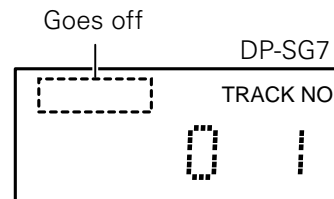
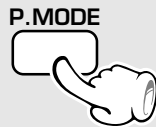

- If the key is pressed during playback, normal playback in order of tracks resumes from the current track.
- Cancellation also is made by pressing the Open/Close (▲) key.

Auto space function

This function is convenient for recording CD on a cassette tape. When the "space" key is pressed during programming of tracks, a non-recorded space of a few seconds will be created between tracks. (The SPACE indicator flashes.) By recording tracks with these spaces on tape, the search and repeat play operations of tape using the DPSS function (which works by searching the non-recorded spaces) can be performed reliably.

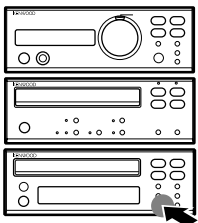

- Even when the performances of two tracks are continuous (which occurs with classical or live recording music), the spaces will be created if they have different track Nos.
- To cancel the creation of space, press the "space" key again.

Repeated playback

Desired tracks or discs can be played back repeatedly.

Select the "CD" input.

To repeat a disc

❶ Confirm that the "PGM" indicator is not lit.



If the "PGM" indicator is lit, press the P.MODE key to turn it off.

Confirm that this is not lit. DP-SG7

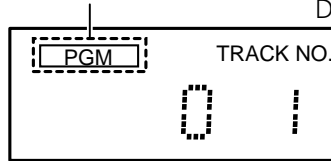

❷ Press the "repeat" key.

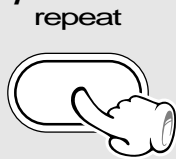
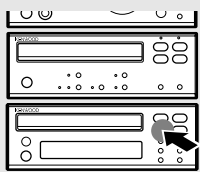

Lights DP-SG7



❸ Start playback.

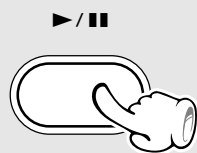
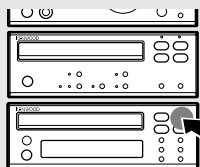

To stop repeated playback

Press the "repeat" key again.

- The "REPEAT" indicator goes off and the playback following the current mode of the CD player starts.

To repeat only the programmed tracks

❶ Follow the procedure for "Listening in the desired sequence" to step ❸ to program the tracks to be played. → 31

❷ Press the "repeat" key.

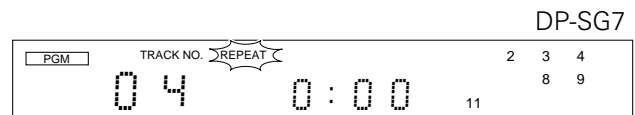
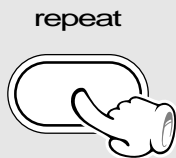
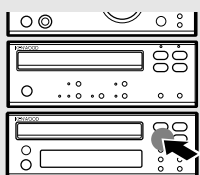

❸ Start playback.

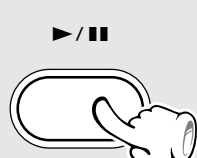
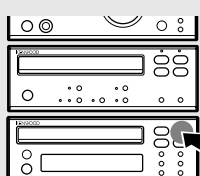

To stop repeated playback

Press the "repeat" key again.

- The "REPEAT" indicator goes off and the playback following the current mode of the CD player starts.

Listening to an unexpected track sequence (random playback)

As the tracks each time are selected randomly, the music can be enjoyed.

Select the "CD" input.

1 Confirm that the "PGM" indicator is not lit.

If the "PGM" indicator is lit, press the P.MODE key to turn it off.

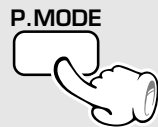
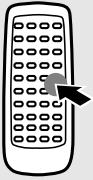

Confirm that this is not lit.

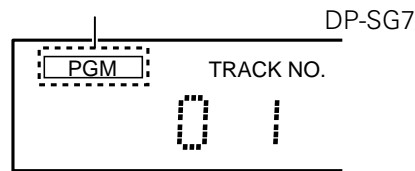

2 Press the RANDOM key.

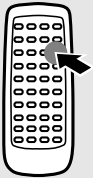

- Playback stops after each track has been played once.
- The random playback can also be repeated by pressing the "repeat" key.



To select another track in the middle of playing one

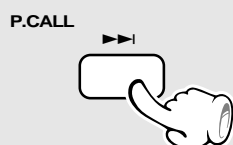

- Pressing the P.CALL key once returns to the beginning of the track being played.

To cancel random playback

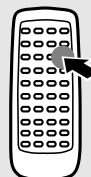

- From the track being played at this time, playback will be in the normal order of tracks.

Selecting the optimum recording method

With this unit, the following edit recording is possible according to the purpose.



Note that this cassette deck cannot record onto Metal tapes.

If you want to avoid any tune being interrupted at the end of tape



Giving preference to the tape length over the track sequence (time edit recording) →

Edit recording of CD is possible by the simple operation of entering the recording length of the tape.

If you want to select the tracks to be recorded while playing a CD



Recording only desired tracks

(ONE TOUCH EDIT.....single track recording) →

Play a CD and, if a track you want to record starts, press the O.T.E. (One Touch Edit) key. The track will be recorded from the beginning.

If you want to record a CD in order of track numbers



One touch recording of an entire CD

(ONE TOUCH EDIT.....recording of all tracks) →

Press the O.T.E. (One Touch Edit) key when in the stop mode. The disc will start to be recorded.

Giving preference to the tape length over the track sequence (time edit recording)

When the tape recording time is specified, recording is executed with changing the track sequence so that no track will be interrupted when the tape direction is changed at the end of one side.

Recording preparations are required.-- (Steps 1 to 4)

1 Select the "EDIT" mode.

1 Confirm that the "PGM" indicator is not lit.

If the "PGM" indicator is lit, press the P.MODE key to turn it off.

2 Press the EDIT key.

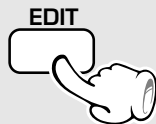
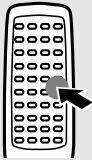

The editing is ended when no operation is executed for 8 sec or more.

Confirm that this is not lit

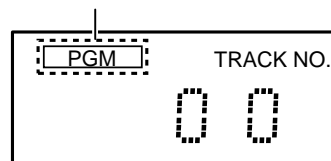

- To cancel the EDIT mode, press the **P.MODE** key of the remote control unit.

DP-SG7

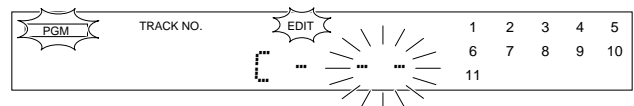

2 Enter the recording length of the tape.

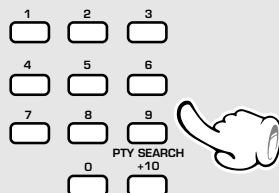

When the "time" key is pressed repeatedly, a tape length of 46, 54, 60, or 90 minutes can be selected easily. After selection, press the EDIT key to go to step 3.

Confirm that the "EDIT" indicator changes from flashing to steady lighting, and then go to step 3.

Press the numeric keys as shown below.

30-minute tape : **+10 +10 +10 0**
46-minute tape : **+10 +10 +10 +10 6**

DP-SG7

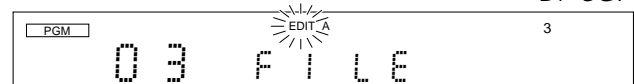

- When automatic edition has been completed, the "EDIT" indicator lights.
- When a wrong time has been entered, confirm that the "EDIT" indicator is lit and start again from step 1.
- Up to 32 tracks can be edited.
- Every time the **▶▶** key is pressed, the edited track numbers will be displayed in the changed order. Press the **■** key to return to the track number of the first track.

3 Start edit recording.

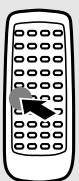

DP-SG7



- The tape and CD stop automatically when recording has completed.



Depending on the combination of conditions from CD contents (number of tracks and length of the tracks) and tape recording time, interruption of a track may not be avoidable. In such a case, the respective track will not be recorded.

Recording only desired tracks (ONE TOUCH EDIT.....single track recording)

At the time of CD playback, any desired track can be selected immediately for recording.

When playing an MD with the DM-SG7 (option), the same procedure can be used to record only that track on tape.

Recording preparations are required. -- 28 (Steps 1 to 4)

1 Play a CD.

Select a mode other than random play.

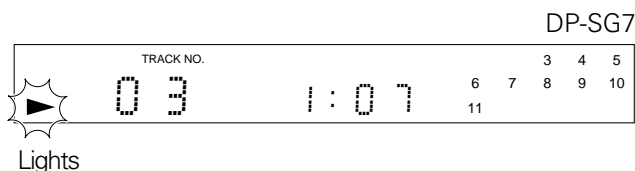
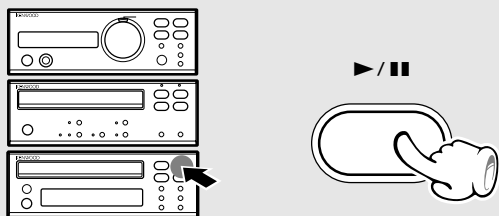

2 When you want to record a track being played, press the O.T.E. key.



In case the key is pressed with track No.3

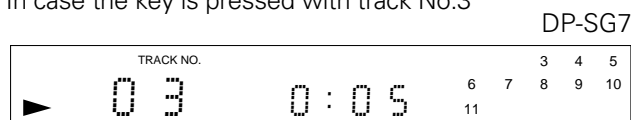

- Playback restarts from the beginning of the track being played and recording starts at the same time.

When recording has been completed, a non-recorded portion of 4 seconds will be produced and the cassette deck part will stop. The CD player will enter temporary stop condition.

To record a different track, repeat the steps 1 and 2.



If you set CRLS beforehand you can enjoy better recording. → 30

To end recording in the middle

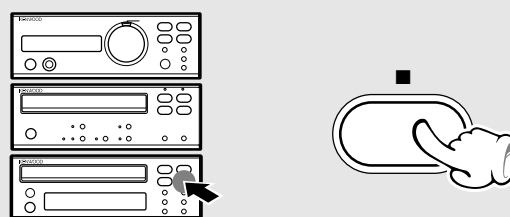

- Both the cassette deck and CD player stop.

One-touch recording of an entire CD (ONE TOUCH EDIT.....recording of all tracks)

When the O.T.E. key is pressed while the CD player is in the stop mode, recording of a CD can be started at the same time as playback.

When the DM-SG7 (option) is connected and the input selector is set to "MD", the same procedure can be used to make a one-touch recording of the entire MD on tape.

Recording preparations are required.--  (Steps 1 to 4)

1 Check that the CD player is in the stop mode.

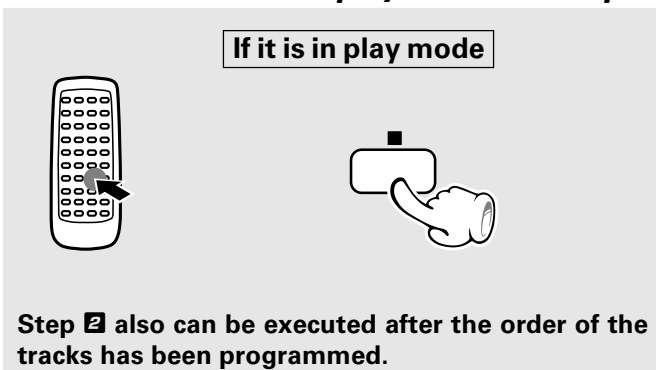

- When recording a CD, set the input selector to CD.

2 Press the O.T.E. key.

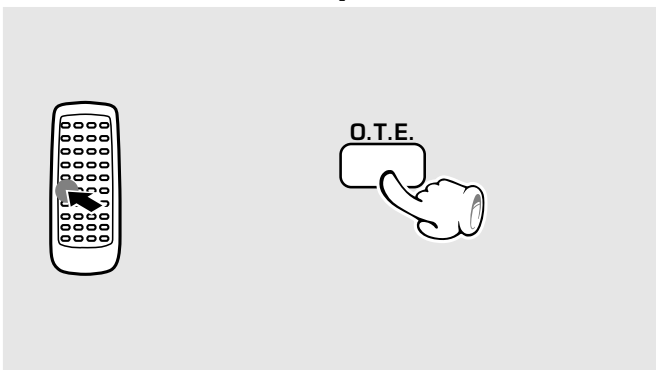

- Recording of CD starts at the same time as playback.
- When the tape direction is changed at the end of the tape, no sound is recorded on the guide tape. When interruption of a track is to be avoided, restart recording from the very beginning of the reverse side according to "Recording". 



To end recording in the middle

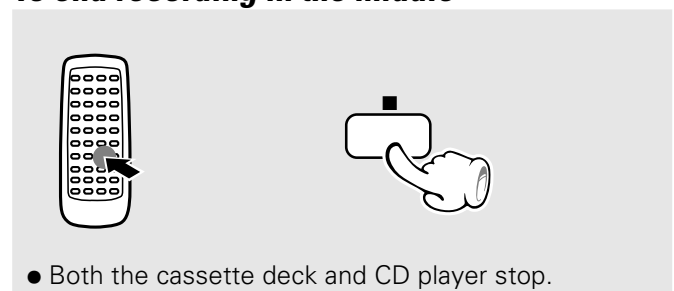

RDS is a system which transmits useful information (digital data) for FM broadcasts together with the broadcast signal. Tuners and receivers designed for RDS reception can extract the information from the broadcast signal for use with various functions such as automatic display of the station name.

For reception of RDS stations, the RDS auto presetting function must be used to preset the stations.

"NO DATA" will be flashed when a station not preset by auto presetting is received. → 27

This unit is equipped with the following functions utilizing RDS data:

PTY (Program Type Identification) Search :→ 40

The tuner automatically searches for a station which is currently broadcasting a specified program type (genre).

PS (Program Service Name) Display : (See below.)

When an RDS broadcast is received, the station name is automatically displayed.

EON (Enhanced Other Network) : → 42

When the information to be received is set in advance and any RDS station in the same network starts broadcasting of such information, the reception automatically will be switched to that station.

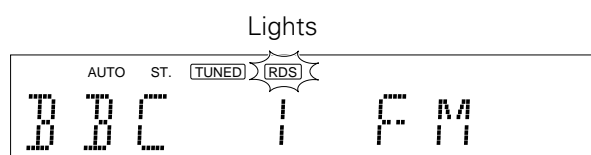

The "RDS" indicator lights up when an RDS broadcast (signal) is received.

* Some functions may not be provided or be given different names depending on countries or areas.

To switch the display contents

Pressing the DISPLAY key changes the display contents.

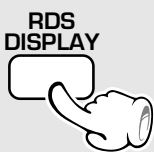
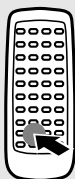

Display mode priority ranking

- ① **PS (Program Service Name) Display :** When an RDS broadcast is received, the station name is automatically displayed. If no PS data was sent, "NO PS" is displayed.

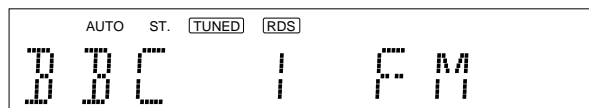

- ② **Frequency Display :** The frequency of the current station is displayed.

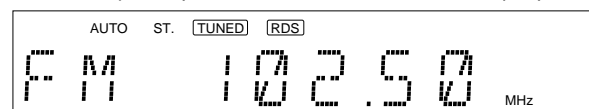

Searching for a desired program type (PTY search)

By specifying the type of program (genre) you want to listen to, the tuner automatically searches for a station which is currently broadcasting a program of the specified type.

For reception of RDS stations, the RDS auto presetting function must be used to preset the stations. 

Set the reception band to FM.

1 Activate the PTY search mode.

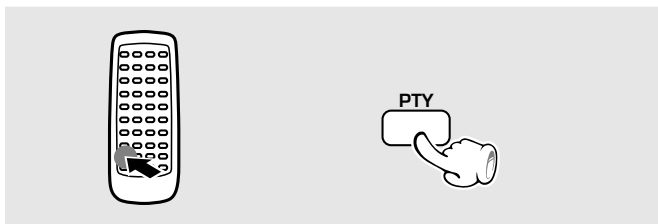

When an RDS broadcast is received, the program type is shown on the display. If no PTY data is available, or if the station is not an RDS station, "NONE" is displayed.

2 Select the program type you desire.

Use the program type table on the right for your convenience.

Program type table

Ⓐ	Ⓑ	Program Type Name	Display
DOWN ↑	1	Pop Music	POP M
	2	Rock Music	ROCK M
	3	Easy listening Music	EASY M
	4	Light Classical Music	LIGHT M
	5	Serious Classical Music	CLASSICS
	6	Other Music	OTHER M
	7	News	NEWS
	8	Current Affairs	AFFAIRS
	9	Information	INFO
	0	Sport	SPORT
UP ↓		Education	EDUCATE
		Drama	DRAMA
		Culture	CULTURE
		Science	SCIENCE
		Varied Speech	VARIED
		Weather	WEATHER
		Finance	FINANCE
		Children's programmes	CHILDREN
		Social affairs	SOCIAL
		Religion	RELIGION
	Phone in	PHONE IN	
	Travel	TRAVEL	
	Leisure	LEISURE	
	Jazz music	JAZZ	
	Country Music	COUNTRY	
	National Music	NATION M	
	Oldies Music	OLDIES	
	Folk Music	FOLK M	
	Documentary	DOCUMENT	

Ⓐ To select using the P.CALL keys

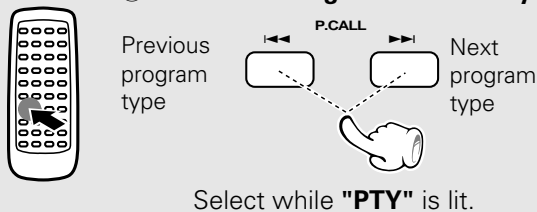

Select while "PTY" is lit.

The P.CALL keys let you select from all 29 program types in the order shown at right. Press the key and release it when the desired type is displayed.

Ⓑ To select with the numeric keys

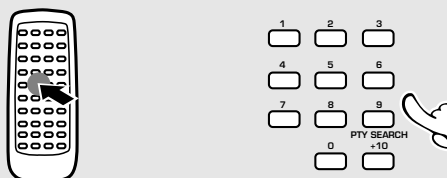

The numeric keys allow you to select programme types 1 to 0 directly. If you want to select one of the other programme types, use the P.CALL key.

"NO DATA" is displayed if this operation is attempted before performing the RDS auto presetting function.

- The operations shown in Ⓐ can also be performed with the **TUNING** keys on the front control.

3 Start the search.

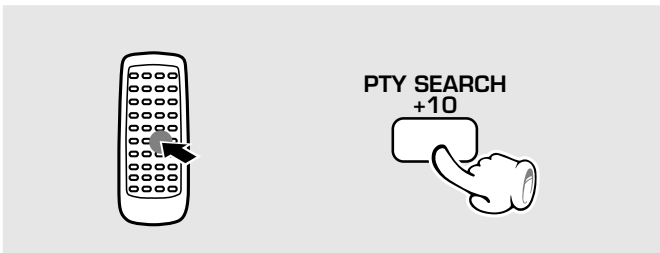

To select another program type
Repeat steps **1**, **2** and **3**

EXAMPLE: Searching for a Rock Music broadcast.

Display while searching

Blinks

R-SG7

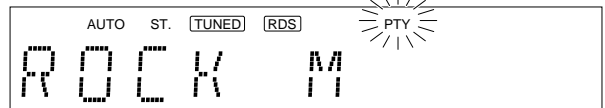

Program type name display

- When the PTY is received, the PTY name blinks and the "PTY" lights up.

Display when a station is received.

Goes out

R-SG7

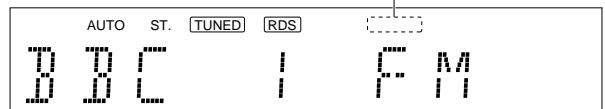

Station name display

- No sound is heard while "PTY" is blinking.
- If the desired program type cannot be found, "NO PROG" is displayed, then after several seconds the display returns to the original display.
- If the desired program type is found, that program is received. The program type display changes temporarily to the frequency display, and then to the station name display.

To be able to listen to the desired information at any time (EON reservation)

By using the EON function, which manages the information of other stations, listening to desired information like traffic information or news etc. can be reserved even when it is not being transmitted at the present. When listening to a station with the "EON" display lit and another station of the same network starts to broadcast an information program for which a reservation has been made, then that station will be selected automatically. When the desired information program ends, return is made to the original program.

For reception of RDS stations, the RDS auto presetting function must be used to preset the stations.

→ 27

Set the reception band to FM.

1 Select the desired information.

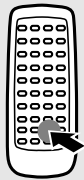

Each press switches the modes as follows.

- ① TA..... Traffic Announcement
- ② NEWS..... News
- ③ INFO..... Information
- ④ Display not lit..... EON cancelled

When "INFO" is selected

This lights for stations where TP (Traffic Program) can be received.

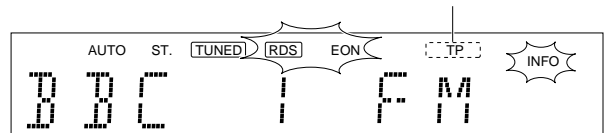

- Please execute automatic presetting when TA, NEWS, and INFO can not be selected.

2 Receive an RDS station.

Select a station where "RDS" and "EON" are lit.

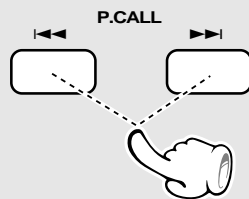

"RDS" and "EON" are lit

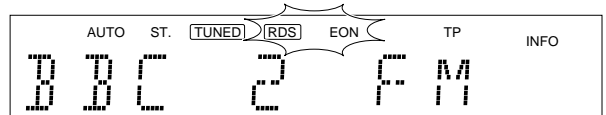

- When "TA" has been selected in step 1, always select a station for which the "TP" indication is lit.
- When "EON" does not light although an RDS station is received, that station is not transmitting EON data. Please select a different station.

3 Wait for the desired information.

CD or tape playback also may be started. As long as the power is ON, standby condition will exist.

TP (Traffic Program) Indication

When the "TP" indication is lit, this indicates that this station or a station in the same network is transmitting traffic information.

When "TP" is displayed for the station presently being received, the traffic information of this station can be heard even without EON reservation.

- When one of the stations of the network of the station received in 2 starts broadcasting the program contents selected in 1, that station will be received automatically. At this time, the input selection becomes TUNER, and CD or MD playback will pause. However, external equipment (AUX) will remain as it is. When reception of the desired EON programs is complete, input selector returns to the previous input source.
- When the power is OFF and during recording, the EON function does not operate.
- When the transmission of the selected program contents ends in case of automatic reception with the EON function, return will be made to the status directly before operation of the EON function.

Listening in Pure A Mode

Setting to pure A operation mode (pure A) is recommended when listening with low volume close to the set or late at night. Then you can enjoy smooth high-quality sound with little distortion.

Please use the normal mode to listen at higher volumes.

CAUTION

When pure A mode is selected, a certain amount of power is used even when no music source is played back, and the temperature of the amplifier section will rise.

1 Switch on pure A.

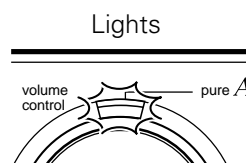
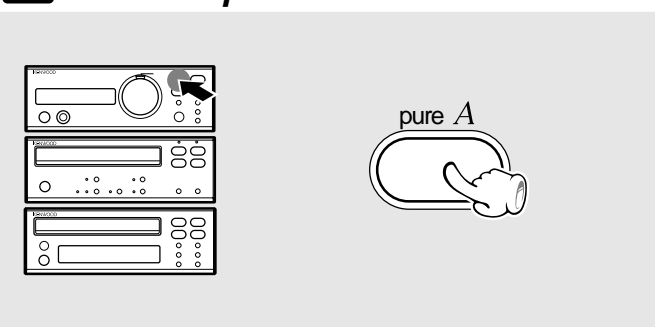

R-SG7

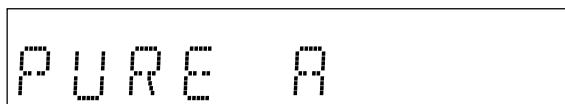

2 Play the music.

3 Adjust the volume.

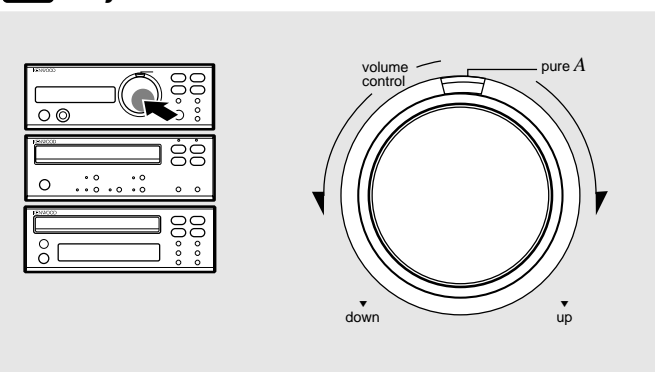

R-SG7

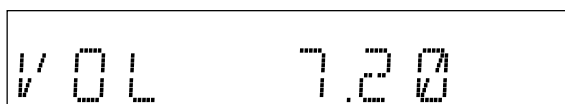

Volume indication

- The volume indication changes to an indication matching the low volume.
- When this is pressed again in pure A mode, normal mode will be obtained. (The pure A indicator goes out.)

What is Pure A?

The amplifier section amplifies the voltage and current of the input signal from the CD etc. and sends the output to the speakers. In order to suppress the distortion occurring with this amplification, amplifiers with class A operation or class AB operation always have current flowing through the circuits for current amplification. This is called the idling circuit. Especially an amplifier with class A operation has a high idling current in comparison to an amplifier with class AB operation, which is used by many units. As the result, class A operation has distortion suppressed to a minimum, and smooth playback with high quality is possible. However, as a certain amount of power is consumed even when no music source is played, the temperature of the amplifier section will become comparatively high. Thus a high-class amplifier with a large-capacity power supply is required to enjoy the sound quality of class A operation.

The amplifier of this unit normally operates in class AB operation, but as the high sound quality of class A operation can be enjoyed easily, a class A operation mode for listening at low volume (pure A) has been provided. Please enjoy the pure A sound quality when listening at low volume close to the set, late at night, etc.

This unit incorporates a clock function. Be sure to adjust the correct time before using the timer function.

Ensure that the power is OFF.

1 *Activate the clock adjustment mode.*

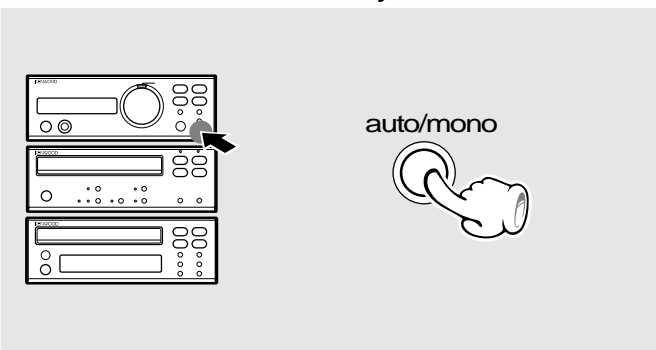

Example: Adjustment to 8:45

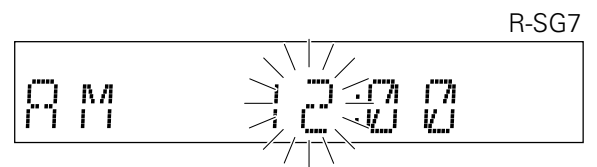

- The time display starts to blink.

2 *Enter the hour.*

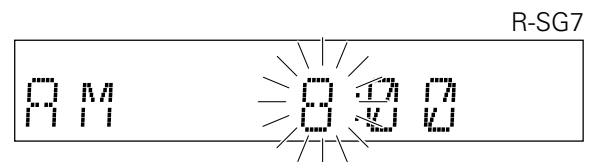
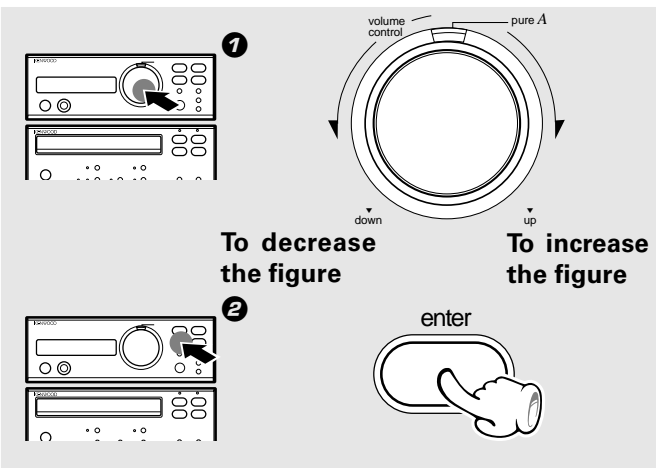

- The time of the day is represented in 12-hour AM/PM method.
- Press the "enter" key. The hour is entered and the minute display starts to blink.

3 *Enter the minute.*

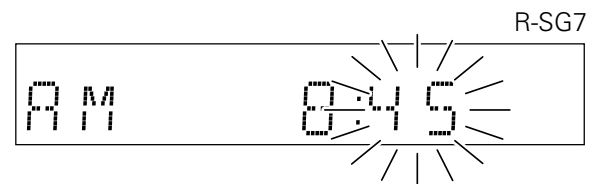
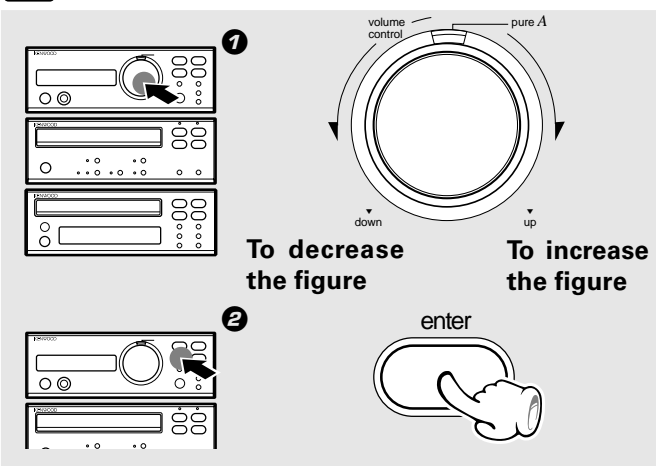

- If you make a mistake, restart from the beginning.
- To adjust correct time, press the "enter" key at the same moment as a time announcement.
- The time display blinks after a power failure or when the power cord has been unplugged from the AC outlet and plugged again. In such a case, adjust the clock again.

Timer operation

Operate easy To use Timer (O.T.T.)

Playback of the selected input source starts at the specified time, and the power is switched off after one hour. This timer operates only once directly after setting.

Sleep timer

The power is turned OFF automatically after the specified period has elapsed.

Timer playback, timer recording

Playback of the selected source (or broadcast recording) will be executed for the set time.

AI timer playback

When timer playback starts, the volume increases gradually.

Adjust the clock before setting the timer.



Operate easy To use Timer (O.T.T.)

Timer playback is possible simply by setting the time. The source selected last before the power was switched off will be played. One hour after start of timer playback, the power will be switched off automatically.



The program timer does not operate during playback by the O.T.T. timer.

- 1 Select the source to be played and set the volume.
- 2 Switch OFF the power supply.
- 3 Press the "tuning (▽)" key.

- 4 Set the ON time.

- 5 Press the "enter" key.

- When the "tuning (▽)" key is pressed, the input source will be displayed, and after a few seconds, the ON time will be displayed.

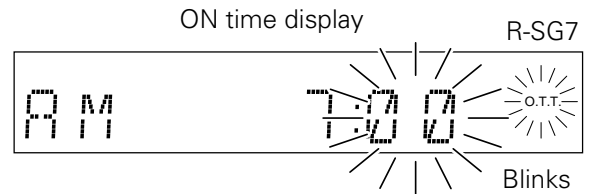

- The ON time can be set in steps of 5 minutes.
- In case of combination with another timer, the input source which operated last will be played.

To cancel

Press the "tuning (▽)" key twice while the power is OFF.

Adjust the clock before setting the timer.

Sleep timer

Set the number of minutes after which the power is to be turned OFF.

- 1 Turn the power ON.

- 2 Set the time.

- The power is turned OFF automatically after the set time has elapsed.
- Each press decreases the time by 10 minutes. The maximum time that can be set is 90 minutes.

90→80→70...30→20→10→Cancel→90→80...

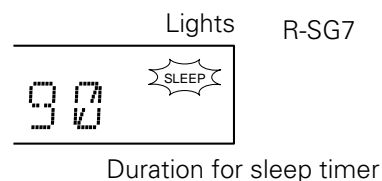

To cancel

Turn the power OFF or press the SLEEP key until the sleep time is cancelled.

Timer programming

This is a 24 hour timer.

Select the time and duration for the operation and the contents, and select operation or no operation as required.

Adjust the clock before setting the timer. →  44

1 Make preparations for the play (recording).

- To listen to radio

The station should be preset prior to the above. →  27

- To listen to CD

Insert a disc. (Program playback is not possible.)

- To listen to tape

Set a tape into deck.

- Listening to MD

Set a disc into the MD recorder.

- For recording

Make preparations for recording. →  28 (Steps 1 to 4)

For recording and playback with an MD recorder (DM-SG7), also refer to the instruction manual enclosed with the DM-SG7.

2 Adjust the listening volume.

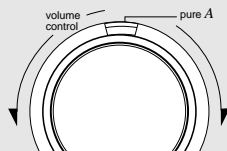
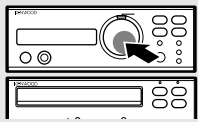

- For recording of broadcasts, muting becomes ON automatically when the power is switched on by the timer.

3 Set the on/standby switch to standby position.

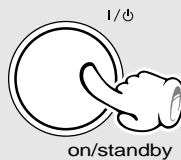
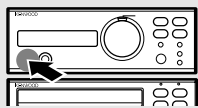

4 Select a program No.

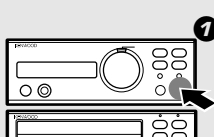

During display of program content

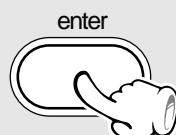
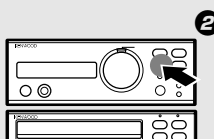

- The "PROG." indicator lights.
- When a timer reservation already has been made, the contents will change to the new settings.

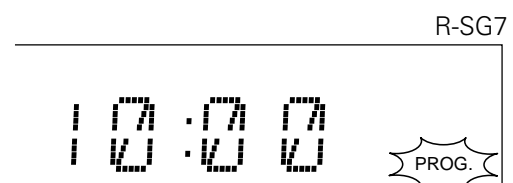

5 Enter the ON time.

1 To decrease the figure To increase the figure

2 enter

- After entering the "hour" with the procedure in **1** and **2**, enter the "minute" using the same procedure.

R-SG7

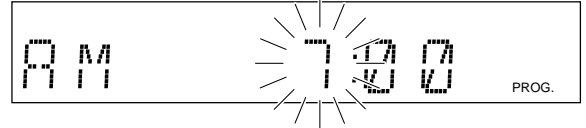

- If you commit a mistake, restart from step **4**.

6 Enter the OFF time.

1 To decrease the figure To increase the figure

2 enter

- After entering the "hour" with the procedure in **1** and **2**, enter the "minute" using the same procedure.

R-SG7

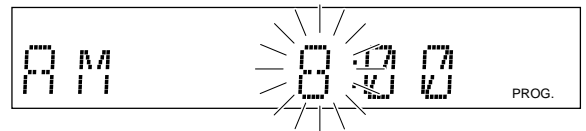

- If you commit a mistake, restart from step **4**.

7 Make the desired reservation.

For timer playback or AI timer playback

1 Select the mode.

Select "PLAY" or "AI".

PLAY Timer play
AI Timer play with gradually increasing volume

REC

Enter it.

2 Select the input source.

Select the source to be played.

TUNER
CD
TAPE
MD (DM-SG7)
AUX

Enter it.

3 Select the broadcast station (only when TUNER is selected).

Select the preset station No.

Enter it.

Timer recording of radio broadcasts

1 Select the mode.

Select "REC".

PLAY
AI
REC

Enter it.

2 Select the input source.

Select the source to be played.

TUNER
AUX

Enter it.

3 Select the broadcast station (only when TUNER is selected).

Select the preset station No.

Enter it.

4 Select the recording unit.

TAPE
MD (DM-SG7)

Enter it.

Application section

Continued on next page

8 Set the program.

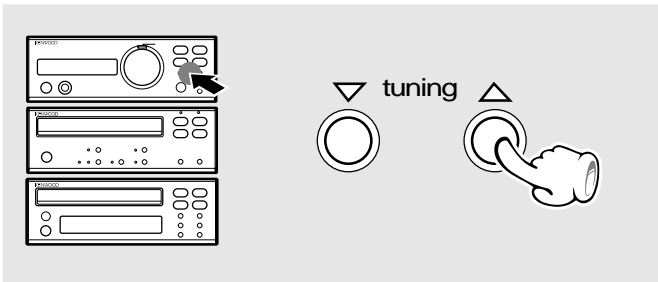

- The "PROG." indicator lights.

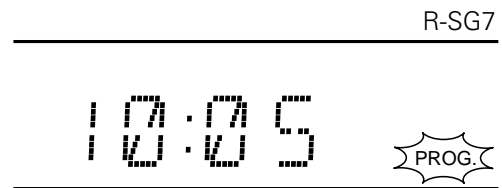

- The timer does not operate when no program is set.

This completes the program timer reservation. Please refer to the following item for confirmation, changes, etc.

Ensure that the power is OFF.

Check the reservation content.

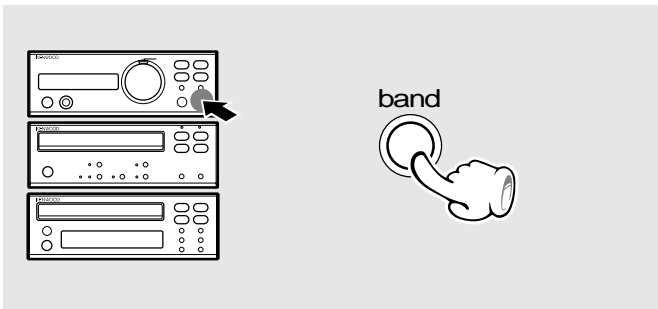

The reservation contents cannot be cleared. The contents are cleared only when they are changed.

- The reserved contents will be displayed for 3 seconds per item. After this, the previous display content appears again.

To change the reserved contents

Restart the procedure of "Timer programming" from the beginning.



When timer operation is not required

Extinguish the program indication.

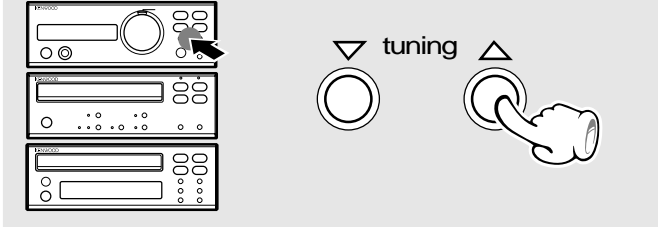

- The reservation contents are held in memory.

To set the same timer program again

Light the program indication.

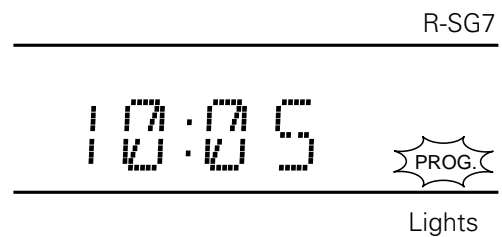
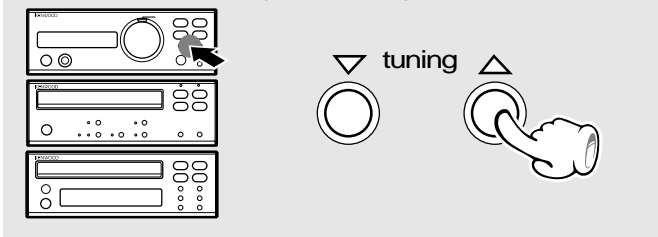

- Also prepare the disc or tape and adjust the listening volume.

Handling of discs and tapes

Disc handling precautions

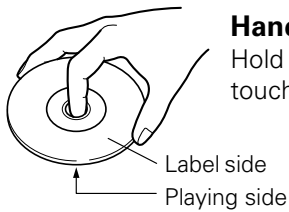

Handling

Hold the discs so that you do not touch the playing surface.

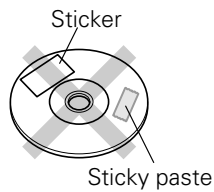

Do not attach paper or tape to either the playing side or the label side of the discs.

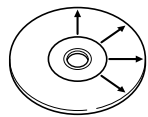

Cleaning

If fingerprints or foreign matter become attached to the disc, lightly wipe the disc with a soft cotton cloth (or similar) from the center of the disc outwards in a radial manner.

Storage

When a disc is not to be played for a long period of time, remove it from the player and store it in its case.

Discs which can be played with this unit

CD (12 cm, 8 cm), and the audio part of CDV, CD-G and CD-EXTRA.

Use discs that comply with the IEC standard, for example a disc carrying the  marking on the label surface.

Never play a cracked or warped disc

During playback, the disc rotates at high speed in the player. Therefore, to avoid danger, never use a cracked or deformed disc or a disc repaired with tape or adhesive agent. Please do not use discs which are not round because they may cause a malfunction.

Disc accessories

The disc accessories (stabilizer, protection sheet, protection ring, etc.) which are marketed for improving the sound quality or protecting discs as well as the disc cleaner should not be used with this system because they may cause malfunction.

Notes on cassette tape

Safety tab (accidental erasure prevention tab)

After an important recording has been finished, break the safety tab, to prevent the recorded contents from being erased or recorded on accidentally.

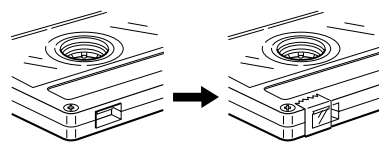
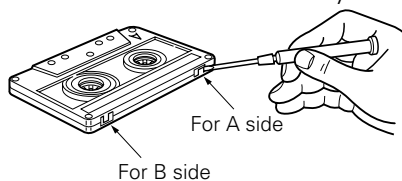

To re-record

Apply tape only to the position where the tab has been removed.

To store cassette tapes

Do not store the tapes in a place which is subject to direct sunlight, or near equipment that generates heat. Keep the cassette tapes away from any magnetic field.

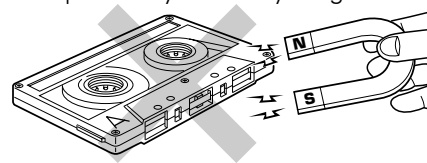

When there is slack in the tape

In such a case, insert a pencil into the reel hole and wind the reel hub to remove the slack.

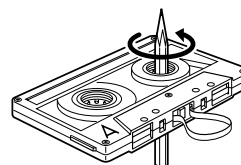

1. Longer tape than 100 minutes cassette tape

Since longer tape than 100 minutes cassette tape is very thin, the tape could adhere to the pinch roller or be easily cut. It is recommended that these tapes not be used with this unit to prevent possible damage.

2. Endless tapes

Do not use an endless tape, as this could damage the mechanism of the unit.

Maintenance

Cleaning the head section

Cleaning the heads and peripheral components

For maintaining the best condition of the deck and for longer service life, always keep the heads (recording / playback / erase), capstan and pinch roller clean.

For the cleaning, use a cleaning cassette available in audio stores.

For details, read the instruction manual of your cleaning tape.

Demagnetizing the head

When the recording / playback head is magnetized, the sound quality will deteriorate. In such a case, demagnetize the head using a commercially available demagnetizer (head eraser).

Maintenance of the unit

When the front panel or case becomes dirty, wipe with a soft, dry cloth. Do not use thinner, benzine, alcohol, etc. for these agents may cause discoloration.

In regard to contact cleaner

Do not use contact cleaners because it could cause a malfunction. Be specially careful not to use contact cleaners containing oil, for they may deform the plastic component.

When your unit needs to be repaired, bring the entire set (Speakers excluded) to your dealer.

Reference

Caution on condensation

Condensation (of dew) may occur inside the unit when there is a great difference in temperature between this unit and the outside.
 This unit may not function properly if condensation occurs. In this case, leave the unit for a few hours with the power left ON, and restart the operation after the condensation has dried up.

Be specially cautious against condensation in a following circumstance:
 When this unit is carried from a place to another across a large difference in temperature, when the humidity in the room where this unit is installed increases, etc.

Dolby noise reduction and HX Pro headroom extension manufactured under license from Dolby Laboratories. HX Pro originated by Bang & Olufsen. "DOLBY", the double-D symbol and "HX PRO" are trademarks of Dolby Laboratories.

Note related to transportation and movement (CD player)

Before transporting or moving this unit, carry out the following operations.

1. Turn the power ON but do not load a disc.
2. Wait a few seconds and verify that the display shown appears.

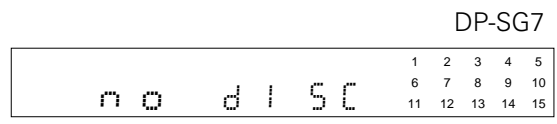

3. Turn the power OFF.

Memory backup function

Stored contents which are cleared immediately when power plug is unplugged from power outlet	Clock display
Stored contents which are cleared in at least a day after power plug is unplugged from power outlet	Amplifier POWER status (ON or OFF) Input selection Volume control value TONE Level Tuner unit Receiving band Frequency Preset stations Program settings

WARNING NOTICE:

IN MOST CASES IT IS AN INFRINGEMENT OF COPYRIGHT TO MAKE COPIES OF TAPES OR DISCS WITHOUT THE PERMISSION OF THE COPYRIGHT OWNERS. ANYONE WISHING TO COPY COMMERCIALY AVAILABLE TAPES OR DISC SHOULD CONTACT THE MECHANICAL COPYRIGHT PROTECTION SOCIETY LIMITED OR THE PERFORMING RIGHTS SOCIETY LIMITED.

What appears to be a malfunction may not always be serious. If your unit should not perform as expected, consult the table below to see if the problem can be corrected before seeking help from your dealer or service representative.

Operation to reset

The microcomputer may fall into malfunction (impossibility to operate, erroneous display, etc.) when the power cord is unplugged while power is ON or due to an external factor. In this case, execute the following procedure to reset the microcomputer and return it to normal condition.

- Please note that resetting the microcomputer clears the contents stored in it returns it to condition when it left the factory.

R-SG7

Pull the power plug from the receptacle, and then plug it in again while keeping the "on/standby" key pressed.

DP-SG7

Pull the power plug from the receptacle, and then plug it in again.



X-SG7

Pull the power plug from the receptacle, and then plug it in again while keeping the "stop (■)" key pressed.













Receiver unit, speakers

Symptom	Cause	Remedy
Sound is not produced.	<ul style="list-style-type: none"> ● The speaker cords are disconnected. ● The volume control is set to the minimum position. ● The MUTE switch of remote control unit is switched ON. ● The headphone plug is inserted into the jack. 	<ul style="list-style-type: none"> ● Connect properly referring to "System connection". → 12 ● Adjust to an required volume. → 18 ● Switch MUTE OFF. → 19 ● Unplug the headphone plug. → 19
All digits of the display section show flashing indication of "--" and no sound is put out.	<ul style="list-style-type: none"> ● The speaker cords are short-circuited. 	<ul style="list-style-type: none"> ● Turn the power OFF, remove the short-circuit and turn the power ON again. → 12
Sound is not produced from the left or right speakers.	<ul style="list-style-type: none"> ● The speaker cords are disconnected. 	<ul style="list-style-type: none"> ● Connect properly referring to "System connection". → 12
The clock display blinks without changing the figures.	<ul style="list-style-type: none"> ● There was a power failure. ● The power cord was unplugged from the outlet. 	<ul style="list-style-type: none"> ● Adjust the present time again. → 44 ● Adjust the present time again. → 44
Timer operation is not possible.	<ul style="list-style-type: none"> ● The present time has not been adjusted or there was a power failure. ● The timer ON time and OFF time have not been set. ● The timer execution was not set up. 	<ul style="list-style-type: none"> ● Adjust the present time referring to "Clock adjustment". → 44 ● Set the timer ON time and OFF time. → 46 ● Press the "Tuning (Δ)" key to set up the execution. → 48
Radio stations cannot be received.	<ul style="list-style-type: none"> ● The antennas have not been connected. ● A proper broadcasting band has not been selected. ● The frequency of the station to be received is not tuned. 	<ul style="list-style-type: none"> ● Connect antennas. → 9 ● Select a band. → 26 ● Tune to the frequency of the desired station. → 26
Noise interferes.	<ul style="list-style-type: none"> ● Car ignition noise. ● Influence of an electric appliance. ● A TV set is installed near the system. 	<ul style="list-style-type: none"> ● Install the outdoor antenna in an apart position from the road. → 9 ● Switch the suspected electric appliance OFF. ● Install the TV or the system at an increased distance between them.



Receiver unit, speakers

Symptom	Cause	Remedy
After presetting, reception is not possible with preset call.	<ul style="list-style-type: none"> The frequency of the preset station is not tunable. The preset memory has been cleared because the power cord has been unplugged for a long period. 	<ul style="list-style-type: none"> Preset stations with tunable frequencies. →  27 Preset stations again. →  27









Cassette deck unit

Symptom	Cause	Remedy
Sound cannot be produced by pressing the play key or no operation occurs even when an operation key is pressed.	<ul style="list-style-type: none"> The head is dirty. The tape is wound too tight due to irregular winding. A nonrecorded tape is played. 	<ul style="list-style-type: none"> Clean the head referring to "Maintenance". →  50 Try another tape. Play a recorded tape.
No operation occurs even when an operation key is pressed.	<ul style="list-style-type: none"> The operation key is pressed in less than 4 seconds after turning the power ON. A tape is not inserted in the unit. The tape is wound too tight due to irregular winding. The tape is fully wound to one of the reels. 	<ul style="list-style-type: none"> Press operation keys after waiting for more than 4 seconds. →  22 Insert a tape. →  22 Try another tape. Change the tape transport direction or reverse the tape insertion orientation. →  23
The DPSS malfunctions.	<ul style="list-style-type: none"> The tape used is not suitable for DPSS, for example the spaces between tunes may be too short. 	<ul style="list-style-type: none"> Refer to "DPSS". →  24
The tray does not open when the Open/Close key is pressed.	<ul style="list-style-type: none"> The key is pressed during recording. The microcomputer is malfunctioning due to external noise. 	<ul style="list-style-type: none"> Press in stop mode. →  23 Unplug the power cord and plug it again. →  52
Sound is harsh or high frequencies are not reproduced.	<ul style="list-style-type: none"> The head is dirty. The tape is stretched or shrunk. 	<ul style="list-style-type: none"> Clean the head referring to "Maintenance". →  50 Try another tape.
Sound is distorted.	<ul style="list-style-type: none"> The recording level has not been set with the CRLS key. The tape being played was recorded with distorted sound. 	<ul style="list-style-type: none"> Refer to "Recording". →  28 Try another tape.
Noise is noticeable.	<ul style="list-style-type: none"> The tape head is magnetized. External noise is induced. A tape recorded with Dolby NR ON is played with Dolby NR OFF. 	<ul style="list-style-type: none"> Demagnetize the head referring to "Maintenance". →  50 Install the system at a distance from other electric appliances and TV. Set the Dolby NR to on. →  23
Sound fluctuates.	<ul style="list-style-type: none"> The capstans or pinch rollers are dirty. The tape is wound irregularly. 	<ul style="list-style-type: none"> Clean the head referring to "Maintenance". →  50 Wind the tape again by fast forwarding, rewinding or playing from an end to the other. →  23



Cassette deck unit

Symptom	Cause	Remedy
Recording cannot be started by pressing the record key.	<ul style="list-style-type: none"> ● The recording protect tab of the cassette has been broken. ● The TAPE input is selected. ● The tape is fully wound to one of the reels. 	<ul style="list-style-type: none"> ● Use a cassette with an unbroken recording protect tab or block the hole. →  49 ● Select the source to be recorded with the input selector key. →  29 ● Change the tape transport direction or reverse the tape insertion orientation. →  28

CD player unit

Symptom	Cause	Remedy
A CD is placed in the player but it cannot be played.	<ul style="list-style-type: none"> ● The disc is placed upside down. ● The disc position is displaced. ● The disc is extremely dirty. ● The disc is scratched. ● Dew is condensed on the optics lens. 	<ul style="list-style-type: none"> ● Place the disc properly, with the label side facing upward. →  20 ● Place the disc properly. →  20 ● Clean the disc referring to "Disc handling precautions". →  49 ● Try another disc. ● Refer to "Beware of condensation" and remove the condensation by evaporation. →  51
Sound is not produced.	<ul style="list-style-type: none"> ● The disc has not been placed. ● The player is not put to the play mode. ● The disc is extremely dirty. ● The disc is scratched. 	<ul style="list-style-type: none"> ● Place a disc in the CD player. →  20 ● Press the ►/ key. →  20 ● Clean the disc referring to "Disc handling precautions". →  49 ● Try another disc.
Sound skips.	<ul style="list-style-type: none"> ● The disc is dirty. ● The disc is scratched. ● The player is subject to vibration. 	<ul style="list-style-type: none"> ● Clean the disc referring to "Disc handling precautions". →  49 ● Try another disc. ● Install the unit in a place not subject to vibrations.

Remote control unit

Symptom	Cause	Remedy
Remote control operation is not possible.	<ul style="list-style-type: none"> ● Batteries are exhausted. ● The remote control is too far away from the system, the controlling angle is deviated or there is an obstacle in between. ● There is no tape or CD set in the component to be played. ● An attempt is made to play the cassette deck which is recording something. 	<ul style="list-style-type: none"> ● Replace with new batteries. →  17 ● Operate the unit inside the remote controllable range. →  17 ● Set a tape or CD in the component to be played. ● Wait until the recording ends.



1. With some tapes, a squeaky noise is produced when the tape is stopped automatically. This is due to the tape protection function, and not a malfunction.
2. Do not use longer than 100 minutes tapes, for the tape is too thin and gets easily tangled.

Receiver (R-SG7)

[Amplifier section]

Rated power output
Class AB operation

20 watts per channel minimum RMS, both channels driven, at 6 Ω, 1 kHz with no more than 10 % total harmonic distortion.

(DIN) 1 kHz at 6 Ω, 0.7 % T.H.D. 15 W + 15 W
Class A operation

7.5 watts per channel minimum RMS, both channels driven, at 6 Ω, 1 kHz with no more than 10 % total harmonic distortion.

Total harmonic distortion 0.02% (1 kHz, 10 W, 6 Ω)
Frequency response 20 Hz ~ 40 kHz, +0 dB, -3 dB
Input sensitivity / Impedance
..... 200 mV / 47 kΩ
Output level / Impedance
SUPER WOOFER PRE OUT 2.0 V / 1 kΩ
TAPE REC 200 mV / 1 kΩ
Signal to noise ratio
..... 96 dB (IHF'66)

[FM Tuner section]

Tuning frequency range 87.5 MHz ~ 108 MHz
Usable sensitivity (DIN)
MONO
.. 1.2 μV (75 Ω) / 13.2 dBf (40 kHz DEV., S/N 26 dB)
Signal to noise ratio
(DIN weighted at 1 kHz, 65.2 dBf input)
MONO 65 dB
STEREO 58 dB
Selectivity (DIN ±300 kHz) 64 dB
Stereo separation (DIN at 1 kHz) 35 dB

[AM Tuner section]

Tuning frequency range 531 kHz ~ 1,602 kHz
Usable sensitivity (30% mod., S/N 20 dB)
..... 15 μV / (500 μV/m)
Signal to noise ratio (at 30% mod., 1 mV input)
..... 48 dB
Output level / Impedance (30% mod., 1 mV input)
..... 0.18 V / 1 kΩ

General

Power consumption 45 W
Dimensions W: 200 mm
H: 77 mm
D: 278 mm
Weight (net) 3.0 kg

CD player (DP-SG7)

Laser Semiconductor laser
Playing rotation 200 rpm ~ 500 rpm (CLV)
Frequency response 4 Hz ~ 20 kHz, ±1.0 dB
Signal to noise ratio More than 100 dB
Dynamic range More than 96 dB
Total harmonic distortion
..... Less than 0.004 % (at 1 kHz)
Channel separation More than 92 dB (at 1 kHz)
Wow & Flutter Unmeasurable Limit
Output level / Impedance
Fixed 1.2 V / 1 kΩ
Digital output
Optical -15 dBm ~ -21 dBm
(wave length 660 nm)

General

Power consumption 10 W
Dimensions W: 200 mm
H: 77 mm
D: 249 mm
Weight (net) 2.0 kg

Cassette deck (X-SG7)

Track 4-track, 2-channel stereo
Recording system AC bias system
(Frequency: 105 kHz)
Heads
Playback / recording head 1
Erasing head 1
Motors 1
Wow and flutter 0.1 % (W.R.M.S.)
Fast winding time Approx. 110 seconds
(C-60 tape)

Frequency response

TYPE I tape 40 Hz to 18,000 Hz, ±3 dB
TYPE IV tape 40 Hz to 19,000 Hz, ±3 dB
Signal to noise ratio
Dolby B NR ON 67 dB (CrO₂ tape)
Dolby C NR ON 73 dB (CrO₂ tape)
Dolby NR OFF 60 dB (CrO₂ tape)
Input sensitivity / Impedance 77.5 mV / 47 kΩ
Output level / Impedance 775 mV / 10 kΩ

General

Power consumption 14 W
Dimensions W: 200 mm
H: 77 mm
D: 249 mm
Weight (net) 2.2 kg



- 1.KENWOOD follows a policy of continuous advancements in development. For this reason specifications may be changed without notice.
- 2.Sufficient performance may not be possible at very low temperatures (under a water-freezing temperature).

KENWOOD

For your records

Record the serial number, found on the back of the unit, in the spaces designated on the warranty card, and in the space provided below. Refer to the model and serial numbers whenever you call upon your dealer for information or service on this product.

Model _____ Serial Number _____

Free Manuals Download Website

<http://myh66.com>

<http://usermanuals.us>

<http://www.somanuals.com>

<http://www.4manuals.cc>

<http://www.manual-lib.com>

<http://www.404manual.com>

<http://www.luxmanual.com>

<http://aubethermostatmanual.com>

Golf course search by state

<http://golfingnear.com>

Email search by domain

<http://emailbydomain.com>

Auto manuals search

<http://auto.somanuals.com>

TV manuals search

<http://tv.somanuals.com>