

## Troubleshooting Guide

What might appear to be a malfunction in your unit may just be the result of slight misoperation or miswiring. Before calling service, first check the following table for possible problems.

PROBLEM	POSSIBLE CAUSE	SOLUTION
<b>No sound.</b> (No sound from one side.)	<ul style="list-style-type: none"> <li>Input (or output) cables are disconnected.</li> <li>Protection circuit may be activated.</li> <li>Volume is too high.</li> </ul>	<ul style="list-style-type: none"> <li>Connect the input (or output) cables.</li> <li>Check connections by referring to "Power indicator".</li> <li>Replace the fuse and use lower volume.</li> </ul>
<b>(Blown fuse.)</b>	<ul style="list-style-type: none"> <li>The speaker cord is shorted.</li> </ul>	<ul style="list-style-type: none"> <li>After check the speaker cord and fixing the cause of the short, replace the fuse.</li> </ul>
<b>The output level is too small (or too large).</b>	The input sensitivity adjusting control is not set to the correct position.	Adjust the control correctly referring to "Controls".
<b>The sound quality is bad.</b> (The sound is distorted.)	<ul style="list-style-type: none"> <li>The speakers wire are connected with wrong <math>\oplus / \ominus</math> polarity.</li> <li>A speaker wire is pinched by a screw in the car body.</li> <li>The switches may be set improperly.</li> </ul>	<ul style="list-style-type: none"> <li>Connect them properly checking the <math>\oplus / \ominus</math> of the terminals and wires well.</li> <li>Connect the speaker wire again so that it is not pinched by anything.</li> <li>Set switches properly by referring to "System examples".</li> </ul>

## Specifications

Specifications subject to change without notice.

Audio Section .....KAC-829/729S .....KAC-629S .....KAC-529S

Max Power Output (4 $\Omega$ )			
Normal	200 W $\times$ 2	120 W $\times$ 2	80 W $\times$ 2
Bridge	600 W $\times$ 1	350 W $\times$ 1	250 W $\times$ 1
Rated Power Output (4 $\Omega$ )			
Normal (20 Hz ~ 20 kHz, 0.08 % THD)	100 W $\times$ 2	60 W $\times$ 2	40 W $\times$ 2
Normal (DIN45324, +B=14.4 V)	100 W $\times$ 2	60 W $\times$ 2	40 W $\times$ 2
Bridge (1 kHz, 0.8 % THD)	300 W $\times$ 1	150 W $\times$ 1	120 W $\times$ 1
Rated Power Output (2 $\Omega$ )			
Normal (1 kHz, 0.8 % THD)	150 W $\times$ 2	75 W $\times$ 2	60 W $\times$ 2
Frequency Response (+0, -1 dB)	5 Hz ~ 50 kHz	10 Hz ~ 45 kHz	5 Hz ~ 50 kHz
Signal to Noise Ratio	100 dB	100 dB	100 dB
Sensitivity (MAX) (rated output)	0.2 V	0.2 V	0.2 V
(MIN) (rated output)	5.0 V	5.0 V	5.0 V
Input Impedance	10 k $\Omega$	10 k $\Omega$	10 k $\Omega$
Low Pass Filter (12 dB/oct.)	80 Hz	80 Hz	80 Hz
High Pass Filter (12 dB/oct.) (KAC-629S only)		150 Hz	

General .....KAC-829/729S .....KAC-629S .....KAC-529S

Operating Voltage (11 ~ 16 V allowable)	14.4 V	14.4 V	14.4 V
Current Consumption (1 kHz, 10% THD)	28 A	19 A	16 A
Dimensions (W $\times$ H $\times$ D)(mm)	221 $\times$ 57 $\times$ 300	221 $\times$ 57 $\times$ 228	221 $\times$ 57 $\times$ 160
[inch]	8-11/16 $\times$ 2-1/4 $\times$ 11-13/16	8-11/16 $\times$ 2-1/4 $\times$ 9	8-11/16 $\times$ 2-1/4 $\times$ 5/16
Weight	3.7 kg (8.1 lbs)	2.8 kg (6.1 lbs)	2.0 kg (4.4 lbs)
	(KAC-829)		
	3.8 kg (8.3 lbs) (KAC-729S)		

## Safety precautions

### ▲WARNING

To prevent injury or fire, take the following precautions:

- When extending the ignition, battery, or ground wires, make sure to use automotive-grade wires or other wires with a 5mm<sup>2</sup> (AWG10) or more to prevent wire deterioration and damage to the wire coating.
- To prevent a short circuit, never put or leave any metallic objects (such as coins or metal tools) inside the unit.
- If the unit starts to emit smoke or strange smells, turn off the power immediately and consult your Kenwood dealer.
- Do not touch the unit during use because the surface of the unit becomes hot and may cause burns if touched.

### ▲CAUTION

To prevent damage to the machine, take the following precautions:

- Be sure the unit is connected to a 12V DC power supply with a negative ground connection.
- Do not open the top or bottom covers of the unit.
- Do not install the unit in a spot exposed to direct sunlight or excessive heat or humidity. Also avoid places with too much dust or the possibility of water splashing.
- When replacing a fuse, only use a new one with the prescribed rating. Using a fuse with the wrong rating may cause your unit to malfunction.
- To prevent a short circuit when replacing a fuse, first disconnect the wiring harness.

### NOTE

- If you experience problems during installation, consult your Kenwood dealer.
- If the unit does not seem to be working right, consult your Kenwood dealer.

### FCC WARNING

This equipment may generate or use radio frequency energy. Changes or modifications to this equipment may cause harmful interference unless the modifications are expressly approved in the instruction manual. The user could lose the authority to operate this equipment if an unauthorized change or modification is made.

### ■ Cleaning the unit

If the front panel gets dirty, turn off the power and wipe the panel with a dry silicon cloth or soft cloth.

### ▲CAUTION

Do not wipe the panel with a hard cloth or a cloth dampened by volatile solvents such as paint thinner and alcohol. They can scratch the surface of the panel and/or cause the indicator letters to peel off.

### ■ Wiring

- If a buzzing noise is heard from the speakers when the engine is running, connect a line noise filter (optional) to each of the battery wire.
- Do not allow the wire to directly contact the edge of the iron plate by using Grommets.
- Connect the ground wire to a metal part of the car chassis that acts as an electrical ground passing electricity to the battery's negative  $\ominus$  terminal. Do not turn the power on if the ground wire is not connected.
- Be sure to attach a protective fuse into the battery wire close to the battery. Use a protective fuse having a capacity that is about 10 A higher than the maximum current drawn by the amplifier.
- Use vehicle-type (fire-resistant) power supply wiring wire for the battery wire and the ground wire. The current capacity of the power supply wiring wire should be about 10 A higher than that of the protective fuse capacity (which means about 20 A higher than the maximum current drawn by the amplifier).
- When more than one power amplifier are going to be used, use a power supply wiring wire and protective fuse of greater current-handling capacity than the total maximum current drawn by each amplifier.

Example: One Power Amplifier Is Used (KAC-829/729S)

Maximum Current Drawn	28 A
Protective Fuse	50 A $\times$ 1 [25 A $\times$ 2]
Cross-sectional Area of Wiring Wire (AWG)	5 mm <sup>2</sup> (AWG 10) or greater $\times$ 1

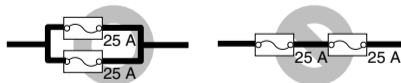

### ■ Speaker Selection

- The rated input power of the speakers that are going to be connected should be greater than the maximum output power (in Watts) of the amplifier. Use of speakers having input power ratings that are less than the output power of the amplifier will cause smoke to be emitted as well as damage.
- The impedance of the speakers that are going to be connected should be 2 $\Omega$  or greater (for stereo connections), or 4 $\Omega$  or greater (for bridged connections). When more than one set of speakers are going to be used, calculate the combined impedance of the speakers and then connect suitable speakers to the amplifier.

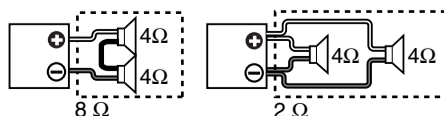

# KENWOOD

## KAC-829 KAC-729S KAC-629S KAC-529S

POWER AMPLIFIER

## INSTRUCTION MANUAL

KENWOOD CORPORATION



Take the time to read through this instruction manual. Familiarity with installation and operation procedures will help you obtain the best performance from your new power amplifier.

### For your records

Record the serial number, found on the back of the unit, in the spaces designated on the warranty card, and in the space provided below.

Refer to the model and serial numbers whenever you call upon your KENWOOD dealer for information or service on the product.

Model KAC-829/729S/629S/529S Serial number \_\_\_\_\_

© PRINTED IN USA B64-1949-10 (KM/EM)

## Installation procedure

- Remove the ignition key and disconnect the negative  $\ominus$  terminal of the battery to prevent short circuits.
- Set the unit according to the intended usage.
- Connect the input and output cables of the units.
- Connect the speaker wires.
- Connect the power wire, power control wire and grounding wire following this order.
- Install the unit in the car.
- Connect the negative  $\ominus$  terminal of the battery.

### ▲WARNING

To prevent fire caused by a short in the wiring, connect a fusible link or breaker nearby the battery's positive terminal.

### ▲CAUTION

- Be sure to turn the power off before changing the setting of any switch.
- If the fuse blows, check wires for shorts, then replace the fuse with one of the same rating.
- Check that no unconnected cables or connectors are touching the car body. Do not remove caps from unconnected cables or connectors to prevent short circuits.
- Connect the speaker wires to appropriate speaker connectors separately. Sharing the negative wire of the speaker or grounding speaker wires to the metal body of the car can cause this unit to fail.
- After installation, check that the brake lamps, wipers, and wipers work properly.

### ■ Speaker level input terminals (1)

- The genuine-accessory car stereo shall have a maximum power output of no more than 40 W.
- Do not connect the speaker output leads from a power amplifier (Optional) to the speaker level input terminals of this unit, for this may cause malfunction or damage.
- Do not connect cables and leads to both RCA cable input jacks and the speaker level input terminals simultaneously, for this may cause malfunction or damage.
- Connect the power control lead to a power supply which can be turned ON/OFF by the ignition key switch (ACC line). With this connection, shock noise may be generated when the power of the genuine-accessory car stereo is switched ON/OFF.

### ■ Power terminal (2)(3)(4)

Connect to their respective terminals the power supply wire, and ground wire, all of which pass through the associated terminal cover. Once the connections are complete, place the cover on the terminal section.

### ■ Accessories

Part name	External View	Number of Items
Terminal cover (Power terminal)		1
Self-tapping screws ( $\phi 4 \times 16$ mm)		4

## Installation

Since the power amplifier has no parts which require operation, it can be installed at a position away from the driver's seat without any hindrances.

As generally accepted positions for its installation, places such as inside the trunk, etc. can be considered.

### ▲CAUTION

- Do not install the unit under the carpet. Otherwise heat build-up occurs and the unit may be damaged.
- Install this unit in a location which allows heat to easily dissipate. Once installed, do not place any object on top of the unit.
- The surface temperature of the amplifier will become hot during use. Install the amplifier in a place where people, resins, and other substances that are sensitive to heat will not come into contact with it.
- When making a hole under a seat, inside the trunk, or somewhere else in the vehicle, check that there is nothing hazardous on the opposite side such as a gasoline tank, brake pipe, or wiring harness, and be careful not to cause scratches or other damage.
- Do not install near the dashboard, rear tray, or air bag safety parts.
- The installation to the vehicle should securely fasten the unit to a place in which it will not obstruct driving. If the unit comes off due to a shock and hits a person or safety part, it may cause injury or an accident.
- After installing the unit, check to make sure that electrical equipment such as the brake lamps, turn signal lamps and windshield wipers operate normally.

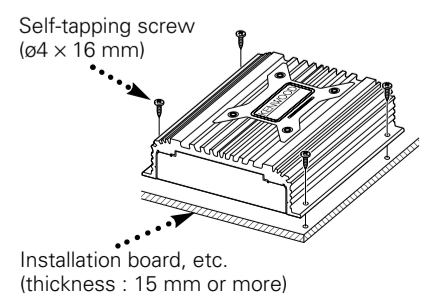

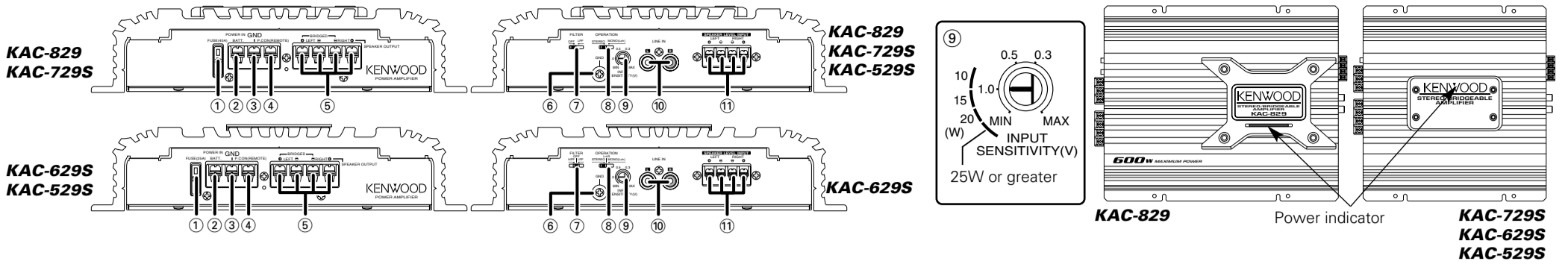

Operations of the following control and switches are required in accordance with the center unit and speakers connected with this unit.

- ① **Fuse**  
40 A x 1 : KAC-829/729S  
25 A x 1 : KAC-629S  
15 A x 1 : KAC-529S  
**NOTE**  
If you can't find the specified capacity fuse at your store etc., consult your Kenwood dealer.
- ② **Battery terminal**
- ③ **Ground terminal**
- ④ **Power control (REMOTE) terminal**
- ⑤ **SPEAKER OUTPUT terminals**
  - **Stereo Connections:**  
When you wish to use the unit as a stereo amplifier, stereo connections are used.
  - **Bridged Connections:**  
When you wish to use the unit as a high-output monaural amplifier, bridged connections are used. (Make connections to the LEFT channel (+) and the RIGHT channel (-) SPEAKER OUTPUT terminals.)

- ⑥ **RCA cable ground lead terminal**  
When using an RCA cable with a ground lead attached, connect the ground lead to this terminal.  
**CAUTION**  
Do not use this terminal for power source grounding. This unit will be damaged if the power source grounding wire is connected to this terminal.
- ⑦ **FILTER switch**  
These switches allow filtering of the speaker output signals.
  - **HPF (High Pass Filter) position (KAC-629S only)**  
Only frequencies of 150 Hz or higher are output. (Frequencies below 150 Hz are cut.)
  - **LPF (Low Pass Filter) position**  
Only frequencies of 80 Hz or lower are output. (Frequencies above 80 Hz are cut.)  
The Lch and Rch will be mixed before output even if the operation switch is set to STEREO.
  - **OFF position**  
The original sound without filtering is output.
- ⑧ **OPERATION switch**  
This switch allows selection of the amplification method of input signals.

- **STEREO position**  
The amplifier can be used as a stereo amplifier.
- **L+R position (KAC-629S only)**  
The input left and right signals are combined before being amplified. Use this position when the unit is used for subwoofer speakers or the L+R (monaural) sound is required.
- **MONO (Lch) position**  
Amplifies the signal input from the left side only. Set to this position and make bridged connections to use as a high-power monaural amplifier. (The input right signal is not output.)
- ⑨ **INPUT SENSITIVITY control**  
Set this control according to the pre-output level of the center unit connected with this unit, or to the maximum power output of the genuine-accessory car stereo. Use the diagram on the right as a guide.  
**NOTE**  
For the pre-output level or the maximum power output, refer to the "Specifications" in the instruction manual of the center unit.
- ⑩ **LINE IN terminal**
- ⑪ **Speaker level input terminals**

**Power indicator**

When the power is turned on, the Power indicator lights. If the Power indicator does not light when the power is turned on, the protection function may be activated. Check whether there is any indication of trouble.

- **The protection function is activated in the following situations:**  
This unit is equipped with a protection function for protecting this unit and your speakers from various accidents or problems that can occur. When the protection function is triggered, the Power indicator goes off and the amplifier stops operating.
  - When a speaker wire may be short-circuited.
  - When a speaker output contacts ground.
  - When the unit malfunctions and a DC signal is sent to the speaker output.
  - When the internal temperature is high and unit won't operate.
  - When a ground wire of the center unit (cassette receiver, CD receiver, etc.) or this unit is not connected to a metal part serving as an electrical ground passing electricity to the battery's negative (-) terminal.

**System examples**

■ **2-channel system**

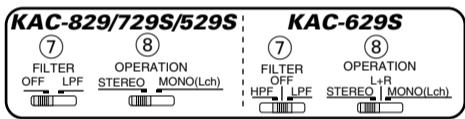

■ **Subwoofer system**

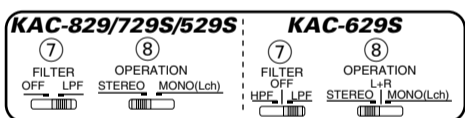
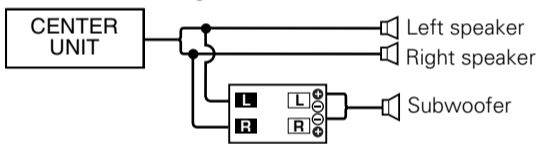

■ **1-channel system**

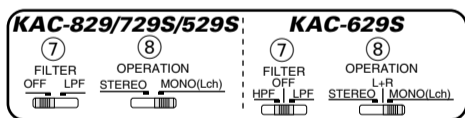
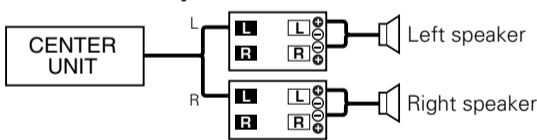

■ **Tri-mode**

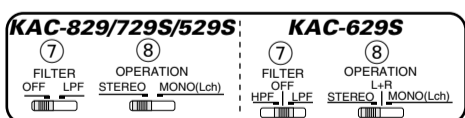
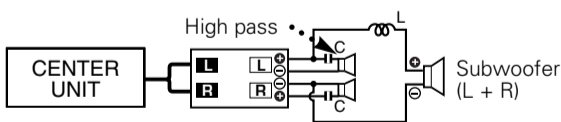

**Principle of Tri-mode**

Method of frequency band division using a coil and capacitor ... in case of 6dB/oct. slope  
Coil (L): Passes low frequencies and blocks high frequencies. (Low pass)  
Capacitor (C): Passes high frequencies and blocks low frequencies. (High pass)

**Example:**

When it is required to set a crossover frequency of 120 Hz using speakers with an impedance of 4 ohms.  
fc=Cut of Frequency (Hz)  
R=Speaker Impedance (Ω)

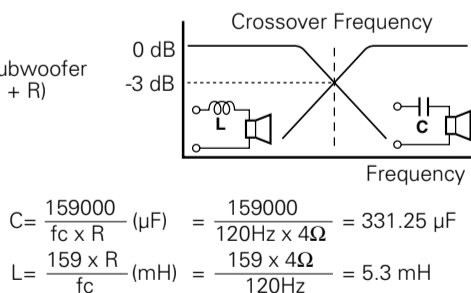

**CAUTION**

- If you wish to bridge-connect a speaker, the speaker impedance must be no less than 4 ohms. Connecting a speaker with an impedance lower than 4 ohms may damage the unit.
- Be sure to connect capacitors to speakers to which high frequencies will be passed. Failure to do so will result in a drop of the combined impedance with the subwoofer.
- Ensure that the withstand voltage and current ratings of the capacitors (C) and coils (L) are sufficient.

**Connection**

**NOTE** For safe installation, read "Installation procedure" before starting work.

■ **RCA cable connection**

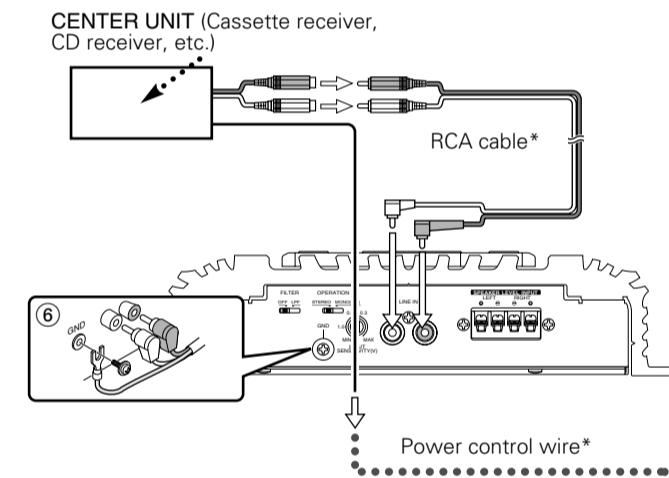

■ **Speaker level input connection**

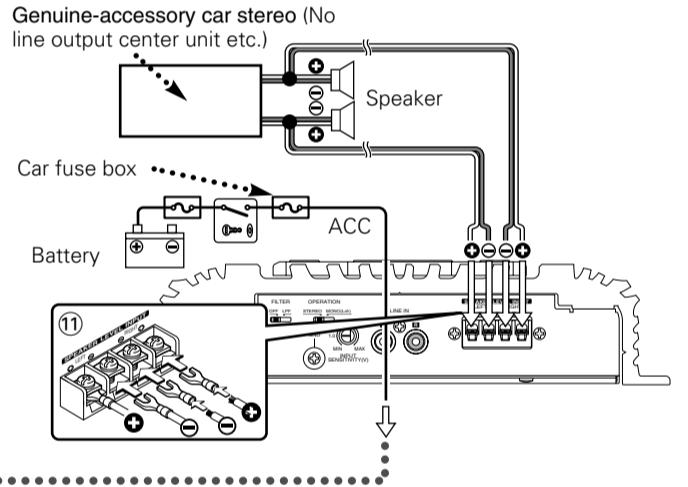

■ **Speaker stereo connection**

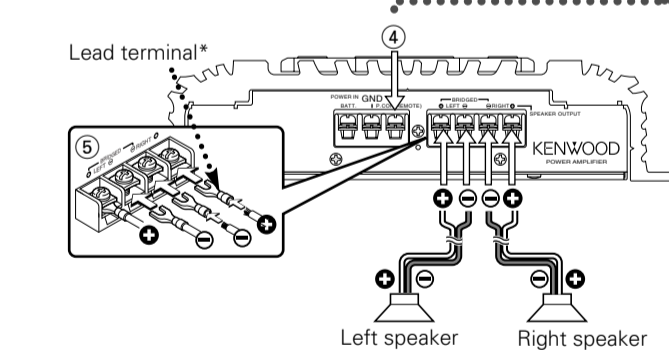

■ **Speaker bridge connection**

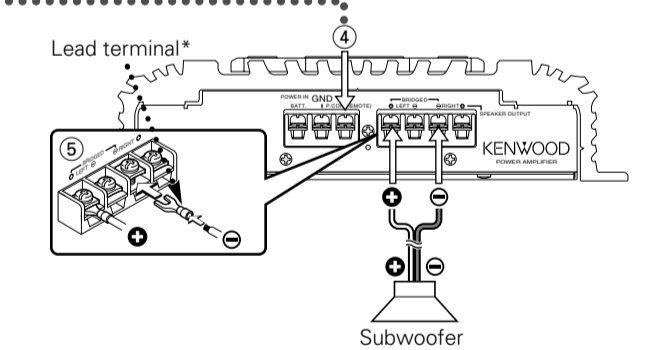

■ **Power wire connection**

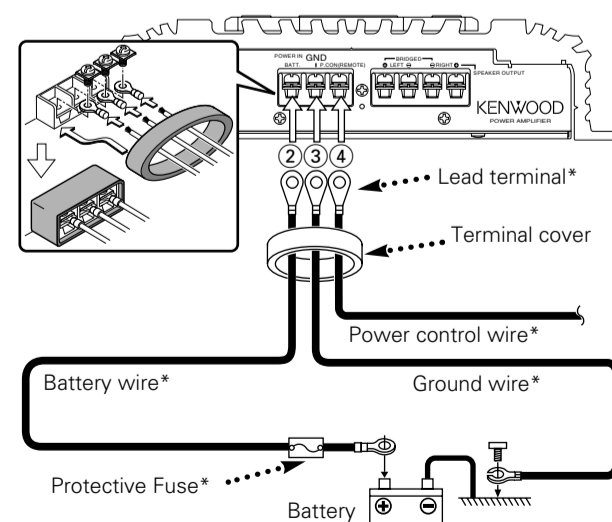

## Free Manuals Download Website

<http://myh66.com>

<http://usermanuals.us>

<http://www.somanuals.com>

<http://www.4manuals.cc>

<http://www.manual-lib.com>

<http://www.404manual.com>

<http://www.luxmanual.com>

<http://aubethermostatmanual.com>

Golf course search by state

<http://golfingnear.com>

Email search by domain

<http://emailbydomain.com>

Auto manuals search

<http://auto.somanuals.com>

TV manuals search

<http://tv.somanuals.com>