

KENWOOD

CD-RECEIVER

KDC-2031SA/G

INSTRUCTION MANUAL

KENWOOD CORPORATION



© B64-2937-00/00 (EW/E2W)



Contents

| | | | |
|---------------------------------|-----------|--|-----------|
| Safety precautions | 3 | Accessories/ Installation Procedure | 14 |
| Notes | 4 | Connecting Wires to Terminals | 15 |
| About CDs | 5 | Installation | 17 |
| General features | 6 | Removing the Unit | 18 |
| Power | | Troubleshooting Guide | 19 |
| Selecting the Source | | Specifications | 21 |
| Volume | | | |
| Attenuator | | | |
| System Q | | | |
| Audio Control | | | |
| Audio Setup | | | |
| Speaker Setting | | | |
| Clock Display | | | |
| Adjusting Clock | | | |
| Dimmer Control | | | |
| DSI (Disabled System Indicator) | | | |
| Theft Deterrent Faceplate | | | |
| TEL Mute | | | |
| Tuner features | 10 | | |
| Tuning | | | |
| Tuning Mode | | | |
| Monaural Reception | | | |
| Station Preset Memory | | | |
| Auto Memory Entry | | | |
| Preset Tuning | | | |
| CD player features | 12 | | |
| Playing CD | | | |
| Fast Forwarding and Reversing | | | |
| Track Search | | | |
| Track Repeat | | | |
| Scan Play | | | |
| Random Play | | | |

Safety precautions

▲WARNING

To prevent injury or fire, take the following precautions:

- To prevent a short circuit, never put or leave any metallic objects (such as coins or metal tools) inside the unit.

▲CAUTION

To prevent damage to the machine, take the following precautions:

- Make sure to ground the unit to a negative 12V DC power supply.
- Do not install the unit in a spot exposed to direct sunlight or excessive heat or humidity. Also avoid places with too much dust or the possibility of water splashing.
- Do not set the removed faceplate or the faceplate case in areas exposed to direct sunlight, excessive heat or humidity. Also avoid places with too much dust or the possibility of water splashing.
- To prevent deterioration, do not touch the terminals of the unit or faceplate with your fingers.
- Do not subject the faceplate to excessive shock, as it is a piece of precision equipment.
- When replacing a fuse, only use a new one with the prescribed rating. Using a fuse with the wrong rating may cause your unit to malfunction.
- Do not use your own screws. Use only the screws provided. If you use the wrong screws, you could damage the unit.

Do Not Load 8 cm (3 in.) CDs in the CD slot

If you try to load a 8 cm (3 in.) CD with its adapter into the unit, the adapter might separate from the CD and damage the unit.

Lens Fogging

Right after you turn on the car heater in cold weather, dew or condensation may form on the lens in the CD player of the unit. Called lens fogging, CDs may be impossible to play. In such a situation, remove the disc and wait for the condensation to evaporate. If the unit still does not operate normally after a while, consult your Kenwood dealer.

Notes

- If you experience problems during installation, consult your Kenwood dealer.
- If the unit fails to operate properly, press the Reset button. The unit returns to factory settings when the Reset button is pressed.

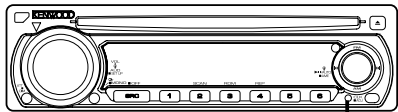

Reset button

- The illustrations of the display and the panel appearing in this manual are examples used to explain more clearly how the controls are used. Therefore, what appears on the display in the illustrations may differ from what appears on the display on the actual equipment, and some of the illustrations on the display may represent something impossible in actual operation.

Cleaning the Unit

If the faceplate of this unit is stained, wipe it with a dry soft cloth such as a silicon cloth.

If the faceplate is stained badly, wipe the stain off with a cloth moistened with neutral cleaner, then wipe neutral detergent off.



- Applying spray cleaner directly to the unit may affect its mechanical parts. Wiping the faceplate with a hard cloth or using a volatile liquid such as thinner or alcohol may scratch the surface or erase characters.

Cleaning the Faceplate Terminals

If the terminals on the unit or faceplate get dirty, wipe them with a dry, soft cloth.

This Product is not installed by the manufacturer of a vehicle on the production line, nor by the professional importer of a vehicle into an EU Member State.

The marking of products using lasers (Except for some areas)

**CLASS 1
LASER PRODUCT**

The label is attached to the chassis/case and says that the component uses laser beams that have been classified as Class 1. It means that the unit is utilizing laser beams that are of a weaker class. There is no danger of hazardous radiation outside the unit.

About CDs

Handling CDs

- Don't touch the recording surface of the CD.



- CD-R and CD-RW are easier to damage than a normal music CD. Use a CD-R or a CD-RW after reading the caution items on the package etc.
- Don't stick tape etc. on the CD. Also, don't use a CD with tape stuck on it.

When using a new CD

If the CD center hole or outside rim has burrs, use it after removing them with a ball pen etc.

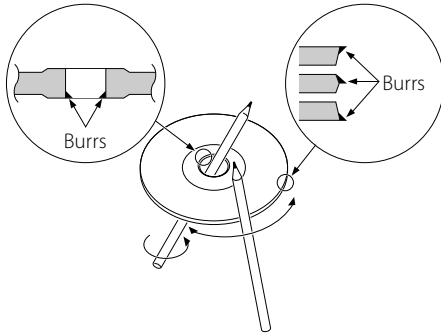

CD accessories

Don't use disc type accessories.

CD cleaning

Clean from the center of the disc and move outward.

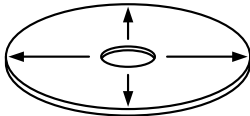

Removing CDs

When removing CDs from this unit pull them out horizontally.

CDs that can't be used

- CDs that aren't round can't be used.

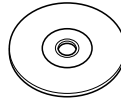

- CDs with coloring on the recording surface or that are dirty can't be used.
- This unit can only play the CDs with



It may not correctly play discs which do not have the mark.

- A CD-R or CD-RW that hasn't been finalized can't be played. (For the finalization process refer to your CD-R/CD-RW writing software, and your CD-R/CD-RW recorder instruction manual.)

CD storage

- Don't place them in direct sunlight (On the seat or dashboard etc.) and where the temperature is high.
- Store CDs in their cases.

General features

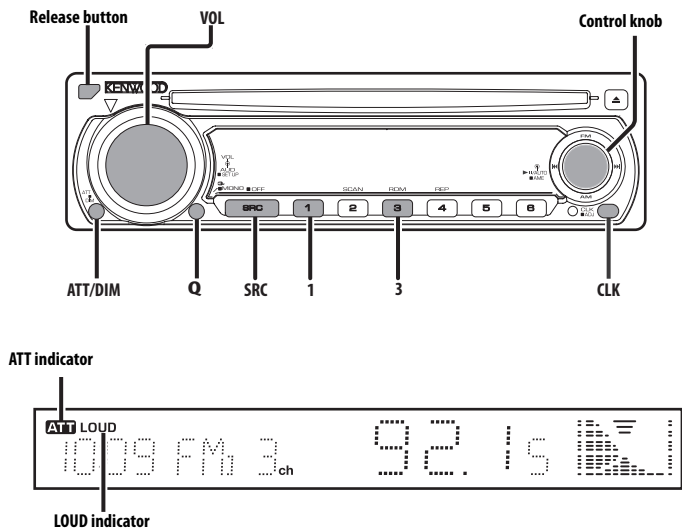

Power

Turning ON the Power

Press the [SRC] button.

Turning OFF the Power

Press the [SRC] button for at least 1 second.

Selecting the Source

Press the [SRC] button.

| Source required | Display |
|----------------------------------|---------|
| Tuner | "TUnE" |
| CD | "CD" |
| Standby (Illumination only mode) | "STBY" |

Volume

Increasing Volume

Turn the [VOL] knob clockwise.

Decreasing Volume

Turn the [VOL] knob counterclockwise.

Attenuator

Turning the volume down quickly.

Press the [ATT] button.

Each time the button is pressed, the Attenuator turns ON and OFF.

When it's ON, the "ATT" indicator blinks.

System Q

You can recall the best sound setting preset for different types of music.

1 Select the source to set

Press the [SRC] button.

2 Select the Sound type

Press the [Q] button.

Each time the button is pressed, the sound setting switches.

| Sound setting | Display |
|---------------|---------|
| Natural | "FLAT" |
| Rock | "ROCK" |
| Pops | "POPS" |
| Easy | "EASY" |
| Top 40 | "TP40" |
| Jazz | "JAZZ" |



- "USER": The values set on the <Audio Control> (page 7). When the System Q setting is changed, the Bass, Middle, and Treble set in audio control replace the System Q values.
- Each setting value is changed with the <Speaker Setting> (page 8).
First, select the speaker type with the Speaker setting.

Audio Control

1 Select the source for adjustment

Press the [SRC] button.

2 Enter Audio Control mode

Press the [VOL] knob.

3 Select the Audio item for adjustment

Press the [VOL] knob.

Each time the knob is pressed, the items that can be adjusted switch as shown below.

4 Adjust the Audio item

Turn the [VOL] knob.

| Adjustment Item | Display | Range |
|-----------------|---------|--------------------|
| Bass level | "BAS" | -8 — +8 |
| Middle level | "MID" | -8 — +8 |
| Treble level | "TRE" | -8 — +8 |
| Balance | "BL" | Left 15 — Right 15 |
| Fader | "FD" | Rear 15 — Front 15 |

5 Exit Audio Control mode

Press any button.

Press the button which is not [VOL] knob and [ATT] button.

Audio Setup

Setting the Sound system, such as Volume offset and Loudness.

1 Select the source for adjustment

Press the [SRC] button.

2 Enter Audio Setup mode

Press the [VOL] knob for at least 1 second.

3 Select the Audio Setup item for adjustment

Press the [VOL] knob.

Each time the knob is pressed, the items that can be adjusted switch as shown below.

4 Adjust the Audio setup item

Turn the [VOL] knob.

| Adjustment Item | Display | Range |
|-----------------|---------|---------|
| Volume offset | "V-0F" | -8 — ±0 |
| Loudness | "LOUD" | ON/OFF |



- Volume offset: Each source's volume can be set as a difference from the basic volume.
- Loudness: Compensating for low and high tones during low volume.
When it's ON, "LOUD" indicator is ON.

5 Exit Audio Setup mode

Press the [VOL] knob for at least 1 second.

General features

Speaker Setting

Fine-tuning so that the System Q value is optimal when setting the speaker type.

1 Enter Standby

Press the [SRC] button.

Select the "STBY" display.

2 Enter Speaker Setting mode

Press the [VOL] knob.

3 Select the Speaker type

Turn the [VOL] knob.

Each time the knob is turned, the setting switches as shown below.

| Speaker type | Display |
|-------------------------|---------|
| OFF | "SP-F" |
| For 5 & 4 in. speaker | "SP-5" |
| For 6x9 & 6 in. speaker | "SP-6" |
| For the OEM speaker | "SP-0" |

4 Exit Speaker Setting mode

Press the [VOL] knob.

Clock Display

Press the [CLK] button.

Each time the button is pressed, the clock display turns ON and OFF.

Adjusting Clock

1 Enter Standby

Press the [SRC] button.

Select the "STBY" display.

2 Select the clock display

Press the [CLK] button.

3 Enter clock adjustment mode

Press the [CLK] button for at least 2 seconds.

The clock display blinks.

4 Adjust the hours

Push the Control knob to [FM] or [AM].

Adjust the minutes

Push the Control knob to [◀◀] or [▶▶].

5 Exit clock adjustment mode

Press the [CLK] button.

Dimmer Control

You can change the unit's display to dimmer.

Press the [DIM] button for at least 1 second.

Each time the button is pressed for 1 second, the Dimmer control turns ON and OFF.

When it's ON, "on DI" is displayed.

DSI (Disabled System Indicator)

A red indicator will blink on the unit after the faceplate is removed, warning potential thieves.

1 Turn the power OFF

Press the [SRC] button for at least 1 second.

2 Set the DSI

While pressing the [1] and [3] button, press the [SRC] button.

Release your fingers from the button after the display is appeared.

Each time the step 1 and 2 operations are done, the DSI turns ON and OFF.

Theft Deterrent Faceplate

The faceplate of the unit can be detached and taken with you, helping to deter theft.

Removing the Faceplate

Press the Release button.

The faceplate is unlocked, allowing you to detach it.



- The faceplate is a precision piece of equipment and can be damaged by shocks or jolts. For that reason, keep the faceplate in its special storage case while detached.
- Do not expose the faceplate or its storage case to direct sunlight or excessive heat or humidity. Also avoid places with too much dust or the possibility of water splashing.

Reattaching the Faceplate

- 1** Align the projections on the unit with the grooves on the faceplate.

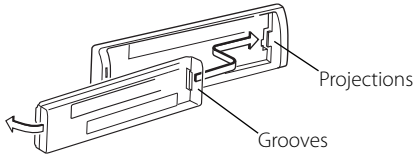

- 2** Push the faceplate in until it clicks.

The faceplate is locked in place, allowing you to use the unit.

TEL Mute

The audio system automatically mutes when a call comes in.

When a call comes in

"CALL" is displayed.
The audio system pauses.

Listening to the audio during a call

Press the [SRC] button.

The "CALL" display disappears and the audio system comes back ON.

When the call ends

Hang up the phone.

The "CALL" display disappears and the audio system comes back ON.

Tuner features

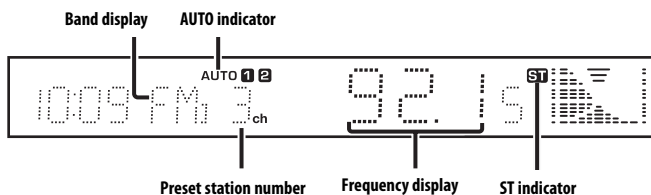
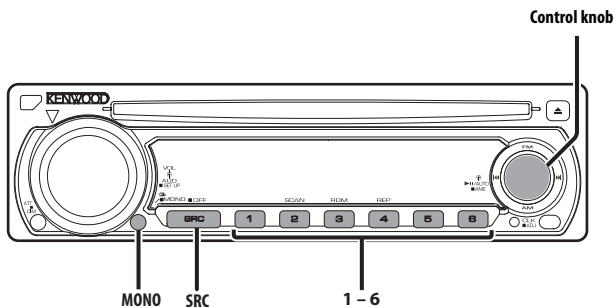

Tuning

Selecting the station.

1 Select tuner source

Press the [SRC] button.

Select the "TUnE" display.

2 Select the band

Push the Control knob to [FM] or [AM].

Each time the knob is pushed to [FM], it switches between the FM1, FM2, and FM3 bands.

3 Tune up or down band

Push the Control knob to [◀◀] or [▶▶].



- During reception of stereo stations the "ST" indicator is ON.

Tuning Mode

Choose the tuning mode.

Press the control knob.

Each time the knob is pressed, the Tuning mode switches as shown below.

| Tuning mode | Display | Operation |
|---------------------|--------------------|---|
| Auto seek | "AUTO 1" indicator | Automatic search for a station. |
| Preset station seek | "AUTO 2" indicator | Search in order of the stations in the Preset memory. |
| Manual | — | Normal manual tuning control. |

Monaural Reception

Press the [MONO] button for at least 1 second.

Each time the button is pressed for at least 1 second, the Monaural Reception turns ON and OFF.

When it's ON, "on MONO" is displayed.

Station Preset Memory

Putting the station in the memory.

1 Select the band

Push the Control knob to [FM] or [AM].

2 Select the frequency to put in the memory

Push the Control knob to [◀◀] or [▶▶].

3 Put the frequency in the memory

Press the desired [1] — [6] button for at least 2 seconds.

The preset number display blinks 1 time.

On each band, 1 station can be put in the memory on each [1] — [6] button.

Auto Memory Entry

Putting stations with good reception in the memory automatically.

1 Select the band for Auto Memory Entry

Push the control knob to [FM] or [AM].

2 Open Auto Memory Entry

Press the Control knob for at least 2 seconds.

When 6 stations that can be received are put in the memory Auto Memory Entry closes.

Preset Tuning

Calling up the stations in the memory.

1 Select the band

Push the Control knob to [FM] or [AM].

2 Call up the station

Press the desired [1] — [6] button.

CD player features

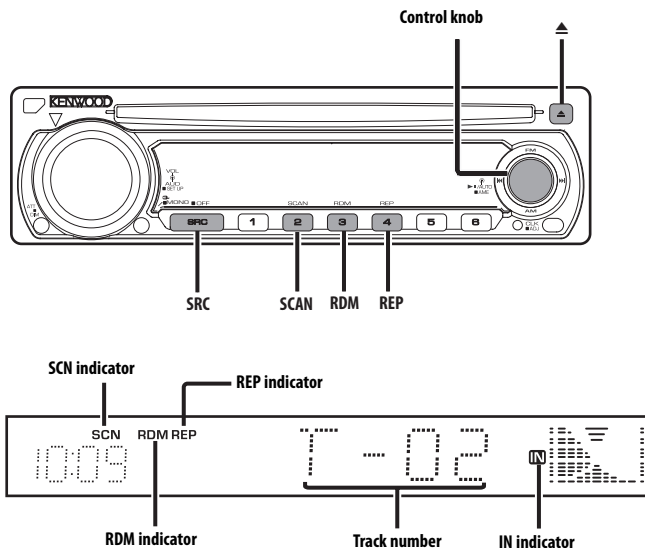

Playing CD

When a disc is inserted

Press the [SRC] button.

Select the "CD" display.



- When a CD is inserted, the "IN" indicator is ON.

Pause and play

Press the control knob.

Each time the knob is pressed, it pauses and plays.

Eject the CD

Press the [▲] button.

Fast Forwarding and Reversing

Fast Forwarding

Hold down on [▶▶] of the Control knob.

Release your finger to play the disc at that point.

Reversing

Hold down on [◀◀] of the Control knob.

Release your finger to play the disc at that point.

Track Search

Selecting the song you want to hear.

Push the Control knob to [◀◀] or [▶▶].

Track Repeat

Replaying the song you're listening to.

Press the [REP] button.

Each time the button is pressed, the Track Repeat turns ON and OFF.

When it's ON, the "REP" indicator is ON.

Scan Play

Playing the first part of each song on the disc you are listening to and searching for the song you want to listen to.

1 Start Scan Play

Press the [SCAN] button.

"SCN" indicator is ON.

2 Release it when the song you want to listen to is played

Press the [SCAN] button.

Random Play

Playing all the songs on the disc in random order.

Press the [RDM] button.

Each time the button is pressed, Random Play turns ON and OFF.

When it's ON, the "RDM" indicator is ON.



- When the Control knob is pushed to [▶▶], the next song select starts.

Accessories/ Installation Procedure

Accessories

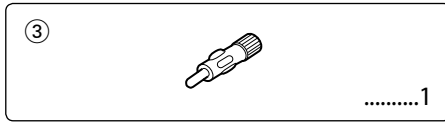
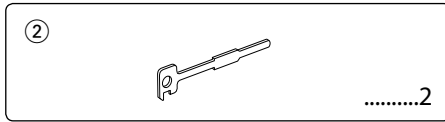
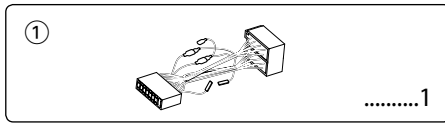

Installation Procedure

1. To prevent short circuits, remove the key from the ignition and disconnect the ⊖ terminal of the battery.
2. Make the proper input and output wire connections for each unit.
3. Connect the wire on the wiring harness.
4. Take Connector B on the wiring harness and connect it to the speaker connector in your vehicle.
5. Take Connector A on the wiring harness and connect it to the external power connector on your vehicle.
6. Connect the wiring harness connector to the unit.
7. Install the unit in your car.
8. Reconnect the ⊖ terminal of the battery.
9. Press the reset button.



- If the power is not turned ON (or it is ON, but will be OFF immediately), the speaker wire may have a short-circuit or touched the chassis of the vehicle and the protection function may have been activated. Therefore, the speaker wire should be checked.
- If your car is not prepared for this special connection-system, consult your Kenwood dealer.
- Only use antenna conversion adapters (ISO-JASO) when the antenna cord has an ISO plug.
- Make sure that all wire connections are securely made by inserting jacks until they lock completely.

- If your vehicle's ignition does not have an ACC position, or if the ignition wire is connected to a power source with constant voltage such as a battery wire, the power will not be linked with the ignition (i.e., it will not turn on and off along with the ignition). If you want to link the unit's power with the ignition, connect the ignition wire to a power source that can be turned on and off with the ignition key.
- If the fuse blows, first make sure that the wires have not caused a short circuit, then replace the old fuse with one with the same rating.
- Insulate unconnected wires with vinyl tape or other similar material. To prevent short circuits, also do not remove the caps on the ends of the unconnected wires or the terminals.
- Connect the speaker wires correctly to the terminals to which they correspond. The unit may receive damage or fail to work if you share the ⊖ wires and/or ground them to any metal part in the car.
- After the unit is installed, check whether the brake lamps, indicators, wipers, etc. on the car are working properly.
- If the console has a lid, make sure to install the unit so that the faceplate does not hit the lid when closing and opening.
- Mount the unit so that the mounting angle is 30° or less.

Connecting Wires to Terminals

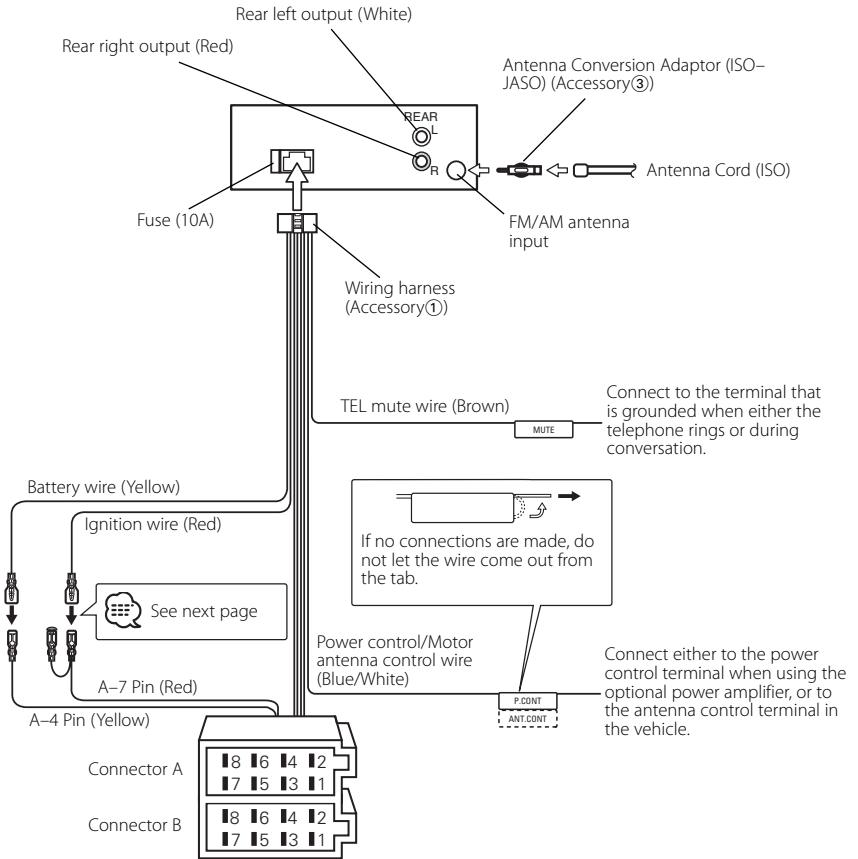

Connecting Wires to Terminals

Connector Function Guide

| Pin Numbers for ISO Connectors | Cable Colour | Functions |
|---------------------------------|--------------|---------------------------|
| External Power Connector | | |
| A-4 | Yellow | Battery |
| A-5 | Blue/White | Power Control |
| A-7 | Red | Ignition (ACC) |
| A-8 | Black | Earth (Ground) Connection |
| Speaker Connector | | |
| B-1 | Purple | Rear Right (+) |
| B-2 | Purple/Black | Rear Right (-) |
| B-3 | Gray | Front Right (+) |
| B-4 | Gray/Black | Front Right (-) |
| B-5 | White | Front Left (+) |
| B-6 | White/Black | Front Left (-) |
| B-7 | Green | Rear Left (+) |
| B-8 | Green/Black | Rear Left (-) |

▲WARNING

Connecting the ISO Connector

The pin arrangement for the ISO connectors depends on the type of vehicle you drive. Make sure to make the proper connections to prevent damage to the unit. The default connection for the wiring harness is described in [1] below. If the ISO connector pins are set as described in [2] or [3], make the connection as illustrated. Please be sure to reconnect the cable as shown [2] below to install this unit to the **Volkswagen** vehicles etc.

[1] (Default setting) The A-7 pin (red) of the vehicle's ISO connector is linked with the ignition, and the A-4 pin (yellow) is connected to the constant power supply.

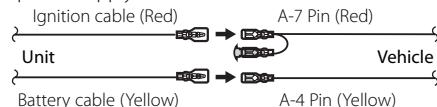

[2] The A-7 pin (red) of the vehicle's ISO connector is connected to the constant power supply, and the A-4 pin (yellow) is linked to the ignition.

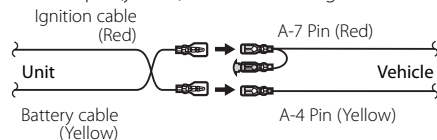

[3] The A-4 pin (yellow) of the vehicle's ISO connector is not connected to anything, while the A-7 pin (red) is connected to the constant power supply (or both the A-7 (red) and A-4 (yellow) pins are connected to the constant power supply).

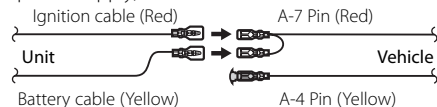

- When the connection is made as in [3] above, the unit's power will not be linked to the ignition key. For that reason, always make sure to turn off the unit's power when the ignition is turned off. To link the unit's power to the ignition, connect the ignition cable (ACC...red) to a power source that can be turned on and off with the ignition key.

Installation

Installation

Metal mounting strap
(commercially available)

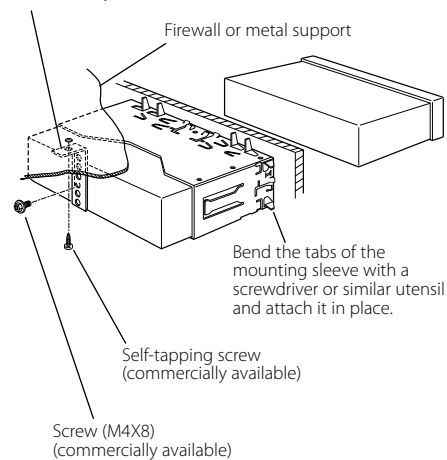

- Make sure that the unit is installed securely in place. If the unit is unstable, it may malfunction (for example, the sound may skip).

Removing the Unit

Removing the hard rubber frame

- 1 Engage the catch pins on the removal tool and remove the two locks on the upper level. Upper the frame and pull it forward as shown in the figure.

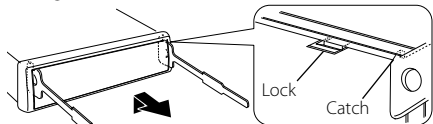

Accessory②
Removal tool

- 2 When the upper level is removed, remove the lower two locations.

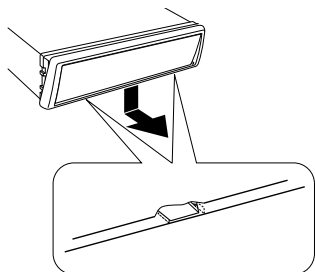

- The frame can be removed from the bottom side in the same manner.

Removing the Unit

- 1 Refer to the section <Removing the hard rubber frame> (page 18) and then remove the hard rubber frame.
- 2 Remove the screw (M4 × 8) on the back panel.
- 3 Insert the two removal tools deeply into the slots on each side, as shown.

Screw (M4X8)
(commercially available)

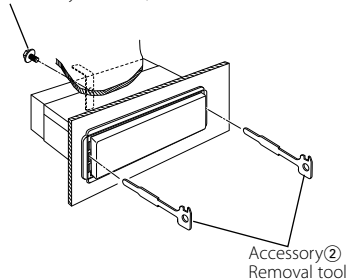

- 4 Lower the removal tool toward the bottom, and pull out the unit halfway while pressing towards the inside.

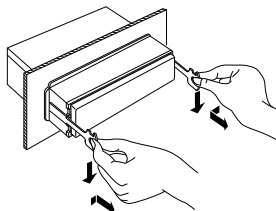

- Be careful to avoid injury from the catch pins on the removal tool.
- 5 Pull the unit all the way out with your hands, being careful not to drop it.

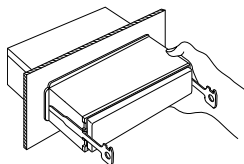

Troubleshooting Guide

What might seem to be a malfunction in your unit may just be the result of slight misoperation or miswiring. Before calling service, first check the following table for possible problems.

General

? The power does not turn ON.

- ✓ The fuse has blown.
 - ⓘ After checking for short circuits in the wires, replace the fuse with one with the same rating.
- ✓ The speaker wire has a short-circuit or touches the chassis of the vehicle, and then the protection function is activated.
 - ⓘ Wire or insulate the speaker cable properly and press the reset button.

? There's a source you can't switch.

- ✓ There's no media inserted.
 - ⓘ Set the media you want to listen to. If there's no media in this unit, you can't switch to each source.

? The memory is erased when the ignition is turned OFF.

- ✓ The ignition and battery wire are incorrectly connected.
 - ⓘ Connect the wire correctly, referring to the section on <Connecting Wires to Terminals>.

? The TEL mute function does not work.

- ✓ The TEL mute wire is not connected properly.
 - ⓘ Connect the wire correctly, referring to the section on <Connecting Wires to Terminals>.

? The TEL mute function turns ON even though the TEL mute wire is not connected.

- ✓ The TEL mute wire is touching a metal part of the car.
 - ⓘ Pull the TEL mute wire away from the metal part of the car.

? Even if Loudness is turned ON, high-pitched tone isn't compensated for.

- ✓ Tuner source is selected.
 - ⓘ High-pitched tone isn't compensated for when in Tuner source.

? No sound can be heard, or the volume is low.

- ✓ The fader or balance settings are set all the way to one side.
 - ⓘ Center the fader and balance settings.
- ✓ The input/output wires or wiring harness are connected incorrectly.
 - ⓘ Reconnect the input/output wires or the wiring harness correctly. See the section on <Connecting Wires to Terminals>.
- ✓ The values of Volume offset are low.
 - ⓘ Turn up the Volume offset, referring to the section on <Audio Setup> (page 7).

? The sound quality is poor or distorted.

- ✓ One of the speaker wires is being pinched by a screw in the car.
 - ⓘ Check the speaker wiring.
- ✓ The speakers are not wired correctly.
 - ⓘ Reconnect the speaker wires so that each output terminal is connected to a different speaker.

Tuner source

? Radio reception is poor.

- ✓ The car antenna is not extended.
 - ⓘ Pull the antenna out all the way.
- ✓ The antenna control wire is not connected.
 - ⓘ Connect the wire correctly, referring to the section on <Connecting Wires to Terminals>.

Disc source

? The specified disc does not play, but another one plays instead.

- ✓ The specified CD is quite dirty.

☞ Clean the CD.

- ✓ The disc is severely scratched.

☞ Try another disc instead.

? A CD ejects as soon as it is loaded.

- ✓ The CD is quite dirty.

☞ Clean the CD, referring to the CD cleaning of the section on <About CDs> (page 5).

? Can't remove disc.

- ✓ The cause is that more than 10 minutes has elapsed since the vehicle ACC switch was turned OFF.

☞ The disc can only be removed within 10 minutes of the ACC switch being turned OFF. If more than 10 minutes has elapsed, turn the ACC switch ON again and press the Eject button.

? The disc won't insert.

- ✓ There's already another disc inserted.

☞ Press the [▲] button and remove the disc.

The messages shown below display your systems condition.

- E-04: The CD is quite dirty. The CD is upside-down. The CD is scratched a lot.
☞ Clean the CD and load it correctly.
- E-99: The unit is malfunctioning for some reason.
☞ Press the reset button on the unit. If the "E-99" code does not disappear, consult your nearest service center.
- IN (Blink): The CD player section is not operating properly.
☞ Reinsert the CD. If the CD cannot be ejected or the display continues to flash even when the CD has been properly reinserted, please switch off the power and consult your nearest service center.

Specifications

Specifications subject to change without notice.

FM tuner section

- Frequency range (50 kHz space)
 - : 87.5 MHz – 108.0 MHz
- Usable sensitivity (S/N = 26dB)
 - : 0.7 μ V /75 Ω
- Quieting Sensitivity (S/N = 46dB)
 - : 1.6 μ V /75 Ω
- Frequency response (\pm 3.0 dB)
 - : 30 Hz – 15 kHz
- Signal to Noise ratio (MONO)
 - : 65 dB
- Selectivity (DIN) (\pm 400 kHz)
 - : \geq 80 dB
- Stereo separation (1 kHz)
 - : 35 dB

MW tuner section

- Frequency range (9 kHz space)
 - : 531 kHz – 1611 kHz
- Usable sensitivity (S/N = 20dB)
 - : 25 μ V

LW tuner section

- Frequency range
 - : 153 kHz – 281 kHz
- Usable sensitivity (S/N = 20dB)
 - : 45 μ V

CD player section

- Laser diode
 - : GaAlAs
- Digital filter (D/A)
 - : 8 Times Over Sampling
- D/A Converter
 - : 1 Bit
- Spindle speed
 - : 500 – 200 rpm (CLV)
- Wow & Flutter
 - : Below Measurable Limit
- Frequency response (\pm 1 dB)
 - : 10 Hz – 20 kHz
- Total harmonic distortion (1 kHz)
 - : 0.01 %
- Signal to Noise ratio (1 kHz)
 - : 93 dB
- Dynamic range
 - : 93 dB
- Channel separation
 - : 85 dB

Audio section

- Maximum output power
 - : 45 W x 4
- Output power (DIN 45324, +B=14.4V)
 - : 28 W x 4
- Tone action
 - Bass : 100 Hz \pm 10 dB
 - Middle : 1 kHz \pm 10 dB
 - Treble : 10 kHz \pm 10 dB
- Preout level / Load (during disc play)
 - : 2000 mV/10 k Ω
- Preout impedance (during disc play)
 - : \leq 600 Ω

General

- Operating voltage (11 – 16V allowable)
 - : 14.4 V
- Current consumption
 - : 10 A
- Installation Size (W x H x D)
 - : 182 x 53 x 155 mm
- Weight
 - : 1.4kg

KENWOOD

Free Manuals Download Website

<http://myh66.com>

<http://usermanuals.us>

<http://www.somanuals.com>

<http://www.4manuals.cc>

<http://www.manual-lib.com>

<http://www.404manual.com>

<http://www.luxmanual.com>

<http://aubethermostatmanual.com>

Golf course search by state

<http://golfingnear.com>

Email search by domain

<http://emailbydomain.com>

Auto manuals search

<http://auto.somanuals.com>

TV manuals search

<http://tv.somanuals.com>