

KENWOOD

KDC-3020R

CD-RECEIVER
INSTRUCTION MANUAL

KENWOOD CORPORATION



© B64-2117-00 (MWN/IW)

Contents

Safety precautions.....	3	CD/External disc control features	13	Accessories	20
About RDS	5	Playing CD		Installation Procedure	20
About CDs.....	5	Playing External Disc		Connecting Wires to Terminals 21	
General features	6	Fast Forwarding and Reversing		Installation	22
Power		Track Search		Troubleshooting Guide	25
Selecting the Source		Album Search		Specifications	28
Volume		Track/Album Repeat			
Attenuator		Track Scan			
Loudness		Random Play			
TEL Mute		Magazine Random Play			
System Q		Disc Naming (DNPS)			
Audio Control		Text/Title Scroll			
Speaker Setting		Menu system.....	16		
Switching Display		Menu System			
Theft Deterrent Faceplate		Touch Sensor Tone			
Tuner features	9	Manual Clock Adjustment			
Tuning		Synchronize Clock			
Station Preset Memory		DSI (Disabled System Indicator)			
Auto Memory Entry		Selectable Illumination			
Preset Tuning		News Bulletin with Timeout Setting			
RDS features	10	Local Seek			
PTY (Program Type)		Tuning Mode			
Program Type preset		Auto Memory Entry			
Changing Language for PTY Function		AF (Alternative Frequency)			
Traffic Information		Restricting RDS Region			
Presetting Volume for Traffic Information		Auto TP Seek			
		Monaural Reception			
		Text Scroll			
		Disc Naming			

Safety precautions

▲WARNING

To prevent injury or fire, take the following precautions:

- Insert the unit all the way in until it is fully locked in place. Otherwise it may fall out of place when jolted.
- When extending the ignition, battery, or ground wires, make sure to use automotive-grade wires or other wires with a 0.75mm² (AWG18) or more to prevent wire deterioration and damage to the wire coating.
- To prevent a short circuit, never put or leave any metallic objects (such as coins or metal tools) inside the unit.
- If the unit starts to emit smoke or strange smells, turn off the power immediately and consult your Kenwood dealer.
- Make sure not to get your fingers caught between the faceplate and the unit.
- Be careful not to drop the unit or subject it to strong shock.
The unit may break or crack because it contains glass parts.
- Do not touch the liquid crystal fluid if the LCD is damaged or broken due to shock. The liquid crystal fluid may be dangerous to your health or even fatal.
If the liquid crystal fluid from the LCD contacts your body or clothing, wash it off with soap immediately.

▲CAUTION

To prevent damage to the machine, take the following precautions:

- Make sure to ground the unit to a negative 12V DC power supply.
- Do not open the top or bottom covers of the unit.
- Do not install the unit in a spot exposed to direct sunlight or excessive heat or humidity. Also avoid places with too much dust or the possibility of water splashing.
- Do not set the removed faceplate or the faceplate case in areas exposed to direct sunlight, excessive heat or humidity. Also avoid places with too much dust or the possibility of water splashing.
- To prevent deterioration, do not touch the terminals of the unit or faceplate with your fingers.
- Do not subject the faceplate to excessive shock, as it is a piece of precision equipment.
- When replacing a fuse, only use a new one with the prescribed rating. Using a fuse with the wrong rating may cause your unit to malfunction.
- To prevent a short circuit when replacing a fuse, first disconnect the wiring harness.
- Do not place any object between the faceplate and the unit.
- Do not use your own screws. Use only the screws provided. If you use the wrong screws, you could damage the unit.

IMPORTANT INFORMATION **About the disc changer to be connected:**

To connect a disc changer having the "O-N" switch to this unit, set the "O-N" switch to "N". To connect a disc changer having no "O-N" switch to this unit, the converter cord CA-DS100 and/or switching adapter KCA-S210A are required as options.

A disc changer doesn't work when it is connected without using these options. If a model with no "O-N" switch is connected, some unavailable functions and information that cannot be displayed are generated. Note that none of the KDC-C100, KDC-C302, C205, C705, and non-Kenwood CD changers can be connected.



You can damage both your unit and the CD changer if you connect them incorrectly.

Do Not Load 3-in. CDs in the CD slot

If you try to load a 3 in. CD with its adapter into the unit, the adapter might separate from the CD and damage the unit.

NOTE

- If you experience problems during installation, consult your Kenwood dealer.
- If the unit does not seem to be working right, try pressing the reset button first. If that does not solve the problem, consult your Kenwood dealer.
- Press the reset button if the Disc auto changer fails to operate correctly. Normal operation should be restored.

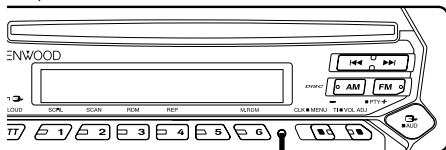

Reset button

- Characters in the LCD may become difficult to read in temperatures below 41 °F (5 °C).
- The illustrations of the display and the panel appearing in this manual are examples used to explain more clearly how the controls are used. Therefore, what appears on the display in the illustrations may differ from what appears on the display on the actual equipment, and some of the illustrations on the display may represent something impossible in actual operation.

Cleaning the Faceplate Terminals

If the terminals on the unit or faceplate get dirty, wipe them with a dry, soft cloth.

Cleaning the Unit

If the faceplate of this unit is stained, wipe it with a dry soft cloth such as a silicon cloth. If the faceplate is stained badly, wipe the stain off with a cloth moistened with neutral cleaner, then wipe neutral detergent off.

- ⚠ Applying spray cleaner directly to the unit may affect its mechanical parts. Wiping the faceplate with a hard cloth or using a volatile liquid such as thinner or alcohol may scratch the surface or erase characters.

**The marking of products using lasers
(Except for some areas)****CLASS 1
LASER PRODUCT**

The label is attached to the chassis/case and says that the component uses laser beams that have been classified as Class 1. It means that the unit is utilizing laser beams that are of a weaker class. There is no danger of hazardous radiation outside the unit.

Cleaning the CD Slot

As dust tends to accumulate in the CD slot, clean it every once in a while. Your CDs can get scratched if you put them in a dusty CD slot.

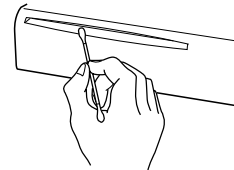
**Lens Fogging**

Right after you turn on the car heater in cold weather, dew or condensation may form on the lens in the CD player of the unit. Called lens fogging, CDs may be impossible to play. In such a situation, remove the disc and wait for the condensation to evaporate. If the unit still does not operate normally after a while, consult your Kenwood dealer.

About RDS

RDS (Radio Data System)

When listening to an RDS station, the programme service name of the station is displayed, advising you quickly which station is being received.

RDS (Radio Data System) stations also transmit alternative frequency data for the same station. When you are making long trips, this function automatically switches to the particular frequency with the best reception for the particular network of stations that you want to listen to. The data is automatically stored, allowing you to switch quickly to another RDS station, broadcasting the same programme, that has better reception. These include stations stored in the station preset memory that you often listen to.

Enhanced Other Network

Stations that offer <Enhanced Other Network> also transmit information about other RDS stations that have traffic information. When you are tuned to a station that is not transmitting traffic information, but another RDS station starts transmitting a traffic bulletin, the tuner automatically switches to the other station for the duration of the bulletin.

Alarm

When an emergency transmission (announcing disasters, etc.) is sent, all current functions are interrupted to allow the warning to be received.

About CDs

Handling CDs

- Don't touch the recording surface of the CD.

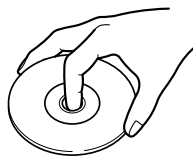

- CD-R and CD-RW are easier to damage than a normal music CD. Use a CD-R or a CD-RW after reading the caution items on the package etc.
- Don't stick tape etc. on the CD. Also, don't use a CD with tape stuck on it.

When using a new CD

If the CD center hole or outside rim has burrs, use it after removing them with a ball pen etc.

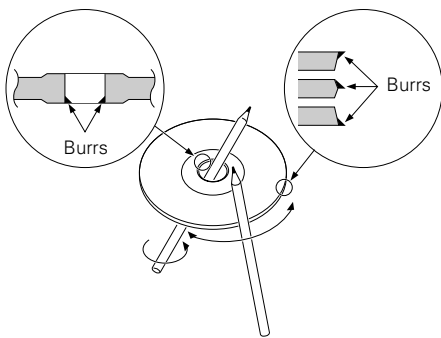

CD accessories

Don't use disc type accessories.

CD cleaning

Clean from the center of the disc and move outward.

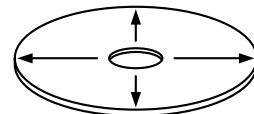



Removing CDs

When removing CDs from this unit pull them out horizontally.

CDs that can't be used

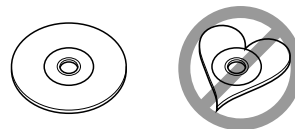
- CDs that aren't round can't be used.



- CDs with coloring on the recording surface or that are dirty can't be used.
 - Don't use CDs without disc mark
- 
- A CD-R or CD-RW that hasn't been finalized can't be played. (For the finalization process refer to your CD-R/CD-RW writing software, and your CD-R/CD-RW recorder instruction manual.)

CD storage

- Don't place them in direct sunlight (On the seat or dashboard etc.) and where the temperature is high.
- Store CDs in their cases.

General features

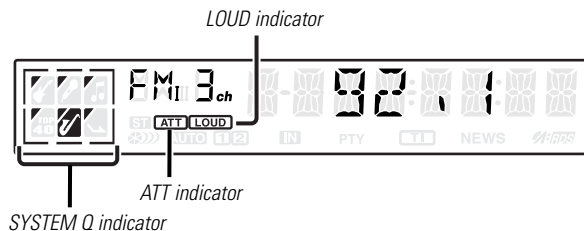
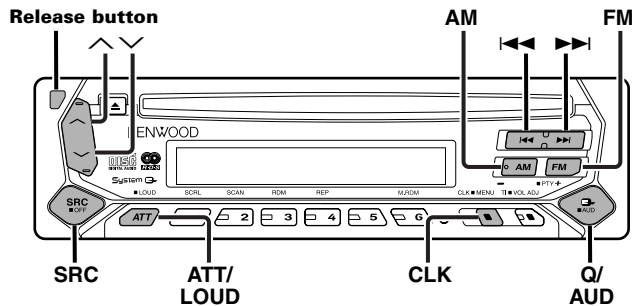

Power

Turning ON the Power

Press the [SRC] button.

Turning OFF the Power

Press the [SRC] button for at least 1 second.

Selecting the Source

Press the [SRC] button.

Source required	Display
Tuner	"TUNER"
CD	"CD"
External disc	"DISC"
Standby (Illumination only mode)	"ALL OFF"

Volume

Increasing Volume

Press the [^] button.

Decreasing Volume

Press the [v] button.

Attenuator

Turning the volume down quickly.

Press the [ATT] button.

Each time the button is pressed the Attenuator turns ON or OFF. When it's ON, the "ATT" indicator blinks.

Loudness

Compensating for low and high tones during low volume.

Press the [LOUD] button for at least 1 second.
 Each time the button is pressed for at least 1 second the Loudness turns ON or OFF.
 When it's ON, "LOUD" indicator is ON.

TEL Mute

The audio system automatically mutes when a call comes in.

When a call comes in

"CALL" is displayed.
 The audio system pauses.

Listening to the audio during a call

Press the [SRC] button.
 The "CALL" display disappears and the audio system comes back ON.

When the call ends

Hang up the phone.
 The "CALL" display disappears and the audio system comes back ON.

System Q

You can recall the best sound setting preset for different types of the music.

1 Select the source to set

Press the [SRC] button.

2 Select the Sound type

Press the [Q] button.
 Each time the button is pressed the sound setting switches.

Sound setting	Display
Flat	"FLAT"
Rock	"ROCK"

Top 40	"TOP40"
Pops	"POPS"
Jazz	"JAZZ"
Easy	"EASY"
Scan of Flat — Easy	"SCAN"



- Each setting value is changed with the <Speaker setting> (page 8).
 First, select the speaker type with the Speaker setting.
- When the System Q setting is changed, the Bass, Middle, and Treble set in audio control replace the System Q values.

Audio Control

1 Select the source for adjustment

Press the [SRC] button.

2 Enter Audio Control mode

Press the [AUD] button for at least 1 second.

3 Select the Audio item for adjustment

Press the [FM] or [AM] button.
 Each time the button is pressed the items that can be adjusted switch as shown below.

4 Adjust the Audio item

Press the [◀◀] or [▶▶] button.

Adjustment Item	Display	Range
Bass level	"BAS"	-8 — +8
Middle level	"MID"	-8 — +8
Treble level	"TRE"	-8 — +8
Balance	"BAL"	Left 15 — Right 15
Fader	"FAD"	Rear 15 — Front 15

5 Exit Audio Control mode

Press the [AUD] button.

General features

Speaker Setting

Fine-tuning so that the System Q value is optimal when setting the speaker type.

1 Enter Standby

Press the [SRC] button.
Select the "ALL OFF" display.

2 Enter Speaker Setting mode

Press the [Q] button.

3 Select the Speaker type

Press the [◀◀] or [▶▶] button.
Each time the button is pressed the setting switches as shown below.

Speaker type	Display
OFF	"SP OFF"
For the OEM speaker	"SP OEM"
For 6 & 6x9 in. speaker	"SP 6/6x9"
For 5 & 4 in. speaker	"SP 5/4"

4 Exit Speaker Setting mode

Press the [Q] button.

Switching Display

Switching the information displayed.

Press the [CLK] button.
Each time the button is pressed the display switches as shown below.

In Tuner source

Information	Display
Program Service name or Frequency	
Clock	

In CD & External disc source

Information

Display

Track Time	
Disc name*	"D-NAME"
Disc title*	"D-TITLE"
Track title*	"T-TITLE"
Clock	

 *: <In External disc control mode>

Theft Deterrent Faceplate

The faceplate of the unit can be detached and taken with you, helping to deter theft.

Removing the Faceplate

Press the Release button.

The faceplate is unlocked, allowing you to detach it.



- The faceplate is a precision piece of equipment and can be damaged by shocks or jolts. For that reason, keep the faceplate in its special storage case while detached.
- Do not expose the faceplate or its storage case to direct sunlight or excessive heat or humidity. Also avoid places with too much dust or the possibility of water splashing.

Reattaching the Faceplate

- 1 Align the projections on the unit with the grooves on the faceplate.

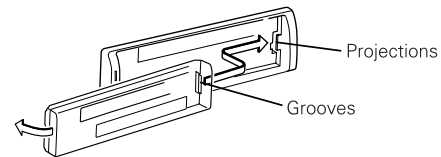

- 2 Push the faceplate in until it clicks.

The faceplate is locked in place, allowing you to use the unit.

Tuner features

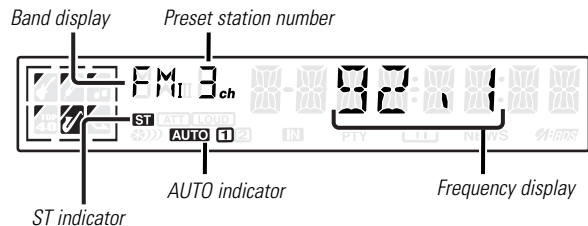
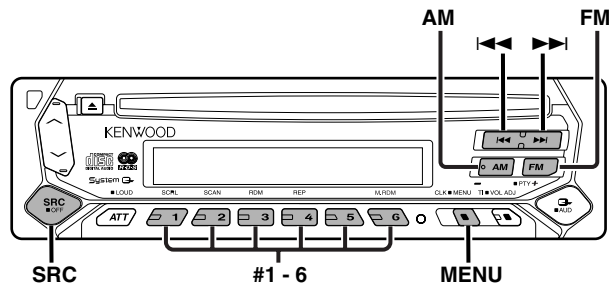

Tuning

Selecting the station.

1 Select tuner source

Press the [SRC] button.
Select the "TUNER" display.

2 Select the band

Press the [FM] or [AM] button.
Each time the [FM] button is pressed it switches between the FM1, FM2, and FM3 bands.

3 Tune up or down band

Press the [◀◀] or [▶▶] button.

 During reception of stereo stations the "ST" indicator is ON.

Station Preset Memory

Putting the station in the memory.

1 Select the band

Press the [FM] or [AM] button.

2 Select the frequency to put in the memory

Press the [◀◀] or [▶▶] button.

3 Put the frequency in the memory

Press the [#1] — [#6] button for at least 2 seconds.

The preset number display blinks 1 time.

On each band, 1 station can be put in the memory on each [#1] — [#6] button.

Tuner features

Auto Memory Entry

Putting a station with good reception in the memory automatically.

1 Select the band for Auto Memory Entry

Press the [FM] or [AM] button.

2 Enter Menu mode

Press the [MENU] button for at least 1 second.
"MENU" is displayed.

3 Select the Auto Memory Entry mode

Press the [FM] or [AM] button.
Select the "A-MEMORY" display.

4 Open Auto Memory Entry

Press the [◀◀] or [▶▶] button for at least 2 seconds.
When 6 stations that can be received are put in the memory
Auto Memory Entry closes.



- When the <AF Function> (page 18) is ON, only RDS stations are put in the memory.
- When Auto Memory Entry is done in the FM2 band, the RDS stations preset in the FM1 band aren't put in the memory. Likewise, when it is done in the FM3 band, RDS stations preset in FM1 or FM2 aren't put in the memory.

Preset Tuning

Calling up the stations in the memory.

1 Select the band

Press the [FM] or [AM] button.

2 Call up the station

Press the [#1] — [#6] button.

RDS features

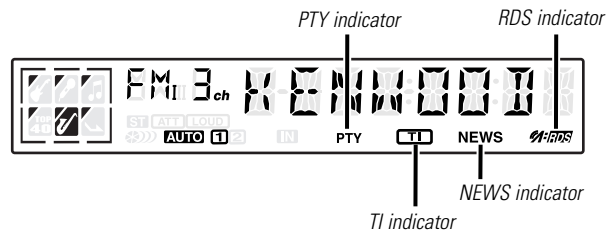
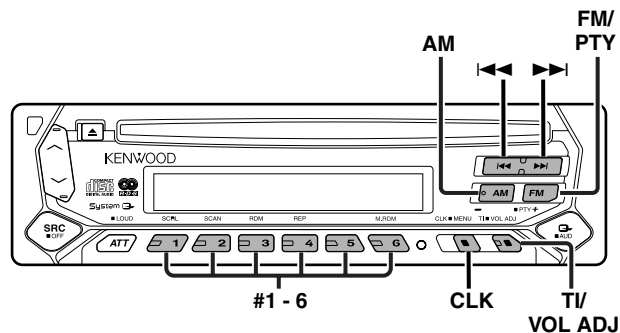

PTY (Program Type)

Selecting the Program Type and searching for a station.

1 Enter PTY mode

Press the [PTY] button for at least 1 second.

During PTY mode the "PTY" indicator is ON.



This function can't be used during a traffic bulletin or AM reception.

2 Select the Program Type

Press the [FM] or [AM] button.

Each time the button is pressed the Program Type switches as shown below.

No.	Program Type	Display
1.	Music	"MUSIC"
2.	Speech	"SPEECH"
3.	News	"NEWS"
4.	Current Affairs	"AFFAIRS"
5.	Information	"INFO"
6.	Sport	"SPORT"
7.	Education	"EDUCATE"
8.	Drama	"DRAMA"
9.	Culture	"CULTURE"
10.	Science	"SCIENCE"
11.	Varied	"VARIED"
12.	Pop Music	"POP M"
13.	Rock Music	"ROCK M"
14.	Easy Listening Music	"EASY M"
15.	Light Classical	"LIGHT M"
16.	Serious Classical	"CLASSICS"
17.	Other Music	"OTHER M"
18.	Weather	"WEATHER"
19.	Finance	"FINANCE"
20.	Children's programs	"CHILDREN"

21.	Social Affairs	"SOCIAL"
22.	Religion	"RELIGION"
23.	Phone In	"PHONE IN"
24.	Travel	"TRAVEL"
25.	Leisure	"LEISURE"
26.	Jazz Music	"JAZZ"
27.	Country Music	"COUNTRY"
28.	National Music	"NATION M"
29.	Oldies Music	"OLDIES"
30.	Folk Music	"FOLK M"
31.	Documentary	"DOCUMENT"



- Speech and Music include the Program type shown below.

Music: No.12 — 17, 26 — 30

Speech: No.3 — 11, 18 — 25, 31

- The Program Type can be put in the [#1] — [#6] button memory and called up quickly. Refer to the <Program Type preset> (page 12).
- The display language can be changed. Refer to <Changing Language for PTY Function> (page 12).

3 Search for the selected Program Type station

Press the [◀◀] or [▶▶] button.

When you want to search for other stations press the [◀◀] or [▶▶] button again.



- When the selected Program Type isn't found, "NO PTY" is displayed.

Select another Program Type.

4 Exit PTY mode

Press the [PTY] button for at least 1 second.

RDS features

Program Type preset

Putting the Program Type in the Preset button memory and calling it up quickly.

Presetting the Program Type

1 Select the Program Type to preset

Refer to <PTY(Program Type)> (page 11).

2 Preset the Program Type

Press the [#1] — [#6] button for at least 2 seconds.

Calling up the preset Program Type

1 Enter PTY mode

Refer to <PTY(Program Type)> (page 11).

2 Call up the Program Type

Press the [#1] — [#6] button.

Changing Language for PTY Function

Selecting the Program Type display language.

1 Enter PTY mode

Refer to <PTY (Program Type)> (page 11).

2 Enter Changing Language mode

Press the [CLK] button.

3 Select the language

Press the [#1] — [#3] button.

Button	Language
[#1]	English
[#2]	French
[#3]	German

4 Exit Changing Language mode

Press the [CLK] button.

Traffic Information

Switching to traffic information automatically when a traffic bulletin starts even when you aren't listening to the radio.

Press the [TI] button.

Each time the button is pressed the Traffic Information function turns ON or OFF.

When it's ON, "TI" indicator is ON.

When a traffic information station isn't being received the "TI" indicator blinks.

When a traffic bulletin starts, "TRAFFIC" is displayed it and it switches to traffic information.



- During reception of a AM station when the Traffic Information function is turned ON, it switches to a FM station.
- During reception of traffic information the adjusted volume is automatically remembered, and the next time it switches to traffic information it's automatically the remembered volume.

Receiving other traffic information stations

Press the [◀◀] or [▶▶] button.



Traffic information station switching can be done when listening to the radio.

Presetting Volume for Traffic Information

Setting the volume during Traffic Information.

1 Receive the station.

2 Set the volume you want.

3 Preset the volume

Press the [VOL ADJ] button for at least 2 seconds.

The volume level display blinks 1 time.

CD/External disc control features

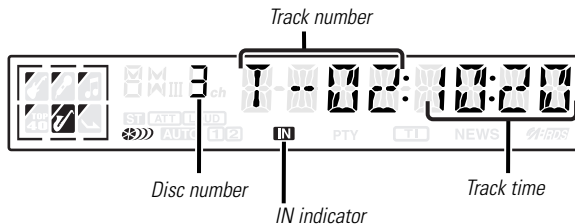
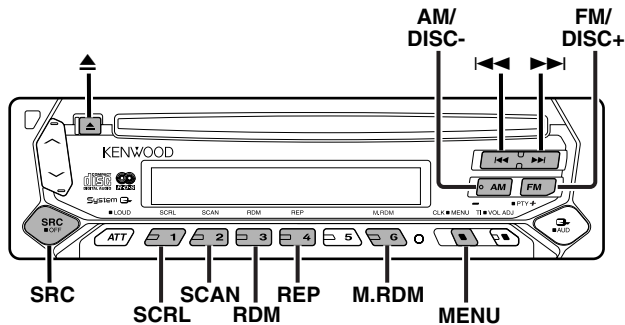

Playing CD

When a CD is inserted

Press the [SRC] button.
Select the "CD" display.

When a CD is inserted, the "IN" indicator is ON.

Eject the CD

Press the [▲] button.

3 in. (8cm) CD cannot be played. Using an adapter and inserting them into this unit can cause damage.

Playing External Disc

Playing discs set in the optional accessory disc player connected to this unit.

Press the [SRC] button.

Select the display for the disc player you want.

Display examples:

Display	Disc player
"CD-2"	CD player
"DISC"	CD changer
"DISC"	MD changer

- Disc #10 is displayed as "0".
- The functions that can be used and the information that can be displayed will differ depending on the external disc players being connected.

CD/External disc control features

Fast Forwarding and Reversing

Fast Forwarding

Hold down on the [▶▶] button.
Release your finger to play the disc at that point.

Reversing

Hold down on the [◀◀] button.
Release your finger to play the disc at that point.

Track Search

Selecting the song you want to hear.

Press the [◀◀] or [▶▶] button.

Album Search (Function of disc changer)

Selecting the disc you want to hear.

Press the [DISC-] or [DISC+] button.

Track/Album Repeat

Replaying the track/disc you're listening to.

Press the [REP] button.
Each time the button is pressed the Repeat Play switches as shown below.

Repeat play	Display
Track Repeat	"REP ON/ "TREP ON"
Album Repeat (Function of disc changer)	"DREP ON"
OFF	"REP OFF"

Track Scan

Playing the first part of each song on the disc you are listening to and searching for the song you want to listen to.

1 Start Track Scan

Press the [SCAN] button.
"SCAN ON"/"TSCN ON" is displayed.

2 Release it when the song you want to listen to is played

Press the [SCAN] button.

Random Play

Playing all the songs on the disc in random order.

Press the [RDM] button.
Each time the button is pressed Random Play turns ON or OFF.
When it's ON, "RDM ON" is displayed.

 When the [▶▶] button is pressed, the next song select starts.

Magazine Random Play (Function of disc changer)

Play the songs on all the discs in the disc changer in random order.

Press the [M.RDM] button.
Each time the button is pressed the Magazine Random Play turns ON or OFF.
When it's ON, "MRDM ON" is displayed.

 When the [▶▶] button is pressed, the next song select starts.

Disc Naming (DNPS) (Function of disc changer)

Attaching a title to a CD.

1 Play the disc you want to attach a name to

 A title can't be attached to a MD.

2 Enter Menu mode

Press the [MENU] button for at least 1 second.
"MENU" is displayed.

3 Select Name set mode

Press the [FM] or [AM] button.
Select the "NAME SET" display.

4 Enter Name set mode

Press the [◀◀] or [▶▶] button for at least 2 seconds.

5 Move the cursor to the enter character position

Press the [◀◀] or [▶▶] button.

6 Select the characters

Press the [FM] or [AM] button.

7 Repeat steps 5 through 6 and attach a name.

8 Exit Menu mode

Press the [MENU] button.

-  • When operation stops for 10 seconds the name at that time is registered, and Name Set mode closes.
- Media that you can attach a name to
 - External CD changer/ player: Varies according to the CD changer/ player. Refer to the CD changer/ player manual.
 - The name of a CD can be changed by the same operation you used to name it.

Text/Title Scroll

Scrolling the displayed CD text or MD title.

Press the [SCRL] button.

Menu system

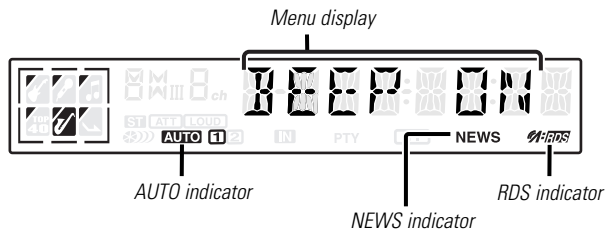
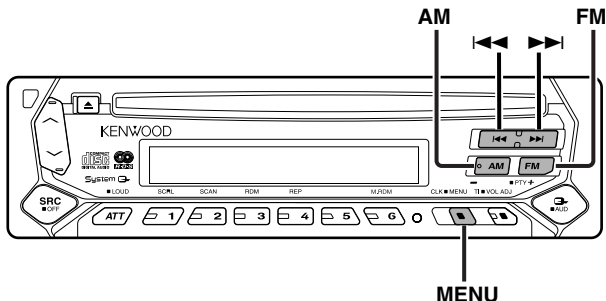

Menu System

Setting during operation beep sound etc. functions. The Menu system basic operation method is explained here. The reference for the Menu items and their setting content is after this operation explanation.

1 Enter Menu mode

Press the [MENU] button for at least 1 second. "MENU" is displayed.

2 Select the menu item

Press the [FM] or [AM] button.

Example: When you want to set the beep sound select the "BEEP" display.

3 Set the menu item

Press the [◀◀] or [▶▶] button.

Example: When "BEEP" is selected, each time the button is pressed it switches "BEEP ON" or "BEEP OFF". Select 1 of them as the setting.

You can continue by returning to step 2 and setting other items.

4 Exit Menu mode

Press the [MENU] button.



When other items that are applicable to the basic operation method above are displayed afterwards their setting content chart is entered. (Normally the uppermost setting in the chart is the original setting.)

Also, the explanation for items that aren't applicable (<Manual Clock Adjustment>etc.) are entered step by step.

Touch Sensor Tone

Setting the operation check sound (beep sound) ON/OFF.

Display

"BEEP ON"

Setting

Beep is heard.

"BEEP OFF"

Beep canceled.

removed, warning potential thieves.

Manual Clock Adjustment



This adjustment can be done when the <Synchronize Clock> (page 17) is set as OFF.

1 Select Clock Adjustment mode

Press the [FM] or [AM] button.

Select the "CLK ADJ" display.

2 Enter Clock Adjust mode

Press the [◀◀] or [▶▶] button for at least 2 seconds.

The clock display blinks.

3 Adjust the hours

Press the [FM] or [AM] button.

Adjust the minutes

Press the [◀◀] or [▶▶] button.

4 Exit Clock adjustment mode

Press the [MENU] button.

Selectable Illumination

Selecting the button illumination color as green or red.

Display	Setting
"DSI ON"	LED flashes.
"DSI OFF"	LED OFF.

Synchronize Clock

Synchronizing the RDS station time data and this unit's clock.

Display	Setting
"SYNC ON"	Synchronizes the time.
"SYNC OFF"	Adjust the time manually.



It takes 3 to 4 minutes to synchronize the clock.

DSI (Disabled System Indicator)

A red indicator will blink on the unit after the faceplate is

Menu system

News Bulletin with Timeout Setting

It switches automatically when a news bulletin starts even if the radio isn't being listened to. Also, the time interval when interrupt is prohibited can be set.

Display and Setting

"NEWS OFF"

"NEWS 00M"

⋮

"NEWS 90M"

When "NEWS 00M" — "NEWS 90M" is set, the News Bulletin Interrupt function is ON.

When it's ON, the "NEWS" indicator is ON.

When the news bulletin starts, "NEWS" is displayed, and it switches to the news bulletin.



- If you choose the "20M" setting, further news bulletins will not be received for 20 minutes once the first news bulletin is received.
- The news bulletin volume is the same level that was set for traffic information (page 12).
- This function is only available if the desired station sends PTY-code for news bulletin or belongs to <Enhanced Other Network>-Network sending PTY-code for news bulletin.
- When the News Bulletin Interrupt function is ON, it switches to an FM station.

Local Seek <In Tuner mode>

Only stations whose reception is good are searched for in auto seek tuning.

Display	Setting
"LO.S OFF"	The local seek function is OFF.
"LO.S ON"	The local seek function is ON.

Tuning Mode <In Tuner mode>

Sets the tuning mode.

Tuning mode	Display	Operation
Auto seek	"AUTO 1"	Automatic search for a station.
Preset station seek	"AUTO 2"	Search in order of the stations in the Preset memory.
Manual	"MANUAL"	Normal manual tuning control.

Auto Memory Entry <In Tuner mode>

For the operation method refer to <Auto Memory Entry> (page 10).

AF (Alternative Frequency)

When poor reception is experienced, automatically switch to another frequency broadcasting the same program in the same RDS network with better reception.

Display	Setting
"AF ON"	The AF function is ON.
"AF OFF"	The AF function is OFF.

When the AF function is ON, the "RDS" indicator is ON.



When no other stations with stronger reception are available for the same program in the RDS network, you may hear the incoming broadcast in bits and snatches. Turn OFF the AF function in such a case.

Restricting RDS Region (Region Restrict Function)

You can choose whether or not to restrict the RDS channels, received with the AF function for a particular network, to a specific region.

Display	Setting
"REG ON"	The Region Restrict Function is ON.
"REG OFF"	The Region Restrict Function is OFF.



Sometimes stations in the same network broadcast different programs or use different program service names.

Auto TP Seek

When the TI function is ON and poor reception conditions are experienced when listening to a traffic information station, another traffic information station with better reception will be searched for automatically.

Display	Setting
"ATPS ON"	The Auto TP Seek Function is ON.
"ATPS OFF"	The Auto TP Seek Function is OFF.

Monaural Reception <In FM reception>

Noise can be reduced when stereo broadcasts are received as monaural.

Display	Setting
"MONO OFF"	The monaural reception is OFF.
"MONO ON"	The monaural reception is ON.

Text Scroll <In External disc control mode>

Setting the displayed text scroll.

Display	Setting
"SCL MANU"	Doesn't scroll.
"SCL AUTO"	Scrolls when the display changes.



The text scrolled is shown below.

- CD text
- MD title

Disc Naming <In External disc control mode>

For the setting method refer to the <Disc Naming> (page 15).

Accessories

External view

..... Number of items

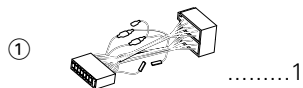

External view

..... Number of items

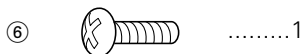

The use of any accessories except for those provided might result in damage to the unit. Make sure only to use the accessories shipped with the unit, as shown above.

▲WARNING

If you connect the ignition wire (red) and the battery wire (yellow) to the car chassis (ground), you may cause a short circuit, that in turn may start a fire. Always connect those wires to the power source running through the fuse box.

▲CAUTION

- If your car's ignition does not have an ACC position, connect the ignition wires to a power source that can be turned on and off with the ignition key. If you connect the ignition wire to a power source with a constant voltage supply, as with battery wires, the battery may die.
- If the console has a lid, make sure to install the unit so that the faceplate will not hit the lid when closing and opening.
- If the fuse blows, first make sure the wires aren't touching to cause a short circuit, then replace the old fuse with one with the same rating.
- Insulate unconnected wires with vinyl tape or other similar material. To prevent a short circuit, do not remove the caps on the ends of the unconnected wires or the terminals.
- Connect the speaker wires correctly to the terminals to which they correspond. The unit may be damaged or fail to work if you share the ⊖ wires or ground them to any metal part in the car.
- When only two speakers are being connected to the system, connect the connectors either to both the front output terminals or to both the rear output terminals (do not mix front and rear). For example, if you connect the ⊕ connector of the left speaker to a front output terminal, do not connect the ⊖ connector to a rear output terminal
- After the unit is installed, check whether the brake lamps, blinkers, wipers, etc. on the car are working properly.
- Mount the unit so that the mounting angle is 30° or less.

Installation Procedure

1. To prevent a short circuit, remove the key from the ignition and disconnect the ⊖ battery.
2. Make the proper input and output wire connections for each unit.
3. Connect the speaker wires of the wiring harness.
4. Connect the wiring harness wires in the following order: ground, battery, ignition.
5. Connect the wiring harness connector to the unit.
6. Install the unit in your car.
7. Reconnect the ⊖ battery.
8. Press the reset button.

Connecting Wires to Terminals

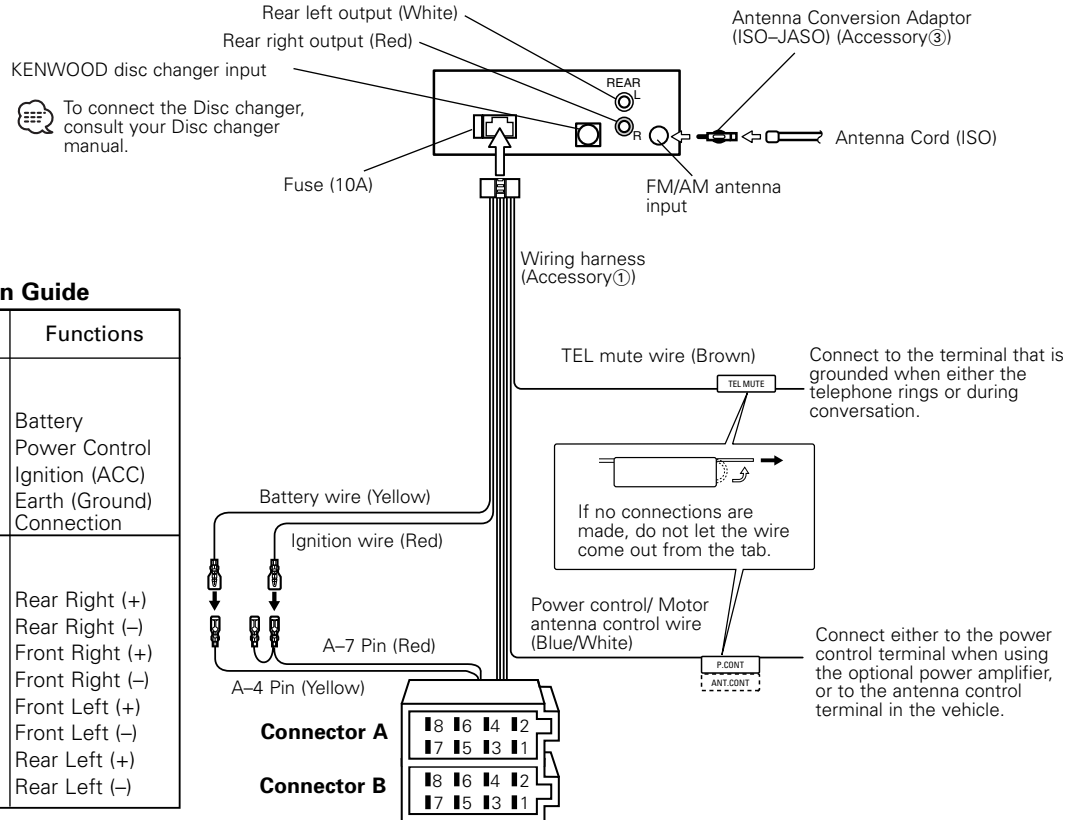

Connector Function Guide

Pin Numbers for ISO Connectors	Cable Color	Functions
External Power Connector		
A-4	Yellow	Battery
A-5	Blue/White	Power Control
A-7	Red	Ignition (ACC)
A-8	Black	Earth (Ground) Connection
Speaker Connector		
B-1	Purple	Rear Right (+)
B-2	Purple/Black	Rear Right (-)
B-3	Gray	Front Right (+)
B-4	Gray/Black	Front Right (-)
B-5	White	Front Left (+)
B-6	White/Black	Front Left (-)
B-7	Green	Rear Left (+)
B-8	Green/Black	Rear Left (-)

Connecting Wires to Terminals

▲WARNING Connecting the ISO Connector (see p.21)

The pin arrangement for the ISO connectors depends on the type of vehicle you drive. Make sure to make the proper connections to prevent damage to the unit.

The default connection for the wiring harness is described in [1] below. If the ISO connector pins are set as described in [2] or [3], make the connection as illustrated.

- [1] (Default setting) The A-7 pin (red) of the vehicle's ISO connector is linked with the ignition, and the A-4 pin (yellow) is connected to the constant power supply.

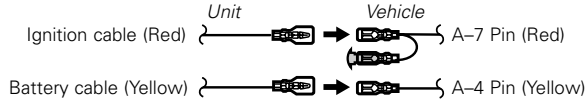

- [2] The A-7 pin (red) of the vehicle's ISO connector is connected to the constant power supply, and the A-4 pin (yellow) is linked to the ignition.

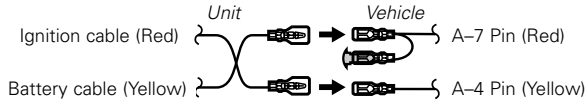

- [3] The A-4 pin (yellow) of the vehicle's ISO connector is not connected to anything, while the A-7 pin (red) is connected to the constant power supply (or both the A-7 (red) and A-4 (yellow) pins are connected to the constant power supply).

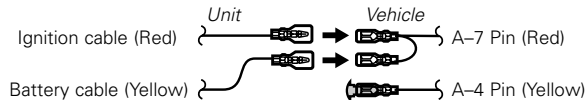

When the connection is made as in [3] above, the unit's power will not be linked to the ignition key. For that reason, always make sure to turn off the unit's power when the ignition is turned off.

To link the unit's power to the ignition, connect the ignition cable (ACC...red) to a power source that can be turned on and off with the ignition key.

Installation

■ Installation

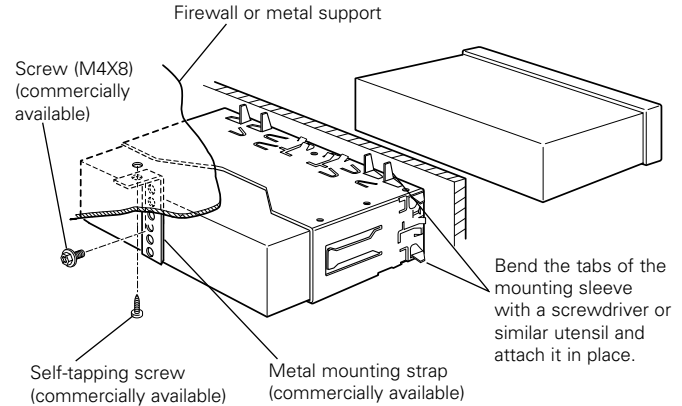

Make sure that the unit is installed securely in place. If the unit is unstable, it may malfunction (for example, the sound may skip).

Installation

■ Installing in Japanese-Made Cars

- 1 Refer to the section "Removing the hard rubber frame" (page 23) and then remove the hard rubber frame.
- 2 Align the holes in the unit (two locations on each side) with the vehicle mounting bracket and secure the unit with the accessory screws.

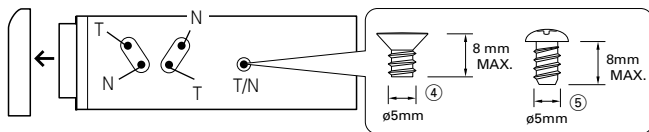

T: Toyota cars
N: Nissan cars

Accessory④...for Nissan car
Accessory⑤ ...for Toyota car



- During installation, do not use any screws except for those provided. The use of different screws might result in damage to the main unit.
- Damage may occur if a screwdriver or similar tool is used with excessive force during the installations.

■ Screwing the Faceplate on the Unit

If you want to fasten the faceplate to the main unit so that it does not fall off, screw in the provided screw (ø4 X 16 mm) in the hole shown below.

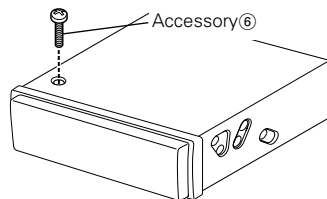

Never insert the tapite screw (ø4 × 16 mm) in any other screw hole than the one specified. If you screw it in another hole, it will contact and may cause damage to the mechanical parts inside the unit.

■ Removing the hard rubber frame

- 1 Engage the catch pins on the removal tool and remove the two locks on the lower level.
Lower the frame and pull it forward as shown in the figure.

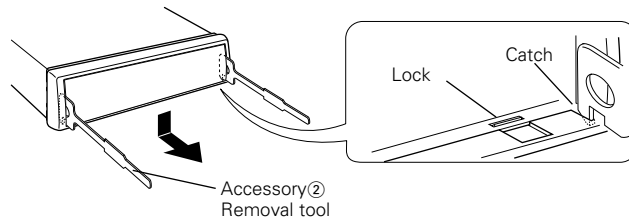

- 2 When the lower level is removed, remove the upper two locations.

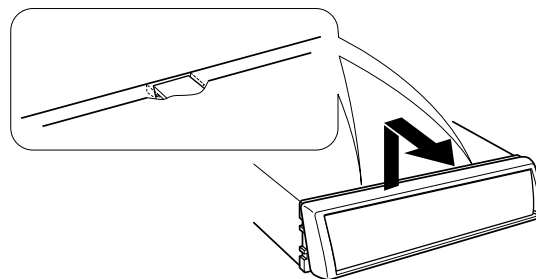

The frame can be removed from the top side in the same manner.

Installation

■ Removing the Unit

- 1 Refer to the section "Removing the hard rubber frame" and then remove the hard rubber frame.
- 2 Remove the screw (M4 × 8) on the back panel.
- 3 Insert the two removal tools deeply into the slots on each side, as shown.

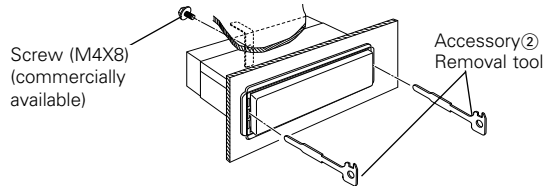

- 4 Lower the removal tool toward the bottom, and pull out the unit halfway while pressing towards the inside.

 Be careful to avoid injury from the catch pins on the removal tool.

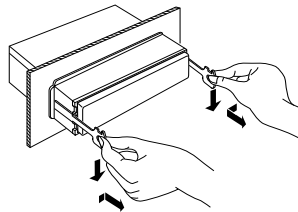

- 5 Pull the unit all the way out with your hands, being careful not to drop it.

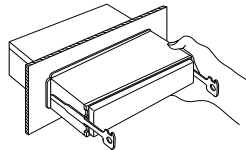

Troubleshooting Guide

What might seem to be a malfunction in your unit may just be the result of slight misoperation or miswiring. Before calling service, first check the following table for possible problems.

General

? The power does not turn ON.

- ✓ The fuse has blown.
 - ☞ After checking for short circuits in the wires, replace the fuse with one with the same rating.
 - ✓ No ACC position on vehicle ignition.
 - ☞ Connect the same wire to the ignition as the battery wire.
-

? Nothing happens when the buttons are pressed.

- ✓ The computer chip in the unit is not functioning normally.
 - ☞ Press the reset button on the unit (page 4).
-

? There's a source you can't switch.

- ✓ There's no CD inserted.
 - ☞ Set the media you want to listen to. If there's no media in this unit, you can't switch to each source.
-

? The memory is erased when the ignition is turned OFF.

- ✓ The battery wire has not been connected to the proper terminal.
 - ☞ Connect the wire correctly, referring to the section on <Connecting Wires to Terminals>.
 - ✓ The ignition and battery wire are incorrectly connected.
 - ☞ Connect the wire correctly, referring to the section on <Connecting Wires to Terminals>.
-

? The TEL mute function does not work.

- ✓ The TEL mute wire is not connected properly.
 - ☞ Connect the wire correctly, referring to the section on <Connecting Wires to Terminals>.
-

? The TEL mute function turns ON even though the TEL mute wire is not connected.

- ✓ The TEL mute wire is touching a metal part of the car.
 - ☞ Pull the TEL mute wire away from the metal part of the car.
-

? Even if Loudness is turned ON, high-pitched tone isn't compensated for.

- ✓ Tuner source is selected.
 - ☞ High-pitched tone isn't compensated for when in Tuner source.
-

? No sound can be heard, or the volume is low.

- ✓ The fader or balance settings are set all the way to one side.
 - ☞ Center the fader and balance settings.
 - ✓ The input/output wires or wiring harness are connected incorrectly.
 - ☞ Reconnect the input/output wires or the wiring harness correctly. See the section on "Connecting Wires to Terminals".
-

? The sound quality is poor or distorted.

- ✓ One of the speaker wires is being pinched by a screw in the car.
 - ☞ Check the speaker wiring.
 - ✓ The speakers are not wired correctly.
 - ☞ Reconnect the speaker wires so that each output terminal is connected to a different speaker.
-

? The Touch Sensor Tone doesn't sound.

- ✓ The preout jack is being used.
 - ☞ The Touch Sensor Tone can't be output from the preout jack.
-

? Even though Synchronize Clock is ON, the clock can't be adjusted.

- ✓ The received RDS station isn't sending time data.
 - ☞ Receive another RDS station.
-

Tuner source

? Radio reception is poor.

- ✓ The car antenna is not extended.
 - ☞ Pull the antenna out all the way.
 - ✓ The antenna control wire is not connected.
 - ☞ Connect the wire correctly, referring to the section on <Connecting Wires to Terminals>.
-

? It isn't the set Traffic information sound volume.

- ✓ The set sound volume is less than the tuner sound volume.
 - ☞ If the tuner sound volume is louder than the set sound volume, the tuner sound volume is used.
-

Troubleshooting Guide

Disc source

? "AUX" is displayed without achieving External disc control mode.

- ✓ O-N switch is set to "O" side.
☞ Set the switch to "N" side.

- ✓ Unsupported disc changer is connected.
☞ Connect the supported disc changer. (page 3)

? The specified disc does not play, but another one plays instead.

- ✓ The specified CD is quite dirty.
☞ Clean the CD.

- ✓ The CD is upside-down.
☞ Load the CD with the labeled side up.

- ✓ The disc is loaded in a different slot from that specified.
☞ Eject the disc magazine and check the number for the specified disc.

- ✓ The disc is severely scratched.
☞ Try another disc instead.

? The specified track will not play.

- ✓ Random play or magazine random play has been selected.
☞ Turn off random play or magazine random play.

? Track repeat, disc repeat, track scan, random play, and magazine random play start by themselves.

- ✓ The setting is not canceled.
☞ The settings for these functions remain on until the setting to off or the disc ejected, even if the power is turned off or the source changed.

? Cannot play CD-R or CD-RW.

- ✓ Finalization processing is not being conducted for CD-R/CD-RW.
☞ Conduct finalization processing with CD recorder.

- ✓ A non-compatible CD changer is being used to play the CD-R/CD-RW.
☞ Use a CD changer compatible with CD-R/CD-RW to play.

? A CD ejects as soon as it is loaded.

- ✓ The CD is upside-down.
☞ Load the CD with the labeled side up.

- ✓ The CD is quite dirty.
☞ Clean the CD, referring to the section on <CD cleaning> (page 5).

? Can't remove disc.

- ✓ The cause is that more than 10 minutes has elapsed since the vehicle ACC switch was turned OFF.
☞ The disc can only be removed within 10 minutes of the ACC switch being turned OFF. If more than 10 minutes has elapsed, turn the ACC switch ON again and press the Eject button.

? The disc won't insert.

- ✓ There's already another disc inserted.
☞ Press the [▲] button and remove the disc.

? Track Search can't be done.

- ✓ For the albums first or last song.
☞ For each album, Track Search can't be done in the backward direction for the first song or in the forward direction for the last song.

If the following situations, consult your nearest service center:

- Even though the disc changer is connected, the Disc Changer source is not ON, with "AUX" showing in the display during the Changer Mode.
- Even though no device (KCA-S210A, CA-C1AX, KDC-CPS87, KDC-CX87, KDC-CPS85, KDC-CX85, KDC-CPS82 or KDC-CX82) is connected, the Auxiliary input is entered when switching modes.

Troubleshooting Guide

The messages shown below display your systems condition.

- EJECT:** No disc magazine has been loaded in the changer. The disc magazine is not completely loaded.
⇨ Load the disc magazine properly.
No CD in the unit.
⇨ Insert the CD.
- NO DISC:** No disc has been loaded in the disc magazine.
⇨ Load a disc into the disc magazine.
- E-04:** No disc has been loaded in the disc magazine.
⇨ Load a disc into the disc magazine.
The CD is quite dirty. The CD is upside-down. The CD is scratched a lot.
⇨ Clean the CD and load it correctly.
- BLANK:** Nothing has been recorded on the MD.
- NO TRACK:** No tracks are recorded on the MD, although it has a title.
- NO PANEL:** The faceplate of the slave unit being connected to this unit has been removed.
⇨ Replace it.
- E-77:** The unit is malfunctioning for some reason.
⇨ Press the reset button on the unit. If the "E- 77" code does not disappear, consult your nearest service center.
- E-99:** Something is wrong with the disc magazine. Or the unit is malfunctioning for some reason.
⇨ Check the disc magazine. And then press the reset button on the unit. If the "E-99" code does not disappear, consult your nearest service center.

- HOLD:** The protective circuit in the unit activates when the temperature inside the automatic disc changer exceeds 60°C (140°F), stopping all operation.
⇨ Cool down the unit by opening the windows or turning on the air conditioner. As the temperature falls below 60°C (140°F), the disc will start playing again.
- NO NAME:** Attempted to display DNPS during the CD play having no disc names preset.
- NO TITLE:** Attempted to display the disc title or track title while the MD having no MD title is being played.
- NO TEXT:** Attempted to display the disc text or track text while the CD having no CD text is being played.
- LOAD:** Discs are being exchanged in the Disc changer.
- NO ACCESS:** After setting it in the Disc Changer, DNPP was done without having it been played at least 1 time.
- IN (Blink):** The CD player section is not operating properly.
⇨ Reinsert the CD. If the CD cannot be ejected or the display continues to flash even when the CD has been properly reinserted, please switch off the power and consult your nearest service center.

Specifications

Specifications subject to change without notice.

FM tuner section

Frequency range (50 kHz space)	87.5 MHz – 108.0 MHz
Usable sensitivity (S/N = 26dB)	8.1 dBf (0.7 μ V/75 Ω)
Quieting Sensitivity (S/N = 46dB)	15.2 dBf (1.6 μ V/75 Ω)
Frequency response (\pm 3 dB)	30 Hz – 15 kHz
Signal to Noise ratio (MONO)	65 dB
Selectivity (DIN) (\pm 400 kHz)	\geq 80 dB
Stereo separation (1 kHz)	35 dB

MW tuner section

Frequency range (9 kHz space)	531 kHz – 1611 kHz
Usable sensitivity (S/N = 20dB)	28 dB μ (25 μ V)

LW tuner section

Frequency range	153 kHz – 281 kHz
Usable sensitivity (S/N = 20dB)	45 μ V

CD player section

Laser diode	GaAlAs (λ =780 nm)
Digital filter (D/A)	8 Times Over Sampling
D/A Converter	1 Bit
Spindle speed	500 – 200 rpm (CLV)
Wow & Flutter	Below Measurable Limit
Frequency response (\pm 1 dB)	10 Hz – 20 kHz
Total harmonic distortion (1 kHz)	0.01 %
Signal to Noise ratio (1 kHz)	96 dB
Dynamic range	93 dB
Channel separation	85 dB

Audio section

Maximum output power	50 W x 4
Full Bandwidth Power (at less than 1% THD)	22 W x 4
Tone action	
Bass :	100 Hz \pm 10 dB
Middle :	1 kHz \pm 10 dB
Treble :	10 kHz \pm 10 dB
Preout level / Load (during disc play)	1800 mV/10 k Ω
Preout impedance (during disc play)	\leq 600 Ω

General

Operating voltage (11 – 16V allowable)	14.4 V
Current consumption	10 A
Installation Size (W x H x D)	182 x 53 x 157 mm 7-3/16 x 2-1/16 x 6-3/16 inch
Weight	3.1 lbs (1.4 kg)

Free Manuals Download Website

<http://myh66.com>

<http://usermanuals.us>

<http://www.somanuals.com>

<http://www.4manuals.cc>

<http://www.manual-lib.com>

<http://www.404manual.com>

<http://www.luxmanual.com>

<http://aubethermostatmanual.com>

Golf course search by state

<http://golfingnear.com>

Email search by domain

<http://emailbydomain.com>

Auto manuals search

<http://auto.somanuals.com>

TV manuals search

<http://tv.somanuals.com>