

KENWOOD

KDC-W4531
KDC-W4031
KDC-W431G
KDC-W409
KDC-3031A
KDC-3031G
KDC-309A
KDC-309G

CD-RECEIVER

INSTRUCTION MANUAL

KENWOOD CORPORATION



CH 01

© B64-2932-00/00 (EW/EN/E2W/E2N)

Contents

Safety precautions	3	Menu system	19
Notes	4	Menu System	
About CDs	5	Security Code	
About MP3 and WMA	6	Touch Sensor Tone	
General features	7	Manual Clock Adjustment	
Power		Synchronize Clock	
Selecting the Source		DSI (Disabled System Indicator)	
Volume		Selectable Illumination	
Attenuator		News Bulletin with Timeout Setting	
System Q		Local Seek	
Audio Control		Tuning Mode	
Audio Setup		AF (Alternative Frequency)	
Speaker Setting		Restricting RDS Region (Region Restrict Function)	
Switching Display		Auto TP Seek	
Dimmer Control		Monaural Reception	
Theft Deterrent Faceplate		Auxiliary Input Display Setting	
TEL Mute		Text Scroll	
		Power OFF Timer	
		CD Read Setting	
		Demonstration mode Setting	
Tuner features	11	Accessories/ Installation Procedure	24
Tuning		Connecting Wires to Terminals	25
Tuning Mode		Installation	27
Station Preset Memory		Removing the Unit	28
Auto Memory Entry		Troubleshooting Guide	29
Preset Tuning		Specifications	32
RDS features	13		
Traffic Information			
Radio Text Scroll			
PTY (Program Type)			
Program Type preset			
Changing Language for PTY Function			
CD/Audio file/External disc control features	16		
Playing CD & Audio file			
Playing External Disc			
Fast Forwarding and Reversing			
Track/File Search			
Disc Search/Folder Search			
Track/File/Disc/Folder Repeat			
Scan Play			
Random Play			
Magazine Random Play			
Folder Select			
Text/Title Scroll			

Safety precautions

⚠WARNING

To prevent injury or fire, take the following precautions:

- To prevent a short circuit, never put or leave any metallic objects (such as coins or metal tools) inside the unit.

⚠CAUTION

To prevent damage to the machine, take the following precautions:

- Make sure to ground the unit to a negative 12V DC power supply.
- Do not install the unit in a spot exposed to direct sunlight or excessive heat or humidity. Also avoid places with too much dust or the possibility of water splashing.
- Do not set the removed faceplate or the faceplate case in areas exposed to direct sunlight, excessive heat or humidity. Also avoid places with too much dust or the possibility of water splashing.
- To prevent deterioration, do not touch the terminals of the unit or faceplate with your fingers.
- Do not subject the faceplate to excessive shock, as it is a piece of precision equipment.
- When replacing a fuse, only use a new one with the prescribed rating. Using a fuse with the wrong rating may cause your unit to malfunction.
- Do not use your own screws. Use only the screws provided. If you use the wrong screws, you could damage the unit.

Do Not Load 8 cm (3 in.) CDs in the CD slot

If you try to load a 8 cm (3 in.) CD with its adapter into the unit, the adapter might separate from the CD and damage the unit.

About CD players/disc changers connected to this unit

KENWOOD disc changers/ CD players released in 1998 or later can be connected to this unit. Refer to the catalog or consult your Kenwood dealer for connectable models of disc changers/ CD players.

Note that any KENWOOD disc changers/ CD players released in 1997 or earlier and disc changers made by other makers cannot be connected to this unit. Unsupported connection may result in damage. Setting the "O-N" Switch to the "N" position for the applicable KENWOOD disc changers/ CD players. The functions that can be used and the information that can be displayed will differ depending on the models being connected.



- You can damage both your unit and the CD changer if you connect them incorrectly.

Lens Fogging

Right after you turn on the car heater in cold weather, dew or condensation may form on the lens in the CD player of the unit. Called lens fogging, CDs may be impossible to play. In such a situation, remove the disc and wait for the condensation to evaporate. If the unit still does not operate normally after a while, consult your Kenwood dealer.

Notes

- If you experience problems during installation, consult your Kenwood dealer.
- If the unit fails to operate properly, press the Reset button. The unit returns to factory settings when the Reset button is pressed.
- Press the reset button if the disc auto changer fails to operate correctly. Normal operation should be restored.

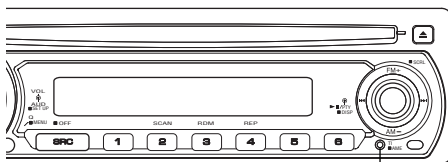

Reset button

- The characters which can be displayed by this unit are A-Z 0-9 @ " ' ` % & * + = , . / \ < > [] () ; : ^ - { } | ~ .
- The illustrations of the display and the panel appearing in this manual are examples used to explain more clearly how the controls are used. Therefore, what appears on the display in the illustrations may differ from what appears on the display on the actual equipment, and some of the illustrations on the display may represent something impossible in actual operation.

Cleaning the Unit

If the faceplate of this unit is stained, wipe it with a dry soft cloth such as a silicon cloth.

If the faceplate is stained badly, wipe the stain off with a cloth moistened with neutral cleaner, then wipe neutral detergent off.



- Applying spray cleaner directly to the unit may affect its mechanical parts. Wiping the faceplate with a hard cloth or using a volatile liquid such as thinner or alcohol may scratch the surface or erase characters.

Cleaning the Faceplate Terminals

If the terminals on the unit or faceplate get dirty, wipe them with a dry, soft cloth.

Before using this unit for the first time

This unit is initially set on the Demonstration mode. When using this unit for the first time, cancel the <Demonstration mode Setting> (page 23).

About DAB Tuner control

(KDC-W4531)

Refer to [A] group on the Instruction manual of DAB Tuner KTC-9090DAB (optional accessory) for the control method of DAB Tuner function.

However, the following control methods of the function for this unit may be differed from the Instruction manual; therefore, refer to the following supplemental instruction.

<Auto Ensemble Memory Entry>

1. Select the preset band for Auto Ensemble Memory Entry.
2. Press the [AME] button for at least 2 seconds. Open Auto Ensemble Memory Entry. After storing in the memory finishes, the number of the pre-set buttons and the ensemble label are displayed.

<Searching by programme type and language> and <Languages to be displayed>

At the operation to press [DISP] button, press [TI] button.

<Automatic Switching DAB priority>

This function cannot be used.

This Product is not installed by the manufacturer of a vehicle on the production line, nor by the professional importer of a vehicle into an EU Member State.

The marking of products using lasers (Except for some areas)

**CLASS 1
LASER PRODUCT**

The label is attached to the chassis/case and says that the component uses laser beams that have been classified as Class 1. It means that the unit is utilizing laser beams that are of a weaker class. There is no danger of hazardous radiation outside the unit.

About CDs

Handling CDs

- Don't touch the recording surface of the CD.



- CD-R and CD-RW are easier to damage than a normal music CD. Use a CD-R or a CD-RW after reading the caution items on the package etc.
- Don't stick tape etc. on the CD.
Also, don't use a CD with tape stuck on it.

When using a new CD

If the CD center hole or outside rim has burrs, use it after removing them with a ball pen etc.

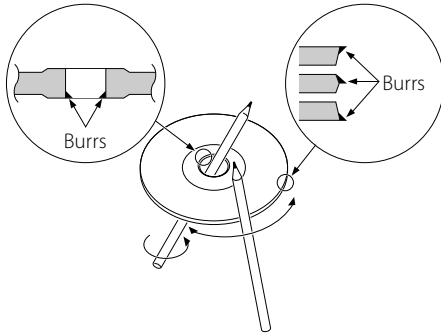

CD accessories

Don't use disc type accessories.

CD cleaning

Clean from the center of the disc and move outward.

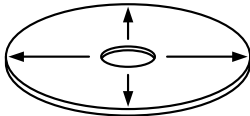

Removing CDs

When removing CDs from this unit pull them out horizontally.

CDs that can't be used

- CDs that aren't round can't be used.

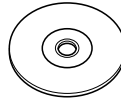

- CDs with coloring on the recording surface or that are dirty can't be used.
- This unit can only play the CDs with



It may not correctly play discs which do not have the mark.

- A CD-R or CD-RW that hasn't been finalized can't be played. (For the finalization process refer to your CD-R/CD-RW writing software, and your CD-R/CD-RW recorder instruction manual.)

CD storage

- Don't place them in direct sunlight (On the seat or dashboard etc.) and where the temperature is high.
- Store CDs in their cases.

About MP3 and WMA

The playable MP3/WMA file (hereafter called Audio file) and the media format has the following limitation. The Audio file, which is out of the specification, may not be able to be played normally, or the file and folder names may not be displayed correctly.

Playable Audio file

- MP3, WMA: KDC-W4531/W4031/W409/W431G



- Attach the correct extension for the Audio file (MP3: ".MP3"; WMA: ".WMA")
- Do not attach the extensions to the other files besides the Audio file. If it is attached, the file, which is not the Audio file, will be played and outputs the loud noise, and then the speaker will be damaged.
- The files with copy protection cannot be played.

Playable MP3 file

- MPEG 1/2 Audio Layer 3 file
- Transfer bit rate: 8-320 kbps
- Sampling frequency
: 8, 11.025, 12, 16, 22.05, 24, 32, 44.1, 48 kHz

Playable WMA file

- The file in accordance with Windows Media Audio (Except for the file for Windows Media Player 9 or after which applies the new functions)
- Transfer bit rate: 48-192 kbps
- Sampling frequency: 32, 44.1, 48 kHz

Playable media

- CD-ROM, CD-R, CD-RW (CD-RW with quick format cannot be used.)



- When recording to the media up to the maximum capacity at once, the writing soft is set to "Disc at once".

Playable disc format

- ISO 9660 Level 1/2
- Joliet
- Romeo
- Long file name.

The maximum number of characters for this unit

File/Folder name: 64 (Joliet: 32) characters

ID3 Tag/Contents property (WMA): 30 characters



- File/Folder name is the number of the characters including the extensions
- ID3 Tag can only display the tag of Ver1.X.

Limitation of structure for the file and the folder

- Maximum number of directory levels: 8
- Maximum number of folders: 50
- Maximum number of files per folder: 255
- Maximum number of files and folders: 512

Playing order of the Audio file

The Audio file is played in the order which is written by writing soft. You may be able to set the playing order by writing the play sequence numbers such as "01" to "99" at the beginning of the file name.

Example

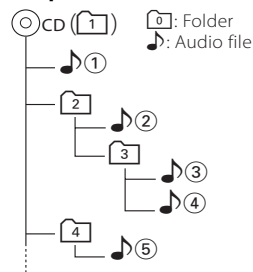

- Playing order after play
 → → → ...
- Forward file search during play (Push the Control knob to)
- Forward folder search during play (Push the Control knob to [FM])
: → ...
- When it is set to directory , skip to the folder before the same level by folder select (Push the Control knob to)
:
- When it is set to directory , makes the level up by folder select (Push the Control knob to [AM])
:

General features

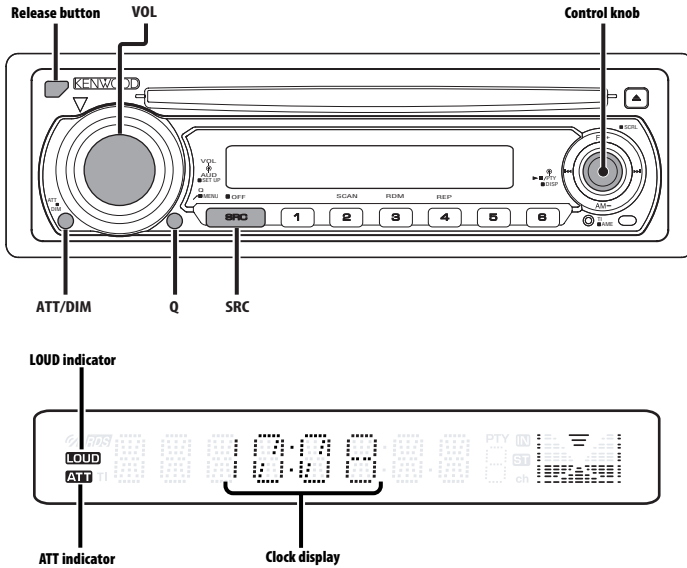

Power

Turning ON the Power

Press the [SRC] button.

Turning OFF the Power

Press the [SRC] button for at least 1 second.

Selecting the Source

Press the [SRC] button.

Source required	Display
Tuner	"TUNER"
CD	"CD"
External disc (Optional accessory)	"CD CH"
Auxiliary input (Optional accessory)	"AUX EXT"
Standby (Illumination only mode)	"STANDBY"



- This unit automatically turns full power OFF after 20 minutes lapses in Standby mode in order to save the vehicles battery.

The time until full power OFF can be set in <Power OFF Timer> (page 23).

Volume

Increasing Volume

Turn the [VOL] knob clockwise.

Decreasing Volume

Turn the [VOL] knob counterclockwise.

Attenuator

Turning the volume down quickly.

Press the [ATT] button.

Each time the button is pressed, the Attenuator turns ON and OFF.

When it's ON, the "ATT" indicator blinks.

General features

System Q

You can recall the best sound setting preset for different types of music.

1 Select the source to set
Press the [SRC] button.

2 Select the Sound type
Press the [Q] button.

Each time the button is pressed, the sound setting switches.

Sound setting	Display
Natural	"NATURAL"
Rock	"ROCK"
Pops	"POPS"
Easy	"EASY"
Top 40	"TOP40"
Jazz	"JAZZ"



- When the System Q setting is changed, the Bass, Middle, and Treble set in audio control replace the System Q values.
- "USER": The values set on the <Audio Control> (page 8).
- Each setting value is changed with the <Speaker Setting> (page 8).
First, select the speaker type with the Speaker setting.

Audio Control

1 Select the source for adjustment
Press the [SRC] button.

2 Enter Audio Control mode
Press the [VOL] knob.

3 Select the Audio item for adjustment
Press the [VOL] knob.

Each time the knob is pressed, the items that can be adjusted switch as shown below.

4 Adjust the Audio item
Turn the [VOL] knob.

Adjustment Item	Display	Range
Bass level	"BAS L"	-8 — +8
Middle level	"MID L"	-8 — +8
Treble level	"TRE L"	-8 — +8
Balance	"BAL"	Left 15 — Right 15
Fader	"FAD"	Rear 15 — Front 15

5 Exit Audio Control mode
Press any button.

Press the button which is not [VOL] knob and [ATT] button.

Audio Setup

Setting the Sound system, such as Volume offset and Loudness.

1 Select the source for adjustment
Press the [SRC] button.

2 Enter Audio Setup mode
Press the [VOL] knob for at least 1 second.

3 Select the Audio Setup item for adjustment
Press the [VOL] knob.

Each time the knob is pressed, the items that can be adjusted switch as shown below.

4 Adjust the Audio setup item
Turn the [VOL] knob.

Adjustment Item	Display	Range
Volume offset	"V-OFF"	-8 — ±0
Loudness	"LOUD"	ON/OFF



- Volume offset: Each source's volume can be set as a difference from the basic volume.
- Loudness: Compensating for low and high tones during low volume.
When it's ON, "LOUD" indicator is ON.

5 Exit Audio Setup mode
Press the [VOL] knob for at least 1 second.

Speaker Setting

Fine-tuning so that the System Q value is optimal when setting the speaker type.

1 Enter Standby
Press the [SRC] button.
Select the "STANDBY" display.

2 Enter Speaker Setting mode
Press the [VOL] knob.

3 Select the Speaker type

Turn the [VOL] knob.

Each time the knob is turned, the setting switches as shown below.

Speaker type	Display
OFF	"SP OFF"
For 5 & 4 in. speaker	"SP 5/4"
For 6x9 & 6 in. speaker	"SP 6x9/6"
For the OEM speaker	"SP OEM"

4 Exit Speaker Setting mode

Press the [VOL] knob.

Switching Display

Switching the information displayed.

1 Enter Switching Display mode

Press the Control knob for at least 1 second.

"DISP SEL" is displayed.

2 Select the Display item

Push the Control knob to [◀◀] or [▶▶]:

In Tuner source (KDC-W431G)

Information	Display
Frequency	"FREQ"
Clock	"CLOCK"

In Tuner source

Information	Display
Program Service name or Frequency	"FREQ"(MW/LW), "FREQ/PS"(FM)
Radio text, Program Service name or Frequency	"R-TEXT"(FM)
Clock	"CLOCK"

The frequency is displayed during Program Service name reception

Press the Control knob for at least 1 second.

The frequency for the RDS station will be displayed for 5 seconds instead of the Program Service name.

In CD source (KDC-3031A/3031G/309A/309G)

Information	Display
Track number & Play time	"P-TIME"
Clock	"CLOCK"

In CD & External disc source (KDC-W4531/W4031/W409/W431G)

Information	Display
Disc title	"D-TITLE"
Track title	"T-TITLE"
Track number & Play time	"P-TIME"
Clock	"CLOCK"

• External disc source: KDC-W4531

In Audio file source (KDC-W4531/W4031/W409/W431G)

Information	Display
Song title & Artist name	"TITLE"
Album name (MP3 only) & Artist name	"ALBUM"
Folder name	"FOLDER"
File name	"FILE"
Track number & Play time	"P-TIME"
Clock	"CLOCK"

In Auxiliary input source

Information	Display
Auxiliary input name	"SRC NAME"
Clock	"CLOCK"

3 Exit Switching Display mode

Press the Control knob.



- If the Disc title, Track title, Song title & Artist name, or Album name & Artist name is selected when the disc which does not have Disc title, Track title, Song title, Album name, or Artist name is played, track number and play time are displayed.

Dimmer Control

You can change the unit's display to dimmer.

Press the [DIM] button for at least 1 second.

Each time the button is pressed for 1 second, the Dimmer control turns ON and OFF.

General features

Theft Deterrent Faceplate

The faceplate of the unit can be detached and taken with you, helping to deter theft.

Removing the Faceplate

Press the Release button.

The faceplate is unlocked, allowing you to detach it.



- The faceplate is a precision piece of equipment and can be damaged by shocks or jolts. For that reason, keep the faceplate in its special storage case while detached.
- Do not expose the faceplate or its storage case to direct sunlight or excessive heat or humidity. Also avoid places with too much dust or the possibility of water splashing.

Reattaching the Faceplate

1 Align the projections on the unit with the grooves on the faceplate.

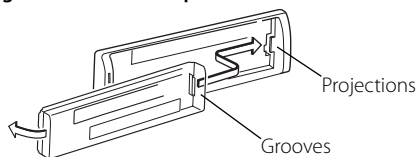

2 Push the faceplate in until it clicks.

The faceplate is locked in place, allowing you to use the unit.

TEL Mute

The audio system automatically mutes when a call comes in.

When a call comes in

"CALL" is displayed.

The audio system pauses.

Listening to the audio during a call

Press the [SRC] button.

The "CALL" display disappears and the audio system comes back ON.

When the call ends

Hang up the phone.

The "CALL" display disappears and the audio system comes back ON.

Tuner features

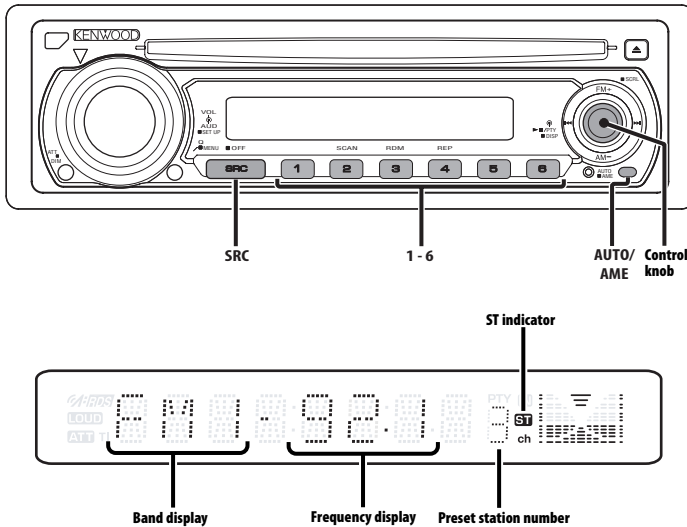

Tuning

Selecting the station.

1 Select tuner source

Press the [SRC] button.

Select the "TUNER" display.

2 Select the band

Push the Control knob to [FM] or [AM].

Each time the knob is pushed to [FM], it switches between the FM1, FM2, and FM3 bands.

3 Tune up or down band

Push the Control knob to [◀◀] or [▶▶].



- During reception of stereo stations the "ST" indicator is ON.

Function of the KDC-W431G

Tuning Mode

Choose the tuning mode.

Press the [AUTO] button.

Each time the button is pressed, the Tuning mode switches as shown below.

Tuning mode	Display	Operation
Auto seek	"AUTO 1"	Automatic search for a station.
Preset station seek	"AUTO 2"	Search in order of the stations in the Preset memory.
Manual	"MANUAL"	Normal manual tuning control.

Station Preset Memory

Putting the station in the memory.

1 Select the band

Push the Control knob to [FM] or [AM].

2 Select the frequency to put in the memory

Push the Control knob to [◀◀] or [▶▶].

3 Put the frequency in the memory

Press the desired [1] — [6] button for at least 2 seconds.

The preset number display blinks 1 time.

On each band, 1 station can be put in the

memory on each [1] — [6] button.

Auto Memory Entry

Putting stations with good reception in the memory automatically.

1 Select the band for Auto Memory Entry

Push the Control knob to [FM] or [AM].

2 Open Auto Memory Entry

Press the [AME] button for at least 2 seconds.

When 6 stations that can be received are put in the memory Auto Memory Entry closes.



- When the <AF (Alternative Frequency)> (page 22) is ON, only RDS stations are put in the memory.
- When Auto Memory Entry is done in the FM2 band, the RDS stations preset in the FM1 band aren't put in the memory.

Likewise, when it is done in the FM3 band, RDS stations preset in FM1 or FM2 aren't put in the memory.

Preset Tuning

Calling up the stations in the memory.

1 Select the band

Push the Control knob to [FM] or [AM].

2 Call up the station

Press the desired [1] — [6] button.

RDS features

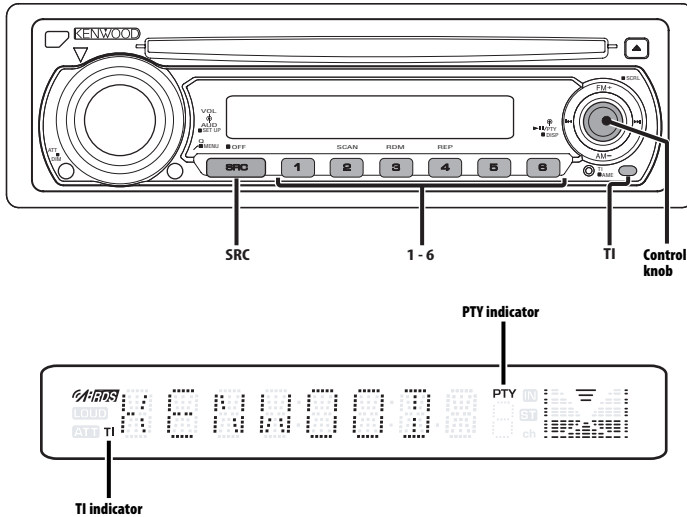

Traffic Information

Switching to traffic information automatically when a traffic bulletin starts even when you aren't listening to the radio.

Press the [TI] button.

Each time the button is pressed, the Traffic information function turns ON and OFF.

When it's ON, "TI" indicator is ON.

When a traffic information station isn't being received the "TI" indicator blinks.

When a traffic bulletin starts, "TRAFFIC" is displayed it and it switches to traffic information.



- During reception of an AM station when the Traffic Information function is turned ON, it switches to an FM station.
- During reception of traffic information the adjusted volume is automatically remembered, and the next time it switches to traffic information it's automatically the remembered volume.

Receiving other traffic information stations

Push the Control knob to [◀◀] or [▶▶].



- Traffic information station can be switched when it is on the Tuner Source or switched from the Tuner Source during the reception of the Traffic bulletin.

Radio Text Scroll

Scrolling the displayed radio text.

Hold down on [FM] of the Control knob for at least 1 second.

RDS features

PTY (Program Type)

Selecting the Program Type and searching for a station.

1 Enter PTY mode

Press the Control knob.

During PTY mode the "PTY" indicator is ON.



- This function can't be used during a traffic bulletin or AM reception.

2 Select the Program Type

Push the Control knob to [FM] or [AM].

Each time the knob is pushed, the Program Type switches as shown below.

No.	Program Type	Display
1.	Speech	"SPEECH"
2.	News	"NEWS"
3.	Current Affairs	"AFFAIRS"
4.	Information	"INFO"
5.	Sport	"SPORT"
6.	Education	"EDUCATE"
7.	Drama	"DRAMA"
8.	Culture	"CULTURE"
9.	Science	"SCIENCE"
10.	Varied	"VARIED"
11.	Pop Music	"POP M"
12.	Rock Music	"ROCK M"
13.	Easy Listening Music	"EASY M"
14.	Light Classical	"LIGHT M"
15.	Serious Classical	"CLASSICS"
16.	Other Music	"OTHER M"
17.	Weather	"WEATHER"
18.	Finance	"FINANCE"
19.	Children's programs	"CHILDREN"
20.	Social Affairs	"SOCIAL"
21.	Religion	"RELIGION"
22.	Phone In	"PHONE IN"
23.	Travel	"TRAVEL"
24.	Leisure	"LEISURE"
25.	Jazz Music	"JAZZ"
26.	Country Music	"COUNTRY"
27.	National Music	"NATION M"
28.	Oldies Music	"OLDIES"
29.	Folk Music	"FOLK M"
30.	Documentary	"DOCUMENT"
31.	Music	"MUSIC"



- Speech and Music include the Program type shown below.
Music: No.11 — 16, 25 — 29
Speech: No.2 — 10, 17 — 24, 30
- The Program Type can be put in the [1] — [6] button memory and called up quickly. Refer to the <Program Type preset> (page 14).
- The display language can be changed. Refer to <Changing Language for PTY Function> (page 15).

3 Search for the selected Program Type station

Push the Control knob to [◀◀] or [▶▶].

When you want to search for other stations, push [◀◀] or [▶▶] of the Control knob again.



- When the selected Program Type isn't found, "NO PTY" is displayed. Select another Program Type.

4 Exit PTY mode

Press the Control knob.

Program Type preset

Putting the Program Type in the Preset button memory and calling it up quickly.

Presetting the Program Type

1 Select the Program Type to preset

Refer to <PTY (Program Type)> (page 14).

2 Preset the Program Type

Press the desired [1] — [6] button for at least 2 seconds.

Calling up the preset Program Type

1 Enter PTY mode

Refer to <PTY (Program Type)> (page 14).

2 Call up the Program Type

Press the desired [1] — [6] button.

Changing Language for PTY Function

Selecting the Program Type display language.

1 Enter PTY mode

Refer to <PTY (Program Type)> (page 14).

2 Enter Changing Language mode Press the [TI] button.

3 Select the language

Push the Control knob to [FM] or [AM].

Each time the knob is pushed, the language switches as shown below.

Language	Display
English	"ENGLISH"
French	"FRENCH"
German	"GERMAN"

4 Exit Changing Language mode Press the [TI] button.

CD/Audio file/External disc control features

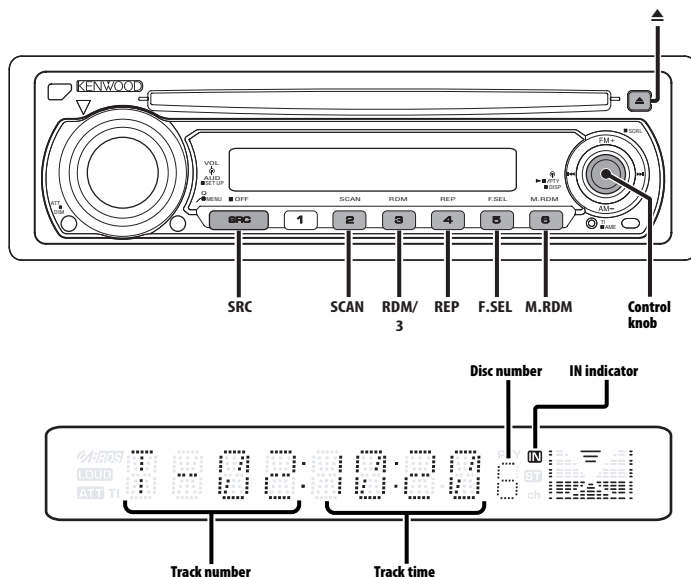

Playing CD & Audio file

When a disc is inserted

Press the [SRC] button.

Select the "CD" display.



- When a CD is inserted, the "IN" indicator is ON.

Pause and play

Press the control knob.

Each time the knob is pressed, it pauses and plays.

Eject the CD

Press the [▲] button.



- Refer to <Playable Audio file> (page6) for the Audio file by models which can be played.

Function of the KDC-W4531

Playing External Disc

Playing discs set in the optional accessory disc player connected to this unit.

Press the [SRC] button.

Select the display for the disc player you want.

Display examples:

Display	Disc player
"CD CH"	CD changer
"MD CH"	MD changer

Pause and play

Press the Control knob.

Each time the knob is pressed, it pauses and plays.



- Disc 10 is displayed as "0".
- The functions that can be used and the information that can be displayed will differ depending on the external disc players being connected.

Fast Forwarding and Reversing

Fast Forwarding

Hold down on [▶▶] of the Control knob.

Release your finger to play the disc at that point.

Reversing

Hold down on [◀◀] of the Control knob.

Release your finger to play the disc at that point.



- The sound is not output while the Audio file is played.

Track/File Search

Searching for a song on the disc or in the Audio file folder.

Push the Control knob to [◀◀] or [▶▶].

Function of disc changer/ Audio file

Disc Search/Folder Search

Selecting the disc set in the Disc changer or the folder recorded on the Audio file media.

Push the Control knob to [AM] or [FM].

Track/File/Disc/Folder Repeat

Replaying the song, disc in the Disc changer or Audio file folder you're listening to.

Press the [REP] button.

Each time the button is pressed, the Repeat Play switches as shown below.

In CD & External disc source

Repeat play	Display
Track Repeat	"TRAC REP"
Disc Repeat (In Disc Changer)	"DISC REP"
OFF	"REP OFF"

In Audio file source

Repeat play	Display
File Repeat	"FILE REP"
Folder Repeat	"FOLD REP"
OFF	"REP OFF"

Scan Play

Playing the first part of each song on the disc you are listening to and searching for the song you want to listen to.

1 Start Scan Play

Press the [SCAN] button.

"TRAC SCN" (CD), "FILE SCN" (Audio file) is displayed.

2 Release it when the song you want to listen to is played

Press the [SCAN] button.

Random Play

Playing all the songs on the disc in random order.

Press the [RDM] button.

Each time the button is pressed, Random Play turns ON and OFF.

When it's ON, "DISC RDM" (CD), "FOLD RDM" (Audio file) is displayed.



- When the Control knob is pushed to [▶▶], the next song select starts.

Function of disc changer

Magazine Random Play

Play the songs on all the discs in the disc changer in random order.

Press the [M.RDM] button.

Each time the button is pressed, the Magazine Random Play turns ON and OFF.

When it's ON, "MGZN RDM" is displayed.



- When the Control knob is pushed to [▶▶], the next song select starts.

CD/Audio file/External disc control features

Function of the KDC-W4531/W4031/W409/W431G
Function of Audio file

Folder Select

Quickly selecting the folder you want to listen to.

1 Enter Folder Select mode

Press the [F.SEL] button.

"F-SELECT" is displayed.

During Select mode the folder information is displayed as shown below.

Folder name display

Displays the current folder name.



2 Select the folder level

Push the Control knob to [FM] or [AM].

With the [FM] of the Control knob, you move 1 level down and with the [AM] of the Control knob 1 level up.

Selecting a folder in the same level

Push the Control knob to [◀◀] or [▶▶].

With the [◀◀] of the Control knob, you move to the previous folder, and with the [▶▶] of the Control knob to the next folder.

Returning to the top level

Press the [3] button.

3 Decide the folder to play

Press the Control knob.

The Folder Select mode releases, and the MP3/WMA in the folder being displayed is played.

Canceling the Folder Select mode

Press the [F.SEL] button.

Text/Title Scroll

Scrolling the displayed CD text, Audio file text, or MD title.

Hold down on [FM] of the Control knob for at least 1 second.

Menu system

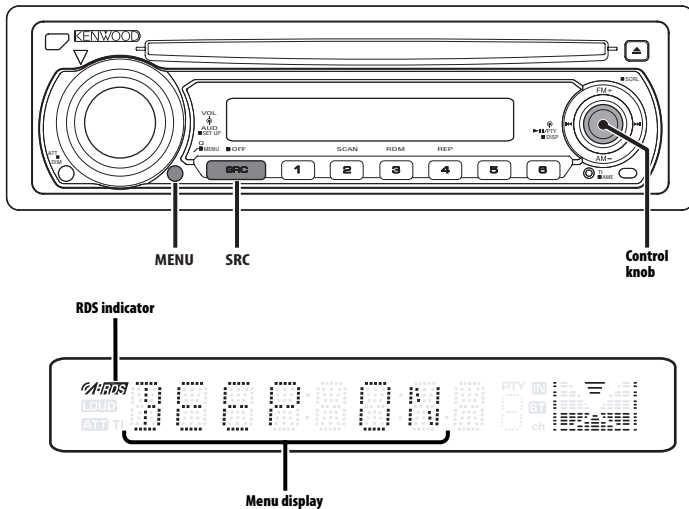

Menu System

Setting during operation beep sound etc. functions.

The Menu system basic operation method is explained here. The reference for the Menu items and their setting content is after this operation explanation.

1 Enter Menu mode

Press the [MENU] button for at least 1 second.

"MENU" is displayed.

2 Select the menu item

Push the Control knob to [FM] or [AM].

Example: When you want to set the beep sound select the "BEEP" display.

3 Set the menu item

Push the Control knob to [◀◀] or [▶▶].

Example: When "BEEP" is selected, each time the knob is pushed it switches "BEEP ON" or "BEEP OFF". Select 1 of them as the setting.

You can continue by returning to step 2 and setting other items.

4 Exit Menu mode

Press the [MENU] button.



- When other items that are applicable to the basic operation method above are displayed, afterwards their setting content chart is entered. (Normally the uppermost setting in the chart is the original setting.) Also, the explanation for items that aren't applicable (<Manual Clock Adjustment> etc.) are entered step by step.

Menu system

Function of the KDC-W4531
In Standby mode

Security Code

Because authorization by the Security Code is required when it's removed from the vehicle, personalizing this unit is by using the Security Code is a help in preventing theft.



- When the Security Code function is activated, it can't be released.
Note, your Security Code is the 4 digit number entered in your "Car Audio Passport" in this package.

1 Enter Standby

Press the [SRC] button.

Select the "STANDBY" display.

2 Enter Menu mode

Press the [MENU] button for at least 1 second.

When "MENU" is displayed, "SECURITY" is displayed.

3 Enter Security Code mode

Press the Control knob for at least 2 seconds.

When "ENTER" is displayed, "CODE" is displayed.

4 Select the digits to enter

Push the Control knob to [◀◀] or [▶▶].

5 Select the Security Code numbers

Push the Control knob to [FM] or [AM].

6 Repeat steps 4 and 5, and complete the Security Code.

7 Confirm the Security Code

Press the Control knob for at least 3 seconds.

When "RE-ENTER" is displayed, "CODE" is displayed.

8 Do the step 4 through 7 step operation, and reenter the security code.

"APPROVED" is displayed.

The Security Code function activates.



- If you enter a Code different from your Security Code, you have to start over from step 4.

Press the Reset button and when it's removed from the battery power source

1 Turn the power ON.

2 Do the step 4 through 7 step operation, and reenter the security code.

"APPROVED" is displayed.

The unit can be used.



- If an incorrect code is input, "WAITING" is displayed, and the input prohibited time shown below is generated.
After the input prohibited time lapses, "CODE" is displayed, and input can be done.

Number of times the incorrect code was input	Input prohibited time
1	—
2	5 minutes
3	1 hour
4	24 hours

In Standby mode

Touch Sensor Tone

Setting the operation check sound (beep sound) ON/OFF.

Display	Setting
"BEEP ON"	Beep is heard.
"BEEP OFF"	Beep canceled.

In Standby mode

Manual Clock Adjustment



- This adjustment can be done when the <Synchronize Clock> (page 21) is set as OFF (KDC-W4531/W4031/W409/3031A/3031G/309A/309G).

1 Select Clock Adjustment mode

Push the Control knob to [FM] or [AM].

Select the "CLK ADJ" display.

2 Enter Clock Adjust mode

Press the Control knob for at least 2 seconds.

The clock display blinks.

3 Adjust the hours

Push the Control knob to [FM] or [AM].

Adjust the minutes

Push the Control knob to [◀◀] or [▶▶].

4 Exit Clock adjustment mode

Press the Control knob.

Function of the KDC-W4531/W4031/W409/3031A/
3031G/309A/309G
In Standby mode

Synchronize Clock

Synchronizing the RDS station time data and this unit's clock.

Display	Setting
"SYNC ON"	Synchronizes the time.
"SYNC OFF"	Adjust the time manually.



- It takes 3 to 4 minutes to synchronize the clock.

In Standby mode

DSI (Disabled System Indicator)

A red indicator will blink on the unit after the faceplate is removed, warning potential thieves.

Display	Setting
"DSI ON"	LED flashes.
"DSI OFF"	LED OFF.

Function of the KDC-W4531/W4031/W409
In Standby mode

Selectable Illumination

Selecting the button illumination color as green or red.

Display	Setting
"KEY RED"	The illumination color is red.
"KEY GRN"	The illumination color is green.

Function of the KDC-W4531/W4031/W409/3031A/
3031G/309A/309G

News Bulletin with Timeout Setting

It switches automatically when a news bulletin starts even if the radio isn't being listened to. Also, the time interval when interrupt is prohibited can be set.

Display and Setting

"NEWS OFF"
"NEWS 00M"
⋮
"NEWS 90M"

When "NEWS 00M" — "NEWS 90M" is set, the News Bulletin Interrupt function is ON. When it's ON, the "NEWS" is displayed. When the news bulletin starts, "NEWS" is displayed, and it switches to the news bulletin.



- If you choose the "20M" setting, further news bulletins will not be received for 20 minutes once the first news bulletin is received.
- The news bulletin volume is the same level that was set for <Traffic Information> (page 13).
- This function is only available if the desired station sends PTY-code for news bulletin or belongs to <Enhanced Other Network>-Network sending PTY-code for news bulletin.
- When the News Bulletin Interrupt function is ON, it switches to an FM station.

In Tuner mode

Local Seek

Only stations whose reception is good are searched for in auto seek tuning.

Display	Setting
"LO.S OFF"	The local seek function is OFF.
"LO.S ON"	The local seek function is ON.

Function of the KDC-W4531/W4031/W409/3031A/
3031G/309A/309G

In Tuner mode

Tuning Mode

Sets the tuning mode.

Tuning mode	Display	Operation
Auto seek	"AUTO 1"	Automatic search for a station.
Preset station seek	"AUTO 2"	Search in order of the stations in the Preset memory.
Manual	"MANUAL"	Normal manual tuning control.

Menu system

Function of the KDC-W4531/W4031/W409/3031A/3031G/309A/309G

AF (Alternative Frequency)

When poor reception is experienced, automatically switch to another frequency broadcasting the same program in the same RDS network with better reception.

Display	Setting
"AF ON"	The AF function is ON.
"AF OFF"	The AF function is OFF.

When the AF function is ON, the "RDS" indicator is ON.



- When no other stations with stronger reception are available for the same program in the RDS network, you may hear the incoming broadcast in bits and snatches. Turn OFF the AF function in such a case.

Function of the KDC-W4531/W4031/W409/3031A/3031G/309A/309G

Restricting RDS Region (Region Restrict Function)

You can choose whether or not to restrict the RDS channels, received with the AF function for a particular network, to a specific region.

Display	Setting
"REG ON"	The Region Restrict Function is ON.
"REG OFF"	The Region Restrict Function is OFF.



- Without restricting AF function to the specified region and network, it sets up to search the station with good reception in the same RDS network.

Function of the KDC-W4531/W4031/W409/3031A/3031G/309A/309G

Auto TP Seek

When the TI function is ON and poor reception conditions are experienced when listening to a traffic information station, another traffic information station with better reception will be searched for automatically.

Display	Setting
"ATPS ON"	The Auto TP Seek Function is ON.
"ATPS OFF"	The Auto TP Seek Function is OFF.

In FM reception

Monaural Reception

Noise can be reduced when stereo broadcasts are received as monaural.

Display	Setting
"MONO OFF"	The monaural reception is OFF.
"MONO ON"	The monaural reception is ON.

Function of the KDC-W4531

Auxiliary Input Display Setting

For selecting the display when switched to Auxiliary input source.

- 1 Select Auxiliary input source**
Press the [SRC] button.
Select the "AUX EXT" display.
- 2 Enter Menu mode**
Press the [MENU] button for at least 1 second.
"MENU" is displayed.
- 3 Select Auxiliary input display setting mode**
Push the Control knob to [FM] or [AM].
Select the "NAME SET" display.
- 4 Enter Auxiliary input display setting mode**
Press the Control knob for at least 2 seconds.
The presently selected Auxiliary input display is displayed.
- 5 Select the Auxiliary input display**
Push the Control knob to [◀◀] or [▶▶].
Each time the knob is pushed, the display switches as shown below.
 - "AUX EXT"
 - "TV"
 - "DVD"
 - "VIDEO"
 - "GAME"
 - "PORTABLE"
- 6 Exit Auxiliary input display setting mode**
Press the [MENU] button.



- When operation stops for 10 seconds, the name at that time is registered, and the Auxiliary input display setting mode closes.

Text Scroll

Setting the displayed text scroll.

Display	Setting
"SCL MANU"	Doesn't scroll.
"SCL AUTO"	Scrolls when the display changes.



- The text scrolled is shown below.
 - CD text
 - Folder name/ File name/ Song title/ Artist name/ Album name
 - MD title
 - Radio text

In Standby mode

Power OFF Timer

Setting the timer to turn this unit's power OFF automatically when Standby mode continues. Using this setting can save the vehicle's battery power.

Display	Setting
"OFF ---"	Power OFF Timer function is OFF.
"OFF 20M" (Original setting)	Turns the power OFF after 20 minutes.
"OFF 40M"	Turns the power OFF after 40 minutes.
"OFF 60M"	Turns the power OFF after 60 minutes.



- This setting is done after setting <Security Code> (page 20).

*Function of the KDC-W4531/W4031/W409/W431G
In Standby mode*

CD Read Setting

When there is a problem on playing a CD with special format, this setting play the CD by force.

Display	Setting
"CD READ1"	Play CD and MP3/WMA.
"CD READ2"	Play CD by force.



- Setting "CD READ2" cannot play MP3/WMA. Some music CDs may not be played back even in the "CD READ2" mode.

In Standby mode

Demonstration mode Setting

Sets the demonstration mode.

1 Select the Demonstration mode

Push the Control knob to [FM] or [AM].

Select the "DEMO" display.

2 Set the Demonstration mode

Press the Control knob for at least 2 seconds.

Each time the knob is pressed at least 2 seconds, the Demonstration mode switches as shown below.

Display	Setting
"DEMO ON"	The Demonstration mode function is ON.
"DEMO OFF"	Exit Demonstration mode (Normal mode).

Accessories/ Installation Procedure

Accessories

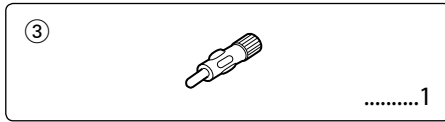
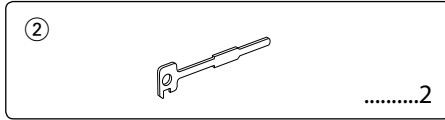
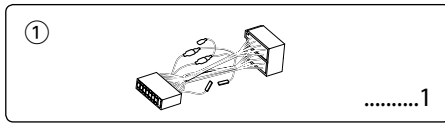

Installation Procedure

1. To prevent short circuits, remove the key from the ignition and disconnect the ⊖ terminal of the battery.
2. Make the proper input and output wire connections for each unit.
3. Connect the wire on the wiring harness.
4. Take Connector B on the wiring harness and connect it to the speaker connector in your vehicle.
5. Take Connector A on the wiring harness and connect it to the external power connector on your vehicle.
6. Connect the wiring harness connector to the unit.
7. Install the unit in your car.
8. Reconnect the ⊖ terminal of the battery.
9. Press the reset button.



- If the power is not turned ON (or it is ON, but will be OFF immediately), the speaker wire may have a short-circuit or touched the chassis of the vehicle and the protection function may have been activated. Therefore, the speaker wire should be checked.
- If your car is not prepared for this special connection-system, consult your Kenwood dealer.
- Only use antenna conversion adapters (ISO-JASO) when the antenna cord has an ISO plug.
- Make sure that all wire connections are securely made by inserting jacks until they lock completely.

- If your vehicle's ignition does not have an ACC position, or if the ignition wire is connected to a power source with constant voltage such as a battery wire, the power will not be linked with the ignition (i.e., it will not turn on and off along with the ignition). If you want to link the unit's power with the ignition, connect the ignition wire to a power source that can be turned on and off with the ignition key.
- If the fuse blows, first make sure that the wires have not caused a short circuit, then replace the old fuse with one with the same rating.
- Insulate unconnected wires with vinyl tape or other similar material. To prevent short circuits, also do not remove the caps on the ends of the unconnected wires or the terminals.
- Connect the speaker wires correctly to the terminals to which they correspond. The unit may receive damage or fail to work if you share the ⊖ wires and/or ground them to any metal part in the car.
- After the unit is installed, check whether the brake lamps, indicators, wipers, etc. on the car are working properly.
- If the console has a lid, make sure to install the unit so that the faceplate does not hit the lid when closing and opening.
- Mount the unit so that the mounting angle is 30° or less.

Connecting Wires to Terminals

	KDC-W4531	KDC-W4031/ W409/3031A/ 3031G/309A/309G	KDC-W431G
A	To Steering remote	To Steering remote	—
B	To KENWOOD disc changer/ External optional accessory	—	—

To connect these leads, refer to the relevant instruction manuals.

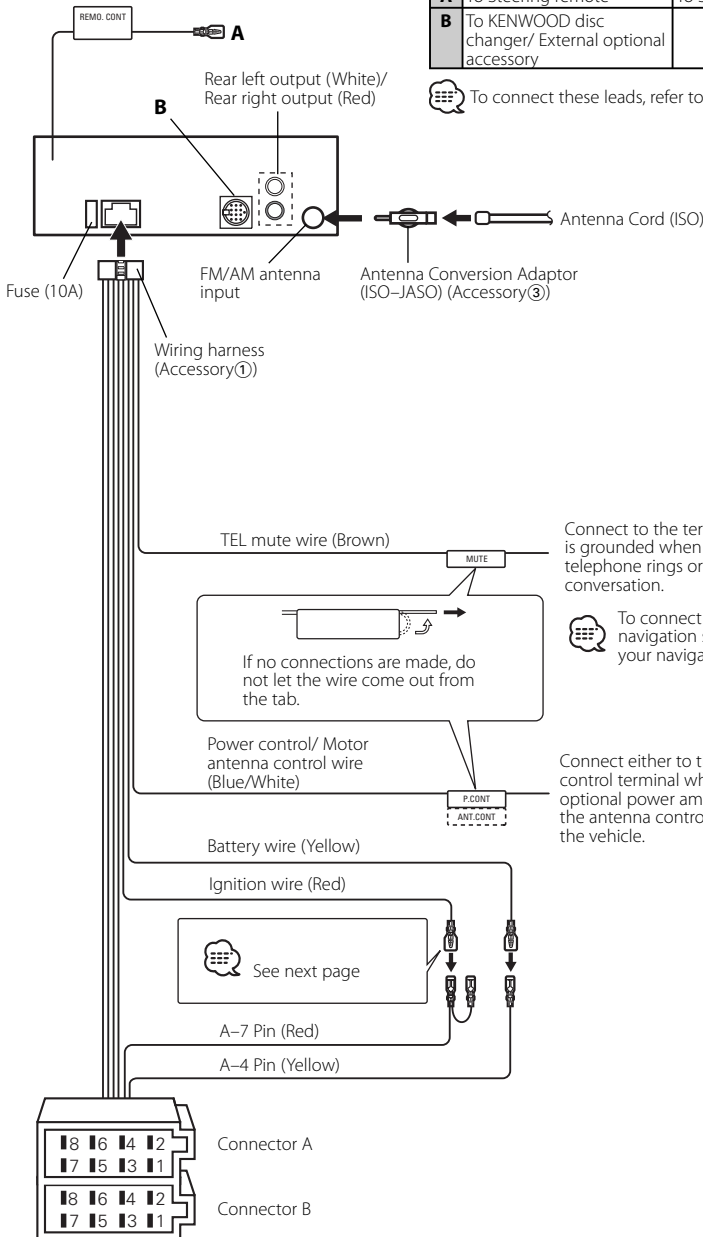

Connect to the terminal that is grounded when either the telephone rings or during conversation.

To connect the KENWOOD navigation system, consult your navigation manual.

Connect either to the power control terminal when using the optional power amplifier, or to the antenna control terminal in the vehicle.

Connecting Wires to Terminals

Connector Function Guide

Pin Numbers for ISO Connectors	Cable Colour	Functions
External Power Connector		
A-4	Yellow	Battery
A-5	Blue/White	Power Control
A-7	Red	Ignition (ACC)
A-8	Black	Earth (Ground) Connection
Speaker Connector		
B-1	Purple	Rear Right (+)
B-2	Purple/Black	Rear Right (-)
B-3	Gray	Front Right (+)
B-4	Gray/Black	Front Right (-)
B-5	White	Front Left (+)
B-6	White/Black	Front Left (-)
B-7	Green	Rear Left (+)
B-8	Green/Black	Rear Left (-)

▲WARNING

Connecting the ISO Connector

The pin arrangement for the ISO connectors depends on the type of vehicle you drive. Make sure to make the proper connections to prevent damage to the unit. The default connection for the wiring harness is described in [1] below. If the ISO connector pins are set as described in [2] or [3], make the connection as illustrated. Please be sure to reconnect the cable as shown [2] below to install this unit to the **Volkswagen** vehicles etc.

[1] (Default setting) The A-7 pin (red) of the vehicle's ISO connector is linked with the ignition, and the A-4 pin (yellow) is connected to the constant power supply.

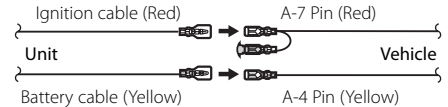

[2] The A-7 pin (red) of the vehicle's ISO connector is connected to the constant power supply, and the A-4 pin (yellow) is linked to the ignition.

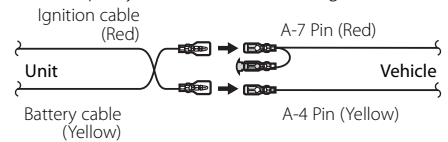

[3] The A-4 pin (yellow) of the vehicle's ISO connector is not connected to anything, while the A-7 pin (red) is connected to the constant power supply (or both the A-7 (red) and A-4 (yellow) pins are connected to the constant power supply).

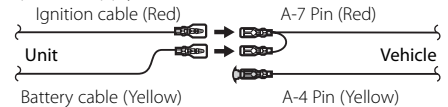

- When the connection is made as in [3] above, the unit's power will not be linked to the ignition key. For that reason, always make sure to turn off the unit's power when the ignition is turned off. To link the unit's power to the ignition, connect the ignition cable (ACC...red) to a power source that can be turned on and off with the ignition key.

Installation

Installation

Metal mounting strap
(commercially available)

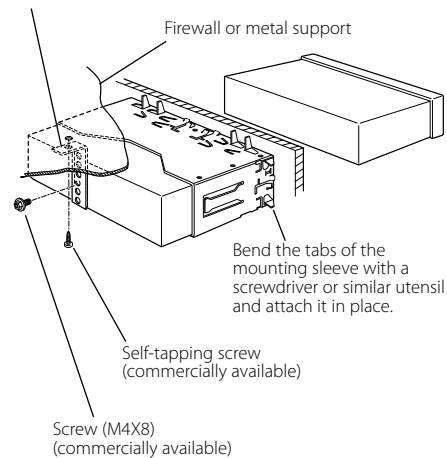

- Make sure that the unit is installed securely in place. If the unit is unstable, it may malfunction (for example, the sound may skip).

Removing the Unit

Removing the hard rubber frame

- 1 Engage the catch pins on the removal tool and remove the two locks on the upper level. Upper the frame and pull it forward as shown in the figure.

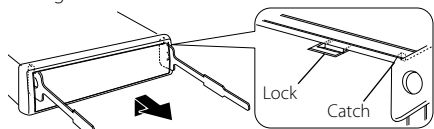

Accessory②
Removal tool

- 2 When the upper level is removed, remove the lower two locations.

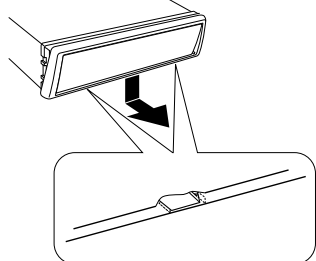

- The frame can be removed from the bottom side in the same manner.

Removing the Unit

- 1 Refer to the section <Removing the hard rubber frame> (page 28) and then remove the hard rubber frame.
- 2 Remove the screw (M4 × 8) on the back panel.
- 3 Insert the two removal tools deeply into the slots on each side, as shown.

Screw (M4X8)
(commercially available)

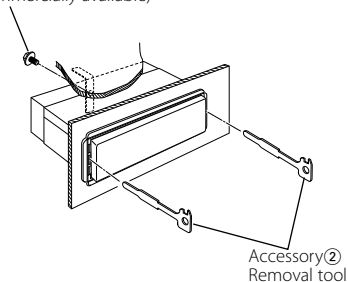

- 4 Lower the removal tool toward the bottom, and pull out the unit halfway while pressing towards the inside.

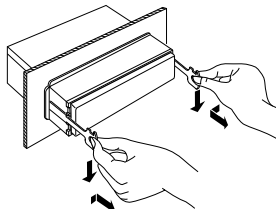

- Be careful to avoid injury from the catch pins on the removal tool.

- 5 Pull the unit all the way out with your hands, being careful not to drop it.

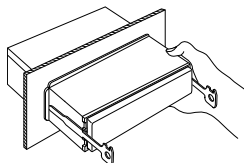

Troubleshooting Guide

What might seem to be a malfunction in your unit may just be the result of slight misoperation or miswiring. Before calling service, first check the following table for possible problems.

General

? The power does not turn ON.

- ✓ The fuse has blown.
 - ⓘ After checking for short circuits in the wires, replace the fuse with one with the same rating.
- ✓ The speaker wire has a short-circuit or touches the chassis of the vehicle, and then the protection function is activated.
 - ⓘ Wire or insulate the speaker cable properly and press the reset button.

? There's a source you can't switch.

- ✓ There's no media inserted.
 - ⓘ Set the media you want to listen to. If there's no media in this unit, you can't switch to each source.
- ✓ The Disc changer isn't connected.
 - ⓘ Connect the Disc changer. If the Disc changer isn't connected to its input terminal, You can't switch to an external disc source.

? The memory is erased when the ignition is turned OFF.

- ✓ The ignition and battery wire are incorrectly connected.
 - ⓘ Connect the wire correctly, referring to the section on <Connecting Wires to Terminals>.

? The TEL mute function does not work.

- ✓ The TEL mute wire is not connected properly.
 - ⓘ Connect the wire correctly, referring to the section on <Connecting Wires to Terminals>.

? The TEL mute function turns ON even though the TEL mute wire is not connected.

- ✓ The TEL mute wire is touching a metal part of the car.
 - ⓘ Pull the TEL mute wire away from the metal part of the car.

? Even if Loudness is turned ON, high-pitched tone isn't compensated for.

- ✓ Tuner source is selected.
 - ⓘ High-pitched tone isn't compensated for when in Tuner source.

? No sound can be heard, or the volume is low.

- ✓ The fader or balance settings are set all the way to one side.
 - ⓘ Center the fader and balance settings.
- ✓ The input/output wires or wiring harness are connected incorrectly.
 - ⓘ Reconnect the input/output wires or the wiring harness correctly. See the section on <Connecting Wires to Terminals>.
- ✓ The values of Volume offset are low.
 - ⓘ Turn up the Volume offset, referring to the section on <Audio Setup> (page 8).

? The sound quality is poor or distorted.

- ✓ One of the speaker wires is being pinched by a screw in the car.
 - ⓘ Check the speaker wiring.
- ✓ The speakers are not wired correctly.
 - ⓘ Reconnect the speaker wires so that each output terminal is connected to a different speaker.

? The Touch Sensor Tone doesn't sound.

- ✓ The preout jack is being used.
 - ⓘ The Touch Sensor Tone can't be output from the preout jack.

? Even though Synchronize Clock is ON, the clock can't be adjusted.

- ✓ The received RDS station isn't sending time data.
 - ⓘ Receive another RDS station.

Tuner source

? Radio reception is poor.

- ✓ The car antenna is not extended.
 - ⓘ Pull the antenna out all the way.
- ✓ The antenna control wire is not connected.
 - ⓘ Connect the wire correctly, referring to the section on <Connecting Wires to Terminals>.

Disc source

? "AUX EXT" is displayed without achieving External disc control mode.

- ✓ Unsupported disc changer is connected.
 - ☞ Use the disc changer mentioned in the <About CD players/disc changers connected to this unit> (page 3) of the section on <Safety precautions>.

? The specified disc does not play, but another one plays instead.

- ✓ The specified CD is quite dirty.
 - ☞ Clean the CD.
- ✓ The disc is loaded in a different slot from that specified.
 - ☞ Eject the disc magazine and check the number for the specified disc.
- ✓ The disc is severely scratched.
 - ☞ Try another disc instead.

? A CD ejects as soon as it is loaded.

- ✓ The CD is quite dirty.
 - ☞ Clean the CD, referring to the CD cleaning of the section on <About CDs> (page 5).

? Can't remove disc.

- ✓ The cause is that more than 10 minutes has elapsed since the vehicle ACC switch was turned OFF.
 - ☞ The disc can only be removed within 10 minutes of the ACC switch being turned OFF. If more than 10 minutes has elapsed, turn the ACC switch ON again and press the Eject button.

? The disc won't insert.

- ✓ There's already another disc inserted.
 - ☞ Press the [▲] button and remove the disc.

? Direct Search can't be done.

- ✓ Another function is ON.
 - ☞ Turn Random Play or other functions OFF.

? Track Search can't be done.

- ✓ For the discs/folders first or last song.
 - ☞ For each disc/folder, Track Search can't be done in the backward direction for the first song or in the forward direction for the last song.

MP3/WMA source

? Cannot play an MP3/WMA.

- ✓ The media is scratched or dirty.
 - ☞ Clean the media, referring to the CD cleaning of the section on <About CDs> (page 5).

? The sound skips when an MP3/WMA is being played.

- ✓ The media is scratched or dirty.
 - ☞ Clean the media, referring to the CD cleaning of the section on <About CDs> (page 5).
- ✓ The recording condition is bad.
 - ☞ Record the media again or use another media.

? The MP3/WMA track time isn't displayed correctly.

- ✓ ---
 - ☞ There are times when it isn't displayed correctly according to the MP3/WMA recording conditions.

If the following situations, consult your nearest service center:

Even though the disc changer is connected, the Disc Changer source is not ON, with "AUX EXT" showing in the display during the Changer Mode.

The messages shown below display your systems condition.

EJECT:	No disc magazine has been loaded in the changer. The disc magazine is not completely loaded. ↻ Load the disc magazine properly. No CD in the unit. ↻ Insert the CD.
NO DISC:	No disc has been loaded in the disc magazine. ↻ Load a disc into the disc magazine.
TOC ERR:	No disc has been loaded in the disc magazine. ↻ Load a disc into the disc magazine. The CD is quite dirty. The CD is upside-down. The CD is scratched a lot. ↻ Clean the CD and load it correctly.
E-05:	The CD is upside-down. ↻ Load the CD correctly.
BLANK:	Nothing has been recorded on the MD.
NO TRACK:	No tracks are recorded on the MD, although it has a title.
E-15:	Media was played that doesn't have data recorded that the unit can play. ↻ Use media that has data recorded that the unit can play.
NO PANEL:	The faceplate of the slave unit being connected to this unit has been removed. ↻ Replace it.
E-99:	Something is wrong with the disc magazine. Or the unit is malfunctioning for some reason. ↻ Check the disc magazine. And then press the reset button on the unit. If the "E-99" code does not disappear, consult your nearest service center.
HOLD:	The protective circuit in the unit activates when the temperature inside the automatic disc changer exceeds 60°C (140°F), stopping all operation. ↻ Cool down the unit by opening the windows or turning on the air conditioner. As the temperature falls below 60°C (140°F), the disc will start playing again.
LOAD:	Discs are being exchanged in the Disc changer.
READING:	The unit is reading the data on the disc.

IN (Blink):	The CD player section is not operating properly. ↻ Reinsert the CD. If the CD cannot be ejected or the display continues to flash even when the CD has been properly reinserted, please switch off the power and consult your nearest service center.
NA FILE:	A MP3/WMA is played with a format that this unit can't support. ↻ ----
COPY PRO:	A copy-protected file is played. ↻ ----

Specifications

Specifications subject to change without notice.

FM tuner section

Frequency range (50 kHz space)
: 87.5 MHz – 108.0 MHz
Usable sensitivity (S/N = 26dB)
: 0.7 μ V /75 Ω
Quieting Sensitivity (S/N = 46dB)
: 1.6 μ V /75 Ω
Frequency response (\pm 3.0 dB)
: 30 Hz – 15 kHz
Signal to Noise ratio (MONO)
: 65 dB
Selectivity (DIN) (\pm 400 kHz)
: \geq 80 dB
Stereo separation (1 kHz)
: 35 dB

MW tuner section

Frequency range (9 kHz space)
: 531 kHz – 1611 kHz
Usable sensitivity (S/N = 20dB)
: 25 μ V

LW tuner section

Frequency range
: 153 kHz – 281 kHz
Usable sensitivity (S/N = 20dB)
: 45 μ V

CD player section

Laser diode
: GaAlAs
Digital filter (D/A)
: 8 Times Over Sampling
D/A Converter
: 1 Bit
Spindle speed
: 500 – 200 rpm (CLV)
Wow & Flutter
: Below Measurable Limit
Frequency response (\pm 1 dB)
: 10 Hz – 20 kHz
Total harmonic distortion (1 kHz)
: 0.01 %
Signal to Noise ratio (1 kHz)
KDC-W4531/W4031/W409/W431G: 105 dB
KDC-3031A/3031G/309A/309G: 93 dB
Dynamic range
: 93 dB
Channel separation
: 85 dB

MP3 decode
KDC-W4531/W4031/W409/W431G
: Compliant with MPEG-1/2 Audio Layer-3
WMA decode
KDC-W4531/W4031/W409/W431G
: Compliant with Windows Media Audio

Audio section

Maximum output power
KDC-W4531/W4031/W409
: 50 W x 4
KDC-3031A/3031G/309A/309G/W431G
: 45 W x 4
Output power (DIN 45324, +B=14.4V)
KDC-W4531/W4031/W409
: 30 W x 4
KDC-3031A/3031G/309A/309G/W431G
: 28 W x 4
Tone action
Bass : 100 Hz \pm 10 dB
Middle : 1 kHz \pm 10 dB
Treble : 10 kHz \pm 10 dB
Preout level / Load (during disc play)
: 2000 mV/10 k Ω
Preout impedance (during disc play)
: \leq 600 Ω

General

Operating voltage (11 – 16V allowable)
: 14.4 V
Current consumption
: 10 A
Installation Size (W x H x D)
: 182 x 53 x 155 mm
Weight
: 1.4 kg

Free Manuals Download Website

<http://myh66.com>

<http://usermanuals.us>

<http://www.somanuals.com>

<http://www.4manuals.cc>

<http://www.manual-lib.com>

<http://www.404manual.com>

<http://www.luxmanual.com>

<http://aubethermostatmanual.com>

Golf course search by state

<http://golfingnear.com>

Email search by domain

<http://emailbydomain.com>

Auto manuals search

<http://auto.somanuals.com>

TV manuals search

<http://tv.somanuals.com>