

# KENWOOD

## RC-D710

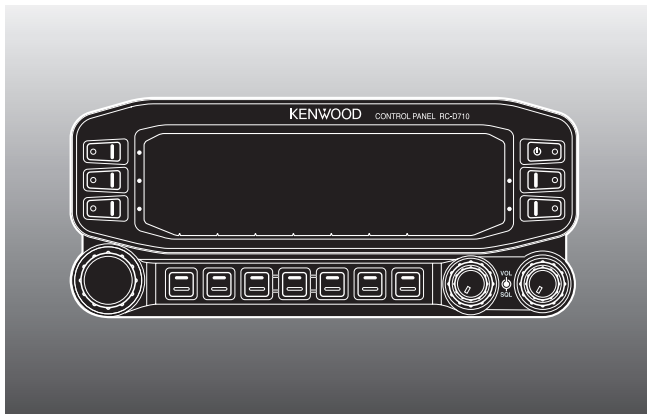

CONTROL PANEL

### INSTRUCTION MANUAL

PANNEAU DE CONTROLE

### MODE D'EMPLOI

PANEL DE CONTROL

### MANUAL DE INSTRUCCIONES

コントロールパネル

### 取扱説明書

Only basic operations are explained in this instruction manual. For a detailed explanation on the operations, refer to the PDF file supplied on the CD-ROM.

Seules les fonctions de base sont expliquées dans ce mode d'emploi. Pour le détail sur les autres opérations, reportez-vous au fichier PDF à votre disposition sur le CD-ROM.

En este manual de instrucciones solamente se explican las operaciones básicas. Si desea obtener una descripción detallada de las operaciones, consulte el archivo PDF correspondiente incluido en el CD-ROM.

本取扱説明書の操作説明は基本的な内容を記載しています。各機能の詳細説明は付属CD-ROM内の取扱説明書（PDF形式）をご覧ください。

Kenwood Corporation

© B62-2003-00 (W)  
09 08 07 06 05 04 03 02 01 00

CONTROL PANEL

# RC-D710

---

## INSTRUCTION MANUAL

Kenwood Corporation

ENGLISH

# THANK YOU

We are grateful you decided to purchase this RC-D710.

## FEATURES

RC-D710 has the following main features:

- Has a built-in TNC which conforms to the AX.25 protocol. With a portable computer, allows you to enjoy Packet operation quite easily.
- Includes a program for dealing with data formats supported by Automatic Packet/ Position Reporting System (APRS®).
- <RC-D710 + TM-V71>  
When the RC-D710 is connected to the TM-V71A/E, the available functions are the same as the TM-D710A/E.
- <RC-D710 + PG-5J>  
When the RC-D710 is connected to the DATA terminal of a transceiver via the PG-5J (option), with the RC-D710 built-in TNC, you can use PACKET and APRS mode (Stand Alone mode).

## NOTICES TO THE USER

One or more of the following statements may be applicable:

### FCC WARNING

This equipment generates or uses radio frequency energy. Changes or modifications to this equipment may cause harmful interference unless the modifications are expressly approved in the instruction manual. The user could lose the authority to operate this equipment if an unauthorized change or modification is made.

### INFORMATION TO THE DIGITAL DEVICE USER REQUIRED BY THE FCC

This equipment has been tested and found to comply with the limits for a Class B digital device, pursuant to Part 15 of the FCC Rules. These limits are designed to provide reasonable protection against harmful interference in a residential installation.

This equipment generates, uses and can generate radio frequency energy and, if not installed and used in accordance with the instructions, may cause harmful interference to radio communications. However, there is no guarantee that the interference will not occur in a particular installation. If this equipment does cause harmful interference to radio or television reception, which can be determined by turning the equipment off and on, the user is encouraged to try to correct the interference by one or more of the following measures:

- Reorient or relocate the receiving antenna.
- Increase the separation between the equipment and receiver.
- Connect the equipment to an outlet on a circuit different from that to which the receiver is connected.
- Consult the dealer for technical assistance.



### Information on Disposal of Old Electrical and Electronic Equipment (applicable for EU countries that have adopted separate waste collection systems)

Products with the symbol (crossed-out wheeled bin) cannot be disposed as household waste. Old electrical and electronic equipment should be recycled at a facility capable of handling these items and their waste byproducts. Contact your local authority for details in locating a recycle facility nearest to you. Proper recycling and waste disposal will help conserve resources whilst preventing detrimental effects on our health and the environment.

## PRECAUTIONS

Observe the following precautions to prevent fire, personal injury, and RC-D710/transceiver damage.

- When operating mobile, do not attempt to configure the RC-D710 while driving; it is too dangerous.
- Do not expose the RC-D710 to long periods of direct sunlight, nor place it near heating appliances.
- Do not place the RC-D710 in excessively dusty, humid, or wet areas, nor on unstable surfaces.
- If an abnormal odor or smoke is detected coming from the RC-D710 or transceiver, switch the RC-D710/transceiver power off immediately, and contact a **Kenwood** service station or your dealer.
- Do not use options not specified by **Kenwood**.

## WRITING CONVENTIONS FOLLOWED IN THIS MANUAL

The writing conventions described below have been followed to simplify instructions and avoid unnecessary repetition.

Instruction	Action
Press [KEY].	Momentarily press KEY.
Press [KEY] (1s).	Press and hold KEY for 1 second or longer.
Press [KEY1], [KEY2].	Press KEY1 momentarily, release KEY1, then press KEY2.
Press [F], [KEY].	Press the F key to enter Function mode, then press KEY to access its secondary function.
Press [KEY] + Power ON.	With the transceiver power OFF, press and hold KEY while turning the transceiver power ON.

# CONTENTS

PREPARATION.....	1
SUPPLIED ACCESSORIES .....	1
INSTALLATION .....	2
CONNECTION TO PC.....	3
CONNECTION TO TM-V71 .....	3
CONNECTION TO PG-5J.....	4
GETTING ACQUAINTED .....	6
OPERATION PANEL (FRONT) <RC-D710 + TM-V71> .....	6
OPERATION PANEL (REAR & LEFT) .....	9
DISPLAY <RC-D710 + TM-V71>.....	10
OPERATION PANEL (FRONT) <RC-D710 + PG-5J>.....	12
BASIC OPERATIONS (RC-D710 + TM-V71).....	14
SWITCHING THE POWER ON/ OFF .....	14
ADJUSTING THE VOLUME .....	14
ADJUSTING THE SQUELCH.....	14
SELECTING A BAND .....	15
SELECTING DUAL BAND MODE/ SINGLE BAND MODE .....	16
SELECTING A FREQUENCY BAND.....	17
SELECTING AN OPERATING MODE.....	18
TRANSMITTING .....	19
MENU MODE .....	20
MENU ACCESS .....	20
MENU CONFIGURATION .....	21
CHARACTER ENTRY .....	32
MAINTENANCE .....	34
GENERAL INFORMATION.....	34
SERVICE .....	34
SERVICE NOTE .....	34
CLEANING .....	34
SPECIFICATIONS.....	35

For a detailed explanation on the operation, refer to the PDF file supplied on the CD-ROM.

- Titles denoted with <RC-D710 + TM-V71> are operation explanations only for when the RC-D710 is connected to the TM-V71(A/E). Titles without this indication include operation explanations for when connecting the RC-D710 to the PG-5J.
- In the explanations, the term "transceiver" is generally referring to the RC-D710 + TM-V71(A/E).

Operation	File name
<b>CONTENTS</b>	00-CONTENTS-E.pdf
<b>OPERATING THROUGH REPEATERS &lt;RC-D710 + TM-V71&gt;</b>	01-REPEATER-E.pdf
<b>MEMORY CHANNELS &lt;RC-D710 + TM-V71&gt;</b>	02-MEMORY CHANNEL-E.pdf
<b>PROGRAMMABLE MEMORY (PM)</b>	03-PM CHANNEL-E.pdf
<b>SCAN &lt;RC-D710 + TM-V71&gt;</b>	04-SCAN-E.pdf
<b>CONTINUOUS TONE CODED SQUELCH SYSTEM (CTCSS) &lt;RC-D710 + TM-V71&gt;</b>	05-CTCSS-E.pdf
<b>DIGITAL CODED SQUELCH (DCS) &lt;RC-D710 + TM-V71&gt;</b>	06-DCS-E.pdf
<b>DUAL TONE MULTI-FREQUENCY (DTMF) &lt;RC-D710 + TM-V71&gt;</b>	07-DTMF-E.pdf
<b>EchoLink® &lt;RC-D710 + TM-V71&gt;</b>	08-EchoLink-E.pdf
<b>OTHER OPERATIONS</b>	09-OTHER OPERATIONS-E.pdf
<b>PACKET OPERATION</b>	10-PACKET-E.pdf
<b>APRS®</b>	11-APRS-E.pdf
<b>RESET</b>	12-RESET-E.pdf
<b>VGS-1 (OPTIONAL) OPERATION &lt;RC-D710 + TM-V71&gt;</b>	13-VGS-E.pdf
<b>CROSS-BAND/ LOCKED-BAND OPERATION &lt;WITH TM-V71(A) K TYPE ONLY&gt;</b>	14-CROSS BAND (K TYPE)-E.pdf
<b>WIRELESS OPERATION &lt;WITH TM-V71(A) K TYPE ONLY&gt;</b>	15-WIRELESS (K TYPE)-E.pdf
<b>WEATHER ALERT &lt;WITH TM-V71(A) K TYPE ONLY&gt;</b>	16-WEATHER ALERT (K TYPE)-E.pdf
<b>SKY COMMAND &lt;WITH TM-V71(A) K TYPE ONLY&gt;</b>	17-SKY COMMAND (K TYPE)-E.pdf

**Note:** Operations file is available in PDF file format. To read the file, you must use Adobe® Reader®.

# PREPARATION

## SUPPLIED ACCESSORIES

Item		Part Number	Quantity
Modular plug cable (for PANEL jack)		E30-7639-XX	1
Line filter		L79-1417-XX	2
Cable with a 2.5 mm (1/10") 3-conductor plug (for GPS jack)		E30-3400-XX	1
Base stand		J09-0409-XX	1
• Sheet		G11-4438-XX	1
Panel holder		J29-0663-XX	1
• Cushion		G13-2233-XX	1
Panel bracket		J29-0707-XX	1
• Sheet		G11-4228-XX	1
Screw set		N99-2055-XX	1
Warranty Card	For USA/ CANADA	--	1
	For Europe	--	1
Instruction manual	English, French, Spanish, Japanese	B62-2003-XX	1
	Italian, German, Dutch, Chinese (traditional)	B62-2004-XX	1
CD-ROM (For a detailed explanation on the operation)		T93-0134-XX	1

# INSTALLATION

## ■ Mobile Installation

- 1 Clean and dry the installation location.



CAUTION

Do not install the bracket close to an air bag.

- 2 Remove the release paper from the base of the panel bracket, then secure it in place using the 3 supplied self-tapping screws.
  - Allow the panel to set for a while, to ensure it remains fast. Otherwise, vibrations may occur.
  - After removing the release paper, it cannot be reused.
- 3 Attach the panel holder to the panel bracket using the 2 supplied SEMS screws.
- 4 Attach the RC-D710 to the panel holder so that it locks in place.

Tapping screw  
(4 mm x 12 mm)

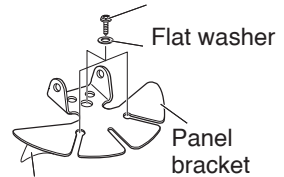

Adhesive tape

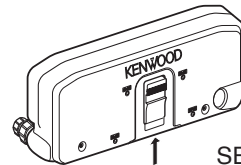

SEMS screw  
(M4 x 10 mm)

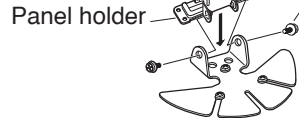

## ■ Fixed Station

- 1 Attach the panel holder to the base stand using the 2 supplied SEMS screws.
- 2 Attach the RC-D710 to the panel holder so that it locks in place.

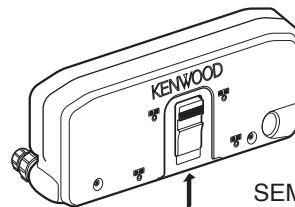

SEMS screw (M4  
x 10 mm)

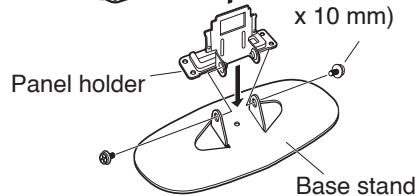



## CONNECTION TO PC

Use a PG-5G (option) cable when connecting the RC-D710 to a computer D-SUB terminal.

### COM terminal pin

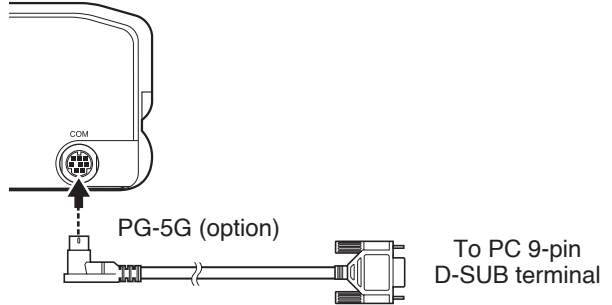
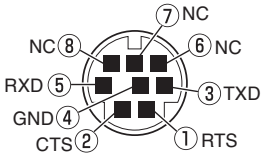

### PG-5G pin configuration (cross connection)

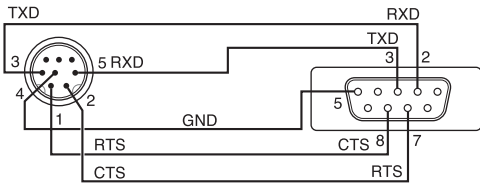

## CONNECTION TO TM-V71

Connect the RC-D710 to the TM-V71 using the supplied cable.

### TM-V71

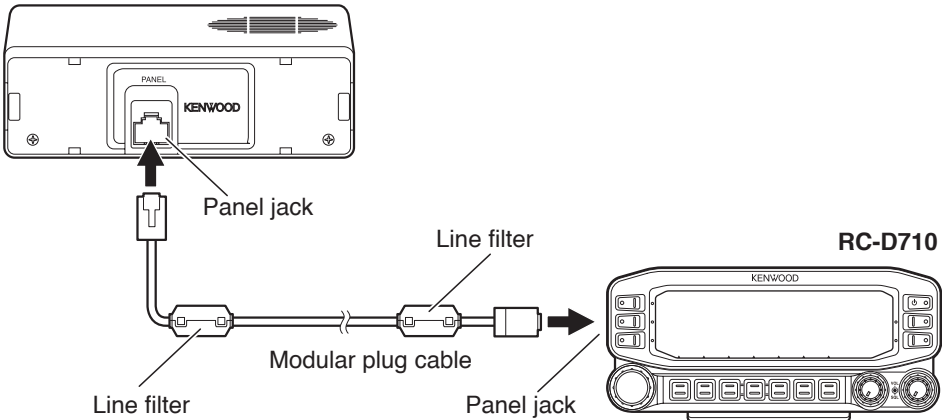

### Installing the Line Filter

Install the line filter approximately 3 cm from the connector.

Approx. 3 cm

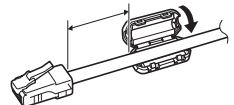

## CONNECTION TO PG-5J

When using the RC-D710 with a transceiver other than the TM-V71, attach the RC-D710 to the transceiver using the PG-5J (option).

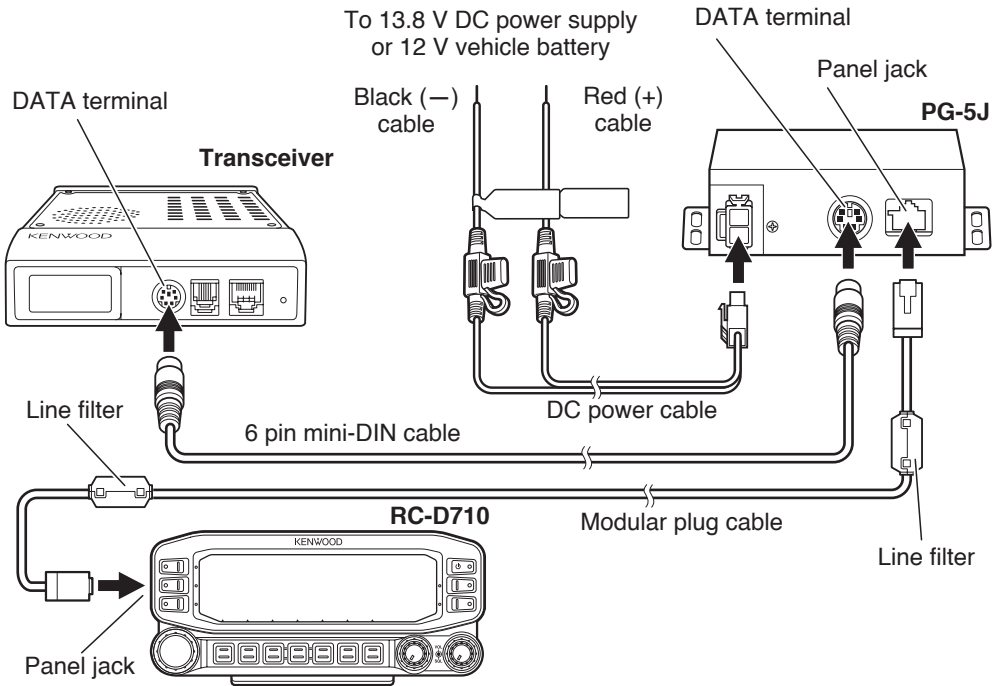

### DATA terminal pin (PG-5J)

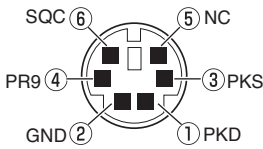

No.	Name	I/O	Function
①	PKD	O	TNC data output 2 Vp-p/ 10 kΩ (9600 bps data) 40 mVp-p/ 10 kΩ (1200 bps data)
②	GND	—	GND
③	PKS	O	Data standby control signal output Open corrector TX : L level / RX : Hi impedance
④	PR9	I	TNC data input (9600 bps) 350 mVp-p to 600 mVp-p/ 10 kΩ
⑤	NC	—	No connection
⑥	SQC	I	Squelch control signal input SQL Open: H level / Close: L level

## ■ Power Cable Connection (PG-5J)

### Fixed Station

In order to use the PG-5J for fixed station operation, you will need a separate 13.8 V DC power supply that must be purchased separately.

---

**Note:** Do not plug the DC power supply into an AC outlet until you make all connections.

---

### Mobile Installation

Be sure to use a 12 V vehicle battery that has sufficient current capacity. If the current to the PG-5J is insufficient, the display may darken during transmission or the transmit output power may drop excessively. Never connect the transceiver to a 24 V battery.

---

**Note:** Install the PG-5J Interface Box using the included screw set in a location where it will not interfere with driving.

---

## ■ Replacing Fuses (PG-5J)

If the fuse blows, determine the cause, then correct the problem. After the problem is resolved, replace the fuse. If newly installed fuses continue to blow, disconnect the power cable and contact your authorized **Kenwood** dealer or an authorized **Kenwood** service center for assistance.



CAUTION

Only use fuses of the specified type and rating; otherwise the PG-5J could be damaged.

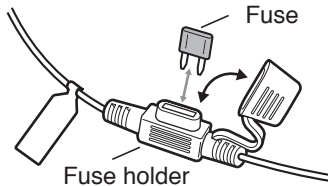

# GETTING ACQUAINTED

## OPERATION PANEL (FRONT) <RC-D710 + TM-V71>

### ■ IN NORMAL MODE

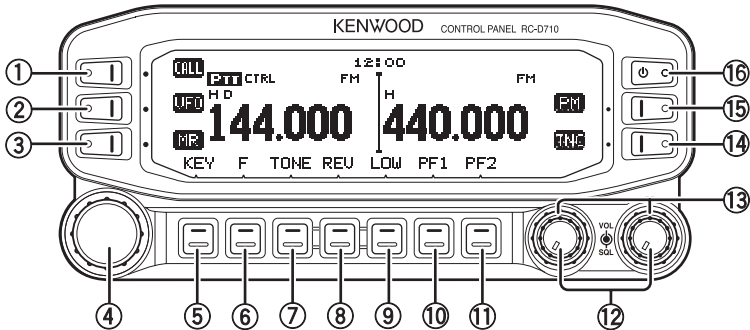

- ① **CALL**  
Press **[CALL]** to select the Call channel.  
Press **[CALL] (1s)** to start Call scan.
- ② **VFO**  
Press **[VFO]** to enter VFO mode , then rotate the **Tuning** control to select an operating frequency.  
Press **[VFO] (1s)** to start VFO scan.
- ③ **MR**  
Press **[MR]** to enter Memory Channel mode, then rotate the **Tuning** control to select a Memory channel.  
Press **[MR] (1s)** to start Memory scan.
- ④ **Tuning Control**  
Rotate to select an operating frequency or Memory channel, change the scan direction, etc.  
Press the **Tuning** control to enter MHz mode (while in VFO or Call mode) or to toggle the display between the channel name and frequency (while in Memory Channel mode).  
Press **Tuning** control **(1s)** to start MHz scan or Group scan.
- ⑤ **KEY**  
Press **[KEY]** to turn the APRS key function ON and OFF.  

---

**Note:** For APRS key functions, refer to the APRS explanation.

---
- ⑥ **F**  
Press **[F]** to enter Function mode.  
Press **[F] (1s)** to turn the transceiver key lock function ON and OFF.

⑦ **TONE**

Press **[TONE]** to turn the Tone function ON.

Each time you press **[TONE]** to toggle the functions as follows: Tone ON >> CTCSS ON >> DCS ON >> OFF.

⑧ **REV**

Press **[REV]** to turn the Reverse function ON or OFF.

Press **[REV] (1s)** to turn the Automatic Simplex Checker ON.

⑨ **LOW**

Press **[LOW]** to toggle the transmit output power as follows: High Power (with TM-V71(A/E) K, E types only) → Middle Power → Low Power.

⑩ **PF1**

Press **[PF1]** to activate its programmable function.

⑪ **PF2**

Press **[PF2]** to activate its programmable function.

⑫ **BAND SEL (VOL) Control**

Rotate the **[BAND SEL]** control to adjust the speaker volume.

Press the left **[BAND SEL]** to select the A band. Press the right **[BAND SEL]** to select the B band.

Press **[BAND SEL] (1s)** to toggle between single and dual-band mode.

⑬ **SQL Control**

Rotate the **[SQL]** control to adjust the squelch level. Clockwise opens the squelch and counterclockwise tightens the squelch.

⑭ **TNC**

Press **[TNC]** to turn built-in TNC ON and the APRS (or NAVITRA) mode ON.

Each time you press **[TNC]**, the mode toggles as follows: APRS (or NAVITRA) mode ON >> PACKET mode ON >> TNC OFF.

- When the built-in TNC turns on, "OPENING TNC" appears on the display.
- When "OPENING TNC" appears on the display, the mode cannot be changed.

⑮ **PM**

Press **[PM]** to enters the PM (Programmable Memory) channel selection mode.

⑯ **⏻**

Press **[⏻]** to turn the transceiver power ON and OFF.

## ■ IN FUNCTION MODE

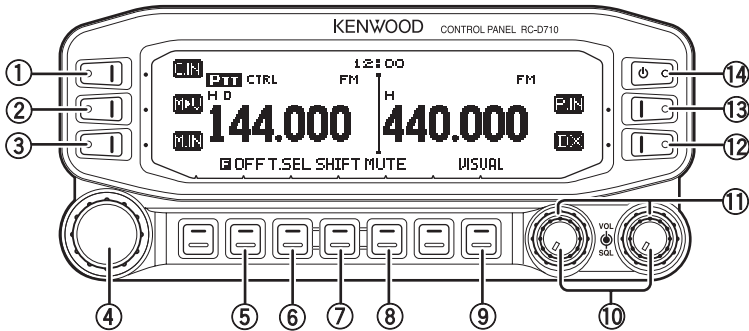

- ① **C.IN**  
Press **[C.IN]** to store the current operating frequency to the Call channel.
- ② **M>V**  
Press **[M>V]** to copy the current Memory channel or Call channel to the VFO (memory shift).
- ③ **M.IN**  
Select a Memory channel, then press **[M.IN]** to store the current operating frequency in the Memory channel.
- ④ **Tuning Control**  
Press the **Tuning** control to enter Menu mode.
- ⑤ **F OFF**  
Press **[F OFF]** to return Normal mode.
- ⑥ **T.SEL**  
While Tone, CTCSS, or DCS is ON, press **[T.SEL]** to enter CTCSS or DCS setup mode.
- ⑦ **SHIFT**  
Press **[SHIFT]** to enter Offset Direction selection mode. Each time you press **[SHIFT]**, the offset direction toggles as follows:  
plus (+) direction → minus (-) direction → -7.6 MHz (with TM-V71(E) E type only) → OFF.
- ⑧ **MUTE**  
Press **[MUTE]** to turn the Mute function ON or OFF.
- ⑨ **VISUAL**  
Press **[VISUAL]** to turn the Visual Scan function ON and OFF.
- ⑩ **BAND SEL (VOL) Control**  
Rotate the **[BAND SEL]** control to adjust the speaker volume.  
Press **[BAND SEL]** to select a frequency band.

- ⑪ **SQL Control**  
Rotate the **[SQL]** control to adjust the squelch level. Clockwise opens the squelch and counterclockwise tightens the squelch.
- ⑫ **DX**  
Press **[DX]** to turn the DX PacketClusters Monitor ON and OFF.
- ⑬ **P.IN**  
Press **[P.IN]** to enter PM Channel registration mode.
- ⑭ **⏻**  
Press **[⏻]** to turn the transceiver power ON and OFF.

## OPERATION PANEL (REAR & LEFT)

- ① **GPS**  
Connect the GPS receiver or the Weather Station to this jack with using supplied cable with a 2.5 mm (1/10") 3-conductor plug.
- ② **COM**  
This terminal is for connecting to a PC. Use a PG-5G (option) cable when connecting the built-in TNC to a computer D-SUB terminal.
- ③ **Panel jack**  
Connect the TM-V71 or PG-5J to this jack using the supplied Modular plug cable.

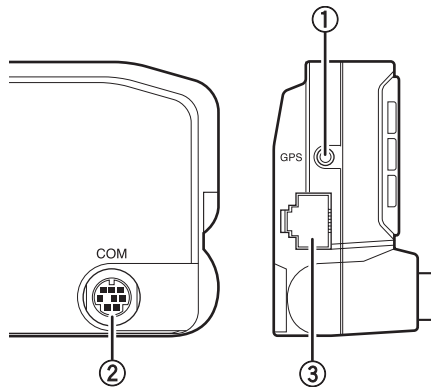



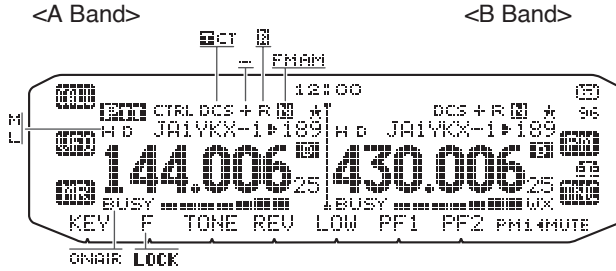

# DISPLAY <RC-D710 + TM-V71>



Indicator	Description
12:00	Clock display (Setting Time: Menu 525)
	Appears when there is a transmission band available. Blinks when the cross-band repeater is ON (with TM-V71(A) K type only).
CTRL	Appears when there is an operation band available. Blinks when the wireless remote control is ON (with TM-V71(A) K type only).
	Appears when the Tone function is ON.
CT	Appears when the CTCSS function is ON.
DCS	Appears when the DCS function is ON.
+	Appears when the Shift function is set to plus.
-	Appears when the Shift function is set to minus.
R	Appears when the Reverse function is ON.
	Appears when the ASC function is ON. Blinks when the ASC function is performing an OK check.
FM	Appears while in AM mode.
FM	Appears while in FM mode.
	Appears while in Narrow FM mode.
	Appears when the selected channel is registered while in Memory Input mode.



Indicator	Description
189	Displays the Memory channel and Menu number.
★	Appears when the Memory Channel Lockout function is ON.
H	Appears while using High output power. Blinks when the temperature protection circuit (transmit power save) turns on. (with TM-V71(A/E) K, E types only)
M	Appears while using Middle output power. Blinks when the temperature protection circuit (transmit power save) turns on.
L	Appears while using Low output power.
144.006 <sub>25</sub>	Displays the operating frequency.
BUSY	Appears when receiving a busy signal.
	Performs as an S meter when receiving a signal and displays the selected power level while transmitting.
ONAIR	Appears while transmitting.
D	Appears while using the External data band.
	Appears while using the Internal data band.
96	Appears when the data terminal is set as 9600 (bps).
MUTE	Appears when mute function is ON.
	Appears while making a continuous recording.
	Appears while in EchoLink Sysop mode.
LOCK	Appears when the Key Lock function is ON.
PM14	Displays the PM channel number.
WX	Appears when Weather Alert is ON. Blinks when receiving a signal. (with TM-V71(A) K type only)

# OPERATION PANEL (FRONT) <RC-D710 + PG-5J>

## ■ IN NORMAL MODE

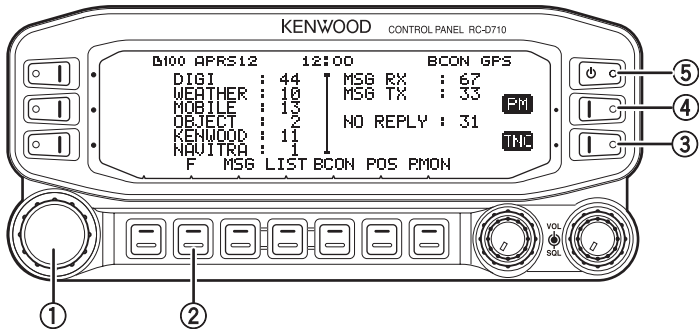

### ① Tuning Control

Press **[F]**, then press the **Tuning** control to enter Menu mode.

### ② F

Press **[F]** to enter Function mode.

### ③ TNC

Each time you press **[TNC]**, the mode toggles between APRS (or NAVITRA) mode ON and PACKET mode ON.

- When “OPENING TNC” appears on the display, the mode cannot be changed.

### ④ PM

Press **[PM]** to enter the PM (Programmable Memory) channel selection mode.

### ⑤ P

Press **[P]** to turn the RC-D710 power ON and OFF.

---

**Note:** For **[MSG]**, **[LIST]**, **[BCON]**, **[POS]**, and **[P.MON]** keys, refer to the APRS explanation.

---

## ■ IN FUNCTION MODE

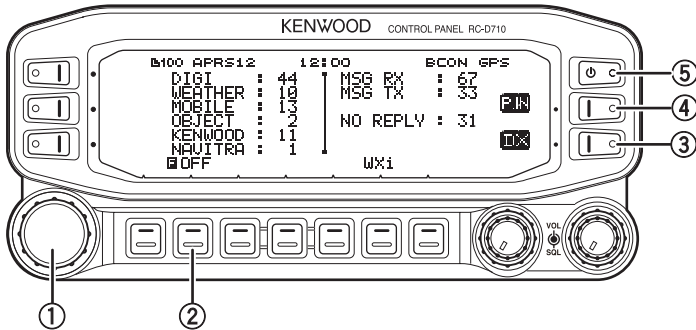

### ① Tuning Control

Press the **Tuning** control to enter Menu mode.

### ② F OFF

Press [**F OFF**] to return Normal mode.

### ③ DX

Press [**DX**] to turn the DX PacketClusters Monitor ON and OFF.

### ④ P.IN

Press [**P.IN**] to enter PM Channel registration mode.

### ⑤

Press [****] to turn the RC-D710 power ON and OFF.

---

**Note:** For [**WXi**] key, refer to the APRS explanation.

---

# BASIC OPERATIONS (RC-D710 + TM-V71)

## SWITCHING THE POWER ON/ OFF

Press the **[PWR]** switch to switch the transceiver ON.



Press the **[PWR]** switch again to switch the transceiver OFF.

## ADJUSTING THE VOLUME

Rotate the **[BAND SEL] (VOL)** control of your selected band clockwise to increase the volume and counterclockwise to decrease the volume.

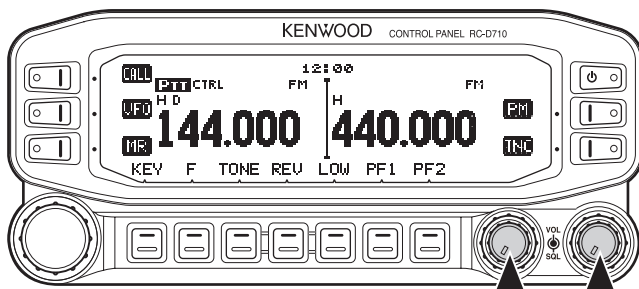

## ADJUSTING THE SQUELCH

Rotate the **[SQL]** control of your selected band, when no signals are present, and select the squelch level at which the background noise is just eliminated.

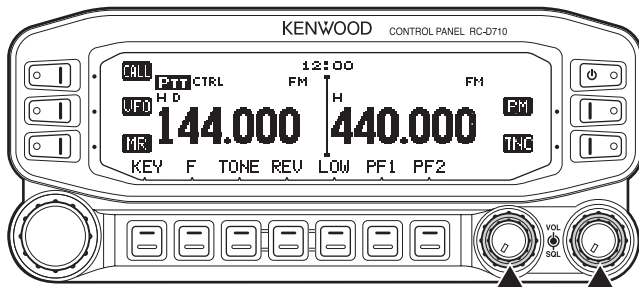

## SELECTING A BAND

Press the left **[BAND SEL]** control to select band A and the right **[BAND SEL]** control to select band B.

- The **CTRL** icon appears at the top of the band on which you are operating and the **PTT** icon appears at the top of the band on which you are currently set to transmit.

Band A (left **[BAND SEL]** control):

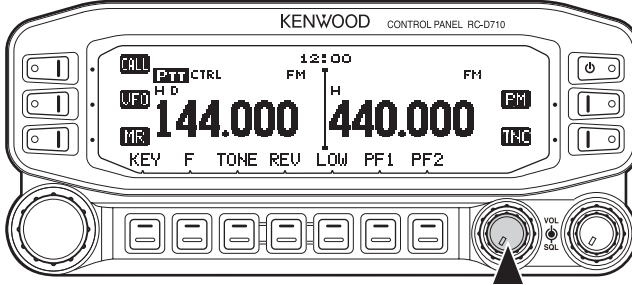

Band B (right **[BAND SEL]** control):

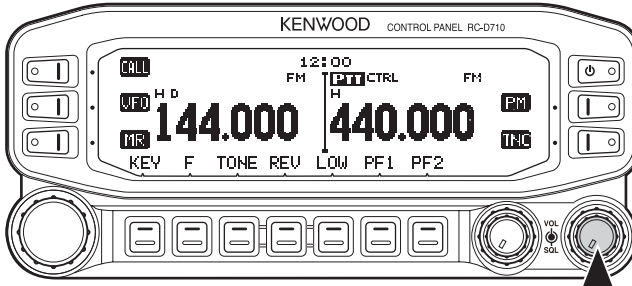

Pressing **[PF2]** allows you to switch the operating band between bands A and B, while maintaining the original band as the transmit band.

Band A is the transmit band and band B is the operating band:

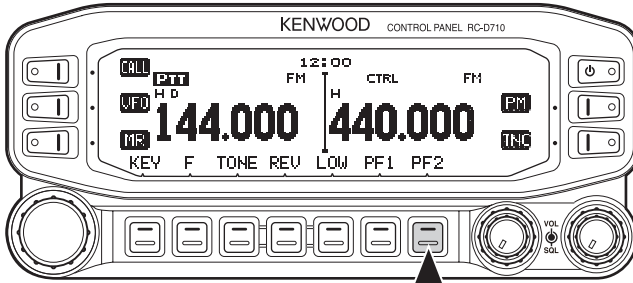

Band A is both the transmit and operating band:

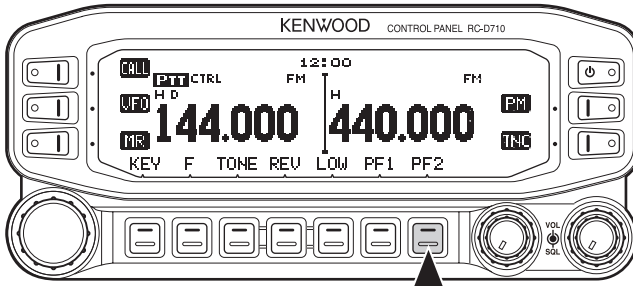

## SELECTING DUAL BAND MODE/ SINGLE BAND MODE

You can switch the transceiver between dual band operation and single band operation by pressing **[BAND SEL] (1s)** of your selected band.

Dual band mode:

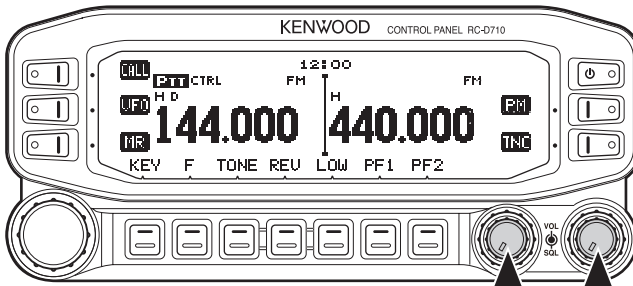

Single band mode (band A only):

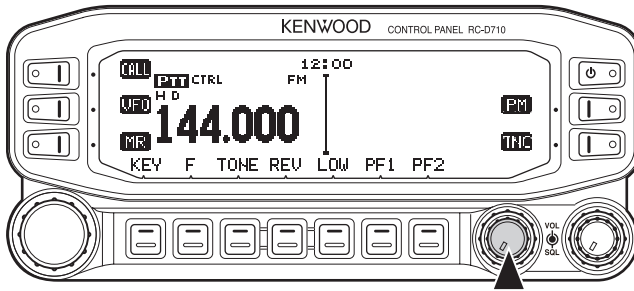

---

Note: You can also turn the center partition bar display off {Menu No. 527}.

---

## SELECTING A FREQUENCY BAND

You can change the default frequency bands for bands A and B.

- 1 Select band A or B by pressing the **[BAND SEL]** control or **[PF2]**.
- 2 Press **[F]**, **[BAND SEL]** of your selected band.
  - Each time you press **[F]**, **[BAND SEL]**, you cycle to the next frequency band.

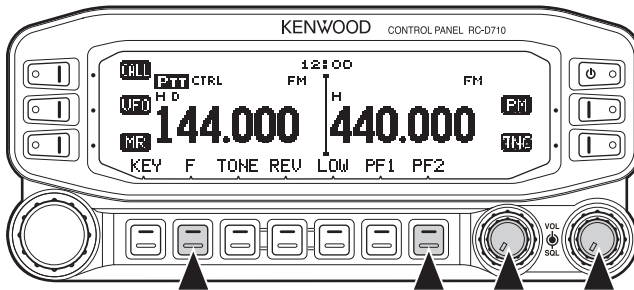

## SELECTING AN OPERATING MODE

There are 3 operating modes available to choose from: VFO mode, Memory Channel mode, and Call Channel mode.

### ■ VFO Mode

VFO mode allows you to manually change the operating frequency.

- 1 Press **[VFO]** to enter VFO mode.

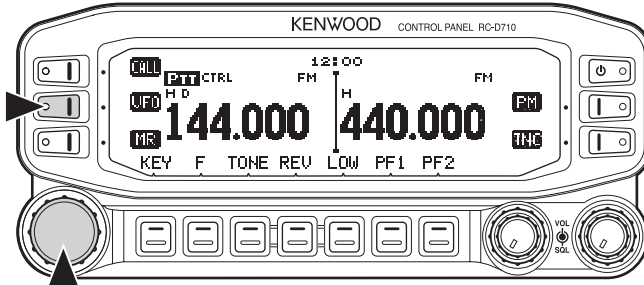

- 2 Rotate the **Tuning** control to select your desired operating frequency.

### ■ Memory Channel Mode

Memory Channel mode allows you to quickly select a frequently used frequency and related data which you have saved in the transceiver memory.

- 1 Press **[MR]** to enter Memory Channel mode.

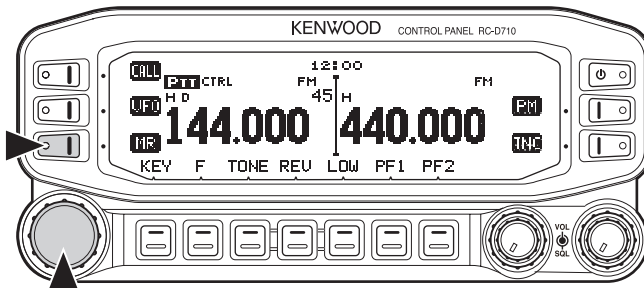

- 2 Rotate the **Tuning** control to select your desired Memory channel.



## ■ Call Channel Mode

Call Channel mode allows you to quickly select a preset channel to allow immediate calls on that frequency. The Call channel can be conveniently used as an emergency channel within your group.

- 1 Select your desired band (A or B).
- 2 Press **[CALL]** to enter Call Channel mode.
  - The **CALL** icon appears on the display.

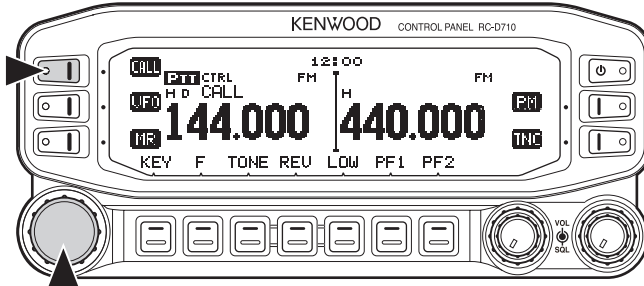

- 3 Press **[CALL]** again to return to your previous operating frequency.

## TRANSMITTING

- 1 Select your desired band and frequency/channel.
- 2 Press and hold the microphone **[PTT]** switch and speak into the microphone to transmit.
  - The **ON AIR** icon and the RF power meter appear on the display for the selected transmit band. The RF power meter shows the relative transmit output power.
  - The **H/L** icon(s) appear on the display, depending on what output power you have selected.

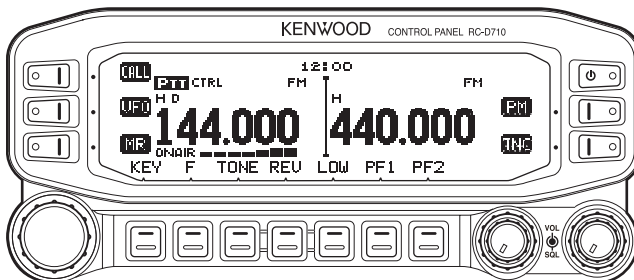

- 3 When you finish speaking, release the **[PTT]** switch.

# MENU MODE

Many functions on this RC-D710 are selected or configured through the Menu instead of physical controls. Once you become familiar with the Menu system, you will appreciate the versatility it offers.

## MENU ACCESS

- 1 Press **[F]**, **Tuning** control to access the Menu.
  - The setup category name appears on the display.

<RC-D710 + TM-V71>



<RC-D710 + PG-5J>



- 2 Rotate the **Tuning** control to select your desired setup category.
- 3 Press the **Tuning** control to set up the current category.
  - The Menu name and number appears on the display.

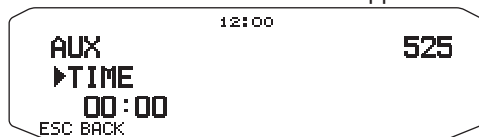

- 4 Rotate the **Tuning** control to select your desired Menu.
- 5 Press the **Tuning** control to set up the current Menu.

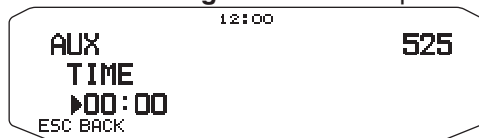

- 6 Rotate the **Tuning** control to select your desired value for the selected Menu.
- 7 Press the **Tuning** control to set the selected value.
- 8 Repeat steps 2 to 7 to set up additional Menus.
  - Press **[ESC]** at any time to exit Menu mode.
  - Press **[BACK]** at any time to cancel the Menu setup and return to the Menu selection.

## MENU CONFIGURATION

AUDIO <RC-D710 + TM-V71>				
Menu No.	Display	Description	Setting Values	Default Setting
000	KEY BEEP	Beep sound	OFF/ ON	ON
001	BEEP VOLUME	Beep volume level	LEVEL 1 ~ LEVEL 7	LEVEL 5
002	EXT.SPEAKER	External speaker output mode	MODE 1/ MODE 2	MODE 1
003 <sup>1</sup>	ANNOUNCE	Voice announcement mode	OFF/ AUTO/ MANUAL	AUTO
004 <sup>1</sup>	ANNOUNCE LANGUAGE	Voice announcement language	ENGLISH/ JAPANESE	ENGLISH
005 <sup>1</sup>	ANNOUNCE VOLUME	Voice announcement volume	LEVEL 1 ~ LEVEL 7	LEVEL 5
006 <sup>1</sup>	ANNOUNCE SPEED	Voice announcement speed	SPEED 0 ~ SPEED 4	SPEED 1
007 <sup>1</sup>	PLAYBACK REPEAT	Recording playback repeat	OFF/ ON	OFF
008 <sup>1</sup>	PLAYBACK INTERVAL	Playback repeat interval time	0 ~ 60 s	10 s
009 <sup>1</sup>	CONTINUOUS RECORDING	Continuous recording	OFF/ ON	OFF

AUDIO <RC-D710 + PG-5J>				
Menu No.	Display	Description	Setting Values	Default Setting
000	KEY BEEP	Beep sound	OFF/ ON	ON
001	BEEP VOLUME	Beep volume level	LEVEL 1 ~ LEVEL 3	LEVEL 2

<b>TX/RX &lt;RC-D710 + TM-V71&gt;</b>				
<b>Menu No.</b>	<b>Display</b>	<b>Description</b>	<b>Setting Values</b>	<b>Default Setting</b>
100	PROGRAMMABLE VFO	Programmable VFO setup	Varies with the selected frequency band	–
101	STEP	Step frequency	Varies with the selected frequency band	–
102	MODULATION	Modulation/demodulation mode	Varies with the selected frequency band	–
103	VHF AIP	VHF band AIP	OFF/ ON	OFF
104	UHF AIP	UHF band AIP	OFF/ ON	OFF
105	S-METER SQUELCH	S-meter squelch	OFF/ ON	OFF
106	S-METER SQL HANGUP TIME	S-meter squelch hang up time	OFF/ 125/ 250/ 500 ms	OFF
107	MUTE HANGUP TIME	Mute hang up time setup	OFF/ 125/ 250/ 500/ 750/ 1000 ms	OFF
108	BEAT SHIFT	Beat shift	OFF/ ON	OFF
109	TOT	Time-out timer	3/ 5/ 10 min	10 min
110 <sup>2</sup>	WEATHER ALERT	Weather alert	OFF/ ON	OFF

<b>MEMORY &lt;RC-D710 + TM-V71&gt;</b>				
<b>Menu No.</b>	<b>Display</b>	<b>Description</b>	<b>Setting Values</b>	<b>Default Setting</b>
200	MEMORY NAME	Memory name setup	Up to 8 characters	–
201	RECALL METHOD	Memory channel recall method	ALL BANDS/ CURRENT	ALL BANDS
202	LOCKOUT	Memory channel lockout	OFF/ ON	OFF
203	GROUP LINK	Memory group link registration	Up to 10 digits (0 ~ 9)	–
204	EchoLink MEMORY	EchoLink memory setting	Up to 8 characters for EchoLink memory name Up to 8 digits for DTMF code	–
205	EchoLink SPEED	EchoLink memory transmission speed	FAST/ SLOW	FAST

DTMF <RC-D710 + TM-V71>				
Menu No.	Display	Description	Setting Values	Default Setting
300	DTMF HOLD	DTMF transmission hold	OFF/ ON	OFF
301	DTMF MEMORY	DTMF memory	Up to 8 characters for DTMF memory name Up to 16 digits for DTMF code	-
302	DTMF SPEED	DTMF memory transmission speed	FAST/ SLOW	FAST
303	DTMF PAUSE	DTMF pause code time	100/ 250/ 500/ 750/ 1000/ 1500/ 2000 ms	500 ms
304	DTMF KEY LOCK	DTMF key lock	OFF/ ON	OFF

REPEATER <RC-D710 + TM-V71>				
Menu No.	Display	Description	Setting Values	Default Setting
400	OFFSET FREQUENCY	Offset frequency	See explanation	-
401 <sup>3</sup>	AUTO REPEATER OFFSET	Auto Repeater Offset	OFF/ ON	ON
402	1750 TX HOLD	Transmission hold when transmitting a 1750 Hz tone	OFF/ ON	OFF
403 <sup>2</sup>	REPEATER MODE	Repeater mode	CROSS BAND/ LOCKED TX: A-BAND/ LOCKED TX: B-BAND	CROSS BAND
404 <sup>2</sup>	REPEATER TX HOLD	Repeater transmission hold	ON/ OFF	OFF
405 <sup>2</sup>	REPEATER ID	Repeater ID registration	Up to 12 characters	-
406 <sup>2</sup>	REPEATER ID TX	Repeater ID transmission	OFF/ MORSE/ VOICE	OFF

<b>AUX &lt;RC-D710 + TM-V71&gt;</b>				
<b>Menu No.</b>	<b>Display</b>	<b>Description</b>	<b>Setting Values</b>	<b>Default Setting</b>
500	POWER ON MESSAGE	Power on message setup	Up to 8 characters	HELLO !!
501	BRIGHTNESS	Display brightness	OFF/ LEVEL 1 ~ LEVEL 8	LEVEL 8
502	AUTO BRIGHTNESS	Display auto brightness	OFF/ ON	OFF
503	BACKLIGHT COLOR	Backlight color	AMBER/ GREEN	AMBER
504	CONTRAST	Display contrast	LEVEL 1 ~ LEVEL 16	LEVEL 8
505	DISPLAY REVERSE MODE	Display reverse mode	POSITIVE/ NEGATIVE	POSITIVE
507	PANEL PF1	PF1 key programmable function value	See explanation	WX CH (K type) FRQ.BAND (E/ M4 types)
508	PANEL PF2	PF2 key programmable function value	See explanation	CTRL
509	MIC PF1(PF)	Microphone PF1 key programmable function value	See explanation	A/B
510	MIC PF2(MR)	Microphone PF2 key programmable function value	See explanation	MR
511	MIC PF3(VFO)	Microphone PF3 key programmable function value	See explanation	VFO
512	MIC PF4(CALL)	Microphone PF4 key programmable function value	See explanation	CALL (K/ M4 types) 1750 (E type)
513	MIC KEY LOCK	Microphone key lock	OFF/ ON	OFF
514	SCAN RESUME	Scan resume method	TIME/ CARRIER/ SEEK	TIME
515	VISUAL SCAN	Number of Channels for Visual Scan	MODE 1: 31ch/ MODE 2 : 61ch/ MODE 3 : 91ch/ MODE 4 : 181ch	MODE 2 : 61ch
516	APO	Auto Power Off time	OFF/ 30/ 60/ 90/ 120/ 180 (minutes)	OFF

**AUX <RC-D710 + TM-V71>**

<b>Menu No.</b>	<b>Display</b>	<b>Description</b>	<b>Setting Values</b>	<b>Default Setting</b>
517	EXT. DATA BAND	External TNC data band type	A-BAND/ B-BAND/ TX:A-BAND RX:B-BAND/ RX:A-BAND TX:B-BAND	A-BAND
518	EXT. DATA SPEED	External TNC data communications speed	1200/ 9600 bps	1200 bps
519	PC PORT BAUDRATE	PC terminal baud rate speed	9600/ 19200/ 38400/ 57600 bps	9600 bps
520	SQC SOURCE	SQC output type	OFF/ BUSY/ SQL/ TX/ BUSY or TX/ SQL or TX	BUSY or TX
521	AUTO PM STORE	Automatic PM entry	OFF/ ON	ON
522 <sup>2</sup>	REMOTE ID	Personal Identification Number	000 ~ 999	000
523 <sup>2</sup>	REMOTE ANSWER BACK	Answer back	OFF/ ON	ON
524	DATE	Date	See explanation	-
525	TIME	Clock time	See explanation	-
526	TIME ZONE	Time zone	UTC + 14:00 ~ UTC - 14:00	UTC
527	DISPLAY PARTITION BAR	Display partition bar	OFF/ ON	ON
528	COM PORT BAUDRATE	COM terminal baud rate speed	9600/ 19200/ 38400/ 57600 bps	9600 bps
529	INT. DATA BAND (PACKET)	Internal TNC data band (PACKET)	A-BAND/ B-BAND/ TX:A-BAND RX:B-BAND/ RX:A-BAND TX:B-BAND	A-BAND

**AUX <RC-D710 + PG-5J>**

<b>Menu No.</b>	<b>Display</b>	<b>Description</b>	<b>Setting Values</b>	<b>Default Setting</b>
500	POWER ON MESSAGE	Power on message setup	Up to 8 characters	HELLO !!
501	BRIGHTNESS	Display brightness	OFF/ LEVEL 1 ~ LEVEL 8	LEVEL 8
502	AUTO BRIGHTNESS	Display auto brightness	OFF/ ON	OFF
503	BACKLIGHT COLOR	Backlight color	AMBER/ GREEN	AMBER
504	CONTRAST	Display contrast	LEVEL 1 ~ LEVEL 16	LEVEL 8
505	DISPLAY REVERSE MODE	Display reverse mode	POSITIVE/ NEGATIVE	POSITIVE
521	AUTO PM STORE	Automatic PM entry	OFF/ ON	ON
524	DATE	Date	See explanation	-
525	TIME	Clock time	See explanation	-
526	TIME ZONE	Time zone	UTC + 14:00 ~ UTC - 14:00	UTC
528	COM PORT BAUDRATE	COM terminal baud rate speed	9600/ 19200/ 38400/ 57600 bps	9600 bps



APRS				
Menu No.	Display	Description	Setting Values	Default Setting
600	BASIC SETTING			
	MY CALLSIGN	Call sign entry	Up to 9 characters	NOCALL
	BEACON TYPE	Beacon type	APRS/ NAVITRA	APRS
601	INTERNAL TNC			
	DATA BAND *RC-D710 + TM-V71	Data band type	A-BAND/ B-BAND/ TX:A-BAND RX:B-BAND/ RX:A-BAND TX:B-BAND	A-BAND
	DATA SPEED	Data communications speed	1200/ 9600 bps	1200 bps
	DCD SENSE	DCD sense type	D or RxD BAND/ BOTH BAND/ IGNORE DCD *RC-D710 + TM-V71	D or RxD BAND
			ON/ IGNORE DCD *RC-D710 + PG-5J	ON
	TX DELAY	TX delay time	100/ 150/ 200/ 300/ 400/ 500/ 750/ 1000 ms	200 ms
602	GPS PORT			
	BAUD RATE	Baud rate speed	2400/ 4800/ 9600 bps	4800 bps
	INPUT	GPS data input type	OFF/ GPS/ WEATHER(Da vis)/ WEATHER (PeetBros)	OFF
	OUTPUT	GPS data output type	OFF/ WAYPOINT/ DGPS	OFF
603	WAYPOINT			
	FORMAT	Way point format	NMEA/ MAGELLAN/ KENWOOD	NMEA
	NAME	Way point name	6-CHAR ~ 9- CHAR	6-CHAR
	OUTPUT	Way point output type	ALL/ LOCAL/ FILTERED	ALL

APRS				
Menu No.	Display	Description	Setting Values	Default Setting
604	COM PORT			
	OUTPUT	COM port output	OFF/ ON	OFF
605	MY POSITION			
	NAME	Name entry	See explanation	-
	LATITUDE	Latitude entry	See explanation	-
	LONGITUDE	Longitude entry	See explanation	-
606	BEACON INFORMATION			
	SPEED	Speed information setup	OFF/ ON	ON
	ALTITUDE	Altitude information setup	OFF/ ON	ON
	POSITION AMBIGUITY	Position ambiguity mode	OFF/ 1-DIGIT ~ 4-DIGIT	OFF
607	POSITION COMMENT			
	POSITION COMMENT	Position comment	See explanation	Off Duty
608	STATUS TEXT			
	TEXT	Status text	See explanation	-
	TX RATE	Status text TX rate	OFF/ 1/1 ~ 1/8	1/1
609	PACKET FILTER			
	POSITION LIMIT	Position limit	See explanation	OFF
	TYPE	Packet filter type	WHEATHER/ DIGI/ MOBILE/ OBJECT/ NAVITRA/ OTHERS	Checked all
610	STATION ICON			
	STATION ICON	Station icon	See explanation	W (KENWOOD icon)
611	BEACON TX ALGORITHM			
	METHOD	Method	MANUAL/ PTT/ AUTO	MANUAL
	INITIAL INTERVAL	Initial interval time	0.2/ 0.5/ 1/ 3/ 5/ 10/ 20/ 30 min	3 min
	DECAY ALGORITHM	Decay algorithm	OFF/ ON	ON
	PROPORTIONAL PATHING	Proportional pathing	OFF/ ON	ON

APRS				
Menu No.	Display	Description	Setting Values	Default Setting
612	PACKET PATH			
	TYPE	Packet path type	See explanation	
613	NETWORK			
	NETWORK	Network	Up to 9 characters	APK102
614	VOICE ALERT *RC-D710 + TM-V71			
	VOICE ALERT	Voice alert	OFF/ ON	OFF
	CTCSS FREQUENCY	CTCSS frequency	See explanation	100.0 Hz
615	WEATHER STATION			
	TX	Weather TX	OFF/ ON	OFF
	TX INTERVAL	Weather TX interval time	5/ 10/ 30 min	5 min
616	DIGIPEAT (MY CALL)			
	DIGIPEAT	Digipeat	OFF/ ON	OFF
617	UI CHECK			
	TIME	UI check time	0 ~ 250 sec	28 sec
618	UIDIGI			
	UIDIGI	UIDIGI	See explanation	
	ALIASES			
619	UIFLOOD			
	UIFLOOD	UIFLOOD	See explanation	
	ALIASES			
	SUBSTITUTION			
620	UITRACE			
	UITRACE	UITRACE	See explanation	
	ALIASES			
621	USER PHRASES			
	USER PHRASES	User phrases	See explanation	
622	AUTO MESSAGE REPLY			
	REPLY	Reply message	OFF/ ON	OFF
	TEXT	Auto message reply text	Up to 50 characters	-
	REPLY TO	Reply to	Up to 9 characters	✳

APRS				
Menu No.	Display	Description	Setting Values	Default Setting
623	GROUP FILTERING			
	MESSAGE	Message group	Up to 59 characters	ALL, QST, CQ, KWD
	BLN	BLN group	Up to 29 characters	-
624	SOUND			
	RX BEEP	RX Beep	OFF/ MESSAGE ONLY/ MINE/ ALL NEW/ ALL	ALL
	SPECIAL CALL	Special call	Up to 9 characters	-
	APRS VOICE *RC-D710 + TM-V71	APRS voice	OFF/ ON	ON
625	INTERRUPT DISPLAY			
	DISPLAY AREA	Display area	OFF/ HALF/ ENTIRE *RC-D710 + TM-V71	ENTIRE
			OFF/ ENTIRE *RC-D710 +PG-5J	ENTIRE
	AUTO BRIGHTNESS	Auto brightness	OFF/ ON	ON
	CHANGE COLOR	Change color	OFF/ ON	ON
626	DISPLAY UNIT 1			
	SPEED, DISTANCE	Speed/ distance	mi/h mile/ Km/h mile/ Knots nm	mi/h mile
	ALTITUDE, RAIN	Altitude/ rain	feet/inch/ m/nm	feet/inch
	TEMPERATURE	Temperature	°F/ °C	°F
627	DISPLAY UNIT 2			
	POSITION	Position format	dd°mm. mm'/ dd°mm' ss. s"	dd°mm. mm'
	GRID FORMAT	Grid format	MAIDENHEAD GRID/ SAR GRID (CONV)/ SAR GRID (CELL)	MAIDENHEAD GRID
628	NAVITRA GROUP			
	GROUP MODE	Group mode	OFF/ ON	OFF
	GROUP CODE	Group code	3 characters	000

APRS				
Menu No.	Display	Description	Setting Values	Default Setting
629	NAVITRA MESSAGE			
	MESSAGE	Message	Up to 20 characters	-

SKY CMD (RC-D710 + TM-V71)				
Menu No.	Display	Description	Setting Values	Default Setting
700 <sup>2</sup>	COMMANDER CALLSIGN	Commander call sign	Up to 9 characters	NOCALL
701 <sup>2</sup>	TRANSPORTER CALLSIGN	Transporter call sign	Up to 9 characters	NOCALL
702 <sup>2</sup>	TONE FREQUENCY	Tone frequency	See explanation	88.5Hz
703 <sup>2</sup>	SKY COMMAND	SKY command	OFF/ COMMANDER/ TRANSPORTER	OFF

AUX 2 (RC-D710 + TM-V71)				
Menu No.	Display	Description	Setting Values	Default Setting
998	POWER ON PASSWORD	Power on password	OFF/ ON	OFF
999	RESET	Reset	VFO RESET/ PARTIAL RESET/ PM RESET/ FULL RESET	VFO RESET

AUX 2 (RC-D710 + PG-5J)				
Menu No.	Display	Description	Setting Values	Default Setting
999	RESET	Reset	PM RESET/ FULL RESET	PM RESET

1 Available only when the optional VGS-1 unit is installed in the TM-V71(A/E).

2 Available only for TM-V71(A) K type models.

3 Available only for TM-V71(A/E) K and E types models.

## CHARACTER ENTRY

Certain menus require you to enter characters, such as the power on message and memory names. When character entry is required, a cursor will appear on the display.

**1** Press the **Tuning** control.

- The cursor will blink.



**2** Rotate the **Tuning** control to select your desired character.

**3** Press the **Tuning** control to set the selected character.

- The cursor will move to the next digit.



- You can move the cursor to the left or right by pressing [**←**] or [**→**].
- You can insert one space by pressing [**SPACE**].
- You can insert a character by pressing [**INS**].
- You can delete the selected character by pressing [**CLR**].

**4** Repeat steps 2 and 3 to enter the remaining characters.

- Press [**ESC**] at any time to exit Menu mode.
- Press [**BACK**] at any time to cancel the Menu setup and return to the Menu selection.

## ■ Microphone Keypad Character Entry (with TM-V71)

The microphone keys can also be used to enter characters. Refer to the table below for characters corresponding to microphone keys.

Key	Character Display (with each press of the key)				Key	Character Display (with each press of the key)			
1	Q	Z	1		7	P	R	S	7
2	A	B	C	2	8	T	U	V	8
3	D	E	F	3	9	W	X	Y	9
4	G	H	I	4	0	(space)		0	
5	J	K	L	5	*	Not used			
6	M	N	O	6	#	-	/	@	

For a memory name, status text, and message:

Key	Character Display (with each press of the key)						
1	q	z	1	Q	Z		
2	a	b	c	2	A	B	C
3	d	e	f	3	D	E	F
4	g	h	i	4	G	H	I
5	j	k	l	5	J	K	L
6	m	n	o	6	M	N	O
7	p	r	s	7	P	R	S
8	t	u	v	8	T	U	V
9	w	x	y	9	W	X	Y
0	(space)	0					
*	Not used						
#	?	!	'	.	,	-	/
	&	#	%	(	)	<	>
	;	:	"	@			

The microphone [A] ~ [D] keys have special functions assigned to them:

[A]: Functions the same as [CLR]

[B]: Functions the same as [←]

[C]: Functions the same as [→]

[D]: Functions the same as the **Tuning** control

# MAINTENANCE

## GENERAL INFORMATION

This product has been factory aligned and tested to specification before shipment. Attempting service or alignment without factory authorization can void the product warranty.

## SERVICE

When returning this product to your dealer or service center for repair, pack it in its original box and packing material. Include a full description of the problem(s) experienced. Include your telephone number along with your name and address in case the service technician needs to contact you; if available, also include your fax number and e-mail address. Don't return accessory items unless you feel they are directly related to the service problem.

You may return this product for service to the authorized **Kenwood** dealer from whom you purchased it, or any authorized **Kenwood** service center. Please do not send subassemblies or printed circuit boards; send the complete product. A copy of the service report will be returned with the product.

## SERVICE NOTE

If you desire to correspond on a technical or operational problem, please make your note legible, short, complete, and to the point. Help us help you by providing the following:

- Model and serial number of equipment
- Question or problem you are having
- Other equipment in your station pertaining to the problem



### CAUTION

Do not pack the equipment in crushed newspapers for shipment! Extensive damage may result during rough handling or shipping.

---

### Note:

- ◆ Record the date of purchase, serial number and dealer from whom this product was purchased.
  - ◆ For your own information, retain a written record of any maintenance performed on this product.
  - ◆ When claiming warranty service, please include a photocopy of the bill of sale or other proof-of-purchase showing the date of sale.
- 

## CLEANING

To clean the case of this product, use a neutral detergent (no strong chemicals) and a damp cloth.



## SPECIFICATIONS

Specifications are subject to change without notice due to advancements in technology.

Supply voltage	10 V DC (9 ~ 11 V DC) <Negative ground>	
Current	Less than 450 mA	
Operating temperature range	-20°C ~ +60°C (-4°F ~ +140°F)	
Dimensions (W x H x D)	Without projections	155 x 70 x 38 mm (6.10" x 2.76" x 1.50")
	With projections	156 x 71 x 56 mm (6.14" x 2.80" x 2.21")
Weight (approx.)	300 g (10.6 oz.)	

To download the MCP-2A software, go to:  
[http://www.kenwood.com/i/products/info/amateur/software\\_download.html](http://www.kenwood.com/i/products/info/amateur/software_download.html)

**Note:** This URL may change without notice.

## Free Manuals Download Website

<http://myh66.com>

<http://usermanuals.us>

<http://www.somanuals.com>

<http://www.4manuals.cc>

<http://www.manual-lib.com>

<http://www.404manual.com>

<http://www.luxmanual.com>

<http://aubethermostatmanual.com>

Golf course search by state

<http://golfingnear.com>

Email search by domain

<http://emailbydomain.com>

Auto manuals search

<http://auto.somanuals.com>

TV manuals search

<http://tv.somanuals.com>