

# KENWOOD

# TK-5720/ TK-5820

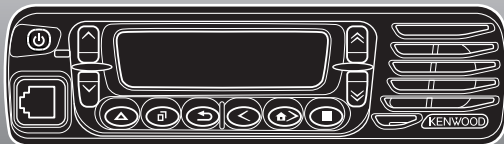

VHF P25 TRANSCEIVER/  
UHF P25 TRANSCEIVER

## INSTRUCTION MANUAL

ÉMETTEUR-RÉCEPTEUR P25 VHF/  
ÉMETTEUR-RÉCEPTEUR P25 UHF

## MODE D'EMPLOI

TRANSCPTOR P25 VHF/  
TRANSCPTOR P25 UHF

## MANUAL DE INSTRUCCIONES

Kenwood Corporation

© B62-2206-00 (K)  
09 08 07 06 05 04 03 02 01 00

VHF P25 TRANSCEIVER/  
UHF P25 TRANSCEIVER

# TK-5720/ TK-5820

ENGLISH

## INSTRUCTION MANUAL

Kenwood Corporation

### Terminal Description

#### Microphone Jack

Pin NO.	Pin Name	Description	Specification	I/O	Notes
1	BLC	Mic key backlight control	CMOS	O	
2	SB	Power Output	13.6 V	O	
3	GND	Ground	Ground	-	
4	PTT/TXD	PTT Input/Serial Data Output	High Impedance/ CMOS	I/O	
5	ME	MIC Ground	Ground	-	
6	MIC	MIC Signal Input	600 $\Omega$	I	
7	HOOK/RXD	Hook Detection/ Serial Data Input	High Impedance	I	
8	DM	MIC Data Detection	High Impedance	I/O	

#### ACC (D-SUB 25 Pin Connector)

Pin NO.	Pin Name	Description	Specification	I/O	Notes
2	RXD1	Serial Data Input	RS-232C compatible	I	
3	TXD1	Serial Data Output	RS-232C compatible	O	
5	DI	Data Input	CMOS	I	input : 0.5 V p-p (Typ.) Data Rate : 9600 bps High Impedance
6	MI2	MIC Signal Input	600 $\Omega$	I	
7	GND	Ground	Ground	-	
9	TXD2	Serial Data Output	TTL	O	
10	RXD2	Serial Data Input	TTL	I	
11	GND	Ground	Ground	-	
18	GND	Ground	Ground	-	
25	ME	MIC Ground	Ground	-	

Antenna Connector  
Impedance is 50  $\Omega$ .

## THANK YOU

We are grateful you have chosen **Kenwood** for your personal mobile applications.

This instruction manual covers only the basic operations of your mobile radio. Ask your dealer for information on any customized features that may have been added to your radio.

## NOTICES TO THE USER

- ◆ Government law prohibits the operation of unlicensed transmitters within the territories under government control.
- ◆ Illegal operation is punishable by fine and/or imprisonment.
- ◆ Refer service to qualified technicians only.

**SAFETY:** It is important that the operator is aware of, and understands, hazards common to the operation of any transceiver.



### WARNING

- ◆ **EXPLOSIVE ATMOSPHERES (GASES, DUST, FUMES, etc.)**  
Turn OFF your transceiver while taking on fuel or while parked in gasoline service stations. Do not carry spare fuel containers in the trunk of your vehicle if your transceiver is mounted in the trunk area.
- ◆ **INJURY FROM RADIO FREQUENCY TRANSMISSIONS**  
Do not operate your transceiver when somebody is either standing near to or touching the antenna, to avoid the possibility of radio frequency burns or related physical injury.
- ◆ **DYNAMITE BLASTING CAPS**  
Operating the transceiver within 500 feet (150 m) of dynamite blasting caps may cause them to explode. Turn OFF your transceiver when in an area where blasting is in progress, or where "TURN OFF TWO-WAY RADIO" signs have been posted. If you are transporting blasting caps in your vehicle, make sure they are carried in a closed metal box with a padded interior. Do not transmit while the caps are being placed into or removed from the container.

The AMBE+2™ voice coding Technology embodied in this product is protected by intellectual property rights including patent rights, copyrights and trade secrets of Digital Voice Systems, Inc. This voice coding Technology is licensed solely for use within this Communications Equipment. The user of this Technology is explicitly prohibited from attempting to extract, remove, decompile, reverse engineer, or disassemble the Object Code, or in any other way convert the Object Code into a human-readable form. U.S. Patent Nos. #5,870,405, #5,826,222, #5,754,974, #5,701,390, #5,715,365, #5,649,050, #5,630,011, #5,581,656, #5,517,511, #5,491,772, #5,247,579, #5,226,084 and #5,195,166.

### Firmware Copyrights

The title to and ownership of copyrights for firmware embedded in Kenwood product memories are reserved for Kenwood Corporation.

## One or more of the following statements may be applicable:

### FCC WARNING

This equipment generates or uses radio frequency energy. Changes or modifications to this equipment may cause harmful interference unless the modifications are expressly approved in the instruction manual. The user could lose the authority to operate this equipment if an unauthorized change or modification is made.

### INFORMATION TO THE DIGITAL DEVICE USER REQUIRED BY THE FCC

This equipment has been tested and found to comply with the limits for a Class B digital device, pursuant to Part 15 of the FCC Rules. These limits are designed to provide reasonable protection against harmful interference in a residential installation.

This equipment generates, uses and can generate radio frequency energy and, if not installed and used in accordance with the instructions, may cause harmful interference to radio communications. However, there is no guarantee that the interference will not occur in a particular installation. If this equipment does cause harmful interference to radio or television reception, which can be determined by turning the equipment off and on, the user is encouraged to try to correct the interference by one or more of the following measures:

- Reorient or relocate the receiving antenna.
- Increase the separation between the equipment and receiver.
- Connect the equipment to an outlet on a circuit different from that to which the receiver is connected.
- Consult the dealer for technical assistance.

## PRECAUTIONS

Observe the following precautions to prevent fire, personal injury, and transceiver damage.

- Do not attempt to configure the transceiver while driving; it is too dangerous.
- Do not disassemble or modify the transceiver for any reason.
- Do not expose the transceiver to long periods of direct sunlight, nor place it near heating appliances.
- If an abnormal odor or smoke is detected coming from the transceiver, switch the transceiver power off immediately, and contact your **Kenwood** dealer.
- Use of the transceiver while you are driving may be against traffic laws. Please check and observe the vehicle regulations in your area.
- Do not use options not specified by **Kenwood**.



### CAUTION

- ◆ The transceiver operates in **12 V** negative ground systems only! Check the battery polarity and voltage of the vehicle before installing the transceiver.
- ◆ Use only a **Kenwood** optional DC power cable.
- ◆ Do not cut and/or remove the fuse holder on the DC power cable.



### WARNING

For passenger safety, install the transceiver securely using an optional mounting bracket and screw set so the transceiver will not break loose in the event of a collision.

# CONTENTS

UNPACKING AND CHECKING EQUIPMENT .....	1
SUPPLIED ACCESSORIES .....	1
PREPARATION.....	2
TOOLS REQUIRED .....	2
POWER CABLE CONNECTION.....	2
INSTALLING THE TRANSCEIVER.....	3
GETTING ACQUAINTED .....	4
FRONT PANEL .....	4
DISPLAY .....	5
PROGRAMMABLE FUNCTIONS.....	6
BASIC OPERATIONS .....	7
SWITCHING POWER ON/OFF.....	7
ADJUSTING THE VOLUME .....	7
SELECTING A ZONE AND CHANNEL .....	7
TRANSMITTING .....	7
RECEIVING .....	8
MENU MODE .....	9
MENU ACCESS .....	9
MENU CONFIGURATION .....	9
CHARACTER ENTRY .....	11
SCAN .....	12
TEMPORARY CHANNEL LOCKOUT .....	12
SCAN DELETE/ADD .....	12
PRIORITY SCAN .....	12
PRIORITY-CHANNEL SELECT .....	13
SCAN REVERT.....	13
FleetSync: ALPHANUMERIC 2-WAY PAGING FUNCTION.....	14
SELCALL (SELECTIVE CALLING) .....	14
STATUS MESSAGE.....	14
SHORT/LONG MESSAGES .....	15
GPS REPORT.....	15
ADVANCED OPERATION .....	16
DTMF (DUAL TONE MULTI FREQUENCY) CALLS .....	16
ENCYRPTION .....	16
EMERGENCY CALLS.....	17
SIGNALING .....	17
LCD BRIGHTNESS .....	18
HORN ALERT.....	18
PUBLIC ADDRESS (PA).....	18
CLOCK .....	19
BACKGROUND OPERATIONS .....	20
TIME-OUT TIMER (TOT) .....	20
SIGNAL STRENGTH INDICATOR.....	20
COMPANDER .....	20
BUSY CHANNEL LOCKOUT (BCL).....	20
PTT ID .....	20
VGS-1 OPTIONAL VOICE GUIDE & STORAGE UNIT.....	21
VOICE RECORDER.....	21
VOICE GUIDE .....	22

# UNPACKING AND CHECKING EQUIPMENT

**Note:** The following unpacking instructions are for use by your **Kenwood** dealer, an authorized **Kenwood** service facility, or the factory.

Carefully unpack the transceiver. We recommend that you identify the items listed in the following list before discarding the packing material. If any items are missing or have been damaged during shipment, file a claim with the carrier immediately.

## SUPPLIED ACCESSORIES

Microphone (with cable) . . . . .	1
Microphone hanger (with 4 x 16 mm self-tapping screws) . . . . .	1
DC power cable . . . . .	1
• Fuse (15 A) . . . . .	2
Mounting bracket . . . . .	1
Screw set	
• 5 x 16 mm self-tapping screw . . . . .	4
• Hex-headed screw with washer . . . . .	4
• Spring washer . . . . .	4
• Flat washer . . . . .	4
Instruction manual . . . . .	1

# PREPARATION



Various electronic equipment in your vehicle may malfunction if they are not properly protected from the radio frequency energy which is present while transmitting. Electronic fuel injection, anti-skid braking, and cruise control systems are typical examples of equipment that may malfunction. If your vehicle contains such equipment, consult the dealer for the make of vehicle and enlist his/her aid in determining if they will perform normally while transmitting.

**Note:** The following preparation instructions are for use by your **Kenwood** dealer, an authorized **Kenwood** service facility, or the factory.

## TOOLS REQUIRED

**Note:** Before installing the transceiver, always check how far the mounting screws will extend below the mounting surface. When drilling mounting holes, be careful not to damage vehicle wiring or parts.

The following tools are required for installing the transceiver:

- 1/4 inch (6 mm) or larger electric drill
- 5/32 inch (4.2 mm) drill bit for the self-tapping screws used to mount the optional mounting bracket
- Circle cutters

## POWER CABLE CONNECTION



- ◆ The transceiver operates in **12 V** negative ground systems only! Check the battery polarity and voltage of the vehicle before installing the transceiver.
- ◆ Use only a **Kenwood** optional DC power cable.
- ◆ Do not cut and/or remove the fuse holder on the DC power cable.

- 1 Check for an existing hole, conveniently located in the firewall, where a power cable can be passed through. If no hole exists, use a circle cutter to drill the firewall, then install a rubber grommet.
- 2 Run the two power cable leads through the firewall and into the engine compartment, from the passenger compartment.
- 3 Connect the red lead to the positive (+) battery terminal and the black lead to the negative (-) battery terminal.
  - Locate the fuse as close to the battery as possible.
- 4 Coil and secure the surplus cable with a retaining band.
  - Be sure to leave enough slack in the cables so the transceiver can be removed for servicing while keeping the power applied.

## INSTALLING THE TRANSCEIVER



### WARNING

For passenger safety, install the transceiver securely using an optional mounting bracket and screw set so the transceiver will not break loose in the event of a collision.

- 1 Mark the position of the holes in the dash by using the mounting bracket as a template. Drill the holes, then attach the mounting bracket using self-tapping screws.
  - Be sure to mount the transceiver in a location where the controls are within easy reach of the user and where there is sufficient space at the rear of the transceiver for cable connections.
- 2 Connect the antenna and power cable to the transceiver.
- 3 Slide the transceiver into the mounting bracket and secure it using hex-headed screws.
- 4 Mount a microphone hanger in a location where it will be within easy reach of the user.
  - The microphone and microphone cable should be mounted in a location where it will not interfere with the safe operation of the vehicle.



### CAUTION

When replacing the fuse in the DC power cable, be sure to replace it with a fuse of the same value. Never replace a fuse with a fuse that has a higher value.

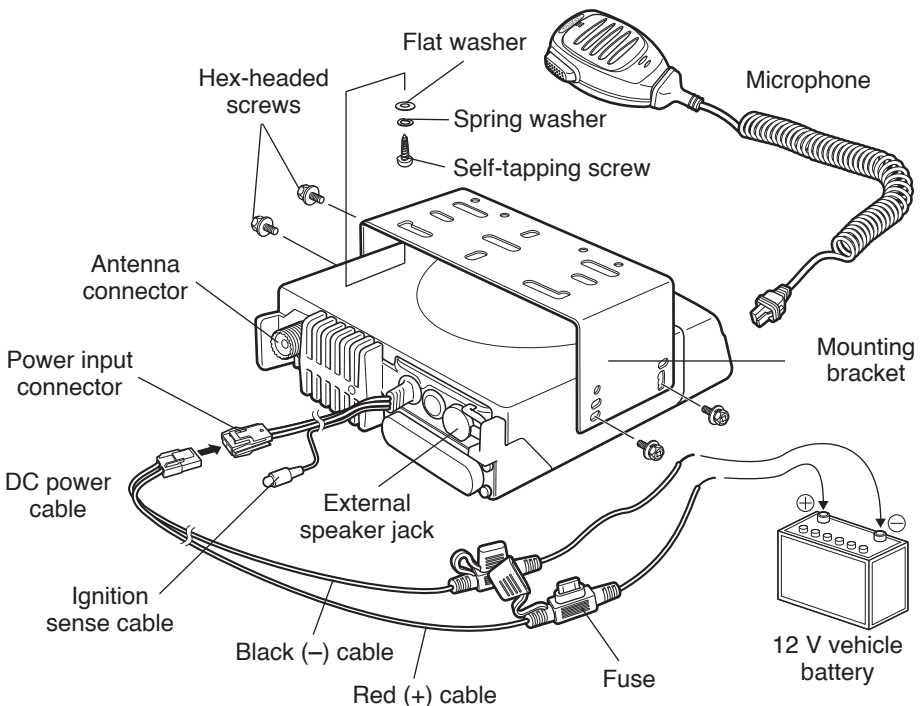



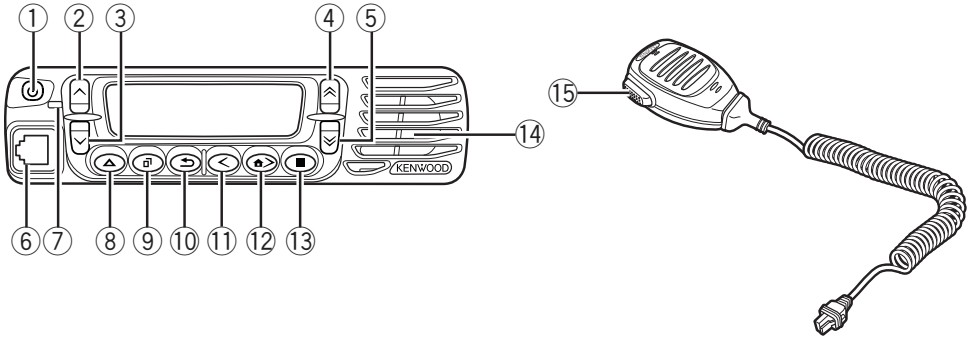

# GETTING ACQUAINTED

## FRONT PANEL

















- ① **⏻ (power) switch**  
Press and hold for approximately 1 second to switch the transceiver power ON and OFF.
- ② **△ key**  
Press to activate its programmable function {page 6}.
- ③ **□ key**  
Press to activate its programmable function {page 6}.
- ④ **△ key**  
Press to activate its programmable function {page 6}. Acts as an Up key for certain functions.
- ⑤ **□ key**  
Press to activate its programmable function {page 6}. Acts as a Down key for certain functions.
- ⑥ **Microphone jack**  
Insert the microphone plug into this jack.
- ⑦ **LED indicator**  
If enabled by your dealer, lights red while transmitting, green while receiving a call, and orange when receiving an optional signaling call (2-tone, DTMF signaling, etc.).
- ⑧ **△ key**  
Press to activate its programmable function {page 6}.
- ⑨ **□ key**  
Press to activate its programmable function {page 6}.
- ⑩ **△ key**  
Press to activate its programmable function {page 6}.
- ⑪ **□ key**  
Press to activate its programmable function {page 6}.

- ⑫  **key**  
Press to activate its programmable function {page 6}.
- ⑬  **key**  
Press to activate its programmable function {page 6}.
- ⑭ **Speaker**  
Internal speaker
- ⑮ **PTT (Push-to-Talk) switch**  
Press and hold this switch then, speak into the microphone to call a station.

## DISPLAY



Indicator	Description
	Monitor or Squelch Off is activated.
	Blinks when an incoming call matches your Optional Signaling.
	The current zone (left icon) or channel (right icon) is added to scan.
	Scan is in progress. Blinks while scan is paused.
	A message is stored in memory. Blinks when a new message has arrived.
	The current channel is a Priority channel.
	Operator Selectable Tone (OST) is activated.
	Talk Around is activated.
	Signal Strength indicator {page 20}
	Encryption is activated.
	Auto Recording on the VGS-1 option is activated.
	Auto Reply Message on the VGS-1 option is activated.
	The auxiliary A function is activated.
	The auxiliary B function is activated.
	Lone Worker is activated.

# PROGRAMMABLE FUNCTIONS

Following is a list of available programmable functions. Please contact your dealer for further details on those functions which have been programmed on your transceiver.

- None (No function)
- 2-tone <sup>1</sup>
- Auto Reply Message <sup>1,2</sup>
- Autodial <sup>1</sup>
- Autodial Programming <sup>1</sup>
- AUX A
- AUX B
- Call 1 ~ 6
- Channel Down
- Channel Entry
- Channel Recall
- Channel Up
- Clock
- Clock Adjustment
- Direct Channel 1 ~ 5
- Direct Channel Select 1 ~ 5
- Display Format
- Emergency <sup>3</sup>
- Encryption <sup>4</sup>
- Encryption Code <sup>4</sup>
- Fixed Volume
- Function
- GPS Position Display
- Home Channel
- Home Channel Select
- Horn Alert
- Individual <sup>4</sup>
- Key Delete
- LCD Brightness
- Lone Worker
- Maintenance
- Menu
- Monitor
- Monitor Momentary
- Operator Selectable Tone <sup>1</sup>
- Playback <sup>2</sup>
- Priority-channel Select
- Public Address
- Scan
- Scan Delete/Add
- Selcall <sup>1</sup>
- Selcall + Status <sup>1</sup>
- Selcall + Short Message <sup>1</sup>
- Send the GPS data <sup>1</sup>
- Squelch Level <sup>1</sup>
- Squelch Off <sup>1</sup>
- Squelch Off Momentary <sup>1</sup>
- Stack
- Status <sup>1</sup>
- Short Message <sup>1</sup>
- Talk Around
- Talkgroup <sup>4</sup>
- Talkgroup Reset <sup>4</sup>
- Transceiver Password
- Voice Memo <sup>2</sup>
- Volume Down
- Volume Up
- Zeroize <sup>4,5</sup>
- Zone Delete/Add
- Zone Down
- Zone Up

<sup>1</sup> Available only for analog operation.

<sup>2</sup> Available only if the VGS-1 optional board has been installed.



<sup>3</sup> Can be programmed only on the  key and an optional auxiliary switch, such as an emergency foot switch.

<sup>4</sup> Available only for P25 operation.

<sup>5</sup> Available only if the Secure Cryptographic Module (SCM) optional board has been installed.



# BASIC OPERATIONS

## SWITCHING POWER ON/OFF

Press and hold  for approximately 1 second to turn the transceiver power ON. Press and hold  again to turn the transceiver OFF.

## ■ Transceiver Password

If the transceiver is password protected, "PASSWORD" will appear on the display when the power is turned ON. To unlock the transceiver, enter the password:



- 1 Select a character using /.

  - If you are using a microphone keypad, you can enter the password by directly.

- 2 Press  to enter the selected character.

  - This step is unnecessary when using the keypad.

- 3 Repeat steps 1 and 2 to enter the entire password.

  - Press  or # to delete a character. Press and hold  or # to delete all characters.

- 4 Press  or \* to confirm the entry.

  - If you enter an incorrect password, an error tone sounds and the transceiver remains locked.
  - The password can contain a maximum of 6 digits.

## ADJUSTING THE VOLUME

Press the keys programmed as **Volume Up/ Volume Down** to adjust the volume level.

## SELECTING A ZONE AND CHANNEL

Select the desired zone using the keys programmed as **Zone Up/ Zone Down**. Each zone contains a group of channels.

Select the desired channel using the keys programmed as **Channel Up/ Channel Down**. Each channel is programmed with settings for transmitting and receiving.

- You can toggle the display between the zone and channel names and numbers by pressing the key programmed as **Display Format**, or by accessing the Menu {page 9}.

## TRANSMITTING



- 1 Select the desired zone and channel.
- 2 Press the key programmed as **Monitor** or **Squelch Off** to check whether or not the channel is free.

  - If the channel is busy, wait until it becomes free.

- 3 Press the microphone **PTT** switch and speak into the microphone. Release the **PTT** switch to receive.
  - For best sound quality, hold the microphone approximately 1.5 inches (3 ~ 4 cm) from your mouth.



### ■ Making Group Calls (P25)

Channels programmed for P25 operation already have a Talkgroup ID assigned. For these channels, simply press and hold the microphone **PTT** switch to make the call. Otherwise, if a key has been programmed with **Talkgroup**, you can select a group ID to make a call to those parties.

- 1 Press the key programmed as **Talkgroup**.
- 2 Press   to select a group ID/name.
- 3 Press  or \* to set the selected Talkgroup.
- 4 Press and hold the microphone **PTT** switch to make the call.
  - Speak into the microphone as you would during a normal transmission.

### ■ Making Individual Calls (P25)

If a key has been programmed with **Individual**, you can make calls to specific persons.

- 1 Press the key programmed as **Individual**.
- 2 Press   to select a unit ID/name.
  - If you are using a microphone keypad, you can enter a unit ID directly.
- 3 Press and hold the microphone **PTT** switch to make the call.
  - Speak into the microphone as you would during a normal transmission.

## RECEIVING

Select the desired zone and channel. If signaling has been programmed on the selected channel, you will hear a call only if the received signal matches your transceiver settings.

---

**Note:** Signaling allows your transceiver to code your calls. This will prevent you from listening to unwanted calls. Refer to "SIGNALING" on page 17 for details.

---

### ■ Receiving Group Calls (P25)

When you receive a group call with a group ID that matches the ID set up on your transceiver, and the Network Access Code also matches, you can hear the caller's voice.

### ■ Receiving Individual Calls (P25)













When you receive an individual call, a ringing tone will sound. If the Network Access Code matches and the squelch type is set to Selective call, the caller's ID will also appear on the display.

To respond to the call, press and hold the microphone **PTT** switch and speak into the transceiver as you would during a normal transmission.

# MENU MODE

Many functions on this transceiver are selected or configured through the Menu instead of physical controls. Once you become familiar with the Menu system, you will appreciate the versatility it offers.

## MENU ACCESS

- 1 Press the key programmed as **Menu**.
  - The category list is shown.
  - When there is only 1 category, the function list is shown (proceed to step 4).
- 2 Press / to select a category item.
  - If you are using a microphone keypad, you can enter a category number directly.
- 3 Press  or \* to view the function list.
- 4 Press / to select a function item.
  - If you are using a microphone keypad, you can enter a function number directly.
- 5 Press  or \* to set up the selected function item.
  - Press  or # to return to the category list.
- 6 Press / to select your desired setting.
  - For settings with more than 1 level, repeat steps 5 and 6.
- 7 Press  or \* to set the selected setting and exit Menu mode.
  - Press  or # at any time to return to the previous display.
  - Press  at any time to exit Menu mode.

## MENU CONFIGURATION

Some transceiver keys may already be programmed with functions listed in the Menu. Those functions can be accessed directly by pressing the key. All other functions can still be accessed using the transceiver Menu. The following table lists the available Menu items.

Display	Description
2-TONE	2-tone Mode
AUTO REPLY MSG	Auto Reply Message ON/OFF
AUTO DIAL	Autodial Mode
AUTO DIAL PROG	Autodial Programming Mode
AUX A	AUX A ON/OFF
AUX B	AUX B ON/OFF
CLOCK	Clock ON/OFF
CLOCK ADJUST	Clock Adjustment mode



<b>Display</b>	<b>Description</b>
DIRECT CH1 SEL ~ DIRECT CH5 SEL	Direct channel 1 ~ 5 Select
DISP FORMAT	Display Format ON/OFF
ENCRYPTION	Encryption ON/OFF
ENCRYP CODE	Encryption Code mode
FIXED VOLUME	Fixed Volume
GPS POS DISP	GPS Position Display mode
HOME CH SEL	Home Channel Select
HORN ALERT	Horn Alert ON/OFF
INDIVIDUAL	Individual mode
KEY DELETE	Encryption Key Delete mode
LCD BRIGHTNESS	LCD Brightness level
MONITOR	Monitor ON/OFF
OST	OST ON/OFF
OST LIST	OST mode
PLAYBACK	Playback mode
PRI CH SEL	Priority Channel Select mode
PUBLIC ADDRESS	Public Address System ON/OFF
SCAN	Scan ON/OFF
SCAN DEL/ADD	Scan Delete/Add
SELCALL	Selcall mode
SELCALL+STATUS	Selcall + Status mode
SELCALL+SDM	Selcall + SDM mode
SEND GPS DATA	Transmit your GPS data
SHORT MESSAGE	Short Message mode
SQUELCH LEVEL	Squelch Level mode
SQUELCH OFF	Squelch Off ON/OFF
STACK	Stack mode
STATUS	Status mode
TALK AROUND	Talk Around ON/OFF
TALKGROUP	Talkgroup mode
TALKGROUP RST	Talkgroup Reset
PASSWORD	Transceiver Password mode
VOICE MEMO	Voice Memo mode

Display	Description
ZEROIZE	Zeroize
ZONE DEL/ADD	Zone Delete/Add

## CHARACTER ENTRY

There are 2 methods available for entering characters:

### 1) keys

Press   to cycle through the characters A ~ Z, 0 ~ 9 and a space (default settings).

You can also assign a character to an optional key and later press that key to recall the assigned character: A ~ Z, a ~ z, 0 ~ 9, or a space and characters.

### 2) Microphone keypad

Press the microphone keypad keys to enter characters as shown in the table below:

DTMF Key	Character Cycle
1	1
2	A B C a b c 2
3	D E F d e f 3
4	G H I g h i 4
5	J K L j k l 5
6	M N O m n o 6
7	P Q R S p q r s 7
8	T U V t u v 8
9	W X Y Z w x y z 9
0	[space] 0



# SCAN

Scan monitors for signals on the transceiver channels. While scanning, the transceiver checks for a signal on each channel and only stops if a signal is present.

To begin scanning, press the key programmed as **Scan**.

- The  icon appears on the display.
- When a signal is detected on a channel, Scan pauses at that channel. The transceiver will remain on the busy channel until the signal is no longer present, at which time Scan resumes.

To stop scanning, press the **Scan** key again.

---

**Note:** To use Scan, there must be at least 2 channels in the scan sequence.

---

## TEMPORARY CHANNEL LOCKOUT

During scan, you can temporarily remove specific channels from the scanning sequence by selecting them and pressing the key programmed as **Scan Delete/Add**.

- The channel is no longer scanned. However, when scanning is ended and restarted, the channels are reset and deleted channels will again be in the scanning sequence.

## SCAN DELETE/ADD

You can add and remove zones and/or channels to and from scan.

- 1 Select your desired zone and/or channel.
- 2 Press the key programmed as **Zone Delete/Add** (to add/remove zones) or **Scan Delete/Add** (to add/remove channels).
  - You can also press and hold the key programmed as **Scan Delete/Add** to add/remove zones.

## PRIORITY SCAN

---

**Note:** To use Priority Scan, a Priority channel must be programmed.







---

When using a single Priority channel, the transceiver will automatically change to the Priority channel when a call is received on that channel, even if a call is being received on a normal channel.

When using dual Priority channels, Priority channel 1 is given precedence over Priority channel 2. So, if a call is received on Priority channel 1 while a call is already on Priority channel 2, the transceiver will change to Priority channel 1.

## PRIORITY-CHANNEL SELECT

If the Priority channel has been set as Operator Selectable by your dealer, you can reprogram the Priority channels.

- 1 Select your desired zone and channel.
- 2 Press the key programmed as **Priority-channel Select**.
- 3 Press / to select "NORMAL", "PRIORITY 1" () , "PRIORITY 2" () , or "PRIORITY 1&2" ().
- 4 Press  to save the setting.

## SCAN REVERT

The Scan Revert channel is the channel selected when you press the microphone **PTT** switch to transmit during scan. Your dealer can program one of the following types of Scan Revert channels:

- **Selected:** The last channel selected before scan.
- **Selected + Talkback:** Same as "Selected", plus you can respond to calls on the channel at which scan is paused.
- **Priority 1/ Priority 2:** The Priority channel (either Priority 1 or Priority 2).
- **Priority 1 + Talkback/ Priority2 + Talkback:** Same as "Priority 1/ Priority 2", plus you can respond to calls on the channel at which scan is paused.
- **Last Called + Selected:** Same as "Selected + Talkback", plus you can respond on the last channel on which you received a call after scan has resumed.

# FleetSync: ALPHANUMERIC 2-WAY PAGING FUNCTION

FleetSync is an Alphanumeric 2-way Paging Function, and is a protocol owned by **Kenwood** Corporation.

---



**Note:** This function is available only in analog operation.

---

## SELCALL (SELECTIVE CALLING)

A Selcall is a voice call to a station or group of stations.

### ■ Transmitting

- 1 Select your desired zone and channel.
- 2 Press the key programmed as **Selcall** or **Selcall + Status** to enter Selcall mode.
- 3 Press   to select the station you want to call.
  - If Manual Dialing is enabled, you can directly enter the station ID using the microphone keypad.
- 4 Press the microphone **PTT** switch and begin your conversation.

### ■ Receiving

An alert tone will sound and the transceiver will automatically enter Selcall mode. The calling station's ID will appear when a Selcall is received. You can respond to the call by pressing the microphone **PTT** switch and speaking into the microphone.

### ■ Identification Codes

An ID code is a combination of a 3-digit Fleet number and a 4-digit ID number. Each transceiver has its own ID.





- Enter a Fleet number (100 ~ 349) to make a group call.
- Enter an ID number (1000 ~ 4999) to make an individual call in your fleet.
- Enter a Fleet number and select "ALL" ID to make a call to all units in the selected fleet (Fleet call).
- Select "ALL" Fleet and enter an ID number to make a call to the selected ID in all fleets (Supervisor call).
- Select "ALL" Fleet and "ALL" ID to make a call to all units (Broadcast call).

## STATUS MESSAGE

You can send and receive 2-digit Status messages which may be decided in your talk group. Messages can contain up to 16 alphanumeric characters. Status messages range from 10 to 99 (80 ~ 99 are reserved for special messages).

A maximum of 15 received messages (combined status messages and short messages) can be stored in the stack memory of your transceiver.







## ■ Transmitting

- 1 Select your desired zone and channel.
- 2 Press the key programmed as **Status** to enter Status mode (proceed to step 5) or **Selcall + Status** to enter Selcall mode (proceed to step 3).
- 3 Press  to select the station you want to call.
  - If Manual Dialing is enabled, you can enter a station ID by using the microphone keypad.
- 4 Press  to enter Status mode.
- 5 Press  to select the status you want to transmit.
  - If Manual Dialing is enabled, you can enter a status ID by using the microphone keypad.
- 6 Press the microphone **PTT** switch or  to initiate the call.
  - “<<COMPLETE>>” appears on the display when the status has been successfully transmitted.

## ■ Receiving

The  icon will flash and a calling ID or text message will appear when a Status call is received. Press any key to return to normal operation.

## ■ Reviewing Messages in the Stack Memory

- 1 Press the key programmed as **Stack**, or press and hold the key programmed as **Selcall**, **Status**, or **Selcall + Status** to enter Stack mode.
  - The last received message is displayed.
- 2 Press  to select the desired message.
  - Message types are identified as follows:  
I: Caller ID, S: Status Message, M: Short Message
  - Press and hold  for 1 second to cycle the display information as follows:  
ID Name > Status/Short Message > Channel > Time Stamp
- 3 Press  to return to normal operation.
  - To delete the selected message, press  or #. To confirm the deletion, press  or \*.
  - To delete all messages, press and hold  or # for 1 second. To confirm the deletion, press  or \*.

## SHORT/LONG MESSAGES

Received short messages are displayed the same as Status messages and are stored in the same stack memory.

To send short messages, and to send and receive long messages, you must connect the transceiver to a PC. Ask your dealer for details.

## GPS REPORT

To send your location data, you must first connect a GPS unit to the transceiver. Once connected, press the key programmed as **Send the GPS data**, or access the Menu {page 9}. If set up by your dealer, GPS data may be automatically transmitted at a preset time interval.

# ADVANCED OPERATIONS

## DTMF (DUAL TONE MULTI FREQUENCY) CALLS

### ■ Making a DTMF Call

---



**Note:** DTMF calls can be made only in analog operation.

---

#### Manual Dialing (Microphone Keypad Only)



- 1 Press and hold the microphone **PTT** switch.
- 2 Enter the desired digits using the microphone keypad.
  - If you release the microphone **PTT** switch, transmit mode will end even if the complete number has not been sent.
  - If the Keypad Auto PTT function has been enabled by your dealer, you do not need to press the **PTT** switch to transmit; you can make the call simply by pressing the microphone keys.

#### Store & Send

- 1 Enter up to 30 digits using the microphone keypad.
  - Alternatively, you can enter digits by using   {page 11}.
- 2 Press the microphone **PTT** switch to make the call.

### ■ Autodial

Autodial allows you to quickly call DTMF numbers that have been programmed onto your transceiver.

- 1 Press the key programmed as **Autodial**, or access the Menu {page 9}.
- 2 Press   to select your desired number, or enter the list number directly (01 ~ 32).
  - The stored entry appears on the display.
- 3 Press the microphone **PTT** switch to make the call.

### ■ Stun Code

This function is used when a transceiver is stolen or lost. When the transceiver receives a call containing a stun code, the transceiver becomes disabled. The stun code is cancelled when the transceiver receives a call with a revive code.

## ENCRYPTION

---

**Note:** You must install the Secure Cryptographic Module (SCM) to use the Encryption feature.

---

Press the key programmed as **Encryption**, or access the Menu {page 9}, to switch the transceiver to secure (encrypted) transmission.

- Pressing the microphone **PTT** switch after the Encryption function has been turned ON encrypts the transmitted signal.

## EMERGENCY CALLS

If your transceiver has been programmed with the Emergency function, you can make emergency calls.

- 1 Press and hold the key programmed as **Emergency**.
  - Ask your dealer for the length of time necessary to hold this key before the transceiver enters Emergency mode.
  - When the transceiver enters Emergency mode, it will change to the Emergency channel and begin transmitting based on how it is set up by your dealer.
- 2 To exit Emergency mode, press the **Emergency** key again.
  - If the Emergency mode completes a preset number of cycles, Emergency mode will automatically end and the transceiver will return to the zone and channel that was in use before Emergency mode was entered.

---

### Note:

- ◆ Your dealer can set the transceiver to emit a tone when transmitting in Emergency mode.
  - ◆ Your dealer can set the transceiver to emit tones and received signals as normal, or mute the speaker during Emergency operation.
- 



## SIGNALING

### ■ Quiet Talk (QT)/ Digital Quiet Talk (DQT)

Your dealer may have programmed QT or DQT signaling on your transceiver channels. A QT tone/ DQT code is a sub-audible tone/code which allows you to ignore (not hear) calls from other parties who are using the same channel.

### Operator Selectable Tone (OST)

If a key has been programmed with **OST**, you can reprogram the QT/DQT settings on each of your channels.

- 1 Select your desired channel.
- 2 Press and hold the key programmed as **OST** for 1 second.
- 3 Press   to select your desired tone or code.
  - Your dealer can set up to 40 tones/codes.
- 4 Press  to save your new setting.
- 5 When you have finished operating using OST, press the **OST** key again to turn the OST function OFF.

### ■ Network Access Code (NAC)

Your dealer may have programmed a Network Access Code on your transceiver channels. NAC is a feature of P25 transceivers that functions similar to QT/DQT; squelch will open when the correct NAC is received.

## ■ Optional Signaling

Your dealer may also program several types of optional signaling for your transceiver channels.

**2-tone Signaling:** 2-tone Signaling opens the squelch only when your transceiver receives a call containing matching 2 tones.

**DTMF Signaling:** DTMF Signaling opens the squelch only when the transceiver receives a call containing a matching DTMF code.

**FleetSync Signaling:** Refer to "SELCALL (SELECTIVE CALLING)" on page 14.

**MDC-1200:** MDC-1200 is a data system using Audio Frequency Shift Keying (AFSK). Transceivers communicate at a 1200 baud rate, using 1200 Hz and 1800 Hz tones.

## LCD BRIGHTNESS

The LCD backlight can be turned off or set to low or high levels. To cycle through the brightness settings, press the key programmed as **LCD Brightness**.

- Each press of **LCD Brightness** cycles the brightness level from high to low to off, and then back to high.

## HORN ALERT

To use the Horn Alert function, your dealer must install an optional unit. When a call is received that matches the optional signaling set up on your transceiver, Horn Alert causes the vehicle horn or some other external alert to sound. This function notifies you of a received call when you are away from your vehicle.

To toggle Horn Alert ON and OFF, press the key programmed as **Horn Alert** or access the Menu {page 9}.

- HA momentarily appears on the display when Horn Alert is active.

## PUBLIC ADDRESS (PA)

To use the Public Address system, your dealer must install an optional unit and an external speaker. This function causes all audio input via the microphone to be amplified and output through the external speaker.

To use the PA system:

- 1 Press the key programmed as **Public Address** or access the Menu {page 9}
  - PA appears on the display when the PA system is active.
- 2 Press and hold the microphone **PTT** switch, then speak into the microphone.
  - Use the **Volume Up** and **Volume Down** keys to adjust the audio output from the external speaker.
- 3 Press the **Public Address** key again or change the zone or channel to return to normal operation.

## CLOCK

If activated by your dealer, you can view the clock by pressing the key programmed as **Clock**.





---

**Note:** Removing the transceiver power for extended periods will cause the clock time to clear.

---

### ■ Clock Adjustment

To set the time:

- 1 Press the key programmed as **Clock Adjustment**.
  - The current time setting appears.
- 2 Press / to increase or decrease the year setting.
- 3 Press  to set the year and cycle to the month setting.
- 4 Repeat steps 2 and 3 to set the month, day, hour, and minute.
- 5 Press  to exit Clock Adjustment mode.
  - You can press  at any time to exit Clock Adjustment mode.



# BACKGROUND OPERATIONS

Your dealer can activate a variety of transceiver functions to perform without any additional operation on your part.

## TIME-OUT TIMER (TOT)

The Time-out Timer is used to prevent you from using a channel for an extended duration. If you continuously transmit for a preset time, the transceiver will stop transmitting and an alert tone will sound. Release the microphone **PTT** switch.

## SIGNAL STRENGTH INDICATOR

The signal strength indicator displays the strength of received calls.



Strong



Sufficient



Weak



Very weak

No icon appears when no signal is available

## COMPANDER

If programmed by your dealer for a channel, the compander will remove excessive noise from transmitted signals, to provide higher clarity of signals.

## BUSY CHANNEL LOCKOUT (BCL)

If BCL is set up by your dealer, you will be unable to transmit if the channel is already in use. Use a different channel or wait until the channel becomes free.

If BCL Override has been programmed, you can transmit over the current signal:

- 1 Press and hold the microphone **PTT** switch.
  - If the channel is already in use, a warning tone will sound.
- 2 Quickly release and then press the **PTT** switch again.
- 3 Speak into the transceiver as you would during a normal call.

## PTT ID

PTT ID is the transceiver unique ID code which is sent each time the microphone **PTT** switch is pressed and/or released.

---

**Note:** PTT ID can be made only in analog operation.

---

# VGS-1 OPTIONAL VOICE GUIDE & STORAGE UNIT

## VOICE RECORDER

The voice recorder allows you to record conversations and create voice memos.

### ■ Auto Recording

If activated, the auto recorder will continuously record all transmitted and received signals. The recording storage area retains 30 seconds of recording.

### ■ Voice Memos

To record a voice memo, for later playback:

- 1 Press the key programmed as **Voice Memo** or access the Menu {page 9}.
  - The duration of recording memory will appear on the display and begin counting down.
- 2 Speak into the microphone to record your voice memo.
- 3 Press **Ⓜ** to end the recording and store it in memory.
  - If the memory becomes full, recording will stop and the voice memo will be stored in memory.





### ■ Auto Reply Message

You can set the transceiver to automatically respond to Individual Calls while using FleetSync.

- 1 Press the key programmed as **Auto Reply Message** to enter Auto Reply Message mode.
- 2 When you receive an Individual Call, the transceiver will send an automatic response to the caller after 3 seconds, and "GREETING" appears on the display
  - If you are available to receive the call, press any key to cancel the auto response.
  - If there is memory available on your transceiver, "I am not available. Leave your Message." will be sent to the caller and they can leave you a recorded message. When a message is stored on your transceiver, "Msg Rcvd" appears on the display.
  - If no memory is available on your transceiver, "I am not available" will be sent to the caller and "MEMORY FULL" appears on the display.

## ■ Playback

To play back a recorded conversation, memo, or message:

- 1 Press the key programmed as **Playback** or access the Menu {page 9}.
  - If the last action on your transceiver was to auto record your conversation, “STORE?” will appear on the display, otherwise a recording channel with the time of the recording will appear.
- 2 Press   to select the channel you want to play.
  - “AR” represents auto recorded conversations, “RM” represents auto reply messages, and “VM” represents voice memos.
- 3 The transceiver will announce the time and channel, then the recording will play back.
  - When the entire recording has been played, “END OF MESSAGE” is displayed. You can also end the recording at any time by pressing .
  - To delete the selected recording, press . To clear all the recorded data, press and hold .

## VOICE GUIDE

When changing the zone and/or channel, an audio voice will announce the new zone and channel. Additionally, when changing a function setting, the new setting will be announced.

---

**Note:** Voice announcements vary by dealer setting.

---

# KENWOOD

## Free Manuals Download Website

<http://myh66.com>

<http://usermanuals.us>

<http://www.somanuals.com>

<http://www.4manuals.cc>

<http://www.manual-lib.com>

<http://www.404manual.com>

<http://www.luxmanual.com>

<http://aubethermostatmanual.com>

Golf course search by state

<http://golfingnear.com>

Email search by domain

<http://emailbydomain.com>

Auto manuals search

<http://auto.somanuals.com>

TV manuals search

<http://tv.somanuals.com>