

KENWOOD

Listen to the Future

AMPED

2008 TRAINING MANUAL
LIVE CONNECTED.DRIVE CONNECTED.

Totally *FRESH* In-dash Receivers

Built-in Bluetooth® with Wireless Music Streaming, Interactive Lighting, and So Much More!

The Wait Is Over

Kenwood's **DNX8120** All-in-One Is Here!



The **XR-S17P** Super Slim Speaker System



Hot and Heavy,

Lean and Mean

CHECK OUT THE NEW WOOFERS!

Mighty Powerful Amps!

Up to **44%** Smaller



WE'RE ON A ROLL!

Welcome dealers, installers, sales staff and other friends of Kenwood! You hold in your hands the 2008 Amped Manual, your travel guide through the world of Kenwood receivers, multimedia, speakers, and more. Amped is not just a training manual—it's a personal invitation into the obsessive-compulsive minds of the Kenwood training staff who spend hours hammering out details on how to display, sell, and install Kenwood product. But as good as we think Amped Manual is, your best selling tool will be Kenwood's 2008 product line.

While other manufacturers save the best stuff for high-end models, Kenwood expands its Live Connected, Drive Connected philosophy to more models. More in-dash receivers have USB connectivity, and almost all are satellite, Bluetooth, and HD Ready. Even our most basic entry-level Kenwood models include front aux in and RCA pre-outs with crossovers. This year, we're adding even more consumer-friendly features like FL full-dot displays with four lines of text, Interactive Lighting Effect, and a simple 1-wire iPod connection.

Kenwood's 2008 multimedia line includes units that literally have it all—Kenwood entertainment, Garmin navigation, and built-in Bluetooth technology. New customizable GUIs with three-skin selection are easy to see and use, and of course Kenwood multimedia offers high-speed control of iPod audio and video files. We've even added affordable in-dash systems for customers who want entertainment and navigation but can't fork out a lot of cash.

This year's amplifiers pack the power in a chassis size up to 44% smaller than previous years. We also have subs and speakers that shake it up in less space, including a new slim component speaker that even our cynical, audiophile product managers are calling the best sounding Kenwood speaker ever built.

Amped Manual is loaded with good stuff. Keep it handy in a desk drawer, the install bay, even the John (you've got to read something), because Amped not only includes the nitty-gritty on 2008 Kenwood product, it includes practical, every-day knowledge from umpteen years of combined experience from people who know what sells.

Happy Reading!
Kenwood Training Staff

KENWOOD

Listen to the Future



Table of Contents

IN-DASH RECEIVERS 4

| | |
|---|----|
| KDC-X991 & KDC-BT838U Flagships..... | 4 |
| Digital Audio Platform (DAP) | 5 |
| OEL Display | 5 |
| KDC-BT838U | 5 |
| USB Direct Control | 6 |
| 1-Wire iPod Connection..... | 6 |
| 3 & 4-Line Displays..... | 7 |
| External Media Control..... | 7 |
| Aux Inputs..... | 8 |
| Interactive Lighting Effect..... | 8 |
| Multi-control Wheel..... | 8 |
| OEM Steering Wheel Interface..... | 8 |
| eXcelon Receivers..... | 9 |
| Graphic Motion Analyzer..... | 9 |
| High Voltage Preouts..... | 9 |
| KDC-X492..... | 10 |
| Kenwood Receivers..... | 10 |
| Satellite Radio Options..... | 12 |
| Double DIN Receivers..... | 12 |
| KCA-BT200 Hands-free Cell Phone Unit..... | 12 |
| Parrot Technology..... | 13 |
| System Crossovers..... | 13 |
| Remote Controls..... | 14 |
| HD Radio Options..... | 14 |
| KDV-412..... | 14 |

KENWOOD CARPORTAL™ EXPANSION SOLUTIONS 15

| | |
|---|----|
| CarPortal™ KOS-A200 | 15 |
| CarPortal™ KOS-V Series..... | 15 |
| KOS-CV100 RGB-to-Composite Adaptor..... | 16 |
| CarPortal™ Install Examples..... | 16 |
| CarPortal™ KOS-L702 & KOS-L432..... | 17 |

MARINE ENTERTAINMENT..... 18

KENWOOD MULTIMEDIA..... 19

| | |
|---------------------------------|----|
| DNX8120..... | 19 |
| DDX812..... | 20 |
| External Switch Control | 21 |
| New GUI Interface..... | 21 |
| Custom Backgrounds..... | 21 |
| KAB (Kenwood Advanced Bus)..... | 22 |
| DNX7120 & DDX712..... | 23 |
| DNX5120 & DDX512..... | 23 |

| | |
|---|----|
| Loading/Changing Start-up Screen..... | 23 |
| KVT-819DVD & KVT-719DVD..... | 24 |
| CCD-2000 Back-up Camera..... | 25 |
| Adding Speakers and Amps..... | 25 |
| System Security | 25 |
| KCA-BT200 Hands-free Cell Phone Unit..... | 25 |
| LZ-702IR & LZ-702W..... | 26 |
| KNA-G510 Navigation System..... | 27 |
| Remote Controls..... | 28 |
| Building the Ultimate A/V System..... | 28 |

AMPLIFIERS 29

| | |
|------------------------------------|----|
| Class D Models..... | 29 |
| Dual Mono Drive | 30 |
| Bass Boost | 30 |
| Signal Sensing Turn-on | 31 |
| Kenwood Amps..... | 31 |
| eXcelon Amps | 32 |
| Dual Sigma Drive..... | 33 |
| KCA-WR10 Optional Remote..... | 33 |
| 4 & 2-Channel Amps..... | 34 |
| K-STAT Technology..... | 34 |
| High Pass/Low Pass Crossovers..... | 34 |

SPEAKERS & SUBWOOFERS 35

| | |
|---------------------------------------|----|
| Excelon Subwoofers | 35 |
| Flat Woofers | 36 |
| Kenwood Subwoofers | 36 |
| New Compact Subs..... | 37 |
| eXcelon Speakers | 37 |
| XR-S17P Slim Component Speakers | 38 |
| Flush Mount Systems | 38 |
| 2-Ohm Drive | 38 |
| Performance Series..... | 39 |
| KFC-P680C for Ford and Mazda..... | 39 |
| KFC-P708 & KFC-P508S..... | 40 |
| Tweeters..... | 40 |
| Thiele Small Parameters | 41 |
| Woofer Graphs..... | 42 |

APPENDIX..... 46

| | |
|---|----|
| Bluetooth Connection Chart..... | 46 |
| Multimedia Adaptor Accessory Chart..... | 47 |





«« IN-DASH CD RECEIVERS

IN-DASH CD RECEIVERS

Listen closely. You can almost *hear* the competition sweating it out. With better receivers priced below \$250 (where most of the business is), we're squishing the other guys like bugs, and connectivity features they're just rolling out are "been there, done that" for Kenwood.

Most Kenwood receivers and all eXcelon receivers include the kind of features and connectivity you've come to expect like WMA, MP3, AAC file compatibility, USB connectivity, front or back aux inputs, and satellite, Bluetooth, and HD Ready. Heck, even our entry-level Kenwood models include front Aux and RCA pre-outs with crossovers. This year, we're tilting the scales with things like built-in Bluetooth and wireless music streaming, FL full-dot displays with four lines of text, interactive lighting, and 1-wire iPod connection.



Selling CD Receivers is all about connectivity, and **nobody** connects like Kenwood!

In case your boss gives you a pop quiz, here's a little cheat sheet for 2008 Kenwood receivers:

- Built-in Bluetooth module (KDC-BT838U)
- All Models with USB Direct Control have 1-wire iPod connection
- Bluetooth compatibility with A2DP music streaming (KDC-MP238 and up)
- Aux input on all units, front aux on entry level units (customers love that!)
- Interactive lighting effect (KDC-MP538U and up)
- Steering wheel remote control interface (KDC-MP438U and up)
- New flip face mechanism (KDC-MP638U and up)
- 3-line full dot displays (KDC-BT838U, KDC-MP538U)

Key features to remember about 2008 eXcelon receivers:

- USB Direct Control and 1-wire iPod connection
- High voltage pre-outs (front, rear and sub)
- System Q-EX/E's+
- Bluetooth compatibility with music streaming
- Steering wheel control interface
- Blue Illumination Effect
- 24-bit D to A converters
- New flip face mechanism (KDC-X991 is motorized)
- Graphic Motion Analyzer (KDC-X991 and KDC-X792)
- 2-year warranty

Bonus Round! Don't forget that every receiver in our 2008 line-up has aux inputs, 50W x 4 MOSFET power, at least one set of RCA pre-outs, and low-pass filters.



Salute the KDC-X991 and KDC-BT838U Flagships!

The KDC-X991 is back by popular demand with a modification that will allow the unit to accept our new 1-wire iPod connection (we'll cover the 1-wire iPod connection later). This all-digital platform receiver is for customers who crave high-end audio and rely on the advice of a trusted

dealer. Be sure to take the time to explain the features of this amazing piece, like USB Direct Control, System Q-EX, 3 gold-plated RCA pre-outs (5V) with HPF & LPF, DSP, 4-Band parametric EQ (front & rear), and 512MB internal storage.



OEL Is Not Your Average Display

The bright 4096 color customizable OEL display is a real eye-catcher, especially with Graphic Motion Analyzer, and it's easy to see even in bright daylight. It projects bright, vivid colors, responds faster than conventional LCD displays, and OEL is a very efficient, self-emitting device that will project uniform brightness across the entire display. Combine the OEL display with our customized motion graphics and customers see digital images with amazing clarity.



In addition to being the tightest in-dash receiver ever built, the KDC-X991 can rip regular CDs to WMA format and copy USB data to its built-in 512MB flash memory.

A Little DAP Will Do

The KDC-X991's Digital Audio Platform (DAP) lets users tailor the sound to their car to create an exceptional front soundstage and very well-defined center image. The DSP portion also features audio enhancements like SRS WOW HD for clarity and acoustic presence, a sound management system, 5-channel digital time alignment, and high performance audio capacitors. Remember, a big bonus of the DAP is that it can rip regular CDs to WMA format and copy USB data to its built-in 512MB flash memory. You can do this while you're playing tunes, and you can rip in real time while you're listening to your music from CD.

Digital SRS WOW offers 10 adjustment levels and enhanced adjustments for TruBass with separate front and rear settings. Having separate front and rear TruBass settings is great for systems with a subwoofer because it can be used on just the front speakers, creating a strong presence for the bass. This will make the bass sound more like it's coming from the front of the car, which integrates the bass better with the rest of the sound.



Time Alignment—Find Your Sweet Spot

You've probably heard the term "sweet spot," which refers to the most optimum seat or position in which to listen to audio. The home theater guys have the luxury of space, but a car's interior is difficult to manipulate to find the sweet spot. Achieving a good soundstage is tough because some speakers are close and some are further away. Vocals can smear, and the soundstage can be undefined or inaccurate. Time Alignment on the KDC-X991 fixes this and lets you and your customers adjust their vehicle speaker distance from 0 to 20.3 feet.

Picture Engine

Customized graphics and personal photos can be copied to a USB thumb drive and downloaded on the KDC-X991 and KDC-X792's displays. We also offer Picture Engine that lets customers customize wallpaper on their single DIN Kenwood displays. The picture engine website is at <http://www.kenwood.net-disp.com>



The KDC-X991 uses O.D.D. (Offset Dual Differential) that creates high quality sound by eliminating the digital distortion/noise in the digital-to-analog converter. O.D.D. uses two sets of 24 bit D/A converters with one slightly offset. When these signals are recombined, the digital noise is greatly reduced, making this one of the best sounding digital-to-analog converters out there.



The Receiver that Swallowed Bluetooth®!

The KDC-BT838U with built-in Bluetooth module and interactive lighting effect is turning more heads than a swimsuit model. Beautiful inside and out, the KDC-BT838U includes our KCA-BT200 Bluetooth hands-free cell phone module with Parrot technology. All your customer needs is a Bluetooth compatible phone and away they go.



The KCA-BT200 incorporates Parrot technology that offers some exciting features like A2DP music streaming and text messaging. Nerd of the year award goes to this acronym, but A2DP is cool. Basically, it's a profile that defines how high quality audio (stereo or mono) can be streamed from one device to another over a Bluetooth connection, like music streamed from a mobile phone to a Kenwood head unit. (All of our 2008

Bluetooth Ready receivers have music streaming capability, which we'll cover in the section on our new KCA-BT200 hands-free unit.)

The KDC-BT838U includes an external microphone that can be mounted away from noisy dashboards. Some radios have the microphones built into the face of the radio where it can pick up ambient noises like heater/AC vents. And don't forget to remind customers that many states are cracking down on using hand-held cell phones while driving, making the KDC-BT838U an ideal all-in-one unit.

Other features you'll find on the KDC-BT838U include 3-line text, full dot display, interactive illumination effect, spectrum analyzer, USB Direct Control, 1-wire iPod connection, Kenwood Music Editor, 3 RCA pre-outs (2.5V) and a multi-control wheel that makes finding music fast and easy.



It's A Better Way to Play

The ability to have high-speed control of iPods and other music media devices and control them directly from the receiver is a great selling feature. Kenwood saw the value of USB connection long before our competitors got on board, and we offer USB Direct Control on models across the board (not just as a step-up feature). Front or rear-mounted USB inputs are on all 2008 eXcelon head units and Kenwood receivers offer this feature on the KDC-MP438U up.



In addition, Kenwood's USB Control is the speediest connection in town (12 MB/bps). Be careful, however, to inform customers that our USB High Speed Control (and the ability to control iPod functions through the receiver), refers to fifth generation (Nano) devices that have adopted a USB "control" protocol. Most customers will have newer 5Gs; however, customers with older iPods should know the facts.

iPod Support Device

| | Headunit | 5L (iP500) | USB (1Wire Cable) -iPod Control | USB (2Wire Cable) -iPod Control |
|----------------------|-------------------|------------|---------------------------------|---------------------------------|
| iPod 3G | 2008 Model w/ USB | Yes | No | No |
| iPod mini | 2008 Model w/ USB | Yes | No | No |
| iPod 4G | 2008 Model w/ USB | Yes | No | No |
| iPod Photo | 2008 Model w/ USB | Yes | No | No |
| iPod nano | 2008 Model w/ USB | Yes | Yes | Yes |
| iPod 5G (with Video) | 2008 Model w/ USB | Yes | Yes | Yes |
| iPod nano 2G | 2008 Model w/ USB | Yes | Yes | Yes |
| iPod nano 3G | 2008 Model w/ USB | No | Yes | Yes |
| iPod Classic | 2008 Model w/ USB | No | Yes | Yes |
| iPod Touch | 2008 Model w/ USB | Yes | Yes | Yes |
| iPod Shuffle | 2008 Model w/ USB | No | No | No |

iPod USB Compatibility

Connect to 2008 H/U through USB



Connect to 07 H/U through KCA-iP500



1-Wire High Speed iPod Control

All Kenwood and eXcelon head units with USB Direct Control include our new 1-wire iPod connection feature. Our training crew is giddy about this one because 1-wire iPod connection allows customers to use the USB cable that comes with their iPod. Now you can tell Mr. "I'm not buying anything extra" that when he purchases a 2008 Kenwood or eXcelon receiver with USB Direct Control, he can plug in his iPod and control it directly from the receiver. No fuss, no muss! No extra do-dads or cables to buy—just the receiver and that little white iPod USB cable that came in the fancy iPod box. Again, be sure to remind customers that this feature only works on the newer (5th generation) iPods. No special downloads are required but customers should make sure the software on their iPod is up to date.

1 Wire Connection (08 model)

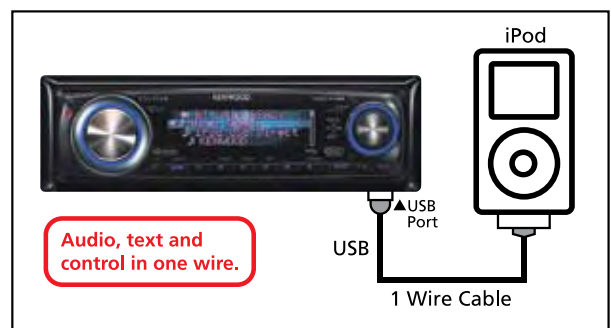

2 Wire Connection (07 model)

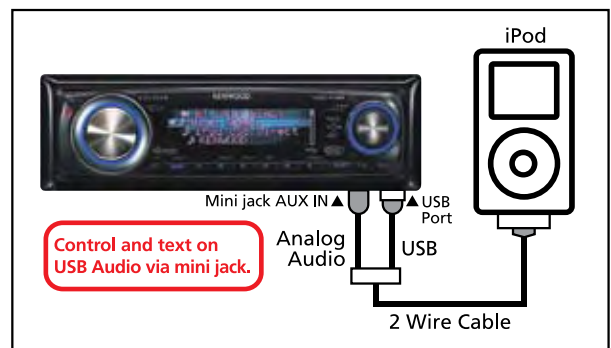

While the USB cable that comes with the iPod works just fine, it's not an automotive-rated device and isn't designed to withstand the hot temperatures of a car interior. We recommend your customer use our KCA-iP100 iPod direct 1-wire cable. It's inexpensive and it can take the heat.



In addition to the convenience, there are audio benefits to 1-wire iPod connection. Because the audio signal leaves the iPod as a digital signal, the D to A conversion takes place on the high quality D to A converters in the Kenwood head units as opposed to the D to A converter in the iPod. Most other manufacturers are still using the old analog serial bus cables which are not as fast and offer ho-hum sound quality.

Think Outside the Port

USB direct connect works on iPods and media devices but there are other benefits. The USB input is also a power source that can charge cell phones, Palm Pilots, Bluetooth headsets and can even work on in-car devices like mini coolers and portable fans (the limit is 500mV of current).

Enough with the One Liners

Kenwood is leading the pack with displays that are better in color, readability, and functionality. Many Kenwood and eXcelon head units offer 3 or 4 lines of text that make it easier for customers to use. Our competitors are offering one and two lines of text, but when you think of all the stuff folks are using with their head units these days—cell phones, satellite radio, Bluetooth adaptors—two lines just ain't enough.



Display and Amplifier On and Off Function

With the exception of the KDC-X991, all models KDC-MP338U or higher include an optional display off function that temporarily turns off the display when buttons are idle. Anytime the display senses idle time (not pushing a button), it turns off, but the lighting surrounding the radio stays on. This is a great feature at night when you don't want the lights on but need to see the radio to operate it. As soon as you operate the radio, it lights back up!

Amplifier Shut off

Amplifier shut off is available on KDC-MP438U and higher and can be adjusted in the stand-by. If you are using the radio as a preamp head unit with amplifiers, it helps reduce noise and keeps the radio cooler because the internal amplifier is not on. If it's not being used, why turn it on?

The KCA-iP200 cable is still available for customers with 2007 Kenwood head units. This inexpensive 2-wire cable enables high-speed iPod data at 12MB/bsps and has a 30-pin cable that terminates at the receiver by USB and stereo mini. Once connected, digital control, text from the files, etc., passes through USB; the audio passes through the analog (stereo mini) cable.



If a customer has an older iPod that can't be controlled by our USB, they can purchase the KCA-iP500 that plugs into our 5L changer bus. If he or she wants to buy a unit that doesn't have USB control like the KDC-MP338 or KDC-MP238, they'll need the KCA-iP500 as well. This adapter is one of the smallest and easiest to connect on the market. It plugs into the changer port of Kenwood radios 2002 and newer. Our iPod adapter doesn't require extra power and ground connections, so it's easy to install. (Note: the KCA-iP500 does not have a pass through for other 5L connected devices.)



External Media Control

With the exception of the KDC-MP208 and KDC-138, all 2008 Kenwood receivers have External Media Control for iPod connectivity with the KCA-iP500 iPod interface. The Kenwood receiver's disc up and down button selects playlists; the Scan button changes the search mode, Playlist, Artist, Album, and Genre. In addition to iPod connectivity, External Media Control allows hook up of satellite and HD Radio. (Keep in mind that units with USB inputs offer superior iPod control.)



Our PC Is PC Music Editor

Kenwood's PC Editor (Music Editor) program is included in the KDC-X991 and Kenwood models KDC-MP538U and higher. This year we're doing something different and including the owner's manuals on disc for models that have the PC Editor disc. We figure the disc is already in the box, so why not save a tree or two?

Music Editor is an optional PC desktop program that allows you to search, manage and select music files from your PC, so no matter what you're in the mood to hear, Kenwood makes it even easier to find. Original desktop software, Kenwood Music Editor performs powerful search functions on USB mass storage devices or portables that can be configured as mass storage devices. Search for music files from your entire PC library; search by Genre, Artist, Album and Playlist. Kenwood Music Editor also includes Playlist Generation technology that analyzes each song based on the tempo and categorizes them into familiar genres like Pop, Rock, etc.

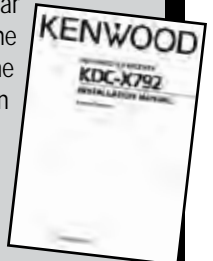

It's Lava Lamp Kind of Cool

Kenwood models with 3-line full dot display (KDC-BT838U and KDC-MP538U) include an interactive illumination that gives the radio a smooth, relaxing blue glow. (This feature is actually on all radios from the 5 series up; however, the 5 and 8 series have more illumination.) It not only looks cool in dash and on the sales floor, it enhances user operation by illuminating each time you turn the volume, track forward or backward, etc. If lighting isn't your customer's thing, you can adjust the setting in the standby mode menu. Blue illumination is also offered on the KDC-MP438U and KDC-X492 surrounding the front USB and aux input ports (a handy feature while driving at night).



Interactive Lighting

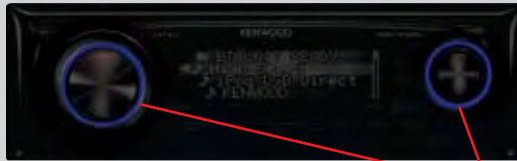

The lights surrounding the knobs flash when operating. Just the knob being used flashes.

Found on models 5 series and higher (except KDC-X991)
These lights can be turned off



The lights surrounding the knobs flash (5 seconds) when in modes or operating. Just the knob being used flashes.



All Kenwood and eXcelon in-dash CD receivers include either front aux or back aux inputs. Rear Aux inputs are for customers who prefer a cleaner look and would rather tuck their media devices in the glove box than connect it directly to the front of the receiver. Customers love the aux input feature because it offers so much flexibility when connecting auxiliary audio devices like iPods, MP3 players, video game systems, rear-seat video systems, and more.

The Dr. Phil of Aux Inputs

Our Aux connections are sensitive and can change the volume or input level according to the device being plugged into the radio. The output levels of most portable devices connected to the aux terminal are low because they are adjusted for headphones. In order to re-adjust this, we added an input sensitivity adjustment function. This allows the input to be gained up or down to match other sources. How's that working for ya?

Previous Flip Models

Previous models had two motions for opening the panel.



2008 Flip Models

This year's flip models have only one motion for the opening panel.

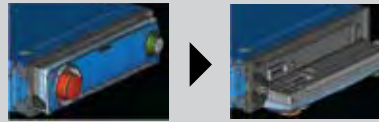

New Mechanism to Flip Over

Kenwood and eXcelon 2008 models with flip down removable faceplates are redesigned for quick and easy removal. Our previous models had two motions for opening the panel; 2008 units only have only one motion. It's quieter and smoother too!



Multi-Control Wheel

All eXcelon receivers and Kenwood receivers from the KDC-MP438U utilize an easy to operate multi-control knob. On the KDC-X492 and KDC-MP438U, it's combined with the volume control. On receivers above these models, it functions as a separate knob. Search by turning the knob/jog, then push in the knob. It's very easy and intuitive!

OEM Steering Wheel Interface

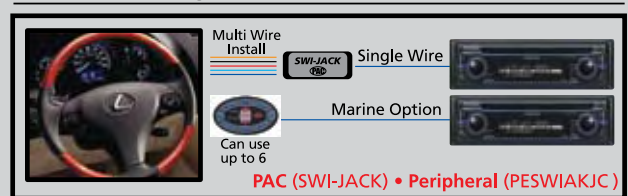

Steering Wheel Interface

- OEM steering wheel interface
- Wired interface
 - Prevents IR interference from sun
 - Available on KDC-MP438U and Higher Models

Eyes on the Road, Hands on the Wheel

All 2008 Kenwood models KDC-MP438U and up (and all eXcelon units) include a hard-wired IR input that makes it easy to interface with your customer's existing steering wheel control. The input interfaces with the PAC (SWI-JAK) and Peripheral steering wheel control adapters

(PESWIAKJC) and goes from a multi-wire to a single wire install. There is no external IR flasher to install and the adapter already has Kenwood codes on-board so the programming goes much faster. The OEM Steering wheel interface can even be used with our KCA-RC50MR in marine installations where multiple marine remotes (up to 6) can be wired to the remote control input. So whether you're fishing on the bow or steering her back to port, you can control the radio.

That eXcelon Edge **eXcelon**

The KDC-X991 may be a mighty titan; however, the KDC-X792, KDC-X692, KDC-X592, and KDC-X492 sport eXcelon exclusive features like special audio-grade capacitors on the power supply that provide stable current and reduce unwanted engine noise. All eXcelon receivers use 24-bit D-to-A converters, high pass (8 point) crossovers for front and rear, and 5 low pass filters for the rear. In addition, all eXcelon head units have a high gloss black finish and the KDC-X592 and higher offer either 3 or 4-line displays.

Don't forget that all eXcelon CD receivers play AAC, MP3, WMA files, have high-voltage pre-outs, USB Direct Control, 1 Wire Direct iPod Connection, aux inputs, System QEX/E's+, and are satellite, Bluetooth and HD Radio Ready.



The KDC-X792 has a few tricks up its sleeve, like a high-resolution (64-color full dot) customizable display. This unit also includes RDS technology and Kenwood's exclusive **Graphic Motion Analyzer**.



The KDC-X692's 4-tone full dot display makes it easy to browse a song list, search for a phone number, or read a **short text message**.

GRAPHIC Motion Analyzer

Graphic Motion Analyzer
GMA is featured on the KDC-X991 and KDC-X792 and lets drivers see the performance of their vehicle on the receiver display. (GMA allows some performance feedback to be displayed on the screen instead of standard full motion graphics, but no, it's not a video game.)



GMA offers five displays: G-Graphic shows lateral (sideways) movement of your car while you're taking corners. G-Meter displays a numeric readout of G-forces while you're accelerating. Turning G-Counter shows G-forces for acceleration over a 1-hour time period and will display average past, which, by the way, is a great way to monitor the use of your car when someone borrows it. GMA's built-in motion-activated stopwatch can be started and stopped when a key is pressed or when your car experiences forward G-forces and, horsepower function measures and records the max horsepower of your car.

QUICK TIP

Demonstrating Graphic Motion Analyzer

To show the customer the ins and outs of GMA:

1. Press the function (FNC) key on the faceplate to display the on-screen menu options.
2. Turn the multi-control wheel to Display Select
3. Push in the multi-control wheel knob to select
4. Turn the multi-control wheel to Display Type F
5. Push in the multi-control wheel knob to select
6. The screen will display an image of a vehicle

High Voltage Pre-outs Make Bag Pipes Sound Good

The 5-Volt and 4-Volt pre-outs on 2008 eXcelon receivers offer a larger signal to the amplifiers. The larger signal means that the amplifier gains don't need to be turned up as high so music is more dynamic with a lower noise floor and much cleaner, clearer sound. Take the time to explain this to a customer and it'll be simple to step them up to a Kenwood eXcelon in-dash receiver.



RDS (Radio Data System)

A feature on the KDC-X991 and KDC-X792, RDS allows small amounts of digital information to be carried over conventional FM radio broadcasts. This technology is widely used by the radio stations, and the benefit of radio with RDS is that it can transmit things like track/artist info on screen.



KDC-X592 includes the features of the **KDC-X692 but uses a 3-line full-dot display**. This unit also includes blue illumination effect that can enhance operation and make **the duller of dashboards look snazzy**.



KENWOOD

Listen to the Future

The next generation of affordable eXcelon is the KDC-X492 that includes a USB Direct Control, 1-wire iPod connection and illuminated front USB port and aux input.

KDC-X492: Amazing and Moderately Priced

Last year's KDC-X491 was a big hit with dealers because it offered many eXcelon step-up features at a price that attracted a broader range of customers. This year we're introducing the KDC-X492 with a 14 segment 13 digital display, 1-wire iPod connection and 3 4V RCA pre-outs. The KDC-X492 has many of the features of its eXcelon older brothers but is slot-loaded instead of flip down faceplate. Similar to the Kenwood KDC-MP438U, the KDC-X492 has front aux and USB inputs with blue illumination and sliding cover.

QUICK TIP

Activating Aux Inputs on 2008 Receivers

The aux input comes in the OFF position from the factory and will not be seen as a SOURCE until activated. All aux inputs (RCA type or 3.5mm type) need to be turned on. When the aux input is activated, it will appear as a SOURCE along with Tuner, CD, or SAT. For example:

To Activate the aux input:

1. Push the SRC button until the unit is in STANDBY mode.
2. Hold down the MENU button until the MENU is accessed.
3. Use the multi jog control to toggle up or down until AUX Off appears.
4. Press the multi jog control to the right until AUX On appears.
5. Press the SRC button.

*Head-units with Soft key interface use the Function button to access the menu.

To Adjust aux input volume:

The aux input can be decreased -8dB or increased +15dB to compensate for wide range of voltage and output by portable devices.

1. Press the SRC button until AUX appears.
2. Press and HOLD the Volume knob in until the Audio settings appear.
3. Use the multi control wheel jog to toggle up or down until V Offset appears.
4. Turn the Volume knob until the desired increase or decrease is reached.
5. Press any preset to exit.

AUX 1 and Aux 2

Aux 1 activates the aux in with no adjustments made to it. Aux 2 has the attenuation volume reduction engaged when the user switches between sources. This is to reduce noise if a device is not connected to the aux input. You must press the Att button to reactivate the aux input after it is chosen as a source to listen to the device.

Kenwood Receivers: We'll Take Them All On!

There's a Kenwood receiver for any budget, from the KDC-BT838U Advanced USB, AAC, WMA, MP3, CD receiver with built-in Bluetooth, to the easy-in KDC-138 CD receiver with front aux in. Models with USB Direct Control have 1-wire iPod connection, and Bluetooth compatible head units are ready for our new hands-free cell phone unit with A2DP music streaming. Interactive illumination can be found on several 2008 models, and we even added a steering wheel remote control interface on the KDC-MP438U and up.

Our KDC-MP738U includes a 64-color full dot display, USB Direct Control, 1 Wire iPod direct Connection, Supreme technology for compressed audio, Kenwood's Music Editor for PC, and a multi-function control wheel that makes finding your entertainment easier than ever.



One of the lowest priced receivers with a high-resolution display, the KDC-MP738U features the Multi-Control wheel for easy operation and plays **AAC, MP3, and WMA files.**



The KDC-MP638U includes the features of the KDC-MP738U but uses a **4-tone full dot high-resolution mono color display.**



The KDC-MP538U and KDC-MP438U are moderately priced models that offer USB Direct Control, 1-Wire iPod connection, and 3 RCA preouts. A unique feature of the KDC-MP438U is the front USB and aux in with blue illumination and sliding cover. The KDC-MP538U uses 3-line full dot display, while the KDC-MP438U has a 14 segment, 13-digit display.

Moderately Priced and Still Loaded

Four entry-level receivers are great buys for customers who want an excellent unit but can't fork out much cash. The KDC-138 CD receiver has a front-panel aux input with sensitivity control, subwoofer level control with bass boost, and even an RCA pre-out that can be used as a full range or subwoofer output. Its bigger brother, the KDC-MP208 WMA/MP3/CD receiver, has front panel aux input with sensitivity control, subwoofer level control with bass boost, RCA pre-out, and includes a remote control. The KDC-MP208 also includes a 14 segment 8-digit display.

The KDC-MP338 and KDC-MP238 have two RCA preouts and are Satellite, HD Radio, and Bluetooth Ready. Both have external media control so you can play and control your iPod with the KCA-iP500 iPod interface and include Supreme technology for compressed audio files. The KDC-MP338 even comes with blue illumination around the front aux input.



Priced to sell, the KDC-MP338 and KDC-238 are satellite, HD Radio and **Bluetooth Ready.**



For customers who want a great radio at a penny-pincher's price, our 2008 receiver line includes the KDC-MP208 and **KDC-138. Both have a front-mounted stereo mini aux input for connection to external audio sources or an iPod and both offer up 50 Watts x 4 MOSFET power.**



Supreme Technology

Supreme An exclusive Kenwood technology, Supreme brings sparkle back to compressed music files by restoring the critical high-frequency information lost during the compression process. With the Supreme function turned on (it's selectable in the setup Menu), your lower bit-rate (96 kbps) MP3, WMA, and AAC files will approach the sound quality of higher bit-rate recordings. Supreme is on all new eXcelon receivers and all Kenwood receivers above the KDC-208.

Full Range or Switched—Your Choice

The pre-out (rear or single depending on the model) can be full range or switched to accommodate a subwoofer amplifier. The output has a selectable low-pass crossover so that if the amp doesn't have it, or you'd like to tune the system from the driver's seat, now you can. The advantage is you can add a subwoofer amp and control it from the radio. This subwoofer out also includes a level adjustment, so the subwoofer volume can be adjusted from the radio, too.



Satellite Radio Options

Whether your customer is an XM fan or loves Sirius, 2008 Kenwood receivers are ready to play both. All Kenwood eXcelon in-dash CD receivers are satellite radio ready and other than the KDC-MP208 and KDC-138, all Kenwood in-dash CD receivers are satellite ready as well.

The overwhelming benefit is the vast number of music streams, sports stations, and the huge variety of talk programming available. Be sure to demonstrate Sirius or XM to customers and let them search through and listen to the different streams. Once they see that they can get all the entertainment they love, they'll be sold. Getting the subscription to Sirius or XM is quick. Visit www.sirius.com or www.xmradio.com for more info.

KCA-SR50 Kenwood Sirius Radio Translator

For In-dash Head Units In addition to the Sirius tuner, to add Sirius satellite, your customer will need to purchase the KCA-SR50. This interface box converts 5L CD Changer Protocol to Sirius SSP. It's compatible with SCC1 tuner and is for use with all 2008 CD Receivers and all 2007 and some older CD and video receivers.



Double the Fun

Our 2008 Kenwood line includes two double DINs, the DPX502 and DPX302. Double DIN options mean a bigger customer base, and Kenwood in-dash models set the standard for performance and function.

Replace your customer's factory double DIN with the DPX302 and they'll enjoy MP3, AAC and WMA playback. Expand the system by adding satellite radio, an iPod adapter, or even multi-channel HD radio. There's even a front aux input. Step up to the DPX502 and gain a front USB input, USB Direct Control, and Kenwood Music Editor. Both double DINs are satellite ready, HD ready, and Bluetooth Ready.

Hands Free and Happy

All eXcelon and most of our Kenwood 2008 in-dash receivers are Bluetooth Ready (it's built-in on the KDC-BT838U). Add our optional KCA-BT200 Bluetooth hands-free unit to one of our Bluetooth Ready receivers and your customers will bask in wireless freedom. The KCA-BT200 Bluetooth module has caller ID and can be paired with up to five Bluetooth enabled phones and download each phone's address book so they can be stored in your receiver. The receiver's keys can be used to dial a number, answer an in-coming call or end a call. The unit also has a microphone that can be mounted in the dash or headliner, and you can listen to the conversation through your car's front speakers. This hands-free unit dramatically improves the driving experience and promotes driver safety. *(Note: Compatibility may vary. Users should always check their phone and service provider for degree of compatibility. Check the Kenwood website for the latest compatibility chart.)*



Satellite Radio Connectivity Chart

| | XM Adaptor and Dock | XM Tuner | Sirius Adaptor | Sirius Tuner |
|--|-------------------------------------|------------|----------------|-----------------------------|
| 2008 Multi Media with KAB | KCA-XM100V | Mini Tuner | CA-SR20V | SCC1 or portables with dock |
| CD and Multi Media with 5 line/Changer Connection | Audiovox CNPKEN1 and Cable CPN200UC | Mini Tuner | KCA-SR50 | SCC1 or portables with dock |

The KCA-BT200 has a single 5L changer bus connection as well as a KAB adaptor cable for the new KAB bus line. This is for our 2008 multimedia products. It connects to compatible receivers using our single-wire 5L bus connection, and even includes a "pass-through" for additional devices like satellite radio or a KCA-iP500 iPod interface. It also has a KAB pass through for other KAB devices. The KCA-BT200 Bluetooth unit is compatible with all eXcelon models and Kenwood models, with the exception of the KDC-138 and KDC-MP208. Note: The input signal has to be the same as the pass-through. KAB in /KAB out or 5 line in/ 5 Line out.



Parrot

Let's Talk Parrot

Our KCA-BT200 includes chipsets by Parrot, creators of some of the most clever wireless chip technologies on the market. Benefits include updatable firmware for future phone compatibility, voice tagging, music streaming, text messaging and control over Bluetooth AVRCP and A2DP. Parrot chipsets embed a powerful DSP with a hardware accelerator, have low power consumption, and offer wide compatibility. They also provide extremely robust voice recognition capabilities in noisy environments. With voice tagging, you can select a name from your address book and hit record and say the name. It tags the address with the name and allows you to dial that person by saying their name.

Calling All Motor Mouths!

Kenwood's KCA-BT200 hands-free cell phone unit is the perfect solution for chatty drivers, not only because it has so many cool features and A2DP music streaming, but because 2008 ushers in new laws banning the use of hand-held cell phones while driving. Five states (California, Connecticut, New Jersey, New York and Washington), and the District of Columbia have enacted jurisdiction-wide cell phone laws prohibiting driving while talking on hand-held cell phones. Our KCA-BT200 lets you make and receive calls right from a compatible Kenwood receiver, call via direct dialing, phone book, or history and hear conversations through your vehicle's front speakers.

Come to the Display Board

Kenwood CD players' performance and features speak for themselves, but we've given them (and you) a little extra help with a cool demo mode. Units with the bright 64-color fluorescent display scroll through features and even demo graphics across the screen. It'll definitely get your customers' attention!

High-Pass/Low-Pass Crossovers

All 2008 Kenwood receivers have low-pass filters that allow only low frequencies to go to a subwoofer amplifier. Step up models have high-pass filters that keep low frequencies from reaching the full range speakers. This

lets you listen to tunes louder with less distortion and reduces the chance of damage. Also, any Kenwood receiver with built-in electronic crossovers have either a dedicated or switchable non-fading (subwoofer) pre-out with a ± 15 dB level control. These features make it easy for your customer to add a subwoofer to the system, giving them control over the sub's volume and the ability to improve the system's sound by experimenting with low-pass crossover settings, all without having to leave the driver's seat.

System E's

System E's has five high-pass crossover points for both front and rear independently at 80,100,120,150, and 180 Hz. System E's also has a low-pass filter at 60, 80, and 120 Hz. On the units that have only front and rear pre-outs, the rear pre-out can be switched to a non-fading sub out with selectable low-pass filter for this output.

System E's+

For the ultimate crossover experience, check out the System E's+. It works the same as System E's but offers more crossover points – eight high-pass and three low-pass. Independent Front and Rear High Pass filters selectable at 40, 60, 80, 100, 120, 150, 180, 220Hz or through at 12dB per Octave. Low pass filter 50, 60, 80, 100, 120 Hz or through at 12 dB per Octave.

Digital System E's +

Found on the KDC-X991, this is the same as System E's+ with 12 high-pass and 13 subwoofer crossover points and selectable slopes at 12, 18, and 24 dB per octave. Independent front, rear high pass filters and subwoofer low pass filter selectable at 30, 40, 50, 60, 70,80, 90, 100, 120, 150, 180, 220, 250 Hz or through at 12/18 or 24 dB per octave.

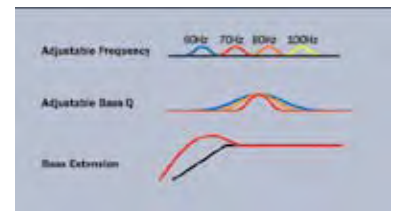

System Q and System QEX

You'll find powerful sound controls on all Kenwood head units. Even our entry level product has System Q which allows for Bass, midrange and treble adjustments. eXcelon product features System QEX which adds adjustment of the centering frequency, Q, and even the low-end extension in the bass frequencies. With this much adjustment capability, the sound can be perfectly tailored to the listener's taste.

Dual Zone Source & Volume Control

Customers with kids will love the Dual Zone Source and Volume Control feature found on all eXcelon in-dash receivers, KDC-MP438U and up in the Kenwood line, and our DPX502 double din. With Dual Zone Source and Volume Control, the kids in the back can zone out on cartoons while the grown ups listen to tunes.

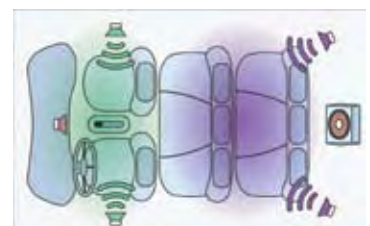

QUICK TIP

System E's + and Electronic Crossovers

To build a cost effective system, power the rear speakers from the in-dash receiver's speaker outputs with the receiver's high-pass crossover activated. With the high-pass crossover in the system, the speakers typically won't need as much power as the front speakers and they'll play almost twice as loud as they would if they were driven full range. This lets the customer budget more money for the front and sub amplifiers, giving them a better-performing system all the way around!

Dual Zone Source Control plays different sources through the front speakers and the rear speakers at the same time, which is perfect for vehicles that have rear-seat video systems. Generally, the in-dash sources are available to play up front, while any sources connected via the 5-Line (changer) bus or aux input can play in the rear. Remember that activating Dual Zone shuts the subwoofer off, and SRS WOW has to be off to activate Dual Zone. Also, it is possible to reverse the sources (play the in-dash sources in the rear and the 5-Line/aux input sources in the front) via the menu system. All 2008 eXcelon receivers come with a remote with a Dual Zone button and rear volume control.

Handy Remotes

Don't forget about the remote controls included with all eXcelon receivers and all Kenwood in-dash receivers except the KDC-138. The grip-type line is ergonomic, sleek, and just large enough that it won't get swallowed by car seats. It's a great sales tool, so be sure and have one handy and let the customer use it.



Most of our 2008 remote models offer a 2-zone button and a volume control for the rear zone. This feature allows audio from a rear video source to play through the rear speakers while the driver listens to a different source in the front. Having the 2-zone and rear volume buttons on the remote is a valuable feature because the driver doesn't have to search through the menu to turn the feature on and off. With the remote, it's instant access.



Experience HD Radio

All eXcelon receivers are HD Ready, and with the exception of our KDC-MP208 and KDC-138, all Kenwood receivers are as well. Combine a Kenwood HD Radio Ready receiver with our KTC-HR200 HD Radio Tuner and customers will experience a new world of digital broadcasting. With HD radio, FM broadcasts sound is close to CD quality and AM broadcasts sounds close to current FM analog. HD radio will also display the Artist, Song Title, etc., on the receiver's screen.

Perhaps the coolest feature of HD Radio is multi-casting or the ability to broadcast two or more programs simultaneously. Just as cable TV allowed specialized local networks, multi-casting provides the potential for stations to offer more niche programming. Multi-casting is a pretty big deal because it lets stations tailor broadcasts and gives listeners a much bigger variety of programs. For instance, a public radio station can broadcast morning news on one "channel" and classical music programming on another channel. It's the same radio station, the same frequency on the dial, but multiple options for the listener.

The KTC-HR200 is for use on the 5-Line for head units and **KAB on video units.** It's compatible with HD Multicasting and **has RDS technology.**

Most major markets have local stations already transmitting in HD Radio, which means your customer is sure to find either their favorite morning show, local traffic, or favorite local DJ in crystal-clear digital. HD Radio programming content is the same as its analog counterpart and so is the same broadcast frequency, but its higher-quality sound and reception are available with no service fees.



QUICK TIP

Installation

The KTC-HR200 HD Radio tuner is your customers' gateway to HD Radio and requires only two connections: a 5-Line cable from the receiver's changer port (or the KAB adaptor included), and a connection to the vehicle's standard AM/FM antenna. The tuner also has a pass-through to connect other accessories. Note: the KTC-HR200 has switches to set it up for either KAB or standard 5 Line communications. The output can only be used for the same type of communication the input is set to. (Example: KAB in/KAB out.) The KTC-HR200 serves as both the analog and digital tuner for the connected receiver, and it switches seamlessly between both types of reception as required. The customer can also manually switch between broadcast reception modes in the in-dash receiver's menu system: Auto Mode allows the KTC-HR200TR to automatically switch between analog and digital reception depending on what the station is broadcasting; Digital Mode will only receive digital signals; Analog Mode only receives analog signals.

The artist, song title, and other text information that are broadcast along with the station's content can be shown on the receiver's display whenever the KTC-HR-200 is receiving a digital signal.



KDV-412: If you have video screens installed for the rear-seat passengers but want to control the system from an in-dash DVD player, the KDV-412 is a full-featured DVD receiver with 50 x 4 output, CD, MP3 and WMA playback. It's also compatible with our KCA-BT200.

With Dual Zone capability, you can send a fixed-level audio signal from the DVD to the back-seat monitors (like our LZ-702IR with built-in IR transmitter), while the front seat enjoys music from satellite radio or an iPod.

QUICK TIP

Make sure your customers know that Kenwood backs up Kenwood and eXcelon products with great warranties:

- Kenwood eXcelon in-dash receivers: two years parts & labor
- Kenwood receivers/amps/speakers: 1 year parts & labor
- Kenwood eXcelon power amplifiers: two years parts & labor
- All Kenwood eXcelon speakers: two years parts & labor



carportal™
EXPANSION SOLUTIONS™

KENWOOD CarPortal™ EXPANSION SOLUTIONS

Kenwood believes there are two types of dealers: those who love CarPortal™ and those who will. CarPortal™ Expansion Solutions are putting energy back into the install bay and helping dealers reclaim profit. This year, we're introducing the KOS-L432 4.3-inch touchscreen.

The KOS-A200 Slam Dunk

For customers who want a cost-effective solution for adding satellite radio, HD Radio, or portable music players, the KOS-A200 is a slam dunk. The KOS-A200 lets customers leave their factory radios in tact and add great after-market technologies like our KCA-iP500 iPod adapter, Sirius or XM radio, the KTC-HR200TR multi-channel HD Radio tuner, as well as Kenwood CD players and changers. An auxiliary RCA-input also lets you add audio from portable DVD players or game consoles.



The KOS-A200 is an easy install. Find power, ground, and switched power, run a remote eye, two antenna adaptors and your customer's two-year-old vehicle now has the latest technology.

In addition, if the factory radio has RDS (and most cars do) the KOS-A200 will take the text information from your text-based sources (satellite radio, HD Radio, USB player, iPod, or CD-Text enabled changer) and convert it to RDS. So along with the audio, the text information is modulated and transmitted to the factory radio.



There's Money in Them Frills!

Our CarPortal™ V Series is where the serious scratch is, and it's a wise dealer who learns how flexible (and profitable) these products can be. USB inputs allow you to add USB storage devices, satellite radio, HD Radio and high-speed control of both iPod audio and video. The KOS-V1000 and KOS-V500 also include GUI functions like changing skins, background customization, remote controlled GUI operation as well as support of USB mass-storage devices and full iPod control.



The KOS-V1000 (eXcelon line) includes two USB inputs, 3 sets of 5V pre-outs, 2AV inputs/2 AV outputs, and four **relayed outputs (external switches)**.



The KOS-V500 has 1 USB port, 3 sets of 2V pre-outs, 2 AV inputs, 1 AV output and **2 relayed outputs (external switches)**.

With CarPortal KOS-V1000 and KOS-V500, the expansion capabilities are practically endless: System E's+ crossovers, reverse camera input, and RGB input for navigation. Convergence features include external switches to control things like garage doors, security gates, car accent lighting, and more. Both display ID3 tag information from MP3 players, and both systems are Bluetooth Ready.

Both systems accept speaker-level output from factory radios (100mv-15 volts) and work with floating ground, common ground, and balanced output. Both turn on with accessory power or by detecting the audio signal.



Add the KOS-CV100 RGB-to-Composite adaptor and a third party factory screen interface and the KOS-V1000/KOS-V500 can display the information on the vehicle's **factory LCD screen. You can install the included IR receiver on/near the dash and control the system with the included remote.**



External Switches: Let Your Custom Side Shine

The external switches on the KOS-V1000 and KOS-V500 are a great opportunity to show off your custom skills. These switches are a trigger that must be properly wired to an external relay for powering electrical devices. The external switch has 100 steps. On position 1, it will send a 500 ms pulse. With each step after the first pulse, the length increases 200 ms. For instance, if you have the pulse set to position 3, then the pulse length is 900 ms or almost one second.

CarPortal KOS-V1000 1968 Firebird



A Custom Console was created to house the screen, Gauges and iPod. Cup holders were also added.

In this application the KOS-V1000 is a **stand alone system**, the factory radio is no longer connected.

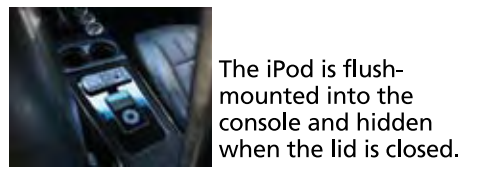

- Source Screen controls the system 
- Bluetooth Control 
- Satellite radio 
- Navigation 
- iPod- Video 

The CarPortal™ KOS-V1000 is a great solution for customers **with classic cars. This 1968 Firebird** has a state-of-the art A/V system and the dash board **remains in tact.**

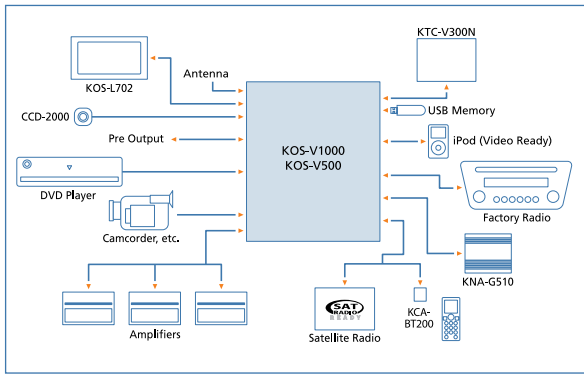

The KOS-V1000 or KOS-V500 can turn your customer's ordinary factory system **into the ultimate cruisin' machine.**



With the KOS-L702, the factory radio becomes one of many sources **in the system.**

The KOS-L702 Touchscreen Powerhouse

The KOS-L702 is a 6.95 inch LCD touchscreen monitor that controls the CarPortal™ KOS-V1000/V500 and offers customers the latest in touchscreen technology. It works harmoniously with existing factory radios and screens, or it can replace factory screens.

The KOS-L702 comes with a flush-mount trim bezel and offers flexible installation options. It can be mounted just about anywhere—inside a car's interior, inside a custom mount, hidden away in the glove box. It controls the functions of the KOS-V Series so users have instant access to mobile entertainment, high-speed iPod control, Bluetooth hands-free cell phone technology, satellite radio, navigation and more.

The KOS-L702 includes a shielded connection cable, hard key controls for volume, video, Menu, etc., and direct select for sources like satellite radio, navigation iPod, USB, video, HD Radio, DVD, etc., via the graphic user interface from the KOS-V1000.



The KOS-L432 Space Saver

This year, Kenwood introduces the KOS-L432 4.3-inch touchscreen monitor for use with CarPortal™. Paired with CarPortal™ KOS-V1000 or KOS-V500, the KOS-L432 offers direct select of satel-

lite radio, iPod, USB, Video, HD Radio, and more. Its compact size makes it ideal for on-dash mounting in smaller vehicles as well as where space for a video monitor is limited. The KOS-L432 includes a 7-meter shielded connection cable, a flush-mount bracket for custom installations, and an AAMPS-compatible bracket.

KOS-V Series Using the Factory Radio as a Source

The customer wants to **add Navigation, Bluetooth, Sirius and iPod control.**



Another example of CarPortal™ versatility! Problem: If the factory radio is removed, the **customer loses the trip computer functions.** Solution: The KOS-L432 is mounted in the console, and the factory radio becomes another **source on the KOS-V500 or KOS-V1000.**

* KOS V-SERIES FEATURE TABLE *

| FEATURES | KOS-V1000 | KOS-V500 |
|------------------------------------|---|-----------------------|
| Music Playback Support | AAC, WMA, MP3 (via USB, iPod) | |
| USB Ports | 2 with Direct Control | 1 with Direct Control |
| Navigation Ready | YES (with KNA-G510, KNA-DV4100, KNA-DV3100) | |
| Bluetooth Ready | YES (with KCA-BT100 or KCA-BT200) | |
| Satellite Ready | YES | |
| HD Radio Ready | YES | |
| External Relays | 4 | 2 |
| Internal Power | 50W X 4 | 50W X 4 |
| RCA Preouts | 3 Gold @ 5V | 3 @ 2V |
| Multitask Browser | YES | |
| A/V In/Out | 2 AV In / 2 AV Out | 2 AV In / 1 AV Out |
| RDS Enabled | YES | |
| System Expansion | Amps, Speakers, Subs | |
| DVD Player Support | YES | |
| Backup Camera Input | YES | |
| Output for Back Seat Entertainment | YES | |



«« MARINE

MARINE ENTERTAINMENT

Did you know that Kenwood offers a full line of marine receivers, speakers and amps? Now you do! We put extensive planning and research in developing a line of marine products specifically for boating enthusiasts.

Receivers and Remotes

Designed for the rough marine climate, Kenwood marine CD receivers deliver superb audio quality and include conformal-coated PCB for durability and large LED displays. All three Kenwood marine receivers have RCA pre-outs, External Media control for portables like iPods, and are HD Radio and Satellite Ready.



Both the KTS-MP300MR and the KTS-MP400MR are single-din but the front panel is larger than DIN to enable the screws on both the left and right sides to be used to bolt the unit to the mounting surface. This creates a water-tight seal around the rubber gasket. Both models have full memory back-up, conformal coating, easy-to-read displays and are HD and Satellite ready.



The KDC-232MR marine receiver includes a detachable faceplate and conformal coating for the main PCB. The rotary encoder and jog control knob make finding music easy!



Available in black or white, the KCA-RC50MR wired marine remote is a great way to control your Kenwood marine receiver.

Speakers, Subs and Amps

Complementing our marine receivers is a full line of speakers. Features like a 6½" water-resistant cone and surround, a fully UV-resistant grille and frame, anti-corrosive speaker terminals, and rubber coated tinsel leads allow these speakers to perform well in the harsh marine environment.

Available in either black or white, the KFC-1652MRW includes a UV-resistant grille and frame, anti-corrosive speaker terminals and **rubber coated tinsel leads.**

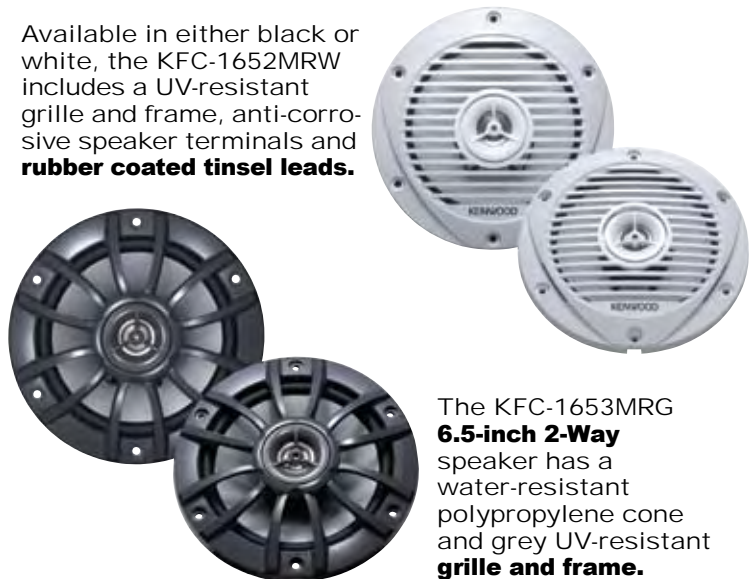

The KFC-1653MRG **6.5-inch 2-Way** speaker has a water-resistant polypropylene cone and grey UV-resistant grille and frame.



The KFC-W254MRW 10-inch woofer features 700 Watts power handling, high-roll butyl rubber surround as well as a long-throw single voice coil. Since it can be difficult to find space for a woofer enclosure on a boat, the KFC-W254MR performs exceptionally well in a free-air application.

In addition, the P-WD250MRW marine amplifier is available in a package with a dual voice coil version of the stand-alone 10" subwoofer. It features Class D amplification, allowing it to power the subwoofer with 200 watts, all while remaining extremely efficient.

The P-WD250MR combines a **Kenwood amplifier designed** for marine use and a 10-inch Marine grade dual voice coil **subwoofer.**





MOBILE VIDEO

KENWOOD MULTIMEDIA

If you thought last year's video and navigation lineup was a hit, you're right, it was. This year, even better entertainment/navigation systems hit shelves, including the DNX8120 with built-in navigation, entertainment and Bluetooth. The DNX7120 improves on the already popular platform of the DNX7100, and we're adding several price-friendly units to the mix.

Features you'll find on all new 2008 Kenwood and eXcelon models include:

- USB Direct Control
- 50W X4 Power
- KAB External Media Control
- Multiple pre-outs for system expansion
- Customizable wallpaper
- Rear view camera connection
- USB, DVD, AAC, MP3, WMA compatibility
- Navigation, Bluetooth, Satellite and HD Radio Ready

Step-up features in the eXcelon lineup include:

- USB Direct Control (2 interfaces)
- High voltage (5V) pre-outs
- Two External Switches for operation of external electronic devices
- Built-in Bluetooth (DNX8120 and DDX812)
- Dolby and dts 5.1 Surround (DNX8120 and DDX812)
- 13 band EQ (DNX8120 and DDX812)



See the connection? Kenwood multimedia gives customers options!



Built-in navigation, built-in entertainment and built-in Bluetooth...you have to ask yourself, what's not inside this box?

DNX8120: The Best All-in-One Indash in the Universe

There's some back-patting going on at Kenwood over this year's eXcelon 8 series, especially the DNX8120. This crazy fresh all-in-one system includes the Bluetooth hands-free cell phone operation, Garmin navigation technology system, and the latest NAVTEQ mapping technology. Combined with our easy-to-use GUI, the DNX8120 is perfect for customers looking for an all-in-one solution.

Entertainment features of the DNX8120 include a 6.95-inch fully motorized touchscreen with improved 3D GUI and 3-skin selection. The screen also includes an industry exclusive reverse angle setting which reduces glare and increases on-axis viewing for vehicles with a sloped dash. We also added a nifty customizable feature that allows you to create your own boot-up screen.

The DNX8120 includes 2 USB interfaces with USB Direct Control for easy access to portable music devices. Add our KCA-iP300 iPod cable and your customer gains the fastest control of iPod audio and video files. In addition, two external switch control relays allow users to control electronic devices directly from the touchscreen.



There's a Message in Our Model Names

DNX refers to Double DIN models with built-in entertainment and navigation. DDX refers to Double DIN video monitors. KVT equals retractable 1 DIN video monitors.



The DNX8120 also caters to customers who appreciate high quality audio features like 5.1 (5V) pre-outs for Dolby and dts surround, digital time alignment, and a unique EQ feature that allows you to paint your EQ curve right on the interactive touchscreen.



Sure Beats Dialing from A Cell Phone!

Bluetooth technology really shines on our video monitors because it offers customers so much freedom and ease of use. Features of the KCA-BT200 Bluetooth hands-free cell phone module are built into the DNX8120 and DNX812. Both units offer hands-free cell phone operation with voice dialing, even in noisy surroundings, and users can text message directly through the touchscreens. All your customer needs is a Bluetooth compatible phone and they're on their way. (We'll cover more about the KCA-BT200 later.) *(Note: Compatibility may vary. Users should always check their phone and service provider for degree of compatibility. Check the Kenwood website for the latest compatibility chart.)*



The DDX812 includes the clever entertainment features of the DNX8120 minus the built-in navigation.

Customers who like the entertainment features of the DNX8120 and the built-in Bluetooth but are not into the whole Nav thing (or already have a portable navigation system) should check out the DDX812. Like the DNX8120, it has a 6.95" fully-motorized touchscreen with reverse tilt, new GUI with changeable skin and a customizable start-up screen.

Both the DNX8120 and DDX812 incorporate new front panel cosmetics that look very sleek installed, and the touchscreen controls and on-screen menu system are easy to operate.



The Fastest Connection Available (We love saying that)

Kenwood's high-speed USB interface offers super fast access to iPods and other portable music devices. All 2008 eXcelon and Kenwood monitors have rear-mounted USB inputs (2 inputs for eXcelon) accessed via a one-meter pigtail cable. Our USB 2.0 Direct Connection has a data rate of 12MB/bs (way faster than conventional serial connections), and Kenwood's USB Direct Control can play almost any music format and almost any USB mass storage device. It even charges the device's battery!

Remember that iPod High Speed control (and the ability to control iPod functions via the monitor) refers to fifth generation (Nano and iPod Video released after September 2005) devices. Kenwood multimedia units will play and control video files on the New Nano, Classic and the iPod Video. Most customers will have newer iPods but save yourself from "angry guy" and make compatibility clear up front. Go to kenwoodusa.com for firmware upgrades and iPod compatibility charts. (Important Note: If your customer has iPod Touch, it will play audio only.)

Our video monitors let you browse the contents of your iPod without interrupting current song/video playback (multi-taskers will love this). Use the easy scroll bar to flip through your files page by page, or just slide your finger down the bar to find music at a specific point. Although video playback on the monitor is restricted while the vehicle is in motion, you can control all video functions and the signal can be output for the backseat monitors.

To enjoy high-speed iPod control of video files, customers need to purchase our KCA-iP300V iPod cable. This inexpensive cable has a 30-pin cable and terminates at the monitor by USB and includes two mini jacks. Kenwood offers one of the few systems on the market that offers full control over iPod video files from the touchscreen. Most other systems require you to start the files from the iPod. Simply connect the iPod to the USB and two separate mini-jack inputs, one for audio and the other for video. This multi-wire scheme lets you control and charge the iPod, play back audio and video files, and even displays multi-line text with album artwork on-screen.



External Switch Control: For A James Bond Kind of Touchscreen



All 2008 eXcelon multimedia units and the Kenwood the DNX7120 and DDX712 include two external switch controls accessible from the main screen. This truly custom feature lets your customers control external electronic devices right from on-screen icons and is an excellent selling feature.

Remember, the External Switches are just a trigger and need to be properly wired to an external relay for powering electrical devices. Individual switches can be set to either "latched" or "pulse." The latched setting is like flipping a light switch—it's either always on or off. The pulsed setting turns on at the button push, but only stays on for a pre-determined amount of time before automatically switching off.

Multimedia - External Switch (Relay Switch)

- Found on Excelon Multi Media, DNX7120, and KOS V product.
- Connect EXT SW wire to device or relay
- Sends a positive trigger
- On-screen buttons can be labeled
- Can be set to:
 - Latched
 - Pulsed (timed from 0-20 seconds)

For Example: Garage opener • Rear monitor

Opener Remote-controller SW relay

Unleash your creativity with endless possibilities:

- Lowering third row seats on SUVs
- Controlling rear seat monitors
- Controlling interior or under-car lighting
- Popping the trunk
- Opening electronic gates or garage doors
- Driving lights or fog lights

QUICK TIP

Timing and Increments of the Pulse

The external switch has 100 incremental settings. These settings can be adjusted from a half a second up to 50 seconds. This is helpful when setting various timed devices like a motorized amp rack (10 seconds), a sunroof (8 seconds), or closing the gates (15 seconds).



Pattern 1: Carbon-like line pattern

Pattern 2: Fire

Pattern 3: Water

eXcelon and Kenwood DNX and DDX video units have super intuitive **touchscreens with three skin patterns.**



So Easy A Grown-up Can Use It

Our 2008 touchscreen interfaces are so easy to use, your technophobic grandmother will be hooked. Don't look for the V Select button on our new 7 and 8 series monitors because it's not there. When users select the source, like navigation on the front screen, it takes them right to navigation screen. What a concept! Hit the DVD icon and the motorized screen is ready to load. Plug in an iPod and the screen goes right to that source. (Hard key select buttons are still located on the front panel.) It will also display album artwork (if available) for both audio and video files; the artwork is displayed in the window on left side of the screen.

Three-skin menu is back on the 7 and 8 series models with a few twists, like a motion graphic flame and carbon-like background. Three skin select is available in fire, water and line pattern and is accessed directly from the main screen.

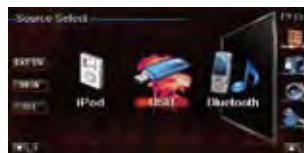

Pick Your Faves

Our 2008 eXcelon and Kenwood video units include a Source Select feature that lets you pick three favorite icons, like iPod, Tuner, and DVD. Selectable from the Setup menu, choose any source you want, and you can even name the icons like PlayStation instead something lame like Video 1 or Video 2.

Bring It on Back

This year's 7 and 8 series DDX and DNX models also allow users to select the panel close position that best matches the tilt of the vehicle's console. Whenever the key is turned off, the unit will go back to the home position or saved position. The panel's close position is stored in non-volatile memory so it remains even if battery power is lost.

Background Check



Our 2008 line lets you transfer and store three digital images to use as a wall-paper background. Simply save the images to a USB thumb drive and transfer the images to the monitor's memory using the USB connection. Up to three images

can be stored into memory and changed at will. Because these monitors feature a widescreen display, digital photos and images in widescreen work best. Images can be deleted individually to free up room for additional wallpaper. Pictures sized to 480 x 260 seem to work best and fill the screen. **Tip:** On 2008 models press the "SOURCE SELECT" for 3 seconds and the icons will be removed from the screen. Touch the screen again and the icons will reappear.

The following chart is a handy guide to finding the best picture size.

Wallpaper and Start-up Screen Picture Size

| | Picture Format | File Size | Color |
|---------|-----------------|----------------|-------------------|
| DNX8120 | JPEG .jpg .jpeg | 480x234 pixels | 16Bit |
| DDX812 | JPEG .jpg .jpeg | 480x234 pixels | 16Bit |
| DNX7120 | JPEG .jpg .jpeg | 480x234 pixels | 16Bit |
| DDX712 | JPEG .jpg .jpeg | 480x234 pixels | 16Bit |
| DNX5120 | JPEG .jpg .jpeg | 480x254 pixels | 24 Bit Full Color |
| DDX512 | JPEG .jpg .jpeg | 480x254 pixels | 24 Bit Full Color |
| KVT-512 | JPEG .jpg .jpeg | 480x270 pixels | 24 Bit Full Color |

Audio Geek Heaven

For your audiophile customers, the 8 Series offers a customizable EQ feature that allows users to customize audio setup based on a 13-band EQ curve. Access this feature from audio set, go to equalizer, and "paint" your musical preference for front, rear, and center channels.

KAB (Kenwood Advanced Bus)

A new feature on all new release video pieces is the Kenwood Advanced Bus or KAB. It's a much faster interface for accessory devices (10 times faster than our 5L bus) and has automatic device recognition. For example, if you're installing Sirius Satellite, you no longer need the KCA-SR50 interface box but simply the CA-SR20 cable. (Don't worry, our accessories like Bluetooth/Sirius/XM and HD radio will all support both connections.)

We believe KAB is a giant step toward future expansion and will eventually transition all of our products to this new communication system. For now, it can only be found on the 2008 double DIN and the KVT-512 multimedia products.

QUICK TIP

USB Options

You can use the rear-panel USB connection for either a USB device or iPod with the KCA-iP300V cable. When using the KCA-iP300V, the USB is used in conjunction with two mini-jack (1/8") connections for Direct USB Control of Video iPods. The USB always stays "hot" when the unit is on, so when it's not in use it can charge portable electronics like cell phones, PDAs or a Bluetooth headset.

Our CA-U1EX USB mounting/extension kit lets you put a USB port just about anywhere your customer's heart desires. Mount it in the dash, under the dash—the possibilities are endless! The kit comes with a flush-mount bezel, which is cool when you see it installed, and an under dash mount. There's USB-to-USB and a USB-mini-to-USB 1 meter cable, so it will work with just about any cord combination.



Behold the next generation all-in-one entertainment/navigation system, the DNX7120!

Kenwood 7 Series (We made the DNX7100 Even Better)

Last year's DNX7100 all-in-one entertainment/navigation system was the industry golden boy with sales that exceeded all expectations. Of course, we improved this already popular platform with the DNX7120. The new unit carries over all the fun features on the DNX7100 and includes new front panel cosmetics and enhanced GUIs functions.

With a built-in Garmin Navigation board, the DNX7120 uses NAVTEQ mapping technology for premium-quality map data. The system also uses flash memory for mapping so there are no discs to worry about, and it allows mapping upgrades through an SD card. Other navigation features include XM NAVTraffic (optional) for live traffic information and XM Satellite entertainment. (Kenwood GXM30 XM tuner and XM subscription required.) XM NAVTraffic displays real-time traffic conditions and suggests alternative routing. The DNX7120 also includes RDS-TMC (optional) for live traffic information through local FM broadcasts (Kenwood GTM10 tuner and subscription required).

There are tons of entertainment features starting with a 6.95-inch video touchscreen with simple controls and expanded screen with reverse-tilt auto slide mechanism. The DNX7120 offers drivers visual simplicity and one-touch control over USB storage devices, including iPod music and video, and is Bluetooth compatible (KCA-BT200 unit required) for hands-free cell phone conversation and touchscreen operation. This unit is also RT+ compatible so it allows FM radio to show the text information that is most popular with consumers, such as artist and title information.

Digital file friendly, the DNX7120 plays MPEG 1 & 2, JPEG, MP3, WMA, MPEG-4, AAC, and DivX, while the 6.95" video touchscreen allows simple control of DVDs, CDs, and VCDs. An expanded screen with reverse-tilt mechanism provides a stunning viewing area for movies, navigation and photos and one-touch control over USB storage devices, including iPod music and video.



The DDX712 contains the entertainment features of the DNX7120 but does not **include built-in navigation. Customers can always add KNA-G510 navigation later with our Nav ready inputs.**



The DNX5120 All-in-One Entertainment/Navigation has a **6.1" fixed screen, USB Direct Control** and is Bluetooth, satellite and HD Radio ready.

The New Kenwood 5 Series: Tastes Great, Less Filling
Even budget-conscious customers can enjoy awesome in-dash video with our new Kenwood 5 Series: the DNX5120, DDX512 and KVT-512. These models offer many of the advanced features of the 7 Series minus a few, so we can pass on the savings.

The DNX5120 is the DNX7120 "light" with a fixed 6.1" touchscreen, front aux input, and 2 RCA pre-outs with switch-able rear/sub and Crossover. Like the DNX7120, it includes a built-in Garmin Navigation Board with maps of U.S., PR, Alaska and Hawaii. This unit does not include 3 skin select and has 2 RCA pre-outs as opposed to three. The GUI does have the customizable start-up and Variable Illumination that allows users to customize their display to match the interiors of their cars. (Keep in mind that there is no SD card slot, so mapping updates are done via DVD.)

LOADING/CHANGING START-UP SCREEN (5 SERIES)

1. First connect the USB Thumbdrive containing image file.
2. To enter setup Mode, press SRC+EJECT, then RESET.



- Press and hold SRC & EJECT keys, then press RESET Key.
- Release reset key, and hold SRC & EJECT Key until Red LED activates.

SRC + EJECT + RESET



- If you want to change the opening image to your own image (i.e., company logo), Press OEM Image.
- If you want to put original KENWOOD opening back, press KENWOOD image.



- Select the image you want to use.
- When the image is loaded, select Enter



Your new opening will remain for few seconds and then switch to the Source Select menu.

LOADING/CHANGING START-UP SCREEN (7 & 8 SERIES)

1. First connect the USB Thumbdrive containing image file.
2. To enter setup Mode, press SRC+EJECT, then RESET.



- Press and hold FNC & EJECT keys, then press RESET Key.
- Release reset key, and hold FNC & EJECT Key until illumination activates.

FNC + EJECT + RESET



- If you want to change the opening image to your own image (i.e., company logo), Press OEM Image.
- If you want to put original KENWOOD opening back, press KENWOOD image.



- Select the image you want to use.
- When the image is loaded, select Enter



Your new opening will remain for few seconds and then switch to the Source Select menu.



The DDX512 offers the same entertainment features of the DNX5120 but does **not include a built-in navigation system. It uses a 6.1" fixed touchscreen with customizable start-up, USB Direct Control, 2V pre-out, and front aux input.**



KVT-819DVD



KVT-719DVD

The new KVT-512 is a full featured DVD Entertainment System with a 7" motorized touchscreen and Variable Illumination. It also includes USB Direct Control and two sets of (2V) pre-outs with switchable rear/sub and crossover. Other features include a customizable opening screen, and Source Select customization. And here's a big plus—this unit doesn't have a hideaway box so installation is a breeze.

KVT-819DVD and KVT-719DVD

These two beauties carry over from last year with software updates for newer iPods. Both include superb video images and intuitive touchscreens and are packed technologies like two USB Direct control ports on the KVT-819DVD—one for Direct iPod audio/video control and the other for almost any type of USB mass storage device. Other features include two External Switch control outputs (KVT-819DVD) for triggering electronic devices like rear seat monitors, under car lighting, or even garage door openers! These models also include advanced performance features like 24-bit high-resolution DAC, System E's+/System Q-EX and Dual Zone capability.



DVD-Audio

For the ultimate in recorded sound, all 8 series models can play DVD-Audio discs, the format of choice for audiophiles. In 2-channel playback mode, DVD-Audio discs feature a 24-bit resolution and a sampling rate of up to 192 kHz (vs. a 16-bit, 44 kHz sampling rate of a standard CD) resulting in a stunning clarity and realism.



RDS (Radio Data System) with RT+

A feature on all eXcelon video units and the DNX7120, RDS allows small amounts of digital information to be carried over conventional FM radio broadcasts. Kenwood has adopted the latest version of RDS with RT+, which gives radio stations a lot of flexibility. RDS with RT+ can broadcast information like artist, album, song title, call-in numbers for talk shows or contests, and more.

Camera Happy

All Kenwood video receivers include a dedicated rear-view camera video connection. This standard RCA style connection works with the Kenwood CCD-2000 back-up camera, or any brand using a RCA connection. There's also a wire on the receiver that connects to the reverse light circuit. When the vehicle is put into reverse, the back-up camera image appears onscreen. In the receiver menu the image can be set to normal or reverse image.



QUICK TIP

The CCD-2000 Rear View Camera is a great add-on to Kenwood systems. It has a reverse image function, high resolution color picture (Approx. 270,000 pixels), wide viewing angles, and a 1.5 LUX for excellent night vision. It has a weather-resistant housing and the mounting bracket and accessories are included.

Bring on the Bass

When your customer is ready to add external amps for speakers and subs, they can choose between the 5.1 (5V) RCA pre-outs on the 8 series DNX and DDX, 3 (5V) RCA pre-outs on the KVT-819DVD, 3 (2V) RCA pre-outs on the Kenwood 7 series, and 2 (2V) RCA pre-outs (with switchable rear or sub) on the 5 series DNX, DDX, and KVT. Enhanced audio features like Dual Zone audio control, and A/V switching (2 A/V inputs for eXcelon, 1 AV input for Kenwood) make Kenwood video the perfect source and controller. For systems without external amps, the internal 50 Watts x 4 MOSFET power amp is ready to take on their speakers.

Security Details

All Kenwood video receivers have two built-in security features. All multi-media receivers have a user-selectable four-digit security code that renders the unit unusable if someone's dumb enough to steal it. Some single DIN units have a removable faceplate with a carrying case as well as a security code. A detachable faceplate is an effective theft deterrent—few people want to steal a radio that has missing parts.



KCA-BT200 Bluetooth Hands-Free Unit with A2DP Music Streaming

All new-release video monitors are compatible with our KCA-BT200 Bluetooth hands-free module. Now, the cell phone becomes another "source" in your multi-media system! The two units connect via the KAB or 5L changer connections (the KCA-BT200 includes a 5L pass-through) to bring the latest wireless technology into your dash.

The KCA-BT200 incorporates Parrot technology that offers some exciting features like A2DP music streaming and text messaging. The KCA-BT200 Bluetooth module has caller ID and can be paired with up to five Bluetooth enabled phones and download each phone's address book so they can be stored in your receiver. The monitors can be used to dial a number, answer an in-coming call or end a call. The unit also has a microphone that can be mounted in the dash or headliner, and you can listen to the conversation through your car speakers.

New features include:

- Wireless Cell Phone Connection via Bluetooth Technology
- SMS (Short Messaging Service) Support
- Automatic Phonebook Synchronization (Storage Capacity of 1000 contacts per phone)
- Voice Recognition in Noisy Surroundings (35 voice tag capable)
- Compatible with most of Bluetooth phones with HFP



Paired with a Bluetooth-enabled cell-phone (you can pair up to five different phones), the KCA-BT200 lets you make and receive phone calls directly from the in-dash touchscreen display. Dial out (when parked, of course) using the on-screen Direct Dial keypad, or download the address book from your phone to search by name or number. You can even program pre-sets for frequently used contacts. Onscreen icons indicate system status, cellular network signal strength, and even battery level remaining, all while the cell phone is still tucked away in a pocket, purse, briefcase, or backpack. (Note: A Bluetooth Connectivity Chart is included in the Appendix section in the back of the manual.)

QUICK TIP

Steering Wheel Remote Wire

All 2008 Kenwood Video receivers have a dedicated steering wheel remote wire on the main harness. Using a 3rd party interface, you can continue to use the factory steering wheel controls, all with just a four-wire hook-up! The interface is easy to program with onboard Kenwood codes, and because there's no IR Flasher to mount, you'll save install time.

Universal Frame for Double DIN

Not all double-DIN sized openings are created equal. That's why we package our double din monitors with exclusive Universal Frame installation panel. Designed with new GM and Toyotas in mind (the two biggest car manufacturers using double-DIN), this unique over-sized trim bezel frame can be trimmed to fit your specific installation. Now, it's easier than ever to get a custom looking install without extensive fabrication.



eXcelon's DNX8120 and DDX812 have the **Bluetooth modules built-in. All other 2008 Video units are Bluetooth compatible!**

Safer Cells

Remember, states are becoming less tolerant of drivers talking from their hand-held cell phones. The DNX8120, DDX812, and any of our Bluetooth compatible video units are great solutions for blabby drivers.

Display Monitors: LZ-702IR & LZ702W

These two monitors may look identical, but the LZ-702IR and the LZ702W address two entirely different video solutions. The LZ-702IR is a 6.95" back-seat entertainment screen. The 336,960-pixel display is perfect for headrest installations and includes a custom headrest mounting trim bezel. The unit features two AV inputs and a built-in 2-channel IR transmitter for use with IR wireless headphones (like our KHP-IR70). Auto Dimmer control means the picture stays bright during daylight but dims at night so it's easier on the eyes.

The LZ-702W 6.95" touchscreen monitor has an RGB navigation input and built-in speaker, so it's a perfect match with the KNA-G510 as a stand-alone navigation unit. The LZ-702W comes supplied with both flush mount trim bezel and dash-mounting bracket.



Better Navigation Hands Down!

The KNA-G510 Hideaway Navigation system continues with some running changes, including improvements to the GPS receiver. Improvements include faster GPS positioning time (from 15 seconds down to 1 second), improved auto locate time (from two minutes down to 45 seconds), and an improved Sirf Star 3 GPS receiver.

The KNA-G510 includes maps of the USA, Canada, and Puerto Rico, and is ready for XM Live Traffic feeds as well. Add the XM chip set tuner, subscribe to XM radio and you'll hear live traffic reports and XM radio. You're going to love XM Instant Traffic & Weather because it provides constant traffic and weather conditions with continuous, real-time updates—that's 24 hours a day, seven days a week. Imagine learning about that overturned big rig before you get on the freeway!

For mapping updates, the KNA-G510 uses Flash memory not discs, so you never have to worry about changing discs. To purchase map updates visit the Garmin web site and select map updates/Kenwood.



Other cutting-edge navigation features include XM NAVTraffic (optional) for live traffic information and XM Satellite entertainment. (Kenwood GXM30 XM tuner and XM subscription required.) An alternative to the XM Live Traffic is the GTM-10 Live Traffic Tuner (subscription required) and receive the same type of traffic information through local FM broadcasts. *(Note: 5 Series multi-media products are not compatible with the XM Nav Traffic tuner.)*

Easy-to-Use Interface

The interface is simple and easy to read. The main Menu offers the simple question "View Map?" or "Where To?" Use the plus and minus sign on each side of the screen to zoom in or out. The map can also be set up to be viewed in 2D or 3D.

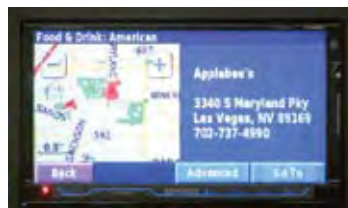

Text To Speech

The KNA-G510 not only tells you that your turn is coming, it will even announce the name of the street that the turn is on. This eliminates confusion when there is more than one turn choice and they are close together. It's safer as well. The driver's eyes spend more time on the road rather than on the map, and all of these commands are produced seamlessly through the stereo system. The music is muted and the command comes through, then you're back to your music. Choose English, Spanish, or French.

Live Traffic and Weather

The KNA-G510 is compatible with the GXM30 Live Traffic, weather tuner/antenna. A single connection from the antenna to the navigation unit is all it takes. Connect and subscribe. (The standard navigation antenna is still necessary.) XM music can be played through the GXM-30 also when connected to compatible receivers. (Music requires additional subscription charges.)



The KNA-G510 is also compatible with the RDS based TMC Live traffic Receiver. The GTM-10 is a receiver that plugs in between the radio and the factory FM antenna. It's a local terrestrial-based system and also requires a subscription.

QUICK TIP

Installation Is Easy

Installation of the KNA-G510 couldn't be easier. It requires constant 12 Volts, Switched 12 Volts, ground, parking brake safety wire, antenna and one cable connection to the in-dash controller. No speed sense wire is needed.





Remote Controls

All eXcelon video receivers and the Kenwood DNX7120 come with an ultra cool 8-direction remote for easy navigation through the screen menus. Navigation mode allows the eXcelon remote to control a connected navigation unit (KNA-G510), and the remotes include a Telephone button that answers the phone and can be used for dialing.

The 7 Series also comes with an AV remote without the navigation capability. Kenwood Video Remotes are full featured and control DVD and audio. Bluetooth capable models also include a Telephone button that answers the phone and can be used for dialing. On the 5 series, remote control is optional.



The DNX8120 is the choice with built-in Bluetooth and Navigation



Start with the DNX8120 and just keep going! This system offers both the highest sound quality and the best connectivity that **Kenwood has to offer.**



«« AMPLIFIERS

AMPLIFIERS

Amplifiers go a long way in improving the overall performance of any audio system, and Kenwood is the leader in amp technology. With gas prices climbing, smaller, more fuel-efficient vehicles are working their way into the install bay—good for the environment (hooray!), hard on the mobile electronics specialist trying to squeeze in an amp or two. Fortunately, Kenwood is ahead of the game with a new line of amps that are potent and remarkably small.

Different Amps for Different Systems

eXcelon and Kenwood offer different amplifiers to fit any vehicle and system configuration:

Class D Mono Power Amp: Designed for subwoofers, Class D amps offer big power and are less demanding on electrical systems.

Class D 4-channel Amp: This digital 4-channel amp is small, efficient, and produces high power. Use this to run all your full range speakers.

Class A/B 4-channel Amp: This amp is flexible and can be used to run four full range speakers or a sub and two full range speakers.

Class A/B 2-channel or Stereo/Bridgeable Amp: A great amp for a pair of front speakers, or bridge it to a subwoofer.

Honey, I Shrunk the Amps

New Kenwood amps pack power into a much smaller chassis size—up to 44% smaller than previous models—and include the KAC-9104D and KAC-8104D Class D Mono power amps, the KAC-8404 4/3/2-channel power amp and the KAC-7204 stereo/bridgeable amp.

These amps are a serious break-through in technology, but how did we squeeze all that juice into a smaller chassis? For starters, engineers moved the transistors and fixed them directly to the heat sink, which helps dissipate heat better. They also expanded the path of airflow by going from one larger fan to two smaller ones. Two fans mean two paths of airflow, which dramatically improves distribution of cool air. This and other design evolutions result in amplifiers as powerful as their bigger ancestors but smaller and more adaptable to new environments.

You'll also notice a redesigned cover with blue illumination that looks great installed, and we've added signal sensing turn-on and bass boost control to all four models.

Class D Prize Fighters

The KAC-9104D and KAC-8104D are 30% and 33% smaller than last year's models. The KAC-9104D is 500 Watts X 1 @ 4 ohms and is 1-ohm stable. The KAC-8104D is 300 Watts x 1 @ 4 ohms. Key features of both include built-in variable low-pass filter, built-in infrasonic filter, signal sensing turn-on, blue illumination, speaker level input, and bass boost (up to +18 dB of boost at 40Hz).

MAX POWER 1800W



2007

Up to 44% Smaller ▶



2008

For power hungry people (you know who you are), the KAC-9104D offers a Dual Mono Drive connection that allows you to strap two KAC-9104D amps together to power a single subwoofer—that's 1800 Watts of power! Combine this with a Kenwood sub and your system could be banned in several counties. Don't say we didn't warn you!



Imagine the installation opportunities of a crushingly powerful Class D amp that's just over 13 inches by 9 inches!

Inaudible Frequency, You Are Cut Off!

The KAC-9104D and KAC-8104D (and all 2008 eXcelon amps) have a built-in infrasonic filter that helps subwoofers perform their best by sharply cutting off inaudible frequencies below 15 or 25 Hz (depending on amplifier model). Although this will improve the sound of subs in sealed enclosures, the biggest audible benefit is for subs in vented boxes. A subwoofer in a vented enclosure acts like a free-air subwoofer below the tuned frequency of the box. At these infrasonic frequencies, the air in the box offers no resistance to the movement of the woofer cone, so the only thing keeping the woofer in-line are its suspension and spider. This dramatically increases distortion and reduces the woofer's power handling, sometimes resulting in blown woofers. By eliminating the inaudible junk, the infrasonic filter improves the woofer's control, improves its sound quality, increases its power handling, and saves amplifier energy for the music that we can hear.



Dual Mono Drive

Up to 2 KAC-9104D per Subwoofer. Doubles the power to subwoofers!

1800 Watts RMS!!!

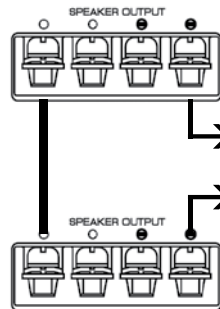
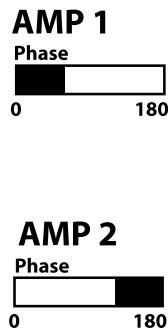

+

-



Dual Mono Drive on the KCA-9104D means you can use up to two KAC-9104D per subwoofer and double the power to an earth-shaking 1800 Watts RMS!

Bass Boost

Boost Your Bass

We've added bass boost circuitry on all new compact size amps. Acoustically speaking, low frequency sound (bass) is harder to hear than high frequency sound, and you have to tweak it to get the most out of low range sound. By amplifying a specific frequency range, bass boost results in well-balanced sound and better sound from the bass and bass drum.

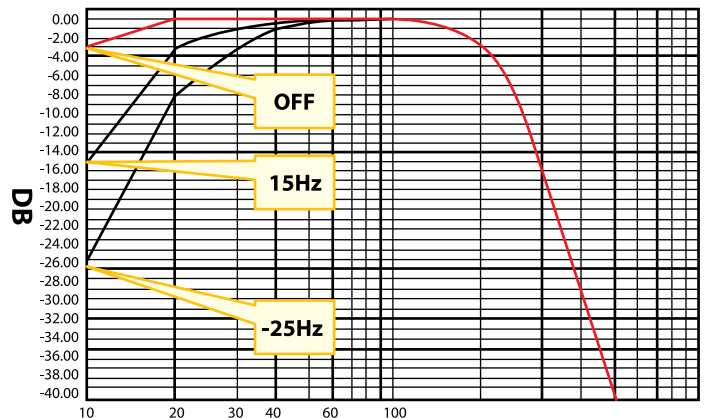

The infrasonic filter reduces distortion by filtering out super low frequencies that subwoofers can't reproduce.

QUICK TIP

Kenwood and specialty line amps feature 24-dB per octave low-pass crossovers. This better crossover is more expensive to make, but the improved sound quality is worth it. All other standard line amps have 18 dB low-pass crossovers. High-pass crossovers are set at 12 dB per octave on all amps.

Signal Sensing—What a Turn-on!

Kenwood compact amps also include signal sensing turn-on. This feature is used when connecting to a radio that doesn't have RCA outputs (can you say factory radio?). Simply wire the speaker leads from the radio to the input of the amplifier, and when the radio is turned on, the amp comes on. No need to look for a lead to turn the amp on.

In addition, all regular-line Kenwood amps have high-level input capability, so it's easy to add an amp to any vehicle no matter what type of radio it has. By making it possible to use the speaker outputs from a factory radio to drive a power amp, Kenwood makes it easy to upgrade a factory system without rebuilding the dash.

Always check the factory system to see what kind of power output it has. The high-level inputs on Kenwood amps can take 35 watts into each channel, so they can be used with most factory stereo systems.



The cover plate on Kenwood 2008 amps completely covers the wire connections, **making for a cleaner installation.**



The KAC-8104 500 Watt Class D mono power amp has a variable low pass **filter, variable high pass filter and blue illumination.**



The KAC-8404 is a 75 Watts x 4 RMS @ **4 ohms, 4-channel amplifier with power MOSFET switching, built-in variable low-pass filter (50Hz-200Hz @ 18dB/Oct), and built-in variable high-pass filter (50Hz-200Hz @ 24 dB/Oct), signal sensing turn-on, and cooling fan.**



The KAC-7204 is a 170 x 2 Watts @ 4 Ohms, 2-channel amp with built-in **variable low-pass filter (50Hz-200Hz) 24dB/Oct; built-in variable high-pass filter (50Hz-200Hz) 12dB/Oct; Power MOSFET switching; and built-in cooling fan.**



The KAC-6404 4/3/2-channel power amplifier is 40 Watts x 4 @ 4 ohms with power MOSFET switching, built-in variable low-pass filter, high pass filter, and cooling fan. The KAC-6202 2-channel power amplifier includes a cast aluminum heat sink, built-in variable low-pass filter, power MOSFET switching, and speaker level input. And finally, the KAC-5203 is an economically priced amp with 55 Watts x 2 @ 4 ohms that is included in our party packs.

Kings Among Amps

Reference Series eXcelon amplifiers carry over and include the KAC-X1R mono Class D power amp and the KAC-X4R 4-channel digital power amp. We're also bringing back our KAC-X10D Class D amp, the KAC-X20 2-channel amp, and the KAC-X40 4-channel amp.



Part of our eXcelon Reference Series, the KAC-X1R mono digital power amp features Dual Sigma Drive, dual power supply, and is 1-Ohm capable.

Features include Dual Sigma Drive and DSP technology, and several eXcelon amps (and the KAC-9104D) are 1-ohm load capable, so when it comes to system demands, these amps deliver.

Rated at 1200 Watts RMS (2400 Watts max power), the KAC-X1R mono digital Class D amp uses Dual Sigma Drive technology that provides an excellent damping factor. Damping factor measures how well an amplifier controls a woofer. The higher the number, the more it limits distortion caused by unwanted woofer movement.



Talk about your threesome! The KAC-X1R works perfectly with a pair of KFC-XW1200F or KFC-XW1000F shallow-mount subs. The amplifier is small, easy to install and, in this configuration, delivers 1200 Watts RMS!

The Class D Difference

Class D amps give your customers stronger, louder, more chest-thumping bass with reduced current demands than Class A/B amps. Class D amps are also easier on the vehicle's electrical system, which means they are less apt to make the lights dim during bass notes.

For subwoofer applications, Class D amps are efficient and their small size offers installation flexibility. Before amplifying an incoming signal, a Class D amp converts the signal to digital. Digital signals can be amplified very efficiently, so you get a lot more power with less current. Less input current reduces power supply size and generates less waste heat, thus reducing the heat sink size. The amp then converts the amplified signal back to analog. This process allows Class D amps, like the KAC-X1R, KAC-X10D, Kenwood KAC-9104D, and KAC-8104D, to crank more power than Class A/B amps of the same size.

Kenwood's Power Couple

More potent than Brad-jolina and Tom-Kat combined, the dual power supply on the KAC-1XR and KAC-X4R provide one power supply for positive current and one power supply for negative current. The result is a cleaner voltage source, less failure due to short circuit or power loss due to variances in transformer tolerances, and less transformer noise.

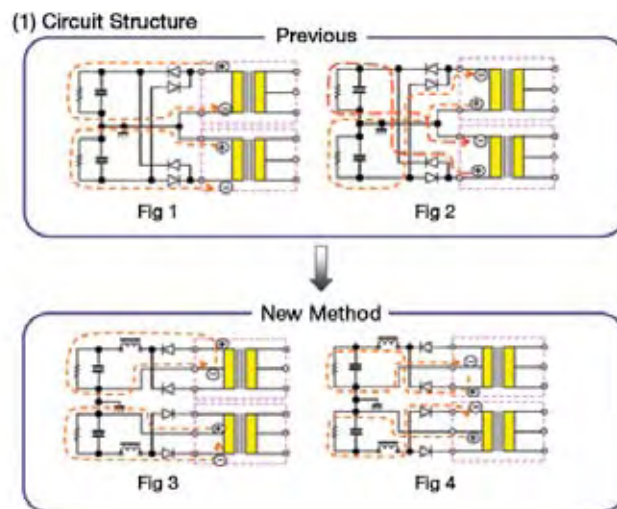

A dual power supply with two transformers ensures steady operation, even when the positive and negative loads are unstable!



The KAC-X4R Reference Series Amplifier is a 4-channel, full range digital amplifier.

The Full Range Digital Amp

The KAC-X4R 4-channel amp uses digital amplifier technology in a full range application along with a unique DSP. This 600 Watt RMS amplifier

(1200 Watts max power) is well suited for any number of system applications because all functions are performed in the digital domain. Its on-board DSP includes features like time alignment, parametric EQ, and audio feedback circuitry for clean, precise power.

Amps at Work

A very cool feature of both of our Reference Series amps is the 14-segment, five-digit blue fluorescent display that shows voltage, current, temperature, and setup menu. Here's a plus for installers: the eXcelon Digital Reference line retains installer memory so you can lock in those settings. The amp information display also includes an over/under input setup. This feature helps precisely match the input sensitivity to the headunit for best sound quality and volume. (The KAC-X4R full digital amplifier comes with a setup disk to adjust input sensitivity.)



Dual Sigma(Σ) Drive

eXcelon Class D mono amplifiers (KAC-X1R & KAC-X10D) use Dual Sigma Drive, which is an advanced negative feedback circuit. When a signal is passed to a subwoofer, say a 50Hz note, the speaker will move and create the note. However, because the speaker has mass and a suspension, it won't stop moving once it's in motion. This extra movement (sound) creates a type of distortion because it is not part of the original signal. The negative feedback circuit senses this unwanted movement as back EMF (electro motive force), which are voltage pulses sent back to the amplifier caused by the speaker movement. The negative feedback loop senses these pulses and sends out an opposite pulse to stop the speaker. Think of it as an electronic brake for your subwoofers.

Kenwood's Dual Sigma Drive extends the negative feedback loop out to the speaker output terminals. This makes the feedback loop more accurate because it considers all of the impedance-changing devices that are after the output transistor (like crossovers, etc.).

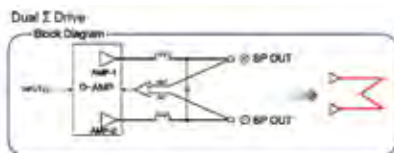

Dual Sigma Drive circuitry ensures a precise reproduction of music by **controlling unwanted speaker movement.**

The KAC-X10D Class D mono power amp pumps out more power than Class A/B amps of the same size and will give your customers stronger, louder, more chest-thumping **bass.**

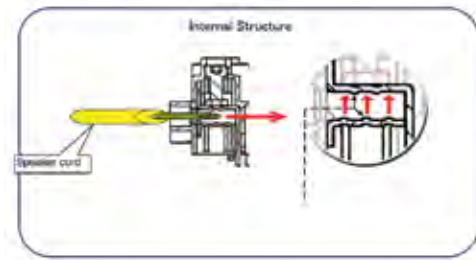

eXcelon Digital Reference amps are designed to provide more contact with less resistance for maximum performance, and you don't need external connectors!

Dial in the Decibels

The KCA-WR10 optional remote controller is designed for the KAC-X1R, KAC-X10D, and the KAC-X20.

This little knob allows bass boost frequency adjustments and level adjustments for bass. Say you want to add 8 dB worth of boost at 43 Hz. With the KCA-WR10, it's just a matter of turning the knobs. And if you are using two amps, you can use a phone cord splitter so one bass boost controller operates both amps.



Stay in Phase

Phase inverter for subwoofer applications is a key feature on all eXcelon amps (and the Kenwood KAC-9104D). A phase inverter switches the output of the amp 180 degrees out of phase. Why would you want to do that? Because it can help when the installation results in a subwoofer being out of phase in the listening position. Flipping the phase inverter switch can increase volume by putting the system back in phase.

1-Ohm Stable

The eXcelon KAC-X1R, KAC-X10D and Kenwood KAC-9104D are 1-Ohm load capable. There is little benefit to running a Kenwood amplifier at 1-Ohm, because in most cases they produce the same power at 2-Ohms. There is also a down side to running an amp at 1-Ohm. The amp will run hotter, which can affect longevity and put large demands on the car's electrical system. So why bother with 1-Ohm? There are cases where the number/impedance of speakers you're connecting will create a 1-Ohm load. If you do run an amp at 1-Ohm, it will draw more current and should be addressed by running heavier gauge power and ground wire to the amp from the power source. *Note: Always match up your speakers properly to the specification of the amplifier.*

QUICK TIP

Double Your Bass

When two 4-ohm speakers of the same impedance are connected in parallel to a single amp channel (both speakers' '+' terminals are connected directly to the '+' terminal on the amplifier, and the same for the '-' side), it cuts the impedance in half. Therefore, two 4-ohm woofers become one 2-ohm woofer system, which doubles the power output of the amp. This also doubles the amount of cone area producing sound. So instead of doubling the amount of amps in the car to get more bass, you can just double the number of subs in the car! (Keep in mind, this same system connected to a bridged 2-channel amplifier would be unstable as the bridged amplifier would see a 1-ohm load.)



4-Channel & 2-Channel Amps

If you're working with full-range or component speaker systems, the KAC-X20 2-channel and KAC-X40 4-channel amplifiers are an excellent match. The KAC-X40 4-channel amp is 70 Watts x 4 RMS @ 4 ohms with variable low pass filter, infrasonic filter, selectable phase inverter, K-STAT technology, and an advanced cooling system. The KAC-X20 2-channel amp is 180 Watts x 2 RMS @ 4 ohms with variable low pass filter, variable high pass filter, infrasonic filter, phase inverter, K-STAT technology, and cooling system.

Kenwood 4/3/2-channel amps include the KAC-8404 and KAC-6404. The KAC-7204, KAC-6202, and KAC-5203 are stereo/bridgeable. Depending on the number of speakers you want to power, use a 2-channel amp to power two full range speakers or two subs, with one on each channel. Otherwise, you can bridge the amp to single channel operation for a single woofer or woofers (be careful not to drop the impedance below 4 ohms bridged). A 4-channel amp can be bridged to 2-channel mode to power a pair of subs or full range speakers.

K-STAT: Better Sound at All Volume Levels

Many amplifiers will have higher distortion when they first power up because it takes time to reach the optimal operating temperature. K-STAT (Kenwood Self Tracking Audio Transistor) technology on the KAC-X20 and KAC-X40 multi-channel amplifiers is a Kenwood patented output transistor that biases automatically based on heat. It does this much faster than a conventional transistor and offers solid audio benefits. The biasing circuit, which ensures the amplifier adjusts properly, is built into the device rather than installed separately. This streamlined design results in lower distortion both when the amp powers up, and at full power. K-STAT technology also reduces thermal resistance but increases power for improved sound quality.

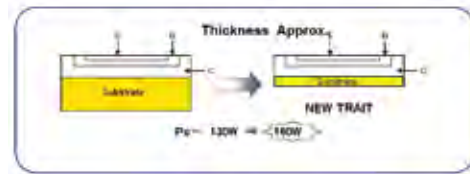

eXcelon multi-channel amplifiers KAC-X20 and KAC-X40 have K-STAT output devices with built-in thermistors with temperature detection and compensation.

High Pass/Low Pass Crossovers

All Kenwood amplifiers have built in crossover networks that should be properly set to maximize performance. Not even a Kenwood speaker can cover the entire range of human hearing, so most speakers are designed to cover sections of that range. Woofers cover low frequencies. Mid range drivers pick up where the woofers leave off, and the tweeters take over at the high frequencies. Woofers sound really bad playing mid range, and mid range drivers distort and bottom out trying to play bass. Tweeters just burn up if they play anything but the highest frequencies. Pay attention to electronic crossovers because they filter out frequencies speakers shouldn't play.

The high-pass crossovers in Kenwood amplifiers cut-off low frequencies so that the front and rear speakers get only the frequencies that they were designed to handle. This improves power handling so they can play louder with more clarity and less distortion.

Low-pass crossovers do basically the same thing—subwoofers are designed to play bass notes. The low-pass crossovers in Kenwood amps cut off higher frequencies, letting the front and rear speakers do all the singing while the subwoofer happily thumps out low bass notes.

eXcelon Two-year Warranty

Don't forget to remind customers that eXcelon amplifiers include a two-year warranty—twice the warranty period of many other manufacturers.





≡≡≡ SPEAKERS

SPEAKERS AND SUBS

Kenwood engineers are obsessed with sound, and while this doesn't lead to a well-balanced life, it does result in some remarkable speakers and subs. This year, we're launching better sounding speakers with smaller mounting depths and factory replacement speakers that offer big sound for small budgets. Of course, both eXcelon and Kenwood subwoofers register on the Richter scale, and our famous woofer graphs are included at the end.

eXcelon



Performance Enhancing Subs

eXcelon earth-shakers include four new dual voice coil models that will blow other manufacturers into yesterday's news. The KFC-XW1224D and KFC-XW1222D are 12-inch mammoths that handle 2000 Watts of pure power. The KFC-XW1024D and KFC-XW1022D 10-inchers share the same features and handle 1600 Watts of power. These subs are dual voice coil designs: 4 + 4 ohm and 2+2 ohm. With the choice of either dual 2-ohm or 4-ohm voice coils, the system can be designed to maximize the amplifier's power output.

Other features that work together to ensure the cleanest possible signal include rubber magnet covers that improve cosmetics and performance by reducing basket vibration, dual magnet drive, super linear spider, and gold-plated push terminals.



New eXcelon dual voice coil subs work **in small sealed or vented enclosures. You can even add an optional grille.**

Dual Voice Coils (DVC)

The voice coil in subwoofer design is important because it converts the sub's magnet energy into cone motion. Although many subwoofers have a single voice coil, dual voice coil subwoofers use two separate voice coils, each with separate connections mounted on one former (also called a bobbin) and connected to a common cone. The biggest benefit is that the voice coils can be configured to meet your system requirements.



Carbon Glass Fiber Makes A Mighty Strong Woofer

Coating carbon material onto glass fibers makes the material wickedly strong and reduces needless resonance in low frequency. New models with this material show faster and clearer sound with less distortion.

Itsy Bitsy Super Linear Spider

In speaker design, the spider controls the cone's movement and keeps the voice coil centered. It's kind of like a shock absorber, smoothing out the cone's ride. The super linear spider on the KFC-XW12R, KFC-XW1024D, KFC-XW1022D, KFC-XW1222DVD, KFC-XW1224D, and eXcelon flat woofers rolls gradually and becomes higher towards the center. This design allows more control over the speaker because there's less stress. Less stress means less failure due to high excursion. The small-to-large pleats also work in a progressive manner so that the speaker remains linear over its entire range of movement.

From Big and Beefy to Lean and Mean

eXcelon super subs are *the* choice for customers into serious bass. The KFC-XW12R has a 12-inch carbon fiberglass cone woofer, two-piece cast aluminum basket, double stacked magnet, and dual voice coil (3 ohm + 3 ohm). This puppy offers up 1000 Watts RMS and includes smart cosmetic designs, like high damping fins and a vented basket that make it very heat efficient. The KFC-XW12R can take a whole lot of punishment because the design creates more strength and surface area for heat to dissipate from the motor and spider (it even has fuses just in case).



Rated at an intestine-twisting 3000 Watts Max, the **KFC-XW12R 12" Super Sub isn't for the High School Musical crowd.**

The KFC-XW12R uses a black trim and black cast frame that look great installed, and the butyl rubber surround is treated to give the rubber a stiffer quality. It even includes smart switching that, with a flip of the switch, lets you put the voice coils in series or parallel, depending on whether you're using a mono or stereo amp. Other key audio features include a symmetrical voice coil, a heat transfer system that keeps heat away from the motor, a super linear spider, and smooth linear rubber surround.



For tight squeezes, the KFC-XW1200F 12-inch and KFC-XW1000F 10-inch have a mere **4" mounting depth and pack in 350/250 Watts RMS. Put these babies in a Mazda Miata and see what happens!**

Our lean and mean KFC-XW1200F and KFC-XW1000F shallow subs offer big bass flavor without the unwanted pounds. With a 4-inch mounting depth, these subs have a single voice coil at 4 ohm, a cast aluminum

basket, and a removable front trim ring with a clean finish. Both the 10-inch and the 12-inch will fit nicely in a small, sealed custom or prefab enclosure (installers will likely build their own).

Carbon Fiber Honeycomb

Carbon fiber material makes for super strong cones, but what you can't see is on the back side of our shallow subs. A honeycomb design (it looks like a bee's nest) dramatically adds to cone strength. Other key features of these slender beasts are the aluminum die-cast basket heat transfer system, super linear spider and surround, and silver-plate push terminals that accept up to 8 AWG.

KENWOOD

Listen to the Future

Kenwood Subwoofers: Success through Excess

Kenwood subwoofers offer mega doses of bass as well. Returning champions include the KFC-W3514DVC, KFC-W3011, and the KFC-W2511. New to the lineup is the KSC-SW10 easy-fit sub that's small enough to fit under car seats and offers up 150 Watts of power.



The KFC-W3514DVC has a deep cone design that can move **20% more air volume than ordinary designs.**

The KFC-3514DVC 12" sub handles 380 Watts of continuous power, 1500 Watts at peak, and includes a titanium coated cone woofer and rubber surround for durability. Its oversized cone can move more air and produce louder and lower bass.

■ QUICK TIP



Notice how the terminals are positioned on one side, making parallel wiring a snap. The new magnet cover overlaps part of the basket for better sound and cosmetic appearance, and even the gasket is detachable for two-way installation. Because the woofer can be mounted either "magnet-in" or "cone-in," the installation trim-ring can be placed either on the front or rear of the basket for a custom-looking finish.

No Customer Left Behind

Super-sturdy, super powerful, and priced to please, the KFC-W3011 and KFC-W2511 are a real deal for woofers. The KFC-W2511 is a 10-inch woofer rated at 1000W peak; the KFC-W3011 is a 12-inch sub that can handle 1200W peak input power. These high performance subs feature a single 4-ohm voice coil, titanium coated woofer, and super linear spider. A long stroke design thumps out the low frequency and the silver-plate finish looks very clean installed. The titanium coated polypropylene cone gives it a nice brushed aluminum look, while a high-roll rubber surround design adds rigidity to the cone's top edge and provides a large contact area so the cone/surround stays together, even when bass crazy customers get greedy.



Rated at 300/250 Watts RMS, 1200/1000 peak, the KFC-W3011 and KFC-W2511 **offer clean, loud and powerful bass.**

Other features include a reversible trim ring that lets you pull off the front and mount it on the back, depending if you're mounting cone out or basket out. Push terminals on the back will take up to an 8-gauge wire, and these subs are easier on installers because they can simply push and release the speaker terminals.



A little bling on back! The silver-plated push terminals on the KFC-W3011 and KFC-W2511 will take up to **an 8-gauge wire.**



Happy Little Thumpers

The KSC-WD250, KSC-W250T and KSC-SW10 compact subs are a quick and easy way to add bass to just about any system. Our new KSC-SW10 5 x 7" compact powered subwoofer includes a 5 x 7" dual voice coil Woofer, 5 x 7" passive radiator woofer, speaker level input and a remote control.



Oh, it'll fit. Slip the KSC-SW10 compact sub underneath the seat and shake things up with 150 Watts of power.

The KSC-WD250 10-inch powered subwoofer works perfectly with a highly efficient 200 Watt Class D amplifier. The KSC-WD250T is a 10-inch powered subwoofer with a dual voice coil, bass reflex enclosure, and a Class D amplifier circuit. This sub is similar to the KSC-WD250 but has a smaller enclosure, which makes it ideal for trucks, hatchbacks and any other places where space is a premium.

QUICK TIP

Don't forget to give your subwoofers plenty of power. Make sure to use a good subwoofer amplifier and large gauge power and ground cables. Subwoofer amplifiers draw a lot of current, so you might want to look at very efficient Class D type amplifiers like the Kenwood KAC-9104D or KAC-X10D.



eXcelon Speakers—An Ear's Best Friend

Two new component speakers make it to the eXcelon line: the XR-S17P slim package and the KFC-X1720P. With peak power at 270 Watts, the eXcelon KFC-X1720P component speaker system includes high-end features like a cast aluminum basket and crossovers with Zobel networks. What's so great about Zobel networks? We love 'em because they keep ohm impedance constant. This means the amplifier never sees an ohm load fluctuation and allows the amp to run cooler and with less distortion. In addition, this year's package requires less mounting depth than last year and it's a direct fit on Ford, GM, and Honda.

The KFC-X1720P, S17P and the KFC-P series incorporate a new component tweeter installation that offers a lot of flexibility. Three types of tweeter mounting are available: flush mount, surface mount and factory location. A swivel function is also available in flush mounting.

New Component Tweeter Installation

In 2008 new model, three types of tweeter mounting are available. (Previous models had only two types.)



To install the tweeter using surface and factory location bracket.



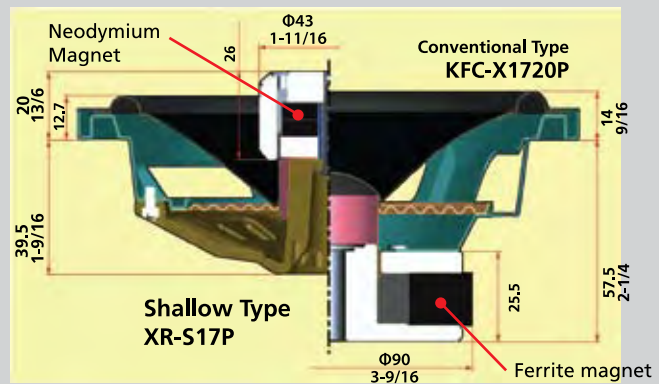

| | | |
|-----------------------|----------------------|--------------------------------------|
| Mounting Depth | Weight | Maximum Magnetic Flux Density |
| 57.5mm 2-1/4inch | 39.5mm 1-9/16inch | 0.83T ▶ 0.90T |
| | 1,022g ▶ 500g | |

Great Sound in a small space!

31% Shallower | 51% Lighter | Magnetic field 8% stronger

Check out the XR-S17P shallow-mount package with **1-9/16" mounting depth and 300 Watts of peak power.**

The XR-S17P shallow package is one of our best sounding speakers, and it just happens to be our thinnest. With a carbon polypropylene hybrid cone, the XR-S17P has a mounting depth of only 1 9/16"—that's unheard of at 300W peak power! It also includes a 6x8" plate for use in Ford and Mazda vehicles and a high quality crossover network.

Flush Mount Systems

The KFC-X172 6¾-inch and KFC-X132 5-inch 2-way flush-mount speakers and KFC-X692 6X9 3-way speaker system feature very cool design advantages like the carbon polypropylene hybrid. These speakers share the same cast aluminum baskets as component speakers, with shallow mounting depth that allows for easy fit into import vehicles.

The KFC-X1710 is a high performance 2-way system that features the same 6¾" midrange driver, and a spacing adapter is included so the speakers fit in standard 6½" applications.

QUICK TIP

2-Ohm Drive

The KFC-X1710 and KFC-X1720P are 2-ohm drive, so you're going to maximize the power output of the full-range amps that drive these speakers. The 2-ohm design will give you more headroom, more dynamics, and a lot more "loud." Both models are a great solution for replacing factory speakers, and they make good factory replacement speakers in OEM systems where the speakers are 2 ohm. We strongly recommend using external amps on these speakers because a 50 X 4 chip's not going to cut it.



Notice the tweeter on the KFC-X1710 is suspended in mid air with the bridge support. **The dust cap on the midrange driver is a cloth material and is used to tune the midrange driver for best sound quality.**



The KFC-X1720P and KFC-X1710 use 2 Ohm drive and serve up 220/270 Watts of power handling. **The 2-ohm drive will maximize the power from external amps.**

PERFORMANCE SERIES

Performance You Can Bank On

With the exception of price, there's nothing moderate about our new Performance Series speakers. Five new models fill in the gap for customers who want to replace their factory speakers but won't go beyond a hundred bucks.

The KFC-1682ie, KFC-1382ie and KFC-1082ie are seriously tight 3-way speakers. Listen to them and you'll notice higher performance than any speaker in this price range. Secret ingredients include fiber texture polypropylene cones that are stronger and lighter than conventional diaphragms and produce smoother and more natural-sounding mid-bass response. The Performance Series speakers also include our third-generation Image Enhancer tweeter technology (IE-3) with wider mid and high-frequency dispersion for better imaging and soundstage.



Image Enhancer incorporates a tweeter bezel that's precisely curved to reduce diffraction. In fact, they're curved with two different radii so they reduce diffraction over a very wide range of frequencies. By eliminating most of this destructive interference, we've evened-out the high-frequency response and increased high-frequency dispersion, so Image Enhancer speakers have amazing clarity without harshness, even when you're listening off-axis.



The KFC-P680C 6x8 is an easy fit for Ford/Mazda.

Upgrades for Ford and Mazda

The KFC-P680C is an easy fit 6 X 8 speaker system that provides 65 Watts RMS and 200 Watts peak. We built these especially for Ford and Mazda, which exclusively adopted this size for both front and rear. With a smooth, elegant black finish, the KFC-P680C is an easy way to get component sound, and the high quality crossover network is built in to the back of the panel.



The KFC-6972ie and KFC-6982ie are 5-way and 4-way 6 x 9s that will blow the socks off other speakers in their **price range.**

Image Enhancer III

New Image Enhancer III

Our engineers keep improving the Image Enhancer technology, and this year's line includes patented Image Enhancer III. Image Enhancer eliminates diffraction, creating clear, detailed sound even for listeners who aren't sitting directly in front of the speaker.



Kenwood's promotional line speaker systems are priced to sell and include amazing audio technologies seldom seen in this price range—the KFC-1661S 6.5" 3-way system at 35 Watts RMS and 180 peak, the KFC-1361s 5.25" 3-Way at 28 Watts RMS/150 peak, and the KFC-1061s 4" 3-way at 20 Watts RMS/120 peak. Key features of these 3-way systems include a polypropylene injection cone, 1/2" Piezo tweeter, and the shallow mounting depth which are GM 6¾" size compatible.

THE KFC-P708 & KFC-P508S

Both the KFC-P708 and the KFC-P508 component speaker packages are a gigantic sound upgrade from factory components. The KFC-P708 is a 6¾" component with killer features like a polypropylene with fiber texture woofer. The KFC-P508 has equally impressive features in a 5¼" component set. Our engineers pushed the surrounds to the very edge of the basket, making room for an extended cone surface area that is up to 20% larger than previous models. The oversized cone results in deeper bass and increased output, and the woofer cone surface is coated with a metallic titanium finish, giving these speakers an undeniably future-looking design.



Our dual cone 2-way speakers include **KFC-1651S 6.5"**, **KFC-1351s 5.25"**, and **KFC-1051S 4"**.



For That Extra Sparkle

Adding tweeters high in the front of the car (A-pillars) can raise the soundstage of the system and give the listener that extra detail he or she wants. For these applications, we offer our KFC-T207 and KFC-ST30 component tweeters that have a P.E.I. balanced dome tweeter and a high power handling. The KFC-T207 component tweeter includes a U.F.L.C. soft dome tweeter and two-way mounting: flush/surface.

In eXcelon, the KFC-XT15ie component tweeters are very similar to the tweeters that come with the eXcelon component speakers, which make them a great match for systems that use those components. They are a ¾" titanium dome tweeter with 3-way mounting and include Image Enhancer technology. Hit the high notes with the KFC-XT15ie component tune-up tweeter or the KFC-T207 component tweeter.

Thiele-Small Parameters and Graphs

The following parameters are useful if you're using a woofer box computer program, and the graphs are excellent performance parameters for each woofer.

Technical Specifications

| | SYMBOL | | KFC-XW12R | KFC-XW1224D | KFC-XW1222D | KFC-XW1024D | KFC-XW1022D |
|----------------------------|--------|----------|--------------|-------------|-------------|--------------|--------------|
| Nominal Impedance | Z | Ω | 3+3 | 4+4 | 2+2 | 4+4 | 2+2 |
| DC Resistance | Revc | Ω | 3.2+3.2 | 3+3 | 1.5+1.5 | 3+3 | 1.5+1.5 |
| Voice Coil Inductance | Levc | mH | 0.728 | 0.63 | 0.5 | 0.56 | 0.67 |
| Piston Area | Sd | sq·m | 0.049 | 0.049 | 0.049 | 0.035 | 0.035 |
| Force Factor | BL | T·m | 11.82 | 9.46 | 6.56 | 6.66 | 6.64 |
| Volume Acoustic Compliance | Vas | liters | 29.11 | 63.77 | 61.03 | 25.48 | 25.81 |
| | | cu.ft | 1.028 | 2.253 | 2.157 | 0.899 | 0.912 |
| Moving Mass | Mms | g | 231.6 | 180.1 | 176.8 | 94.2 | 156.5 |
| Resonance Frequency | Fs | Hz | 35.8 | 27.4 | 28.3 | 42.4 | 32.7 |
| Mechanical Q Factor | Qms | | 4.403 | 4.448 | 5.813 | 3.892 | 5.13 |
| Electrical Q Factor | Qes | | 0.598 | 0.52 | 0.55 | 0.848 | 0.546 |
| Total Q Factor | Qts | | 0.526 | 0.47 | 0.50 | 0.696 | 0.494 |
| Peak Power | | W | 3000 | 1000+1000 | 1000+1000 | 800+800 | 800+800 |
| Peak Excursion | Xmax | mm | 8.5 | 7.7 | 5.9 | 6.9 | 8.2 |
| Displacement | | cc | 3630 | 3030 | 3030 | 1790 | 1790 |
| | | cu.ft | 0.128 | 0.107 | 0.107 | 0.063 | 0.063 |
| Mounting Depth | | mm (in.) | 211(8-15/16) | 168(6-5/6) | 168(6-5/6) | 147(5-13/16) | 147(5-13/16) |
| Weight of Magnet | | g (oz) | 4080(143.6) | 2420(85.2) | 2420(85.2) | 1700(59.8) | 1700(59.8) |
| Voice Coil Diameter | | mm (in.) | 75(2-15/16) | 65(2-9/16) | 65(2-9/16) | 50(1-15/16) | 50(1-15/16) |

Technical Specifications

| | KFC-XW1200F | KFC-XW1000F | KFC-W3011 | KFC-W2511 | KFC-W112S(8Ω) | KFC-W110S(8Ω) |
|----------------------------|--------------|-------------|--------------|--------------|---------------|---------------|
| Nominal Impedance | 4 | 4 | 4 | 4 | 8 | 8 |
| DC Resistance | 3.2 | 3.0 | 3 | 4 | 6.3 | 6.3 |
| Voice Coil Inductance | 2.8 | 2.1 | 1.26 | 2.8 | 3.2 | 3.2 |
| Piston Area | 0.049 | 0.034 | 0.050 | 0.035 | 0.048 | 0.035 |
| Force Factor | 12.93 | 10.7 | 10.1 | 13.9 | 15.4 | 16 |
| Volume Acoustic Compliance | 62.69 | 21.05 | 26.6 | 9.38 | 87.7 | 40.2 |
| | 2.214 | 0.744 | 0.940 | 0.331 | 3.0 | 1.41 |
| Moving Mass | 224.0 | 127 | 171.9 | 122.9 | 119.5 | 112 |
| Resonance Frequency | 24.8 | 38.6 | 45 | 60 | 28 | 32 |
| Mechanical Q Factor | 2.897 | 5.279 | 3.839 | 8.575 | 10.4 | 10.7 |
| Electrical Q Factor | 0.67 | 0.84 | 1.519 | 0.932 | 0.613 | 0.591 |
| Total Q Factor | 0.544 | 0.72 | 1.088 | 0.84 | 0.579 | 0.561 |
| Peak Power | 1400 | 1000 | 1200 | 1000 | 800 | 700 |
| Peak Excursion | 8.5 | 7.5 | 11.3 | 6.9 | 7.7 | 7.7 |
| Displacement | 1740 | 1110 | 6495 | 3552 | 3511 | 2294 |
| | 0.061 | 0.039 | 0.229 | 0.125 | 0.124 | 0.081 |
| Mounting Depth | 100(3-15/16) | 85(3-3/8) | 170(6-11/16) | 142.7(5-5/8) | 141.6(5-9/16) | 123.8(4-7/8) |
| Weight of Magnet | 1370(48.2) | 1080(38.0) | 1780(62.7) | 1230(43.3) | 820(28.9) | 820(28.9) |
| Voice Coil Diameter | 65(2-9/16) | 50(1-15/16) | 65(2-9/16) | 48(1-7/8) | 50(1-15/16) | 50(1-15/16) |

Recommended Enclosures

NOTE: Measurements are shown in millimeters and inches. Inches are indicated by parentheses.

KFC-XW12R

| Volume | W | H | D | Mounting Hole | Port Diameter d | Port Length L | Displacement(cu.ft) |
|------------------------------|----------------|---------------|---------------|---------------|---------------------|---------------|---------------------|
| Sealed 1.25 cft (35.4 liter) | 380 (14-15/16) | 375 (14-3/4) | 360 (14-3/16) | 282(11-1/8) | Round Port 76(3) | 178(7) | 0.229 |
| Vented 1.5 cft (42.5 liter) | 380 (14-15/16) | 440 (17-5/16) | 360 (14-3/16) | | | | |

W,H,D : External Dimensions

Use 19mm(3/4 inch) thick Medium Density Fiberboard(MDF) or High Density Particleboard.

KFC-XW1224D/1222D

| Volume | W | H | D | Mounting Hole | SW | SH | SL | Displacement(cu.ft) |
|------------------------------|----------------|---------------|--------------|---------------|-----------|-----------------------------------|-------------|---------------------|
| Sealed 1.25 cft (35.4 liter) | 375 (14-3/4) | 370 (14-9/16) | 355 (14) | 282(11-1/8) | 35(1-3/8) | Rectangular Port 322(12-11/16) | 480(18-7/8) | 0.11 |
| Vented 1.5 cft (42.5 liter) | 507 (19-15/16) | 360 (14-3/16) | 320 (12-5/8) | | | | | |

KFC-XW1024D/1022D

| Volume | W | H | D | Mounting Hole | SW | SH | SL | Displacement(cu.ft) |
|------------------------------|--------------|--------------|----------------|---------------|-----------|---------------------------------|-------------|---------------------|
| Sealed 1 cft (28.3 liter) | 330 (13) | 375 (14-3/4) | 325 (12-13/16) | 235(9-1/4) | 35(1-3/8) | Rectangular Port 302(11-7/8) | 480(18-7/8) | 0.06 |
| Vented 1.25 cft (35.4 liter) | 485 (19-1/8) | 340 (13-3/8) | 300 (11-13/16) | | | | | |

KFC-XW1200F

| Volume | W | H | D | Mounting Hole | Displacement(cu.ft) |
|----------------------|---------------|--------------|-------------|---------------|---------------------|
| 0.8 cft (22.6 liter) | 773 (30-7/16) | 362 (14-1/4) | 107(4-3/16) | 282(11-1/8) | 0.061 |

KFC-XW1000F

| Volume | W | H | D | Mounting Hole | Displacement(cu.ft) |
|----------------------|--------------|-------------|-------------|---------------|---------------------|
| 0.6 cft (17.0 liter) | 718 (28-1/4) | 324(12-3/4) | 103(4-1/16) | 235(9-1/4) | 0.039 |

KFC-W3011

| Volume | W | H | D | Mounting Hole | Port Diameter d | Port Length L | Displacement(cu.ft) |
|------------------------------|----------------|---------------|---------------|---------------|-----------------|------------------|---------------------|
| Sealed 1.25 cft (35.4 liter) | 380 (14-15/16) | 375 (14-3/4) | 360 (14-3/16) | 282(11-1/8) | sealed 76(3) | sealed 178(7) | 0.229 |
| Vented 1.5 cft (42.5 liter) | 380 (14-15/16) | 440 (17-5/16) | 360 (14-3/16) | | | | |

KFC-W2511

| Volume | W | H | D | Mounting Hole | Port Diameter d | Port Length L | Displacement(cu.ft) |
|------------------------------|-------------|---------------|---------------|---------------|-----------------|------------------|---------------------|
| Sealed 1 cft (28.3 liter) | 330 (13) | 390(15-3/8) | 325(12-13/16) | 235(9-1/4) | sealed 76(3) | sealed 178(7) | 0.125 |
| Vented 1.25 cft (35.4 liter) | 340(13-3/8) | 455(17-15/16) | 330(13) | | | | |

KFC-W112S

| Volume | W | H | D | Mounting Hole | Port Diameter d | Port Length L | Displacement(cu.ft) |
|------------------------------|----------------|---------------|---------------|---------------|-----------------|------------------|---------------------|
| Sealed 1.25 cft (35.4 liter) | 380 (14-15/16) | 375 (14-3/4) | 360 (14-3/16) | 277(10-7/8) | sealed 76(3) | sealed 178(7) | 0.124 |
| Vented 1.5 cft (42.5 liter) | 380 (14-15/16) | 440 (17-5/16) | 360 (14-3/16) | | | | |

KFC-W110S

| Volume | W | H | D | Mounting Hole | Port Diameter d | Port Length L | Displacement(cu.ft) |
|------------------------------|-------------|---------------|---------------|---------------|-----------------|------------------|---------------------|
| Sealed 1 cft (28.3 liter) | 330 (13) | 390(15-3/8) | 325(12-13/16) | 233(9-3/16) | sealed 76(3) | sealed 178(7) | 0.081 |
| Vented 1.25 cft (35.4 liter) | 340(13-3/8) | 455(17-15/16) | 330(13) | | | | |

INSTALLERS NOTE: Kenwood woofers are designed primarily for sealed enclosures. Although they will work in a vented box, we recommend a sealed enclosure for maximum performance. Also note that the shallow woofers display graphs only for sealed enclosures.

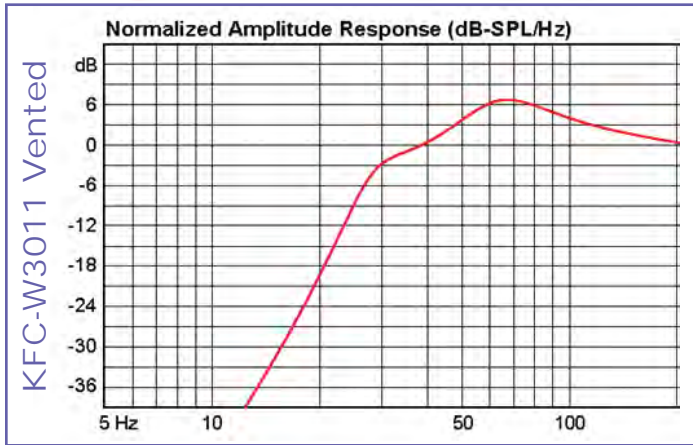
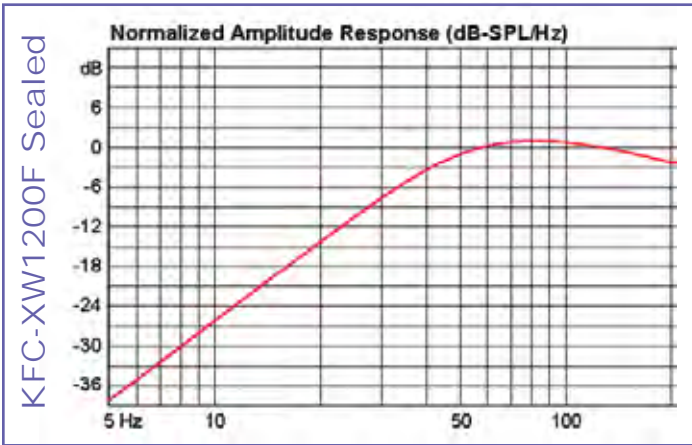
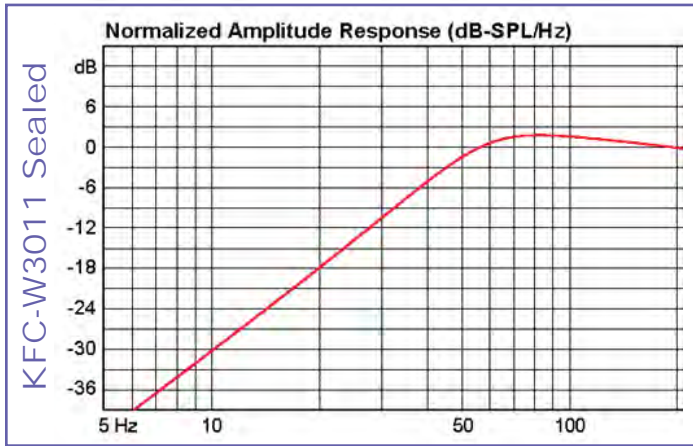
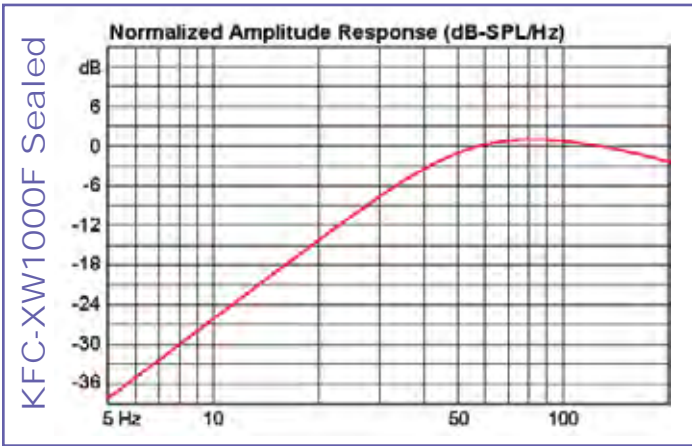
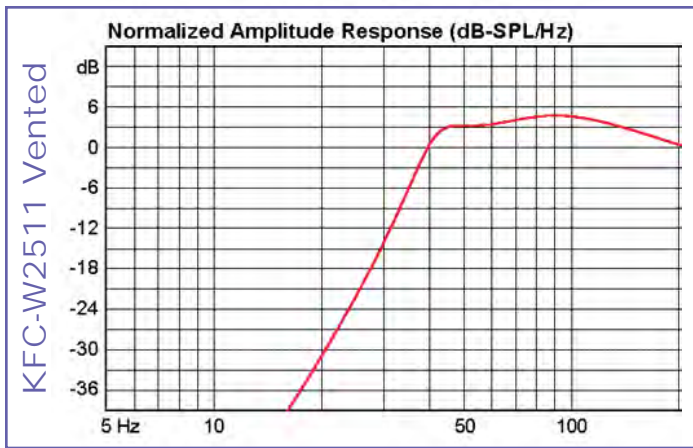
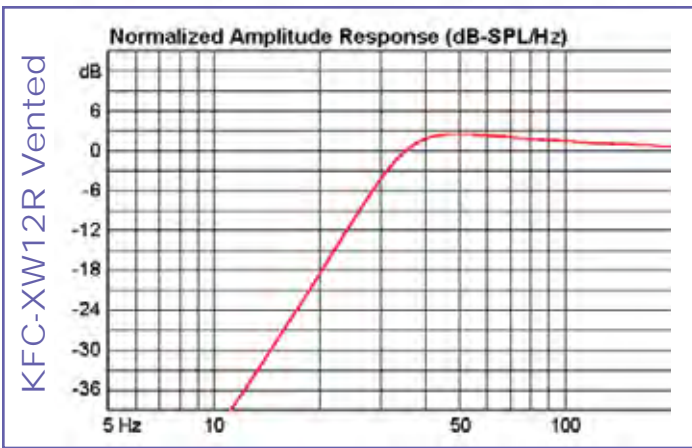
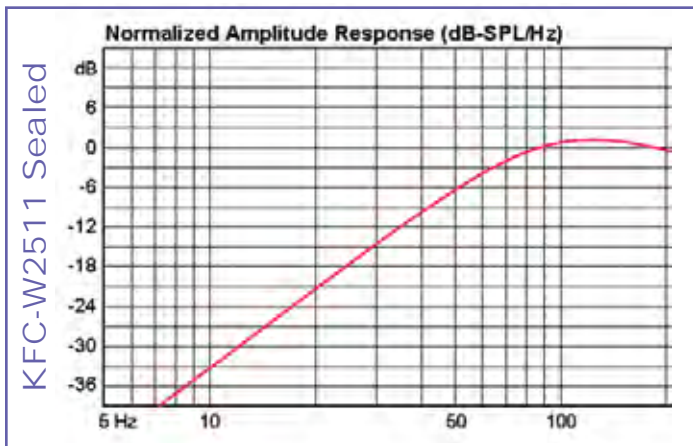
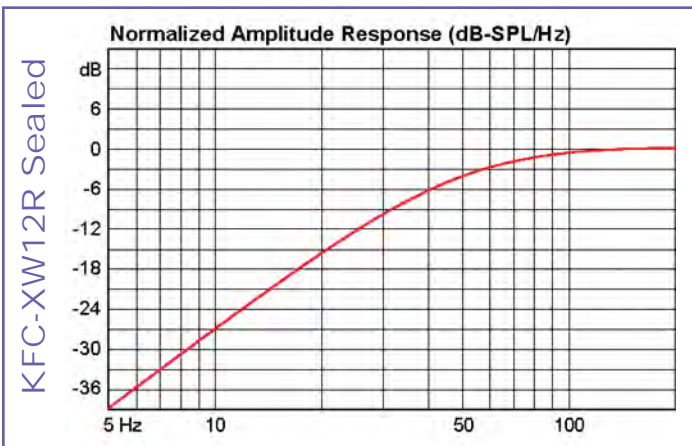

KFC-W3514DVD Sealed

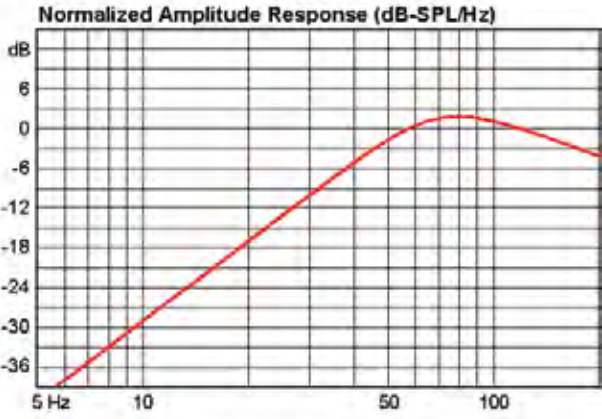

KFC-W110S Vented

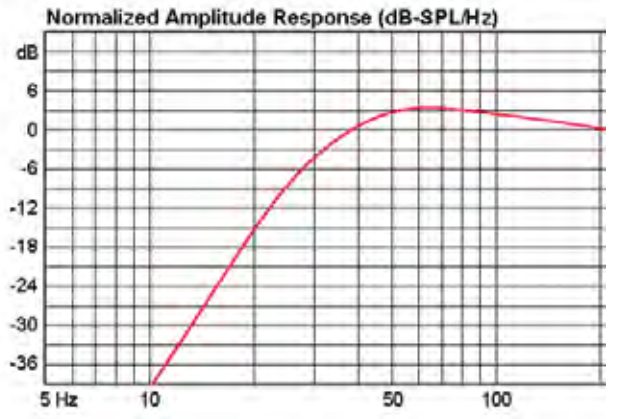

KFC-W3514 Vented

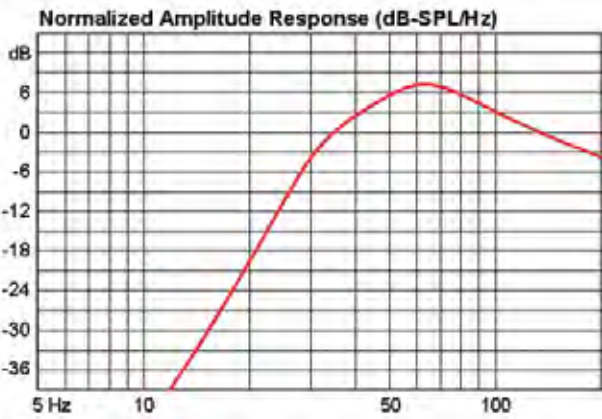

KFC-W112S Sealed

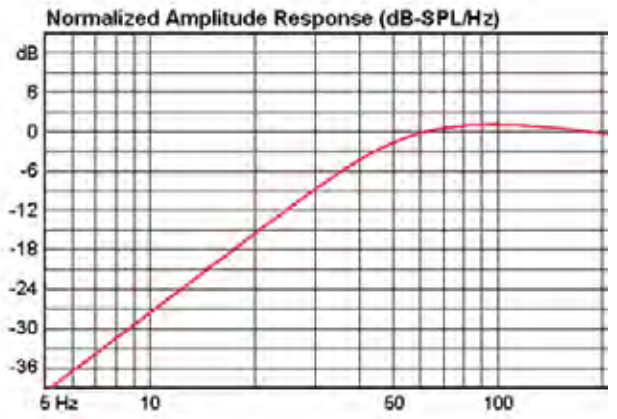

KFC-W110S Sealed

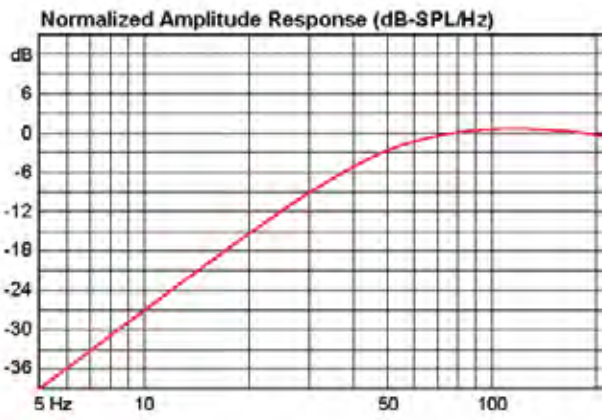

KFC-W112S Vented

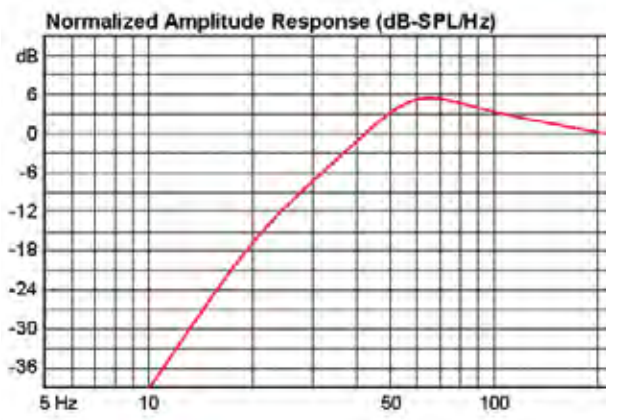

Recommended Enclosures

SEALED

KFC-XW1024D

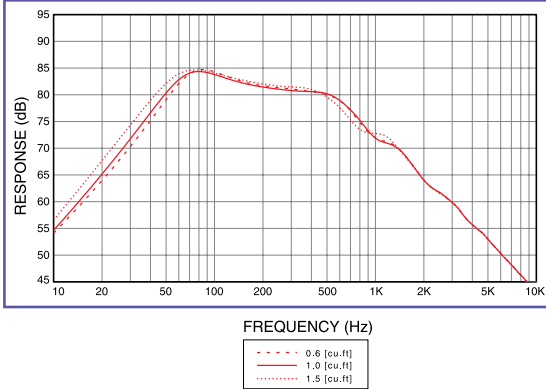

KFC-XW1022D

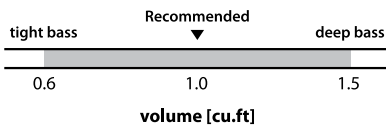
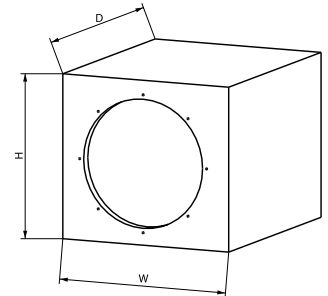
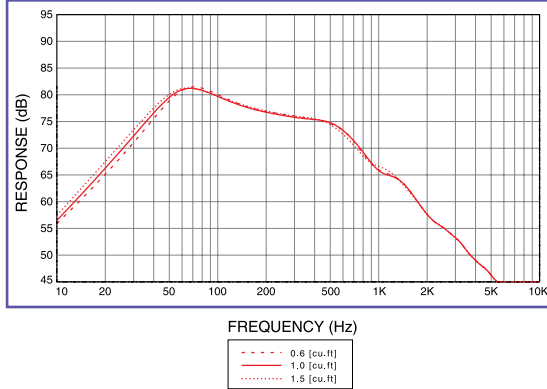

* W, H, D : External Dimensions

| Type | Inner Volume | W | H | D | Mounting Hole | Displacement |
|--------|--------------------|--------------|------------------|--------------------|-----------------|--------------|
| SEALED | 1 cft (25.3 Liter) | 330 mm (13") | 375 mm (14-3/4") | 325 mm (12-13/16") | 235 mm (9-1/4") | 0.06 cu.ft |

Use 19mm (3/4 inch) thick Medium Density Fiberboard (MDF) or High Density Particleboard.

PORTED

KFC-XW1024D

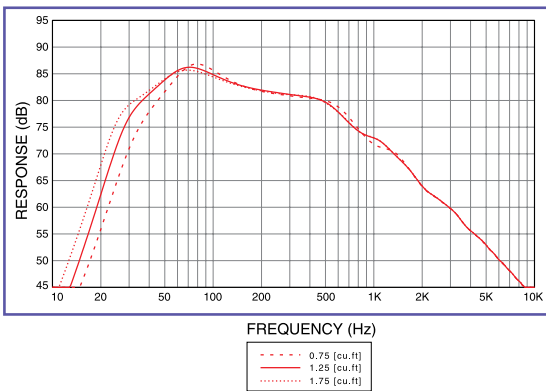

KFC-XW1022D

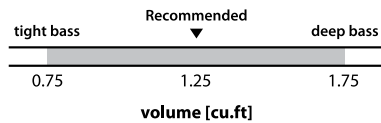
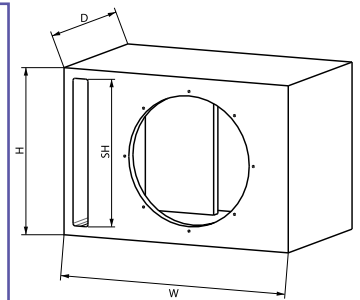
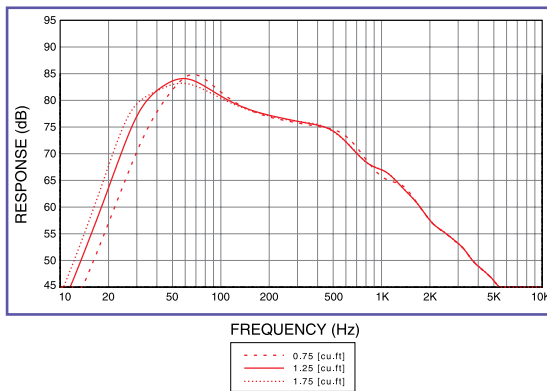

* W, H, D : External Dimensions

| Type | Inner Volume | W | H | D | Mounting Hole | SW | SH | SL | Displacement |
|--------|-----------------------|------------------|------------------|--------------------|-----------------|----------------|------------------|------------------|--------------|
| PORTED | 1.25 cft (35.4 Liter) | 485 mm (19-1/8") | 340 mm (13-3/8") | 300 mm (11-13/16") | 235 mm (9-1/4") | 35 mm (1-3/8") | 302 mm (11-7/8") | 480 mm (18-7/8") | 0.06 cu.ft |

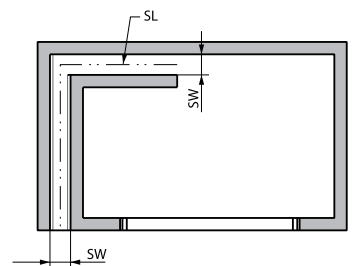

Use 19mm (3/4 inch) thick Medium Density Fiberboard (MDF) or High Density Particleboard.

Recommended Enclosures

SEALED

KFC-XW1224D

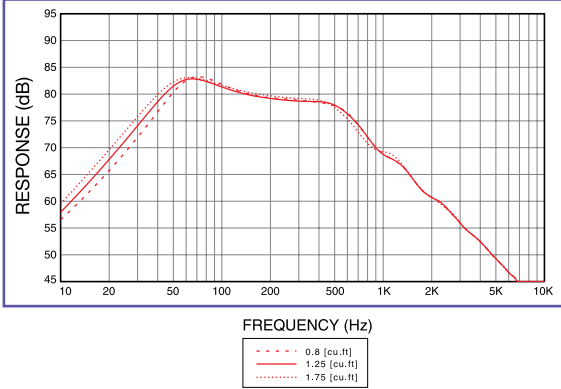

KFC-XW1222D

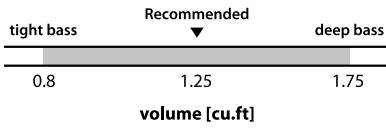
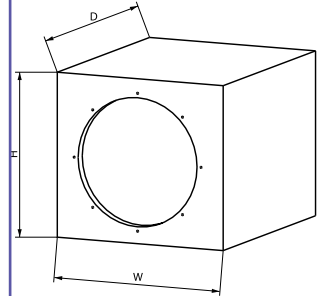
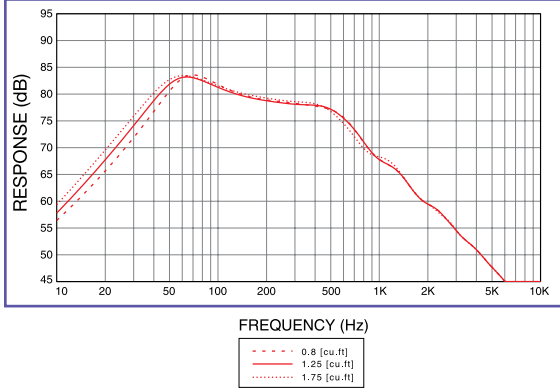

* W, H, D : External Dimensions

| Type | Inner Volume | W | H | D | Mounting Hole | Displacement |
|--------|-----------------------|------------------|-------------------|--------------|------------------|--------------|
| SEALED | 1.25 cft (35.4 Liter) | 375 mm (14-3/4") | 370 mm (14-9/16") | 355 mm (14") | 282 mm (11-1/8") | 0.11 cu.ft |

Use 19mm (3/4 inch) thick Medium Density Fiberboard (MDF) or High Density Particleboard.

PORTED

KFC-XW1224D

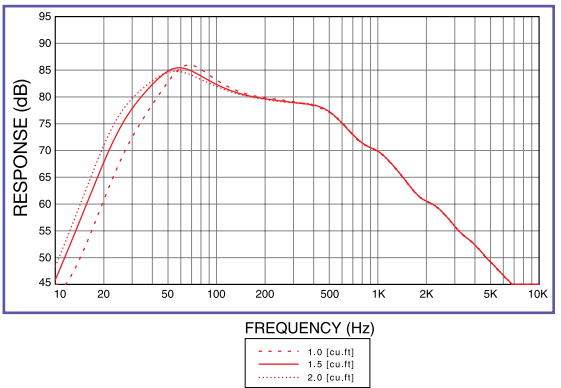

KFC-XW1222D

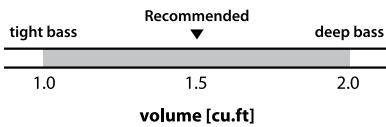
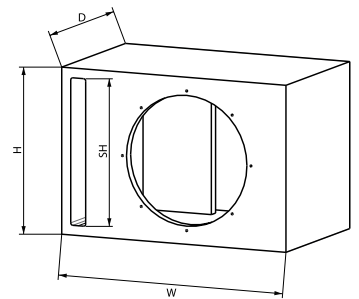
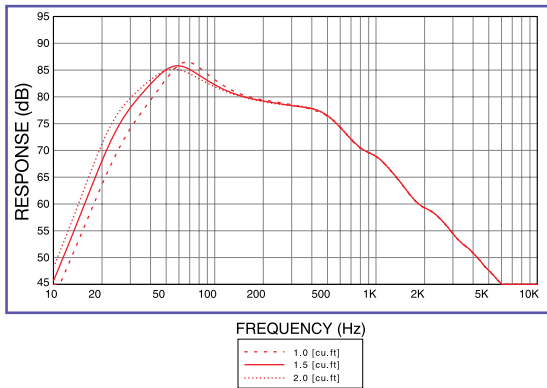

* W, H, D : External dimensions

| Type | Inner Volume | W | H | D | Mounting Hole | SW | SH | SL | Displacement |
|--------|----------------------|--------------------|-------------------|------------------|------------------|----------------|--------------------|------------------|--------------|
| PORTED | 1.5 cft (42.5 Liter) | 507 mm (19-15/16") | 360 mm (14-3/16") | 320 mm (12-5/8") | 282 mm (11-1/8") | 35 mm (1-3/8") | 322 mm (12-11/16") | 480 mm (18-7/8") | 0.11 cu.ft |

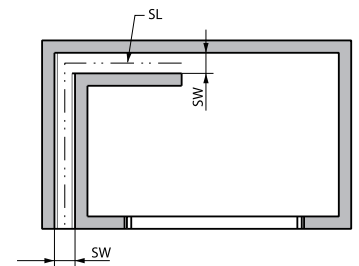

Use 19mm (3/4 inch) thick Medium Density Fiberboard (MDF) or High Density Particleboard.

APPENDIX >>>

Bluetooth™ Connection Chart

| | | Bluetooth Hands-Free | Auto Phonebook Download & Sub Index | Touch Tone (DTMF) | Voice Tagging | A2DP Music Streaming | 2-Way SMS Support | Firmware Updateable | # Of Paired Phones | # Of Phones Connected Same Time |
|----------------|------------|----------------------|-------------------------------------|-------------------|---------------|----------------------|-------------------|---------------------|--------------------|---------------------------------|
| 2008 DNX | DNX8120 | BUILT-IN | BUILT-IN | BUILT-IN | BUILT-IN | BUILT-IN | BUILT-IN | BUILT-IN | 5 | 3 |
| | DNX7120 | KCA-BT200 | KCA-BT200 | KCA-BT200 | KCA-BT200 | KCA-BT200 | KCA-BT200 | KCA-BT200 | 5 | 3 |
| | DNX5120 | KCA-BT200 | KCA-BT200 | KCA-BT200 | KCA-BT200 | KCA-BT200 | KCA-BT200 | KCA-BT200 | 5 | 3 |
| 2008 DDX | DDX812 | BUILT-IN | BUILT-IN | BUILT-IN | BUILT-IN | BUILT-IN | BUILT-IN | BUILT-IN | 5 | 3 |
| | DDX712 | KCA-BT200 | KCA-BT200 | KCA-BT200 | KCA-BT200 | KCA-BT200 | KCA-BT200 | KCA-BT200 | 5 | 3 |
| | DDX512 | KCA-BT200 | KCA-BT200 | KCA-BT200 | KCA-BT200 | KCA-BT200 | KCA-BT200 | KCA-BT200 | 5 | 3 |
| 2008 KVT | KVT-819DVD | KCA-BT200 | Auto PB Only | No | No | No | No | KCA-BT200 | 5 | 3 |
| | KVT-719DVD | KCA-BT200 | Auto PB Only | No | No | No | No | KCA-BT200 | 5 | 3 |
| | KVT-512 | KCA-BT200 | KCA-BT200 | KCA-BT200 | KCA-BT200 | KCA-BT200 | KCA-BT200 | KCA-BT200 | 5 | 3 |
| 2008 CarPortal | KOS-V1000 | KCA-BT200 | Auto PB Only | No | No | No | No | KCA-BT200 | 5 | 3 |
| | KOS-V500 | KCA-BT200 | Auto PB Only | No | No | No | No | KCA-BT200 | 5 | 3 |

Bluetooth™ Connection Chart - 2008 CD

| | | Bluetooth Hands-Free | Auto Phonebook Download & Sub Index | Touch Tone (DTMF) | Voice Tagging | A2DP Music Streaming | Receive SMS Messaging | Firmware Updateable | # Of Paired Phones | # Of Phones Connected Same Time |
|---------|----------|----------------------|-------------------------------------|-------------------|---------------|----------------------|-----------------------|---------------------|--------------------|---------------------------------|
| 2008 CD | KDC-X991 | KCA-BT200 | Auto PB ONLY | No | No | No | No | KCA-BT200 | 5 | 3 |
| | KDC-X792 | KCA-BT200 | KCA-BT200 | No | KCA-BT200 | KCA-BT200 | KCA-BT200 | KCA-BT200 | 5 | 3 |
| | KDC-X692 | KCA-BT200 | KCA-BT200 | No | KCA-BT200 | KCA-BT200 | KCA-BT200 | KCA-BT200 | 5 | 3 |
| | KDC-X592 | KCA-BT200 | KCA-BT200 | No | KCA-BT200 | KCA-BT200 | KCA-BT200 | KCA-BT200 | 5 | 3 |
| | KDC-X492 | KCA-BT200 | KCA-BT200 | No | KCA-BT200 | KCA-BT200 | KCA-BT200 | KCA-BT200 | 5 | 3 |

| | | Bluetooth Hands-Free | Auto Phonebook Download & Sub Index | Touch Tone (DTMF) | Voice Tagging | A2DP Music Streaming | Receive SMS Messaging | Firmware Updateable | # Of Paired Phones | # Of Phones Connected Same Time |
|--|------------|----------------------|-------------------------------------|-------------------|---------------|----------------------|-----------------------|---------------------|--------------------|---------------------------------|
| | KDC-BT838U | BUILT-IN | BUILT-IN | No | BUILT-IN | BUILT-IN | BUILT-IN | BUILT-IN | 5 | 3 |
| | KDC-MP738U | KCA-BT200 | KCA-BT200 | No | KCA-BT200 | KCA-BT200 | KCA-BT200 | KCA-BT200 | 5 | 3 |
| | KDC-MP638U | KCA-BT200 | KCA-BT200 | No | KCA-BT200 | KCA-BT200 | KCA-BT200 | KCA-BT200 | 5 | 3 |
| | KDC-MP538U | KCA-BT200 | KCA-BT200 | No | KCA-BT200 | KCA-BT200 | KCA-BT200 | KCA-BT200 | 5 | 3 |
| | KDC-MP438U | KCA-BT200 | KCA-BT200 | No | KCA-BT200 | KCA-BT200 | KCA-BT200 | KCA-BT200 | 5 | 3 |
| | KDC-MP338 | KCA-BT200 | KCA-BT200 | No | KCA-BT200 | KCA-BT200 | KCA-BT200 | KCA-BT200 | 5 | 3 |
| | KDC-MP238 | KCA-BT200 | KCA-BT200 | No | No | KCA-BT200 | No | KCA-BT200 | 5 | 3 |

2008 Multi Media Adaptor/Accessory Chart

| | | Bus Type | Bluetooth Module | Sirius Adaptor | XM Adaptor | iPod Nano/ Newer | HD Radio | NAV Traffic G510 or built in | |
|----------------|--|------------|------------------|--------------------|------------|-------------------|------------|------------------------------|----------------|
| 2008 DNX | | DNX8120 | KAB | BUILT-IN | CA-SR20V | KCA-XM100V | KCA-iP300V | KTC-HR200 ONLY | GXM30 or GTM10 |
| | | DNX7120 | KAB | KCA-BT200 ONLY | CA-SR20V | KCA-XM100V | KCA-iP300V | KTC-HR200 ONLY | GXM30 or GTM10 |
| | | DNX5120 | KAB | KCA-BT200 ONLY | CA-SR20V | KCA-XM100V | KCA-iP300V | KTC-HR200 ONLY | GTM10 ONLY |
| 2008 DDX | | DDX812 | KAB | BUILT-IN | CA-SR20V | KCA-XM100V | KCA-iP300V | KTC-HR200 ONLY | GXM30 or GTM10 |
| | | DDX712 | KAB | KCA-BT200 ONLY | CA-SR20V | KCA-XM100V | KCA-iP300V | KTC-HR200 ONLY | GXM30 or GTM10 |
| | | DDX512 | KAB | KCA-BT200 ONLY | CA-SR20V | KCA-XM100V | KCA-iP300V | KTC-HR200 ONLY | GXM30 or GTM10 |
| 2008 KVT | | KVT-819DVD | 5 Line | KCA-BT200 or BT100 | KCA-SR50 | Audiovox Solution | KCA-iP300V | KTC-HR200 or 100 | GXM30 or GTM10 |
| | | KVT-719DVD | 5 Line | KCA-BT200 or BT100 | KCA-SR50 | Audiovox Solution | KCA-iP300V | KTC-HR200 or 100 | GXM30 or GTM10 |
| | | KVT-512 | KAB | KCA-BT200 ONLY | CA-SR20V | KCA-XM100V | KCA-iP300V | KTC-HR200 ONLY | GXM30 or GTM10 |
| 2008 CarPortal | | KOS-V1000 | 5 Line | KCA-BT200 or BT100 | KCA-SR50 | Audiovox Solution | KCA-iP300V | KTC-HR200 or 100 | GXM30 or GTM10 |
| | | KOS-V500 | 5 Line | KCA-BT200 or BT100 | KCA-SR50 | Audiovox Solution | KCA-iP300V | KTC-HR200 or 100 | GXM30 or GTM10 |

NOTES:

| | |
|--|--|
| | |
| | |
| | |
| | |
| | |
| | |
| | |
| | |
| | |
| | |
| | |
| | |
| | |
| | |
| | |
| | |
| | |
| | |
| | |
| | |
| | |
| | |
| | |
| | |
| | |

NOTES:



KENWOOD
Listen to the Future

live connected. drive connected.™

Kenwood USA Corporation • 2201 E. Dominguez Street • Long Beach, CA 90810

Download from www.Somanuals.com. All Manuals Search And Download.

Free Manuals Download Website

<http://myh66.com>

<http://usermanuals.us>

<http://www.somanuals.com>

<http://www.4manuals.cc>

<http://www.manual-lib.com>

<http://www.404manual.com>

<http://www.luxmanual.com>

<http://aubethermostatmanual.com>

Golf course search by state

<http://golfingnear.com>

Email search by domain

<http://emailbydomain.com>

Auto manuals search

<http://auto.somanuals.com>

TV manuals search

<http://tv.somanuals.com>